



# **X<sup>®</sup>CCR** REBREATHER

## **USER INSTRUCTIONS**

Edition 2.2.2



# 1 List of contents



## 1 GENERAL INFORMATIONS

- 1.1 Important information and Warnings
- 1.2 Manufacturer
- 1.3 CE certification

## 2 INTRODUCTION

- 2.1 Limitations on Use
  - 2.1.1 Depth limits
  - 2.1.2 Temperature conditions
  - 2.1.3 CO<sub>2</sub> scrubber duration limit
- 2.2 Assessment of Risks
  - 2.2.1 Work Rates
  - 2.2.2 Vertical Head Down Position
  - 2.2.3 Expected Inspired Gas Concentrations
  - 2.2.4 Visibility
  - 2.2.5 Use of High Oxygen Content Gases
  - 2.2.6 Potential Long Term Health Effects
- 2.3 Scope of Functionality and Features
  - 2.3.1 Working Principles of CCR
  - 2.3.2 Main Body
  - 2.3.3 Radial Scrubber
  - 2.3.4 CCR Head
  - 2.3.5 Breathing Loop
  - 2.3.6 Set-point Controller and Display Devices
- 2.4 Technical Specifications
- 2.5. Diagram of XCCR with Back-Mounted Counterlungs
- 2.6. Diagram of XCCR with Front-Mounted Counterlungs

## 3 TECHNICAL DESIGN

- 3.1 XCCR overview
  - 3.1.1 XCCR with Back-Mounted Counterlungs
  - 3.1.2 XCCR with Front-Mounted Counterlungs
- 3.2. Base Unit
- 3.3 Radial Scrubber
- 3.4 Breathing hoses

- 3.5 T-pieces
- 3.6 ADV - Automatic Diluent Valve
- 3.7 Back-Mounted Counterlungs
- 3.8 Front-Mounted Counterlungs
- 3.9 BOV - Bail Out Valve
- 3.10 Oxygen Tank
- 3.11 Diluent Tank
- 3.12 Back Plate and Harness
- 3.13 Buoyancy Control Device - BCD Wing
- 3.14 XCCR Head
- 3.15 Solenoid & Oxygen Control electronics
- 3.16 DiveCAN Communication Bus
- 3.17 Primary Controller Handset
- 3.18 Head-Up Display

## **4 OPERATION OF PRIMARY CONTROLLER**

- 4.1 Turning ON
- 4.2 Turning OFF

## **5 PROCEDURES, Usage and Checks**

- 5.1 Preparation Before the Dive
  - 5.1.1 Replacement of CO<sub>2</sub> Sorbent
  - 5.1.2 Assembling the Head onto the Canister Body
  - 5.1.3 Connecting the Back-Mounted Counterlungs and the Breathing Loop
  - 5.1.4 Connecting the Front-Mounted Counterlungs (if used) and the Breathing Loop
  - 5.1.5 Filling the gas cylinders
  - 5.1.6 Battery Charging
  - 5.1.7 Calibration of Oxygen Sensors
  - 5.1.8 One-way Directional Valves Check
  - 5.1.9 The whole XCCR Unit Inspection
  - 5.1.10 Bail-Out system
  - 5.1.11 Donning and fitting the XCCR Unit on the diver
- 5.2 Checklist - Prior the dive
- 5.3 Checklist - Just before the dive
- 5.4 Checklist - When entering the water
- 5.5 When Diving
- 5.6 Checklist - After the Dive

- 5.7 Quick Cleaning of the unit
- 5.8 Complete Cleaning of the unit
- 5.9 Storage

## **6 MAINTENANCE and SERVICING**

- 6.1 Maintenance
- 6.2 Maintenance and Service Inspection Intervals
- 6.3 12-months Maintenance and Service Interval
- 6.4 36-months Maintenance and Service Interval

## **7 Warranty**

## **8 Impressum**



Important warning



Important information



# 1 GENERAL INFORMATION

## 1.1 Important Information and Warnings

It is extremely important that you read this manual in its entirety and understand the content and practical application to diving the XCCR prior to use. If you are unsure of any information included in this text, please consult with your XCCR Instructor or directly with iQsub Technologies.

The XCCR unit must never be used without obtaining specific training, the XCCR diver course.

This manual is designed as reference material to supplement training with a qualified, active teaching status, instructor in the proper use and care of your XCCR. It is not intended to replace your qualifying dive training agency's rebreather diving instructional materials, nor does it cover all critical aspects of rebreather diving in general.

Remember, a closed circuit rebreather may fail at any time!

Therefore the diver must be equipped with an autonomous bailout system, which is independent of the CCR equipment and is adequate for the dive, while assuming the worst case scenarios.

The bailout system must be sufficiently configured so that the dive can be terminated without difficulty in the event of a malfunction.

The manufacturer does not bear any responsibility for usage of the XCCR, if the apparatus has been modified in any way, that is not set forth in this instruction manual or in the technical guidelines issued by the manufacturer.

Any modification of the XCCR unit immediately increases your risk while diving the XCCR. Any modification of the XCCR unit voids the warranty and CE approval.

Failure to observe the service and maintenance intervals it increases your risk while diving the XCCR.

Repairs and replacement of parts on the XCCR unit may only be carried out by the manufacturer or by a service center officially approved by the manufacturer. Spare parts, repair and servicing of the device are available only to users who can demonstrate their appropriate certification to use the XCCR.

The XCCR unit may be used only with cylinders with a valid certificate in accordance with the requirements in force in the country in which the unit is used.

You must read AND ACCEPT these warnings in order to dive on the XCCR unit.

In countries that are not members of the European Union, there may be additional requirements regarding the use of closed circuit rebreathers.

Before you start using the XCCR unit, it is necessary to check the actual mandatory requirements in the country in which you intend to use the device.

Reproduction and/or changes of this document in whole or in part are expressly prohibited without written approval from iQsub Technologies s.r.o.

## 1.2 Manufacturer



The XCCR Rebreather is designed and manufactured in the Czech Republic by:



## 1.3 CE certification



The XCCR presented in this manual has been subjected to the process of certification at the notified body DEKRA Testing and Certification GmbH and meets the requirements of Regulation (EU) 2016/425 and the norm DIN EN 14143: 2013-10 Respiratory equipment - Self-contained re-breathing diving apparatus.

The CE mark indicates compliance with the requirements and the number 0158 next to the CE mark determines the identification code of DEKRA Testing and Certification GmbH.

## 2 INTRODUCTION

The XCCR is an expedition grade rebreather designed to provide reliable performance in demanding underwater environments. The unit was developed using years of experience in CCR development and testing with respect to the needs of technical divers and explorers.

The XCCR combines a well proven rebreather chassis with the most innovative electronics package to form a fault tolerant rebreather. The most important features of the XCCR are reliability, flexibility, durability and user-friendly design with tool-less assembly and maintenance.

The XCCR rebreather is intended for use solely by persons trained and qualified to assemble and use the XCCR rebreather and are capable of fully understanding the instructions contained in this instruction manual.

The XCCR is intended for use for recreational and technical diving.

All subsequent updates will be available on iQsub.com and factory approved instructors.

### 2.1 Limitations on use

#### 2.1.1 Depth limits

The maximum operating depth for XCCR users in accordance with the EN 14143:2013 is **100m**.

Additional maximum operating depth limitations depend on diluent used:

<u>Diluent</u>	<u>Max. depth</u>
Air	40 m
Trimix	100 m

#### 2.1.2 Temperature conditions

The XCCR can be used within the water temperatures range above **4°C / 39°F** and less than **34°C / 93°F**. Operation at temperatures outside of this range may lead to unreliable function or even injury of the diver. The minimal temperature is defined by CO<sub>2</sub> scrubber duration tests, which is executed at **4°C / 39°F**

### 2.1.3 CO<sub>2</sub> scrubber duration limit

The maximum safe operating period of sorbent is 240 min, determined by a test in accordance with EN 14143:2013, during which 1.6 liters per minute of CO<sub>2</sub> were added to the breathing loop with ventilation of 40 liters per minute, in water of temperature 4°C, while the exhaled gas was of temperature 32±4 °C with limit at ppCO<sub>2</sub> 5mBar.

The sorbent maximum operating duration differs depending on the type of sorbent, ambient temperature, depth and exertion rate of the diver.

## 2.2 Assessment of risks

### 2.2.1 Work rates

The XCCR is intended for use on dives involving low to moderate work rates (normal activities in recreational and technical diving). It is also capable of sustaining a diver operating at higher work rates, however the diver needs to calculate a significant reduction in scrubber duration, due to related CO<sub>2</sub> production. Also, with a higher work rate, the diver must take into consideration increased oxygen consumption.

Additionally the diver needs to take into account, that a higher work rate may have an impact on decompression as well as oxygen toxicity thresholds. Certain additional safety margins should be added. Each body is different and reacts differently gas stresses. Consequently, it is not possible to specify 100% accurate gas loading and decompression information.

### 2.2.2 Vertical head down position

A vertical, head down position during a dive is an unusual position for a diver and normally never used unless absolutely necessary. In a vertical head down position an unintentional activation or even free flow of the ADV can possibly occur due to ADV is activated by a negative pressure in the breathing loop. To avoid this, when the diver is forced to go to a vertical head down position, he can close the shut-off valve connected to the ADV and use the manual adding valve for diluent to maintain an optimal breathing loop volume.

### 2.2.3 Expected inspired gas concentrations

The oxygen setpoint range of the XCCR is from 0.5 to 1.5 bar.

The setpoint range creates breathing gas mixture representing an inspired oxygen partial pressure between 0.5 bar and 1.5 bar.

The default Low setpoints is 0.7 and the High setpoint is 1.3 and they are selectable and changeable by user within the listed setpoint range. The oxygen fraction of the mixture depends upon depth and the set point.

The following table shows the oxygen and nitrogen fraction with diluent “Air”, for the setpoints 0.7 and 1.3 and depth 0 to 50 meters. The nitrogen fraction varies depending upon the selected diluent for a dive.

Depth	Abs. Pressure	Setpoint	ppO <sub>2</sub>	O <sub>2</sub> (%)	ppN <sub>2</sub>	N <sub>2</sub>
m	bar		bar	%	bar	%
0	1.0	0.7	0.70	70	0.3	30
3	1.3	1.3	1.3	100	0	0
6	1.6	1.3	1.3	81	0.3	19
10	2.0	1.3	1.3	65	0.7	35
20	3.0	1.3	1.3	43	1.7	57
30	4.0	1.3	1.3	32	2.7	68
40	5.0	1.3	1.3	26	3.7	74
50	6.0	1.3	1.3	21	4.7	79

To reach the maximum operating depth of 100 meters a Trimix diluent is strongly required. Diving to depths exceeding the maximal recreational depth of 40 meters requires additional training and significantly increases all the risks and may only be carried out by well trained and qualified divers.

## 2.2.4 Visibility

During a dive it is essential that the diver is able to read all the information from the setpoint controller display and HUD. Therefore the XCCR should only be used when the visibility in water exceeds approximately 30 centimeters. Using the XCCR in visibility conditions that make impossible viewing of the setpoint controller display and HUD poses increased risks of operation.

## 2.2.5 Use of high oxygen content gases

CNS = Central Nervous System Oxygen Toxicity is a combination of oxygen pressure and time of exposure. The training for the XCCR rebreather covers CNS oxygen toxicity and the NOAA exposure limits.

Prolonged exposure to oxygen in excess of 0.5 bar can lead to pulmonary toxicity, affecting the whole body. Pulmonary toxicity is tracked using Oxygen Toxicity Units, known as OTUs. One OTU is earned by breathing 100% oxygen at one bar for one minute. The most conservative limit sets a maximum of 300 OTUs per day for multi day diving activities. During several days of diving it is necessary to calculate OTUs consistently with the principles of NOAA or other recognized organizations ( for instance IANTD, TDI).

## 2.2.6 Potential long term health effects

At the time of publishing, there are no long term studies available for using a rebreather. It is the responsibility of the diver to inform himself of the consequences of CNS, OTU's and the effect of decompression, and emersion in water.

## 2.3 Scope of functionality and features



### 2.3.1 Working Principle of CCR

The basic working principle of the closed circuit rebreather consists of recycling the breathing mixture. Carbon dioxide produced by a diver is removed from the exhaled gas. After replenishing the consumed oxygen, this is again refreshed for the next inhalation by a diver. The composition of the breathing mixture changes continuously during the dive.

### 2.3.2 Main body

The main body consist of the robust aluminum or optionally Delrin Canister equipped with quick release fasteners for easy attaching and replacing gas cylinders.

The unit is equipped with 3L/232bar gas cylinders.

Optionally gas cylinders from 2L to 7L can be used.

The compact multi-outlet manifolds allow direct connectivity of on-board gases and optionally off-board gases via Swagelok QC6 quick disconnect connectors (9/16"-18).

The Diluent manifold has 8 outlets and Oxygen manifold has 5 outlets.

Radial scrubber with self-packing feature, capacity 3,3 kg of soda lime.



### 2.3.3 Radial Scrubber

The full size Radial scrubber with self-packing feature has capacity 3,3 kg of soda lime. The scrubber operating time is up to 6 hours.

### 2.3.4 CCR Head

The X-head is connected and safely locked to the Canister by its industry unique quick bayonet lock.

High pressure sensors 300 bar are integrated in the head for reading of high pressure in the gas cylinders with displaying on the Primary Controller Handset display.

Three O<sub>2</sub> sensors are placed in the easy removable sensor cartridge.

CO<sub>2</sub> solid state sensor is integrated in the sensor cartridge to check ppCO<sub>2</sub> in the breathing loop.

The Solenoid and Oxygen electronics board is power supplied with two separate and easy replaceable Li-Ion batteries, located in the head, outside of the breathing loop.

### 2.3.5 Breathing loop

The XCCR unit is equipped with the Back-mounted counterlungs or optionally with Front-mounted (over the shoulders) counterlungs.

The Automatic Diluent Valve (ADV) is integrated into the inhale T-piece, operating by underpressure in the breathing loop.

Manual add valves for manual adding of O<sub>2</sub> and diluent by the diver.

The Bail-Out Valve (BOV) is a standard part of the loop.

The breathing loop is equipped with Click Lock Couples on every connection point.

### 2.3.6 Set-point Controller and Display devices

The XCCR is standardly equipped with:

- reliable [Shearwater DiveCAN Petrel2 Controller](#) with color LCD display, Trimix deco, log-book, HP and CO<sub>2</sub> readings on the display, designed for the XCCR
- compact [Shearwater DiveCAN Head-Up Display](#) (the HUD) with independent PPO<sub>2</sub> monitoring on three O<sub>2</sub> sensors
- additional port for direct connecting of an optional secondary monitor / computer allowing 3-cell ppO<sub>2</sub> monitoring.

## 2.4 Technical specifications ■ ■ ■

Dimensions	H x W x D	70 x 40 x 25 cm
Weight	34,0 kg	Complete unit without soda lime and gases - travel weight
	21,4 kg	Unit without tanks and soda lime - air travel weight
	38,9kg	Complete unit ready for dive with 3L tanks and filled with soda lime Carrying of the unit requires the assistance of another person or use of a carriage
Temperature limits	Diving:	water temperature above 4 °C and less than 34 °C in accordance with requirements of EN14143:2013
	Transport:	+4°C to +40°C / 39°F to 104°F
	Storage:	+5°C to +25°C / 41°F to 77°F
Atmospheric pressure range		800 – 1050mbar
Maximum application depth	Max. 40 m	with Air as diluent
	Max. 100 m	with Trimix 12/65 (or higher) as diluent
	Warning:	Dives exceeding a depth of 100m bring significantly increased risks and therefore are strongly not recommended, rather prohibited
CO2 Scrubber	Type:	Radial
	Soda lime:	3,2 kg / 7,1 lb (Sofnolime 797) or equivalent soda lime
	Running time:	225min acc. to EN 14143:2013 up to 360min at mild work
	Test parameter:	Ventilation 40L/min, 1.6L/min CO2, 4°C water temperature Diluent for 40 m - Air Diluent for 100 m - Trimix 12/65
Soda lime	Sofnolime® 797	1-2,5mm, non indicating or white to violet indicating manufactured by Molecular Products Limited, U.K.
Back-Mounted Counterlungs	Volume:	2x4,0 liter
Front-Mounted Counterlungs	Volume:	2x3,8 liter
Oxygen Tank		Eurosteel cylinder 3 Liter/232bar or 3 Liter/300bar, with monovalve M26x2
Diluent Tank		Eurosteel cylinder 3 Liter/232bar or 3 Liter/300bar, with monovalve DIN 5/8"
Gas endurance of the unit On-board Gases (200bar)	OXYGEN:	3 liter x 200bar = 600 liters, minus 180 liters reserve (30%) => 420 liters useable The on-board oxygen supply will last up to 280 minutes at consumption 1.5 liter O <sub>2</sub> per minute.
	Diluent	3 liter x 200bar = 600 liter minus 120 liters reserve (20%) => 480 useable liter Diluent endurance depends on the max. depth and changes of the depth during the dive.
Required purity of the gases	Air:	EN 12021
	Oxygen:	≥99.5% (medicinal oxygen)
	Helium:	≥99.99 (Hel 4.0)
Regulator 1st stage - Oxygen	Connection:	M26x2, medium pressure: 9.5 +/- 0,5 bar
Regulator 1st stage - Diluent	Connection:	DIN 5/8", medium pressure: 9.5 +/- 0,5 bar
Oxygen control		Readings from three oxygen sensors with Voting logic
Oxygen sensors		3 galvanic Rebreather oxygen sensor, type NaNS01 SMB (coax), M16x1 Output 9 - 13 mV
Oxygen Setpoint range		2 changeable setpoints, settable from 0,5 to 1,5 bar O <sub>2</sub>
Oxygen Alarms	Low oxygen	0,4 bar or less
	High oxygen	1,6 bar or above
Batteries in the Head		2 independent batteries 3,7V Li-Ion, size 18650, replaceable by user
Batteries in the Handset		1 battery AA size 1.5V Alkaline or 3.6V Saft or 3.7V Li-Ion rechargeable
Safety devices		Over pressure valve on Oxygen manifold (15 - 18 bar)
		Safety pressure valve on the Head (3 - 5 bar)

## 2.5 Diagram of XCCR with Back-mounted counterlungs

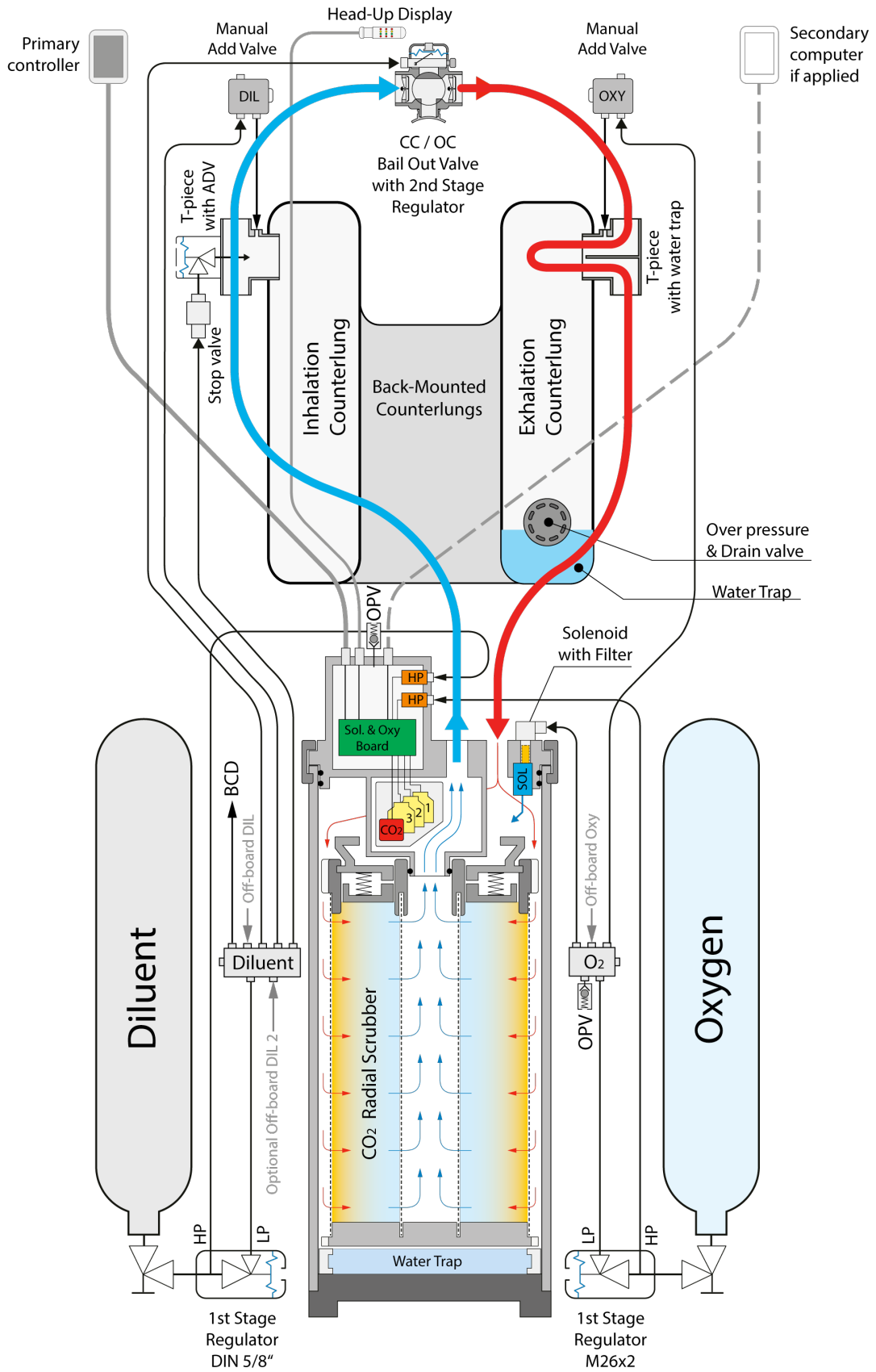

2.6 Diagram of XCCR with Front-mounted counterlungs

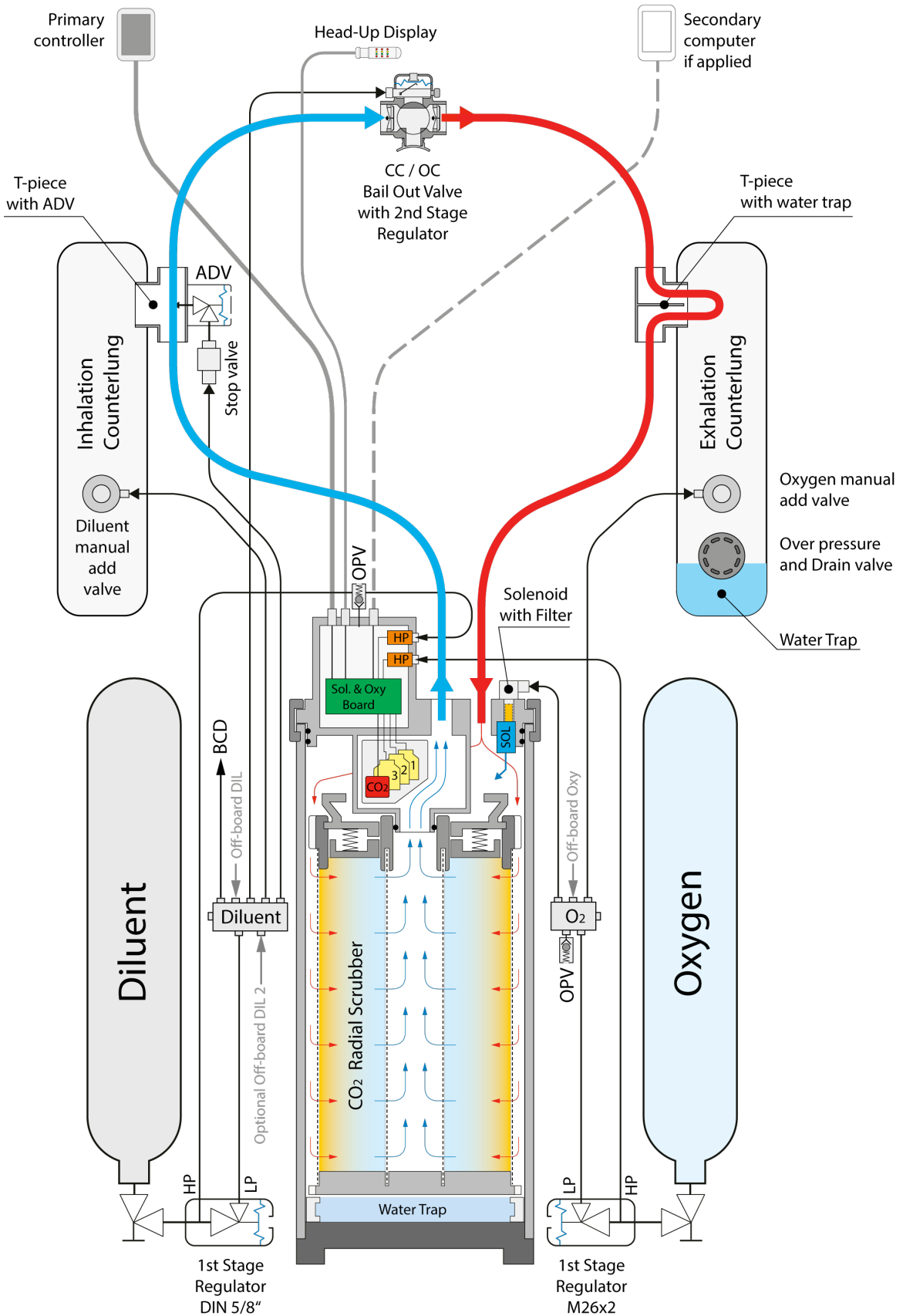

### 3 TECHNICAL DESIGN ■ ■ ■ ■ ■

This chapter describes the basic design and the assembly of the XCCR Rebreather and acts as a guideline for better understanding the unit and for reassembly, if it is necessary to disassemble it for maintenance or for any other reason (transport, maintenance, storage etc.) The whole unit is fully assembled and tested before shipping.

#### 3.1 XCCR overview ■ ■ ■



### 3.1.1 XCCR with Back-mounted Counterlungs

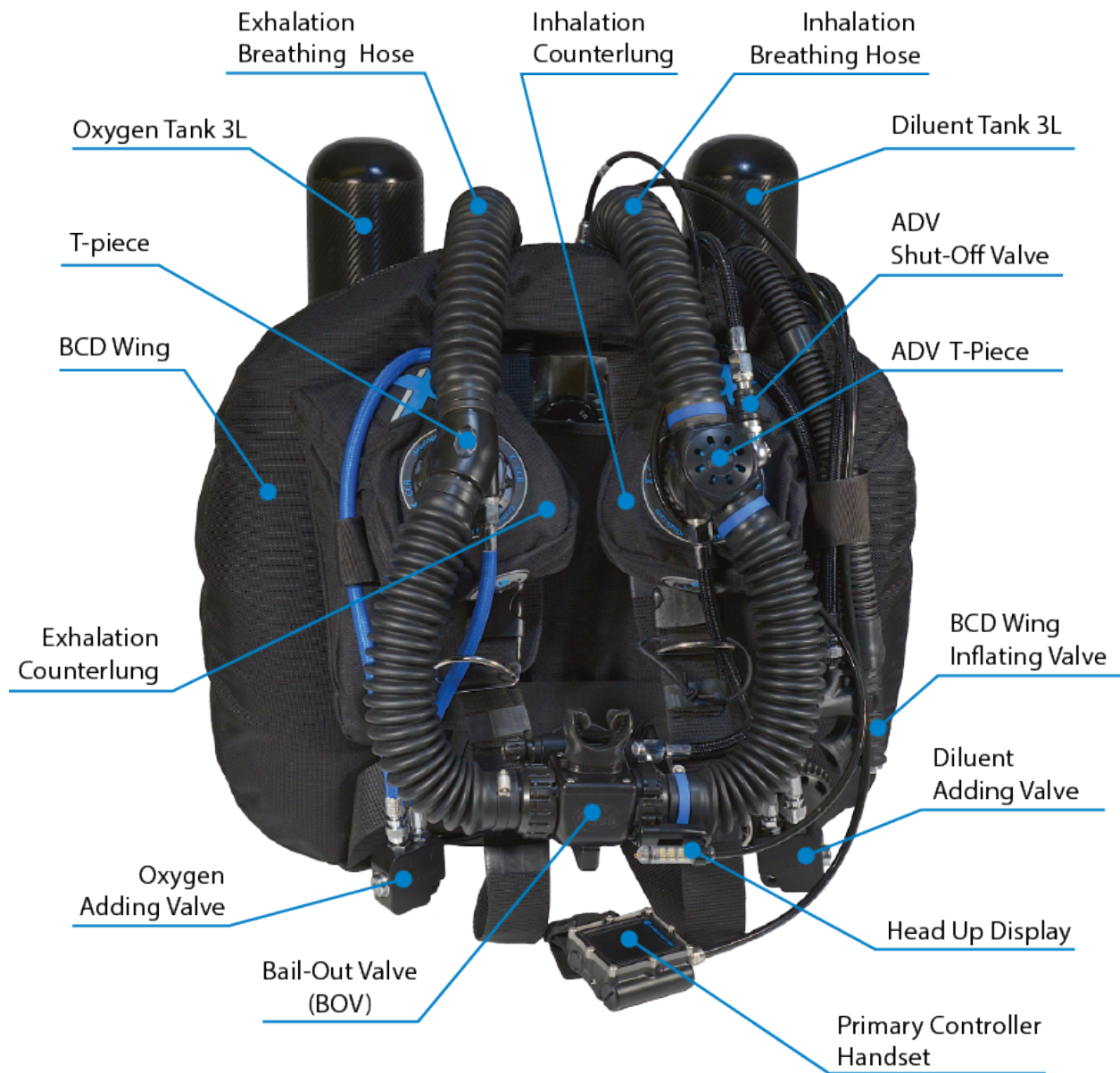



### 3.1.2 XCCR with Front-mounted Counterlungs



## 3.2 Base unit

The base unit of the XCCR consists of the Canister made of a marine grade hard anodized aluminum with teflon coating or optionally Delrin.

This is the central element of the rebreather that connects and carries all its components.

The Canister has a mounted bottom, sealed by o-ring. The bottom is fixed in the canister by means of a locking ring, which is designed simultaneously as a spacer with a water trap. The bottom is replaceable if damaged.

At the upper edge of the Canister there are the six grooves for the industry unique Quick Bayonet Lock of the CCR head.

The Canister is also equipped with a number of circumferential grooves for fixing the Backplate Adapter and two Quick Release Fasteners for attaching of the oxygen and diluent cylinders.

The Backplate Adapter is made of stainless steel and carries the two M8 bolts for securing the BCD and the Backplate with harnesses. The two M8 bolts are replaceable for longer ones in case of use of a thicker backplate and back-mounted counterlungs.

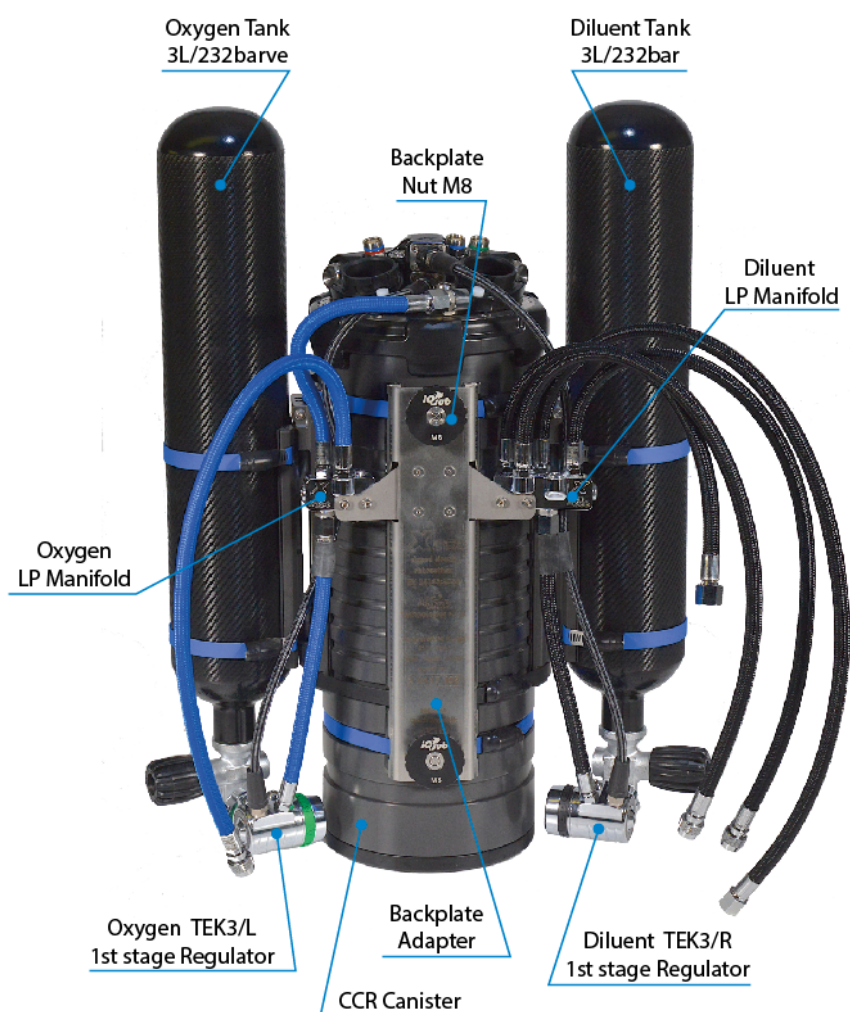

The Backplate Adapter carries also the Oxygen and Diluent manifolds, which enable gas distribution to the individual devices.

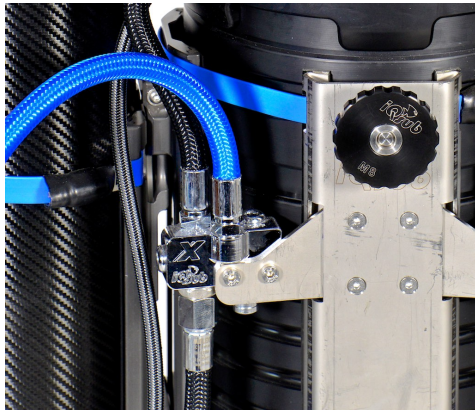

The Oxygen manifold is equipped with an overpressure valve in case of failure on the intermediate pressure from the 1st stage regulator. The Oxygen manifold has 3 top outlets and 1 optional side outlet. The top outlets are for connecting LP hoses leading to the Solenoid and the Manual Adding Valve. The third outlet is intended for connecting an optional off-board oxygen source.

The Diluent manifold has 5 top outlets and 1 optional side outlet. The top outlets are for connecting LP hoses to the ADV, the Manual Adding Valve, the BOV's 2nd stage regulator and the BCD wing. The remaining outlet is intended for connecting optional off-board gases.

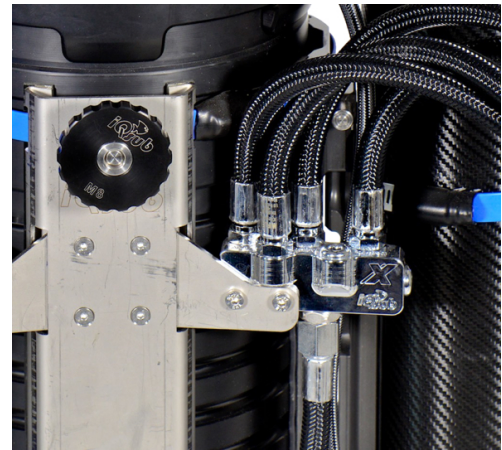

The quick release fasteners are made of aluminum with hard anodizing. They provide very easy and secure attaching of the oxygen and diluent tanks to the canister. When attaching or releasing the tank, press the upper button on the female fastener (fastened to the can) and put on or take away the tank.

The backplate adapter and the quick release fasteners are fastened onto the Canister by stainless steel clamps. The clamps are provided with a plastic sleeve to protect the joined parts against electrochemical corrosion (stainless steel / aluminum).



### 3.3 Radial Scrubber

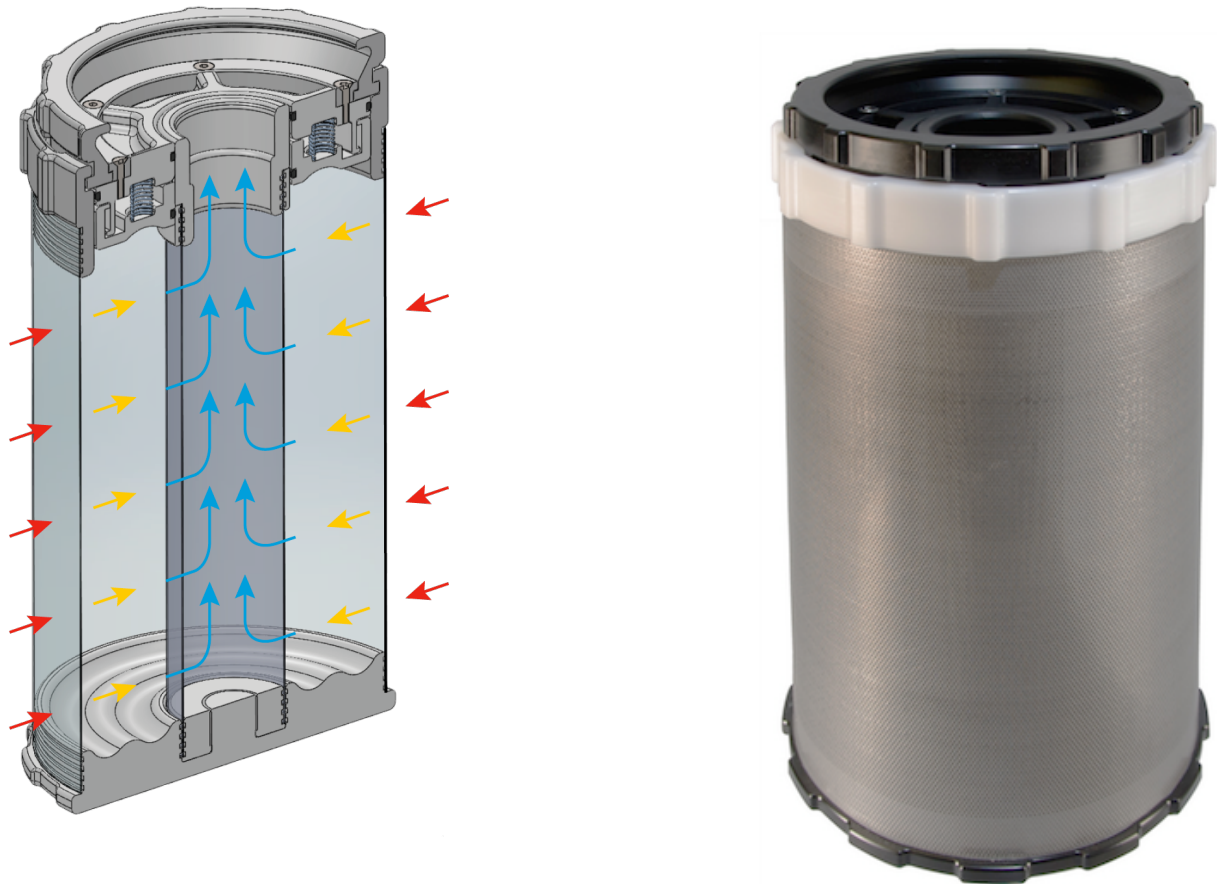

The XCCR uses a radial scrubber.

The breathing gas passes through the outer tube to the center tube of the scrubber, where it flows up to the neck connected to the rebreather head.

The XCCR scrubber consists of the outer and the inner tubes made of stainless steel and are very finely perforated for perfect retention of soda lime granules while low resistance of the breathing gas flow. The scrubber bottom holds the both tubes together. The top ring reinforces and protects the outer tube.

The scrubber is closed by an upper lid with an easy to use bayonet lock. The scrubber lid is equipped with a spring loaded plate in order to ensure sustained compression of the soda lime (self-packing) to protect against gas channeling (bypass of the soda lime).

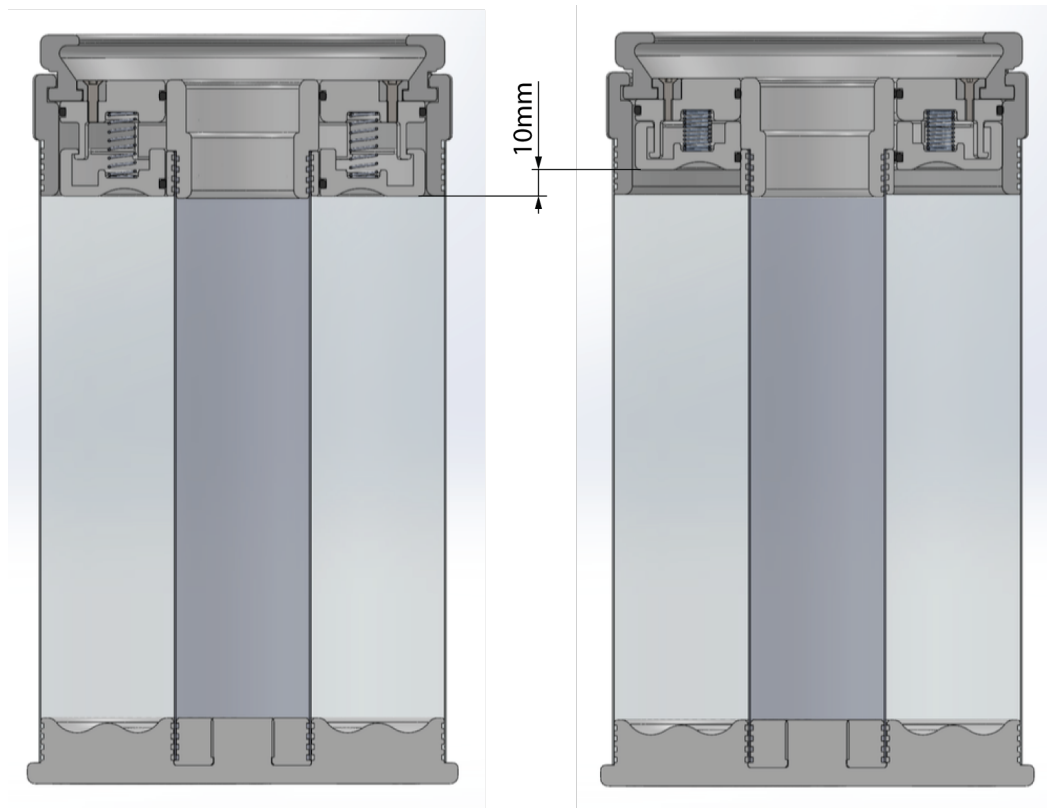

The scrubber top ring is equipped with a number of protrusions on the periphery that enable breathing gas to flow between the canister wall into the scrubber.

The bottom is also equipped with a number of protrusions on the periphery that enable condensation or eventually water to flow to the water trap at the canister bottom.

The capacity of the XCCR scrubber is approximately 3,2 kg / 7,1 lb of soda lime.

The supported soda lime is [Sofnolime 797, 1-2,5mm](#), non indicating or white to violet indicating, manufactured by Molecular Products Limited, U.K.

It is also allowed to use other soda lime of equivalent parameters to Sofnolime 797.

The safe operating period of the scrubber is 225min in accordance with EN 14143:2013, when the extreme conditions are applied:

1.6 L/min of CO<sub>2</sub> is injected to the breathing loop, in 40 m depth, at 40 L/min ventilation, in water temperature 4°C, while exhaled gas temperature is 32±4 °C, until the limit level ppCO<sub>2</sub> of 5 mBar is achieved.

This corresponds to consumption 1.78 l/min of Oxygen.

The typical operating period of the scrubber at mild to moderate work is 360 min.

### 3.4 Breathing Hoses



The breathing corrugated hoses are made of EPDM rubber, which is very resistant to weathering, salt water, UV radiation and grease.



The breathing corrugated hoses on their both ends are equipped with a coupler and the nut with easy-to-use click bayonet lock for connecting to the rebreather head and the BOV (Bail-Out valve).

The corrugated hoses are the mechanically least durable part of the unit, therefore focus your attention on protecting them all the time.

The corrugated hoses can be damaged by excessive stress and it is necessary to protect them against perforation, cuts, excessive stretching and wear.



**Avoid long-term deformation of the hoses when storing or transport the unit. Using the hoses for grasping or fastening the XCCR is do not permissible !**

### 3.5 T-pieces



The low-profiled T-pieces are used to connect the breathing hoses to the Counterlungs.

The T-pieces are made of Delrin and are connected to the Counterlungs via a socket and fastened by a nut with trapezoidal thread resistant to damage. When attached to the Counterlungs the T-pieces may still rotate the full 360° range.

The breathing hoses are fitted on the T-piece nipples and secured by a compact stainless steel hose clamp.

The hose clamp on the inhalation hoses has a blue sleeve to indicate the inhalation side of the loop.





The T-piece on the exhalation side has an inner rib that directs the breathing gas and eventual water that may penetrate via BOV into the exhalation Counterlung, where it can be easily drained out through the over pressure valve.

The T-piece on the inhalation side has integrated ADV - automatic diluent valve with additional Shut-Off valve (more info in chapter 3.6).

The both T-pieces are standardly equipped with a lateral inlet for the possibility to connect a LP hose leading from the manual adding valve (in the Back-mounted Counterlungs configuration).



### 3.6 ADV - Automatic Diluent Valve



The automatic diluent valve - the ADV is integrated into the inhalation T-piece.

The ADV is designed in a similar way like a 2nd stage regulator, it is activated by a negative pressure in the breathing loop and automatically adds diluent to the breathing loop when needed (in the event of decreasing the volume of the breathing loop).



At the ADV inlet there is mounted the Shut-off valve that shuts off diluent from the connected LP hose. It is operated by sliding up or down the black switching ring. It is useful in the event of malfunction of the ADV or if a diver wants to have the adding of diluent into the loop under his full control.

The ADV does not require any adjustment.



**The blue diaphragm, which opens the ADV valve is an element that may be sensitive to damage. The condition of the diaphragm must be verified prior each dive by the negative pressure test and by a visual inspection.**

### 3.7 Back-mounted Counterlungs



The XCCR is configured with Back-mounted counterlungs, which are advantageous for diving in a low profile environments such as caves and wreck.

The Back-mounted counterlungs (BM-counterlungs) are made in a way that the inhalation and exhalation counterlungs are connected by a middle section into one single compact piece. The counterlungs are connected to the breathing loop via the T-pieces on their top.

The BM-counterlungs are made of a double layer, where the outer shell protects the inner bladder and bears all fasteners.

The inner bladder is made of a thin and soft Cordura with PU coating.

The inner bladder are accessible through a zippers at the middle of the outer shell.

The both layers at the top have an opening with the trapezoidal threaded fitting installed for connecting the appropriate T-piece.



The BM-counterlungs are equipped with Velcro straps on the both sides for attaching the LP hoses leading from the manifolds.

The BM-counterlungs are fastened by the backplate bolts and are located between the backplate and the BCD wing.

The BM-counterlungs on the top are ensured by a plastic buckle 1,5" located on the strap of the backplate harness, ensuring their correct position.

The counterlungs can be removed for cleaning, disinfection, drying or storing.

The inhalation counterlung is located on the left side (meant from the viewpoint of the diver when wearing the XCCR), while the exhalation counterlung is located on the diver's right side.

The exhalation counterlung is equipped with the over pressure / dump valve located at the right lower edge of the exhalation counterlung allowing easy to drain eventual water that may penetrate via BOV into the exhalation counterlung. The over pressure / dump valve can be operated manually by pulling the string. The over pressure / dump valve is adjustable to allow the positive pressure test of the loop, while during the dive it have to be in the full open position to ensure maximum permissible overpressure in the breathing loop less than 40 mbar.



For adding diluent into the loop there is standalone manual adding valve, the Diluent MAV, connected via LP hoses from the appropriate manifold to the lateral inlet on the T-piece with integrated ADV, located on the inhalation counterlung.

For adding oxygen into the loop there is standalone oxygen manual adding valve, the oxygen MAV, connected via LP hoses from the appropriate manifold to the lateral inlet on the T-piece, located on the exhalation counterlung.

The manual adding valves (The MAVs ) are made of Delrin with a metal button valve and connecting fittings.

The MAVs are operated by pressing the large button on its side. The button for oxygen adding is marked by a small nipple in the middle. The button for diluent adding is marked by a dent in the middle. The MAVs have additional connecting port allowing connecting off-board gases via optional Swagelok QC6 quick-connect coupler, if necessary.

Use solely oxygen-compatible lubricant for maintenance of the manual add valves.

### 3.8 Front-mounted Counterlungs



The XCCR can be optionally equipped with the Front-mounted counterlungs, configured as the top of the shoulders counterlungs.

The counterlungs are connected to the breathing loop via the T-pieces on their top.

The counterlungs are made of a double layer, where the outer shell protects the inner bladder and bears all fasteners. The inner bladder is made of a thin and soft Cordura with PU coating. The inner bladder is accessible through a zipper on the side of the outer shell.

Both layers has two openings provided with different fittings for connecting the T-piece and the manual inflating valve.

The counterlungs are equipped with D-rings for attaching divers's accessories and with Velcro straps on the side for attaching the LP hoses leading from the manifold.



The counterlungs are fastened on the top by a plastic buckle 1,5" located at the top edge of the backplate, and then at the lower end by a plastic buckle 1" with a strap fixed to the belt. The counterlungs are also additionally fastened to the backplate harness by Velcro flaps. This ensures their correct position when wearing the XCCR and during the dive.

The counterlungs can be easily removed for cleaning, disinfection, drying or storing.



### The inhalation counterlung

is positioned at the left strap of the backplate harness (meant from the viewpoint of the diver when wearing the XCCR).

For adding diluent into the loop the inhalation counterlung is equipped with the manual inflating valve, which is located in the lower third of the counterlung.

### The exhalation counterlung

is positioned at the right strap of the backplate harness (meant from the viewpoint of the diver when wearing the XCCR).

The exhalation counterlung is equipped with the manual inflating valve for adding oxygen into the loop and also with the OPV - over pressure valve. The manual inflating valve is located in the lower third of the exhalation counterlung.

The OPV is located at the lower edge of the exhalation counterlung allowing easy to drain eventual water that may penetrate via BOV into the exhalation counterlung.



The manual inflating valves are made of Delrin and are connected to the Counterlungs via a socket and secured by a nut with trapezoidal thread resistant to damage. When attached to the Counterlungs the manual inflating valves remain revolving in full 360° range.

They are operated by pressing the center large button. The button for oxygen is marked as "Oxygen" and the button for diluent is marked as "Diluent".

The manual inflating valves are fed via LP hoses from the respective manifold.

The LP hoses are with a quick-release connector allowing quick disconnection or emergency connection of the off-board gases, if necessary.

Use solely oxygen-compatible lubricant for maintenance of the manual inflating valves.

The OPV - over pressure valve is the standard SiTech dry suit valve installed into a rubber sleeve positioned in the lower hole on the exhalation counterlung.

The required pressure in the breathing loop is regulated by turning the upper valve body. Turning counterclockwise sets the OPV to minimal overpressure. Turning clockwise sets the OPV to maximum overpressure.

### 3.9 BOV - Bail Out Valve

The Bail-Out Valve (BOV) is a Diver Surface Valve with a 2nd stage regulator incorporated into the mouthpiece with the ability of supplying the diver with open circuit breathing gas.

A diver can be switched to the closed circuit or if needed to the second stage regulator and breathe an open circuit bail-out gas. This allow the diver to have a source of breathing gas at all times. The BOV 2nd stage regulator is connected to the diluent cylinder via the LP hose connected to the diluent manifold or to an off-board bailout tank.



The BOV's CC/OC switching valve allows to switch between the close circuit (the CC mode) and the open circuit (OC mode) and is easy operated by rotating the knob on the front of the BOV.

When the BOV is switched to the CC mode - the knob is rotated to its horizontal position, the breathing loop is open via the mouthpiece, this allows the diver to breathe on the rebreather closed circuit.

When the BOV is switched to the OC mode - the knob is rotated to its vertical position, the open circuit via the 2nd stage regulator is operable while the rebreather breathing loop is fully closed. In this position no water can enter the breathing loop when the BOV is out of the diver's mouth and submerged.



In case that the BOV in CC mode is out of the diver's mouth and submerged, water can easily enter the breathing loop and flood the counterlung and even the whole rebreather. Therefore anytime before removing the BOV from the mouth, the diver must switch the BOV to OC mode.



**The knob must be turned always to its extreme positions (vertical or horizontal) and must never be turned in any intermediate position, this would cause malfunction due to semi opening of the CC and the OC mode together.**

### **One-way directional valves (mushroom valves)**

provide and ensure the correct breathing gas circulation in the breathing loop in the correct direction from left to right, from the inhalation counterlung to the exhalation counterlung, then through the CO<sub>2</sub> scrubber and subsequently to the oxygen sensors and back to the inhalation counterlung and over again.

They are among the most important parts of the BOV and the entire XCCR. They ensure gas flow in the correct direction from left to right and ensure the proper flow of the breathing gas through the entire rebreather. One-way directional valves ensure the exhaled breathing gas cannot return to the inhalation counterlung and cannot be repeatedly inhaled by the diver without removal of carbon dioxide and replenishment with oxygen.

When inhaling, the breathing gas comes from the inhaling counterlung on the left through the corrugated hose to the BOV, where it flows through the inhalation valve on the left side to the mouthpiece and into the diver's lungs.

When exhaling, the breathing gas flows through the mouthpiece and the exhalation one-way valve on the right side through the corrugated hose to the exhaling counterlungs on the right.



**The one-way directional valves are one of the most critical parts of the rebreather, where it is difficult to detect a malfunction on them during a dive. Therefore before every dive and before connecting the breathing corrugated hoses it is very important and necessary to check that the both one-way directional valves are in good condition and work correctly! If any of the valves would be found as not sufficiently flexible or even partially stiff or damaged in any way, any diving must be immediately canceled until the both valves are replaced with new ones and are functioning properly.**



**Ignoring this warning can lead to injury and possibly even death of the diver.**

### The mouthpiece

is the connection part between the rebreather and the diver. The mouthpiece is robust and anatomically shaped, because it has to ensure easy gas flow and a secure holding of the BOV in the diver's mouth during long dives.

### The 2nd stage regulator

is operable in the OC mode and allows the diver to breathe an open circuit bail-out gas. The 2nd stage regulator has an adjusting knob on the right allowing to adjust optimal breathing resistance and prevention against free flow.

### The breathing corrugated hoses

are connected via couplers and securing nuts onto the bayonet connectors on the BOV. The securing nuts are locked by the white buttons on the BOV.

It is impossible to connect the breathing hoses incorrectly due to different bayonet connectors on the BOV. The 3-lug bayonet is on the inhalation side on the diver's left and the 4-lug bayonet is on the exhalation side on the diver's right.

## 3.10 Oxygen Tank

The XCCR is equipped with a 3L / 232bar steel tank of 100 mm diameter, with nominal filling pressure 200 bar and the valve tread M25x2.

The tank is labeled as "OXYGEN".

The tank is fastened to the quick release fastener by stainless steel clamps and is located on the diver's right side when wearing the unit.

The oxygen tank monovalve has M26x2 / 200 bar outlet connection.

High pressure in the oxygen tank is measured by the HP-sensor in the head and is shown on the Primary Controller display.

High pressure is fed from the 1st stage regulator via Miflex HP hose to the HP-sensor located on the head, where the middle lower fitting UNF 7/8" marked "OXY".

The XCCR on the oxygen side uses Apeks TEK3 Nitrox 1st stage regulator with M26x2 connecting thread.

The oxygen 1st stage regulator has to be setup in the original LP pressure setting 9,5bar +/-0,5bar.



### 3.11 Diluent Tank ■ ■ ■



The XCCR is equipped with a 3L-232bar steel tank of 100 mm diameter, nominal filling pressure 200 bar, the valve tread M25x2.

The tank is labeled as "DILUENT".

The tank is fastened to the quick release fastener with stainless steel clamps and is located on the diver's left side when wearing the unit.

The diluent tank monovalve has DIN 5/8" / 200 bar outlet connection.

High pressure in the diluent tank is measured by the HP-sensor in the head and is shown on the Primary Controller display.

High pressure is fed from the 1st stage regulator via Miflex HP hose into HP-sensor located on the head, the middle top fitting UNF 7/8", marked "DIL".

The XCCR on the diluent side uses Apeks TEK3 first-stage regulator with G5/8" connecting thread.

The diluent 1st stage regulator has to be setup in the original LP pressure setting 9,5bar +/-0,5bar.

### 3.12 Back plate and Harness ■ ■ ■



The XCCR unit is carried by the backplate and attached on the diver's body via the harness.

The backplate is connected to the XCCR canister via backplate adapter with two M8 bolts and secured by large custom shaped M8 nuts.

The backplate is easy possible to dismount by unscrewing the M8 nuts and removing from the backplate adapter.

The harness is fully assembled together with the backplate. Before use it is necessary to adjust the harness to ensure proper fit .

The XCCR unit has to sit as high as possible on the diver's back.

The harness is equipped with a D-ring on the both shoulder straps, on the belt as well as on the crotch strap. D-rings are intended for attaching diver's accessories as well as a propulsion vehicle (scooter) attached to the D-ring located on the crotch strap.

The Front-mounted counterlungs, if used, must be fastened to the harness.

The tops of the counterlungs are equipped with female 1,5" buckle. The male 1,5" buckles are fixed on the strap at the top of the back plate.

The bottoms of the front-mounted counterlungs are equipped with female buckle 1". The male 1" buckles are fixed via a strap to the belt on the back plate.

### 3.13 Buoyancy Control Device - BCD Wing ■ ■ ■

The XCCR uses a wing-type buoyancy control device - BCD with nominal buoyancy 200 N.

The BCD are made of a double layer, where the outer shell of Cordura 2000 fabric protects the inner bladder and provides attachment to the XCCR unit. The inner bladder is made of Cordura 560 fabric with PU coating and is accessible through a zipper on the side of the outer shell.



The BCD is equipped with a standard manual inflating valve fed with gas via LP hose connected to the diluent manifold. The inflating valve is connected to the BCD via a corrugated hose.

The corrugated hose has to be fastened by the Velcro flaps on the side of the inhalation counterlung. This ensures the correct position of the inflating valve to be easy found and used during the dive.

The wing is fastened between the back plate and the backplate adapter by M8 screws. The supplied BCD is intended for use with XCCR with two 3 liter gas cylinders.



With the XCCR it is also allowed the use of another BCD Wing, which has a valid CE approval, meets the requirements of EN 14143, has a minimum volume of 20 liters and the inflating hose is located to the left (about 8-10 cm from the middle).



**The BCD is not a life support device !!!**

**This is not a lifejacket or a rescue device !!!**

**It is not designed to keep and maintain the diver's face above the surface if the diver lost control of him/her or become unconscious.**

### 3.14 XCCR Head

The X-head is the heart of the XCCR.

It contains the Solenoid & Oxygen control electronics, the solenoid valve adding oxygen, three oxygen sensor and one CO<sub>2</sub> sensor, two high-pressure sensors and two replaceable Li-Ion batteries.

The Solenoid & Oxygen control electronics (the SOLO board) is built in the hermetic compartment inside the head (not accessible by user).

The head is equipped with watertight connectors made of AISI 316L for easy connecting the Primary Controller handset, the Head-Up Display and an optional Secondary ppO<sub>2</sub> monitor / computer.

The watertight connectors are color coded this way:

- GREEN** DiveCAN Controller Bus.
- BLUE** DiveCAN Monitor Bus.
- BLUE-RED** Combined DiveCAN and Analog Monitor Bus.

The Primary Controller Handset must be connected to the **GREEN** labeled connector. The DiveCAN Head-Up Display must be connected to one of the **BLUE** labeled connectors. The DiveCAN Petrel Monitor must be connected to one of the **BLUE** labeled connectors. Any optional analog monitor / computer must be connected to the **RED** labeled connector.

The inner hermetically sealed compartment is equipped with a safety valve in case of a failure on a HP-sensor. The safety valve is located on the top of the head next to the connector marked as "SEC" (blue-red labeled).



The safety valve can not be adjusted or manipulated by a user under any circumstance!

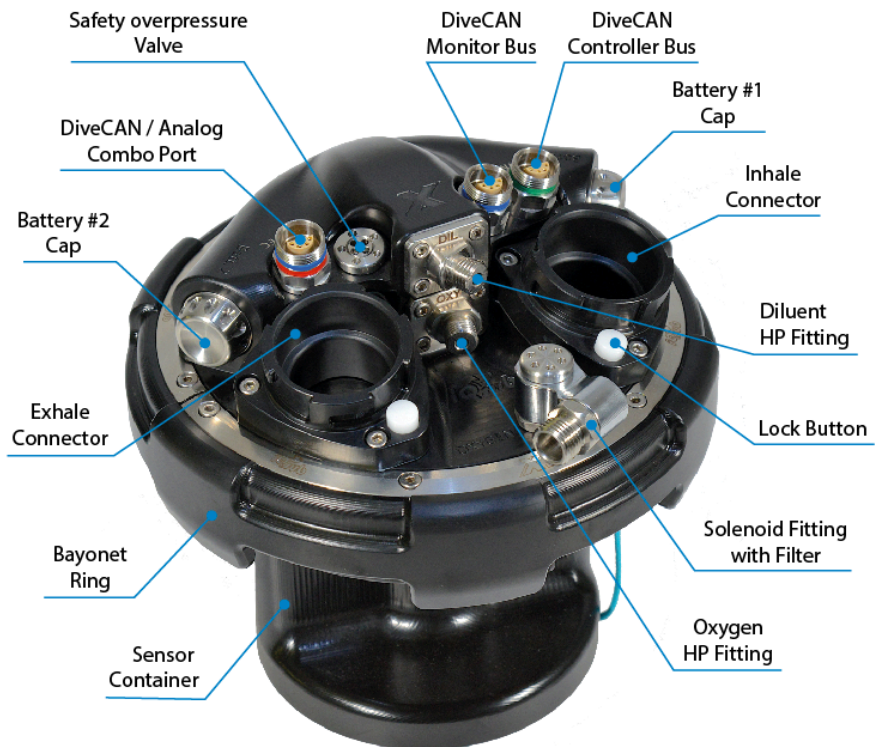



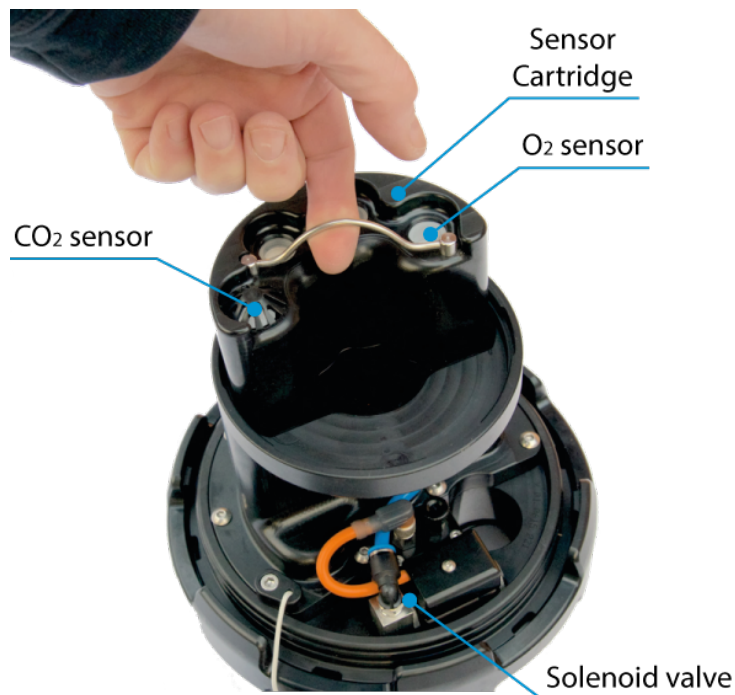

Three Oxygen sensors and built-in solid-state CO<sub>2</sub> sensor are placed in the easily removable sensor cartridge making it easy to dry, check or replace the sensors.

The sensor cartridge is connected to the head electronics via the robust 10-pin connector.

To remove the sensor cartridge, turn the sensor covering lid counterclockwise to its stop and pull the lid out. Then use the wire handle on the cartridge to pull the cartridge out.

To place the sensor cartridge back, insert the cartridge in the sensor container and push it to its stop to

connect the 10-pin connector on its bottom.

Place the wire handle to its right position (towards the sensors), insert the covering lid and turn it clockwise to the stop to lock it.

With the low power solenoid valve of AISI 316 Stainless steel body operates up to 17 bar (above the ambient pressure), no low-pressure adjustment on the 1st stage regulator is needed.

The solenoid is equipped with the swivel fitting UNF 9/16" with built-in O<sub>2</sub>-filter.

The XCCR head is mounted on the canister via the industry unique Quick Bayonet Lock. When installing the head, put the head on the canister and push and turn the head slightly until it fits into the bayonet locks. Then push the bayonet ring uniformly down (approx. 3mm) and turn it clockwise until it stops. The head is now locked on the canister.

When removing the head from the canister, push the bayonet ring uniformly down (approx. 3mm) and turn it counterclockwise until it stops to unlock the head, then pull the head up.

Two independent replaceable Li-Ion 18650 batteries are located in two separate compartments on the sides of the head, completely separate from the breathing loop. Batteries are accessible by unscrewing the battery caps.



**The battery Caps have to be tightened solely by fingers (without any tool), but each time up to its stop. This ensure the correct and reliable electric connection of the battery.**

**If the cap remains not tightened to its stop, this could cause short power outage due to a movement in the thread from pressure changes in the depth between ca. 15 to 20 m.**

### 3.15 Solenoid & Oxygen control electronics



The Solenoid & Oxygen electronics, the SOLO board, controls the Solenoid and maintains ppO<sub>2</sub> in the loop. The SOLO board is located in the hermetic compartment inside the head, not accessible by the user.

The SOLO board is power supplied from two independent batteries.

Only replaceable Li-Ion 3,7V, 18650 size batteries should be used in the XCCR Head.

The **Battery #1** supplies the Solenoid, while the **Battery #2** supplies the Head-Up Display and ppO<sub>2</sub> reading output for an additional secondary monitoring computer.

The fully charged battery should have a voltage of 4.1V - 4.2V.

The voltage of the discharged battery is about 3.6V.

The SOLO board has very low power consumption and providing long term battery life.

#### The SOLO Board functions & features

- |  |
|--|
|  |
| - monitoring the current ppO <sub>2</sub>              |
| - firing the solenoid and maintaining ppO <sub>2</sub> |
| - monitoring CO <sub>2</sub>                           |
| - HP pressure measurement                              |
| - Head-Up Display control and calibration              |
| - batteries status monitoring                          |
| - ppO <sub>2</sub> reading for a secondary computer    |

The SOLO board uses ppO<sub>2</sub> readings from three O<sub>2</sub> sensors to maintain the ppO<sub>2</sub> in the breathing loop in accordance with the current chosen setpoint.

PPO<sub>2</sub> reading output from all the three oxygen sensors are electronically separated one from another as well the PPO<sub>2</sub> reading outputs to the Primary Controller, Head-Up Display and the secondary computer are electronically separated one from another.

In the event of a failure or short circuit on any sensor or a connected device, it does not affect the values of the remaining ppO<sub>2</sub> readings.

In the event of a failure or short circuit on the cable connected to a secondary device, it does not affect the ppO<sub>2</sub> readings on the SOLO board as well as on outputs to the Primary Controller or the HUD.



In the event that communications between the Petrel controller and the X-head are lost for any reason or a short circuit on the cable connected to the Primary, the SOLO board in the head will continue working while revert to a **0.7** setpoint.

The SOLO board uses DiveCAN bus for communicating with connected electronics devices (see chapter 3.16).

## 3.16 DiveCAN Communication Bus



The DiveCAN<sup>®</sup> is a digital communication standard developed specifically for rebreathers by [Shearwater Research Inc.](#)

The DiveCAN<sup>®</sup> standard was designed to improve rebreather electronics. It offers the following advantages over an analog wiring:

- Robust error-checked communications. A message is either received correctly or it isn't. Compare this with analog wiring where corrosion or poor connections can result in incorrect data being used.
- Upgradable and expandable.
- Components (Primary Controller, HUD, secondary monitor, etc.) can be easily removed for travel, repair, backup, and upgrades.
- Modular design compartmentalizes critical functions for redundancy. For example, the Solenoid and Oxygen electronics (the SOLO board) can measure and inject oxygen independently of the handset. If the handset is unplugged or damaged, the SOLO board can continue to control loop PPO2.

A minimum configuration has:

One **Control Bus** with the Primary controller connected to the SOLO board and one **Monitor Bus** with the Head-Up Display connected to the SOLO board.

The **Monitor Bus** is independent and provides backup PPO2 monitoring in the event of a failure of the primary control bus.

The **Spare auxiliary port** can be used for additional devices or future expansion.

DiveCAN<sup>®</sup> devices connect together using specially designed underwater connectors. This allows easy disconnection of devices for travel, upgrades and repair.

## DiveCAN Bus diagram

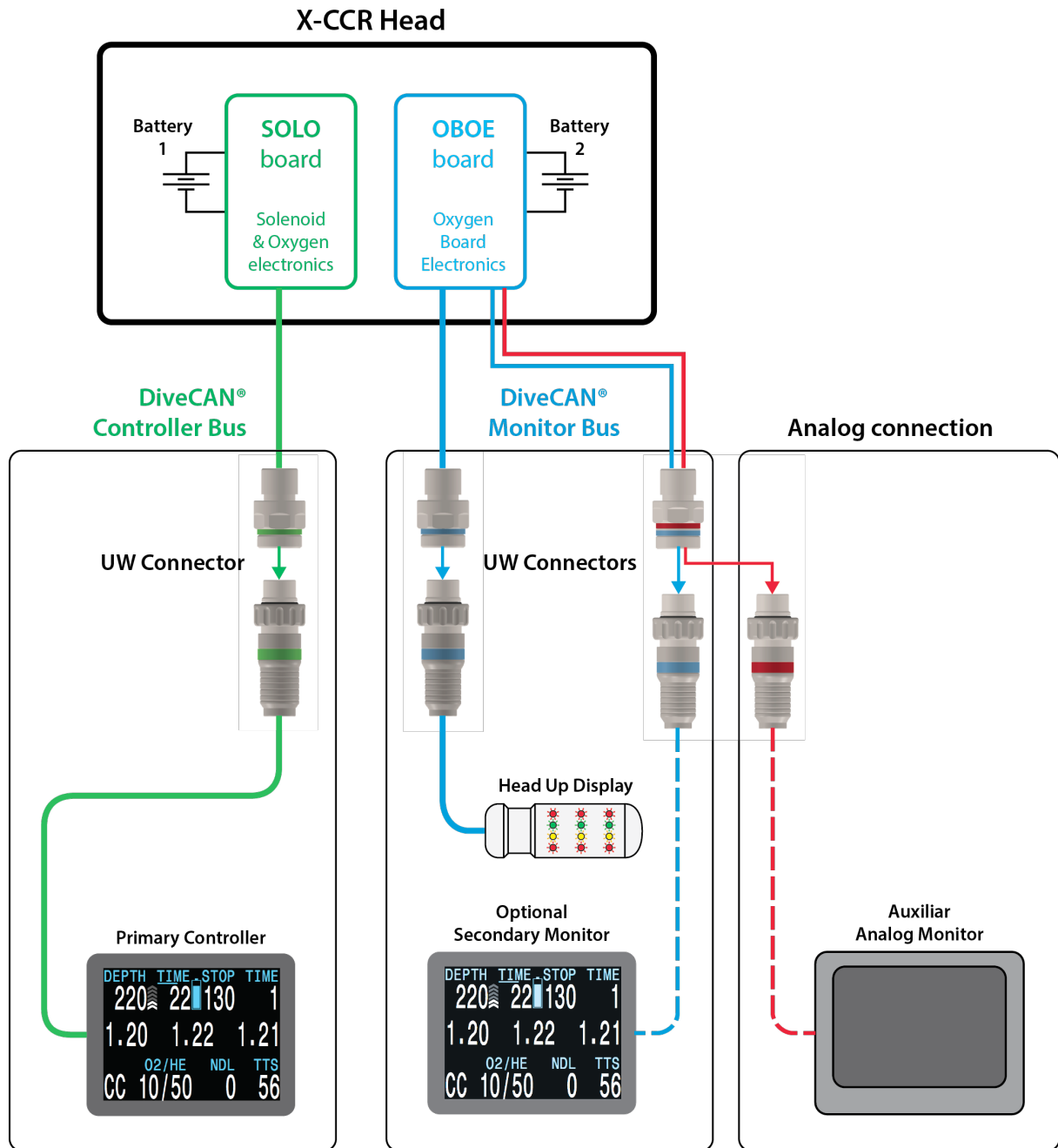

DiveCAN® connections allow rebreather components to communicate.

## 3.17 Primary Controller Handset

The Primary Controller Handset is the [Shearwater DiveCAN Petrel2 Controller](#), designed for the XCCR.

The Primary Controller Handset is connected to the SOLO board in the head via the UW connector to the **Control Bus**.

The Control bus connector on the Head as well as the cable connector of the Primary handset are marked with a **GREEN** ring.

### Feature List

- DiveCAN communications for robust connections
- Two PPO2 set-points, each of which can be set between 0.5 and 1.5
- Automatic PPO2 set-point switching (configurable)
- Depth, time and oxygen sensor display
- Bühlmann decompression model with gradient factors conservatism
- Optional VPM-B decompression model
- 5 CC and 5 OC gases
- Gases can be changed and added during a dive
- CNS tracking
- Dive Planner
- No lockout from violating deco stops
- Any combination of oxygen, nitrogen, and helium (Air, Nitrox, Trimix)
- Open and closed circuit, switchable during a dive
- Metric and Imperial displays
- Automatic turn off after 15 minutes on the surface
- Depth sensor rated to 450 feet/140 meters of seawater
- Tilt compensated digital compass
- 1000 hour dive log memory
- Log downloads and firmware upgrades using Bluetooth
- Flexible user replaceable "AA" battery of almost types

### Specifications

Specification	DiveCAN® Rebreather Model
Operating Modes	Closed Circuit (CC) Open Circuit (OC, for bailout)
Decompression Model	Bühlmann ZHL-16C with GF VPM-B and VPM-B/GFS (optional)
Pressure (depth) sensor	Piezo-resistive
Range	0 Bar to 14 Bar
Accuracy	+/-20 mBar (at surface) +/-100 mBar (at 14bar)
Crush Depth Limit	30 Bar (~290msw)
Surface Pressure Range	500 mBar to 1080 mBar
Depth of dive start	1,6 m of sea water
Depth of dive end	0,9 m of sea water
Operating Temperature Range	+4°C to +32°C



<b>Long-Term Storage Temperature Range</b>	+5 °C to +25°C
<b>Battery</b>	AA Size, 09V to 43V
<b>Recommended Battery Type</b>	AA 15V Photo Lithium (eg Energizer Ultimate Lithium)
<b>Battery Operating Life (Display Medium Brightness)</b>	35 Hours (AA 15V Alkaline) 55 Hours (AA 15V Photo Lithium) 100 Hours (SAFT LS14500)
<b>External Connector</b>	Hardwired cable to 5-pin DiveCAN® connector (male pins)
<b>Weight</b>	0,4kg
<b>Size (W X L X H)</b>	84mm x 74mm x 38mm

### 3.18 Head-Up Display ■ ■ ■

The Head-Up Display is the compact [Shearwater DiveCAN Head-Up Display](#) (the HUD) with PPO<sub>2</sub> monitoring on three O<sub>2</sub> sensors.

The main feature of the Head-Up Display (the HUD) is to show the current status of ppO<sub>2</sub> in the breathing loop as well as ppO<sub>2</sub> alarms to the diver.

The HUD is connected to the X-head by the cable with the UW connector marked with a **BLUE** ring.

The HUD is power supplied by battery #2 in the X-head.

The HUD has two wet contacts for automatic turning on when entering water. The rear longer wet contact acts as a mechanical push button.

**Turning On:** Press the push button once.

#### Basic Commands:

1. Press the button until desired column blinks
2. Hold for 3 seconds.
3. LEDs blink twice to confirm.
4. Command executes.

**TURN-OFF:** Turn-off to save power. The HUD will auto shutdown if not wet for 30 minutes.

**CALIBRATE:** Execute this command to perform PPO<sub>2</sub> calibration. Calibrates to a PPO<sub>2</sub> of 1.0 absolute atmospheres (ata) or bar. i.e. assumes 100% O<sub>2</sub> at sea-level.

Unplug the HUD and use alternate DiveCAN handset (e.g. the Primary controller or an optional PPO<sub>2</sub> monitor) for high-altitude calibration.

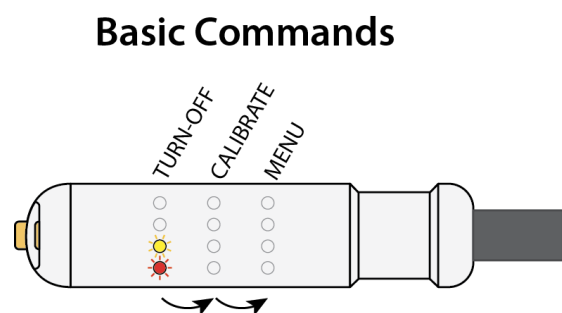

Each press advances one column

**MENU:** Execute this command to enter the Advanced Options menu.

**Advanced Options menu:**

Enter Advanced Options by executing MENU command (see above).  
Press to select, hold 3 seconds to confirm.

**SMITHER'S:** Default Smither's PPO2 code blink pattern.

**COLOR-BLIND:** Optional blink pattern that does not require color to determine PPO2

**Advanced Options**

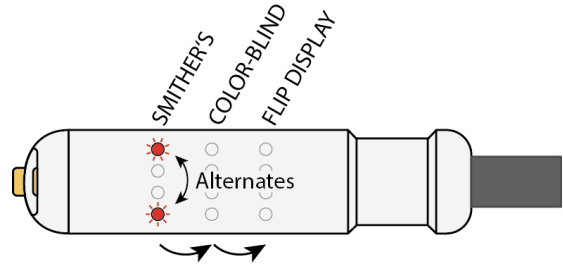



Each press advances one column

**PPO2 Display**

PPO2 (ata)	Modified Smither's (default)	Color Blind Option
Above 1,6	 Top-Red blinks each 0,1 above 1,6	 Top row blinks each 0,1 above 1,6
1,1 to 1,6	 Green blinks each 0,1 above 1,0	 Middle-top blinks each 0,1 above 1,0 ← Blinks ← On solid
1,0	 Green & Yellow blink once	 Both middle rows on solid ← On solid ← On solid
0,4 to 0,9	 Yellow blinks each 0,1 below 1,0	 Bottom-middle blinks each 0,1 below 1,0 ← On solid ← Blinks
Below 0,4	 Bottom-Red blinks each 0,1 below 0,4	 Bottom row blinks each 0,1 below 0,4

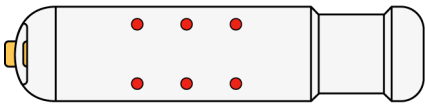
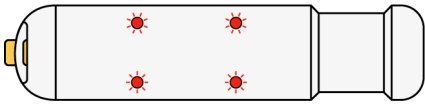
## Error Display

Error Display	Display Description	Error Description
	Top and bottom Red LEDs on solid	Sensor has failed PPO2 calibration. One or more columns may display this error.
	Four corners blinking	No communication with O2 sensor electronics.
	After turn on, the yellow row stays on for 30 seconds	Battery is low and should be changed

## Troubleshooting:

Bizarre displays or commands and PPO2 backwards?  
Flip HUD and do "Flip Display" command.

The button not working?

Ensure wet contacts are dry, as the button is disabled when diving (because wet).

The HUD is not able to turn on?

Check the battery #2 status and whether correct connection of the UW connector on the head.



**When not in use - always dry the wet contacts and turn-off the HUD to conserve battery power.**

## 4 OPERATING of Primary Controller

### 4.1 Turning ON

To turn the Primary Controller On:

Press both the MENU (left) and the SELECT (right) buttons at the same time.

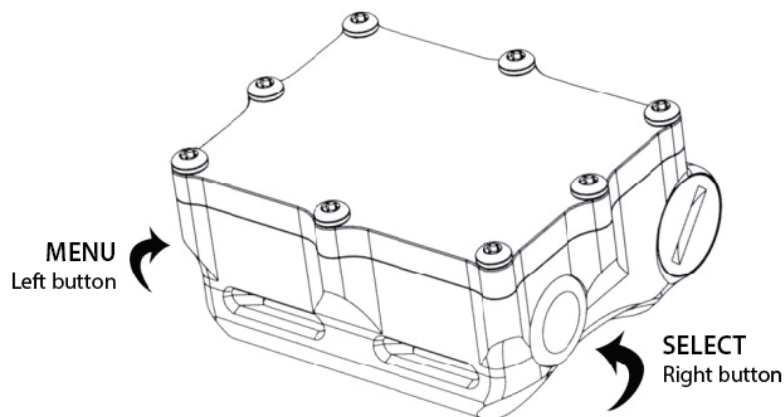

#### The Buttons

Two piezo-electric buttons are used to change settings and view menus. Except for turning the Primary Controller Handset On, all operations are simple single button presses.

#### MENU button (Left)

From main screen:	brings up the menu
In a menu:	moves to the next menu item
Edit a setting:	changes the setting's value

#### SELECT button (Right)

From main screen:	steps through information screen
In a menu:	performs command or starts editing
Edit a setting:	saves the setting's value

#### BOTH button (Left & Right)

When the handset is off: pressing MENU and SELECT at the same time will turn the Primary handset on.

No other operation requires pressing both buttons at the same time.

## Button Hints

When in a menu, button hints label each button

For example, the hints to the right tell us:

use MENU to **change** the brightness value

use SELECT to **save** the current value

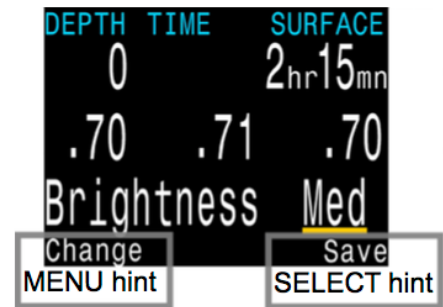

## 4.2 Turning OFF

The "Turn Off" menu will only appear when on the surface. The "Turn Off" menu item will not appear during a dive and also after a dive until the End Dive Delay time has expired

To turn the Primary Controller OFF:

- Press the MENU (left) button, "Turn Off" menu appears on the screen.
- Then confirm it by pressing the SELECT (right) button. Then the Primary Controller should turn off.



For detailed operating instructions for the XCCR primary controller see:

## Appendix 1 "Operation of SHEARWATER PETREL2 DiveCAN Controller"



## 5 PROCEDURES, Usage and Checks



### 5.1 Preparation before the dive



#### 5.1.1 Replacement of CO<sub>2</sub> sorbent

Remove the previous sorbent from the scrubber completely. If needed, clean up the perforated sheets from the rest of the sorbent or its dust.

Place the scrubber on a dry and clean surface. Turn the scrubber lid ring counterclockwise to unlock and pull it out to open the scrubber.

In order to prevent entrance of sorbent into the central tube, use the lid of the sorbent canister and place it on the central tube throat.

Pour the sorbent into the scrubber between the outer and inner tubes from the lowest height.

Fill the scrubber until approx. half full with the sorbent. Knock lightly all around the outer tube of the scrubber in order to level out the sorbent and compact it.

Fill the scrubber once more until reach the marker line - the lower edge of the top ring. Knock lightly all around the outside of the scrubber in order to level out the sorbent and compact it. If the sorbent final level is under the marker line, add the appropriate amount of the sorbent. If the sorbent final level is over the marker line, remove the appropriate amount of the sorbent to reach the correct level.

Then insert the scrubber lid, push the scrubber lid ring down and turn it clockwise to lock it. The scrubber is correctly filled if after shaking, rolling and a slight tapping on the ground, the level of the sorbent remain at the marker line - the lower edge of the top ring.

To check it you must open and then close the lid again. When opening the filled scrubber, the top lid should jump up spontaneously, what means that the springs were compressed well and so the self-packing feature works correctly.

After filling the scrubber turn it upside down and lightly tap it to remove dust that penetrated the central pipe.

Before inserting the scrubber into the XCCR canister, ensure that the water trap area in the canister is dry. Then insert the correctly filled scrubber into the canister.



#### **IMPORTANT:**

**Any sorbent that has already been used must never be used for another dive!  
Always handle the sorbent in accordance with the safety and operational instructions of the manufacturer.**

### 5.1.2 Assembling the head onto the canister body

Before mounting the head:

- take the sensor cartridge and visually check that all the oxygen and CO<sub>2</sub> sensors are installed and connected properly.
- then insert the sensor cartridge into the sensor container on the head and push it to its stop to connect the 10-pin connector on its bottom properly. Place the wire handle to its right position along the sensors and close the cartridge by insert the covering lid and turn it clockwise to lock it.
- apply oxygen-compatible lubricant on the inner sealing surface of the canister, where the head O-rings sit.

Mount the head on the XCCR canister. Place the head on the canister and rotate it a little bit until the bayonet fits to the grooves on the canister, push the bayonet ring uniformly down (ca. 3mm) and turn it clockwise until it stops to lock the head. The red dot marks must be accurately one above the other.

Connect the HP hoses to the UNF 7/8" fittings of the HP sensors on top of the head.

Connect the oxygen HP hose (56cm long) to lower fitting and the diluent HP hose to upper fitting. The HP connecting pin must be inserted into the both fittings before connecting the HP hoses.

Connect the oxygen hose (25cm long) that leads from the oxygen manifold to the solenoid fitting - the swiveled fitting UNF 9/16" at the peripheral edge of the head.

### 5.1.3 Connecting the back-mounted counterlungs and the breathing loop

Put the back-mounted counterlungs onto the backplate bolts between the backplate and the BCD wing and fasten all of them by the large M8 nuts.

Fasten the back-mounted counterlungs to the backplate harness by Velcro flaps on their back side and fasten the female buckle 1,5" on the counterlungs top to the male buckle located at the top D-ring of the backplate harness, ensuring their correct position.

Attach the inhalation hose with the ADV T-piece installed (blue marked hose clamps) to the left head hose connector with the 3-bit bayonet lock. Slide the hose coupler coaxially with the hose connector and turn the nut clockwise until the bayonet nut clicks to become locked.

Attach the ADV T-piece to the top fitting of the inhalation counterlung on the left, meant from the viewpoint of the diver wearing the unit, and secure it by the nut. Then connect the black LP regulator hose (40cm long), that leads from the diluent manifold, to the Shut-off valve, installed on the ADV.

Attach the diluent standalone manual adding valve by connecting the black LP hose (30cm long) to the ADV T-piece 's lateral inlet UNF 9/16". Then connect the black LP inflator hose (61cm long) by the quick-release connector to the diluent standalone MAV, that leads from the diluent manifold.

Attach the exhalation hose with the simple T-piece installed to the right head hose connector with the 4-bit bayonet lock. Slide the hose coupler coaxially with the hose connector and turn the nut clockwise until the bayonet nut clicks to become locked.

Attach the simple T-piece to the top fitting of the exhalation counterlung on the right, meant from the viewpoint of the diver wearing the unit, and secure it by the nut.

Attach the oxygen standalone manual adding valve by connecting the blue LP hose (30cm long) to the simple T-piece's lateral inlet UNF 9/16". Then connect the blue LP inflator hose (61cm long) by the quick-release connector to the oxygen standalone MAV, that leads from the oxygen manifold.

Attach the BOV to inhalation hose (blue marked hose clamps) to its left hose connector with the 3-bit bayonet lock and connect the LP regulator hose (75cm long) to the 2nd stage regulator of the BOV, that leads from the diluent manifold.

Attach the BOV to exhalation hose to its right hose connector with the 4-bit bayonet lock.

Put the LP hoses leading from the manifolds as well as the BCD's corrugated inflating hose into the position along the counterlungs and secure them with the the Velcro flaps on the outer side of the counterlungs.

Connect the quick-release connector of the inflator to the BCD.

Connect the black LP inflator hose (61cm long) by the quick-release connector to the BCD wing.

#### **5.1.4 Connecting the front-mounted counterlungs (if used) and the breathing loop**

Attach the front-mounted counterlungs with the female buckle 1,5" located at their top to the male buckle fixed on the strap at the top edge of the backplate, and then fasten them to the backplate harness by Velcro flaps on their back side, this ensures their correct position.

Attach the counterlungs with the female buckle 1" located at their lower point to the male buckle on a strap fixed to the belt.

Attach the diluent manual adding valve to the lower fitting of the inhalation counterlung, the left counterlung meant from the viewpoint of the diver wearing the unit, and secure it by the nut. Then connect the black LP inflator hose (61cm long) by the quick-release connector, that leads from the diluent manifold to the diluent manual adding valve.

Attach the oxygen manual adding valve to the lower fitting of the exhalation counterlung, the right counterlung meant from the viewpoint of the diver wearing the unit, and secure it by the nut. Then connect the blue LP inflator hose (61cm long) by the quick-release connector, that leads from the oxygen manifold to the oxygen manual adding valve.

Attach the inhalation hose with the ADV T-piece installed (blue marked hose clamps) to the left head hose connector with the 3-bit bayonet lock. Slide the hose coupler coaxially with the hose connector and turn the nut clockwise until the bayonet nut clicks to become locked.

Attach the ADV T-piece to the top fitting of the inhalation counterlung and secure it by the nut.

Attach the exhalation hose with the T-piece installed to the right head hose connector with the 4-bit bayonet lock. Slide the hose coupler coaxially with the hose connector and turn the nut clockwise until the bayonet nut clicks to become locked.

Attach the T-piece to the top fitting of the exhalation counterlung and secure it by the nut.

Attach the BOV to inhalation hose (blue marked hose clamps) to its left hose connector with the 3-bit bayonet lock and connect the LP regulator hose (75cm long) to the 2nd stage regulator of the BOV, that leads from the diluent manifold.

Attach the BOV to exhalation hose to its right hose connector with the 4-bit bayonet lock.

Put the LP hoses leading from the manifolds as well as the BCD's corrugated inflating hose into the position along the counterlungs and secure them with the the Velcro flaps on the outer side of the counterlungs.

### 5.1.5 Filling the gas cylinders

Filling the tanks is subject to specific safety regulations and must be carried out by a qualified personnel, especially in the case of filling and handling oxygen.

If you are not such a person, leave the blending of mixtures to a fully qualified person.

### 5.1.6 Battery charging

Before charging, the Li-Ion batteries 18650 must be removed from the battery compartment in the head. Check that the batteries are not deformed, corroded or otherwise damaged, otherwise replace them immediately.

Do not discharge the batteries before charging.

Insert the batteries into an external charger that came with the XCCR unit and connect the charger to the power supply 110V - 240V. Charging is displayed by the LED indicator going to blink. Once the charging is finished, LED indicator lights steadily.

Remove the batteries from the charger and place them into the battery compartment on the head with its plus contact forward.

Check the battery caps, especially the sealing o-ring to be clean and lightly greased, if not, clean the o-ring and grease it lightly with an oxygen compatible or silicone lubricant.

Keep the thread and the sealing surface in the battery compartment clean.

Screw the caps into the battery compartment solely by fingers without any tool up to its stop (touching the metal ring) to ensure proper electrical connection.



**If the battery cap remains not tightened to its stop (up to the metal ring in the head), this could cause a brief interruption of power due to a movement in the thread from pressure changes in the depth between ca. 15 to 20 m.**

**The batteries must be checked and recharged before every dive, especially before the first dive after some period of no activity.**

Before any long period of storage and before transport remove the both batteries from the head. The Solenoid & Oxygen electronics (the SOLO board) in turn-off mode has minimal current consumption, but after a long period of time it can drain the battery significantly.

Especially during a transport it can be switched on by improper handling or manipulation, which may cause switching on the unit and so to discharge the batteries or even emptying the oxygen tank (due to active solenoid) before diving.

### 5.1.7 Calibration of oxygen sensors

The oxygen sensor have to be calibrated by the Calibration kit supplied with the unit, which consists of two parts, the calibration insert and the check valve.

Remove the head from the canister, so that the inlet throat of the sensor lid is accessible. Put the calibration insert into the sensor lid inlet and attached a LP inflator hose connected to the oxygen manifold. For this purpose, disconnect the hose leading to the manual adding valve and attach it temporarily to the calibration insert.

Remove the inhaling breathing hose on the left (blue marked clamps) and insert the check valve into the hose connector to close the sensor chamber in the head.

Then slightly open the valve on the oxygen tank, so that only a little oxygen to flow through the sensor chamber and the check valve out.

Turn On the primary handset.

Wait a couple of seconds for mV stabilization on the sensors readings

Perform calibration procedure in accordance with the chapter A1.4.2 Calibration.

At higher altitudes above sea level perform altitude calibration.



**If any failure in the calibration process, repeat the whole procedure again.  
If any repeated failure on any oxygen sensor, this must be replaced immediately and permanently before the next dive.**

### 5.1.8 One-way directional valves check

The one-way directional valves are one of the most critical parts of the rebreather, where it is difficult to detect a malfunction on them during a dive. Therefore before every dive and before connecting the breathing corrugated hoses it is very important and necessary to check that the both one-way directional valves are in good condition and work correctly! If any of the valves would found as not sufficiently flexible or even partially stiff or damaged in any way, any diving must be immediately canceled until the both valves are replaced with new ones and are functioning properly.

Remove the BOV from the breathing hoses, switch it to the CC mode and insert the mouthpiece in the mouth.



Cover the left hose connector on the BOV and try to do suction in the mouthpiece, no gas can enter the BOV, while exhalation should be possible.

Cover the right hose connector on the BOV and try to do overpressure in the mouthpiece, no gas can leave the BOV, while inhalation should be possible.

Then execute the check on possible leaking, switch the BOV to the OC mode and insert the mouthpiece in the mouth. Try to do strong suction in the mouthpiece for a couple of seconds. No gas can enter the BOV in this situation. During the test the diluent tank has to be closed or the 2nd stage regulator hose has to be disconnected and the inlet has to be sealed by a finger.

### **5.1.9 The whole XCCR unit inspection**

Check thoroughly that the XCCR is complete, that all the XCCR components and its parts are assembled properly and no part been replaced with another, which is not part of the original XCCR.

If any part would be found defective or damaged, even partially, any further use of the XCCR is prohibited until the defect is completely fixed.

### **5.1.10 Bail-out system**

The diver has to take appropriate bail-out system, which enables safe return to the surface from the deepest / farthest point of the dive with the longest decompression time while having the safety margin.

The useful procedure is to take a corresponding number of stage tanks with appropriate travel and decompression gases while having a bail-out plan for every dive. Preparation and setting up the bail-out stage tanks is similar to open circuit diving.

### **5.1.11 Donning and fitting of the XCCR unit on the diver**

After fulfilling the pre-dive check, the unit has to be placed on a flat and stable surface, where the unit is well accessed in a standing position of the diver and can be easy donned on the diver.

Before donning the unit there is necessary to check that the harness is adjusted to the physical dimensions of the diver. The XCCR unit has to sit as high as possible on the diver's back, while it must be comfortable enough. The unit and the harnesses must not restrict the free breathing of the diver.

Move the breathing corrugated hoses with the BOV of over the unit on its opposite side.

Don on the harness straps on the shoulders while standing on both feet and place the unit on your back. In a little forward bend slightly raise up the unit to shortly release the straps to allow setting the unit on your back properly.

Place the crotch strap into the final position, then pass the belt buckle through the eye of the crotch strap, slightly tighten the belt and lock the buckle.

Move the breathing corrugated hoses with the BOV over your head back onto the chest.

If the Front-Mounted Counterlungs are applied, fasten the lower female buckles of the front-mounted counterlungs to the belt via the short straps with the male buckle placed on the belt on the right and on the left.

Check that all the harness and straps fit well on the diver's body and are adequately tightened.

Fasten the Primary Controller Handsets to the left wrists as well as the secondary computer (if applied) to the right wrist.

Place the BCD inflating valve to the correct and well accessible position.

Check, that the unit sits on the body comfortably and no part of the unit or harness doesn't push or obstruct anywhere on the diver's body.

#### **Donning and fitting of the XCCR unit with Back-mounted counterlungs:**





**Donning and fitting of the XCCR unit with Front-mounted counterlungs:**



## 5.2 Checklist - Prior the dive



Prior every dive on the XCCR unit it is essential that the diver executes all the checks according to this checklist:

Check procedures - Prior the dive	
Step	Procedure description
1	Check the CO <sub>2</sub> scrubber that is filled with new soda lime that has never been used before.
2	Check that the CO <sub>2</sub> scrubber is inserted in the canister
3	Check the sensor cartridge is inserted into the head
4	Check the sensor lid is inserted and locked.
5	Analyze the content and the sufficient pressure of the diluent and oxygen tanks. Check the tanks are fastened properly.
6	Take a Bailout system adequate for the dive, while assume the worst case scenarios.
7	Open the tank valves on the both tanks and check displaying of the pressure.
8	Check the medium pressure of both 1st stage regulators. The medium pressure of oxygen and diluent pressure must be within the range 9,5 +/-0,5 bar and stable. It is prohibited to dive the unit, if the medium pressure is out of the range.
9	Calibrate the O <sub>2</sub> sensors and CO <sub>2</sub> sensor
10	Place the head onto the canister and lock the head bayonet
11	Check the head bayonet whether red dot marks being accurately one above the other.
12	Check all the LP and HP hoses are connected. Take care to ensure that the O-rings are clean.
13	Check that the both one-way directional valves in the BOV are in good condition and work correctly!
14	Check the manual adding valves that are working properly.
15	Check the ADV that is working properly.
16	Check the BCD wing inflating valve that it works properly.
17	Check the BOV to ensure that the CC/OC switch and the 2nd stage regulator are working properly.
18	Check the overpressure / drain valve on the counterlungs that is working properly.
19	Perform the negative pressure test: Close the both tank valves and perform suction via the mouthpiece and make underpressure in the breathing loop. Close the BOV and wait a few minutes, whether the breathing loop still keeps underpressure.
20	Open the both tank valves.
21	Perform the positive pressure test: Fill the breathing loop with air fully via the mouthpiece, until the overpressure valve on the counterlungs releasing the overpressure. Close the mouthpiece and wait a few minutes, whether the breathing loop still keeps overpressure.
22	Switch the primary handset on and check the status of batteries, pressure in the tanks, the HUD functioning well, solenoid works correctly.
23	Open the BOV - switch to CC mode
24	Breathe for 2-3 minutes from the unit in order to check that the CO <sub>2</sub> scrubber works properly.
25	Close the BOV - switch to OC mode
26	Switch the primary handset off and close the both tank valves

### 5.3 Checklist - Just before the dive



Prior entering the water, the diver has to execute all the checks according to this checklist:

Check procedures - Just before the dive	
Step	Procedure description
1	Open the tank valves on the both tanks and check the system, that no gas leak anywhere
2	Check the manual adding valves that are working properly.
3	Check the ADV that is working properly.
4	Check the BCD wing inflating valve that it works properly.
5	Check the BOV to ensure that the CC/OC switch and the 2nd stage regulator are working properly.
6	Perform the negative pressure test
7	Perform the positive pressure test
8	Turn On the primary controller handset and check the Low setpoint, status of batteries, pressure in the tanks, the HUD functioning and that the solenoid works correctly.
9	Breathe for 2-3 minutes from the unit in order to check that the CO <sub>2</sub> scrubber works properly.

### 5.4 Checklist - When entering the water



Do not enter the water without having performed the Prior dive check !

Just after entering the water, the diver has to execute all the checks according to this checklist:

Check procedures - When entering the water	
Step	Description
1	Perform a bubble check in the shallow water between the surface and 3m depth. Never start a deeper descent without carrying out the bubble check.
2	Check the display on the primary controller and whether the Low setpoint is set. Check the HUD is operating correctly.
3	Check that the unit is positioned correctly and sits comfortably on the back, that every its part is in the right position.
4	Check that breathing is comfortable and without any increased breathing resistance



## 5.5 When diving



When diving the unit, the diver have to read the HUD signals and check the current values on the primary handset. The diver has to check the current ppO<sub>2</sub> reading on every cell, the current status of batteries, pressure in the tanks, any alarms displayed on the screen, current depth and time, the status of the stack timer and CO<sub>2</sub> reading.



**The most important information, which must be known by the diver in every moment, is the current ppO<sub>2</sub> in the breathing loop !!!**

The optimum diver's position in the water with respect to minimum breathing effort is at an angle of 10 - 20 degrees, this means that the diver's head is a little bit higher than the legs. Breathing should be deep and continuous all the time. The volume of the breathing loop should be as low as needed for comfortable breathing. Too high volume brings effect on breathing effort as well as on buoyancy. Low volume is optimal until spontaneous triggering of the ADV is not needed.



**In case, that the ppO<sub>2</sub> deviation from the setpoint is close to the safe limits (0,4 bar or 1.6 bar), then there is necessary intervention of the diver to maintain the ppO<sub>2</sub> in the breathing loop manually within the safe limits:**

**At high ppO<sub>2</sub> - flush the loop with diluent in appropriate volume via the manual adding valve.**

**At low ppO<sub>2</sub> - use manual dosing of oxygen via the manual adding valve, while dose in a few steps with a delay of 10 seconds between doses (due to delay on O<sub>2</sub> cell readings).**

**This situation can happen during diving if too fast ascent or too fast descent of the diver or when a failure of the solenoid.**

## 5.6 Checklist - After the dive



This procedure describes all steps that should be performed on the XCCR unit after the dive.:

After the dive Procedures	
Step	Procedure description
1	Never close the tank valves until you take off the XCCR unit.
2	Take off the XCCR unit.
3	Turn Off the primary controller handset and make its wet contacts dry.
4	Turn Off the Head-Up Display and make its wet contacts dry.
5	Close the oxygen and diluent tank valves.

6	Remove the head, open the sensor container and pull out the sensor cartridge to dry.
7	Take off the scrubber and leave it out to dry.
8	Wipe the canister to dryness.
9	Remove the breathing hoses from the head, remove the T-pieces from Counterlungs and remove the BOV.
10	Rinse the breathing hoses and T-pieces with fresh water, hang them in a vertical position and leave to dry.
11	Rinse the BOV and leave it to dry.
12	Take off the counterlungs, rinse with fresh water and hang to dry.

Steps 5 to 10 are only necessary if no further dive will be done in the same day.

## 5.7 Quick cleaning of the unit ■ ■ ■

The quick-cleaning procedure should be performed after every dive.

Quick cleaning Procedures	
Step	Procedure description
1	Rinse the fully assembled and closed XCCR unit with fresh water.
2	Remove the head, open the sensor container and pull out the sensor cartridge
3	Take off the scrubber
4	Wipe the canister, the sensor container and the sensor cartridge to dryness.
5	Remove the breathing hoses with T-pieces, the BOV and Counterlungs
6	Rinse the breathing hoses with T-pieces, the BOV and the counterlungs thoroughly with fresh water and leave them to dry.
7	Hang the breathing hoses with T-pieces in a vertical position and leave them to dry
8	Leave the unit to dry.



**Each time before every cleaning REMOVE the sensor cartridge from the Head !  
The sensor cartridge contain electronics parts, which may be damaged.**

**Each time before every cleaning REMOVE the Scrubber from the Unit !  
Soda lime with water forms caustic solution, which may damage electrical  
and metal parts of the Unit.**

## 5.8 Complete cleaning of the unit ■ ■ ■

The complete cleaning procedure should be performed at the end of the diving day.

Procedures - Complete cleaning	
Step	Procedure description
1	Rinse the fully assembled and closed XCCR unit with fresh water.
2	Remove the head, open the sensor container and pull out the sensor cartridge
3	Take off the scrubber and remove the soda lime.
4	Wipe the canister, the sensor container and the sensor cartridge to dryness.
5	Remove the breathing hoses with T-pieces, the BOV and Counterlungs.
6	Prepare the recommended disinfectant solution in accordance with its manufacturer specifications.
7	Immerse the breathing hoses with T-pieces and the BOV into the disinfectant solution for a couple of minutes (in accordance with the manufacturer specifications).
8	Rinse the breathing hoses with T-pieces and the BOV thoroughly with fresh water and leave them to dry
9	Pour a appropriate small amount of disinfectant into the counterlungs, fill them with water and allow the solution to act for a couple of minutes (in accordance with the manufacturer specifications).
10	Empty the counterlungs, rinse them thoroughly with fresh water (min. 2x) and hang them in vertical position to dry (with T-piece socket down)
11	Hang the breathing hoses with T-pieces in a vertical position and leave them to dry
12	Leave every part of the XCCR unit to dry.



Each time before every cleaning, **REMOVE the sensor cartridge from the Head!**  
The sensor cartridge contain electronics parts, which may be damaged.

Each time before every cleaning, **REMOVE the Scrubber from the Unit!**  
Soda lime with water forms caustic solution, which may damage electrical and metal parts of the Unit.

The XCCR unit has to be stored in a dry and well ventilated space without sunlight (UV radiation).

Prior to storage, every part of the breathing loop must be cleaned and disinfected thoroughly in accordance with chapter 5.8 Complete Cleaning and must be completely dry.

The scrubber must be emptied, cleaned and dry and should be inserted into the XCCR canister.

The XCCR unit has to be fully assembled to avoid penetration of any living creatures into the breathing loop.

The BOV has to be partially open to avoid the loading on the one-way valves due to changes in ambient pressure. The switch knob should be in its middle position (45°).

The unit should be stored in a vertical position (head up), it is also admissible to store the unit in horizontal position with the canister down while the counterlungs and breathing hoses on top.

For extended storage (a year or more) it's recommended to keep the gas pressure in the both gas tanks in range 30 to 50 bar.

## 6 MAINTENANCE and SERVICING



## 6.1 Maintenance ■ ■ ■

The XCCR unit should be treated with thorough care. The care generally includes regular inspection of the equipment status, regular cleaning and greasing all the o-rings as well as sealing surfaces, monitoring and observing the maintenance intervals.

All the rubber and plastic parts getting older and this process is accelerated if exposed to direct sunlight and or to longer exposure to salt. The parts listed in the table should be replaced during standard maintenance period, but at the latest after the end of their service life given in the table:

Service lifetime	Part
5 years	Counterlungs, BCD wing
5 years	All rubber parts - Breathing hoses, O-rings, membranes
5 years	Diluent high and low pressure hoses
5 years	Oxygen high and low pressure hoses
2 years	Diaphragm assembly in the BOV 2nd stage regulator
2 years	Diaphragm in the ADV
1 year	Oxygen sensors and BOV's one-way valves

When observing the maintenance intervals, the production date of the unit is decisive.

The service life of oxygen sensors is one year or maximum 18 months from the date of production printed on the sensors.

## 6.2 Maintenance and Service inspection intervals ■ ■ ■

The XCCR unit must be maintained and serviced according to the given intervals specified in the tables below and under these conditions:

### The user

may replace oxygen sensors, o-rings in the breathing loop, breathing hoses, diaphragms in the BOV and ADV, BOV's one-way directional valves, shut-off valve, scrubber, fasteners and counterlungs assembly.



**The user must use solely original XCCR spare parts. If any other part would be used, the warranty is voided and this brings a significant risk of malfunction what could result injury or even death.**

## The replaced parts must be returned back to the manufacturer.

The periodical maintenance, service inspections and repairs on the electronics, solenoid, 1st stage regulators, BOV, ADV and the BCD wing must be performed solely by the manufacturer or by a service centre approved by the manufacturer.

The periodical maintenance intervals are based on normal usage.

In case of more intensive usage or the unit is used at training courses, the periodical maintenance intervals must be adequately shortened.

Defective and or unreliable parts must be replaced immediately, regardless of the periodical maintenance and service inspection intervals.

## Regular service inspection

The XCCR requires regular service inspection always after the period of 12 months or after 100 hours of underwater usage of the unit.

If the unit is used in salt water or polluted waters, it requires a reasonably shorter service intervals.

Service inspections must be performed solely by the manufacturer or by a service centre officially approved by the manufacturer.

### 6.3 12-months Maintenance and Service interval ■ ■ ■

Part	Maintenance or Service performance
Oxygen sensors	Replace every O2 sensors, if the period of use is 12 months or more or the period from the manufacturing date is 18 months or more.
Oxygen 1st stage regulator	Revision or setting of the low pressure to 9,5 +/- 0,5 bar, inspection of the valve seat, diaphragm, o-rings. Performing of the oxygen service.
Diluent 1st stage regulator	Revision or setting of the low pressure to 9,5 +/- 0,5 bar, inspection of the valve seat, diaphragm, o-rings.
HP and LP oxygen hoses	Inspection and oxygen service on all the oxygen hoses.
HP and LP diluent hoses	Inspection on all the diluent hoses.
Breathing loop	Replacement of o-rings on all the breathing hose connections and on the head.
BOV	Replacement of the one-way directional valves, cleaning and greasing the CC/OC valve. Revision of the 2nd stage regulator and breathing parameters.
Scrubber	Inspection on the scrubber tubes and connections. Replacement of all the o-rings.
High pressure sensors	Inspection of the HP values displayed on the Primary handset.
CO2 sensor	Inspection of the CO2 solid state sensor and that it displays correct value.



XCCR Head	Replace the two o-rings 156x3 on the head.
BOV	Replace the 2nd stage regulator diaphragm and exhalation valve.
Oxygen tank	Let do an official pressure test and oxygen service, this has to be in compliance with the specific regulations applicable in the country of use. Replace gas marking stickers.
Diluent tank	Let do an official pressure test, this has to be in compliance with the specific regulations applicable in the country of use. Replace gas marking stickers.
ADV	Replace the blue diaphragm.

## 6.4 36-months Maintenance and Service interval ■ ■ ■

Part	Maintenance or Service performance
XCCR Unit	Return the whole unit to the manufacturer or a service centre officially approved by the manufacturer to perform the complete inspection, maintenance and services.

## 7 Warranty ■ ■ ■ ■ ■

The company iQsub Technologies s.r.o. provides a 12-months warranty to the first owner to the proper operation of the unit.

The company iQsub Technologies s.r.o. guarantees that the product will be free of defects in material and workmanship, provided that compliance with the recommendations for the user, maintenance and service within the following limits.

The guarantee does not apply in the case of misuse, neglect, modification or unauthorized servicing of the product.

Warranty coverage is limited to the repair or replacement of parts or the whole product, depending on decisions of the company iQsub Technologies s.r.o.



**Self-repair results in loss of warranty and can lead to loss of health or even of life !!!**

## 8 Impressum ■ ■ ■ ■ ■

This user instructions manual was created and produced by iQsub Technologies s.r.o. in 2017. The original version is in English language. All other language mutations of this manual are based on the original English version.

All information in this document is believed to be accurate and sufficient to the safe operation of the XCCR unit.

The User Instructions content is based on knowledge available at the time of issue. iQsub Technologies s.r.o. reserves the right to make changes at any time. New updates will be available at the manufacturer or on its official web page iQsub.com.

Reproduction and/or changes of this document in whole or in part are expressly prohibited without written approval from iQsub Technologies s.r.o.

As it is not possible to guarantee full accuracy and aptness of this document, all liability from this document is excluded.

Cited companies or product names are trademarks belonging to the respective companies.

is a trademark of iQsub Technologies s.r.o. registered since 2000.



is a trademark of iQsub Technologies s.r.o. for Diving Breathing Apparatus, registered since 2015.

is a trademark of Shearwater Research Inc.



is a trademark of Shearwater Research Inc. for digital communication standard developed for rebreathers.



# Appendix 1

## "Operation of SHEARWATER PETREL2 DiveCAN Controller"

### List of content

- A1.1 Main Screen
- A1.2 Info Screens
- A1.3 MENU
- A1.4 MENU Reference
  - A1.4.1 Turn Off
  - A1.4.2 Calibration
  - A1.4.3 Calibration Problems
  - A1.4.4 Switch Setpoint
  - A1.4.5 Select Gas
  - A1.4.6 Switch to OC/CC
  - A1.4.7 Dive Setup+
  - A1.4.8 Edit Low Setpoint
  - A1.4.9 Edit High Setpoint
  - A1.4.10 Define Gas
  - A1.4.11 Brightness
  - A1.4.12 Setpoint -> 0,19
  - A1.4.13 Dive Log Menu
  - A1.4.14 System Setup+
- A1.5 Display Setup
- A1.6 Compass Setup
- A1.7 System Setup
- A1.8 Stack-Timer Setup
- A1.9 CO<sub>2</sub> Monitoring Setup
- A1.10 Firmware Upload and Dive Log Download
- A1.11 Changing the Battery
- A1.12 Tissue Cleared
- A1.13 Error Displays
- A1.14 Storage and Maintenance
- A1.15 Servicing

The main screen shows the most important information needed for technical diving.



**Top Row**

Depth, Ascent Bar Graph, Battery status, Dive Time / Deco Stops / Surface interval

**Center Row**

PPO<sub>2</sub> as measured from three O<sub>2</sub> sensors

**Bottom Row**

Circuit Mode, Current Gas & Deco Info (NDL - no deco limit, TTS - time to surface)

**Color Coding**

Color coding of text draws attention to problems or unsafe situations  
White text indicates normal conditions.



**YELLOW** is used for warnings that are not immediately dangerous but should be addressed.

Sample warning: A better gas is available.

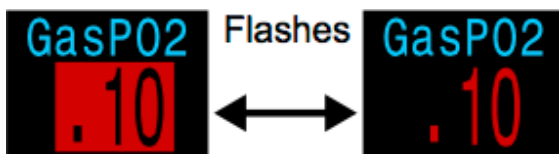

**FLASHING RED** is used for critical alerts that could be life threatening if not immediately addressed.

Sample critical alert: Continuing to breathe this gas could be fatal.

**Color Blind Users**

The warning or critical alert states can be determined without the use of color

Warnings display on a solid inverted background  
Critical alerts flash between inverted and normal text

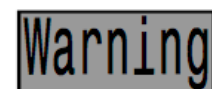

Warning - doesn't flash

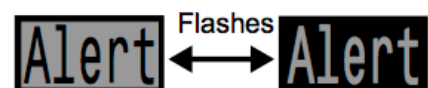

Critical alert - flashes

**The Top Row**

The top row shows depth and time information



### Depth

- Imperial: In feet (no decimal places)
- Metric: In meters (displays with 1 decimal place up to 999m)
- Note: If the depth shows a **Flashing Red zero**, then the depth sensor needs service

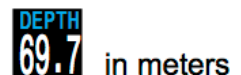

### Ascent Bar Graph

- Shows how fast you are currently ascending:
- Imperial: 1 arrow per 10 feet per minute (fpm) of ascent rate
- Metric: 1 arrow per 3 meters per minute (mpm) of ascent rate

White when 1 to 3 arrows, **Yellow** when 4 to 5 arrows  
**Flashes Red** when 6 arrows or more

Note: Deco calculations assume 33fpm (10mpm) ascent rate

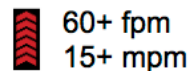
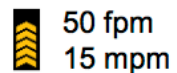
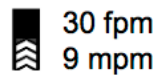

### Dive Time

- The length of the current dive in minutes
- The seconds display as a bar drawn below the word "Time".
- It takes 15 seconds to underline each character in the word.
- Does not display the seconds bar when not diving.

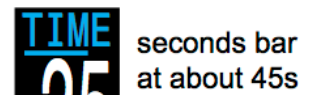
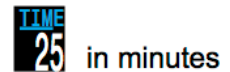

### Battery Icon

- Yellow** when the battery needs to be changed
- Red** when the battery must be replaced immediately
- The default behavior is that battery icon is shown on the surface but disappears when diving.
- If low or critical then the battery icon will appear while diving.

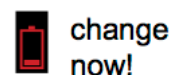
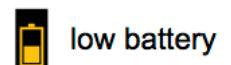

### Stop Depth and Time

Stop – The next stop depth in the current units (feet or meters).

This is the shallowest depth to which you can ascend.

Time – The time in minutes to hold the stop.

Will Flash Red if you ascend shallower than the current stop.

By default the Primary Controller Handset controller uses a 3m last stop depth (10ft).

At this setting, you may perform the last stop deeper if you choose.

The only difference is that the predicted time-to-surface will be shorter than the actual TTS since off-gassing is occurring slower than expected.



Stop at 90ft for 2 min



Alert - depth is shallower than the 90ft stop depth

There is also an option to set the last stop to 20ft (6m) if you wish.

### Surface Interval

When on the surface, the STOP DEPTH and TIME are replaced by a surface interval display.

Shows the hours and minutes since the end of your last dive Above 4 days, the surface interval is displayed in days.



The surface interval is reset when the decompression tissues are cleared See the section on Tissues Cleared.

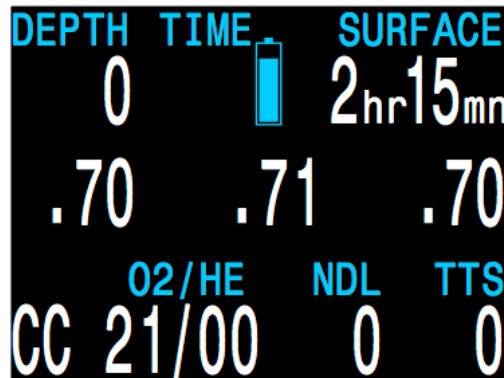

## The Center Row



The center row displays PPO2 as measured from three O2 sensors



PPO2 units are absolute atmospheres (1ata = 1013mbar).

A voting algorithm is used to decide which of the three sensors are likely to be correct. If a sensor matches either of the other two sensors within ±20%, it passes voting. The system average PPO2 is the average of all sensors that have passed voting.

If all sensors fail voting, then the display will alternate **VOTING FAILED** with the PPO2 measurements (which will all be **yellow** to indicate that voting has failed). When voting has failed, the lowest PPO2 reading will be used for deco calculations.

PPO2 **Flashes Red** when less than 0.40 or greater than 1.6. These limits can be adjusted in the Adv. Config 2 menu.

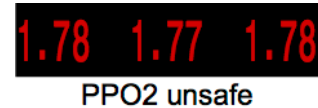

When a sensor is voted out, it displays in **Yellow**. Voting is performed to determine which sensors are most likely to be correct if the readings disagree. A sensor that is within 20% of either of the other sensors passes the voting and is included in the system average PPO2 (used to control O2 injection and calculate decompression).



When the O2 sensors require calibration, the PPO2 value will display as **FAIL**. Instructions can be found in the Calibration section.



**Voting Failed**

If no consensus can be found between the three O2 sensors, then voting has failed. This displays as PPO2 values alternating with "VOTING FAILED".

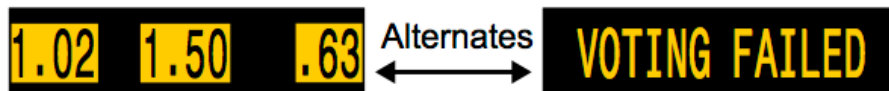

When voting fails, the solenoid will not inject O2 to maintain the PPO2 setpoint. If this occurs, follow the training guidelines from your rebreather manufacturer or training agency.

When voting fails the decompression calculations use the PPO2 from the lowest sensor (most conservative value), down to a minimum PPO2 of 0.16.

## The Bottom Row

The bottom row displays the current mode, gas and decompression information



### Circuit Mode

The current breathing configuration. One of:  
 OC = Open circuit (bailout so displays in **Yellow**)  
 CC = Closed circuit



### Current Gas (O2/He)

The current gas shown as a percentage of Oxygen and Helium.  
 The remainder of the gas is assumed to be Nitrogen.  
 In closed circuit mode, this gas is the diluent.  
 In open circuit mode this is the breathing gas.

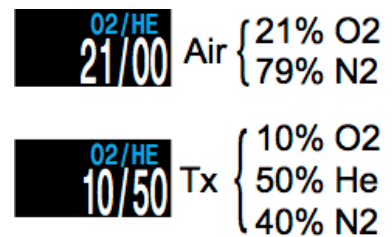

Displays in **Yellow** when there is better deco gas available than the current gas.

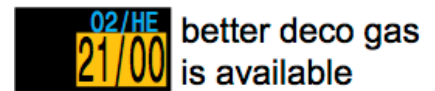

### No Decompression Limit (NDL)

The time remaining, in minutes, at the current depth until decompression stops will be necessary.  
 Displays in **Yellow** when the NDL is less than 5 minutes.



Once NDL reaches 0 (ie deco stops needed), the NDL display is just wasting space. To address this, a few different values can be set to replace the NDL (see Dive Setup → NDL Display)  
 The options are:



**CEIL:** The current ceiling in the current units (feet or meters) **Flashes Red** if you ascend shallower than the current ceiling.



**GF99:** The raw percentage of the Bühlmann allowable supersaturation at the current depth.



@+5: The predicted time-to-surface (TTS) if you were to stay at the current depth for 5 more minutes.

**Time-to-Surface (TTS)**

The time-to-surface in minutes This is the current time to ascend to the surface including the ascent plus all required deco stops.



Assumes:

- Ascent rate of 33 feet per minute (10 meters per minute).
- Decompression stops will be followed.
- Programmed gases will be used as appropriate.

The bottom row is also used to show additional information.

The Primary controller Handset is a full Trimix decompression computer, the [Shearwater DiveCAN Petrel2 Controller](#) with firmware designed for XCCR.

By using only the bottom row for this additional information, the critical information contained on the Top and Center Rows is always available during a dive.

The additional information that can be displayed on the bottom row includes:

**Info Screens:** Shows additional dive information  
Press SELECT (right button) to step through info screens

**Menus:** Allows changing settings  
Press MENU (left button) to enter menus

**Warnings:** Provide important alerts  
Press SELECT (right button) to clear a warning



A1.2 Info Screens ■ ■ ■

Info screens provide additional information that does not fit on the main screen.

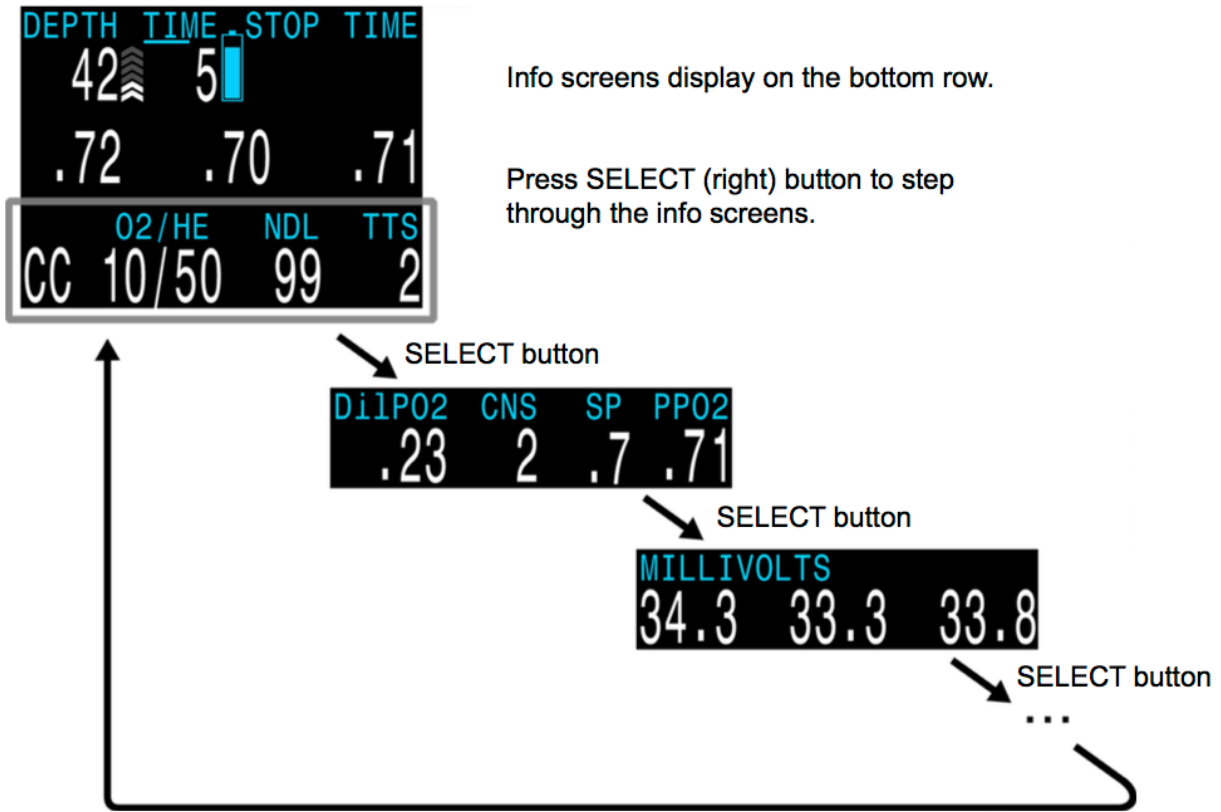

Info screens display on the bottom row.

Press SELECT (right) button to step through the info screens.

Starting from the main screen, the SELECT (right) button steps through the info screens .

**Compass** is displayed on the second info screen.

**High Pressure readings** from the on-board oxygen and diluent cylinders are displayed on the third info screen.

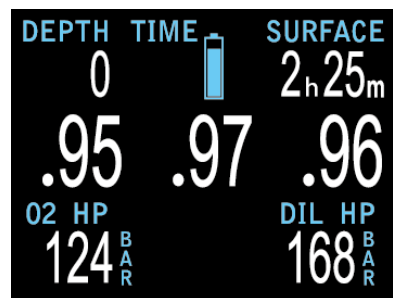

**Stack-Timer** and **ppCO2** are displayed on the fourth info screen.

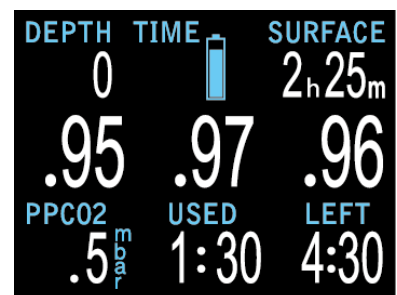

More info on Stack-Timer Setup see capture A1.8

More info on ppCO2 Setup see capture A1.9

When all info screens have been viewed, pressing SELECT again will return to the main screen.

Info screens time-out after 10 seconds, returning to the main screen. Pressing the MENU (left) button will also return to the main screen.

The info screen content is optimized for each mode. Set the Primary Controller Handset to the mode you will be using (e.g. OC) and step through the info screens to get familiar with the content.

### Diluent ppO<sub>2</sub>

The PPO<sub>2</sub> of the currently selected diluent Not measured directly, but calculated as the fraction of O<sub>2</sub> in the diluent multiplied by the current depth's pressure.

Displays in **Flashing Red** when the PPO<sub>2</sub> of the diluent is less than 0.19 or greater than 1.65.



When performing a manual diluent flush, you can check this value to see what the expected PPO<sub>2</sub> will be at the current depth. Also, can use to verify it is safe to flush with the diluent.

### CNS Toxicity Percentage

Central Nervous System oxygen toxicity loading percentage **Flashes Red** when 100 or greater.

The CNS percentage is calculated continuously, even when on the surface and turned off. When deco tissues are reset, the CNS will also be reset.





### Setpoint (SP)

The currently requested PPO<sub>2</sub> setpoint.

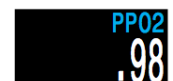

### Average PPO<sub>2</sub>

The purpose of this value is to show what PPO<sub>2</sub> is actually being used for setpoint maintenance and decompression calculations.



The Controller votes on the three measured PPO<sub>2</sub> values to decide what is the most likely true PPO<sub>2</sub>. This value shows the result of the voting.

When you have bailed out to OC, the center row continues to display the external measured PPO<sub>2</sub> Use this info display to see the OC PPO<sub>2</sub>.

In CC mode, displays in **Flashing Red** when less than 0.40 or greater than 1.6.



In OC mode, displays in **Flashing Red** when less than 0.19 or greater than 1.65.

### Millivolts

The raw millivolt (mV) readings from the PPO2 sensors.



MILLIVOLTS  
42.0 46.0 43.0

### Average Depth

Displays the average depth of the current dive, updated once per second  
When not diving, shows the average depth of the last dive



AVG  
50 ft

### Average Depth in Atmospheres (AvgATM)

The average depth of the current dive, measured in absolute atmospheres (ie a value of 1.0 at sea level).

When not diving, shows the average depth of the last dive.



AvgATM  
2.52

### Maximum Depth

The maximum depth of the current dive.

When not diving, displays the maximum depth of the last dive.

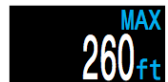

MAX  
260 ft

### Fraction Inspired O2 (FiO2)

The fraction of the breathing gas composed of O2.  
This value is independent of pressure.



FiO2  
.42

The next three values show decompression information, and are covered in more detail in the NDL Display section.

### CEIL

The current ceiling in the current units (feet or meters) **Flashes Red** if you ascend shallower than the current ceiling.



CEIL  
74

### GF99

The raw percentage of the Bühlmann allowable supersaturation at the current depth.



GF99  
80%

### @+5/TTS

The @+5 is the predicted time-to-surface (TTS) if you were to stay at the current depth for 5 more minutes.

Since this value is most useful when compared to the current TTS,

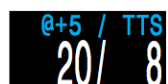

@+5 / TTS  
20 / 8



the current TTS is displayed beside the @+5 value.

### Tissues Bar Graph

The tissues bar graph shows the tissue compartment inert gas tissue tensions based on the Bühlmann ZHL-16C model. Note that VPM-B also tracks tensions in the same way.

The fastest tissue compartment is shown on the top, and the slowest on the bottom. Each bar is the combined sum of the nitrogen and helium inert gas tensions. Pressure increases to the right.

The vertical black line shows the inert gas inspired pressure. The boundary between the green and yellow zones is the ambient pressure. The boundary between the yellow and red zone is the ZHL-16C M-Value pressure.

Note that the scale for each tissue compartment above the green zone is different. The reason the bars are scaled in this way is so that the tissues tensions can be visualized in terms of risk (ie how close they are as a percentage to Bühlmann's original super-saturation limits). Also, this scale changes with depth, since the M-Value line also changes with depth.

#### Some Sample Tissues Graphs

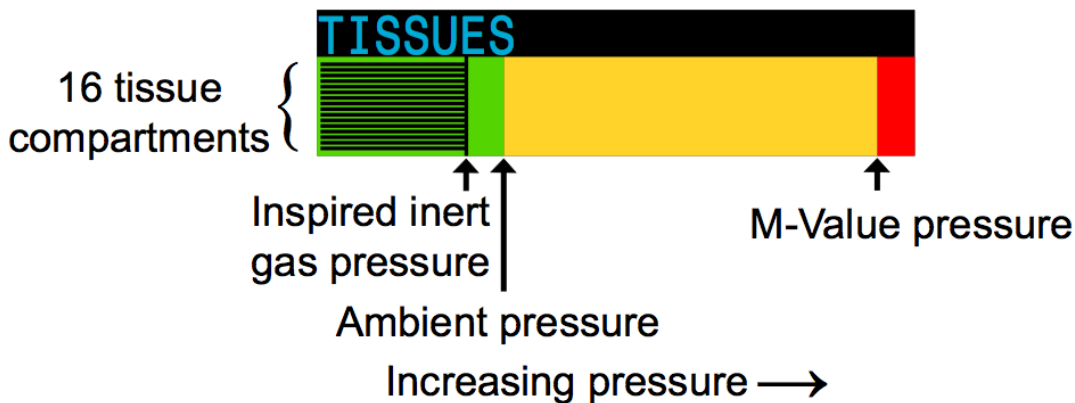
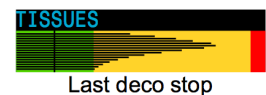
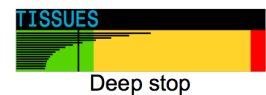
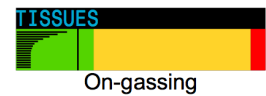
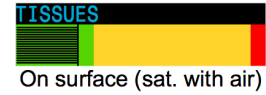

### Battery

Ambient pressure Increasing pressure

The Primary Controller's internal battery voltage Displays in **Yellow** when the battery is low and needs replacement.

Displays in **Flashing Red** when the battery is critically low and must be replaced as soon as possible. Also shows battery type.

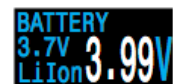

### External Battery (EXT V)

The voltage of the external battery used to fire the solenoid.

**Flashing Red** when the battery is critically low

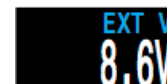

Solenoid hasn't fired yet

and must be replaced as soon as possible.  
 Only sampled when solenoid is fired, so if solenoid has not yet fired, value is unknown and displays as a Yellow "?".

### Gradient Factor

The deco conservatism value when the deco model is set to GF The low and high gradient factors control the conservatism of the Bühlmann GF algorithm.  
 See "Clearing up the Confusion About Deep Stops" by Erik Baker.



### VPM-B (and VPM-BG)

The deco conservatism value when the deco model is set to VPM-B. For VPM-B, higher values are more conservative.  
 If the deco model is VPM-B/GFS, also displays the gradient factor for surfacing. For the gradient factor, higher values are less conservative.

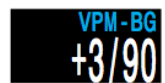

### Pressure

The pressure in millibars Two values are shown, the surface (surf) pressure and the current (now) pressure.  
 The current pressure is only shown on the surface.  
 The surface pressure is set when the Primary Controller Handset is turned on.  
 If the Altitude setting is set to SeaLvl, then surface pressure is always 1013 millibars.

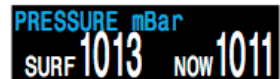

### Temperature

The current temperature in degrees Fahrenheit (when depth in feet) or degrees Celsius (when depth in meters).

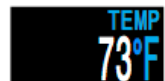

### Date and Time

In the format dd-mon-yy  
 12 or 24 hour clock time

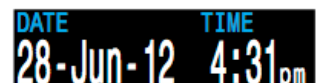
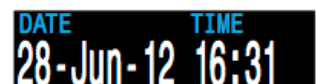

### Serial Number & Version

Each Primary Controller Handset has a unique serial number  
 The version number indicates the available features.  
 The last two numbers are the firmware version (V12 in this image).



### Compass

The Primary Controller Handset contains a tilt-compensated digital compass

**Compass features:**

- 1° resolution
- ± 5° accuracy
- Smooth, high-speed refresh rate
- User set heading marker with reciprocal
- True North (declination) adjustment
- Tilt compensation ±45°

**Viewing the Compass**

When enabled, the compass is viewed by pressing the SELECT (right) button once.

Press SELECT again to continue on to view the regular info screens.

Unlike the regular info screens, the compass never times out back to the main screen.

Press MENU (left) button to return to the main screen.

**Compass Limitations**

It is important to understand some compass limitations before use.

**Calibration** - The digital compass needs occasional calibration. This can be done in the System Setup → Compass menu and takes only one minute.

**Battery Changes** - When the battery is changed, the compass should be calibrated. This is because each battery has its own magnetic signature that interacts with the compass. Fortunately this effect can be removed with proper calibration.

**Interference** - Since a compass operates by reading the Earth's magnetic field, the compass heading is affected by anything that distorts that field or creates its own.

\*Ferromagnetic materials (such as iron, steel, or nickel) should be kept away from the Primary controller when using the compass.

\*A traditional compass should also not be placed too close, as it contains a permanent magnet

\*Electric motors and high current cabling (such as from dive lights) can also cause interference and should be kept at a distance

\*Being inside or near a shipwreck may also affect the compass heading

**Marking a Heading**

To mark a heading, press MENU (left) button until "Mark Compass" is displayed, then press SELECT (right) button to mark the current direction. The display will then jump back to the compass display.

The heading is shown as a pair of green triangles.



Only one heading can be marked at a time, it can however be changed. Once a heading has been marked, there is no way to clear the heading arrows from the display.

When the marked heading is off screen, an arrow points the shortest way back.

When facing the opposite direction, the reciprocal heading is shown as a pair of red triangles.

## A1.3 MENU

Menus perform actions and allow settings to be changed

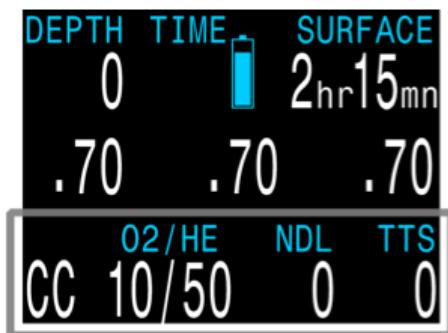

Press MENU (left) button to step through the menus.

Press SELECT (right) button to execute command or enter sub-menu.

Menus display on the bottom row.

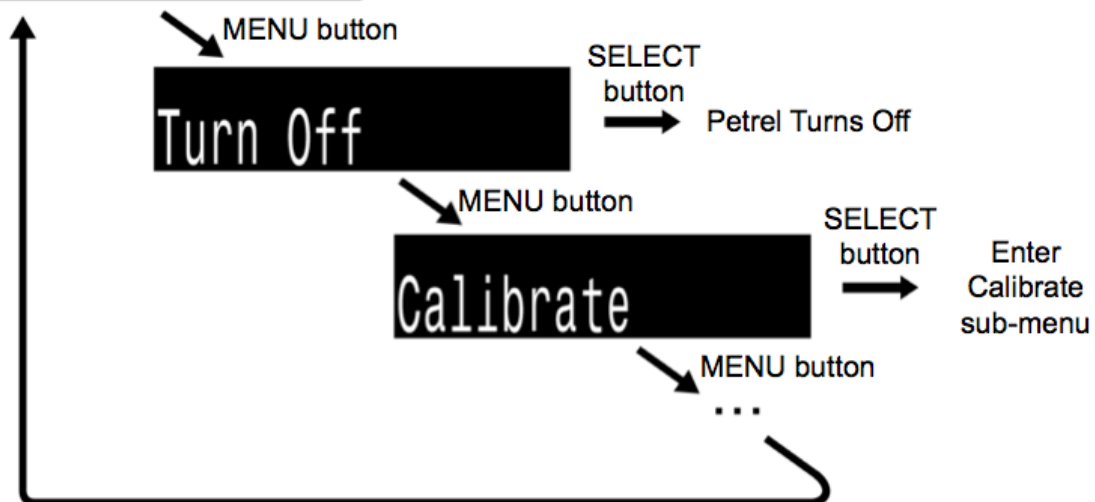

Starting from the main screen, pressing the MENU (left) button steps through the menus. When all menus have been viewed, pressing MENU again will return to the main screen

Pressing the SELECT (right) button when a menu is displayed, either performs an action or enters a sub-menu.

If no buttons are pushed for 1 minute, the menu system will time-out, returning to the main screen. Anything that had been previously saved will be retained. Anything that was in the middle of editing will be discarded.

### Adaptive Menus

Only menus necessary for the current mode are shown. This keeps operation simple, prevents mistakes, and reduces button presses.

### Menu Structure

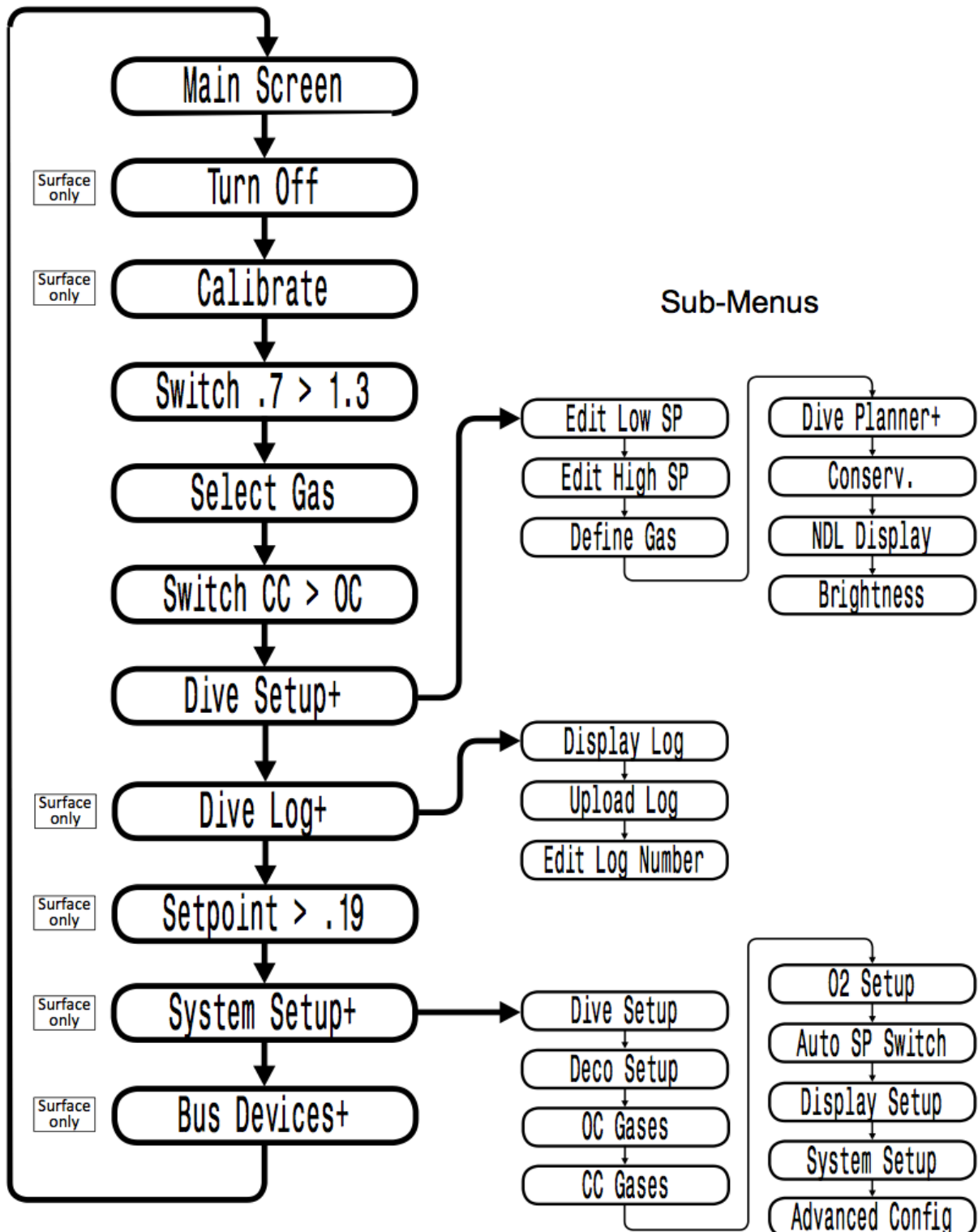

### Basic Setup



Before using the computer there are several things that need to be configured. This is not an exhaustive list of the pre-requisites for diving the system, but a suggestion of key tasks.

- **Calibrate the oxygen sensors if needed.** If calibration is not needed, then we recommend verifying the PPO2 at multiple points. For example, in air, flushed with oxygen, and ideally also a PPO2 greater than 1.0.
- In the System Setup menu **set the units** to metric or imperial, also set the date and time
- **Enter the gases** This includes the diluents (CC gases) and bailout gases (OC gases)
- The system will use the gases that are available in the order of oxygen content during the Time To Surface (TTS) prediction The system will use the next available gas that has a PPO2 of less than 1.0 for closed circuit diving
- If the computer is in open circuit or is switched to open circuit during a dive, the system will calculate the TTS based on the configured open circuit gases that are available. It will use the next available gas that has a PPO2 of less than 1.6 for open circuit diving.

**NOTE:** These gases are used automatically only for TTS predictions. The gas used to calculate the current tissue load and the current ceiling is always the gas actually selected by the diver.

## Decompression and Gradient Factors

The basic decompression algorithm used for the Primary Controller is Bühlmann ZHL-16C modified by the use of Gradient Factors.

The controller implements Gradient Factors by using levels of conservatism, while the default of the system is 30/70.

The system provides several settings that are more aggressive than the default.



**Don't use the system until you understand how it works !**



More info on Decompression, Gradient factors and Conservatism should be available in XCCR Training manuals issued by training agencies.

### A1.4 MENU Reference

### A1.4.1 Turn Off

The “Turn Off” item puts the computer to sleep. While sleeping, the screen is blank, but the tissue contents are maintained for repetitive diving. The “Turn Off” menu item will not appear during a dive. It will also not appear after a dive until the End Dive Delay time has expired to allow for a continuation dive.

### A1.4.2 Calibration

The Calibrate menu will only appear when in CC mode and on the surface. This menu calibrates the mV output from the oxygen sensors to PPO2.

Upon selecting the calibration menu, the screen will show:

- Top row: Millivolt (mV) readings from the 3 O2 sensors
- Middle row: PPO2 values (using the previous calibration)
- Bottom row: The calibration gas fraction of O2 (FO2)

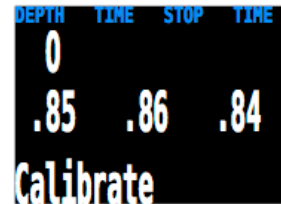

If you need to change the calibration gas FO2, do this in the System Setup → O2 Setup menu.

After flooding the breathing loop with the calibration gas (typically pure oxygen), press the SELECT button to perform the calibration.

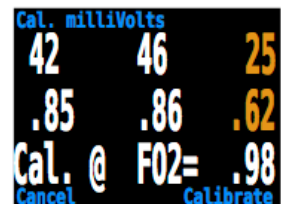

Good sensors should be in the range of 35 - 65 mV at sea level in 100% oxygen. A sensor will fail calibration if not in the range of 30mV to 70 mV. This allowable range scales automatically with changes to FO2 and barometric pressure. If outside the allowable range, a millivolt reading is shown in **yellow**.

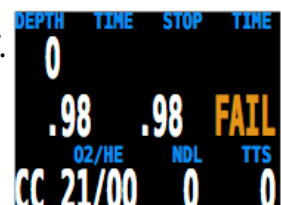

Once the calibration completes, a report will be shown. This shows which sensors passed calibration, and the value of the expected PPO2 based on barometric pressure and the FO2.

Back at the main screen, the displays should now all read the expected PPO2. For example, if FO2 is 098 and barometric pressure is 1013 mbar (1 ata), then PPO2 will be 0,98. If any display shows **FAIL**, the calibration has failed because the mV reading is out of range.

The “Calibrate” menu item will not display during a dive.

### A1.4.3 Calibration Problems

#### One sensor displays FAIL after calibration

This could indicate a bad sensor. It has failed because the mV output was not in range. The sensor could be old or damaged, and should be inspected. Damage and corrosion to wires or connectors is also a common problem. Fix the problem and recalibrate before diving  
DEPTH TIME STOP TIME.

### All sensors display FAIL after calibration

This could be caused by an accidentally unplugged cable or a damaged cable or connector. Also, accidentally performing the calibration in air or without a proper oxygen flush could cause this problem. A failed calibration can only be fixed by performing a successful calibration.

### PPO2 does not show 0.98 after calibration

If the Altitude setting in the Display Setup menu is set to Auto, then the PPO2 after calibration may not be exactly equal to the FO2.

This is because weather causes minor changes in barometric pressure. For example, say a low-pressure weather system has reduced the normal (1013mbar) barometric pressure to 990mbar. The PPO2 in absolute atmospheres is then  $0.98 * (990/1013) = 0.96$ .

The 0,96 PPO2 result is, in this case, correct. At high altitudes, the difference between FO2 and PPO2 will be even larger. To see the current pressure, start at the main screen and press the SELECT button a few times (displays as Pressure mBar NOW) .

If you are at sea level, and want the calibrated PPO2 to exactly match the FO2, then change the Altitude setting to SeaLvl. Only do this when actually at sea level, and also be aware that using this SeaLvl setting is actually introducing error into the PPO2 measurements.

## A1.4.4 Switch Setpoint

During a dive the "Switch Setpoint" menu item will be the first item displayed, since the "Turn Off" and "Calibrate" displays are disabled when diving.

Pressing SELECT when this menu is displayed changes the PPO2 setpoint from the low setpoint to the high setpoint or vice-versa. To redefine the PPO2 value of a setpoint, use the Dive Setup menu.

This menu item performs a manual switching of PPO2 setpoint. Automatic setpoint switching can be setup in the System Setup → Auto SP Switch menu. When auto setpoint switches are enabled, this menu item is still available to provide manual control

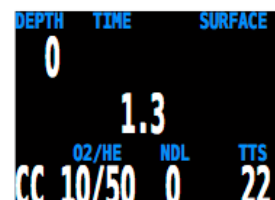
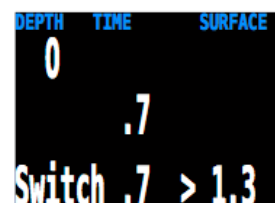

## A1.4.5 Select Gas

This menu item allows you to pick a gas from the gases you have created. The selected gas will be used either as the breathing gas in open circuit mode, or the diluent in closed circuit mode.

Gases are always sorted from most to least oxygen content.

Use the MENU button to increment to the desired diluent/gas, then press the SELECT button to select that diluent/gas.

If you increment past the number of gases available, the display will fall back out of the "Select Gas" display without changing the selected gas.

An 'A' will appear next to the currently active gas.

A gas that is off will be shown in **magenta**, but can still be selected. It will be turned on automatically if it is selected. Off gases are not used in decompression calculations.

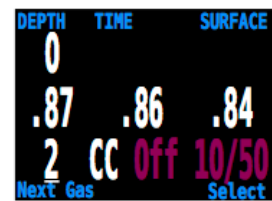
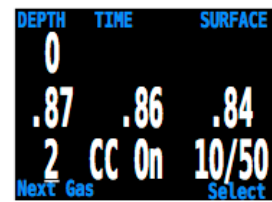
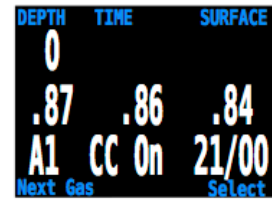
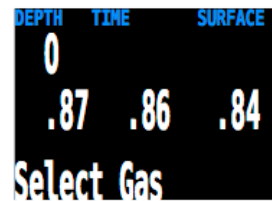

### A1.4.6 Switch to OC/CC

Depending on the current computer setting, this selection will show as either "Switch CC > OC" or "Switch OC > CC".

Pressing SELECT will select the displayed mode for decompression calculations. When switching to open circuit while diving, the most appropriate open circuit gas will become the breathing gas for calculations.

At this point, the diver may want to switch to a different gas, but since the diver may have other things to deal with, the computer will make a "best guess" of which gas the diver would choose.

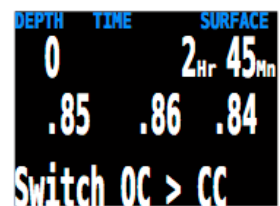

### A1.4.7 Dive Setup+

The Dive Setup menus are available both on the surface and when diving. The values in Dive Setup+ can also be accessed in the Systems Setup+ menu, but the System Setup+ menu is not available when diving.

Pressing SELECT will enter the Dive Setup sub-menu.



### A1.4.8 Edit Low Setpoint

This item allows you to set the low setpoint value. It will display the currently selected value. Values from 0,5 to 1,5 are allowed. A press of MENU will increment the setpoint.

Press the SELECT button when "Edit Low SP" is displayed and the edit display will be shown.

It is set at the lowest valid value for setpoint, 0,5.

Another press of MENU will increment it again.

If SELECT is pushed, the currently displayed setpoint will be selected, and the display will return to the "Edit Low SP" menu item.

If the highest allowable value 1.5, has been passed, the value will return to 0.5.

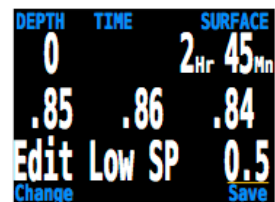
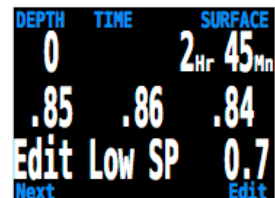

### A1.4.9 Edit High Setpoint

The high setpoint function works exactly like the low setpoint function.

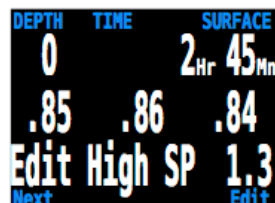

### A1.4.10 Define Gas

The function allows you to set up 5 gases in Closed Circuit and 5 gases in Open Circuit.

You must be in Open Circuit to edit open circuit gases, and you must be in Closed Circuit to edit closed circuit diluents. For each gas, you can select the percentage of oxygen and helium in the gas. The remainder is assumed to be nitrogen.

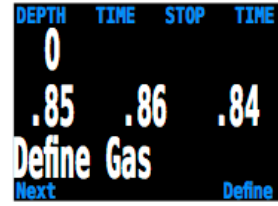

Pushing SELECT when "Define Gas" is displayed presents the function to define gas number 1.

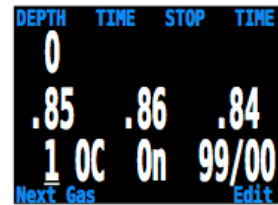

Pushing the MENU button will display the next gas.

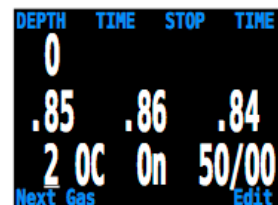

Pushing SELECT will allow you to edit the current gas. The gas contents are edited one digit at a time. The underline will show you the digit being edited.

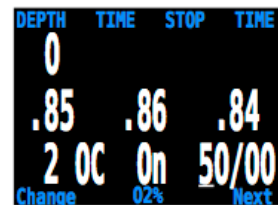

Each push of the MENU button will increment the digit being edited. When the digit reaches 9, it will roll over to 0.

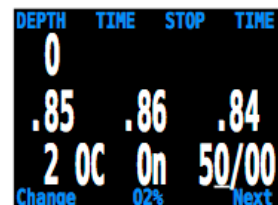

Pushing SELECT will lock in the current digit, and move on to the next digit.

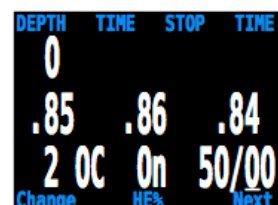

Pushing SELECT on the last digit will finish editing that gas, and bring you back to the gas number. Any gases that have both oxygen and helium set to 00 will not be displayed in the "Select Gas" function.

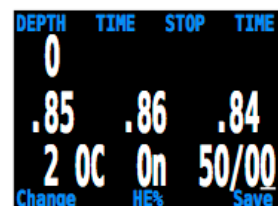

Pushing MENU will continue to increment the gas number.



**Note:** The “A” denotes the active gas. You cannot delete the active gas. If you try, it will generate an error. You can edit it, but cannot set both the O2 and HE to 00.

The computer will display all 5 gas entries available to allow you to enter new gases.

Pressing MENU one more time when the fifth gas is displayed will return you to the “Define Gas” menu item.

DEPTH	TIME	STOP	TIME
0			
.85	.86	.84	
2 OC	On	50/00	
Change	HE%	Save	

DEPTH	TIME	STOP	TIME
0			
.85	.86	.84	
A3 OC	On	14/55	
Next Gas		Edit	

DEPTH	TIME	STOP	TIME
0			
.85	.86	.84	
5 OC	On	00/00	
Done		Edit	



**Only turn-on gases you are carrying.**

**Only turn on the gases you are actually carrying on the dive. The computer has a full picture of the OC and CC gases you are carrying and can make informed predictions about decompression times.**

**There is no need to turn gases off and on when you switch from CC to OC, because the computer already knows what the gas sets are. You should have the CC and OC gases you are actually carrying turned on.**

If you often use other gases, but not on this dive, you can enter the gas and turn it off. You can turn gases on and off during a dive and you can also add or remove a gas during the dive if needed.

### A1.4.11 Brightness

The display brightness has three fixed brightness settings plus an Auto mode.

The fixed options are:

- **Low:** Longest battery life
- **Med:** Best mix of battery life and readability
- **High:** Easiest readability, especially in bright sunlight.

The “Auto” option will use the light sensor measures ambient light levels and then adjusts the screen brightness to best performance. The more ambient light there is, the brighter the display will get. At depth, or in dark water, very little brightness is needed to see the display.

The Auto setting works well in most situations. It provides maximum brightness in bright sunlight, but then lowers brightness to save battery life when the environment gets darker.

The brightness of the display is the major determinant of battery life. Up to 80% of the power consumption is to power the display. When a low battery alert occurs, the display brightness is automatically reduced to extend battery life.

### A1.4.12 Setpoint -> 1.9

Pressing SELECT when this menu is displayed changes the PPO2 setpoint to 0,19. This menu is only available when on the surface.

This feature is provided as a convenience to prevent the solenoid from firing when setting up the rebreather on your workbench. There is very little room for error with a 0,19 setpoint, so it should never be used when breathing on the loop.

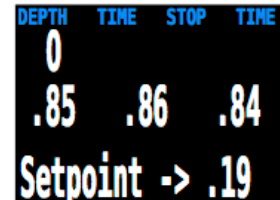

If a dive begins on the 0,19 setpoint, the setpoint is automatically switched up to the low setpoint.



#### **NEVER breath on the loop when setpoint is 0,19 !**

There is very little room for error with a 019 PPO2 setpoint. A small drop in PPO2 could lead to hypoxia, which can be just as deadly on the surface as underwater. The 0,19 setpoint is only for use during setup and transportation.

### A1.4.13 Dive Log Menu

#### Display Log

At the "Display Log" prompt, press SELECT to view the most recent dive. The profile of the dive is plotted in blue, with decompression stops plotted in red.

The following information is displayed:

- Maximum and Average depth
- Dive number
- Date (mm/dd/yy)
- Start- Start of dive
- End- End of dive
- Length of dive in minutes.

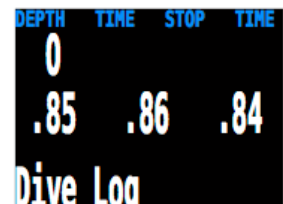

Press MENU to see the next dive, or SELECT to quit viewing logs.

Press Back to see the list of dive logs, and next to select the next dive and View.

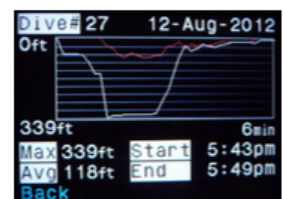

#### Upload Log

See "Firmware Upload and Dive Log Download" instructions.

Logs are uploaded using Bluetooth. Selecting this menu item starts the Bluetooth connection and then waits for commands from a desktop or laptop computer.

### Edit Log Number

The dive log number can be edited. This is useful if you want the Primary Controller Handset log numbers to match your lifetime dive count.

At the "Edit Log Number" prompt, press SELECT to begin editing. While editing, use MENU to change the value of the currently underlined digit, and SELECT to move to the next digit.

The next dive number will be +1 from the value entered here. For example, if you enter 0015, then the next dive will be dive number 16.

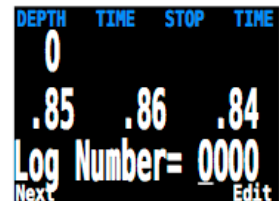
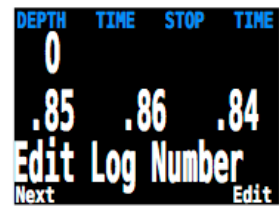

## A1.4.14 System Setup+

System Setup contains configuration settings together in a convenient format for updating the configuration before a dive. System setup cannot be accessed during a dive.

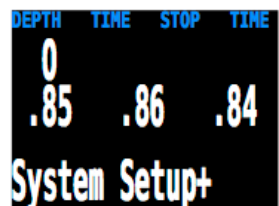

### Dive Setup

The first submenu of System Setup+ is Dive Setup.

#### Salinity

Water type (salinity) affects how the measured pressure is converted to depth.

Settings:

- Fresh
- EN13319
- Salt

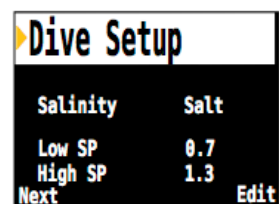

Fresh and Salt water differ by about 3%. Salt water, being denser, will display a shallower depth for the same measured pressure versus the Fresh water setting. The EN13319 value is between Fresh and Salt. It is from the European CE standard for dive computers, and is the Primary Controller's default value.

### Low and High Setpoints

Each setpoint can be set from 0,5 to 1,5.

The setpoints can also be edited, even during a dive, in the Dive Setup menu.

## O2 Setup

This menu allows changing settings related to the O2 Sensor calibration and display.

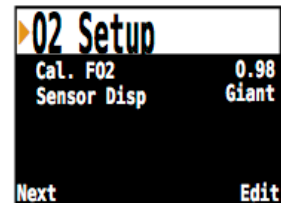

### Cal. FO2

This setting allows you to set the fraction of oxygen (FO2) of the calibration gas.

The calibration gas FO2 can be set from 0,70 to 1,00. The default value of 098 is for pure oxygen, but assumes about 2% water vapor due to the diver's breathing on the loop during the flushing process.



This setting value is the fraction of oxygen, not the partial pressure of oxygen. When the calibration is performed, the Primary Controller measures the ambient barometric pressure to determine the PPO2. If you are at sea-level, and do not want small variations in barometric pressure changing the calibrated PPO2 result, there is an option to set the Altitude to a SeaLvl .

### Auto SP (Setpoint) Switch

Auto Setpoint Switch configuration sets up the setpoint switching. It can be set up to auto switch up only, down only, both, or neither.

First, you set the whether the "Up" switch occurs automatically or manually. If "Up" is set to "Auto", then you can set the depth at which the auto switch occurs.

The menu options are the same for the down setpoint switch.

Example: Up: 0.7>1.3 = Auto, Up Depth = 21m  
Down: 1.3>0.7 = Auto, Down Depth = 12m

The dives starts at the 0.7 setpoint. As you descend past 21m, the setpoint switches "up" to 1.3.

You finish your bottom time, then begin ascending.

When you ascend above 12m, it switches "down" to 0.7.

When a switch is set to "Auto", you can always manually override the setting at any time during the dive.

Each auto setpoint switch can occur only once per dive.

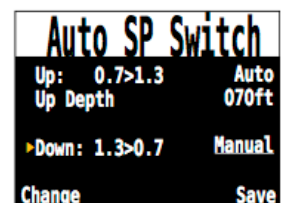
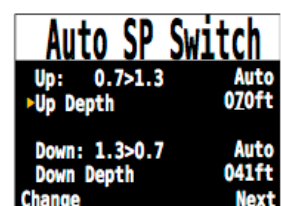
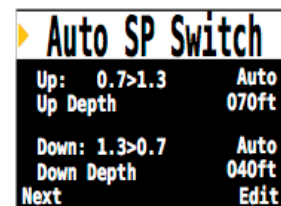

Either switch can be set to auto or manual independent of the other switch.

The values 0,7 and 1,3 are shown as examples only. Other values for the low and high setpoint can be adjusted in the Dive Setup menu.

## A1.5 Display Setup

### Units

Two options are available:

- Meters: Metric units (depth in meters, temperature in °C)
- Feet: Imperial units (depth in feet, temperature in °F)

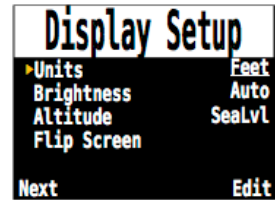

### Brightness

Screen brightness can be set to fixed levels or an automatic setting.

Fixed options:

- Low: Longest battery life
- Med: Best mix of battery life and readability
- High: Easiest readability, especially in bright sunlight

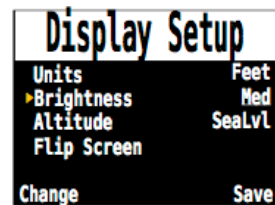

The "Auto" option measures ambient light levels and then adjusts the screen brightness to best performance. It provides maximum brightness in bright sunlight, but then lowers brightness to save battery life when the environment gets darker.

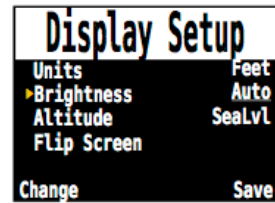

### Altitude

The altitude setting when set to 'Auto' will compensate for pressure changes when diving at altitude. If all your diving is at sea level, then setting this to 'SeaLvl' will assume that surface pressure is always 1013 mBar (1 atmosphere).

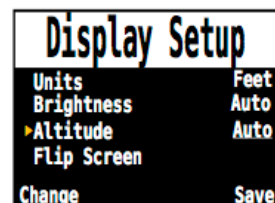

#### Diving at Altitude.

When diving at altitude you must set this option to 'Auto' (the default setting is 'SeaLvl')

Further, when diving at altitude, you must turn the computer on at the surface. If the auto-on safety feature is allowed to turn the computer on after a dive has started then the computer assumes the surface pressure is 1013 mBar. If at altitude this could result in incorrect decompression calculations.

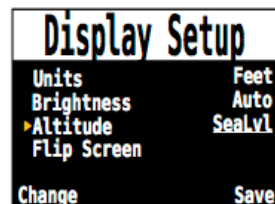

### Flip Screen

This function displays the contents of the screen upside down, allowing

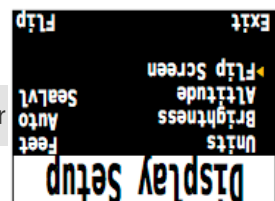

## A1.6 Compass Setup

### Compass View

The Compass View setting can be set to:

- **Off:** The compass is disabled and the Mark Compass option is removed from the menus
- **60°, 90°, or 120°:** Sets the range of the compass dial that is visible on the main screen. The actual amount of arc that is shown on the screen is 60°, so this may seem the most natural. The 90° or 120° setting can be used to see a wider range.

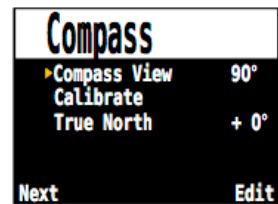

### True North

In most places, a compass does not point towards True North, but rather to Magnetic North. The difference in angle between these two directions is called the magnetic declination (also called magnetic variation), and varies around the world. The declination in your location can be found on maps or by searching online.

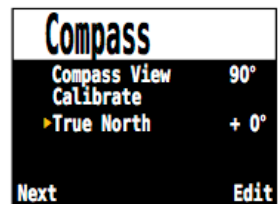

This setting can be set from -99° to +99°.

If you only need to match an uncompensated compass, or your navigation is all based on relative directions, then this setting is not necessary and can be left at 0°.

### Calibrate Compass

Calibration of the compass may be needed if the accuracy drifts over time or if a permanent magnet or ferromagnetic metal (e.g. iron or nickel) object is mounted very close to the Primary Controller Handset. To be calibrated out, such an object must be mounted with the Primary Controller Handset so that it moves along with the handset.

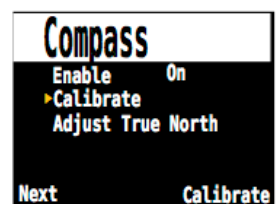

**Battery Affects the Compass Calibration.**

Each battery has its own magnetic signature, mostly due to its steel case. Therefore, recalibrating the compass when changing the battery is recommended.

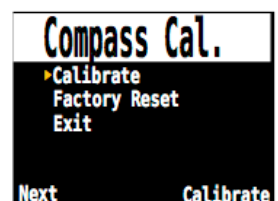

Compare the Primary Controller Handset with a known good compass or fixed references to determine if calibration is needed. If comparing against fixed references, remember to consider the local deviation between Magnetic North and True North (declination).

Calibration is typically not needed when traveling to different locations. The adjustment needed then is the True North (declination).

When calibrating, rotate the Primary Controller Handset smoothly through as many 3D twists and turns as possible in 15 seconds. Keep metal and magnetic objects away during calibration. The calibration can also be reset back to the factory values. After calibration, it is recommended to compare the compass accuracy with a known good compass or fixed references.

## A1.7 System Setup ■ ■ ■

### Date

The first 'System Setup' changeable option is 'Date,' which allows the user to set the current date.

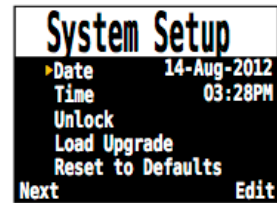

### Time

The next 'System Setup' changeable option is 'Time,' which allows the user to set the current time. The format can be set to AM, PM or 24 hour time.

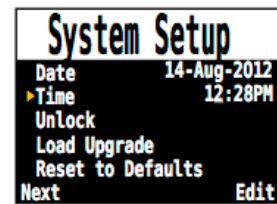

### Unlock Code

The next 'System Setup' changeable option is 'Unlock,' which allows the user to enter in an unlock in order to change models and to set other features.

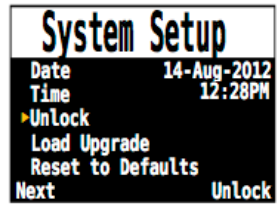

### Load Upgrade

Use this option to load firmware upgrades. This starts a Bluetooth connection and then waits for commands from a laptop or desktop computer.

See the section 'Firmware Upload and Dive Log Download' for detailed instructions.

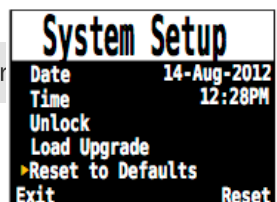
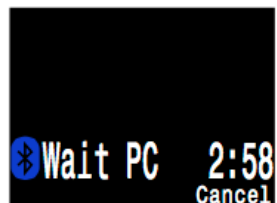
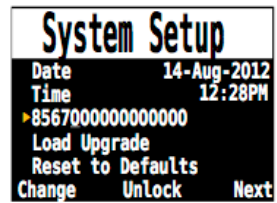



## Reset to Defaults

The final 'System Setup' option is 'Reset to Defaults'. This will reset all user changed options to factory settings and clear the tissues on the Primary Controller Handset. 'Reset to Defaults' cannot be reversed.

Note: This will not delete dive logs, or reset dive log numbers.

## A1.8 Stack-Timer Setup

The Stack-Timer is a countdown timer of current usage of Soda Lime in the scrubber. The Stack-Timer can be reset by the user.

### Viewing the Stack Timer

The Stack-Timer can be reset by the user. Time is shown in hours and minutes (H:mm). In these examples, the total Stack Time is set to 6:00. The Stack Timer is viewed by pressing the right button a few times from the main screen.

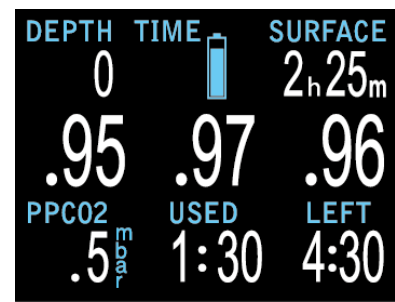

### Setting up the Stack Timer

Setup is done in the Adv. Config 3 menu. Settings:

- Stack Timer (On or Off)
- Total Time (range 1:00 to 6:00)
- Count When (Diving or On)

"Warn at" and "Alarm at" are not adjustable. Fixed at 1:00 (Warn) and 0:30 (Alarm).

Changing the "Total Time" setting resets the stack timer to the newly set value. The Stack Timer is not reset if turned on or off.

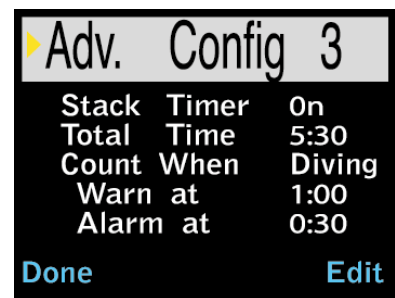

### Resetting the Stack Timer

When Stack Timer is enabled, a "Reset Stack Time" menu option appears at the top-level.

Pressing right button brings up the confirm screen (next image).

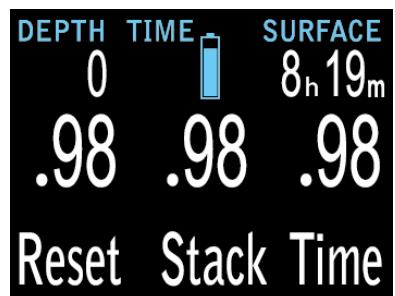

The Reset Confirmation screen shows the reset value and current remaining stack time.

The Reset option is only available on the surface.

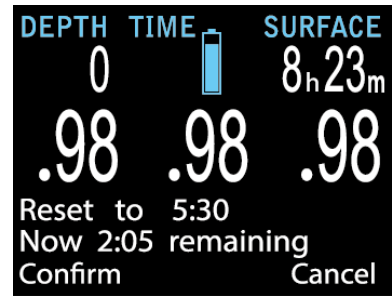

### Warning level

When the remaining Stack Time falls below the “Warn at” level, a warning is generated.

Once user confirms this warning with the right button and then the warning is gone.

If the user confirms this on the surface, and then starts a dive, this error will be regenerated once the dive starts.

The remaining time displays in Inverted Yellow when in the warning state.

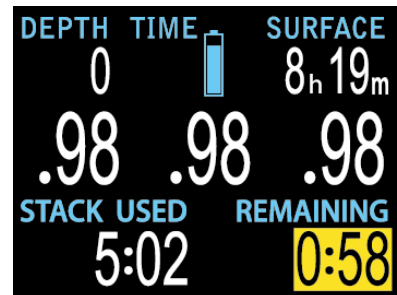
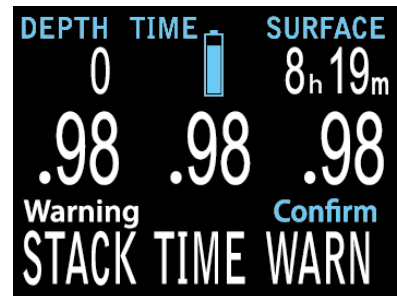

### Alarm level

When the remaining Stack Time falls below the “Alarm at” level, a warning is generated.

Once user confirms this warning with the right button and then the warning is gone. However, a permanent “Stack Time” red error is displayed until the stack timer is reset.

The remaining time displays in Flashing Red when in the alarm state.

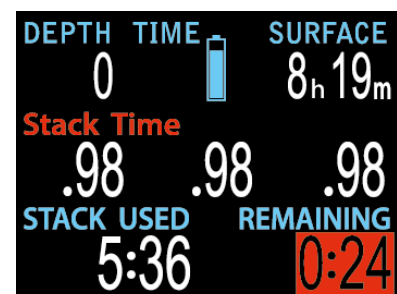
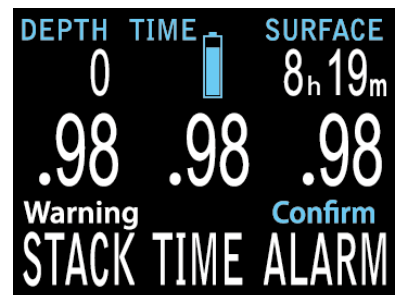

## A1.9 CO2 Monitoring Setup

The CO2 monitoring displays current ppCO2 (in mbar) in the breathing loop right behind the scrubber.

The ppCO2 value is viewed by pressing the right button a few times from the main screen.

### Setting up the CO2 monitoring

Setup is done in the System Setup menu.

Scroll through the menu until you come to the CO2 Setup.

Settings:

CO2 Enable (On or Off)

CAL. CO2 ppm (CO<sub>2</sub> ppm of the used calibrating gas)

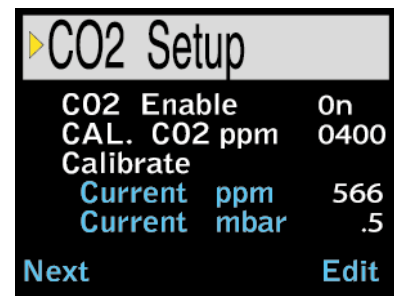

In CAL. CO2 ppm set the actual CO<sub>2</sub> ppm of the currently used calibrating gas according to which ppm was set.

Note:

**ppm** is the unit "parts per million",  
for air as the calibrating gas use 400 ppm (0,04% CO<sub>2</sub>).

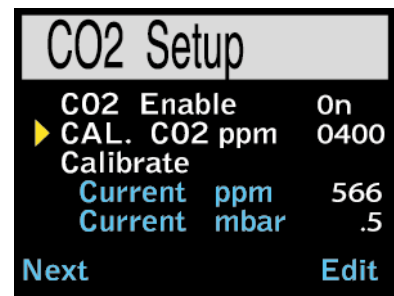

### Calibration of the CO2 monitoring

Select "Calibrate" and confirm with right button.

Keep sensor in a known CO<sub>2</sub> gas until reading is stable, then Confirm with right button.

"Waiting for calibration to complete" is shown on the screen until the calibration is executed.

Then the screen shows a CO2 Calibration Report:

SUCCESS - the calibration was executed successfully.

FAILED - the calibration was unsuccessful  
and must be repeated until successful.

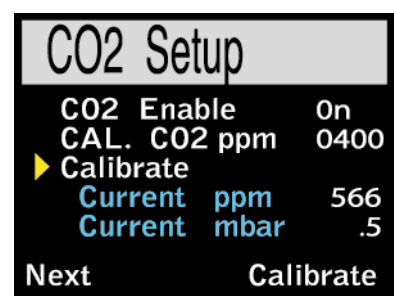

## A1.10 Firmware Upload and Dive Log Download

Bluetooth communications are used for both Firmware Uploading and Dive Log Downloading.

NOTE: Upgrading the firmware resets decompression tissue loading. Plan repetitive dives accordingly.

Start a Bluetooth connection by selecting the Upload Log menu.

The Primary Controller screen will switch from "Initializing" to "Wait PC" which will have a countdown.

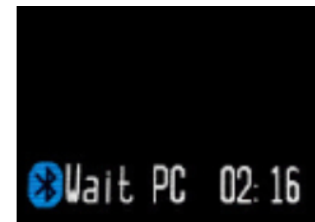
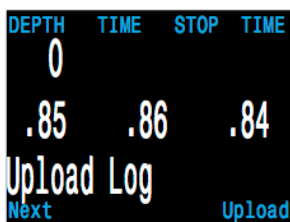

Now go back to the Shearwater Desktop. Click start from the open "Update Firmware Box", or "Download Log". The PC will then connect to the Controller, and send the new firmware.



The Controller screen will give percentile updates of receiving the firmware, then the Personal Computer will read "Firmware successfully sent to the computer".

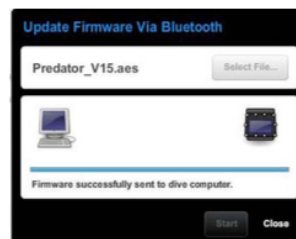

After receiving the new firmware, the Primary Controller will reset and display a message stating either firmware update success or failure.



**During the update process, the screen may flicker or go blank for a few seconds.**

**Do not remove the battery during the upgrade process.**



**A firmware update will clear the tissues. Therefore, be avoid updating the firmware in the middle of a dive trip.**

## A1.11 Changing the Battery ■ ■ ■

NOTE: A large coin or washer is required for this section.

### Turn off the Primary Controller Handset

It is a good practice to turn off the Primary Controller before removing the battery. If removed while on, then there is a small chance (about 1 in 5000) that the deco tissues will be corrupted. The Primary Controller detects this using a cyclic redundancy check (CRC), so there is no danger. However, the tissues will be lost and repetitive dives will need to be planned accordingly.

### Remove the battery cap

Insert the coin or washer into the battery cap slot. Unscrew by turning counter clockwise until the battery cap is free. Be sure to store the battery cap in a clean dry space.

### Exchange the battery

Remove the existing battery by tilting the Primary Controller Handset. Insert the new battery positive contact first. A small diagram on the bottom of the Primary Controller shows the proper orientation.



### Accepted battery types

The Shearwater Primary Controller Handset can accept a wide variety of AA sized batteries. The Primary Controller Handset can accept any AA sized (or 14500 size) battery that outputs a voltage between 09V and 43V.

### Reinstalling the battery cap

It is very important that the battery cap O-ring is clear of dust or debris. Carefully inspect your O-ring for any debris or damage and gently clean. It is recommended that you lubricate your battery cap's O-ring on a regular basis with an O-ring lubricant compatible with Buna-N (Nitrile) O-rings. Lubricating helps ensure that the O-ring seats properly and does not twist or bunch.

Insert the battery cap into the Primary Controller Handset and compress the battery contact springs. While the springs are compressed rotate the battery cap clockwise to engage the threads. Be sure not to cross thread the battery cap's threads. Tighten the battery cap until snug. Do not over tighten the battery cap.

## Battery Types

After changing the battery, a screen will prompt for the battery type to be entered. The Primary Controller attempts to guess what type of battery is being used. If the battery type is incorrect, it should be manually edited. Having the battery type set correctly is important so that the Primary Controller can give low battery warnings at the proper voltage levels.

Supported battery types are:

**1.5V Alkaline:** The common AA battery type that can be purchased at most supermarkets and electronics stores around the world. Not rechargeable. Inexpensive and reliable, they provide 35 hours of operation.

**1.5V Photo Lithium:** Fairly common, but more expensive than alkalines. They provide about 55 hours of operation. Not rechargeable. Good for use in very cold water. Recommended.

**1.2V NiMH:** Common rechargeable batteries used in digital cameras and photo flashes. Can have high self discharge. Provide about 30 hours of operation per charge. Can die quickly, so care should be taken to ensure sufficient charge prior to diving.

**3.6V Saft:** The Saft LS14500 lithium batteries provide very high energy density. However, their high cost makes other battery types a better choice for most users. Provide about 100 hours of operation. Can die quickly, so care should be taken to ensure sufficient charge prior to diving.

**3.7V Li-Ion:** Rechargeable 14500 Li-Ion batteries provide about 35 hours of operation per charge. Can be ordered from the internet. Have more gradual voltage drop as discharged, so easier to determine remaining capacity than NiMH rechargeables. Good in cold water.



Battery operating lifetimes are given with screen on medium brightness and at room temperature. Higher brightness and lower temperature can reduce life. Lower brightness can increase life.

**Recommended Battery Type:** 1.5V AA Photo Lithium

Common brands include: Energizer Advanced and Ultimate Lithium AA.

The 1.5V Photo Lithium batteries have many characteristics that make them an excellent choice:

- Widely available
- Long operating life (55 hours on medium brightness)
- Excellent cold temperature performance
- Able to provide higher output current than Saft lithium

## A1.12 Tissues Cleared



Some conditions will cause the decompression inert gas tissue loadings to be cleared. When cleared, the tissues are set to being saturated with breathing air at the current barometric pressure.

The Primary Controller does not lock-out when the tissues are cleared. If the tissues are cleared, then the diver must take appropriate cautions when planning repetitive dives. The Primary Controller clearly notifies when tissues are cleared, so that the diver has the proper information to make responsible decisions.

After changing the battery, you will see one of the two screens below. The first indicates that the tissues have been cleared, so caution is needed if repetitive dives are planned. The second indicates that the tissues have been fully restored.

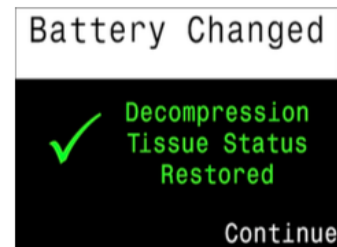
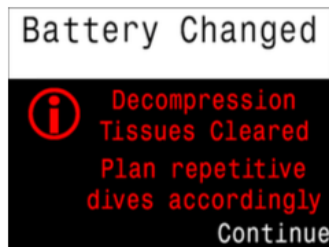

Conditions that cause the tissues to be cleared are:

**Firmware Updates:** A firmware update will clear the tissues. Therefore, updating the firmware in the middle of a dive trip is not a good idea.

**User Request:** You can clear the tissues manually in the System Setup → System Setup menu. Use the Reset To Defaults option. This will then prompt if you want to reset the settings only, the tissues only, or both.

**Slow Battery Change:** Quick battery changes do not normally cause the tissues to be cleared. A super capacitor stores energy to keep the clock running for at least 15 minutes during a battery change. If the battery is removed for longer than 15 minutes, then the tissues will be cleared.

**Corruption:** A 32-bit cyclic redundancy check (CRC) is used to verify the integrity of the tissues each time the Primary Controller is turned on. If corrupted, the tissues will be cleared. The most likely cause of corruption is removing the battery with the Primary Controller turned on. Therefore, turning the Primary Controller Handset off before changing the battery is the best practice.



## A1.13 Error Displays



The system has several displays that alert an error condition.

### Limitations of Alarms

All alarm systems share common weaknesses.

They can alarm when no error condition exists (false positive). Or they can fail to alarm when a real error condition occurs (false negative).

So by all means respond to these alarms if you see them, but NEVER depend on them. Your judgement, education, and experience are your best defenses. Have a plan for failures, build experience slowly, and dive within your experience.

Each of the alarms will display the message in **yellow** until dismissed. The error is dismissed by pressing SELECT.



This message will appear if the average PPO2 goes **above 1.6** for more than 30 seconds.



This message will appear if the average PPO2 goes **below 0.4** (1.9 for OC) for more than 30 seconds.

It is not unusual to get this error immediately after submerging with a manual CCR and a hypoxic mix. The first breath after submerging floods the loop with low PPO2 gas.

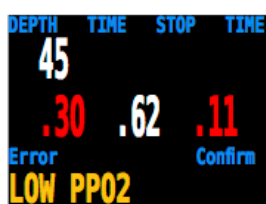

The situation is usually resolved by increasing depth such that when the error is noticed, the PPO2 is no longer low.

This condition will also cause the "**LOW PPO2**" display to appear.

Here, the computer does not have two sensors that have confirming values. There is no way to know the actual PPO2, and the average PPO2 will be calculated as 0.11 (the lowest value is the most conservative for decompression calculations).

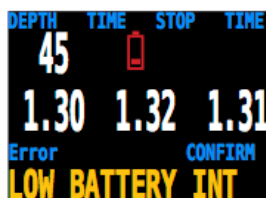

This message will appear when your internal battery is low for 30 seconds. The battery needs to be changed. The computer will also flash the battery symbol **RED**.



This alarm is a notification that there has either been a very fast ascent for a short period of time, or that there has been an ascent of more than 66 fpm / 20 mpm maintained for over a minute. This alarm may return after being dismissed if the condition occurs again.



This alarm occurs when the diver has been above the minimum depth for a decompression stop for more than one minute. This alarm will only appear once during a dive, but it will also appear once on the surface after the dive.

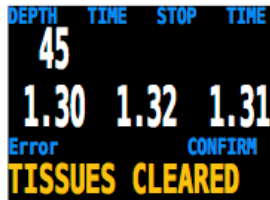

This alarm will show when the decompression tissues are cleared. All decompression information has been lost.



This alarm happens when the computer does not complete all of its tasks in the time allotted. It can happen occasionally from a transient problem like a battery bounce after an impact. It can also be the result of a hardware problem.

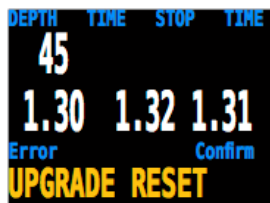

This reset shows up after a software update. This is the normal event that shows the computer has been rebooted after the software update.

This is not an exhaustive list.

Please contact Shearwater if you experience any unexpected errors.

The center row also shows permanent "Low PPO2" or "High PPO2" messages when the PPO2 is not in a safe range. These message will clear automatically once a safe PPO2 is restored.

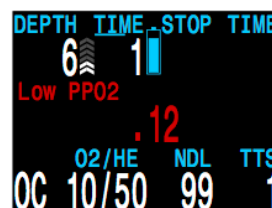

## A1.14 Storage and Maintenance



The Primary Controller Handset should be stored dry and clean.

Do not allow salt deposits to build up on your dive computer. Wash your computer with fresh water to remove salt and other contaminants. **Do not use detergents or other cleaning chemicals** as they may damage the Primary Controller Handset. Allow to dry naturally before storing.

Do not wash under high pressure jets of water as it may cause damage to the depth sensor.

Store Primary Controller Handset out of direct sunlight in a cool, dry and dust free environment. Avoid exposure to direct ultra-violet radiation and radiant heat.

Do not store batteries in Primary Controller Handset for long periods (several months). Batteries can and do leak, so don't risk your expensive computer on a simple task like removing batteries.



**Dead batteries are at a higher risk of leaking. Remove such a battery immediately.**

## A1.15 Servicing



There are no user serviceable parts inside the Primary Controller Handset.

Do not tighten or remove the faceplate screws.

Clean with water ONLY. Any solvents may damage the Primary Controller Handset.

Service of the Primary Controller Handset may only be done at Shearwater Research, or by any of our authorized service centers.

Your nearest service center can be found at [www.shearwaterresearch.com/contact](http://www.shearwaterresearch.com/contact)

## List of updates released in May 2019



### Page 35

In the event that communications between the Petrel controller and the X-head are lost for any reason or a short circuit on the cable connected to the Primary, the SOLO board in the head will continue working while revert to a **0.7** setpoint.