

**Features:**

- 1200V Schottky Diode
- Zero Reverse Recovery Current
- High Frequency Operation
- Positive Temperature Coefficient
- Temperature independent

Switching

**Benefits:**

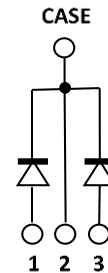
- Unipolar Rectifier
- Minimal switching loss
- Higher Efficiency
- Low cooling requirement

Symbol	Value	Unit
$V_{RRM}$	1200	V
$I_F$ ( $T_c = 156^\circ\text{C}$ )	10	A
$*Q_C$	26	nC

**Applications:**

- Switch Mode Power Supply
- Booster diodes in PFC, DC/DC
- AC/DC converters

**Outline**

**TO-247-3**
**Circuit**

**Maximum Ratings (\*Per leg)**

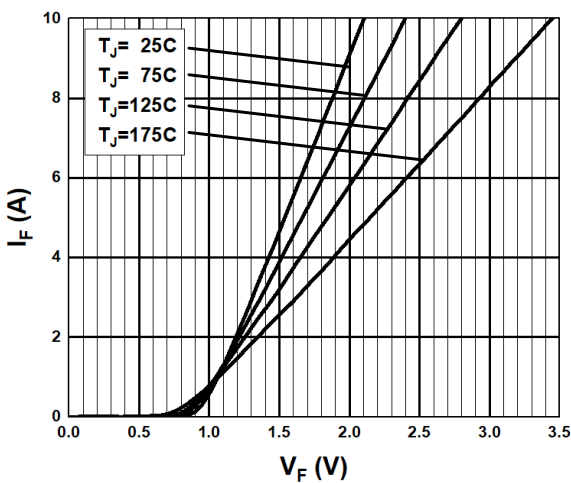
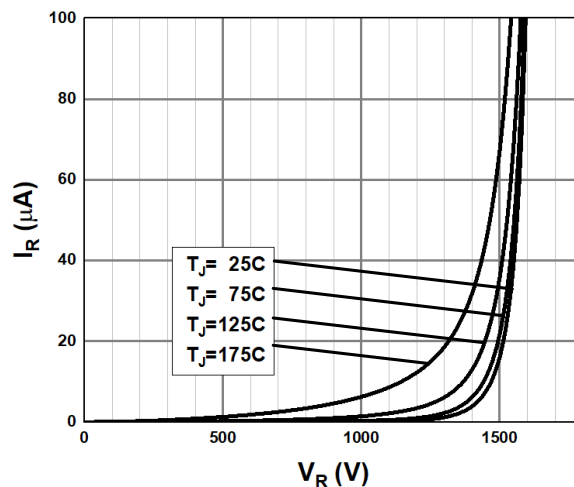
Symbol	Parameter	Value	Unit	Test Conditions
$V_R$	DC Peak Reverse Voltage	1200	V	$T_J = 25^\circ\text{C}$
$V_{RRM}$	Repetitive Peak Reverse	1200	V	$T_J = 25^\circ\text{C}$
$V_{RSM}$	Surge Peak Reverse Voltage	1300	V	$T_J = 25^\circ\text{C}$
$I_F$	Continuous Forward Current	*17/34 *7.5/15 *5/10	A	$T_C = 25^\circ\text{C}$ $T_C = 135^\circ\text{C}$ $T_C = 156^\circ\text{C}$
$I_{FRM}$	Repetitive Peak Forward Surge Current	*55 *44	A	$T_C = 25^\circ\text{C}$ , $T_p = 10\text{ms}$ , Half Sine Wave $T_c = 125^\circ\text{C}$ , $T_p = 10\text{ms}$ , Half Sine Wave
$I_{FSM}$	Non-Repetitive Peak Forward Surge Current	*65 *58	A	$T_C = 25^\circ\text{C}$ , $T_p = 10\text{ms}$ , Half Sine Wave $T_c = 125^\circ\text{C}$ , $T_p = 10\text{ms}$ , Half Sine Wave
$P_D$	Power Dissipation	*88 *29	W	$T_C = 25^\circ\text{C}$ $T_c = 125^\circ\text{C}$
$T_{J,max}$	Operating Junction Temperature	175	$^\circ\text{C}$	
$T_{stg}$	Storage Temperature Range	-55 to 175	$^\circ\text{C}$	

**Thermal characteristics (\*Per leg)**

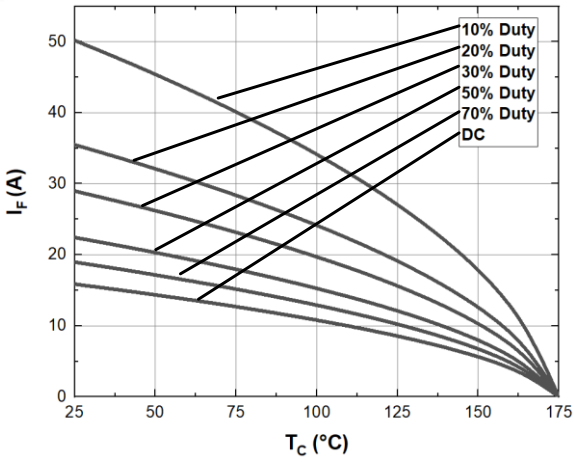
Symbol	Parameter	Min.	Typ.	Max.	Unit
$R_{thJC}$	Thermal resistance		*1.7/0.85		°C/W

**Electrical Characteristics (Per leg)**

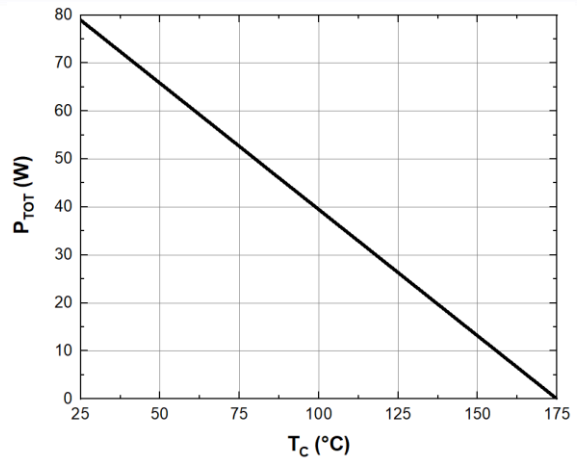
Symbol	Parameter	Value			Unit	Test Conditions
		Min.	Typ.	Max.		
$V_{DC}$	DC Blocking Voltage	1200			V	$I_R = 100\mu A, T_J = 25^\circ C$
$V_F$	Forward Voltage		1.55 2.4	1.9 2.7	V	$I_F = 10A, T_J = 25^\circ C$ $I_F = 10A, T_J = 175^\circ C$
$I_R$	Reverse Current		3 15	100 500	$\mu A$	$V_R = 1200V, T_J = 25^\circ C$ $V_R = 1200V, T_J = 175^\circ C$
$Q_C$	Total Capacitive Charge		26		nC	$I_F = 5A, dI/dt = 300A/\mu s$ $T_J = 25^\circ C, V_R = 800V$
$C$	Total Capacitance		259 24 20		pF	$V_R = 1V, T_J = 25^\circ C, f = 1\text{ MHz}$ $V_R = 400V, T_J = 25^\circ C, f = 1\text{ MHz}$ $V_R = 800V, T_J = 25^\circ C, f = 1\text{ MHz}$

**Typical Performance (Per leg)**

**Fig. 1 Forward Characteristics**

**Fig. 2 Reverse Characteristics**

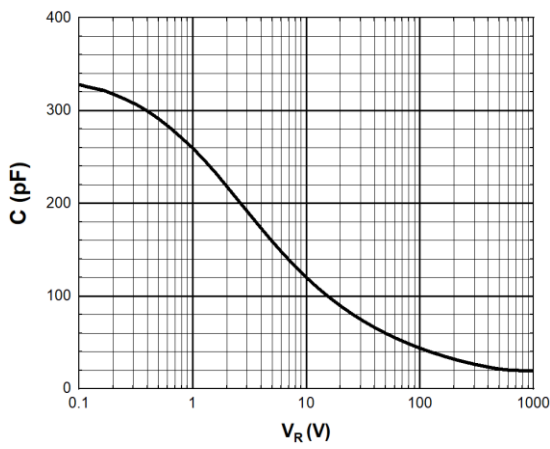
**Typical Performance (per leg)**



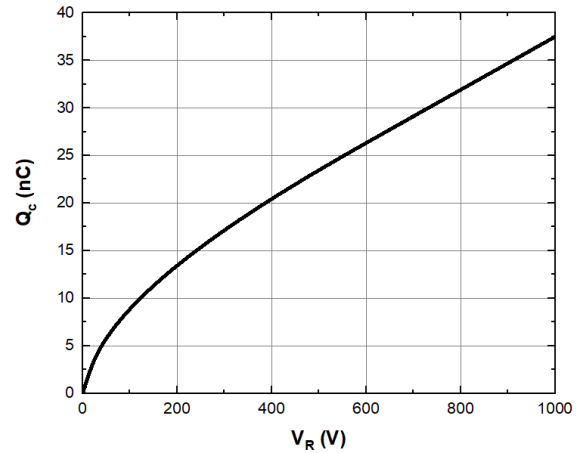
**Fig. 3 Current Derating**



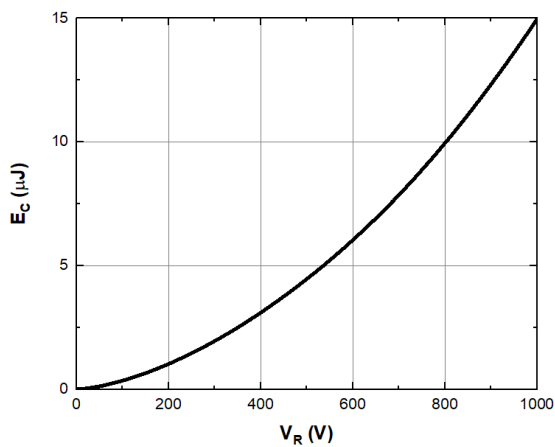
**Fig. 4 Power Derating**



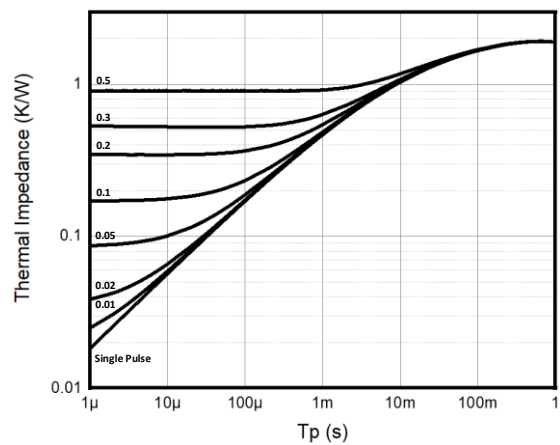
**Fig. 5 Capacitance vs. Reverse Voltage**



**Fig. 6 Recovery Charge vs. Reverse Voltage**

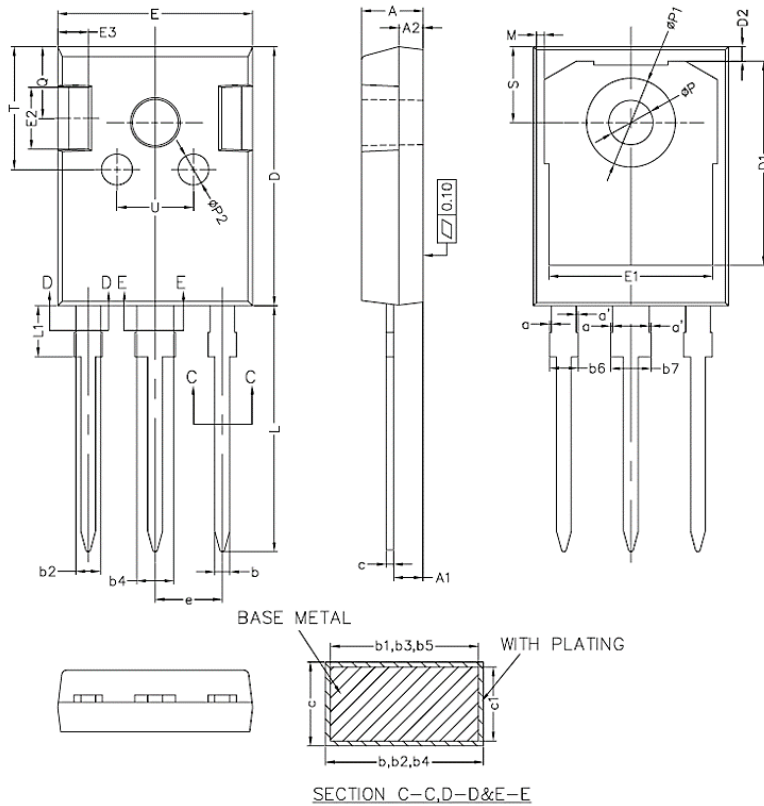


**Fig. 7 Capacitance stored Energy**



**Fig. 8 Thermal Impedance**

**Package TO-247-3 (Unit: mm)**



COMMON DIMENSIONS  
(UNITS OF MEASURE=MILLIMETER)

SYMBOL	MIN	NOM	MAX
A	4.90	5.00	5.10
A1	2.31	2.41	2.51
A2	1.90	2.00	2.10
a	0	-	0.15
a'	0	-	0.15
b	1.16	-	1.26
b1	1.15	1.2	1.22
b2	1.96	-	2.06
b3	1.95	2.00	2.02
b4	2.96	-	3.06
b5	2.95	3.00	3.02
b6	-	-	2.25
b7	-	-	3.25
c	0.59	-	0.66
c1	0.58	0.60	0.62
D	20.90	21.00	21.10
D1	16.25	16.55	16.85
D2	1.05	1.20	1.35
E	15.70	15.80	15.90
E1	13.10	13.30	13.50
E2	4.90	5.00	5.10
E3	2.40	2.50	2.60
e	5.34	5.44	5.54
L	19.80	19.92	20.10
L1	-	-	4.30
M	0.35	-	0.95
P	3.50	3.60	3.70
P1	7.00	-	7.40
P2	2.40	2.50	2.60
Q	5.60	-	6.00
S	6.05	6.15	6.25
T	9.80	-	10.20
U	6.00	-	6.40

NOTES:  
1. ALL DIMENSIONS REFER TO JEDEC STANDARD TO-247 AD DO NOT INCLUDE MOLD FLASH OR PROTRUSIONS.  
2. EJECTION MARK DEPTH  $0.10^{+0.15}_{-0.05}$ .

This Product has not been designed or tested for use in, and is not intended for use in, applications implanted into the human body nor in applications in which failure of the product could lead to death, personal injury or property damage, including but not limited to equipment used in the operation of nuclear facilities, life-support machines, systems, or air-traffic control systems.

The information given in this document shall in no event be regarded as a guarantee of conditions or characteristics. With respect to any examples, hints or any typical values stated herein and/or any information regarding the application of the product, AZ Power Inc. disclaims any and all warranties and liabilities of any kind, including without limitation warranties of non-infringement of intellectual property rights of any third party.