

MEEET

KIN PANEL

FERMAX

INSTALLER'S MANUAL

en.









CONGRATULATIONS FOR BUYING A QUALITY PRODUCT!
Fermax Electrónica develops and manufactures premium equipment that meets the highest design and technology standards. We hope you will enjoy all its functions.

*Technical publication for information purposes edited by FERMAX ELECTRÓNICA S.A.U.
FERMAX ELECTRÓNICA applies a continuous improvement policy, therefore it reserves the right to modify the contents of this document, as well as the product features hereof at any time and without prior notice. Any modification will be reflected in subsequent editions of this document.*

*This product is protected with the following patents and utility models:
PATENTS: US 9215410, US 9762852, BE1023440, AU2014203706.
UTILITY MODELS: ES1187384U, ES1141495U, FR3038192, DE202016000632U1, CN205987229(U).*

INDEX

| | | |
|---|--|-----------|
|  | 1. DESCRIPTION | 4 |
|  | 2. WEB BROWSER PROGRAMMING | 5 |
| | 2.1. Decive | 5 |
| | 2.2. General | 6 |
| | 2.3. Network configuration | 8 |
| | 2.4. Access | 9 |
| | 2.5. Face recognition | 11 |
| | 2.6. Lift | 11 |
| | 2.7. Ip camera | 12 |
| | 2.8. Sip | 12 |
| | 2.9. Sip call | 14 |
| | 2.10. Advanced | 16 |
| | 2.11. Pincode | 17 |
| | 2.12. Wechat QR | 18 |
| | 2.13. Reset | 18 |
|  | 3. OPERATION | 20 |
| | 3.1. Icon functions | 22 |
|  | 4. INSTALLATION | 26 |
| | 4.1. Flush box installation | 26 |
| | 4.2. Installation Guide Diagram | 26 |
| | 4.3. Connectors | 27 |
| | 4.4. Basic diagrams | 28 |
| | 4.5. Diagram Installation of the 4 RELAY MODULE REF. 1491 | 28 |
| | 4.6. Diagram installation of the GUEST CODE Module Ref. 1494 | 28 |
| | 4.7. Diagram installation of the lift control system | 29 |
|  | 5. TECHNICAL SPECIFICATIONS | 30 |
|  | 6. ANNEX | 31 |
| | 6.1. Firmware updates | 31 |
| | 6.2. Regulations | 31 |

DESCRIPTION

This document is the Installer Manual for KIN PANEL REF. 1445, version V 03.10. It includes installation and programming instructions.



NOTE:

Resident can access to their corresponding entrance by passing their authorized Mifare identifier. The door will open and release the lock.

The Mifare identifier data must be added through FERMAX MEET MANAGEMENT software. Maximum 100.000 identifiers .

By means of their WIEGAND connection (output) it is possible to integrate this Mifare reader in third party Access Control Systems. It is also possible to integrate third party readers using WIEGAND protocol with the KIN panel.

WEB BROWSER PROGRAMMING

For programming of the KIN panel, access is required through a PC via a web browser. Preferably use Chrome browser.

The PC must be connected to the same LAN as the panel and configured with an IP address in the same range. The KIN panel default IP address is 10.1.0.1.

Type the IP address of the panel in the address bar of the browser. An identification form will appear.

The default identification data are:

- **User name:** admin
- **Password:** 123456

A web page will appear with the different programming sections:

2.1. DEVICE

The section DEVICE provides some technical information regarding the equipment, as a reference.

- **FERMAX KIN PANEL:** Device type.
- **FIRMWARE:** Version of the installed firmware.
- **SERIAL N°:** Unique identification number of the panel.
- **DEVICE:** Type and panel number.
- **MAC:** Panel MAC number.
- **IP:** IP address assigned to the panel.

2.2. GENERAL

The section GENERAL allows the configuration of the identification parameters of the KIN panel within the installation. It allows time-date configuration.

Button for saving options above of it.

Button for saving date/time options only.

TYPE: Select the identification parameters of the panel. There are some other parameters related, depending on TYPE selection:

General Entrance Panel

Panel installed in one of the main entrances to a condominium.

• **DEVICE NUMBER:** Number assigned to the general entrance where this panel is installed (1-9000).

In the case that there is one entrance only, leave the default value 1.

• **DEVICE TAG:** Text to be shown in the monitor and guard unit.

• **ALPHANUMERIC KEYPAD:** Select this box if this panel will use alphanumeric call and unselect if it will use numerical digits only.

In the case of ALPHANUMERIC call, the available characters are A to H. The panel will convert character A to 1, B to 2, etc. For example, dialling 80C, the called is 803.

Block Panel Entrance

Panel installed in a single building or in a block of a condominium.

• **BLOCK:** Number assigned to the block where the panel has been installed (1-999). In the case of individual blocks, let the default value: 1.

• **DEVICE NUMBER:** Number assigned to the block entrance where this panel is installed (1-99). In the case that there is one entrance only, leave the default value. 1.

• **DEVICE TAG:** Text to be shown in the monitor and guard unit.

• **ALPHANUMERIC KEYPAD:** Select this box if this panel will use alphanumeric call and unselect if it will use numbers only.

In the case of ALPHANUMERIC call, the available characters are A to H. The panel will convert character A to 1, B to 2, etc.

For example, dialling 80C, the called monitor is 803

1 W Panel

For a single house or apartment. It can only call to a unique apartment.

| | |
|----------------|------------------------------|
| TYPE: | 1W PANEL |
| BLOCK: | 1 |
| APARTMENT: | 803 |
| DEVICE NO.: | 1 |
| DEVICE TAG: | VILLA PANEL (≦16 CHARACTERS) |
| SCREEN PROMPT: | MS AND MR WILLIAMS HOUSE |

- **BLOCK:** Number assigned to the block where the house or apartment belongs (1-999). In the case of individual apartments or houses, leave the default value: 1.
- **APARTMENT:** Apartment number where this panel is installed. (0001-9899).
- **NAME:** Text to be shown in the panel, as an information for visitors.
- **DEVICE NUMBER:** Number assigned to this panel (1-9. In the case that there is one panel only, leave the default value 1.
- **DEVICE TAG:** Text to be shown in the monitor and guard unit.
- **SCREEN PROMPT:** Text to be shown in the panel, as an information for visitors.

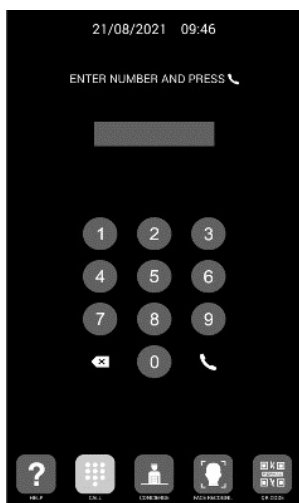

Numerical keypad

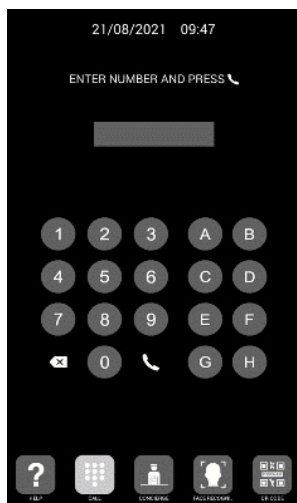

Alphanumeric keypad



1 WAY panel

LANGUAGE: Select the desired language in the dropdown options.

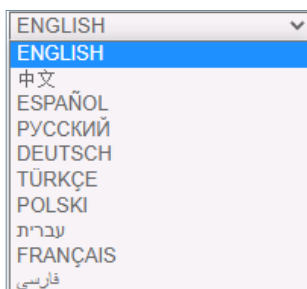

Default option is ENGLISH.
Refresh the webpage after changing the language.

PANEL VOLUME: Select the desired value between 1 and 5. Default option is 4.
The conversation volume is common for uplink and downlink.

BACKGROUND: Select dark colour or light colour.

BRIGHTNESS: Set the brightness value of the screen, 50, 100, 150, 200 and 250 option (default 250).

VOICE SYNTH: Enables or disables the speech when door lock is released. If the speech is disabled, no speech in the panel will sound when the lock is released.

VIDEO RESOLUTION: In order to fit the different types of monitors. The default value 640×480.

SIP DIVERT MODE: This function is available for the device of sip call list. Please refer to SIP section for further details.

PARALLEL CALL: When the panel calls the resident, the monitor and the call divert APP rings at the same time. Once one terminal answers the call the other one stops ringing.

SEQUENTIAL CALL: When the panel calls the resident, the monitor will ring 30s if no answer, the call divert APP or other associated devices will start to ring.

SCREENSAVER: Enable or disable screen saver of the panel. The screensaver appears when the panel is idle, and nobody is in front of it for 60 seconds. Then, and after 3 minutes, the panel turns off for saving energy.

The screensaver is customizable and can be imported, exported or deleted. The default screensaver cannot be deleted.

HELP: Enable HELP icon at the panel.

The help is customizable and can be imported, exported or deleted. The default screensaver cannot be deleted.

STANDBY INTERFACE: Standby interface is optional: CALL, HELP or DIRECTORY.

CONCIERGES: You can select 0, 1 or 2 in the dropdown options. There will be no CONCIERGE icon if in the panel the selected parameter is 0. Visitor can call one concierge if you select 1. Visitor can call two concierges if you select 2.

The number of concierges can be assigned to each concierge from 9901 to 9998, depending on the installation. In addition, a concierge tag can be added for description, such as Lobby Concierge or SOS Concierge call.

It is also possible to call other concierges than the ones indicated in the panel dialling the concierge number through the keypad.

DATE FORMAT: Format to show the date information in the screen.

DATE: Setting date manually (See note below).

TIME: Setting time manually (See note below).

TIME ZONE: Setting the time zone of panel. Select local time zone and save.

DAYLIGHT SAVING TIME: Shall be enabled for DST periods and disabled for wintertime.

NOTES:

If the installation has FERMAX MANAGEMENT SOFTWARE, the date and time of panel will synchronize automatically with the management software. If the panel has access to internet, the date and time of panel will also synchronize with internet time server.

If the installation has no FERMAX MANAGEMENT SOFTWARE the installer can set date, time and time zone manually. Do not use the GMT (TIME ZONE) adjustment in this case. GMT is usable only when the time is automatically taken from internet or FERMAX MANAGEMENT SOFTWARE.

Date and time can't be saved after power loss, unless there were internet or management software in the installation. However, the time zone, date format and daylight-saving time can be saved anyway.

Pay attention to the SAVE button related to panel settings or date/time settings since are different and independent.

2.3. NETWORK CONFIGURATION

Allows the configuration of the different parameters of the LAN network reference.

IP: IP address to be assigned to this panel.

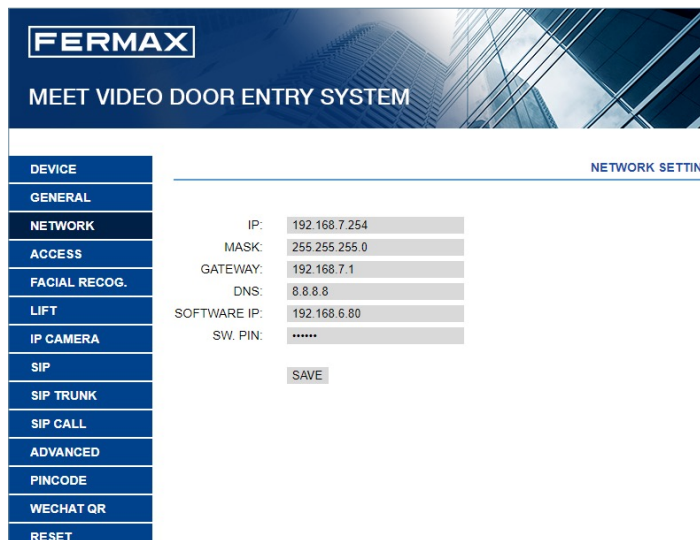

MASK: Subnet mask corresponding to the LAN.

GATEWAY: LAN gateway.

DNS: DNS server address. In case of doubt, we recommend using the default value 8.8.8.8.

SOFTWARE IP: IP address of the PC where the MEET Management Software is installed (if any).

SOFTWARE PIN: PIN ACCESS code for the Management Software control. The default setting is 123456. Indicate the corresponding parameters and click on SAVE to confirm.

NOTE:

The MEET system uses static IP addressing. This ensures that each device has a unique IP address in the same installation.

If a device has an IP address already assigned to another device on the network, an “IP CONFLICT” prompt will appear, along with the MAC of the conflicting device.

Both devices will not work properly until this issue is resolved.

2.4. ACCESS

This section allows some programmings related to the access control functionality of the panel.

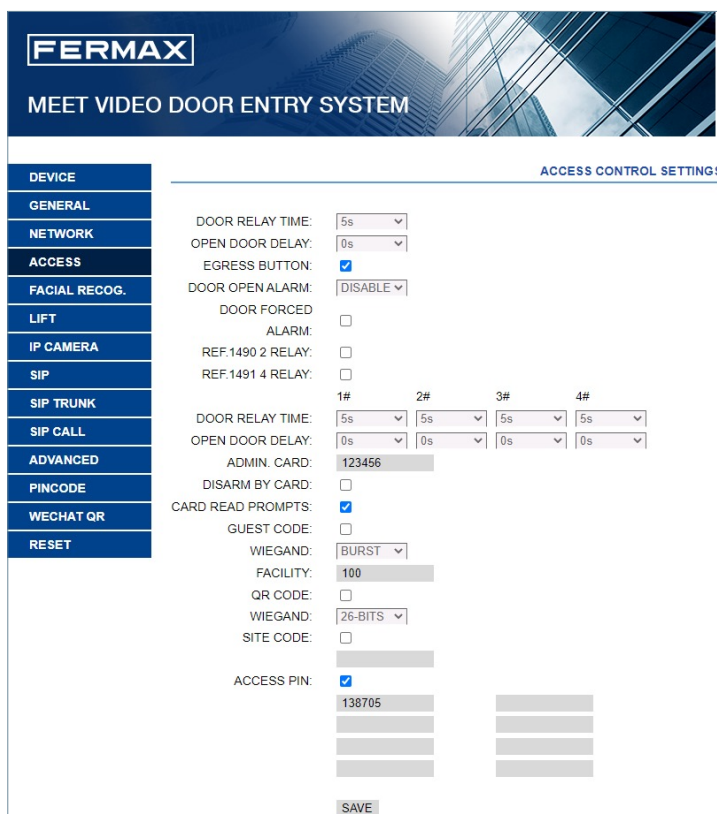

DOOR RELAY TIME: Time for lock-release relay remains active (1-9s optional).

OPEN DOOR DELAY: The time that the open-door command has been sent and the relay is not activated. The relay will activate after the DOOR DELAY TIME is set, Open door relay is useful when the door is not closed the panel. (option 0-9s).

EGRESS BUTTON: The egress button will function if the EGRESS BUTTON is enabled. The relay of panel and Ref.1490 will be activated if the egress button is activated.

DOOR OPEN ALARM: An alarm will trigger if the door keeps opened after the programmed DOOR ALARM time. Options: disable, 30s, 60s, 120s, 180s and 250s.

DOOR FORCED ALARM: An alarm will trigger if an abnormal way to open the door has been detected, for example because there has not been any previous "open the door" command.

REF.1490 2 RELAY: It activates or deactivates the 2 relay module performance.

REF.1491 4 RELAY: Activates or deactivates the additional relay performance. A module Ref. 1491 (4 relay module) must be connected to the RS485 port of the panel No.1. The module address must be set to number 2 (default value).

- **1-4 DOOR RELAY TIME:** Time that the corresponding additional door relay keeps active (1-9s optional).
- **1-4 OPEN DOOR DELAY:** The time that the open door command has been sent and the relay is not activated. The relay will activate after the DOOR DELAY TIME is set, Open door relay is useful when the door is not closed the panel. (option 0-9s).

REMARK: This delay time will not apply to the EXIT BUTTON door lock release that will be always immediate.

ADMIN CARD: Admin/master card ID registered to enrol additional prox cards. This option is useful when there is not MEET MANAGEMENT SOFTWARE available.

When there is no management software, enter 0000 if you do not know the ID of the admin card. The first MIFARE prox card detected by the reader will act as admin/master card. The card of the residents can be added afterwards.

To program user cards, present the admin/master card previously created on the card reader. The panel will enter in cards program mode. All the cards presented from now on will automatically be updated in the panel and may be used to open the door.

If there are not more cards to program, after two minutes the panel will exit program mode.

There is not possible to deregister cards programmed by this method. Use the FERMAX MEET MANAGEMENT SOFTWARE for full operational possibilities.

DISARM BY CARD: When an already programmed user card is presented to the reader, and it has been previously assigned to a monitor, the alarm system of the corresponding apartment will change to HOME mode.

CARD READ PROMPTS: To disable, no tips when the panel reads cards.

GUEST CODE: Guest code function can be enabled or disabled. The panel needs to be connected with a module Ref. 1494 to a third party Access Control System. See INSTALLATION section.

WIEGAND Protocol used for Wiegand transmission (BURST or 26 BITS). Enter available parameter depending on the third-party Access Control System.

FACILITY: Enter available parameter depending on the third-party Access Control System.

QR CODE: Enable or disable QR code function

WIEGAND: Protocol used for Wiegand transmission (26 BITS or 34 BITS). Enter available parameter depending on the third party Access Control System

SITE CODE: The panel will verify the site code of QR if the SITE CODE is enabled. The SITE CODE of QR must be same as filled in.

ACCESS PIN: Enable or disabled the activation of the relay for ACCESS PIN code.

UP to 8 different PIN codes per panel. PIN length between 4 to 6 digits.

2.5. FACE RECOGNITION

Use this setting to enable or disable the FACE RECOGNITION function of the panel.

The FERMAX MANAGEMENT SOFTWARE V01.05 is required for programming and managing the photos of the authorized faces if the model is 5.0.

The FERMAX MANAGEMENT SOFTWARE V01.06 is required for programming and managing the photos of the authorized faces if the model is 6.0.

The screenshot shows the FERMAX web interface for the MEET VIDEO DOOR ENTRY SYSTEM. On the left is a vertical sidebar menu with the following items: DEVICE, GENERAL, NETWORK, ACCESS, FACIAL RECOG. (highlighted), LIFT, IP CAMERA, SIP, SIP TRUNK, SIP CALL, ADVANCED, PINCODE, WECHAT QR, and RESET. The main content area is titled 'FACE RECOGNITION' and contains the following settings:

- FACE RECOGNITION:
- AUTO ACTIVATION:
- MODEL: 6.0 (dropdown menu)
- LIVENESS DETECTION: ENABLED (dropdown menu)
- SIMILARITY: LOW (dropdown menu)

A 'SAVE' button is located at the bottom of the settings area.

FACE RECOGNITION: Enable or disabled face recognition function.

AUTO ACTIVATION: Enable or disable auto activation function of QR code or face recognition. If enabled, wait 15 seconds for any process to end.

MODEL: 5.0, 6.0 options. Default 6.0.

The FERMAX MANAGEMENT SOFTWARE V01.05 is required for programming and managing the photos of the authorized faces if the model is 5.0.

The FERMAX MANAGEMENT SOFTWARE V01.06 is required for programming and managing the photos of the authorized faces if the model is 6.0.

LIVENESS DETECTION: Enable or disabled LIVENESS DETECTION function.

SIMILARITY: High, medium and low options. Default is low.

NOTES:

MEET panel face recognition function is based on a bidimensional face identification, with the ability of differentiating among photos or live faces in certain conditions.

This technology can be used to open doors but cannot guarantee the highest security level or 100% accuracy of liveness detection.

2.6. LIFT

The block panel will show lift dispatch if the LIFT function is enabled.

LIFT DISPATCH: Enable or disable LIFT DISPATCH function.

WAITING TIME: This time will define the maximum time that the message “Please wait for lift dispatch” will be shown on the display.

The WAITING TIME need be extended based on the delay time of receiving the signal from the elevator to the MEET 32 input module. If the signal is not received within this time on the MEET 32 input module, then the “Please wait for lift dispatch” information on the panel will disappear and a message of “Lift dispatch failed” will be displayed.

NUMBER OF INPUT PORTS: Only available in panel programmed as PANEL 1. according to quantity of lift and block panel , then select number of input ports.

The screenshot shows the 'LIFT CONTROL' configuration page. On the left is a navigation menu with options: DEVICE, GENERAL, NETWORK, ACCESS, FACIAL RECOG., LIFT (selected), IP CAMERA, SIP, SIP TRUNK, SIP CALL, ADVANCED, PINCODE, WECHAT QR, and RESET. The main content area includes a 'LIFT' checkbox (checked), 'DISPATCH' (checked), 'WAITING TIME' (6s), and 'NUMBER OF INPUT PORTS' (5). Below this is a table with 3 columns: PORT NO., DEVICE NO., and INFORMATION DISPLAYED. The table contains 5 rows, with the first row having '1' in both PORT NO. and DEVICE NO. columns. A 'SAVE' button is at the bottom.

| PORT NO. | DEVICE NO. | INFORMATION DISPLAYED |
|----------|------------|-----------------------|
| 1 | 1 | |
| 2 | | |
| 3 | | |
| 4 | | |
| 5 | | |

2.7. IP CAMERA

The monitor can switch to IP CCTV camera video during a conversation. This function allows to configure IP CCTV cameras using RTSP protocol to be displayed as an auxiliary camera to provide different view angles from the door or related areas.

The screenshot shows the 'IP CAMERA SETTINGS' configuration page. The navigation menu on the left is the same as in the previous screenshot, with 'IP CAMERA' selected. The main content area includes 'NUMBER OF CAMS' (3), and three camera entries: IP CAM 1 (TENNIS COURT, URL: rtsp://admin:12345@192.168.1.72), IP CAM 2 (CORRIDOR, URL: rtsp://admin:12345@192.168.1.174:554), and IP CAM 3 (LIFTS, URL: rtsp://admin:12345@192.168.1.44:554). A 'SAVE' button is at the bottom.

NUMBER OF CAMS: IP camera Number. Up to 4 different cameras.

- CAMERA 1, 2, 3 and 4: IP camera name.
- URL: -> **rtsp://user:password@ip_address_of_camera.**

User: password: for cameras that require a username and password for connection.

Depending on the brand/model of camera, other URL different than the one above would be required. Check the IP camera technical documentation.

2.8. SIP

This option allows to configure KIN panel to use SIP functionalities, such as call divert to smartphone using the FERMAX MEET ME APP or allow the panel to operate with a third-party SIP systems or terminals using SIP protocol instead of FERMAX MEET protocol.

Configuration for smartphone call divert, using FERMAX MEET ME APP

Configure the SIP parameters as explained below, if the divert function to smartphone, through the FERMAX MEET ME server is used.

FERMAX
MEET VIDEO DOOR ENTRY SYSTEM

SIP SETTINGS

DEVICE

GENERAL

NETWORK

ACCESS

FACIAL RECOG.

LIFT

IP CAMERA

SIP

SIP TRUNK

SIP CALL

ADVANCED

PINCODE

WECHAT QR

RESET

ENABLE SIP: [SEARCH SIP STATUS](#)

SIP SERVER: sip.sip.fermax.com

DOMAIN: sip.fermax.com

OUTBOUND:

STUN IP:

STUN PORT: 5060

H.264: 102

SIP USER: 0199984

SIP PASS:

CONVERSATION: 120s

RING TIME: 30s

SAVE

ENABLE SIP: Select this box to enable SIP functions.

SEARCH SIP STATUS: this button appears when enable SIP function, shows SIP REGISTERED if the panel register successfully or SIP REGISTER FAILED if the panel register unsuccessfully.

SIP SERVER: Use the FERMAX MEET server -> ***sip: sip.fermax.com.***

DOMAIN: Indicate the server domain -> **sip.fermax.com**

OUTBOUND: Not necessary. Leave it in blank.

STUN IP: Not necessary. Leave it in blank.

STUN PORT: Not necessary. Leave it in blank.

H.264: Leave the default value: 102.

SIP USER, SIP PASSWORD: Indicate the user and password of the FERMAX MEET ME licence assigned to this panel. They are indicated in a label attached in the front of the panel.

CONVERSATION, RING TIME: No function.

Configuration for SIP server integration

Configure the SIP parameters as explained below, for the cases where the KIN panel works as an extension of a SIP server.

Contact with the SIP server administrator to get some of the information required in this section.

FERMAX
MEET VIDEO DOOR ENTRY SYSTEM

SIP SETTINGS

DEVICE

GENERAL

NETWORK

ACCESS

FACIAL RECOG.

LIFT

IP CAMERA

SIP

SIP TRUNK

SIP CALL

ADVANCED

PINCODE

WECHAT QR

RESET

ENABLE SIP: [SEARCH SIP STATUS](#)

SIP SERVER: sip.192.168.1.190

DOMAIN: 192.168.1.190

OUTBOUND: sip

STUN IP: 192.168.1.190

STUN PORT: 5060

H.264: 102

SIP USER: 1012

SIP PASS:

CONVERSATION: 120s

RING TIME: 35s

SAVE

ENABLE SIP: Select this box to enable SIP functions.

SEARCH SIP STATUS: this button appears when enable SIP function, shows SIP REGISTERED if the panel register successfully or SIP REGISTER FAILED if the panel register unsuccessfully.

SIP SERVER: Indicate the sip SERVER address. Format -> sip: IP_SERVER.

DOMAIN: domain of the SIP server or IP address.

OUTBOUND: Not necessary. Leave it in blank.

STUN IP: domain of the SIP server.

STUN PORT: Used for the configuration of Internet SIP server-based installations. It is usually port 5060. Check with your network or SIP server administrator.

H.264: Depends on the SIP SERVER. In the case of doubt, leave the default value (102).

SIP USER, SIP PASSWORD: Indicate the user and password that this terminal is programmed in the SIP server.

CONVERSATION, RING TIME: No function.

2.9. SIP CALL

This option allows to generate calls to smartphone devices in the cases where it is not a MEET monitor associated in the installation. A FERMAX MEET ME licence Ref. 1496 is required for each apartment

The call can be received in 8 smartphones simultaneously.

Furthermore, it is also possible, to generate simultaneous calls to several devices MEET and/or third-party SIP devices as well, using SIP protocol instead of FERMAX MEET protocol.

A .CSV file containing the associated number and the information of the diverted device or devices must be updated in the panel.



The operation procedure to generate and update the .CVS file is as follow:

1. Select EXPORT to generate a blank .CVS table, and save it in your PC.

Rename this table as your choice or leave the default name (MEET CALL DIVERT PXXX-YY.csv), where XXX is the BLOCK NUMBER and YY is the device number assigned to this panel).

| | A | B | C | D |
|----|-----------|--------|---|---|
| 1 | APARTMENT | NUMBER | | |
| 2 | | | | |
| 3 | | | | |
| 4 | | | | |
| 5 | | | | |
| 6 | | | | |
| 7 | | | | |
| 8 | | | | |
| 9 | | | | |
| 10 | | | | |
| 11 | | | | |

MEET CALL DIVERT P066-0001-01

2. Use Microsoft Excel / Notepad or Notepad++ (recommended) to open the created file. It will look like:
3. The first cell (A1) has the content: APARTMENT, the second cell(B1) has content :NUMBER, Do not change it.
4. Use the following cells (A2,B2 A3, B3,A4,B4 etc.) to fill in the data of the apartment and number of devices to divert.

Dependieng of the type of call, the format of the data is different:

a. IN the case of a call to a FERMAX MEET ME LICENCE:

APARTMENT, sip: **XXXXXX@sip.fermax.com** were XXXXXXXX is the licence name and APARTMENT is the number to dial in the panel.

b. IN the case of a call to a MEET device in the same installation:

APARTMENT, **sip:XXX@IP_DEVICE** where XXX is any identifier of the device and IP_DEVICE is the IP address to the MEET monitor to call. It is possible to generate a P2P SIP call without the identifier as follows: *sip:IP_DEVICE*.

c. In the case of a call to a third party SIP device (through a SIP server):

APARTMENT, sip:user@IP_SIP_SERVER where user is the identification user that the device to call has been programmed in the SIP server, and IP_SIP_SERVER is the SIP server IP address.

d. It is also possible to assign multiple and different divert formats to the same apartment (for example a call to a third-party SIP device and a smartphone device as well).

Use the corresponding format explained above, using the same row but different column for each format. See example below.

5. Once the table has been finished, save it and IMPORT to the panel. For this, click on “Choose file”, select the file to import and click on IMPORT button.

Wait for a few seconds until a pop up message “UPLOAD SUCCESSFUL” appear.

EXAMPLE

| A | B |
|-----------|---|
| APARTMENT | NUMBER |
| 170 | sip:192.168.1.190 |
| 171 | sip:0103283@sip.fermax.com |
| 645 | sip:192.168.1.195 |
| 180 | sip:1234@192.168.1.170 |
| 181 | sip:1234@192.168.1.170;sip:0103283@sip.fermax.com |
| 182 | sip:1234@192.168.1.170;sip:192.168.1.195 |
| 183 | sip:1234@192.168.1.170;sip:192.168.1.197;sip:0103283@sip.fermax.com |

In this example:

- Apartment 170 generates a call to the monitor IP 192.168.1.190 in the same installation.
- Apartment 171 generates a call to the smartphone with FERMAX MEET ME licence 0103283.
- Apartment 645 generates a call to the monitor IP 192.168.1.195 in the same installation.
- Apartment 180 generates a call to the SIP device 1234 of the SIP server with IP 192.168.1.170.
- Apartment 181 generates a call to the SIP device 1234 of the SIP server with IP 192.168.1.170 and to the smartphone with FERMAX MEET ME licence 0103283.
- Apartment 182 generates a call to the SIP device 1234 of the SIP server with IP 192.168.1.170 and to the monitor IP 192.168.1.195 in the installation.
- Apartment 183 generates a call to the SIP device 1234 of the SIP server with IP 192.168.1.170 and to the monitor IP 192.168.1.197 in the installation and to the smartphone with FERMAX MEET ME licence 0103283.

2.10. ADVANCED

Some advanced settings, such as quick dial and directory, can be selected in this section.

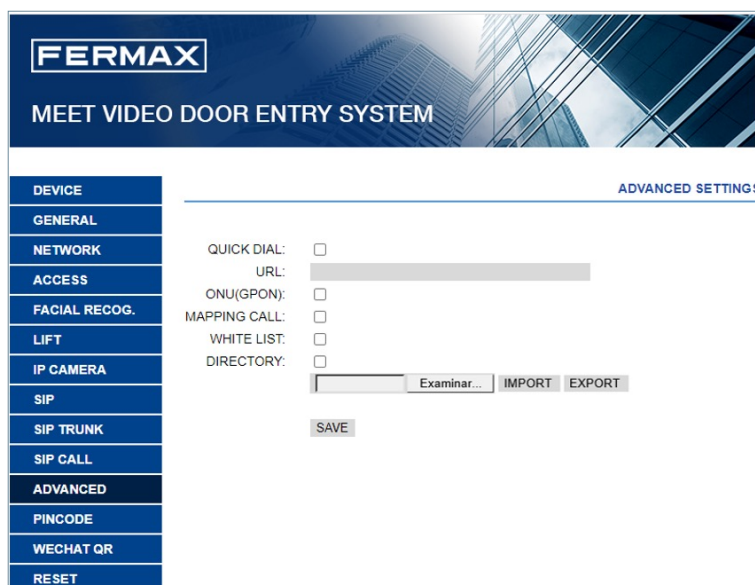

QUICK DIAL: This function is not available in this version.

URL: Indicate the device that has to receive the call, with the corresponding format:

- Another monitor -> **sip:@IP_monitor**
- SIP device: -> **sip:user@IP_SIP_server**
- FERMAX MEET ME device -> **sip:meet_me_user@sip.fermax.com**

ONU (GPON): Used in large installations based on SIP protocol (GPON) and in combination with the configuration of said installations.

MAPPING CALL: The installer can create a mapping call list. Mapping call code can include numbers and letters (A-H). For block panels, 1-5 digits is allowed, for general entrance panel, 1-8 digits is allowed. The visitor can call the apartment via mapping code only if this apartment has mapping code enabled, the visitor can call the apartment via apartment number if this apartment does not have a mapping code.

WHITE LIST: The apartment can be called if the corresponding white list of apartment is Y (YES), otherwise, the apartment cannot be called.

DIRECTORY: KIN panel allows to use a directory for calling the tenants. Visitors can select the tenant's name from this directory and call directly without knowing the apartment number.

The operation procedure to generate and update the .CSV file is as follow:

1. Select EXPORT to generate a blank .CVS table, an save it in your PC. Rename this table as your choice or let the default name agenda.csv.
2. Use Microsoft Excel / Notepad or Notepad++ (recommended) to open the created file. It will have a look like this.

| 1 | APARTMENT, NAME, MAPPING CODE, WHITELIST (Y) | | | |
|----|--|--|--|--|
| 2 | | | | |
| 3 | | | | |
| 4 | | | | |
| 5 | | | | |
| 6 | | | | |
| 7 | | | | |
| 8 | | | | |
| 9 | | | | |
| 10 | | | | |
| 11 | | | | |

3. The first cell (A1) has the content: APARTMENT, The second cell (B1) has the content: NAME, The third cell (C1) has the content: MAPPING CODE, The fourth cell (D1) has the content: WHITELIST(Y)

4. Use the following cells (A2, A3, A4, etc.) to fill in the data of apartment name, user's name, mapping code and whitelist, with the format "Apartment number", "Name", "Mapping code", "Whitelist(Y)". If Mapping

or Whitelist is not used the format remains the same, all 4 commas are needed. Check with Notepad or Notepad++ that the format is properly kept as per the picture.

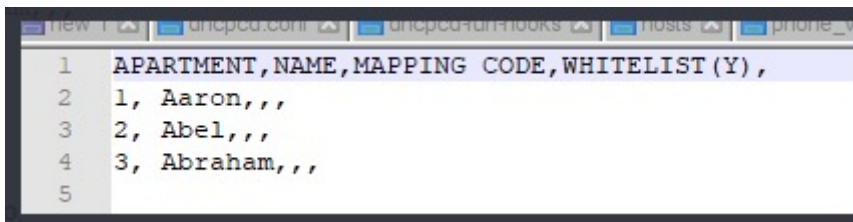

5. Once the table has been finished, save it and import to the panel. For this, click on “Choose file”, select the file to import and click on IMPORT button.

Wait for a few seconds until a pop up message “UPLOAD SUCCESSFUL” appears.

REMARK: Donot use special characters such as “-“ on the names or the upload process on the panel will not perform properly.

EXAMPLE:

| APARTMENT | NAME | MAPPING CODE | WHITELIST(Y) |
|-----------|------------------|--------------|--------------|
| 1 | Merideth Semmes | 1234 | Y |
| 2 | Jasmin Drennan | | Y |
| 3 | Nicola Haugh | | Y |
| 4 | Cherri Breedlove | | Y |
| 201 | Avril Wagstaff | | Y |
| 202 | Mac Gatchell | | Y |
| 301 | Carl Elliott | | Y |
| 302 | Kassie Rawley | | Y |
| 401 | Elias Spagnuolo | | Y |
| 402 | MarylN Arvizo | | Y |
| 1501 | Maurice Maxwell | 15011 | Y |
| 1502 | Olen Pelt | 15012 | Y |
| 1001 | Irwin Schoemaker | | Y |
| 1002 | Alesia Pareja | | Y |
| 2103 | Vern Boley | | Y |
| 2104 | Austin Lucio | | Y |
| 2201 | Wynona Standley | | Y |
| 2202 | Gregg Ying | | Y |
| 2601 | Shanika Frigo | | Y |
| 2602 | Ginny Dampier | | Y |
| 2705 | Jan Harshbarger | | Y |
| 2706 | Dawn Allington | | Y |
| 28 | Deetta Robb | | Y |
| 2901 | Jame Bradfield | | Y |
| 2902 | Rosita Mccullum | | Y |
| 3007 | Beulah Hassler | | Y |



NOTE:

In the case of non-Latin writing system languages (for example: Chinese, Russian / Cyrillic, Arabic, Hebrew etc.), the procedure is as follows:

1. From the web server of the panel, export the **empty .csv file**.
2. Open with Windows Notepad and copy the directory list to the desired writing system (Latin, Chinese, Russian / Cyrillic, Arabic, ...).
3. Save the file as **.csv / all files * . * / UTF-8**.
4. From the panel’s webserver, import this file and wait for the message “file uploaded successfully” to be displayed.

In the case of **non-Latin** writing systems, it is recommended NOT to use Microsoft Excel since there is a risk of altering the format of the directory file and that the content of the directory is not loaded correctly.

2.11. PINCODE

It allows you to change the INSTALLER PIN code, to access both the installation configuration parameters through the monitor’s own screen and the configuration through a web browser.

Enter the current code, the new pin and confirm it.

The new password can have alphanumeric characters and has no limit on its length.

Finally, select SAVE.

The screenshot shows the FERMAX web interface for the MEET VIDEO DOOR ENTRY SYSTEM. The top navigation bar includes the FERMAX logo and the system name. A sidebar on the left lists various settings categories: DEVICE, GENERAL, NETWORK, ACCESS, FACIAL RECOG., LIFT, IP CAMERA, SIP, SIP TRUNK, SIP CALL, ADVANCED, PINCODE, WECHAT QR, and RESET. The main content area is titled 'PINCODE SETTINGS' and contains three input fields for 'CURRENT PIN:', 'NEW PIN:', and 'CONFIRM PIN:'. A 'SAVE' button is located below these fields.

NOTE:

Make a note of the new PIN at your convenience. If you lose or forget your PIN, you should contact FERMAX's Technical Department to receive instructions regarding its recovery. All settings programmed into the panel will be lost after recovery.

2.12. WECHAT QR

This function is not available in this version of Firmware V 03.10. It is recommended to deactivate it in the web server so that the icon does not appear in the lower part of the screen of the KIN.

2.13. RESET

Use this functionality to remotely reset the KIN panel, or to return it to factory settings. In both cases it will ask for confirmation.

The screenshot shows the FERMAX web interface for the MEET VIDEO DOOR ENTRY SYSTEM. The top navigation bar includes the FERMAX logo and the system name. A sidebar on the left lists various settings categories: DEVICE, GENERAL, NETWORK, ACCESS, FACIAL RECOG., LIFT, IP CAMERA, SIP, SIP TRUNK, SIP CALL, ADVANCED, PINCODE, WECHAT QR, and RESET. The main content area is titled 'RESTORE' and contains two options: 'RESTORE FACTORY SETTINGS' and 'REBOOT DEVICE'. Each option has an 'OK' button next to it.

RESTORE FACTORY SETTINGS: The monitor will automatically turn off and start up with the factory settings. We refer below the essential parameters for your reference.

GENERAL

- BLOCK: 1
- DEVICE: 1

- LANGUAGE: ENGLISH
- VIDEO RESOLUTION: 640 x 480
- INSTALLERPASSWORD:123456

NETWORK

- IP: 10.1.0.1
- MASK: 255.0.0.0
- GATEWAY: 10.254.0.1
- DNS: 8.8.8.8
- SOFTWARE IP: 10.0.0.200

Any other parameters (sip, IP cameras, concierges, cards, etc.) that have been configured will also be lost.

REBOOT DEVICE: The panel will automatically turn off and start up but retain all the programming parameters it had previously.

When resetting, the device will lose connection with the PC. Refresh the website after about 60 seconds to resume the connection.

OPERATION

The screen of the KIN PANEL is interactive, so its operation depends on the call process or selected function. When someone stands in front of the panel or touches anywhere in the screen, a standby interface is shown. This standby interface can be a keypad for calling or some HELP information, or directory, depending on the programming settings.

Depending on the programming settings, the call keypad can be numerical, alphanumerical or individual. It is also possible to select one of the available function icons at the bottom of the screen. These icons must be enabled by the installer.

See WEB BROWSER PROGRAMMING section for further details.

Numerical Keypad

Apartments can be called only with numbers.

To call an apartment, dial apartment number and press the telephone icon. Then follow instructions on screen. It is also possible to select and use the available icon functions (call concierges, face recognition, etc.)

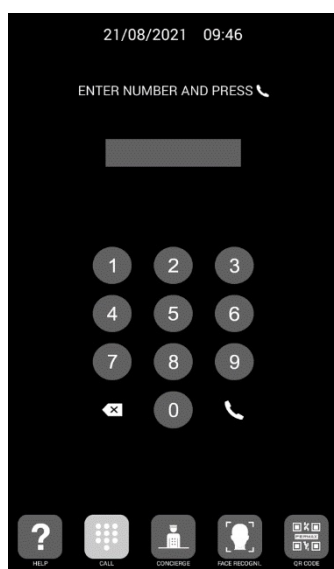

Alphanumerical Keypad

It is possible to call the apartments using letters and numbers.

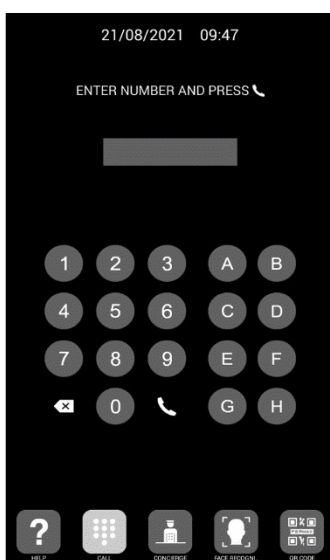

To call an apartment, dial apartment number and/or letters and press the telephone icon.

Then follow instructions on screen.

Available letters are A to H. The panel converts these letters to numbers: A to 1, B to 2, etc.

For example, dialling 80C, the called monitor is 803.

The panel does not convert these letters to numbers if the panel call apartment via mapping code.

It is also possible to select and use the available icon functions (call concierges, face recognition, etc.).

1 W Keypad

It is only possible to call the apartment indicated in the panel.

For this, only press the telephone icon. Then follow instructions on screen.

It is also possible to select and use the available icon functions (call concierges, face recognition, etc.).

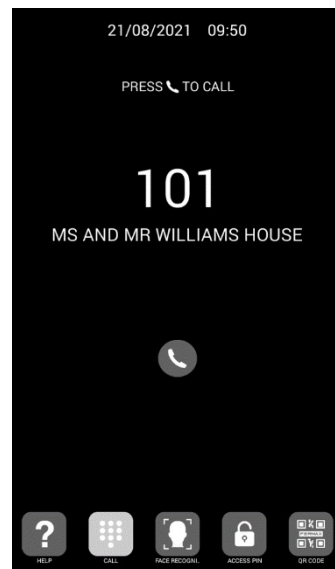

On Screen Information

It is possible to get basic information on the equipment configuration through the screen

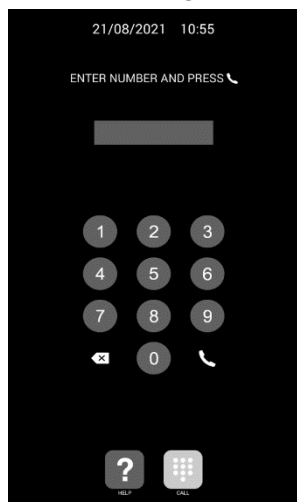

1. Dial 9999, followed by the telephone icon



2. The screen will display information about panel settings:

- Firmware version
- GENERAL settings
- Serial number
- IP address
- MAC

NOTE: In the case the panel is configured as a 1W KEPAD, it is not possible to access the information screen from the panel since with that configuration the panel does not allow to dial 9999, it only admits calls to the assigned apartment.

Standby

If the keypad is not used, for 60 seconds the panel will turn into a screensaver. Then, if nobody is in front of the panel, it turns off after 3 minutes for saving energy.

NOTE: The screensaver can be customized, so it is possible that it differs from the one in the image above.



3.1. ICON FUNCTIONS

Depending on the programming and capabilities of the installation, some icon functions will be available on the bottom of the screen.

Up to 5 icons will appear on the screen. If there were more than 5 functions available, use the horizontal scroll over the icons to make visible the hidden ones.

The utility of each icon is explained below. Tap on the corresponding icon to use the associated function.

HELP Icon



It offers some easy instructions for the users.



NOTE: The HELP screen can be customized, so it is possible that it differs from the one in the image above.

CALL Icon



It shows the calling screen, it can be a numerical keypad, an alphanumerical keypad or a single apartment calling button.

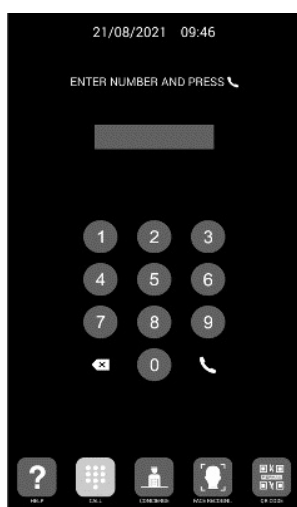

Numerical keypad

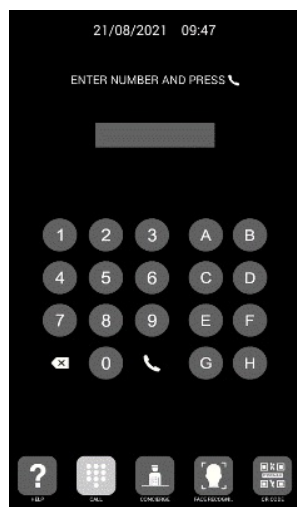

Alphanumerical keypad



1 WAY panel



CONCIERGE Icon

It allows to directly call to one or two available concierges.

Users should tap the desired concierge icon for contact him. Depending on the programming settings or installation, one or two concierge icons would be available.

The tag beside the concierge icon can be customized.

See WEB BROWSER PROGRAMMING section for further details.

It is also possible to call other concierges different than the ones with icon, dialling the corresponding concierge number (as same as a call to an apartment)



FACE RECOGNITION Icon

Users can be identified by means of facial recognition.

Tapping this button, the face recognition interface will appear. Users should stay for a few seconds in front of the panel.

If the user's face has been programmed and the system recognises him, the door will open.

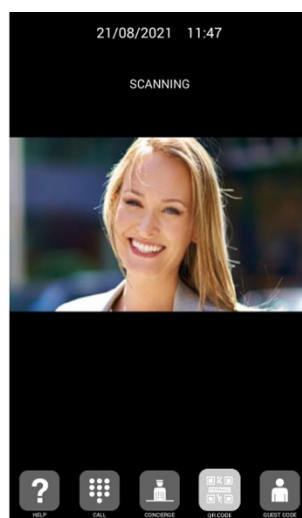

NOTE:

Face recognition requires some previous programming by means of the FERMAX MEET MANAGEMENT Software.



QR CODE Icon

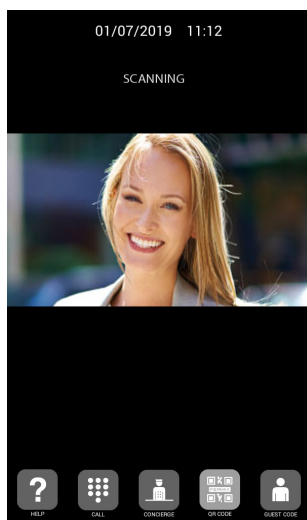

This option allows users to open the door by means of scanning a QR code that has been provided to him, for example to get access during a certain day.

The panel shall have installed a GUEST CODE MODULE Ref.1494, as explained in the INSTALLATION section. A third-party Access Control System is required.



DIRECTORY Icon

It allows to use a directory for selecting and calling an apartment searching the owner's name.

It is possible to make a scroll in the list or select the letter of the right side to filter the names which their first letter matches.

A programming is required. See WEB BROWSER PROGRAMMING section for further details.



GUEST CODE Icon

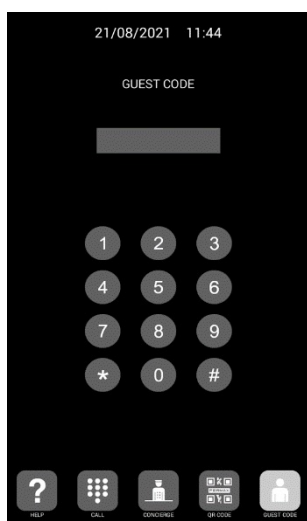

This option allows users open the door by means of entering a numerical code that has been given to him, for example to get access during a certain day.

The panel shall have installed a GUEST CODE MODULE Ref.1494, as explained in the INSTALLATION section. A third-party Access Control System is required.

Users shall enter the valid GUEST CODE followed by “#” to open the door.



ACCESS PIN Icon

This option allows users open the door by means of entering an ACCESS PIN code.

Length of ACCESS PIN could be between 4 to 6 digits.

The panel admits up to 8 different ACCESS PIN, that must be programmed by the installer. See WEB BROWSER PROGRAMMING section for further details.

Users shall enter the valid ACCESS PIN followed by “KEY” button to open the door.

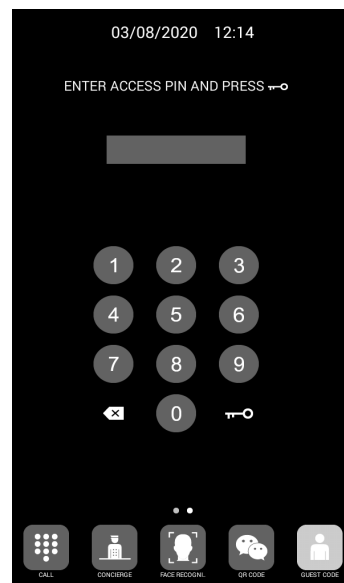

✂ INSTALLATION

4.1. FLUSH BOX INSTALLATION

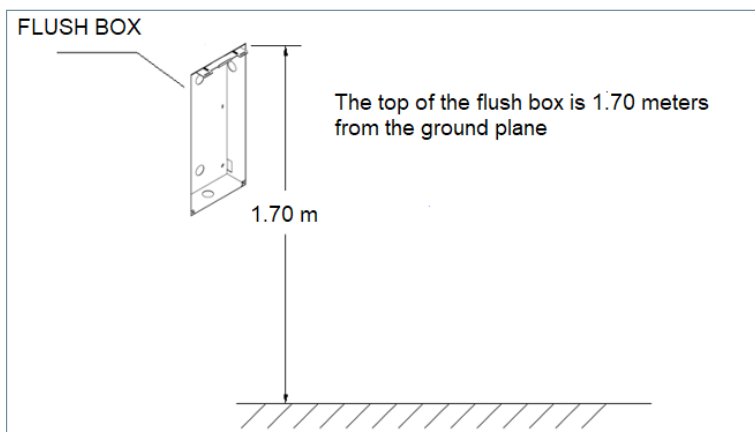

4.2. INSTALLATION GUIDE DIAGRAM

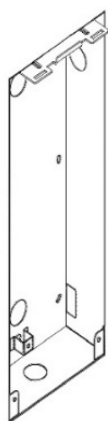

1 Flush box install.

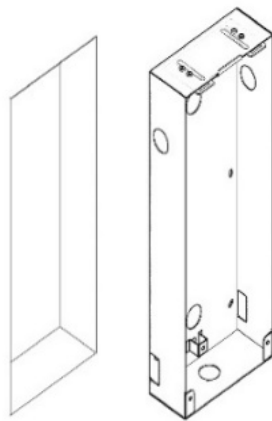

2 Base flush box depth adjustment hook.

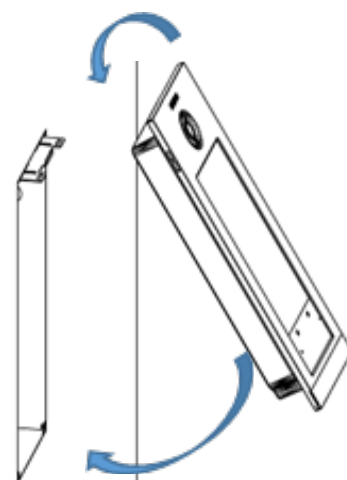

3 The upper part of the panel is stuck in, then move the panel to the flush box.

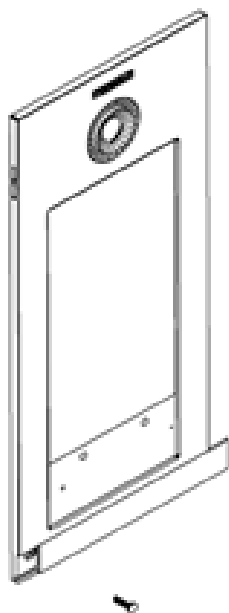

4 Move the slider of the panel and fix the two screws. When installing, pay attention to the reservation of the 2 cm space around the door to move the slide cover.

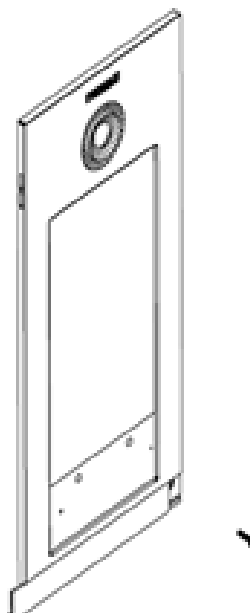

4.3. CONNECTORS

The KIN panel is connected to the installation by means of connectors: ethernet for LAN connection and MOLEX type connectors for other connections (power supply, RS-485, etc.).

A bag containing the corresponding female connectors with their cables comes with the panel.

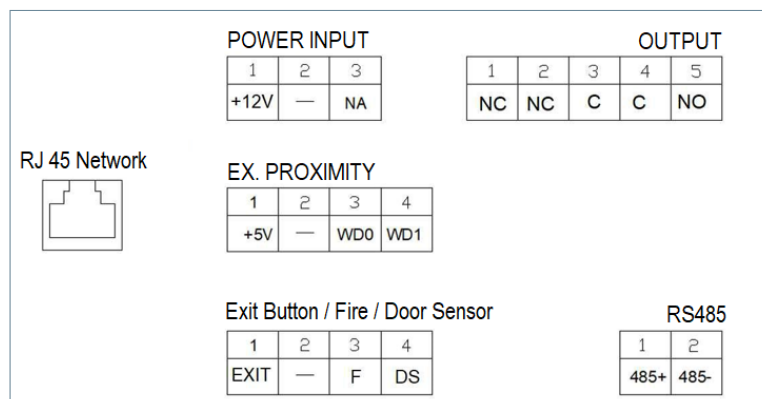

POWER INPUT: 12 Vdc power supply for the cases where no LAN PoE is available.

OUTPUT: Electric lock control relay output.

- NC: Normaly closed contact
- NO: Normaly opened contact
- C: Common

NOTE: NC & C contacts are internally duplicated

EX PROXIMITY:

- (WD0-WD1) Wiegand input/output
- (+5V, -) 5 Vdc auxiliar output

Exit Button /Fire / Door Sensor. See NOTES.

- (EXIT, -) Connections for indoor button
- (F, -) Input for fire alarm & block doors unlock contacts
- (DS, -) Connection for door opened sensor

RS48

- Output for Ref. 1491/Ref. 9545 MEET LIFT Control Gateway, Ref. 1494 Guest code or Ref. 1490 External Relay (*)

(*) Ref. 1490 works in this case as a repeater of the internal relay of the panel.

RJ 45 Network

- RJ 45 LAN or LAN PoE connection

NOTES:

EXIT, FIRE and DS require installer programming. See WEB BROWSER PRORAMMING for further details.

EXIT button allows users to open the door from inside.

FIRE input in PANEL N° 1 has to be connected to a fire output relay of a third-party fire alarm system. If a fire alarm is triggered, an alarm will sound in all the panels of the block, and all the doors will remain opened.

Installing a door open sensor in DS, an alarm sounds in the panel and concierge if the door remains opened during a programmed period, or the door has been forced as well.

The panel has an internal tamper button. If the panel is separated from the wall, an alarm is triggered in the panel, concierge and FERMAX MANAGENEMN SYSTEM (if exists).

4.4. BASIC DIAGRAMS

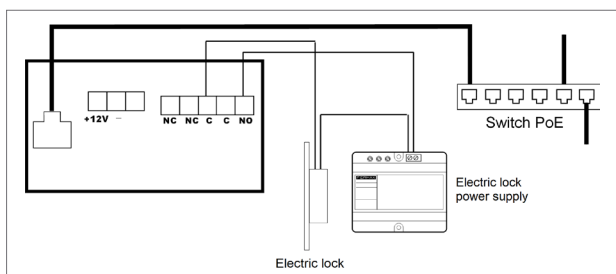

Basic diagram using PoE Switch.

Use a power supply adapted to the electric lock voltage & current

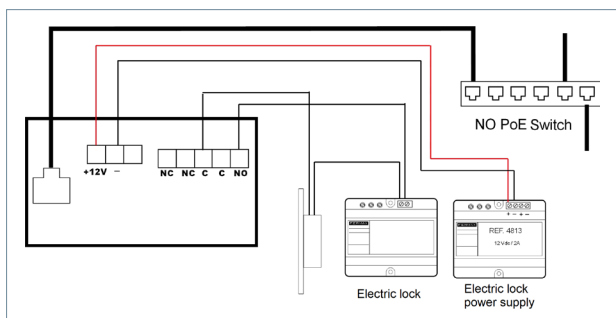

Basic diagram using no PoE switch

Supply the panel by means of a FERMAX Ref. 4813 (12 Vdc 2A) power supply

Use a power supply adapted to the electric lock voltage & current. Do not power the panel and the electric lock from the same power supply.

4.5. DIAGRAM INSTALLATION OF THE 4 RELAY MODULE REF. 1491

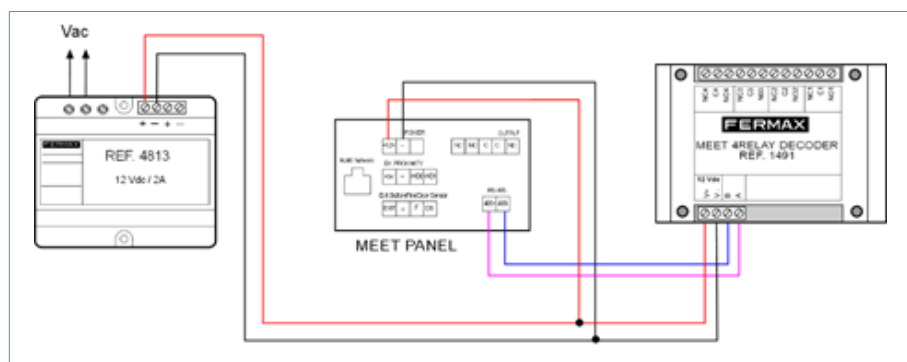

This module is necessary if you want to use the function of activating from the monitors additional relays (up to 4), for example to activate additional doors or gates.

NOTE:

The 1491 module need be connected to the PANEL No.1 in the block. The decoder RS485 address need be set to number 2 (factory defaults is 2).

4.6. DIAGRAM INSTALLATION OF THE GUEST CODE MODULE REF. 1494

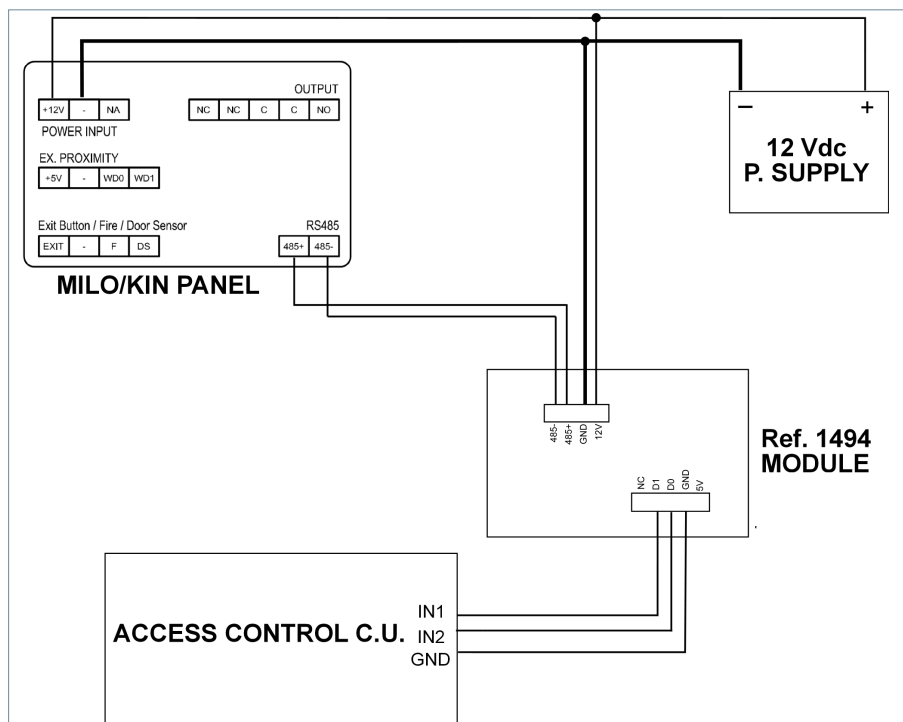

4.7 DIAGRAM INSTALLATION OF THE LIFT CONTROL SYSTEM REF. 9545

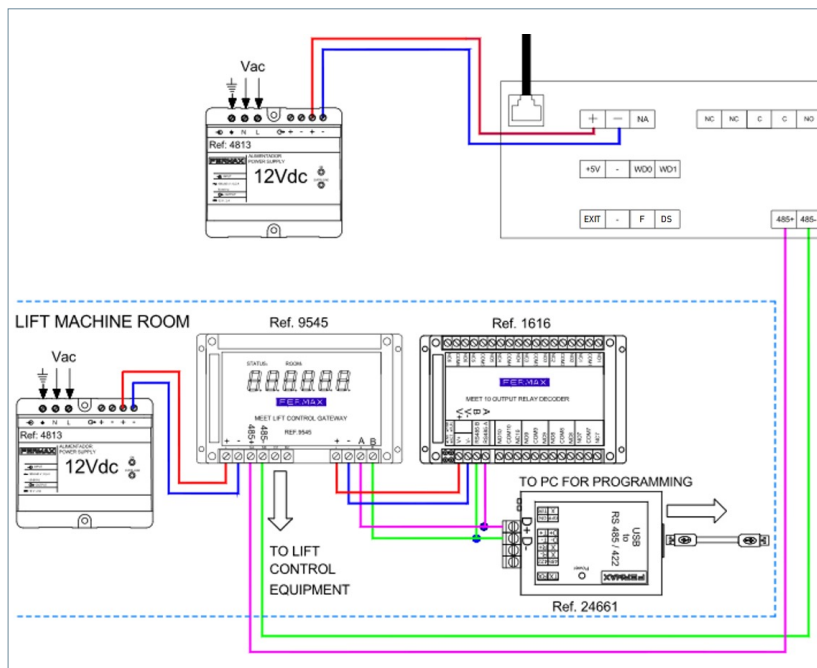

This installation has to be performed in the PANEL n° 1 of the corresponding block only.

TECHNICAL SPECIFICATIONS

| | |
|----------------------------------|-------------------------------------|
| Power supply | 12 Vdc or PoE (*) |
| Standby current | 250 mA (*) |
| With heating resistance ON | 750 mA (**) |
| Working current | 1.000 mA (**) |
| With heating resistance ON | 1.500 mA (**) |
| Display specifications | |
| Size | 10.1 inch |
| Format | 16:9 |
| Resolution | 1.024*600 |
| Camera specifications | |
| Resolución | 1.280 (H)*720 (V) |
| Visual angle | 55° (V), 105° (H) |
| Minimum illumination | 0,5 Lux |
| Maximum conversation time | 120s |
| Door relay time | 1-9s |
| Door delay time | 0-9s |
| Door sensor time | disable, 30s, 60s, 120s, 180s, 250s |
| IC cards | 100.000 cards |
| Face data | 6.000 faces |
| Operating temperature | -40~70 °C |
| Relative humidity | 20%~80%, without condensation |

(*) In cold places below -20°C use a 12 Vdc 2A power supply instead of PoE.

(**) An internal heating resistant is connected automatically when temperature is below -20°C

ANNEX

6.1. FIRMWARE UPDATES

Sometimes it may be necessary or convenient to update a new firmware version because improvements or corrections have been incorporated into its operation.

FERMAX's Technical Department periodically informs (through Communications, Technical Bulletins, etc.) about the release of a new firmware update, as well as the improvements incorporated.

Contact the FERMAX Technical Department if you wish to receive the corresponding update file.

The firmware update is performed via the FERMAX MEET System Upgrading Tool V01.00.exe. The procedure for updating the firmware with the corresponding update file is as follows:

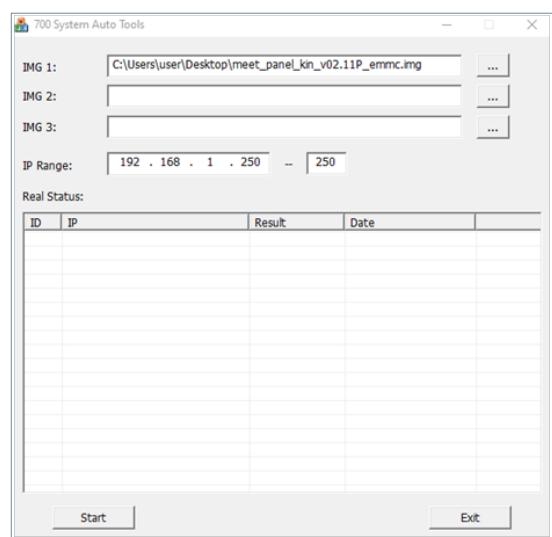

1. Start the FERMAX MEET System Upgrading Tool v1.00.exe.
2. Browse the PC to find the location of the corresponding update file.
3. Indicate the IP of the panels.
4. Select Upgrade.

The new firmware will be installed, and the panel will automatically restart.

6.2. REGULATIONS

Radio frequency module. Ec Declaration of Conformity:

FERMAX ELECTRÓNICA, S.A.U. declara que este producto cumple con los requerimientos de: RED 2014/53/EU Directive "Radio frequency equipment".

<https://www.fermax.com/intl/en/pro/documents/technical-documentation/DT-13-declarations-of-conformity.html>

Radio frequency module:

- Frecuencia: 13.56MHz / Potencia máxima: 2,45mW

This device, pursuant to Part 15 of the FCC Rules. These limits are designed to provide reasonable protection against harmful interference in a residential installation. This equipment generates, uses, and can radiate radio frequency energy, and if not installed and used in accordance with the instructions, may cause harmful interference to radio communications. However, there is no guarantee that interference will not occur in a particular installation. If this equipment does cause harmful interference to radio or television reception, which can be determined by turning the equipment off and on, the user is encouraged to try to correct the interference by one or more of the following measures:

- o Reorient or relocate the receiving antenna.*
- o Increase the separation between the equipment and receiver.*
- o Connect the equipment into an outlet on a circuit different from that to which the receiver is connected.*
- o Consult the dealer or an experienced radio/TV technician for help.*

FERMAX

Avd. Tres Cruces, 133
46017 Valencia
Spain

For more information, visit www.fermax.com

Contact: tec@fermax.com