

MEET

MEET GUARD UNIT F95391

FERMAX

INSTALLER MANUAL

CONGRATULATIONS FOR BUYING A QUALITY PRODUCT!

Fermax Electrónica develops and manufactures premium equipment that meets the highest design and technology standards. We hope you will enjoy all its functions.

*Technical publication for information purposes edited by FERMAX ELECTRÓNICA S.A.U.
FERMAX ELECTRÓNICA applies a continuous improvement policy, therefore it reserves the right to modify the contents of this document, as well as the product features hereof at any time and without prior notice. Any modification will be reflected in subsequent editions of this document.*

This product is protected with the following patents and utility models:

PATENTS: US 9215410, US 9762852, BE1023440, AU2014203706.

UTILITY MODELS: ES1187384U, ES1141495U, FR3038192, DE202016000632U1, CN205987229(U).

INDEX

1.	Product Introduction	4
1.1	Overview	4
1.2	Guard Unit Interface	4
2.	Functions Overview	5
2.1	Call Reception	5
2.2	Call Apartment	7
2.3	Auto ON	8
2.4	Call to Guard Unit	9
2.5	Lift Control	9
2.6	Mode	10
2.7	Call Transfer	12
2.8	Call Forward	13
2.9	Call log	15
2.10	Alarm Log	16
2.11	Settings	17
3.	Configuration via Web Server	19
3.1	Device Information	19
3.2	General Settings	19
3.3	Network Settings	20
3.4	SIP Settings	21
3.5	SIP Call	22
3.6	Advanced Settings	24
3.7	Lift control	27
3.8	Unlock Settings	27
3.9	Installer Pin Settings	28
3.10	Restore	28
4.	Installation	29
4.1	Schematic Diagram of Guard Unit Installation	29
4.2	Connectors	31
4.3	Technical Parameters	31

1. Product Introduction

The following document is the installer manual for the FERMAX MEET Guard Unit, corresponding to the ref.95391 with firmware V03.50.

It is required, when installed in v3.0 MEET installations, to enable “Backward compatibility” function via webserver to ensure the Guard Unit is compatible with the installation.
See chapter 3.2.General Settings. Additionally, in case of installations with mixed Guard Units, 9539 & 95391, master+slaves, it is required 95391 to be configured as a Master Guard Unit.

1.1 Overview



1.2 Guard Unit Interface

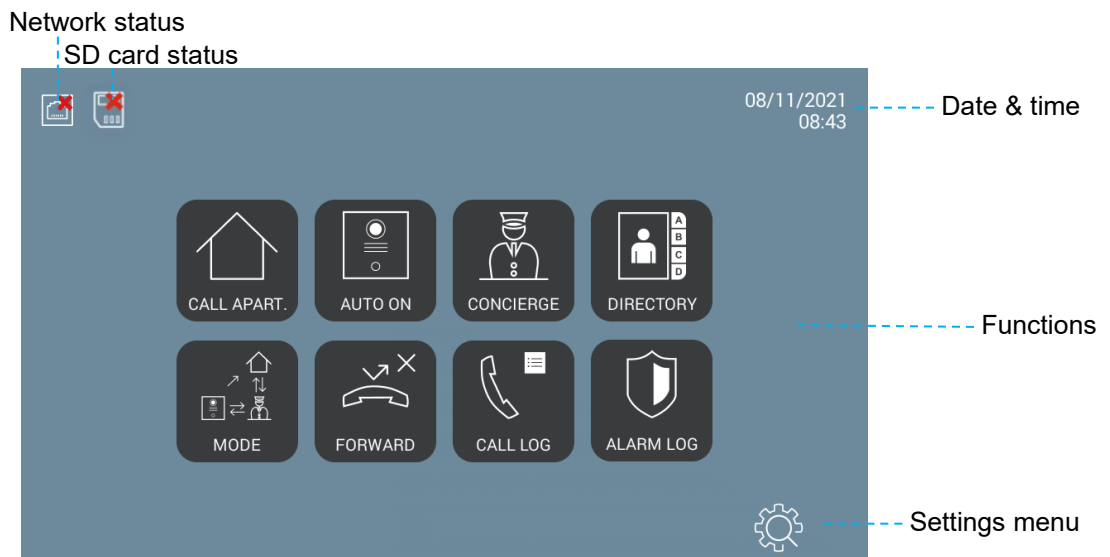

Network status icon will automatically hide once the guard unit has booted and a connection to the network is detected.

SD card status icon will appear in case of enabling any function which requires of the SD card and no SD card is detected, or in case its remaining memory is less than 50MB.

2. Functions Overview

Described functions only apply to a MEET Guard Unit working in “MEET mode”, not in SIP mode. Additionally, Mode, Call Transfer & Call Forward functions will require the rest of MEET devices with a firmware \geq v3.50

2.1 Call Reception

MEET Guard Unit can receive calls from:

- Outdoor panels (communication + taking pictures -if available- + lock release)
- Monitors (communication only)
- Other Guard Units from the same installation*

MEET Guard Unit with the same “number” (**CONCIERGE NO**, i.e., 9901, please see Config, *General Settings*) and different “extensions” (**DEVICE NO**, i.e., 0 and 1) can’t call each other.

Maximum duration of any call is 120 seconds. This time can’t be modified.

Default Guard Unit interface when receiving a call from an outdoor panel:

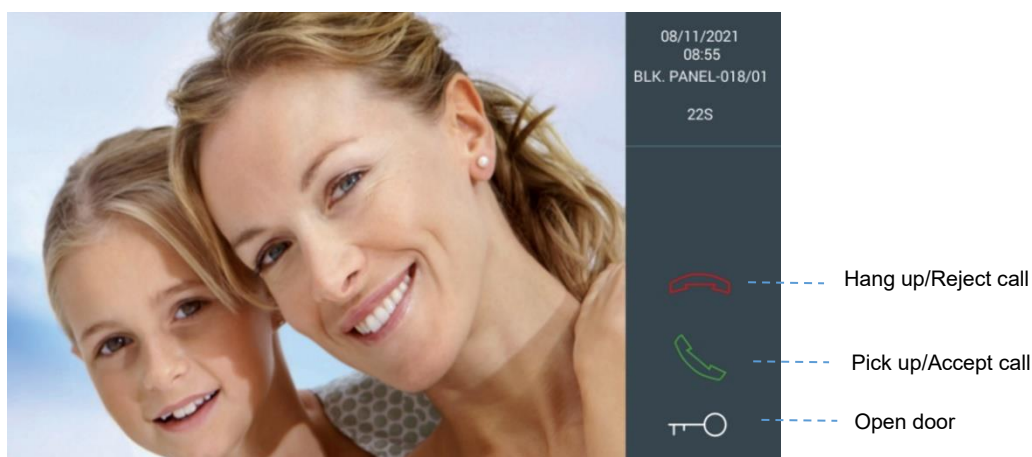

By touching the icon , the concierge can establish communication with the caller.

The Guard Unit interface will display an icon  for volume control.

Guard Unit interface once communication with an outdoor panel has been established:

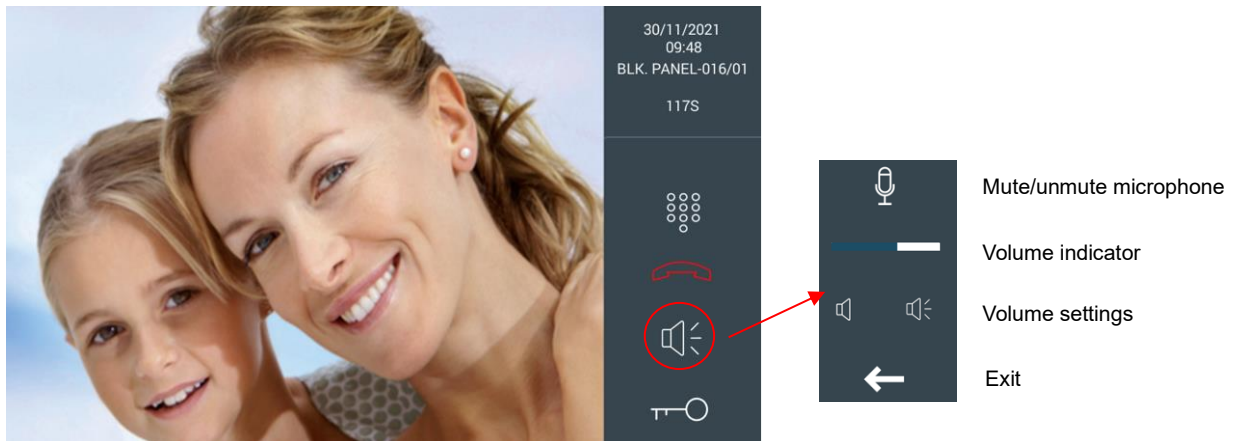

In case there are additional doors other than the main door (up to 4, to be configured via webserver), touching “Open door” icon will display more options at the bottom of the screen. Click on the one corresponding to the door to be opened.

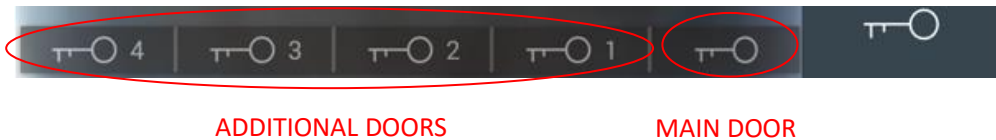

ADDITIONAL DOORS

MAIN DOOR

In case additional cameras exist (up to 4, to be configured via webserver), a three dots icon will appear on the control panel. By pressing on it, more options will appear at the bottom of the screen. Tap on the corresponding one to change the camera to be displayed.

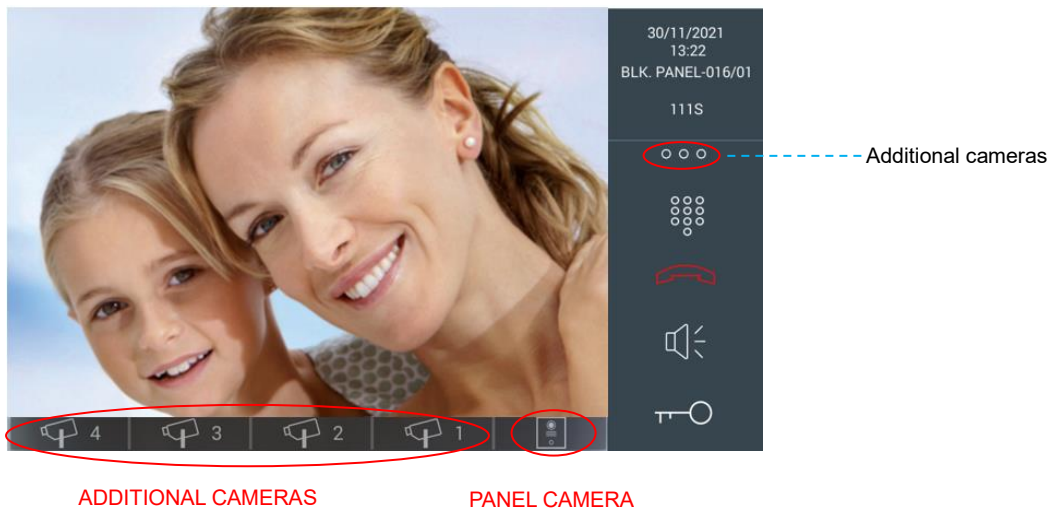

ADDITIONAL CAMERAS

PANEL CAMERA

2.2 Call Apartment

This action can be done:

- A) Using “Call to Apartment” menu
- B) Via “Directory” (if enabled)





Call to Apartment menu





The number/digits to enter will depend on how the Guard Unit has been configured, and if mapping call function is enabled or not (please see *Advanced Settings*):

A) General Guard Unit

- Able to call to any apartment
- Number to enter =
 - Mapping call disabled
Block number (i.e., 16) + Apartment number (i.e., 3001), then 
 - Mapping call enabled and apartment not included in mapping call list
Block number (i.e., 16) + Apartment number (i.e., 3001), then 
 - Mapping call enabled and apartment included in mapping call list
1 to 8 digits (0-9,A-H), then 

B) Block Guard Unit

- Able to call to any apartment in the same block
- Number to enter =
 - Mapping call disabled
Apartment number (i.e., 3001), then 
 - Mapping call enabled and apartment not included in mapping call list
Apartment number (i.e., 3001), then 
 - Mapping call enabled and apartment included in mapping call list
1 to 5 digits (0-9,A-H), then 

It is possible to know how the Guard Unit is configured, General or Block, via “Settings” > “About”.



Directory

This function must be enabled via webserver (please see *Advanced Settings*). Otherwise, it will show a “FUNCTION NOT ACTIVATED” message.



Select one apartment and press call icon.

It is possible to select the letter of the right side to filter the names by its first letter.

2.3 Auto ON



This function allows the concierge to begin a communication with a panel, without requiring a previous call from a visitor.

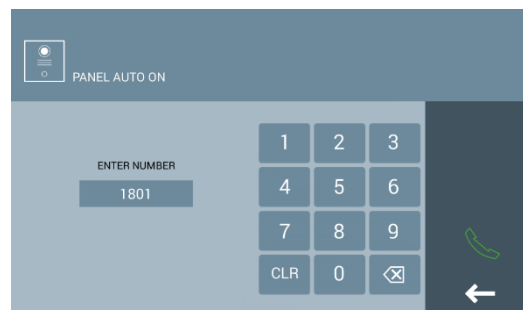

The numbers to enter will depend on how the Guard Unit has been configured:

A) General Guard Unit

- Able to call to any block panel
- Number to enter = Block number (BBB) + Panel number (PP), i.e.: 00101, then 

B) Block Guard Unit

- Able to call to any panel of the same block
- Number to enter = Panel number (i.e.: 1), then 

It is possible to know how the Guard Unit is configured, General or Block, via “Settings” > “About”. The concierge cannot perform auto on to General Entrance panels or 1W panels.

2.4 Call to Guard Unit



MEET Guard Units can call any other available guard units in the installation.

To call a certain MEET Guard Unit, the concierge must enter the number of a different Guard Unit (9901, 9902, 9903, etc.) and press call button.

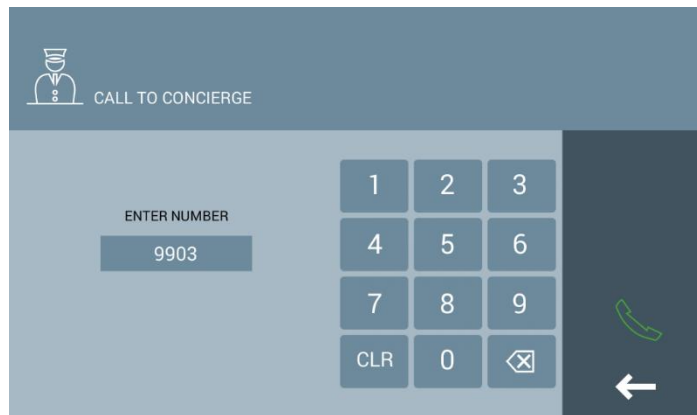

MEET Guard Units with the same “number” (**CONCIERGE NO**, i.e., 9901, please see Config, *General Settings*) and different “extensions” (**DEVICE NO**, i.e., 0 and 1) can’t call each other.

2.5 Lift Control

Two available options:

A) Unsupervised Lift control

The concierge can activate “Lift to floor” function, without requiring a previous confirmation from the apartment.

Once enabled via webserver, a “Lift” button will appear in “Call to Apartment” and “Directory” (if enabled) menus.

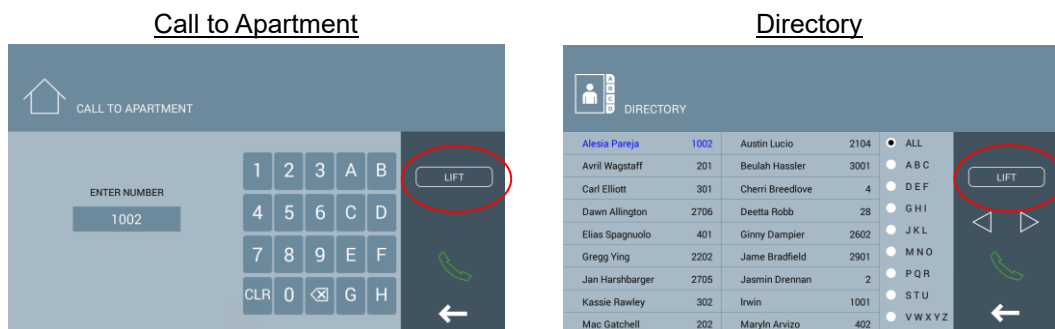

Pressing “Lift” button will cause the visitor can use the Lift to the corresponding floor.

B) Supervised Lift control

The concierge can only activate “Lift to floor” function once the apartment has been called and communication guard-tenant finishes. At this moment, the following menu will be displayed for authorizing to lift or not:

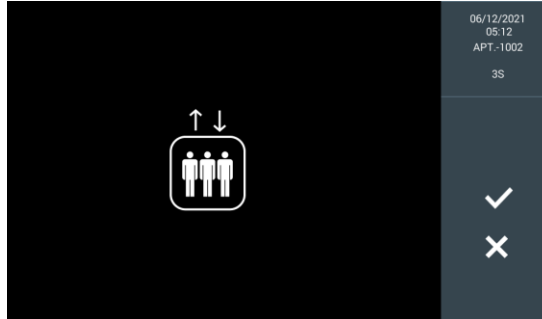

These functions must be enabled via webserver (please see *Lift control*).

A No. 1 Block panel is required. Otherwise, “LIFT CONTROL ERROR” message will be shown when trying to use LIFT CONTROL function.



2.6 Mode

This function allows to change MEET Guard Unit working mode. Four available modes:

Mode	Icon	Description
Day		<ul style="list-style-type: none"> All calls from the panels are intercepted by the Guard Unit Apartments and panels can call directly to the Guard Unit
Mixed w/o monitoring		<ul style="list-style-type: none"> Calls from panels to apartments will not go through the Guard Unit Apartments and panels can call directly to the Guard Unit
Mixed with monitoring		<ul style="list-style-type: none"> Panel calls to the apartment. In case there is no answer in 15 seconds, the monitor stops ringing and MEET Guard Unit will start ringing. From this moment, the guard can pick up the call Apartments and panels can call directly to the Guard Unit
Night		<ul style="list-style-type: none"> The concierge will not receive any calls. Direct call from panels to apartments Apartments and panels will show a message CONCIERGE IS OUT OF SERVICE if the concierge is called

The concierge can change current mode by selecting “Mode” button in Main interface, and then entering concierge password (1111 by default).

Once entered, a submenu will be displayed for changing actual mode. Current active mode button will show a white border, while non-active modes will not.

In case of selecting “Mixed” mode, a new submenu will be shown for enabling (green icon) or disabling (red icon) monitoring function.

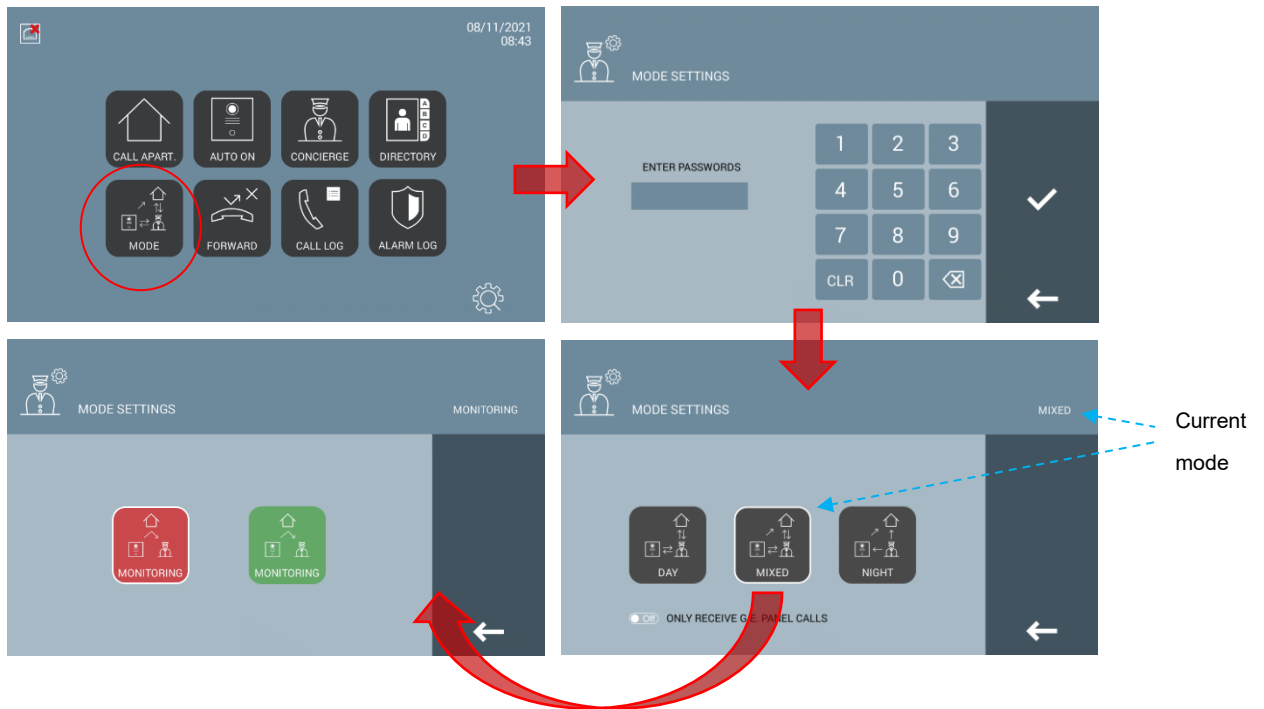

Once a mode is selected, MEET Guard Unit will send the new mode to its corresponding panels. Mode of a “General Guard Unit” is sent to all panels, while mode of a “Block Guard Unit” is only sent to the panels in the same block.

Different MEET Guard Units with the same number (i.e., 9901) and different extensions (0,1...) will always synchronize their mode according to the latest mode selected from any of them.

In case MEET Guard Unit goes offline, the rest of the panels will automatically change to Mixed w/o monitoring mode after some minutes. Once it goes online again, MEET Guard Unit mode will be restored to its latest mode after some minutes.

ONLY RECEIVE G.E. PANEL CALLS

Only available in case MEET Guard Unit has been configured as a “General Guard Unit”.

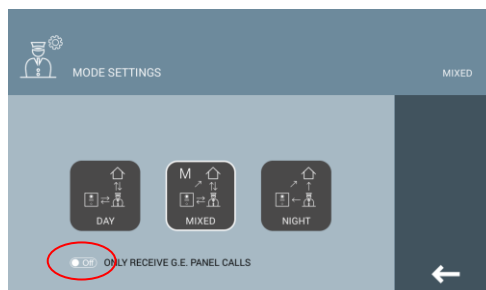

- OFF: General Guard Unit can be called by block panels
- ON: General Guard Unit can't be called by any block panel

2.7 Call Transfer

This function gives the concierge the ability to transfer a call from a panel, answered or not, to an apartment, via apartment number or Directory (if enabled).

The concierge can:

- A) Directly transfer the call -without calling to the apartment-, via “Direct transfer” button
- B) Call the apartment and, once the tenant agrees, establish a communication between door and apartment. In case the tenant doesn’t agree, the Guard Unit will automatically resume the conversation with the caller.

Auto ON calls (MEET Guard Unit to panel) can be transferred too.

Transfer capabilities are limited to how MEET Guard Unit is configured:

- “General Guard Unit” can transfer calls to all apartments in the installation
- “Block Guard Unit” can transfer calls to apartments in the same block

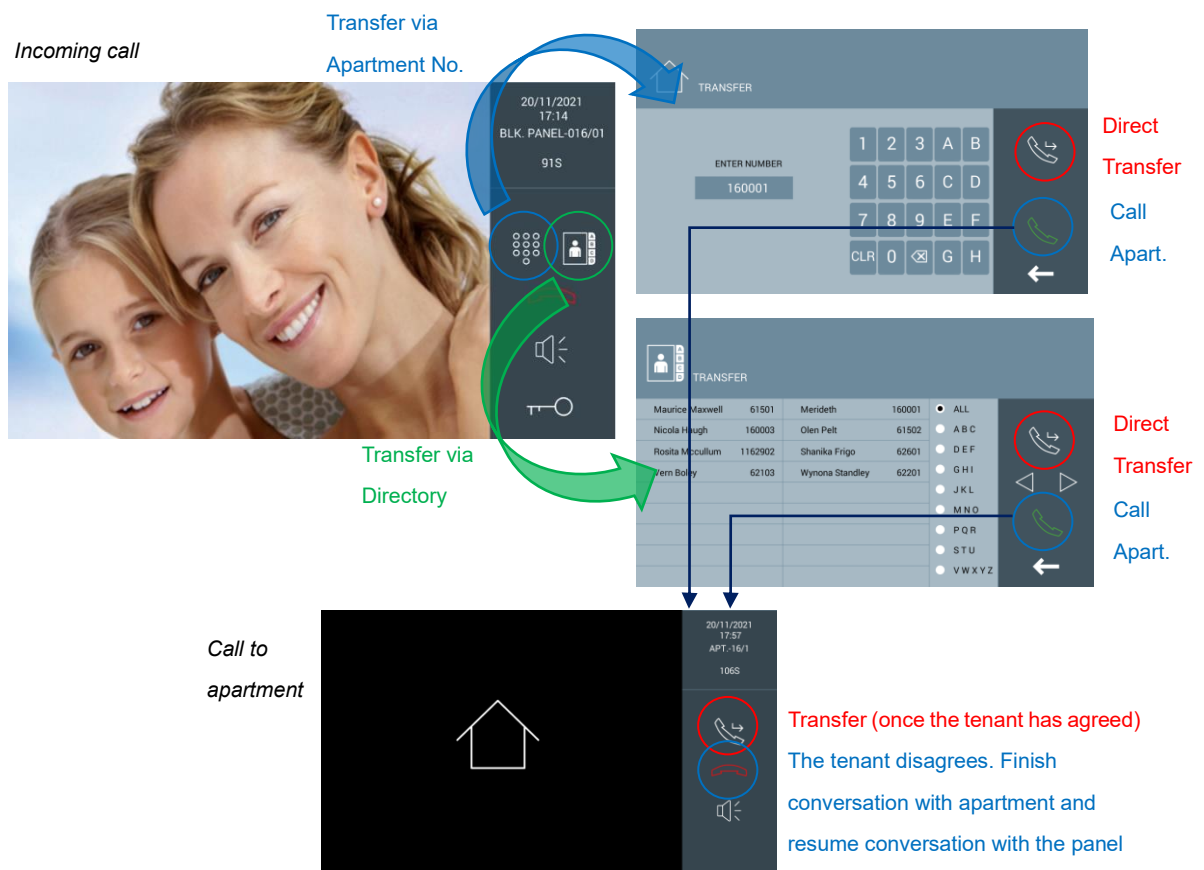

Please see *Call Apartment* section for more information about how to enter apartment number or Directory usage.

Maximum conversation time (panel+concierge+apartment) is 120 seconds.

2.8 Call Forward



This function allows the concierge to forward all the calls from panels, monitors, or other guard units. Actual status, enabled or disabled, is displayed in MEET Guard Unit main menu:

Call Forward Enabled	Call Forward Disabled
 FORWARD	 FORWARD

The concierge can enable/disable Forward function and change Forward settings by selecting “Forward” button in the main interface and entering concierge password (1111 by default).

Forward function settings

It is required to manually disable Forward function before changing call forward settings.

MEET Guard Unit can forward calls to:

- A) A single concierge number (9901, 9902...), which will act as a “*DESIGNATED GUARD UNIT*”
- B) MEET ME



Once settings are saved and Forward function is enabled, both Origin (“Forwarder”) and Designated (“Receiver”) Guard Units will show information regarding actual Forward settings:

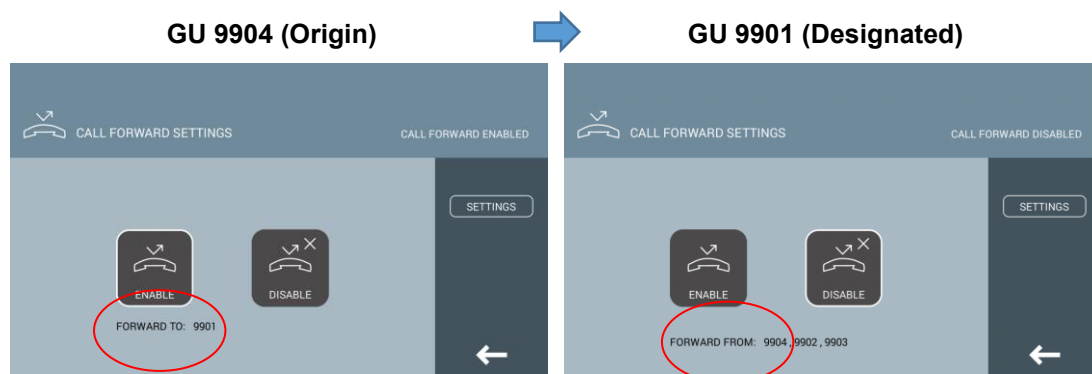

From that moment, all the calls received in the *Origin Guard Unit* will be forwarded to the *Designated Guard Unit*. In case of receiving a forwarded call, the call log of *Designated Guard Unit* will show the number of the *Origin Concierge*.

Designated Guard Unit can act as an *Origin Guard Unit* at the same time and forward its own received calls to other guard units or MEET ME. Calls received via Forward function can't be re-forwarded to a third MEET Guard Unit.

GU 9901 (Designated+Origin)

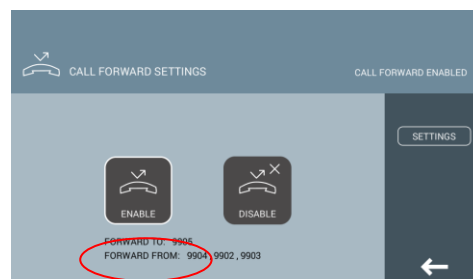

In case the *Origin Guard Unit* is configured as a “General Guard Unit” and the *Designated Guard Unit* is configured as a “Block Guard Unit”, the “Block Guard Unit” will be able to receive calls from panels, monitors... different to the ones of its own block.

Forwarding requires both MEET GU, *Origin* and *Designated*, not to be in *Night mode*.

REMARKS:

1. A General Guard Unit can act as a Designated Guard Unit. This designation has priority over **ONLY RECEIVE G.E. PANEL CALLS** setting.
2. The numbers of Origin & Designated Guard Units must be different.
3. In case a block panel calls to a Designated GU, the Designated GU can only transfer the call to the apartments of the same block.

2.9 Call log



MEET Guard Unit allows to have a clear view of all the call history via Call Log function.

Forward from No.9903 Concierge No.9902 answered

Date	Time	Direction	Number	Attachment
07/12/2021	06:09	Outgoing	BLK. PANEL-016/01	
07/12/2021	06:07	Incoming	BLK. PANEL-016/01[9902]	
07/12/2021	06:07	Incoming	BLK. PANEL-016/01	
07/12/2021	06:06	Incoming	[9903]BLK. PANEL-016/01	
07/12/2021	06:05	Incoming	APT.-16/1	
07/12/2021	06:05	Incoming	APT.-16/1	
07/12/2021	06:04	Incoming	BLK. PANEL-016/01	
07/12/2021	06:04	Incoming	APT.-16/1	
07/12/2021	06:04	Incoming	BLK. PANEL-016/01	

Annotations: Outgoing call, Incoming call, Transfer to Apt.-16/1, Attachment

Calls with no interaction with MEET Guard Unit are not logged: panel to apartment, apartment to apartment, calls to a different Guard Unit ...

Missed calls

The concierge can, in case of observing there is a missed call, to call back via Call Log.

07/12/2021 06:18

CALL LOG

Missed calls

Show only "Missed calls" (optional)

07/12/2021 06:18 BLK. PANEL-016/01

07/12/2021 06:18 BLK. PANEL-016/01

07/12/2021 06:09 BLK. PANEL-016/01

07/12/2021 06:07 BLK. PANEL-016/01

07/12/2021 06:07 BLK. PANEL-016/01

07/12/2021 06:06 [9903]BLK. PANEL-016/01

07/12/2021 06:05 APT.-16/1

07/12/2021 06:05 APT.-16/1

07/12/2021 06:04 BLK. PANEL-016/01

NO ATTACHMENTS

MISSED RECORDS

07/12/2021 06:18 BLK. PANEL-016/01

07/12/2021 06:18 BLK. PANEL-016/01

06/12/2021 05:00 BLK. PANEL-018/1/A

03/12/2021 07:09 [9907]CONCIERGE

03/12/2021 07:09 BLK. PANEL-066/07

03/12/2021 04:22 [9903]BLK. PANEL-066/01

03/12/2021 04:22 [9903]BLK. PANEL-066/01

03/12/2021 04:19 [9903]BLK. PANEL-066/01

03/12/2021 04:14 BLK. PANEL-066/01

Call back is not available for general entrance panels.

Deleting records

It is possible to delete all the records or one by one using “Trash icon”.

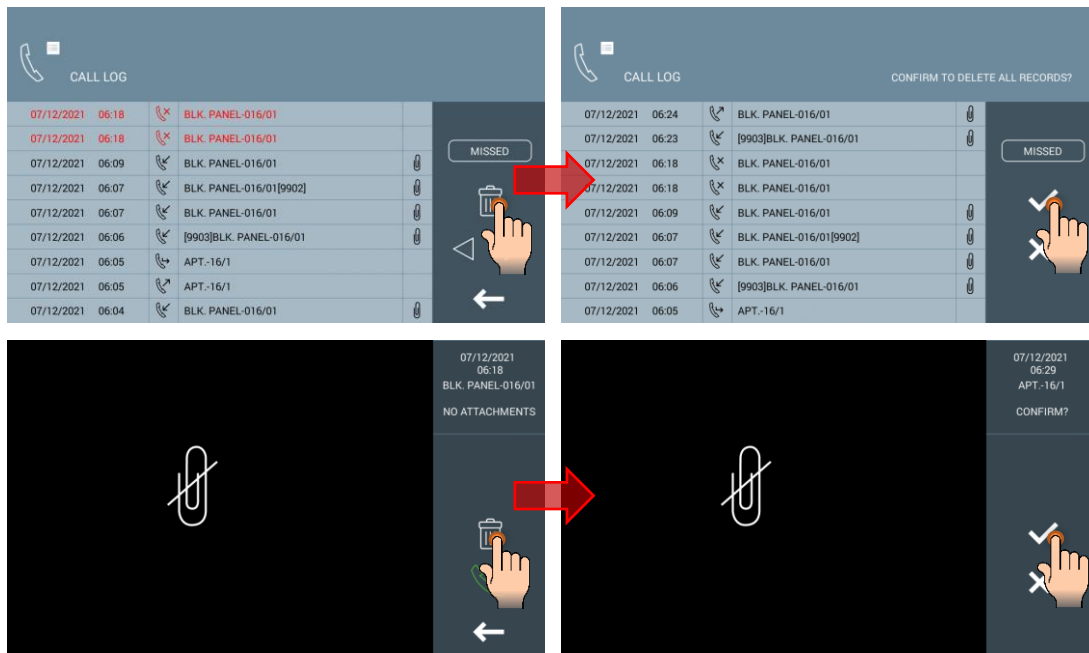

Maximum 128 call logs. The oldest call logs will be replaced by newest call logs.

2.10 Alarm Log



MEET Guard Unit includes a LED and a siren which will be activated after receiving an alarm notification from a monitor or a panel (tamper, door sensor, etc.)

Both LED and siren will turn off after the guard touch CONFIRM button.

In case Guard Unit's volume is zero then alarms will only activate the led.

The alarm events can be found at the ALARM LOG menu. Each record includes date and time, source and triggered zone. It is not possible to delete complete log nor individual registers.

Date	Time	Source	Zone
16/11/2021	07:18	BLK. PANEL-066/01	DOOR FORCED ALARM
16/11/2021	07:11	APT.-66/1	ZONE 6 PANIC
16/11/2021	07:11	APT.-66/1	ZONE 5 WINDOW
16/11/2021	07:11	APT.-66/1	ZONE 4 DOOR
16/11/2021	07:11	APT.-66/1	ZONE 3 IR
16/11/2021	07:11	APT.-66/1	ZONE 2 GAS
16/11/2021	06:39	1W-66/1/1	DOOR FORCED ALARM
16/11/2021	06:33	1W-66/1/1	DOOR FORCED ALARM
16/11/2021	06:30	1W-66/1/1	DOOR ALARM

This function can be enabled or disabled via webserver (please see *Advanced Settings*).

A maximum of 450 alarm logs is recorded. The oldest alarm logs are replaced by the newer ones.

2.11 Settings

MEET Guard Unit Settings can be modified via Settings menu.



Setting	Description	Picture
Sound	Options: <ul style="list-style-type: none"> • Ringtone • Click tone • Volume 	
Screen	Options: <ul style="list-style-type: none"> • Brightness 	
Language		
Date and Time	Options: <ul style="list-style-type: none"> • Date format • Time zone • DST <p>Please see below for additional information</p>	
Functions	Please see below for additional information	
Password	Used in Mode & Forward functions Default password: 1111	

About	Information: <ul style="list-style-type: none"> • Firmware • Type of device, number, and extension • MAC • IP address 	
-------	---	--

Date/Time Setting

A) Automatic

- Requirement: Internet connection or MEET MANAGEMENT SOFTWARE
- Time Zone to be configured

B) Manual

- Offline Guard Unit
- Time Zone not to be configured
- Date and time not saved in case of power failure

Function Setting

Function
MISSED CALL FROM PANEL RECORDING (VIDEO) / Panels' Answering Machine
MISSED CALL FROM APARTMENT RECORDING (AUDIO) / Apartments' Answering Machine
CONVERSATION WITH APARTMENT RECORDING (AUDIO)
AUTOMATIC PANEL PICTURE CAPTURE (3 pictures during call: 28 sec, 26 sec and 24 sec.)
MANUAL PANEL PICTURE CAPTURE

Manual and Automatic picture capture functions will momentarily stop the video, so the concierge knows a snapshot has been taken.

Audio and Video recording functions require an SD card (not included).

Audio volume of recording will depend on the latest volume adjusted during conversation.

SD card requirements:

- Maximum capacity: 128GB
- Class 4
- Format: FAT32, exFAT, NTFS

An icon indicating there is no SD card will appear in main menu once remaining memory is lower than 50MB.

Records must be manually deleted via *Call log* menu.

Maximum number of pictures stored in MEET Guard Unit is 384 (manual + automatic -128 call logs x 3 pictures-).

3. Configuration via Web Server

MEET Guard Unit has an integrated web server for its configuration. Chrome web browser is recommended.

Default IP: 10.201.100.0
Username: admin
Password: 123456

3.1 Device Information

The following information is displayed: device name, firmware version, device info, MAC address and IP address.



The screenshot shows the FERMAX web interface. At the top, there is a blue header with the FERMAX logo and the text "MEET VIDEO DOOR ENTRY SYSTEM". Below the header is a navigation menu with buttons for "DEVICE", "GENERAL", "NETWORK", "SIP", "SIP CALL", "ADVANCED", "LIFT CONTROL", "UNLOCK", "PINCODE", and "RESTORE". To the right of the menu, the "DEVICE INFO" section is displayed, showing the following information: FERMAX MEET CONCIERGE, FIRMWARE: V03.50AB, DEVICE: GENERAL CONCIERGE 9910-0, MAC: BC:F8:11:01:CB:AD, IP: 192.168.6.74, COPYRIGHT © FERMAX ELECTRONICA S.A.U, and www.fermax.com.

3.2 General Settings

CONCIERGE TYPE: Select the identification parameter of the guard unit. There are some other parameters related, depending on TYPE selection:

GENERAL CONCIERGE

Concierge installed in the control central or one of the main entrances.

CONCIERGE TYPE:	<input type="text" value="GENERAL CONCIERGE"/>
CONCIERGE NO.:	<input type="text" value="9901"/>
DEVICE NO.:	<input type="text" value="0"/>
DEVICE TAG:	<input type="text" value=""/> (≤ 16 CHARACTERS)

CONCIERGE NO.: Guard unit number, 9901 to 9998 (default option 9901).

DEVICE NO.: Guard unit extension, 0 to 7 (default option 0, Master GU).

In case there is only one guard unit, its device number must be 0.

Extensions can't be repeated. Guard units with the same CONCIERGE NO. and different DEVICE NO. will ring at the same time.

DEVICE TAG: Text to be shown in any monitor or other guard unit.

BLOCK CONCIERGE

Guard unit installed in a single building or in a block of a condominium.

CONCIERGE TYPE:	BLOCK CONCIERGE	▼
BLOCK:	16	
CONCIERGE NO.:	9901	
DEVICE NO.:	0	
DEVICE TAG:		(≦ 16 CHARACTERS)

BLOCK: Number assigned to the block where the guard unit has been installed (1-999).

CONCIERGE NO.: Guard unit number, 9901 to 9998 (default option 9901).

DEVICE NO.: Guard unit extension, 0 to 7 (default option 0, Master GU). In case there is only one guard unit, its Device No. must be 0. Extension numbers can't be repeated. Guard units with the same CONCIERGE NO. and different DEVICE NO. will ring at the same time.

DEVICE TAG: Text to be shown in any monitor or other guard units.

SYNC CODE: Synchronization code between guard units with the same concierge no.

BACKWARD COMPATIBILITY: Modes, Forward call and Transfer call will not available if this function is enabled. For installations <V3.5.

DEVICE	GENERAL SETTINGS
GENERAL	CONCIERGE TYPE: GENERAL CONCIERGE ▼
NETWORK	CONCIERGE NO.: 9910
SIP	DEVICE NO.: 0
SIP CALL	DEVICE TAG: (≦ 16 CHARACTERS)
ADVANCED	SYNC CODE: 123456
LIFT CONTROL	BACKWARD COMPATIBILITY: <input type="checkbox"/> (<V3.5)
UNLOCK	SAVE
PINCODE	
RESTORE	

3.3 Network Settings

MEET allows the installer to define the IP range according to the project needs and make the network management easier. MEET Guard Unit network mode is static mode. Ensure that each device has a unique IP address in the installation. Devices (panel, monitor and guard unit) will show IP conflict in case there are two or more devices with the same IP address.

IP: IP address of the guard unit (default option 10.201.100.0).

MASK: Subnet mask of the guard unit (default option 255.0.0.0).

GATEWAY: Default gateway of the guard unit (default option 10.254.0.1).

DNS: DNS of the guard unit (default option 8.8.8.8).

SOFTWARE IP: IP address of PC where MMS is installed. (Default 10.0.0.200).

SW. PIN: Pin code in case the guard unit is registered in MEET management software.

NETWORK SETTINGS

IP: 192.168.6.100
MASK: 255.255.255.0
GATEWAY: 192.168.6.1
DNS: 8.8.8.8
SOFTWARE IP: 192.168.6.230
SW. PIN:

SAVE

3.4 SIP Settings

ENABLE SIP: Enable or disable SIP function

SEARCH SIP STATUS: This button appears when enable SIP function. Result:

- A) **SIP REGISTERED** if the register is successful or
- B) **SIP REGISTER FAILED** if the register is unsuccessful.

SIP SERVER: SIP server IP address.

DOMAIN: Sip server domain.

OUTBOUND: Some servers are used when NAT.

STUN IP: Audio and video NAT traversing public network server IP.

STUN PORT: The port of audio and video NAT traversing public network server.

SIP USER: The username of sip account.

SIP PASS: The password of sip account.

CONVERSATION: No function.

When the guard unit is used as a SIP device, SIP function must be enabled and all SIP parameters corresponding to the used SIP server must be configured.

SIP SETTINGS

ENABLE SIP: [SEARCH SIP STATUS](#)
SIP SERVER: sip.sip.fermax.com
DOMAIN: sip.fermax.com
OUTBOUND:
STUN IP:
STUN PORT: 5060
SIP USER: 0994624
SIP PASS:

CONVERSATION: 120S

SAVE

3.5 SIP Call

This option allows to generate direct calls to smartphones in installations without MEET monitors, or in case it is required to make a call to an additional SIP device via SIP protocol (i.e.: VoIP telephone) other than a MEET device. In case of installations with MEET monitors, this menu should remain empty, and call forward should be configured directly on each monitor. Direct calls to apartments require a FERMAX MEET ME licence Ref. 1496 per each apartment. Calls to MEET ME licenses can be received in up 8 smartphones simultaneously.

A csv file containing the associated apartment numbers and SIP calls to be done must be uploaded to the concierge.



The procedure to generate and update the csv file is as follows:

1. Press EXPORT to generate a blank csv table and save it to your PC.
Rename this table as your choice or leave the default name (MEET CALL DIVERT G99XY.csv, XY is the device number assigned to this concierge).
2. Use [Notepad++](#) or any other similar text editor to open downloaded file.

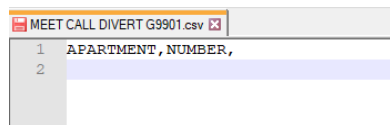

3. The first row contains the headers: APARTMENT, NUMBER. Do not change it.
4. Use the following rows (2, 3, 4, etc.) to fill in the data of required SIP calls.

Data to be included will depend on desired type of call:

- a. Call to a FERMAX MEET ME LICENCE:
APARTMENT, sip:XXXXXXX@sip.fermax.com where XXXXXXX is the licence name and APARTMENT is the number to dial in the concierge.
- b. Call to a third-party SIP device (via SIP server or P2P):
APARTMENT, sip:user@IP_SIP_SERVER where user is the identification

user (extension) of a certain SIP device in a SIP server, and IP_SIP_SERVER is the IP address of the SIP server.

or **APARTMENT, sip:anynumber@DEVICE_IP_ADDRESS** (P2P call)

It is also possible to assign multiple and different divert formats to the same apartment (for example, a parallel call to a third-party SIP device and a smartphone device). Use the corresponding format explained above, using the same row and different column for each call. See example below.

Please remember P2P calls to MEET monitors are executed directly, so there is no need to declare them.

Other functions like sequential call requires of a SIP server.

5. Once the table has been finished, save it, and press “Choose file” button, select the file to import and press IMPORT button.

Wait a few seconds until a pop-up message “UPLOAD SUCCESSFUL” appears.

Example

- Pressing “101” must call to MEET ME license 1234567
- Pressing “102” must call to SIP telephone 1 (ext. 500) registered in a local SIP server with IP address 192.168.1.150
- Pressing “103” must call to MEET ME license 7654321 and SIP telephone 2 192.168.1.152
- Pressing “104” must call to MEET ME licenses 7654000, 7654001 and 7654002

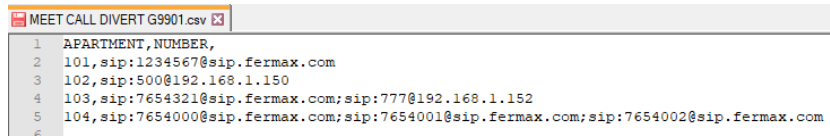

```
MEET CALL DIVERT G9901.csv
1 APARTMENT,NUMBER,
2 101,sip:1234567@sip.fermax.com
3 102,sip:500@192.168.1.150
4 103,sip:7654321@sip.fermax.com;sip:777@192.168.1.152
5 104,sip:7654000@sip.fermax.com;sip:7654001@sip.fermax.com;sip:7654002@sip.fermax.com
6
```

Please remember that, additionally to these calls, a MEET P2P call will always be executed to apartments 101-104 without requiring to include any additional configuration.

REMARKS:

1. A maximum of 1000 rows can be imported.
2. In case the call divert list is empty or with invalid data, the webserver will show IMPORT ERROR OR BLANK FILE, PLEASE CHECK when the list is imported

3.6 Advanced Settings

ALARM: Enable or disable alarm function reception. When the function is disabled, the concierge will not receive any alarm information.

DIRECTORY: The concierge can use a directory for calling apartments. The concierge can select the apartment's name from this directory and call directly without knowing its apartment number.

A .CSV table with the name of the tenants and apartment numbers must be created.

The operation procedure to generate and update the .CSV file is as follow:

1. Press EXPORT to generate a blank .CSV table, an save it to your PC.
Rename this table as your choice or leave the default name.
2. Use [Notepad++](#) or any other similar text editor to open the file downloaded:

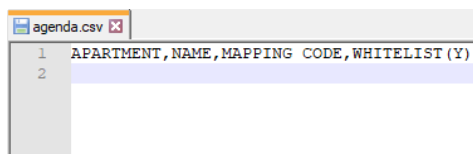

```

agenda.csv
1 APARTMENT,NAME,MAPPING CODE,WHITELIST(Y)
2
  
```

3. The first row contains the headers of required information: APARTMENT, NAME, MAPPING CODE and WHITELIST(Y). Do not change it.
4. Use the following rows (2, 3, 4...) to fill in required data, each one in a different row.
The 4 commas must always exist per each row.
5. Once the table has been finished, save it, and import to the device by pressing “Choose file” to import, select the file and click on IMPORT button.

Wait for a few seconds until a pop-up message “UPLOAD SUCESS” appears.

Uplodaded agenda



```

agenda.csv
1 APARTMENT,NAME,MAPPING CODE,WHITELIST(Y),
2 1,Merideth Semmes,,,
3 2,Jasmin Drennan,,,
4 4,Cherri Bredove,,,
5 201,Avril Wagstaff,,,
6 202,Mac Gatchel,,,
7 301,Carl Elott,,,
8 401,Elias Spagnudo,,,
9 402,Marilyn Arvizo,,,
10 1001,Irwin Schoemaker,,,
11 1002,Alesia Pareja,,,
12 2104,Austin Lucio,,,
13 2202,Gregg Ying,,,
14 2602,Ginny Dampier,,,
15 2705,Jan Harshbarger,,,
16 2706,Dawn Allington,,,
17 28,Deetta Robb,,,
18 2901,Jame Bradfield,,,
19 3001,Beulah Hassler,,,
  
```

Result

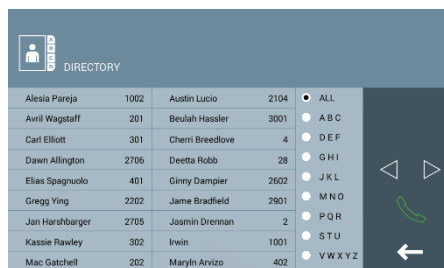

In the case of non-Latin alphabets (for example: Chinese, Russian / Cyrillic, Arabic, Hebrew etc.), the procedure is as follows:

1. From the web server of the concierge, export the **empty .CSV file**.
2. Open with Windows Notepad and copy the directory list of the CSV file in the notepad with the desired alphabet (Latin, Chinese, Russian / Cyrillic, Arabic, ...).
3. Save the file as **.CSV / all files *. * / UTF-8**
4. From the guard unit's webserver, import this file and wait for the message "file uploaded successfully" to be displayed.

REMARKS:

1. A maximum of 1000 rows can be imported.
2. If the agenda list is empty or with invalid data, the web will show IMPORT ERROR OR BLANK FILE, PLEASE CHECK when the list be imported, the valid data still can be imported.

MAPPING CALL: The installer can create a mapping call list. Mapping call code can include numbers and letters (A-H). For block guard unit, 1 to 5 digits is allowed, for general guard unit, 1 to 8 digits is allowed. In case an apartment doesn't have an assigned mapping code, it can be called via its apartment number. Example:

```

agenda_Mapping_call.csv
1 APARTMENT,NAME,MAPPING CODE,WHITELIST(Y),
2 102,Jasmin Drennan,1,,
3 202,Austin Lucio,2,,
4 444,Olen Pelt,3,,

```

WHITELIST: If this function is enabled, the guard unit can only call to a certain apartment if it has been previously declared in the directory and setted to Y (YES). Otherwise, it can't be called (via Directory nor Call to Apartment). Please do not use "N" (NO), the upload will fail.

Uplodaded agenda

Result (whitelist enabled)

```

agenda.csv
1 APARTMENT,NAME,MAPPING CODE,WHITELIST(Y),
2 1,Merideth Semmes,,Y,
3 2,Jasmin Drennan,,Y,
4 4,Cherri Bredove,,Y,
5 201,Avril Wagstaf,,Y,
6 202,Mac Gatchel,,Y,
7 301,Carl Elott,AB3,Y,
8 401,Elias Spagnudo,,
9 402,Marilyn Arvizo,,Y,
10 1001,Irwin Schoemaker,,Y,
11 1002,Alesia Pareja,AAA,Y,
12 2104,Austin Lucio,,Y,
13 2202,Gregg Ying,,Y,
14 2602,Ginny Dampier,,
15 2705,Jan Harshbarger,,Y,
16 2706,Dawn Allington,,
17 28,Deetta Robb,,
18 2901,James Bradfield,,Y,
19 3001,Beulah Hassler,,Y,

```

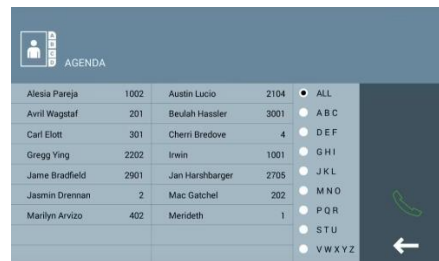

Hidden in the Agenda.

Can't be called via Call to Apt. menu

ALPHANUMERIC KEYPAD: Enable this function in case it is required to use the alphanumeric call. Available characters when enabled are A to H.

Characters usage will depend on if mapping call function is enabled or not.

A) **MAPPING CALL disabled:** The device will convert character A to 1, B to 2, etc.

agenda_Mapping_call.csv	
1	APARTMENT, NAME, MAPPING CODE, WHITELIST (Y),
2	102, Jasmin Drennan, 10A, Y,
3	202, Austin Lucio, 10B, Y,
4	444, Olen Pelt, 22D, Y,

↑ 10A = Call to apt. 101
 → 10B = Call to apt. 102
 ↓ 22D = Call to apt. 224

B) **MAPPING CALL enabled:** The guard unit will do the conversion according to uploaded directory.

agenda_Mapping_call.csv	
1	APARTMENT, NAME, MAPPING CODE, WHITELIST (Y),
2	102, Jasmin Drennan, 10A, Y,
3	202, Austin Lucio, 10B, Y,
4	444, Olen Pelt, 22D, Y,

↑ 10A = Call to apt. 102
 → 10B = Call to apt. 202
 ↓ 22D = Call to apt. 444

SIP EXTENSION: Enable or disable sip extension function. This functionality allows a different SIP device (a MEET ME license, generally) to be called. When a panel or monitor calls to the Guard unit, enabled SIP extensions will ring too. Once any of them answers the call, the rest of devices will stop ringing. The maximum amount of SIP extensions is 2.

URL: sip: sip account @IP address of sip server

NUMBER OF CAMERAS: Numbers of IP cameras related to the panel that will be available to switch during a panel call. (0-4 optional).

RTSP: Enable or disable RTSP function.

When the guard unit calls to a monitor or to another guard unit, the associated IP CCTV RTSP video stream will be displayed in the monitor or guard unit.

URL: rtsp://user:password@IP address of camera

This is the URL of the CCTV RTSP video stream that will be associated to the guard unit.

User and password: optional, for cameras that require them for connecting.

The format of the URL may vary depending on the brand/model of the camera. See data sheet of the corresponding camera.



MEET VIDEO DOOR ENTRY SYSTEM

ADVANCED SETTINGS

DEVICE	ALARM: <input checked="" type="checkbox"/>
GENERAL	DIRECTORY: <input checked="" type="checkbox"/>
NETWORK	<input type="button" value="Seleccionar archivo"/> <input type="button" value="Nin...lec."/> <input type="button" value="IMPORT"/> <input type="button" value="EXPORT"/>
SIP	MAPPING CALL: <input type="checkbox"/>
SIP CALL	WHITE LIST: <input type="checkbox"/>
ADVANCED	ALPHANUMERIC KEYPAD: <input type="checkbox"/>
LIFT CONTROL	SIP EXTENSION 1: <input type="checkbox"/>
UNLOCK	URL: <input type="text"/>
PINGCODE	SIP EXTENSION 2: <input type="checkbox"/>
RESTORE	URL: <input type="text"/>
	NUMBER OF CAMERAS: <input type="text" value="0"/>
	RTSP: <input type="checkbox"/>
	<input type="button" value="SAVE"/>

3.7 Lift control

LIFT RELEASE: Enable or disable LIFT function. LIFT BUTTON will appear in CALL TO APARTMENT and DIRECTORY menus if this function is enabled. (*Unsupervised Lift Control*)

VISITOR LIFT CONTROL: Enable or disable visitor Lift control. If enabled, the concierge will be able to authorize for lifting after having communicated with a certain apartment. (*Supervised Lift Control*)

DEVICE GENERAL NETWORK SIP SIP CALL ADVANCED **LIFT CONTROL** UNLOCK PINCODE RESTORE

LIFT CONTROL

LIFT RELEASE:

VISITOR LIFT CONTROL:

SAVE

3.8 Unlock Settings

NUMBER OF DOORLOCKS: Indicate the number of door openers the guard unit will control. (Between 0 and 4). Depending on the number indicated, the guard unit screen will display additional door icons when the guard unit receives a call from a panel.

DTMF UNLOCK: Enables or disables DTMF unlock function

This function is used with third-party SIP devices that requires a certain DMTF command for opening the door.

DTMF KEY: Character to be sent for releasing a SIP outdoor panel, like # or *. The characters to release the lock can also be set up in the SIP panel. DMTF KEY command will be sent when pressing “key” (open) button.

HTTP UNLOCK: Enable or disable HTTP unlock function.

The guard unit will send an http request when the concierge presses for releasing the lock.

URL: Indicates the HTTP unlock command the guard unit will send for releasing the lock from a SIP panel when the concierge presses the door open icon.

The URL shall be correctly configured in the SIP panel.

DEVICE GENERAL NETWORK SIP SIP CALL ADVANCED **LIFT CONTROL** **UNLOCK** PINCODE RESTORE

UNLOCK SETTINGS

NUMBER OF DOORLOCKS: 0

DTMF UNLOCK:

DTMF KEY: #

HTTP UNLOCK:

URL: #

SAVE

3.9 Installer Pin Settings

This menu allows to change default password of the webserver login.

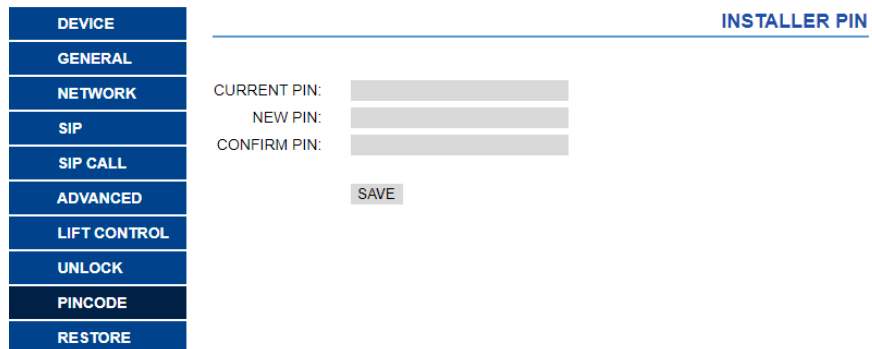

The screenshot shows a web interface for changing the installer pin. On the left is a vertical menu with buttons for: DEVICE, GENERAL, NETWORK, SIP, SIP CALL, ADVANCED, LIFT CONTROL, UNLOCK, PINCODE, and RESTORE. The 'PINCODE' button is highlighted. The main content area is titled 'INSTALLER PIN' and contains three input fields labeled 'CURRENT PIN:', 'NEW PIN:', and 'CONFIRM PIN:'. Below these fields is a 'SAVE' button.

3.10 Restore

RESTORE FACTORY SETTINGS: All the settings are restored to default factory settings.

The IP address will be changed to the default IP: 10.201.100.0.

REBOOT DEVICE: The concierge will be restarted, keeping all previous settings.

4. Installation

4.1 Schematic Diagram of Guard Unit Installation

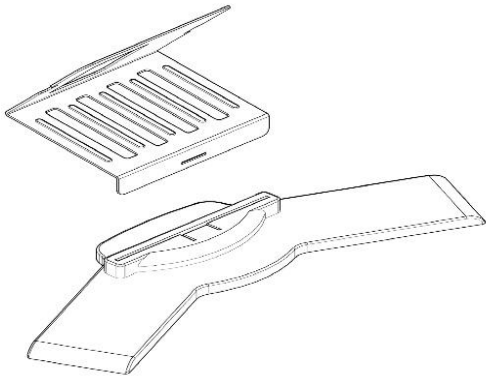

Fit support on the base plate.

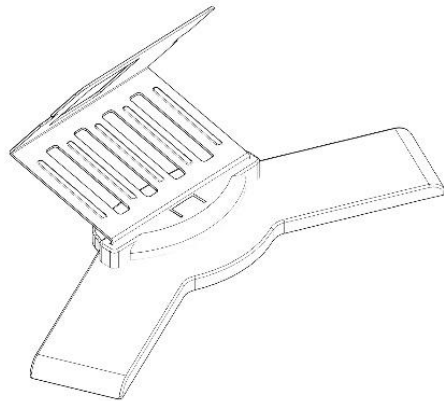

Support installation.

Assembly direction.

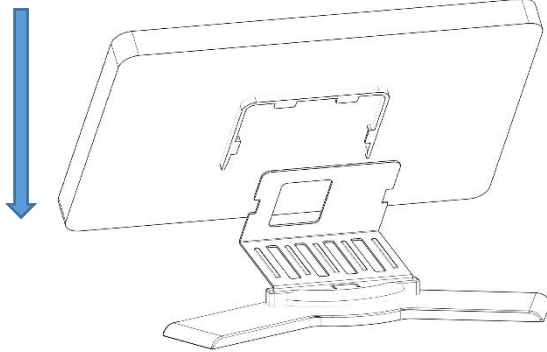

Display screen is stuck from up and down.

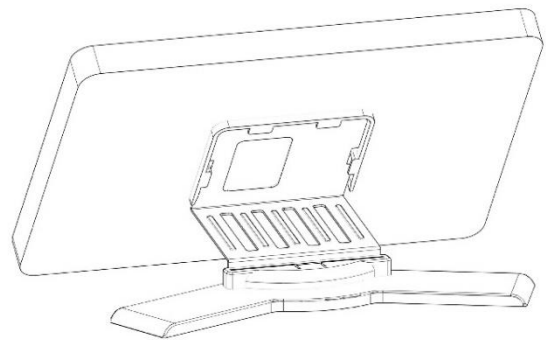

Installation is complete.

Steps for removing the display

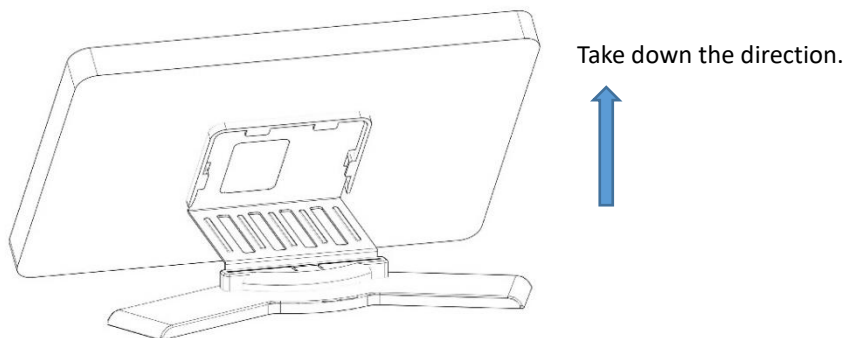

The display screen is removed from the bottom up from the bracket.

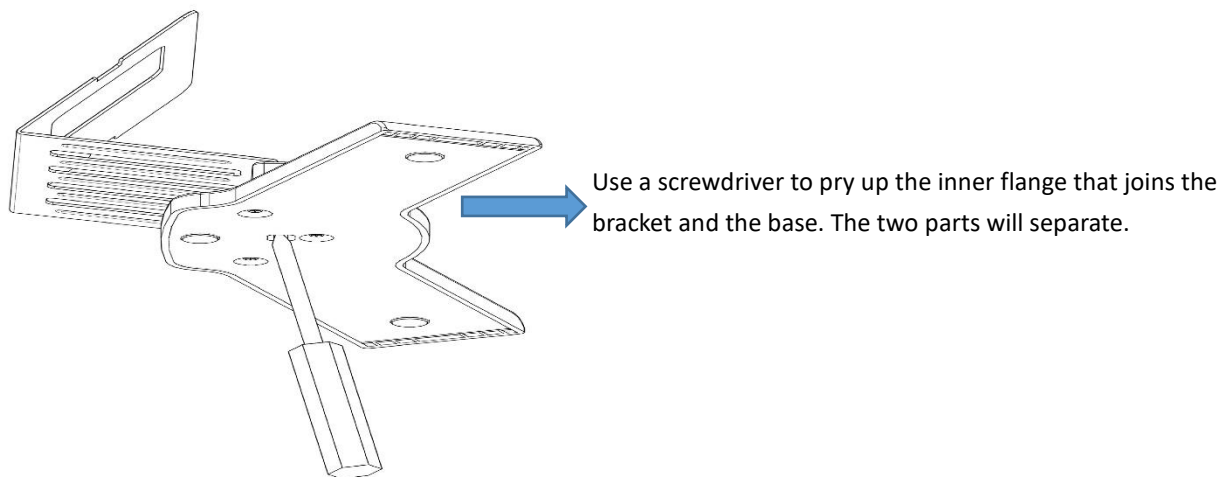

Remove the support from the base.

4.2 Connectors

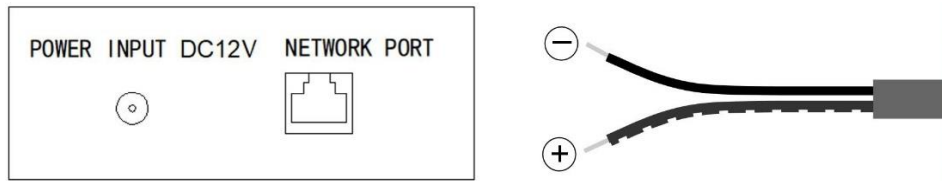

- 12Vdc Power Input. The internal terminal is the positive
- 10/100Mbps RJ45 Port (PoE)

4.3 Technical Parameters

Power supply: 12Vdc or POE.

Standby current: 200mA.

Working current: 500mA.

Screen: 10,1" inches capacitive touch screen.

Resolution: 1024x600px.

Maximum conversation time: 120s.

Maximum record time: 120s.

Concierge number: 9901-9998.

Extension: 0-7 (0 = Master).

Call ring tones: 6.

Operating temperature: -10~55°C.

Relative Humidity: 20-93%, without condensation.



The device you have purchased is identified under Directive 2012/19/EU on waste electrical and electronic equipment. More info:



This equipment has been tested and found to comply with the limits for a Class B digital device, pursuant to part 15 of the FCC Rules. These limits are designed to provide reasonable protection against harmful interference in a residential installation. This equipment generates, uses, and can radiate radio frequency energy and, if not installed and used in accordance with the instructions, may cause harmful interference to radio communications. However, there is no guarantee that interference will not occur in a particular installation.

If this equipment does cause harmful interference to radio or television reception, which can be determined by turning the equipment off and on, the user is encouraged to try to correct the interference by one or more of the following measures:

- *Reorient or relocate the receiving antenna.*
- *Increase the separation between the equipment and receiver.*
- *Connect the equipment into an outlet on a circuit different from that to which the receiver is connected.*
- *Consult the dealer or an experienced radio/TV technician for help.*

For more information, visit www.fermax.com

Contact: tec@fermax.com / www.fermax.com/contact