



SPECTIS™
MOULDERS INC.
Custom Polyurethane Products

BLOCKS, BRACKETS & GINGERBREADS





BLOCKS, BRACKETS & GINGERBREADS

NOTICE :

SPECTIS ADHESIVE MUST BE USED ON ALL BEDDING/BUTT JOINTS.

SPECTIS RESERVES THE RIGHT TO HOLLOW OUT THE BACK OF ANY PRODUCT WITHOUT NOTICE. SOME PRODUCTS MAY BE MADE AS ASSEMBLIES.



- BL 2400**
- 4 3/4" Projection
 - 12 3/8" Height
 - 7 3/4" Width



- BL 2517**
- 6 1/2" Projection
 - 7 1/4" Overall Projection
 - 16 1/4" Height
 - 5 1/2" Width



- BL 3048**
- 5 1/2" Projection
 - 13 1/4" Height
 - 7 1/2" Width



- BL 2530**
- 9 3/4" Projection
 - 26 3/8" Height
 - 9 3/4" Width



- BL 2782**
- 8" Projection
 - 29" Height
 - 12" Width



- BL 2783**
- 20" Projection
 - 54" Height
 - 12" Width



- BL 2837**
- 9 1/2" Projection
 - 36" Height
 - 10 1/2" Width



- BL 2420**
- 4 1/4" Projection
 - 9 3/4" Height
 - 5" Width



- BL 2423**
- 4 11/16" Projection
 - 6 1/8" Overall Projection
 - 17 1/8" Height
 - 5 1/2" Width



- BL 2563**
- 6" Projection
 - 13 1/2" Height
 - 7 7/8" Width



- BL 2784**
- 5 1/2" Projection
 - 5 11/16" Overall Projection
 - 9 7/8" Height
 - 5 1/8" Width



- BL 2829**
- 8" Projection
 - 16" Height
 - 11" Width



Photo above illustrates the use of the following Spectis products: custom header and block BL 2483A.



- BL 2845**
- 8 5/16" Projection
 - 13" Height
 - 10 3/8" Width



- BL 2440**
- 25 3/8" Projection
 - 35 7/8" Height
 - 18" Width



- BL 2522**
- 14 1/2" Projection
 - 26" Height
 - 6 1/2" Width

1 • 8 0 0 • 6 8 5 • 9 9 8 1



Blocks may come with hollows in tops and/or backs

BLOCKS, BRACKETS & GINGERBREADS



- BL 2574**
- 23 1/16" Projection
 - 24 1/8" Height
 - 7 1/2" Width



- BL 2734**
- 7 3/4" Projection
 - 9" Overall Projection
 - 30 3/4" Height
 - 2 1/2" Width



- BL 2874**
- 25 1/2" Projection
 - 44 1/2" Height
 - 14 1/2" Width



- BL 2918**
- 10 15/16" Projection
 - 16 1/4" Height
 - 6" Width



- BL 2422**
- 4 1/8" Projection
 - 6" Overall Projection
 - 16 3/16" Height
 - 5" Width



- BL 2666**
- 5 3/4" Projection
 - 9 3/8" Overall Projection
 - 22 1/2" Height
 - 5" Width



- BL 2755**
- 2" Projection
 - 9 1/2" Height
 - 3 3/4" Width



- BL 2800**
- 4 3/4" Projection
 - 35 3/4" Height
 - 8 1/2" Width



Photo above illustrates the use of the following Spectis products: block BL 2734, balusters BAL 2028-12, gingerbread GB 3323, finial FIN 102 and porch posts PP 3203.

www.spectis.com



Blocks may come with hollows in tops and/or backs



BLOCKS, BRACKETS & GINGERBREADS

NOTICE :

SPECTIS ADHESIVE MUST BE USED ON ALL BEDDING/BUTT JOINTS.

COMBINED BL 2483

- 11 1/8" Projection
- 7" Height
- 14" Width
- Block Components for MD 1242 on page 170

BL 2483C

- 7 1/2" Projection
- 1 1/8" Height
- 14" Width

BL 2483B

- 11 1/8" Projection
- 1 3/8" Height
- 9 1/4" Width

BL 2483A

- 10 1/4" Projection
- 4 7/16" Height
- 8" Width

BL 2483R-5/12 • 5/12 Pitch
BL 2483L-5/12 • 5/12 Pitch

BL 2635L
BL 2635R

- 24 3/4" Projection
- 17 13/16" Height
- 2 7/8" Width

BL 2463

- 11 1/8" Projection
- 8 7/8" Height
- 14" Width

BL 2445

- 3" Projection
- 3 1/8" Overall Projection
- 2 1/16" Height
- 2 3/16" Width

BL 2516

- 15 7/8" Projection
- 9 1/4" Height
- 3 5/8" Width

BL 2835

- 23 7/8" Projection
- 13 7/8" Height
- 5 1/2" Width

BL 2982

- 13 3/16" Projection
- 11 1/4" Height
- 5" Width

BL 2538

- 13 1/4" Projection
- 6 1/2" Height
- 7 5/8" Width

BL 2427

- 23 1/2" Projection
- 11 1/2" Height
- 9 1/4" Width

BL 2836

- 13" Projection
- 10" Height
- 8" Width

BL 2610

- 3 9/16" Projection
- 1 5/8" Height
- 3" Width

BL 2882

- 3 15/16" Projection
- 1 7/8" Height
- 2 1/2" Width

BL 3061

- 11 1/8" Projection
- 5 13/16" Height
- 9 1/4" Width

BL 2581

- 2 7/8" Projection
- 1 3/8" Height
- 1 3/8" Width

1 • 8 0 0 • 6 8 5 • 9 9 8 1



Blocks may come with hollows in tops and/or backs

BLOCKS, BRACKETS & GINGERBREADS



BL 2993

- 5 1/8" Projection
- 3" Height
- 3 1/2" Width



BL 2895

- 10" Projection
- 17 3/4" Height
- 7 3/4" Width



BL 2956

- 10 15/16" Projection
- 4 7/8" Height
- 11 1/8" Width
- 2 PARTS- A & B



BL 2436

- 15 7/8" Projection
- 8 1/4" Height
- 10 1/4" Width



BL 2492

- 6 7/8" Projection
- 4 1/2" Height
- 6 7/8" Width



BL 2854

- 15 7/8" Projection
- 6" Height
- 9 3/4" Width



BL 2557

- 7 1/2" Projection
- 3 3/8" Height
- 5" Width



BL 2621

- 21" Projection
- 6 1/4" Height
- 6 1/16" Width



BL 2597

- 22 1/4" Projection
- 7" Height
- 6 3/8" Width



BL 2762

- 20 3/8" Projection
- 7" Height
- 5 7/8" Width



COMBINED BL 2604

- 17 1/4" Projection
- 10 1/2" Height
- 21" Width
- Block Components for MD 1484 on page 171

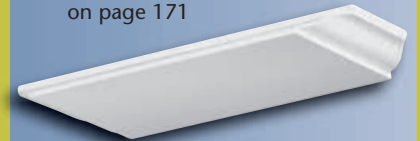

BL 2604C

- 11 1/4" Projection
- 1 11/16" Height
- 21" Width



BL 2604B

- 16 11/16" Projection
- 2 1/16" Height
- 13 7/8" Width



BL 2604A

- 15 3/8" Projection
- 6 11/16" Height
- 12" Width

www.spectis.com



Blocks may come with
hollows in tops and/or backs



BLOCKS, BRACKETS & GINGERBREADS

NOTICE :

SPECTIS ADHESIVE MUST BE USED ON ALL BEDDING/BUTT JOINTS.



COMBINED BL 2476

- 5 11/16" Projection
- 3 13/16" Height
- 7" Width
- Block Components for MD 1259 on page 170



BL 2476C

- 3 3/4" Projection
- 9/16" Height
- 7" Width

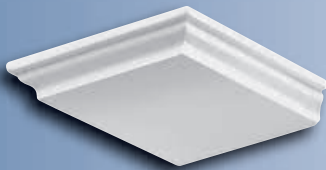

BL 2476B

- 5 9/16" Projection
- 11/16" Height
- 4 5/8" Width



BL 2476A

- 5 1/8" Projection
- 2 9/16" Height
- 3 1/4" Width

BL 2476L-8/12

BL 2476R-8/12



BL 2864

- 17 1/2" Projection
- 6 3/4" Height
- 8" Width



BL 2865

- 32" Projection
- 14" Height
- 7 1/2" Width



BL 2830

- 15" Projection
- 16" Overall Projection
- 24" Height
- 16 3/8" Width



BL 2960

- 38 3/4" Projection
- 13 5/8" Height
- 6 15/16" Width



BL 2961

- 23 11/16" Projection
- 20 1/4" Height
- 10 7/16" Width



BL 2803

- 6 3/4" Projection
- 29" Height
- 5 1/4" Width



BL 2804

- 6 7/8" Projection
- 15 3/4" Height
- 5 1/4" Width



BL 2464

- 3 3/4" Projection
- 8 1/2" Height
- 4 7/8" Width



BL 2428

- 3" Projection
- 3 1/4" Overall Proj.
- 8 1/4" Height
- 3 5/16" Width

1 • 8 0 0 • 6 8 5 • 9 9 8 1



Blocks may come with hollows in tops and/or backs

BLOCKS, BRACKETS & GINGERBREADS



BL 2496

- 41 7/8" Projection
- 21 3/4" Height
- 3 7/8" Width



BL 2974

- 12" Projection
- 3 3/4" Height
- 2 3/4" Width



BL 2951

- 16 3/4" Projection
- 32 1/4" Height
- 12 7/8" Width



BL 2407

- 1 1/8" Projection
- 16 1/4" Height
- 9 1/2" Width



BL 2502

- 1" Projection
- 14" Height
- 8" Width



BL 2644

- 1 1/4" Projection
- 11 1/2" Height
- 7" Width



BL 2757

- 1" Projection
- 10 1/4" Height
- 5 1/2" Width



BL 2797

- 1" Projection
- 14" Height
- 5 1/4" Width



Photo above illustrates the use of Spectis custom panel insert and moulding MD 1154.



BL 2535

- 1 1/4" Projection
- 7 1/2" Height
- 5" Width

BL 2535L-9/12

- 9/12 Pitch



BL 2983

- 1 3/8" Projection
- 10 1/8" Height
- 6" Width



BL 2632

- 1 1/4" Projection
- 11 1/2" Height
- 7" Width

www.spectis.com



Blocks may come with hollows in tops and/or backs



BLOCKS, BRACKETS & GINGERBREADS

NOTICE :

SPECTIS ADHESIVE MUST BE USED ON ALL BEDDING/BUTT JOINTS.



BL 2617

- 1 9/16" Projection
- 20 1/4" Height
- 12" Width



BL 3067

- 1 1/8" Projection
- 25 3/4" Height
- 16 5/8" Width



BL 3113

- 3 5/8" Projection
- 10 1/2" Height
- 6 1/8" Width



BL 2472

- 2 1/4" Projection
- 10 3/4" Height
- 6 1/4" Width



BL 2740

- 7/8" Projection
- 11 3/4" Height
- 3 3/4" Width



BL 3039

- 3" Projection
- 14" Height
- 5" Width



BL 2896

- 3" Projection
- 18" Height
- 5" Width



BL 2687

- 5" Projection
- 13 5/8" Height
- 5" Width



BL 2412

- 5 1/2" Projection
- 14" Height
- 6 7/8" Width

BL 2412L-8/12

BL 2412R-8/12

- 8/12 Pitch



BL 2426

- 5 1/4" Projection
- 10" Height
- 3 1/2" Width



BL 3016

- 8" Projection
- 14" Height
- 8" Width



BL 3038

- 10 1/2" Projection
- 14" Height
- 6" Width



BL 2998

- 10" Projection
- 16" Height
- 6" Width



BL 2481

- 10 1/2" Projection
- 20" Height
- 6" Width



BL 2930

- 5 1/4" Projection
- 10" Height
- 4" Width



BL 2935

- 5 1/4" Projection
- 14" Height
- 3 1/2" Width

1 • 8 0 0 • 6 8 5 • 9 9 8 1



Blocks may come with
hollows in tops and/or backs

BLOCKS, BRACKETS & GINGERBREADS



BL 2419
 • 3 1/2" Projection
 • 35" Height
 • 7 1/2" Width



BL 3044
 • 5 1/8" Projection
 • 15 7/8" Height
 • 5 5/8" Width



BL 3109
 • 2 1/2" Projection
 • 24 1/2" Height
 • 8 3/4" Width



BL 2477
 • 4 1/4" Projection
 • 21" Height
 • 4 1/4" Width



BL 2725
 • 6" Projection
 • 22 1/2" Height
 • 5" Width



BL 2457
 • 14 1/4" Projection
 • 30" Height
 • 7 1/2" Width



BL 2458
 • 14 1/4" Projection
 • 30" Height
 • 7 1/2" Width



BL 2473
 • 10 5/8" Projection
 • 19" Height
 • 10 5/8" Width



BL 2487
 • 15 5/8" Projection
 • 19 3/8" Height
 • 11 1/2" Width



Photo above illustrates the use of the following Spectis products: custom mouldings with blocks BL 2487.

www.spectis.com



Blocks may come with hollows in tops and/or backs



BLOCKS, BRACKETS & GINGERBREADS

NOTICE :

SPECTIS ADHESIVE MUST BE USED ON ALL BEDDING/BUTT JOINTS.



- BL 2922**
- 8 1/2" Projection
 - 16" Height
 - 4 1/2" Width



- BL 2429**
- 17 1/2" Projection
 - 35" Height
 - 11" Width

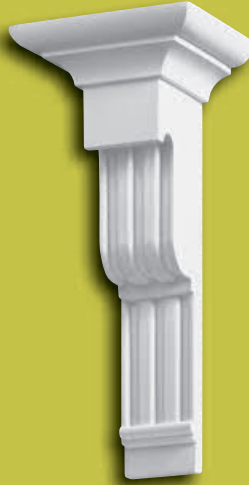

- BL 2460**
- 6 3/4" Projection
 - 17" Height
 - 7 3/4" Width



Photo above shows the use of Spectis block BL 2531.



- BL 2534**
- 11" Projection
 - 20 7/8" Height
 - 7 7/8" Width



- BL 2566**
- 6 5/8" Projection
 - 18 3/8" Height
 - 7 3/4" Width



- BL 2691**
- 21 1/8" Projection
 - 29 1/2" Height
 - 8 7/8" Width



- BL 2425**
- 9 5/8" Projection
 - 15 5/8" Height
 - 2 1/2" Width



- BL 3052**
- 7 7/8" Projection
 - 17 3/4" Height
 - 2 1/2" Width



- BL 2531**
- 20 1/4" Projection
 - 35" Height
 - 9 1/2" Width



- BL 2620**
- 10 1/2" Projection
 - 22" Height
 - 4 1/4" Width



- BL 2989**
- 10" Projection
 - 19 13/16" Height
 - 4" Width

1 • 8 0 0 • 6 8 5 • 9 9 8 1



Blocks may come with hollows in tops and/or backs

BLOCKS, BRACKETS & GINGERBREADS



BL 2855
 • 15 3/8" Projection
 • 27 9/16" Height
 • 8 3/8" Width



BL 2508
 • 12" Projection
 • 20 3/4" Height
 • 11" Width



BL 3130
 • 11" Projection
 • 38 1/2" Height
 • 6" Width



BL 3179
 • 7 1/4" Projection
 • 48" Height
 • 7 1/4" Width



BL 2605
 • 8 5/16" Projection
 • 25 1/2" Height
 • 3 1/8" Width



BL 2626
 • 8 5/8" Projection
 • 13 3/4" Height
 • 3" Width



BL 2456
 • 14 1/4" Projection
 • 30" Height
 • 7 1/2" Width



BL 2590
 • 10 5/8" Projection
 • 19 1/4" Height
 • 4 1/2" Width



BL 2627
 • 9 3/16" Projection
 • 14 7/8" Height
 • 3" Width



BL 2902
 • 10 3/4" Projection
 • 28 1/8" Height
 • 5" Width



BL 2733
 • 4" Projection
 • 9" Height
 • 3 1/2" Width



BL 2527
 • 4 1/2" Projection
 • 14 1/2" Height
 • 8 1/8" Width



BL 2707
 • 24" Projection
 • 11" Height
 • 8" Width



BL 3124
 • 24" Projection
 • 21" Height
 • 5" Width





BLOCKS, BRACKETS & GINGERBREADS

NOTICE :

SPECTIS ADHESIVE MUST BE USED ON ALL BEDDING/BUTT JOINTS.

- BL 2946**
- 16 1/2" Projection
 - 34" Height
 - 4" Width



- BL 3110**
- 18 3/16" Projection
 - 30 1/2" Height
 - 3" Width



- BL 3158**
- 32" Projection
 - 48" Height
 - 6" Width



- BL 2729**
- 4" Projection
 - 28" Height
 - 16" Width



- BL 2838**
- 7" Projection
 - 17 1/4" Height
 - 4 1/2" Width



- BL 2932**
- 26" Projection
 - 18" Height
 - 4 1/2" Width



- BL 3090**
- 9 3/4" Projection
 - 10 1/4" Height
 - 3 1/2" Width



- BL 2724**
- 20" Projection
 - 5 7/8" Height
 - 3" Width

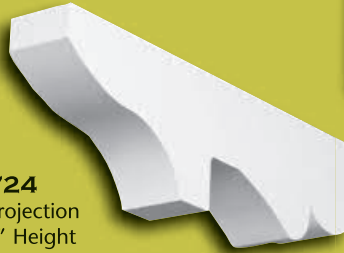

- BL 2927**
- 12" Projection
 - 36" Height
 - 4" Width



- BL 2739**
- 4 1/2" Projection
 - 19" Height
 - 4 1/2" Width



- BL 2817**
BL 2817CF
- 12" Projection
 - 39" Height
 - 12" Width
 - **CONCRETE FINISH**
- BL 2816CF**
- 12" Projection
 - 49" Height
 - 12" Width
 - **CONCRETE FINISH**



- BL 2843**
- 14" Projection
 - 3 3/4" Height
 - 4" Width

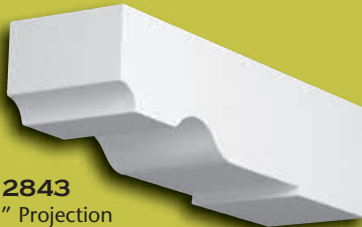

- BL 2880**
- 24" Projection
 - 10" Height
 - 6" Width



- BL 2448**
- 13" Projection
 - 3 3/4" Height
 - 6" Width

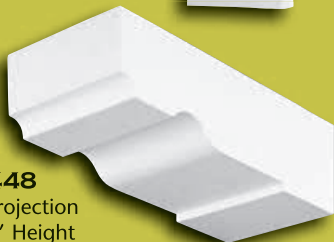

- BL 3161**
- 36" Projection
 - 8" Height
 - 10" Width



- BL 2449**
- 9" Projection
 - 3 3/4" Height
 - 6" Width

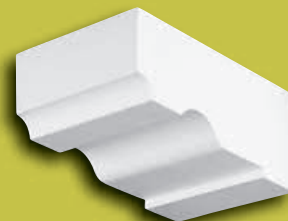

1 • 8 0 0 • 6 8 5 • 9 9 8 1



Blocks may come with
hollows in tops and/or backs

BLOCKS, BRACKETS & GINGERBREADS



BL 2931
 • 3 1/2" Projection
 • 8" Height
 • 11" Width



BL 2953
 • 9 1/4" Projection
 • 29" Height
 • 7" Width



BL 2544
 • 3" Projection
 • 7" Height
 • 3 1/2" Width



BL 2710
 • 7" Projection
 • 12" Height
 • 7 1/2" Width



BL 2659
 • 15" Projection
 • 25 3/4" Height
 • 14 1/2" Width



BL 2680
 • 9" Projection
 • 14 1/2" Height
 • 7" Width

BL 2680W
 • WOODGRAIN



BL 2411-16
 • 16" Projection
 • 7 3/8" Height
 • 3" Width

BL 2411-18
 • 18" Projection
 • 7 5/8" Height
 • 3" Width



BL 2866
 • 24" Projection
 • 27" Overall Projection
 • 10" Height
 • 3" Width



BL 2564
 • 52" Projection
 • 13 3/4" Height
 • 5 3/4" Width



BL 2969
 • 26" Projection
 • 5 1/2" Height
 • 2" Width

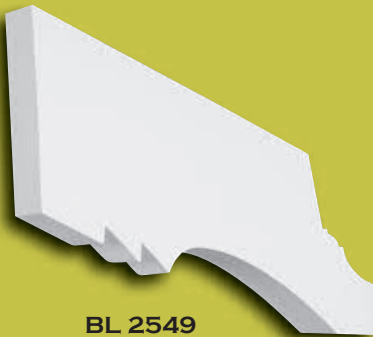

BL 2549
 • 16 1/2" Projection
 • 12" Height
 • 2 5/8" Width

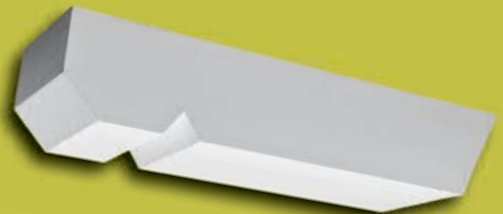

BL 3005
 • 20 1/4" Projection
 • 4" Height
 • 6" Width



BL 2772
 • 18" Projection
 • 11 1/4" Height
 • 3" Width
 • 6/12" Pitch



BL 2773
 • 18 1/16" Projection
 • 11 1/4" Height
 • 3" Width
 • 3/12" Pitch



BL 2550
 • 39 1/2" Projection
 • 6 11/16" Height
 • 2" Width

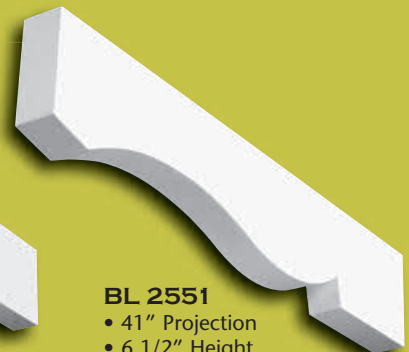

BL 2551
 • 41" Projection
 • 6 1/2" Height
 • 2" Width

www.spectis.com



Blocks may come with
hollows in tops and/or backs



BLOCKS, BRACKETS & GINGERBREADS

NOTICE :

SPECTIS ADHESIVE MUST BE USED ON ALL BEDDING/BUTT JOINTS.



BL 2647
• 23" Projection
• 11 3/8" Height
• 3 1/2" Width

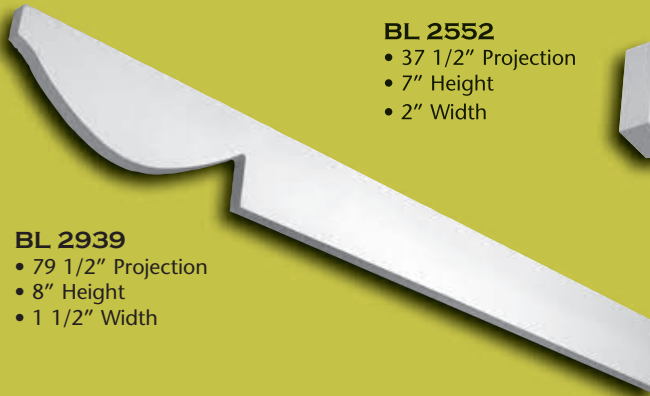

BL 2939
• 79 1/2" Projection
• 8" Height
• 1 1/2" Width

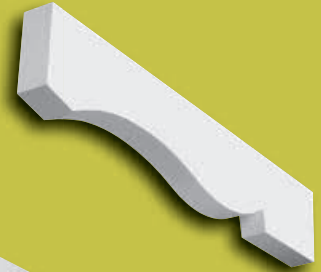

BL 2552
• 37 1/2" Projection
• 7" Height
• 2" Width



BL 2685
• 16" Projection
• 7" Height
• 5" Width



BL 2926
• 18" Projection
• 6" Height
• 4 1/2" Width

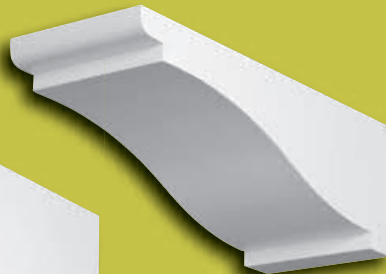

BL 2901
• 18 1/2" Projection
• 6 1/4" Height
• 7 1/4" Width



BL 3029
• 21 3/4" Projection
• 12" Height
• 6" Width



BL 2668
• 29" Projection
• 9 1/2" Height
• 6" Width



BL 3028
• 46" Projection
• 12" Height
• 6" Width



BL 2925
• 49" Projection
• 16" Height
• 4" Width

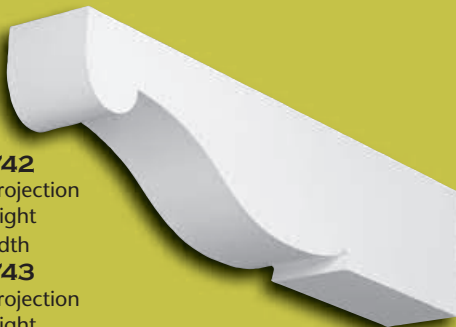

BL 2742
• 23" Projection
• 6" Height
• 4" Width

BL 2743
• 26" Projection
• 6" Height
• 4" Width

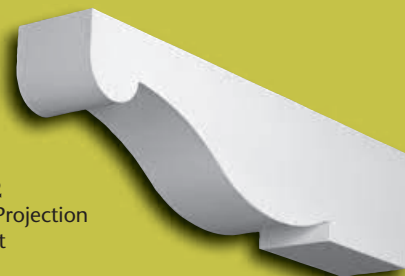

BL 2912
• 24 1/2" Projection
• 6" Height
• 4" Width

1 • 8 0 0 • 6 8 5 • 9 9 8 1

Blocks may come with
hollows in tops and/or backs



BLOCKS, BRACKETS & GINGERBREADS



BL 3115
 • 29" Projection
 • 6" Height
 • 3" Width



BL 2646
 • 11 3/16" Projection
 • 5" Height
 • 3 1/2" Width



BL 3143
 • 11" Projection
 • 4" Height
 • 4" Width

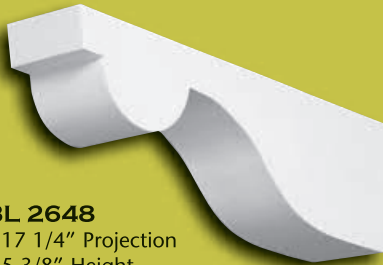

BL 2648
 • 17 1/4" Projection
 • 5 3/8" Height
 • 3 1/2" Width



BL 2987
 • 13" Projection
 • 9 1/4" Height
 • 3 1/8" Width



BL 2690
 • 26 1/2" Projection
 • 5 1/4" Height
 • 7 1/4" Width

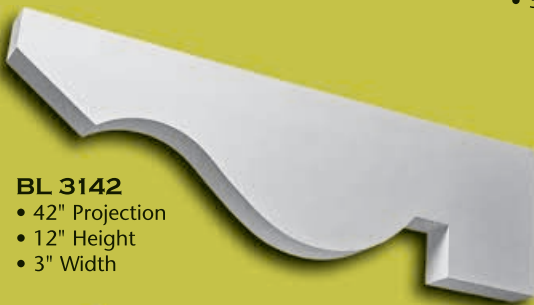

BL 3142
 • 42" Projection
 • 12" Height
 • 3" Width



BL 2774
 • 39" Projection
 • 12" Height
 • 3" Width



BL 2776
 • 20" Projection
 • 10" Height
 • 12" Width



BL 3122RS
 • 24" Projection
 • 5 1/4" Height
 • 5 1/4" Width



BL 3007
 • 24" Projection
 • 12" Height
 • 6" Width



BL 3094
 • 27 1/2" Projection
 • 5 1/2" Height
 • 5 1/2" Width

BL 2798
 • 9 7/8" Projection
 • 25 7/8" Height
 • 7 1/2" Width





BLOCKS, BRACKETS & GINGERBREADS

NOTICE :

SPECTIS ADHESIVE MUST BE USED ON ALL BEDDING/BUTT JOINTS.



BL 2921
• 60" Projection
• 5 1/2" Height
• 7 1/2" Width



BL 2920
• 30" Projection
• 5 1/2" Height
• 7 1/2" Width



BL 2547
• 26" Projection
• 9 1/2" Height
• 3" Width



BL 2765
• 14 1/2" Projection
• 6 11/16" Height
• 5" Width
• 6/12 Pitch



BL 2764
• 14 1/2" Projection
• 7 1/4" Height
• 5" Width
• 3/12 Pitch

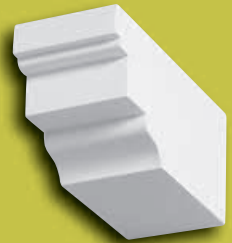

BL 2514
• 6" Projection
• 2 7/8" Height
• 2 1/2" Width



BL 2562
• 21 1/2" Projection
• 18 1/4" Height
• 4 1/4" Width

BL 2766
• 14 1/2" Projection
• 6 1/2" Height
• 5" Width
• 7/12 Pitch



BL 2682
• 14" Projection
• 9" Height
• 2 1/2" Width
• 4/12 Pitch



BL 2683
• 14" Projection
• 9" Height
• 2 1/2" Width
• 5/12 Pitch



BL 2678
• 9" Projection
• 24" Height
• 8" Width

1 • 8 0 0 • 6 8 5 • 9 9 8 1



Blocks may come with
hollows in tops and/or backs

BLOCKS, BRACKETS & GINGERBREADS



BL 3185
 • 19 1/2" Projection
 • 11 1/2" Height
 • 3" Width

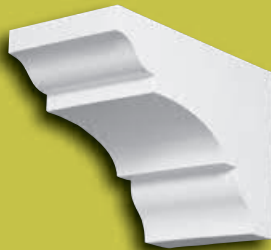

BL 2706
 • 11 1/2" Projection
 • 7 3/4" Height
 • 6" Width



BL 2980
 • 11" Projection
 • 13" Height
 • 6" Width

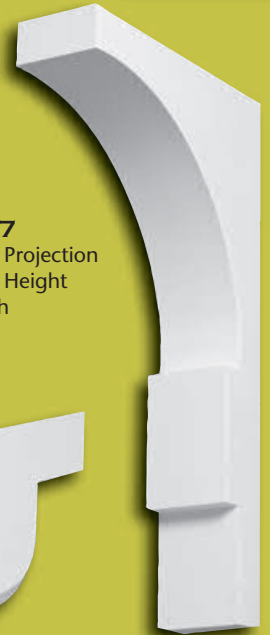

BL 2737
 • 13 1/4" Projection
 • 23 3/4" Height
 • 4" Width



BL 3087
 • 24" Projection
 • 30" Height
 • 5 1/4" Width



BL 3088
 • 45 1/4" Projection
 • 39" Height
 • 5 1/4" Width



BL 2807
 • 21" Projection
 • 12 3/8" Height
 • 3" Width



BL 2754
 • 24" Projection
 • 14 1/2" Height
 • 7 1/4" Width



BL 3182
 • 30 1/2" Projection
 • 9" Height
 • 10" Width



BL 2789
 • 9 1/4" Projection
 • 13" Height
 • 3 1/8" Width



BL 2822
 • 27 1/2" Projection
 • 21 3/4" Height
 • 3" Width



BL 2827
 • 17" Projection
 • 12" Height
 • 5" Width
BL 2827L-10/12
BL 2827R-10/12
 • 17" Projection
 • 16 3/16" Height
 • 5" Width

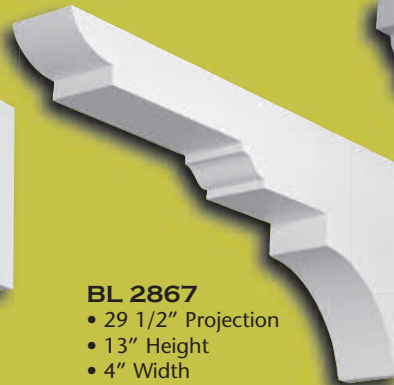

BL 2867
 • 29 1/2" Projection
 • 13" Height
 • 4" Width

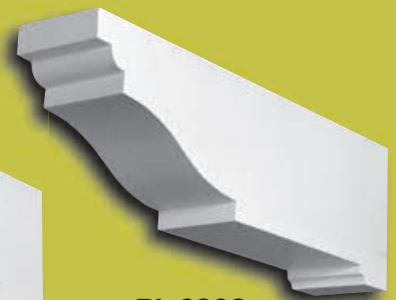

BL 2903
 • 26" Projection
 • 8 5/8" Height
 • 5" Width

www.spectis.com



Blocks may come with
hollows in tops and/or backs



BLOCKS, BRACKETS & GINGERBREADS

NOTICE :

SPECTIS ADHESIVE MUST BE USED ON ALL BEDDING/BUTT JOINTS.



BL 2977

- 12 1/2" Projection
- 10 1/4" Height
- 3 1/2" Width



BL 3165

- 10" Projection
- 4" Height
- 3" Width



BL 3173

- 15 1/4" Projection
- 7 1/4" Height
- 4" Width

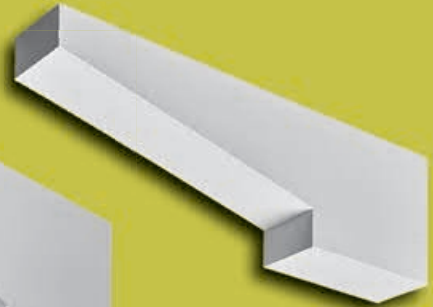

BL 3174

- 24" Projection
- 7 1/4" Height
- 4" Width



BL 3169

- 26" Projection
- 7" Height
- 5" Width



BL 3183

- 39" Projection
- 12" Height
- 4" Width



BL 2904

- 12 3/4" Projection
- 9" Height
- 7" Width



BL 2770RS

- 21" Projection
- 12" Height
- 8 3/4" Width
- ROUGH SAWN
- WOODTONE COLOUR



BL 2771RS

- 23" Projection
- 12" Height
- 8 3/4" Width
- ROUGH SAWN
- WOODTONE COLOUR



BL 2913

- 18" Projection
- 9 3/8" Height
- 3" Width



BL 2872

- 52" Projection
- 42" Height
- 12" Width



BL 3015

- 22" Projection
- 24" Height
- 4" Width

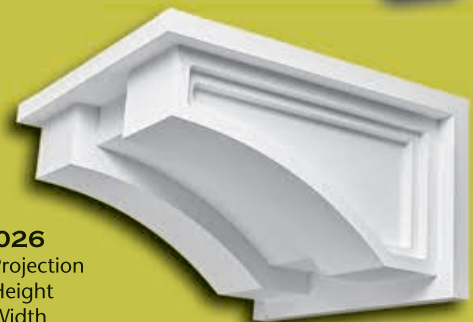

BL 3026

- 24" Projection
- 14" Height
- 24" Width

1 • 8 0 0 • 6 8 5 • 9 9 8 1

Blocks may come with hollows in tops and/or backs



BLOCKS, BRACKETS & GINGERBREADS

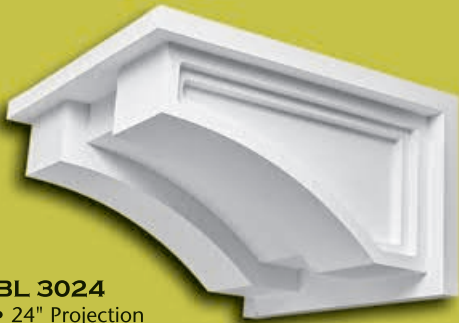

BL 3024
 • 24" Projection
 • 20" Height
 • 24" Width



BL 2887
 • 26 3/8" Projection
 • 22 3/4" Height
 • 5 3/8" Width



BL 3025
 • 36" Projection
 • 20" Height
 • 16" Width



BL 2756
 • 1 3/4" Projection
 • 5 3/4" Height
 • 5 5/8" Width



BL 3066
 • 4" Projection
 • 10" Height
 • 4" Width



BL 2778
 • 31" Projection
 • 9 1/4" Height
 • 10 1/2" Width

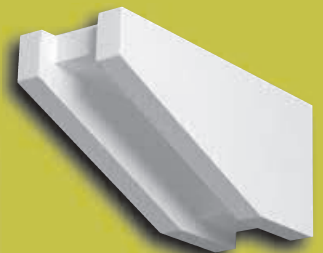

BL 2779
 • 16 1/2" Projection
 • 7 1/2" Height
 • 6 1/2" Width

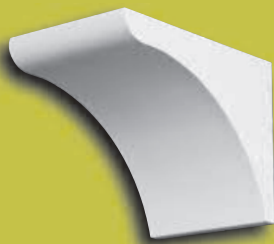

BL 2693
 • 8 1/2" Projection
 • 6 1/4" Height
 • 5 3/4" Width

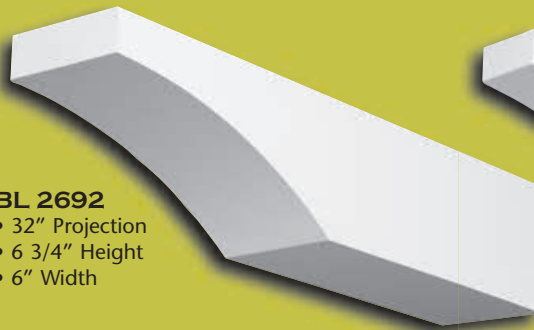

BL 2692
 • 32" Projection
 • 6 3/4" Height
 • 6" Width

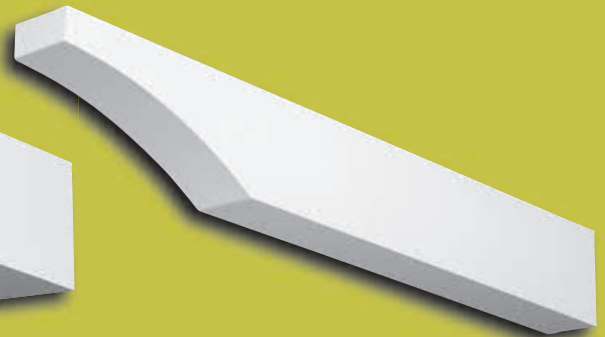

BL 2694
 • 36" Projection
 • 6 3/4" Height
 • 4" Width

BL 2695
 • 24" Projection
 • 6 3/4" Height
 • 4" Width

BL 2696
 • 32" Projection
 • 6 3/4" Height
 • 4" Width

BL 2697
 • 48" Projection
 • 6 3/4" Height
 • 4" Width



BL 3118
 • 22" Projection
 • 18" Height
 • 7 3/4" Width



BL 3117
 • 32" Projection
 • 18" Height
 • 7 3/4" Width

www.spectis.com



Blocks may come with
hollows in tops and/or backs



BLOCKS, BRACKETS & GINGERBREADS

NOTICE :

SPECTIS ADHESIVE MUST BE USED ON ALL BEDDING/BUTT JOINTS.

BL 3135

- 12 3/4" Projection
- 9 1/4" Height
- 4" Width

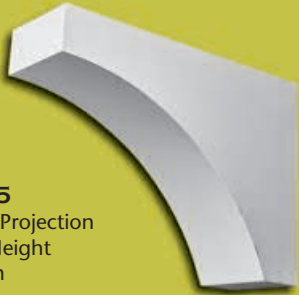

BL 2781

- 15" Projection
- 5 1/2" Height
- 18" Width

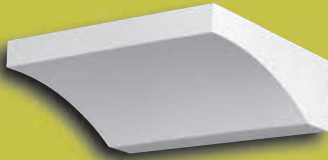

BL 2862

- 34 1/2" Projection
- 12" Height
- 2" Width



BL 2915

- 9 1/4" Projection
- 5" Height
- 7" Width



BL 2415

- 9" Projection
- 3 15/16" Height
- 4 1/8" Width



BL 3006

- 32" Projection
- 7 1/4" Height
- 6" Width



BL 2870

- 34" Projection
- 6 1/2" Height
- 2" Width



BL 2609L-5/12 BL 2609R-5/12

- 5/12 Pitch
- 9" Projection
- 5 3/16" Height
- 4 1/4" Width



BL 2611

- 20 3/8" Projection
- 4 1/2" Height
- 4 3/8" Width



BL 2888

- 16 5/8" Projection
- 5" Height
- 6 1/4" Width



BL 2718

- 22" Projection
- 11 1/4" Height
- 6" Width



BL 2991

- 17 5/8" Projection
- 12 1/2" Height
- 8" Width



BL 3176

- 13" Projection
- 5 1/2" Height
- 5 1/2" Width

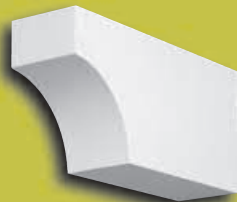

BL 2744

- 15" Projection
- 7 3/8" Height
- 4" Width



BL 3139

- 16" Projection
- 7 1/4" Height
- 3" Width

1 • 8 0 0 • 6 8 5 • 9 9 8 1

Blocks may come with
hollows in tops and/or backs



BLOCKS, BRACKETS & GINGERBREADS



BL 2992
 • 18" Projection
 • 7 1/4" Height
 • 3 1/4" Width

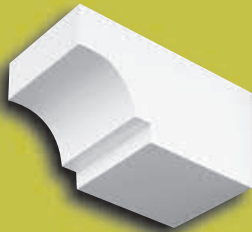

BL 2518
 • 12" Projection
 • 5 1/2" Height
 • 5 1/2" Width

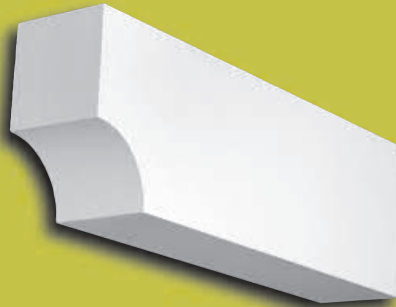

BL 2908
 • 30" Projection
 • 10" Height
 • 6" Width

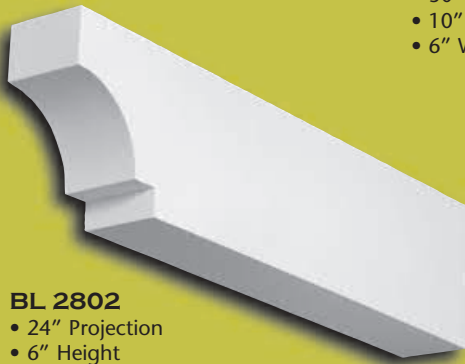

BL 2802
 • 24" Projection
 • 6" Height
 • 3" Width

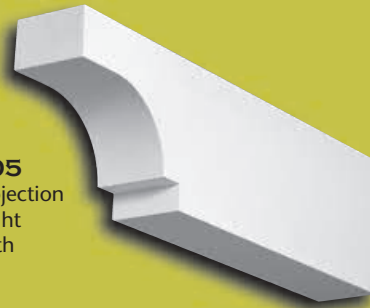

BL 2805
 • 21" Projection
 • 6" Height
 • 3" Width



BL 2924
 • 13 1/2" Projection
 • 7" Height
 • 2 3/4" Width



Photo above illustrates the use of Spectis blocks BL 2457.



BL 2978
 • 15" Projection
 • 15" Height
 • 6" Width



BL 2820RS
 • 27" Projection
 • 18" Height
 • 4" Width
 • **ROUGH SAWN**
 • **WOODTONE COLOUR**

FINISHING

All Spectis' products are shipped "double primed" with an exterior grade latex paint and are ready for use. We recommend final finishing after installation is complete for the most consistent appearance possible. Please see "finishing" recommendations (on page 267) for more information.





BLOCKS, BRACKETS & GINGERBREADS

NOTICE :

SPECTIS ADHESIVE MUST BE USED ON ALL BEDDING/BUTT JOINTS.



BL 2708

- 31" Projection
- 11 1/4" Height
- 8" Width



BL 2709

- 19" Projection
- 7 1/2" Height
- 8" Width



BL 2883

- 37" Projection
- 18 3/4" Height
- 18" Width



BL 2752

- 15" Projection
- 6" Height
- 6" Width



BL 2753

- 23" Projection
- 8" Height
- 8" Width



BL 2910

- 28 1/8" Projection
- 9 1/2" Height
- 6" Width



BL 2625

- 18" Projection
- 10 1/2" Height
- 7 1/4" Width

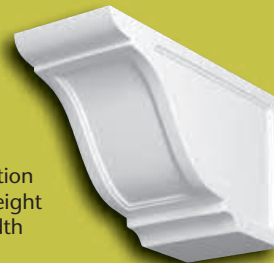

BL 2769

- 18" Projection
- 10 1/4" Height
- 7 1/4" Width



BL 2923

- 35" Projection
- 19" Height
- 10" Width



BL 3054

- 40" Projection
- 12 1/8" Height
- 7 1/4" Width



BL 3055

- 54 7/8" Projection
- 11 13/16" Height
- 7 1/4" Width



BL 3056

- 56 1/8" Projection
- 11 13/16" Height
- 7 1/4" Width

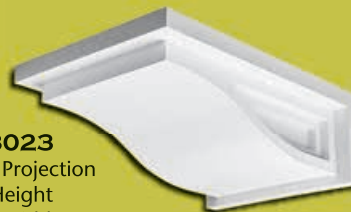

BL 3023

- 24" Projection
- 8" Height
- 16" Width

1 • 8 0 0 • 6 8 5 • 9 9 8 1



Blocks may come with
hollows in tops and/or backs

BLOCKS, BRACKETS & GINGERBREADS



- BL 2404**
- 7 3/4" Projection
 - 3 1/2" Height
 - 5" Width

BL 2404L-5/12

BL 2404R-5/12

- 5/12 Pitch

BL 2404L-7/12

BL 2404R-7/12

- 7/12 Pitch

BL 2404L-10/12

BL 2404R-10/12

- 10/12 Pitch

BL 2404R-12/12

BL 2404L-12/12

- 12/12 Pitch



- BL 2414**
- 18" Projection
 - 7 1/2" Height
 - 7" Width



- BL 2444**
- 7 3/4" Projection
 - 4" Height
 - 5 1/8" Width

BL 2444L-5/12

BL 2444R-5/12

- 5/12 Pitch

BL 2444L-6/12

BL 2444R-6/12

- 6/12 Pitch

BL 2444L-7/12

BL 2444R-7/12

- 7/12 Pitch

BL 2444L-8/12

BL 2444R-8/12

- 8/12 Pitch

BL 2444L-9/12

BL 2444R-9/12

- 9/12 Pitch



- BL 2469**
- 7 5/16" Projection
 - 4" Height
 - 4 3/4" Width

BL 2469L-5/12

BL 2469R-5/12

- 5/12 Pitch

BL 2469L-7/12

BL 2469R-7/12

- 7/12 Pitch

BL 2469L-9/12

BL 2469R-9/12

- 9/12 Pitch

BL 2469L-12/12

BL 2469R-12/12

- 12/12 Pitch

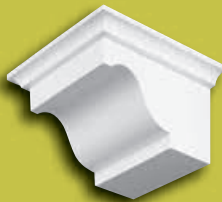

- BL 2999**
- 8 3/4" Projection
 - 6 1/2" Height
 - 6 7/8" Width

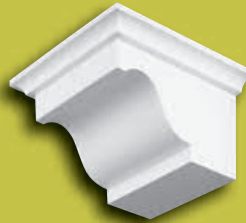

- BL 2509**
- 9 7/8" Projection
 - 5 3/4" Height
 - 8 5/8" Width



- BL 3131**
- 7" Projection
 - 5" Height
 - 6 1/4" Width



- BL 2519**
- 9 1/2" Projection
 - 5 3/4" Height
 - 5 3/8" Width



- BL 2525**
- 9 1/2" Projection
 - 5 3/4" Height
 - 5 7/8" Width



- BL 2526**
- 14" Projection
 - 5 3/4" Height
 - 8 5/8" Width



- BL 2905**
- 9 3/4" Projection
 - 5" Height
 - 5 1/2" Width

BL 2905L-6/12

BL 2905R-6/12

- 6/12 Pitch



- BL 2643**
- 17" Projection
 - 7 3/8" Height
 - 7" Width



- BL 2871**
- 9 1/2" Projection
 - 5 3/4" Height
 - 5 3/4" Width



- BL 3126**
- 4 7/8" Projection
 - 4 1/4" Height
 - 5 3/16" Width



- BL 2571**
- 6 1/2" Projection
 - 6" Height
 - 5 1/2" Width
- BL 2571L-6.5/12**
- BL 2571R-6.5/12**
- 6.5/12 Pitch



- BL 2556**
- 4 3/4" Projection
 - 2 1/8" Height
 - 3 1/8" Width

- BL 3146**
- 13 1/2" Projection
 - 8 1/2" Height
 - 9" Width
- BL 3146L-6/12**
- BL 3146R-6/12**
- 6/12 Pitch



www.spectis.com



Blocks may come with
hollows in tops and/or backs



BLOCKS, BRACKETS & GINGERBREADS

NOTICE :

SPECTIS ADHESIVE MUST BE USED ON ALL BEDDING/BUTT JOINTS.



BL 2486
• 8 1/2" Projection
• 5 1/4" Height
• 10" Width



BL 2628
• 8 3/8" Projection
• 4" Height
• 6 1/2" Width



BL 2629
• 6 1/2" Projection
• 3 1/2" Height
• 6" Width
BL 2629L-5/12
BL 2629R-5/12



BL 2630
• 5 3/8" Projection
• 3 1/8" Height
• 5 1/2" Width



BL 2641
• 5 1/2" Projection
• 2 1/2" Height
• 2 1/2" Width
BL 2641L-5/12
BL 2641R-5/12
• 5/12 Pitch
BL 2641L-6/12
BL 2641R-6/12
• 6/12 Pitch
BL 2641L-10/12
BL 2641R-10/12
• 10/12 Pitch



BL 2652
• 4 1/2" Projection
• 4" Height
• 4 9/16" Width



BL 2741
• 5 3/8" Projection
• 3 1/8" Height
• 5 3/8" Width



BL 2622
• 8" Projection
• 5 3/8" Height
• 5 3/8" Width



BL 2658L-8/12
BL 2658R-8/12
• 8/12 Pitch
• 7 1/4" Projection
• 7" Height
• 4 1/4" Width



BL 2968
• 23 3/4" Projection
• 10 11/16" Height
• 6 7/8" Width



BL 2873
• 32" Projection
• 6" Height
• 6" Width



BL 3040
• 66 3/8" Projection
• 12" Height
• 10" Width



BL 2909L-6/12
BL 2909R-6/12
• 12" Projection
• 7 1/2" Height
• 5 3/8" Width
• 6/12 Pitch
BL 2909L-7/12
BL 2909R-7/12
• 12" Projection
• 7 3/4" Height
• 5 3/8" Width
• 7/12 Pitch



BL 2439
• 22" Projection
• 13 1/2" Height
• 6 1/2" Width



BL 2911
• 12" Projection
• 5 1/2" Height
• 5 1/2" Width



BL 2914
• 14" Projection
• 5" Height
• 7" Width

1 • 8 0 0 • 6 8 5 • 9 9 8 1



Blocks may come with hollows in tops and/or backs

BLOCKS, BRACKETS & GINGERBREADS



- BL 2929**
- 9 3/4" Projection
 - 5 1/2" Height
 - 6 3/4" Width

- BL 2929L-6/12**
BL 2929R-6/12
- 9 3/4" Projection
 - 8 3/4" Height
 - 6 5/16" Width
 - 6/12 Pitch



- BL 2761**
- 10" Projection
 - 5" Height
 - 4 3/4" Width



- BL 2834**
- 10 3/4" Projection
 - 6 1/2" Height
 - 6 1/2" Width



- BL 2494**
- 13" Projection
 - 8" Height
 - 9" Width



- BL 2560**
- 9" Projection
 - 4" Height
 - 4 1/8" Width



- BL 2462**
- 8" Projection
 - 8" Height
 - 4 7/8" Width



- BL 2578**
- 8" Projection
 - 8" Height
 - 4 7/8" Width



- BL 2846**
- 11 1/8" Projection
 - 11 1/8" Height
 - 7 1/4" Width

- BL 2846L-10/12**
BL 2846R-10/12

- 11 1/8" Projection
- 18 9/16" Height
- 10/12 Pitch

- BL 2846L-15/12**
BL 2846R-15/12

- 11 1/8" Projection
- 23 3/8" Height
- 15/12 Pitch



- BL 2847L-15/12**
BL 2847R-15/12
- 11 1/8" Projection
 - 20 3/16" Height
 - 3 1/2" Width
 - 15/12 Pitch



- BL 2575**
- 8" Projection
 - 11" Height
 - 4 7/8" Width



- BL 2580**
- 4 1/4" Projection
 - 10 3/4" Height
 - 4 7/8" Width



- BL 2916**
- 3 1/4" Projection
 - 4 3/4" Height
 - 6 1/4" Width



- BL 2459**
- 5 1/2" Projection
 - 3" Height
 - 4 7/8" Width



- BL 2677**
- 5 3/4" Projection
 - 3 1/8" Height
 - 3 1/2" Width



- BL 2812**
- 6 1/2" Projection
 - 3 1/4" Height
 - 5 1/2" Width
- BL 2812L-8/12**
BL 2812R-8/12
- 8/12 Pitch



- BL 2813**
- 5 1/8" Projection
 - 2 11/16" Height
 - 4 5/8" Width



- BL 3057**
- 5 11/16" Projection
 - 3 1/2" Height
 - 4 1/2" Width



- BL 2848**
- 9 5/16" Projection
 - 5 3/8" Height
 - 8" Width



- BL 2488**
- 9 1/4" Projection
 - 6" Height
 - 7 1/8" Width





BLOCKS, BRACKETS & GINGERBREADS

NOTICE :

SPECTIS ADHESIVE MUST BE USED ON ALL BEDDING/BUTT JOINTS.



BL 2498

- 11 7/16" Projection
- 5 1/8" Height
- 5 3/4" Width

BL 2498L-6/12

- 6/12 Pitch



BL 2796

- 11 7/16" Projection
- 5 1/8" Height
- 9 3/8" Width

BL 2796L-10/12

BL 2796R-10/12

- 11 7/16" Projection
- 11 1/16" Height
- 10/12 Pitch

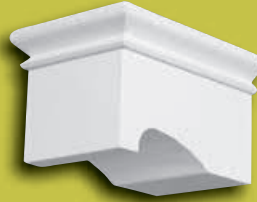

BL 2653

- 7 7/8" Projection
- 5" Height
- 5 3/4" Width



BL 2875

- 13 1/2" Projection
- 8 3/4" Height
- 6" Width



BL 2664

- 13" Projection
- 16 7/8" Height
- 4" Width



BL 2408

- 7 3/4" Projection
- 7" Height
- 5" Width

BL 2408R-10/12

BL 2408L-10/12

- 10/12 Pitch



BL 3063

- 21" Projection
- 6 3/4" Height
- 6" Width

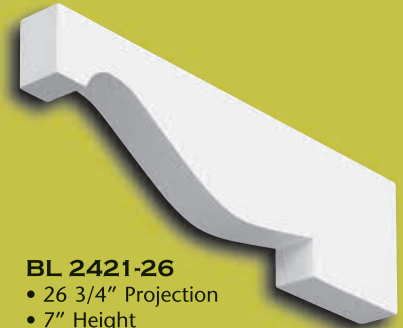

BL 2421-26

- 26 3/4" Projection
- 7" Height
- 2 1/2" Width

BL 2421-32

- 32 3/4" Projection
- 7" Height
- 2 1/2" Width



BL 3121

- 20" Projection
- 5 1/2" Height
- 2 1/2" Width



BL 2542

- 60" Projection
- 7" Height
- 5" Width

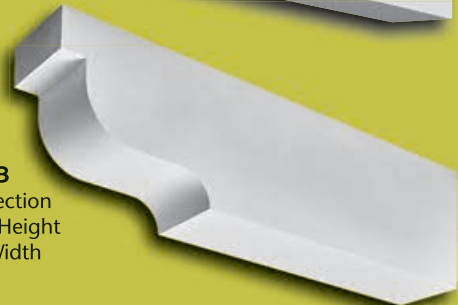

BL 3033

- 42" Projection
- 11 1/4" Height
- 7 1/4" Width



Photo above illustrates Spectis custom trellis & brackets

1 • 8 0 0 • 6 8 5 • 9 9 8 1



Blocks may come with
hollows in tops and/or backs

BLOCKS, BRACKETS & GINGERBREADS

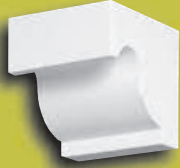

- BL 2801**
- 3 3/4" Projection
 - 3 5/8" Height
 - 3 11/16" Width



- BL 3069**
- 4 7/16" Projection
 - 3 1/2" Height
 - 4 1/2" Width



- BL 2944**
- 10" Projection
 - 9" Height
 - 7" Width

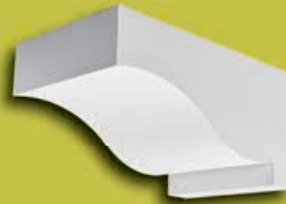

- BL 3093**
- 10 3/4" Projection
 - 5 1/4" Height
 - 6" Width



- BL 2663**
- 10 5/8" Projection
 - 8" Height
 - 2" Width

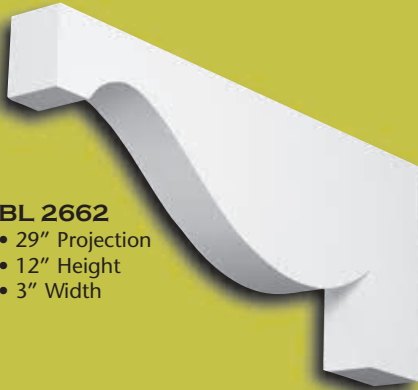

- BL 2662**
- 29" Projection
 - 12" Height
 - 3" Width



- BL 2572**
- 9 3/4" Projection
 - 5" Height
 - 3 1/2" Width



- BL 3166**
- 12" Projection
 - 14" Height
 - 3" Width



- BL 2790**
- 21 1/2" Projection
 - 12 1/2" Height
 - 3 1/2" Width

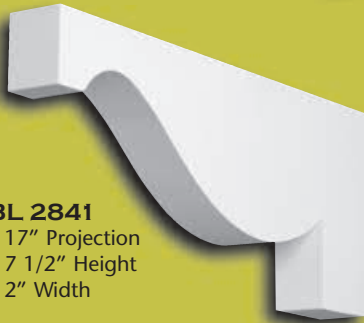

- BL 2841**
- 17" Projection
 - 7 1/2" Height
 - 2" Width

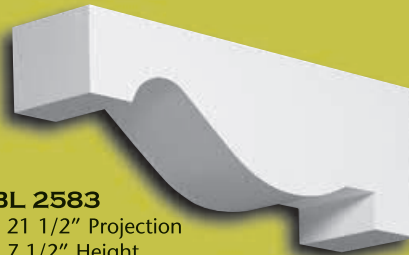

- BL 2583**
- 21 1/2" Projection
 - 7 1/2" Height
 - 5 1/2" Width

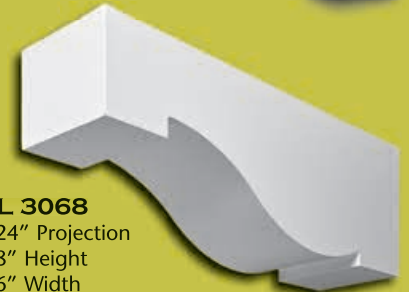

- BL 3068**
- 24" Projection
 - 8" Height
 - 6" Width



Photo above illustrates the use of Spectis brackets & headers with keystones



- BL 2748**
- 20" Projection
 - 7" Height
 - 3" Width

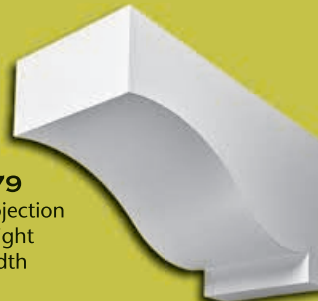

- BL 2979**
- 24" Projection
 - 12" Height
 - 10" Width





BLOCKS, BRACKETS & GINGERBREADS

NOTICE :

SPECTIS ADHESIVE MUST BE USED ON ALL BEDDING/BUTT JOINTS.

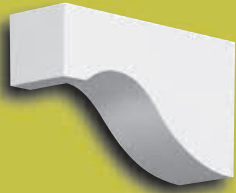

BL 2588

- 8 5/8" Projection
- 5" Height
- 2 3/4" Width

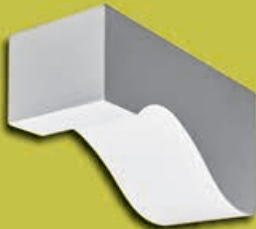

BL 3043

- 6 9/16" Projection
- 3 1/4" Height
- 2 13/16" Width



BL 2823

- 7 13/16" Projection
- 5 1/2" Height
- 3 11/16" Width

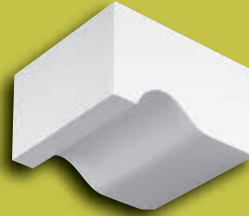

BL 2570

- 6 3/4" Projection
- 3" Height
- 5" Width

BL 2570L-9/12

BL 2570R-9/12

- 9/12 Pitch

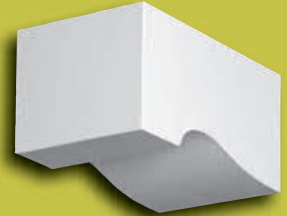

BL 2936

- 10" Projection
- 5 1/8" Height
- 6" Width

BL 2936L-6/12

BL 2936R-6/12

- 6/12 Pitch



BL 3159

- 7 1/4" Projection
- 6" Height
- 4" Width



BL 2840

- 3 1/8" Projection
- 5 1/2" Height
- 3 5/8" Width



BL 2860

- 9 1/2" Projection
- 6 3/8" Height
- 2 3/4" Width



BL 2858

- 13 1/2" Projection
- 4 1/2" Height
- 2 3/4" Width



BL 2667

- 7 1/2" Projection
- 3 7/8" Height
- 3 3/4" Width

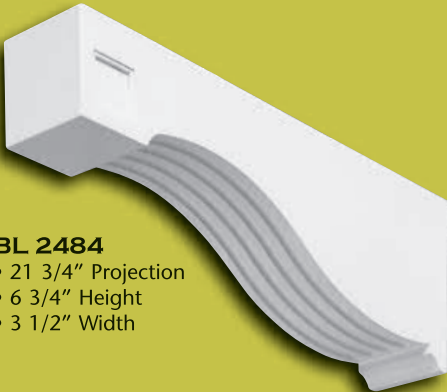

BL 2484

- 21 3/4" Projection
- 6 3/4" Height
- 3 1/2" Width



BL 2485

- 15 3/4" Projection
- 5 1/2" Height
- 3 1/2" Width



BL 2851

- 36" Projection
- 9" Height
- 6" Width



BL 2981

- 21 3/4" Projection
- 7 15/16" Height
- 3 1/2" Width



BL 2809

- 13" Projection
- 5 1/2" Height
- 3 1/2" Width

1 • 8 0 0 • 6 8 5 • 9 9 8 1



Blocks may come with hollows in tops and/or backs

BLOCKS, BRACKETS & GINGERBREADS



Photo above illustrates a custom Spectis gable end with blocks BL 2593.



- BL 2467**
- 10 1/2" Projection
 - 16" Height
 - 3" Width



- BL 2705**
- 12" Projection
 - 24" Height
 - 3 1/2" Width



- BL 2679**
- 7 7/8" Projection
 - 14 7/8" Height
 - 8 1/8" Width



- BL 2475**
- 13 1/4" Projection
 - 6" Height
 - 6" Width



- BL 2537**
- 15" Projection
 - 8" Height
 - 4" Width



- BL 2704**
- 12" Projection
 - 12" Height
 - 3 1/2" Width



- BL 2767**
- 6 1/8" Projection
 - 3 7/8" Height
 - 6 3/8" Width

- BL 2592-3.5**
- 14 3/4" Projection
 - 9" Height
 - 3 1/2" Width
- BL 2592-4.5**
- 4 1/2" Width
- BL 2592-5.5**
- 5 1/2" Width



- BL 2758**
- 5 1/8" Projection
 - 3 7/8" Height
 - 6 3/8" Width

www.spectis.com



Blocks may come with
hollows in tops and/or backs



BLOCKS, BRACKETS & GINGERBREADS

NOTICE :

SPECTIS ADHESIVE MUST BE USED ON ALL BEDDING/BUTT JOINTS.



BL 2889PC

- 35 1/4" Projection
- 8 3/4" Height
- 6 1/2" Width
- PECKY CYPRESS
- WOODTONE COLOUR



BL 2897PC

- 43 1/4" Projection
- 20 1/4" Height
- 13 1/2" Width
- PECKY CYPRESS
- WOODTONE COLOUR



BL 2899PC

- 17 1/4" Projection
- 8 3/4" Height
- 6 1/2" Width
- PECKY CYPRESS
- WOODTONE COLOUR



Photo above shows the use of Spectis custom brackets in pecky cypress texture



BL 2898PC

- 35 1/4" Projection
- 9 1/4" Height
- 6" Width
- PECKY CYPRESS
- WOODTONE COLOUR



BL 3012RS

- 17 1/4" Projection
- 8 1/2" Height
- 6 1/2" Width

1 • 8 0 0 • 6 8 5 • 9 9 8 1



Blocks may come with hollows in tops and/or backs

BLOCKS, BRACKETS & GINGERBREADS



BL 2413
 • 4 3/4" Projection
 • 6 3/16" Height
 • 3" Width



BL 2424
 • 5 7/16" Projection
 • 5 7/8" Height
 • 4" Width

BL 2424R-5/12

BL 2424L-5/12
 • 5/12 Pitch

BL 2424R-7/12

BL 2424L-7/12
 • 7/12 Pitch

BL 2424R-10/12

BL 2424L-10/12
 • 10/12 Pitch



BL 2461
 • 5" Projection
 • 6 3/16" Height
 • 4 3/4" Width



BL 3167
 • 13 1/4" Projection
 • 9 1/4" Height
 • 3 1/4" Width

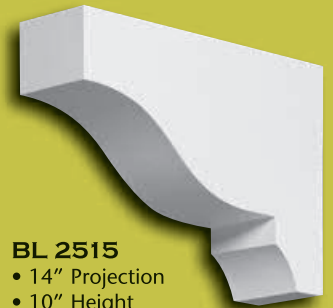

BL 2515
 • 14" Projection
 • 10" Height
 • 4" Width



BL 2634
 • 5 7/16" Projection
 • 5 7/8" Height
 • 6" Width



BL 2657
 • 2" Projection
 • 4" Height
 • 3" Width



BL 2674
 • 5 7/16" Projection
 • 5 7/8" Height
 • 2 1/4" Width

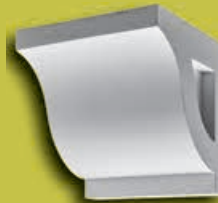

BL 3077
 • 5 7/16" Projection
 • 5 7/8" Height
 • 12" Width

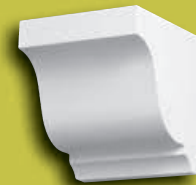

BL 2795
 • 5 1/2" Projection
 • 5 3/4" Height
 • 5 1/2" Width



BL 2878
 • 5" Projection
 • 5 7/8" Height
 • 2 1/4" Width



BL 2711
 • 5" Projection
 • 5 7/8" Height
 • 4" Width

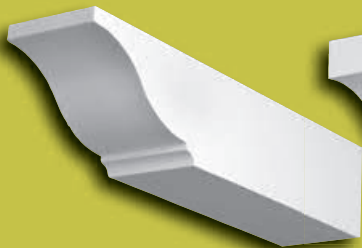

BL 2963-7.75
 • 7 3/4" Projection
 • 4" Height
 • 4" Width

BL 2963-14
 • 14" Projection
 • 4" Height
 • 4" Width

BL 2963-18
 • 18" Projection
 • 4" Height
 • 4" Width

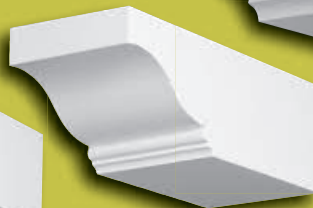

BL 2806
 • 12" Projection
 • 4" Height
 • 5" Width



BL 2947
 • 72" Projection
 • 8" Height
 • 8 1/2" Width



BL 3099
 • 4" Projection
 • 8" Height
 • 7" Width



BL 3100
 • 5" Projection
 • 8" Height
 • 7" Width



BL 2479
 • 7" Projection
 • 11" Height
 • 6" Width



BL 3106
 • 10" Projection
 • 12" Height
 • 4" Width



BL 2441
 • 7" Projection
 • 12" Height
 • 12" Width
BL 2441R-10/12
BL 2441L-10/12
 • 10/12 Pitch





BLOCKS, BRACKETS & GINGERBREADS

NOTICE :

SPECTIS ADHESIVE MUST BE USED ON ALL BEDDING/BUTT JOINTS.

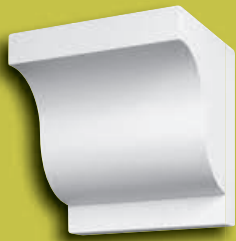

BL 2490
• 10" Projection
• 12" Height
• 12" Width



BL 3002
• 10" Projection
• 15" Height
• 6" Width



BL 3003
• 18" Projection
• 24" Height
• 3" Width



BL 2432
• 14" Projection
• 15 3/4" Height
• 4" Width



BL 2447FS
• 14" Projection
• 15 3/4" Height
• 4" Width
• **FOSSIL STONE**



BL 2500
• 5" Projection
• 6 1/4" Height
• 4 3/4" Width



BL 2500L-6/12

BL 2500R-6/12

• 6/12 Pitch

BL 2500L-7/12

BL 2500R-7/12

• 7/12 Pitch

BL 2500L-10/12

BL 2500R-10/12

• 10/12 Pitch



BL 2637
• 5 3/4" Projection
• 5" Height
• 3" Width



BL 2638
• 4" Projection
• 6 1/2" Height
• 3" Width



BL 2654
• 9 3/8" Projection
• 6" Height
• 3" Width



BL 3150PC
• 8" Projection
• 7" Height
• 4" Width



BL 3151PC
• 15 1/4" Projection
• 10" Height
• 4" Width



BL 3152PC
• 16" Projection
• 10" Height
• 6" Width



BL 3153PC
• 20" Projection
• 7 3/4" Height
• 4" Width

1 • 8 0 0 • 6 8 5 • 9 9 8 1



Blocks may come with
hollows in tops and/or backs

BLOCKS, BRACKETS & GINGERBREADS



BL 2728
 • 20" Projection
 • 9" Height
 • 8" Width



BL 2881
 • 10" Projection
 • 16" Height
 • 6" Width



BL 2973
 • 12 5/8" Projection
 • 9" Height
 • 3" Width



BL 2656
 • 14" Projection
 • 10" Height
 • 4" Width



BL 2948
 • 8 1/2" Projection
 • 10 1/2" Height
 • 3" Width



BL 2949
 • 8 1/2" Projection
 • 8 1/2" Height
 • 3" Width



BL 2952
 • 2" Projection
 • 3" Height
 • 3" Width



BL 2986
 • 3 9/16" Projection
 • 5 1/4" Height
 • 3 1/2" Width



BL 2791
 • 3 1/2" Projection
 • 5 1/2" Height
 • 3 1/2" Width



BL 3112RS
 • 7 3/8" Projection
 • 9" Height
 • 7 3/8" Width



BL 3102RS
 • 7 3/8" Projection
 • 16" Height
 • 7 3/8" Width



BL 2586
 • 11 1/4" Projection
 • 14 1/4" Height
 • 3" Width



BL 2623
 • 7 5/8" Projection
 • 6" Height
 • 2" Width



BL 2631
 • 8" Projection
 • 5 3/8" Height
 • 5 3/8" Width



BL 2670
 • 5 3/4" Projection
 • 8" Height
 • 3 1/2" Width



BL 2624
 • 10 1/8" Projection
 • 8" Height
 • 3" Width

www.spectis.com



Blocks may come with
hollows in tops and/or backs



BLOCKS, BRACKETS & GINGERBREADS

NOTICE :

SPECTIS ADHESIVE MUST BE USED ON ALL BEDDING/BUTT JOINTS.

BL 3164WG

- 14" Projection
- 13" Height
- 6" Width



BL 2815RS

- 22" Projection
- 16" Height
- 4" Width
- ROUGH SAWN
- WOODTONE COLOUR



BL 2906

- 18" Projection
- 24" Height
- 3" Width



BL 2732-24

- 24" Projection
- 10" Height
- 6" Width

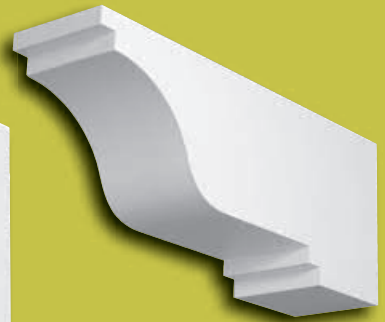

BL 2732-48

- 48" Projection
- 10" Height
- 6" Width



BL 2536

- 5" Projection
- 5" Height
- 4" Width



BL 2833

- 13" Projection
- 11 7/8" Height
- 8" Width



BL 2839

- 4 3/4" Projection
- 4 3/4" Height
- 3" Width



BL 2958

- 6 1/2" Projection
- 7 1/4" Height
- 5 1/2" Width



BL 2959

- 7 1/2" Projection
- 7 1/4" Height
- 5 1/2" Width



BL 2768

- 30" Projection
- 11" Height
- 6" Width



BL 2433

- 3" Projection
- 5 1/8" Height
- 2 3/16" Width



BL 2587

- 3" Projection
- 3 1/2" Height
- 1 1/2" Width



BL 2466

- 30" Projection
- 32 1/4" Height
- 10" Width



BL 2738

- 6 3/4" Projection
- 6 3/8" Height
- 5" Width



BL 2676

- 6 7/8" Projection
- 5 3/8" Height
- 4 3/8" Width

1 • 8 0 0 • 6 8 5 • 9 9 8 1



Blocks may come with hollows in tops and/or backs

BLOCKS, BRACKETS & GINGERBREADS



- BL 2402**
- 9 1/2" Projection
 - 4 3/4" Height
 - 5 7/8" Width



- BL 2405**
- 11 1/4" Projection
 - 3" Height
 - 11 1/4" Width
- BL 2405L-6/12**
BL 2405R-6/12
- 6/12 Pitch



- BL 2416**
- 7 3/4" Projection
 - 3 3/8" Height
 - 5 1/8" Width
- BL 2416L-7.5/12**
BL 2416R-7.5/12
- 7.5/12 Pitch
- BL 2416L-9/12**
BL 2416R-9/12
- 9/12 Pitch
- BL 2416L-12/12**
BL 2416R-12/12
- 12/12 Pitch



- BL 2474**
- 7" Projection
 - 4" Height
 - 4" Width



- BL 2573**
- 6" Projection
 - 4" Height
 - 4" Width

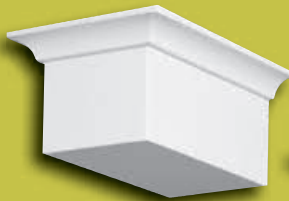

- BL 2573L-6/12**
BL 2573R-6/12
- 6/12 Pitch



- BL 2842**
- 7 1/4" Projection
 - 3 3/8" Height
 - 5" Width



- BL 2539**
- 3 3/4" Projection
 - 5 11/16" Height
 - 7 1/2" Width

- BL 2573L-10/12**
BL 2573R-10/12
- 10/12 Pitch

- BL 2907**
- 9 1/2" Projection
 - 3" Height
 - 8 1/2" Width



- BL 2524**
- 1 5/8" Projection
 - 5 1/2" Height
 - 6 5/8" Width



- BL 3157**
- 9" Projection
 - 5" Height
 - 8 5/8" Width



- BL 2401**
- 15" Projection
 - 6" Height
 - 9 5/8" Width



- BL 2540**
- 3 3/4" Projection
 - 3 11/16" Height
 - 5 1/2" Width

- BL 2967**
- 7" Projection
 - 5 7/16" Height
 - 8 1/2" Width



- BL 2454**
- 7" Projection
 - 11 1/4" Height
 - 17 1/2" Width



- BL 2523**
- 4 1/4" Projection
 - 5 1/2" Height
 - 6 5/8" Width

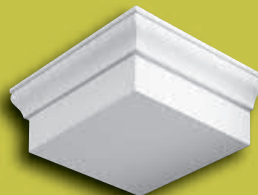

- BL 2554**
- 9 7/8" Projection
 - 4" Height
 - 10 3/4" Width



- BL 2736**
- 9 1/4" Projection
 - 5" Height
 - 9 5/8" Width

- BL 3147**
- 10" Projection
 - 6 5/8" Height
 - 13 3/4" Width





BLOCKS, BRACKETS & GINGERBREADS

NOTICE :

SPECTIS ADHESIVE MUST BE USED ON ALL BEDDING/BUTT JOINTS.



- BL 2546**
- 1 7/8" Projection
 - 6" Height
 - 6" Width



- BL 3120**
- 3 13/16" Projection
 - 5 7/8" Height
 - 5 1/8" Width

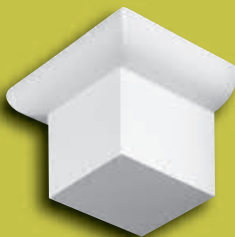

- BL 2569**
- 4 1/4" Projection
 - 3" Height
 - 4" Width

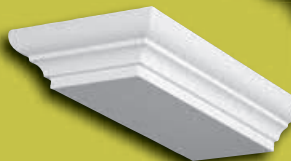

- BL 3080**
- 9 3/4" Projection
 - 2 1/2" Height
 - 5 11/16" Width



- BL 2584**
- 8 5/8" Projection
 - 5" Height
 - 12 1/4" Width

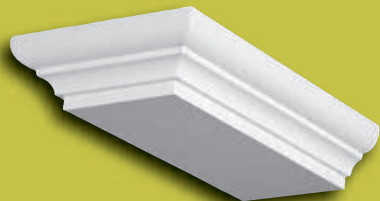

- BL 2818**
- 10 3/4" Projection
 - 1 15/16" Height
 - 5 5/8" Width

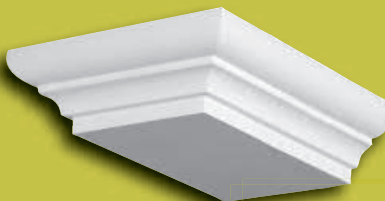

- BL 2819**
- 7 1/2" Projection
 - 1 15/16" Height
 - 5 5/8" Width



- BL 2660**
- 15 1/2" Projection
 - 11 3/4" Height
 - 10 1/2" Width



- BL 2997**
- 8" Projection
 - 4" Height
 - 10" Width



- BL 3062**
- 7" Projection
 - 4" Height
 - 9" Width
- BL 3062L-7/12**
BL 3062R-7/12



- BL 2937**
- 12 1/2" Projection
 - 9" Height
 - 15" Width



- BL 2501**
- 7 3/4" Projection
 - 2 5/8" Height
 - 9 1/4" Width



- BL 2443**
- 4 7/8" Projection
 - 2 1/2" Height
 - 5" Width



- BL 2808L**
BL 2808R
- 3" Projection
 - 1 1/8" Height
 - 6 1/2" Width



- BL 2595**
- 6 1/8" Projection
 - 4 1/8" Height
 - 4 13/16" Width



Photo above shows the use of Spectis custom bracket and pilaster.

1 • 8 0 0 • 6 8 5 • 9 9 8 1



Blocks may come with hollows in tops and/or backs

BLOCKS, BRACKETS & GINGERBREADS



BL 2403

- 4 1/8" Projection
- 5" Height
- 3 7/8" Width



BL 2442

- 4 3/4" Projection
- 6" Height
- 12" Width



BL 2495

- 5 1/2" Projection
- 4 1/2" Height
- 4 1/2" Width



BL 3105

- 5 3/4" Projection
- 5 3/4" Height
- 5 3/4" Width



BL 2528

- 8" Projection
- 1 1/2" Height
- 7 11/16" Width



BL 2470FS

- 9" Projection
- 9" Height
- 4 1/2" Width
- FOSSIL STONE

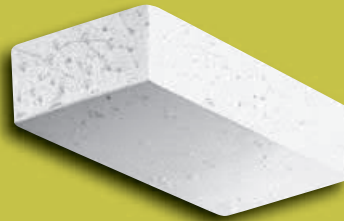

BL 2471FS

- 9" Projection
- 2" Height
- 4 1/2" Width
- FOSSIL STONE



BL 2491

- 6" Projection
- 6" Height
- 6" Width

BL 2491L-8/12

BL 2491R-8/12

- 8/12 Pitch



BL 2984

- 4" Projection
- 8" Height
- 6" Width

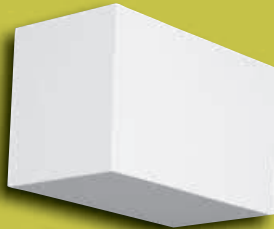

BL 2640

- 8" Projection
- 5" Height
- 4 1/4" Width



BL 2684

- 1 1/2" Projection
- 6 3/8" Height
- 3 1/4" Width



BL 2886

- 3" Projection
- 4 7/8" Height
- 9" Width

BL 2886L-12/12

BL 2886R-12/12

- 3" Projection
- 4 7/8" Height
- 13 7/8" Width
- 12/12 Pitch



BL 2722

- 10" Projection
- 8 1/2" Height
- 10" Width

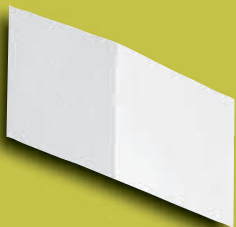

BL 2759-6/12

- 2 7/8" Projection
- 1 7/8" Height
- 7 3/8" Width
- 6/12 Pitch

BL 2759-10/12

- 3 3/8" Projection
- 1 5/8" Height
- 7 3/8" Width
- 10/12 Pitch



BL 2613

- 13 1/2" Projection
- 5 1/2" Height
- 25" Width



BL 2760

- 5 1/2" Projection
- 7" Height
- 3 1/4" Width





BLOCKS, BRACKETS & GINGERBREADS

NOTICE :

SPECTIS ADHESIVE MUST BE USED ON ALL BEDDING/BUTT JOINTS.



BL 2799
• 1" Projection
• 3 1/2" Height
• 3 1/2" Width



BL 3127
• 8 1/4" Projection
• 4" Height
• 4" Width

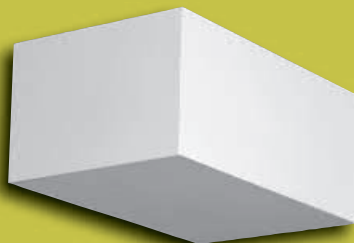

BL 2861
• 10 1/8" Projection
• 4 7/16" Height
• 6 1/2" Width



BL 2877
• 13" Projection
• 6" Height
• 3" Width

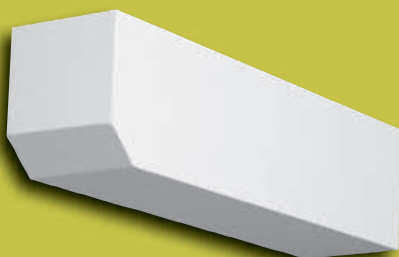

BL 2919
• 15" Projection
• 4" Height
• 3 1/2" Width



BL 3129
• 22" Projection
• 7 1/2" Height
• 5 1/2" Width



BL 2933
• 1 3/4" Projection
• 4 1/2" Height
• 6" Width



BL 3095
• 2 3/8" Projection
• 7 3/4" Height
• 4 3/4" Width



BL 2940
• 4 1/2" Projection
• 8" Height
• 5 1/2" Width



BL 2941
• 3 1/2" Projection
• 5 1/2" Height
• 3 1/2" Width

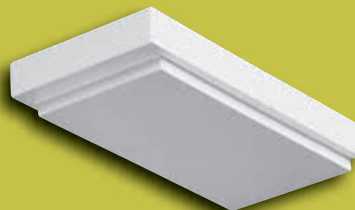

BL 2455
• 14 1/4" Projection
• 2" Height
• 7 1/2" Width



BL 2545
• 2 1/4" Projection
• 6 1/2" Height
• 6 1/2" Width



BL 2699
• 18" Projection
• 10 5/8" Height
• 7 3/4" Width



BL 3070
• 3 7/8" Projection
• 7" Height
• 6 1/4" Width



BL 2435
• 5 3/8" Projection
• 4" Height
• 4" Width



BL 2714
• 4" Projection
• 12" Height
• 8" Width

1 • 8 0 0 • 6 8 5 • 9 9 8 1



Blocks may come with hollows in tops and/or backs

BLOCKS, BRACKETS & GINGERBREADS



BL 2965
 • 15" Projection
 • 14" Height
 • 3 1/2" Width



BL 3027
 • 16" Projection
 • 8" Height
 • 8" Width

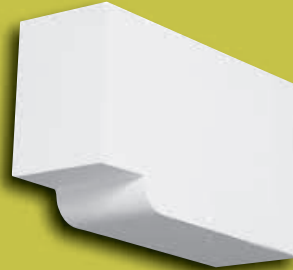

BL 2619
 • 10 1/2" Projection
 • 6" Height
 • 3 1/2" Width



BL 2794
 • 11" Projection
 • 10 3/4" Height
 • 7 1/2" Width



BL 2513
 • 20" Projection
 • 20" Height
 • 4" Width



BL 3092
 • 12" Projection
 • 5 1/2" Height
 • 3 3/4" Width



BL 3149
 • 9 1/2" Projection
 • 6" Height
 • 6" Width



BL 2785
 • 10" Projection
 • 10" Height
 • 5" Width



BL 3172
 • 4" Projection
 • 5" Height
 • 5" Width



BL 2633
 • 30" Projection
 • 35 5/8" Height
 • 14 5/8" Width



BL 2553
 • 15" Projection
 • 17 1/2" Height
 • 6" Width



BL 3032
 • 5 1/2" Projection
 • 5" Height
 • 5 1/2" Width



BL 2749
 • 6 1/2" Projection
 • 6" Height
 • 4" Width



BL 2780
 • 11" Projection
 • 9" Height
 • 3 3/8" Width



BL 3177
 • 18" Projection
 • 24 1/8" Height
 • 3" Width



BL 2824
 • 26" Projection
 • 18" Height
 • 8" Width



BL 3083
 • 30" Projection
 • 35" Height
 • 6" Width

www.spectis.com



Blocks may come with
hollows in tops and/or backs



BLOCKS, BRACKETS & GINGERBREADS

NOTICE :

SPECTIS ADHESIVE MUST BE USED ON ALL BEDDING/BUTT JOINTS.



BL 2825
• 15" Projection
• 11" Height
• 8" Width



BL 3059
• 6 1/8" Projection
• 4 1/4" Height
• 1 1/2" Width



BL 2585
• 12" Projection
• 16" Height
• 6" Width



BL 2651
• 14" Projection
• 16" Height
• 6" Width



BL 2438
• 9" Projection
• 9" Height
• 3 1/2" Width

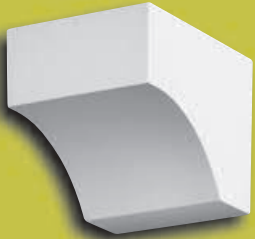

BL 2493
• 11" Projection
• 8" Height
• 8 1/8" Width



BL 2616
• 2" Projection
• 3" Height
• 4" Width



BL 2985
• 2" Projection
• 3" Height
• 6" Width



BL 2702
• 4" Projection
• 4" Height
• 6" Width



BL 2548
• 10" Projection
• 10" Height
• 1 1/2" Width



BL 2726
• 6" Projection
• 6" Height
• 1 1/2" Width



BL 3018
• 3 1/8" Projection
• 3 1/8" Height
• 3" Width



BL 2731
• 5 1/2" Projection
• 5 1/2" Height
• 3 1/2" Width



BL 2751
• 6" Projection
• 6" Height
• 4" Width



BL 2976
• 11 1/4" Projection
• 11 1/4" Height
• 3 1/2" Width



BL 2750
• 12" Projection
• 12" Height
• 8" Width



BL 3021
• 9 3/4" Projection
• 11" Height
• 17 3/4" Width



BL 2763
• 12" Projection
• 14" Height
• 2" Width

1 • 8 0 0 • 6 8 5 • 9 9 8 1



Blocks may come with hollows in tops and/or backs

BLOCKS, BRACKETS & GINGERBREADS



Photo above shows the use of Spectris brackets in rough sawn texture



- BL 3189**
- 12" Projection
 - 17" Height
 - 5 1/2" Width



- BL 3114**
- 15 1/4" Projection
 - 24" Height
 - 5 1/4" Width



- BL 2814RS**
- 18" Projection
 - 12" Height
 - 4" Width
 - **ROUGH SAWN**
 - **WOODTONE COLOUR**



- BL 3137**
- 7" Projection
 - 9 1/4" Height
 - 4" Width



- BL 3136**
- 12 3/4" Projection
 - 18" Height
 - 8" Width



- BL 2849**
- 14" Projection
 - 18" Height
 - 4" Width



- BL 2853**
- 24" Projection
 - 24" Height
 - 8" Width



- BL 3181**
- 38" Projection
 - 38" Height
 - 8" Width



- BL 2950**
- 4 1/4" Projection
 - 5 3/4" Height
 - 3" Width



- BL 3134**
- 5" Projection
 - 9 1/4" Height
 - 4" Width





BLOCKS, BRACKETS & GINGERBREADS

NOTICE :

SPECTIS ADHESIVE MUST BE USED ON ALL BEDDING/BUTT JOINTS.



BL 3089
• 11" Projection
• 11" Height
• 3" Width



BL 2954
• 12" Projection
• 12" Height
• 4" Width



BL 3171
• 14" Projection
• 14" Height
• 4" Width



BL 2504
• 6" Projection
• 4" Height
• 4" Width

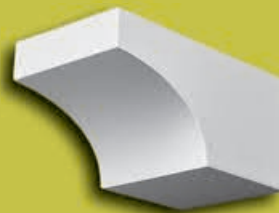

BL 2971
• 7" Projection
• 3 1/2" Height
• 4" Width

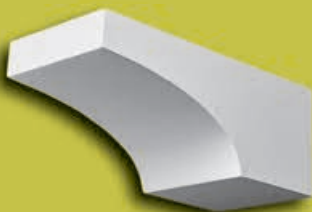

BL 2972
• 9" Projection
• 3 1/2" Height
• 4" Width

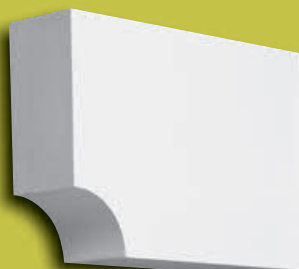

BL 2593
• 20" Projection
• 14 1/2" Height
• 6" Width



BL 2964
• 10" Projection
• 7" Height
• 3 1/2" Width

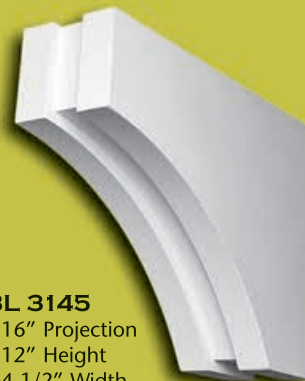

BL 3145
• 16" Projection
• 12" Height
• 4 1/2" Width



BL 2826
• 6" Projection
• 6" Height
• 4" Width



BL 2582
• 4 1/2" Projection
• 7 5/16" Height
• 2" Width



BL 2489
• 10" Projection
• 8" Height
• 4" Width



BL 2890
• 9 1/2" Projection
• 10 3/4" Height
• 3 1/2" Width

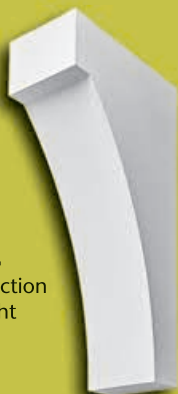

BL 3184
• 12" Projection
• 23" Height
• 6" Width



BL 3096
• 8" Projection
• 20 1/2" Height
• 4" Width



BL 2719
• 5 1/4" Projection
• 6" Height
• 12" Width



BL 2612
• 5 5/16" Projection
• 5" Height
• 3" Width

1 • 8 0 0 • 6 8 5 • 9 9 8 1



Blocks may come with
hollows in tops and/or backs

BLOCKS, BRACKETS & GINGERBREADS



BL 2792
 • 3" Projection
 • 3" Height
 • 6" Width



BL 2857
 • 2 7/8" Projection
 • 2 3/4" Height
 • 6" Width



BL 2884
 • 20" Projection
 • 15" Height
 • 3" Width



BL 3014
 • 4" Projection
 • 9 1/4" Height
 • 3 1/2" Width



BL 2521
 • 11 7/8" Projection
 • 16" Height
 • 3" Width



BL 2532
 • 16" Projection
 • 17" Height
 • 6" Width



BL 2885
 • 9 1/4" Projection
 • 9 1/4" Height
 • 3" Width



BL 3140
 • 18" Projection
 • 18" Height
 • 3 3/8" Width

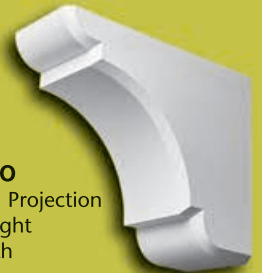

BL 3170
 • 14 1/2" Projection
 • 12" Height
 • 6" Width



BL 2431
 • 14 1/2" Projection
 • 14 1/2" Height
 • 3 1/2" Width



BL 2480
 • 24" Projection
 • 24" Height
 • 5 1/4" Width



BL 2533
 • 12" Projection
 • 13" Height
 • 5 1/2" Width



BL 3180
 • 11 1/2" Projection
 • 9 1/2" Height
 • 6" Width



BL 2618
 • 12" Projection
 • 12" Height
 • 3 1/2" Width



BL 2639
 • 30" Projection
 • 30" Height
 • 7" Width



BL 2717
 • 18" Projection
 • 18" Height
 • 5 1/4" Width



BL 2810
 • 20" Projection
 • 19 1/2" Height
 • 2" Width





BLOCKS, BRACKETS & GINGERBREADS

NOTICE :

SPECTIS ADHESIVE MUST BE USED ON ALL BEDDING/BUTT JOINTS.

BL 2970

- 29 1/2" Projection
- 22" Height
- 3" Width

BL 2577

- 18" Projection
- 16 1/2" Height
- 4" Width

BL 3098

- 36" Projection
- 30" Height
- 7" Width

BL 2589

- 15" Projection
- 20" Height
- 5" Width

BL 2893

- 10" Projection
- 10" Height
- 1 1/2" Width

BL 3168

- 18" Projection
- 18" Height
- 3 1/2" Width

BL 3091WC

- 27" Projection
- 30" Height
- 6" Width

BL 2934

- 27" Projection
- 27" Height
- 6" Width

BL 3128

- 21" Projection
- 30" Height
- 5 1/4" Width

BL 2975

- 29" Projection
- 29" Height
- 5" Width

BL 3010

- 30" Projection
- 30" Height
- 7" Width

BL 3125

- 24" Projection
- 24" Height
- 3" Width

BL 3097

- 30" Projection
- 30" Height
- 7" Width

1 • 8 0 0 • 6 8 5 • 9 9 8 1



Blocks may come with
hollows in tops and/or backs

BLOCKS, BRACKETS & GINGERBREADS



BL 3141
 • 36" Projection
 • 36" Height
 • 3" Width



BL 3037
 • 18" Projection
 • 24 1/4" Height
 • 3 1/2" Width



BL 2859
 • 18" Projection
 • 24" Height
 • 5 1/2" Width



BL 3047
 • 18" Projection
 • 18" Height
 • 4" Width



BL 3042
 • 20" Projection
 • 20" Height
 • 4" Width



BL 2503
 • 30 1/8" Projection
 • 30 1/8" Height
 • 6 1/16" Width



BL 2520
 • 29" Projection
 • 21 7/16" Height
 • 4" Width



BL 2700
 • 27 1/2" Projection
 • 27 1/2" Height
 • 2 1/2" Width



BL 3178
 • 44" Projection
 • 32" Height
 • 5" Width



BL 2601
 • 10" Projection
 • 10" Height
 • 4" Width



BL 2602
 • 16" Projection
 • 16" Height
 • 4" Width



BL 3085
 • 24" Projection
 • 24" Height
 • 4" Width



BL 2446
 • 13 1/2" Projection
 • 13 1/2" Height
 • 3 1/2" Width





BLOCKS, BRACKETS & GINGERBREADS

NOTICE :

SPECTIS ADHESIVE MUST BE USED ON ALL BEDDING/BUTT JOINTS.



BL 2721
• 14 1/2" Projection
• 24" Height
• 4" Width



BL 2957
• 22" Projection
• 24" Height
• 5 1/2" Width



BL 3163WG
• 26" Projection
• 24" Height
• 6" Width



BL 2723
• 25" Projection
• 18 1/16" Height
• 6" Width



BL 2594
• 12 3/8" Projection
• 23" Height
• 2 1/2" Width



BL 2688
• 36" Projection
• 30" Height
• 5" Width



BL 2786
• 18" Projection
• 18 1/8" Height
• 6" Width



BL 3084
• 28" Projection
• 22 3/8" Height
• 6" Width



BL 2543
• 12" Projection
• 36 9/16" Height
• 3 1/2" Width



BL 2745
• 18" Projection
• 24" Height
• 6" Width



BL 2746
• 18" Projection
• 36" Height
• 6" Width



BL 2747
• 14" Projection
• 24" Height
• 6" Width



BL 3011
• 13" Projection
• 28" Height
• 6" Width

1 • 8 0 0 • 6 8 5 • 9 9 8 1



Blocks may come with
hollows in tops and/or backs

BLOCKS, BRACKETS & GINGERBREADS



BL 2856

- 23 3/8" Projection
- 44 3/4" Height
- 8" Width



BL 3009

- 26 3/4" Projection
- 29" Height
- 5 1/2" Width



BL 3008

- 56" Projection
- 45" Height
- 5 1/2" Width



BL 3030

- 14 1/2" Projection
- 14 1/2" Height
- 5" Width



BL 3031

- 24" Projection
- 24" Height
- 5" Width



BL 3076

- 24 3/4" Projection
- 42" Height
- 5" Width

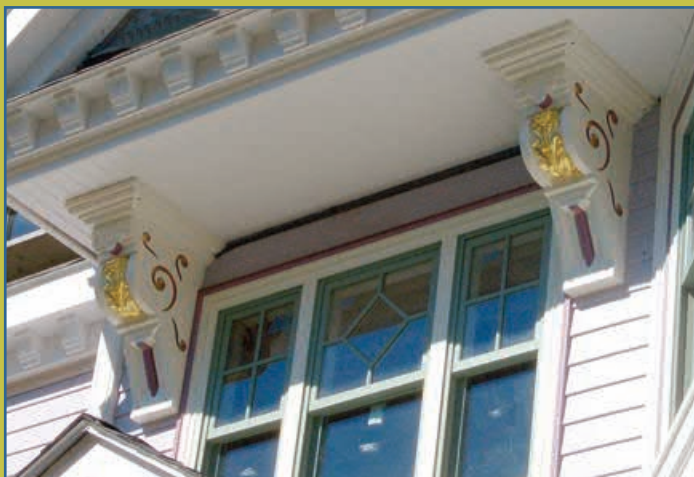

Photo above shows the use of Spectis block BL 2440.

BL 2894

- 20 1/2" Projection
- 65 3/4" Height
- 3 3/4" Width



BL 2698

- 30 3/4" Projection
- 30 3/4" Height
- 8" Width





BLOCKS, BRACKETS & GINGERBREADS

NOTICE :

SPECTIS ADHESIVE MUST BE USED ON ALL BEDDING/BUTT JOINTS.

BL 2703

- 30 3/4" Projection
- 30 3/4" Height
- 5" Width

BL 2465-15

- 15" Projection
- 24" Height
- 3 1/2" Width

BL 2465-28

- 28" Projection
- 30" Height
- 3 1/2" Width

BL 2650

- 28" Projection
- 30" Height
- 6" Width

BL 2689

- 30" Projection
- 28" Height
- 4" Width

BL 2735

- 36 1/4" Projection
- 42 1/4" Height
- 3 1/2" Width

BL 3073

- 36 3/4" Projection
- 43 7/8" Height
- 5" Width

BL 2567

- 32" Projection
- 32" Height
- 6" Width

BL 3111

- 34 1/4" Projection
- 41 1/4" Height
- 5 3/4" Width

BL 2879

- 26" Projection
- 46" Height
- 7 1/2" Width

BL 2665

- 17 1/2" Projection
- 17 1/2" Height
- 6" Width

BL 2716

- 22 3/4" Projection
- 22 3/4" Height
- 6" Width

BL 2715

- 29" Projection
- 29" Height
- 6" Width

1 • 8 0 0 • 6 8 5 • 9 9 8 1



Blocks may come with
hollows in tops and/or backs

BLOCKS, BRACKETS & GINGERBREADS



BL 3065
 • 47" Projection
 • 47" Height
 • 8" Width



BL 2831
 • 24" Projection
 • 25" Height
 • 4" Width



BL 3082WG
 • 36" Projection
 • 46" Height
 • 8" Width



BL 3081WG
 • 42" Projection
 • 41 1/4" Height
 • 8" Width



BL 2917
 • 37" Projection
 • 38" Height
 • 3 1/2" Width



BL 2591
 • 15" Projection
 • 18" Height
 • 3 1/2" Width



BL 3035
 • 24" Projection
 • 26" Height
 • 4" Width



BL 3036
 • 36" Projection
 • 44" Height
 • 6" Width



BL 2661
 • 24" Projection
 • 36" Height
 • 7 1/4" Width



BL 2828
 • 30" Projection
 • 28" Height
 • 3 1/2" Width



BL 2869
 • 18 5/8" Projection
 • 24" Height
 • 4" Width

BL 3191
 • 24" Projection
 • 24" Height
 • 4" Width

BL 3192
 • 22 1/2" Projection
 • 40 1/2" Height
 • 4" Width



BL 3104
 • 23" Projection
 • 34" Height
 • 3" Width





BLOCKS, BRACKETS & GINGERBREADS

NOTICE :

SPECTIS ADHESIVE MUST BE USED ON ALL BEDDING/BUTT JOINTS.



BL 2555
 • 30 1/2" Projection
 • 27 1/2" Height
 • 3 1/2" Width



BL 2844
 • 30 1/2" Projection
 • 27 1/2" Height
 • 6" Width



BL 2468
 • 15 7/8" Projection
 • 15 7/8" Height
 • 2" Width



BL 2576
 • 32" Projection
 • 32" Height
 • 4" Width



BL 2671
 • 11 1/2" Projection
 • 11 1/2" Height
 • 3" Width



BL 2672
 • 17 1/2" Projection
 • 17 1/2" Height
 • 3" Width



BL 3013
 • 23 7/8" Projection
 • 23 7/8" Height
 • 4 1/2" Width



BL 3144
 • 32 1/2" Projection
 • 47 1/2" Height
 • 6" Width



BL 3160
 • 24" Projection
 • 43" Height
 • 5 1/2" Width



BL 2499
 • 33" Projection
 • 42" Height
 • 3 1/2" Width



BL 2541
 • 26" Projection
 • 27" Height
 • 4 1/2" Width



BL 3046
 • 32" Projection
 • 32" Height
 • 6" Width

1 • 8 0 0 • 6 8 5 • 9 9 8 1



Blocks may come with
hollows in tops and/or backs

BLOCKS, BRACKETS & GINGERBREADS



BL 3045
 • 40" Projection
 • 40" Height
 • 6" Width



BL 2775
 • 41 1/2" Projection
 • 48" Height
 • 7 1/4" Width



BL 2777
 • 24" Projection
 • 26" Height
 • 5 1/2" Width



BL 2892
 • 19 1/2" Projection
 • 31 1/2" Height
 • 7 1/4" Width



BL 3071
 • 26 3/8" Projection
 • 28 3/8" Height
 • 6" Width



BL 3175
 • 12" Projection
 • 24" Height
 • 3 1/2" Width



BL 2565
 • 18" Projection
 • 30" Height
 • 4" Width



BL 2614
 • 15" Projection
 • 18" Height
 • 6" Width



BL 2821
 • 13 1/2" Projection
 • 15" Height
 • 2 1/2" Width



BL 3188
 • 9" Projection
 • 11" Height
 • 3 1/2" Width



BL 3187
 • 16" Projection
 • 18" Height
 • 3 1/2" Width



BL 3050
 • 16" Projection
 • 18" Height
 • 3" Width





BLOCKS, BRACKETS & GINGERBREADS

NOTICE :

SPECTIS ADHESIVE MUST BE USED ON ALL BEDDING/BUTT JOINTS.



BL 3064
• 20" Projection
• 22" Height
• 3" Width



BL 3132
• 18 3/4" Projection
• 24" Height
• 3 1/2" Width



BL 2559
• 27 1/4" Projection
• 25 1/2" Height
• 3 1/2" Width



BL 2558
• 15 1/4" Projection
• 13 1/2" Height
• 3 1/2" Width



BL 2701
• 25" Projection
• 25" Height
• 3 1/2" Width



BL 2928
• 25" Projection
• 27 1/2" Height
• 3 1/2" Width



BL 3020
• 28 1/2" Projection
• 40" Height
• 5 1/2" Width



BL 3034
• 32 3/4" Projection
• 34 3/4" Height
• 5 1/2" Width



BL 3051
• 36" Projection
• 36" Height
• 6" Width



BL 2868
• 36" Projection
• 36" Height
• 5" Width



BL 3086
• 48" Projection
• 48" Height
• 4" Width



BL 3017
• 35" Projection
• 40" Height
• 6" Width

1 • 8 0 0 • 6 8 5 • 9 9 8 1



Blocks may come with hollows in tops and/or backs

BLOCKS, BRACKETS & GINGERBREADS



BL 2606
 • 12" Projection
 • 28 1/4" Height
 • 5 1/4" Width



BL 2608
 • 10" Projection
 • 8" Height
 • 3 1/2" Width



BL 3060
 • 11" Projection
 • 9" Height
 • 3 1/2" Width



BL 2863
 • 14" Projection
 • 10" Height
 • 4 1/2" Width



BL 2942
 • 28 1/4" Projection
 • 9" Height
 • 5 1/4" Width



BL 2607
 • 22" Projection
 • 29" Height
 • 4" Width
 • 6/12 Pitch



BL 2994
 • 32 1/2" Projection
 • 32 1/2" Height
 • 4" Width



BL 2712
 • 32" Projection
 • 30" Height
 • 7" Width



BL 2713
 • 44" Projection
 • 44" Height
 • 10" Width



BL 2943
 • 24" Projection
 • 25 1/4" Height
 • 2 1/2" Width



BL 2945
 • 13 1/4" Projection
 • 13 1/4" Height
 • 2 1/2" Width





BLOCKS, BRACKETS & GINGERBREADS

NOTICE :

SPECTIS ADHESIVE MUST BE USED ON ALL BEDDING/BUTT JOINTS.



BL 2962
• 40" Projection
• 40" Height
• 4" Width



BL 3123
• 40" Projection
• 40" Height
• 5 1/2" Width



BL 2727
• 24" Projection
• 22" Height
• 2" Width



BL 3138
• 38 1/2" Projection
• 31" Height
• 5" Width

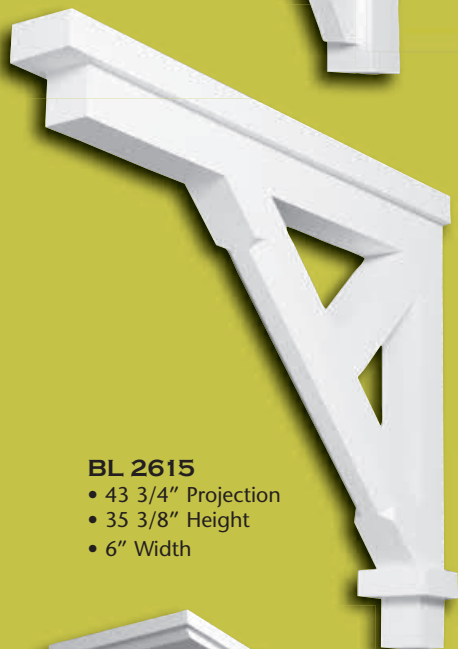

BL 2615
• 43 3/4" Projection
• 35 3/8" Height
• 6" Width



BL 2681
• 24" Projection
• 30" Height
• 4" Width



BL 2811
• 22" Projection
• 56" Height
• 6" Width
• 4/12 Pitch



BL 3116
• 34 1/4" Projection
• 48" Height
• 6" Width



BL 2852
• 24" Projection
• 26" Height
• 12" Width



BL 2649
• 4 1/2" Projection
• 4 7/16" Height
• 2 7/8" Width

1 • 8 0 0 • 6 8 5 • 9 9 8 1



Blocks may come with hollows in tops and/or backs

BLOCKS, BRACKETS & GINGERBREADS



- BL 3162**
- 38" Projection
 - 48" Height
 - 3 1/2" Width

- BL 2832**
- 35" Projection
 - 65 1/2" Height
 - 6" Width



Photo above show the use of Spectis custom brackets & moulding



- BL 3053**
- 58" Projection
 - 80" Height
 - 14" Width



- BL 2598**
- 31 1/2" Projection
 - 31 1/2" Height
 - 6 " Width



- BL 2793**
- 21" Projection
 - 21" Height
 - 4" Width

FINISHING

All Spectis' products are shipped "double primed" with an exterior grade latex paint and are ready for use. We recommend final finishing after installation is complete for the most consistent appearance possible. Please see "finishing" recommendations (on page 267) for more information.



- BL 2995**
- 21 1/2" Projection
 - 21 1/2" Height
 - 4" Width



- BL 2645**
- 11" Projection
 - 17" Height
 - 2 7/8" Width

www.spectis.com



Blocks may come with hollows in tops and/or backs



BLOCKS, BRACKETS & GINGERBREADS

NOTICE :

SPECTIS ADHESIVE MUST BE USED ON ALL BEDDING/BUTT JOINTS.



BL 2938
 • 36 1/8" Projection
 • 36 1/8" Height
 • 6" Width



BL 3103
 • 20" Projection
 • 36 1/8" Height
 • 6" Width



BL 2891
 • 30" Projection
 • 30" Height
 • 6" Width



BL 3022
 • 30" Projection
 • 30" Height
 • 4" Width



BL 2996
 • 43 1/4" Projection
 • 43 1/4" Height
 • 4" Width



BL 2675
 • 18" Projection
 • 16" Height
 • 3 1/2" Width

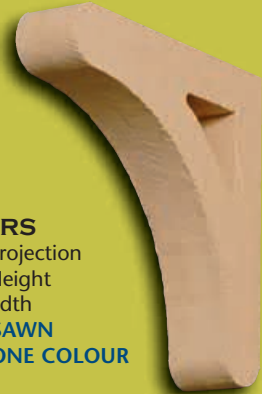

BL 2720RS
 • 12 7/8" Projection
 • 12 7/8" Height
 • 2 3/4" Width
 • **ROUGH SAWN**
 • **WOODTONE COLOUR**



BL 2451
 • 12 1/2" Projection
 • 10 1/8" Height
 • 7 1/4" Width



BL 2599
 • 11" Projection
 • 9" Height
 • 7 1/4" Width



BL 2600
 • 9 3/4" Projection
 • 9" Height
 • 5" Width



BL 2452
 • 12" Projection
 • 9" Height
 • 4 1/2" Width

1 • 8 0 0 • 6 8 5 • 9 9 8 1



Blocks may come with
hollows in tops and/or backs

BLOCKS, BRACKETS & GINGERBREADS



BL 2453
 • 8 15/16" Projection
 • 6 13/16" Height
 • 3 3/8" Width



BL 2642PC
 • 8 7/8" Projection
 • 9" Height
 • 2 1/2" Width
 • PECKY CYPRESS
 • WOODTONE COLOUR



BL 3072
 • 8 3/8" Projection
 • 10 3/4" Height
 • 4" Width



BL 3078
 • 14" Projection
 • 15 1/8" Height
 • 6" Width



BL 3079
 • 14" Projection
 • 19 3/8" Height
 • 6" Width



BL 3074
 • 14" Projection
 • 22" Height
 • 7" Width



BL 3075
 • 15 1/2" Projection
 • 37 7/8" Height
 • 8" Width



BL 2900
 • 16" Projection
 • 18" Height
 • 6" Width



BL 2966
 • 11" Projection
 • 11" Height
 • 6" Width



BL 3058
 • 10 1/2" Projection
 • 8 3/4" Height
 • 7 1/2" Width



BL 2686
 • 12" Projection
 • 16 1/2" Height
 • 3" Width





BLOCKS, BRACKETS & GINGERBREADS

NOTICE :

SPECTIS ADHESIVE MUST BE USED ON ALL BEDDING/BUTT JOINTS.



BL 2505
• 15" Projection
• 19 1/16" Height
• 3 1/2" Width



BL 2507
• 11" Projection
• 15" Height
• 3 1/2" Width



BL 2673
• 7 1/2" Projection
• 10 5/8" Height
• 3" Width



BL 2636
• 6 7/8" Projection
• 8 1/2" Height
• 6" Width



BL 2955
• 18 1/2" Projection
• 18 1/2" Height
• 6" Width



BL 3000
• 18" Projection
• 30" Height
• 9 1/4" Width



BL 3001
• 18" Projection
• 48" Height
• 9 1/4" Width



BL 2430
• 10 1/2" Projection
• 12 1/2" Height
• 1" Width



BL 2482
• 17 1/2" Projection
• 23 3/8" Height
• 4 1/4" Width



BL 2510A
• 10" Projection
• 10 9/16" Height
• 3 5/8" Width
BL 2510B
• 11 7/8" Projection
• 13 15/16" Height
• 4 1/4" Width
BL 2510C
• 15" Projection
• 18" Height
• 5 3/4" Width



BL 2511A
• 10" Projection
• 10 9/16" Height
• 3 5/8" Width
BL 2511B
• 11 7/8" Projection
• 14" Height
• 4 1/4" Width
BL 2511C
• 15" Projection
• 18" Height
• 5 3/4" Width

1 • 8 0 0 • 6 8 5 • 9 9 8 1



Blocks may come with
hollows in tops and/or backs

BLOCKS, BRACKETS & GINGERBREADS



BL 2730-10
 • 10" Projection
 • 12" Height
 • 5" Width
BL 2730-12
 • 12" Projection
 • 16" Height
 • 5" Width



BL 2990
 • 17 1/8" Projection
 • 14" Height
 • 3 3/16" Width



BL 3004
 • 15 1/2" Projection
 • 21 1/2" Height
 • 5" Width



BL 3107
 • 15 3/16" Projection
 • 15 15/16" Height
 • 8 11/16" Width



BL 2787
 • 11 1/2" Projection
 • 11 3/4" Height
 • 3 1/2" Width



BL 2788
 • 8 1/2" Projection
 • 9" Height
 • 3 1/2" Width



BL 3019
 • 9 1/4" Projection
 • 14" Height
 • 5" Width



BL 2579
 • 17 1/4" Projection
 • 19 1/2" Height
 • 7 3/4" Width



BL 2437
 • 11" Projection
 • 15 1/2" Height
 • 2 1/2" Width



BL 3186
 • 11 5/8" Projection
 • 5 1/2" Height
 • 2 1/2" Width





BLOCKS, BRACKETS & GINGERBREADS

NOTICE :

SPECTIS ADHESIVE MUST BE USED ON ALL BEDDING/BUTT JOINTS.



BL 2506

- 14 1/2" Projection
- 14 1/2" Height
- 1" Width



BL 2603

- 4 3/4" Projection
- 4 3/4" Height
- 3/4" Width



BL 2850

- 14 3/4" Projection
- 15 1/2" Height
- 4 3/4" Width



BL 2596

- 9 1/2" Projection
- 17 1/4" Height
- 2" Width



BL 2434

- 12" Projection
- 12" Height
- 1" Width



BL 2478

- 15 1/4" Projection
- 21" Height
- 3" Width



BL 2561

- 26" Projection
- 26" Height
- 4" Width



BL 2529

- 12 3/16" Projection
- 12 3/16" Height
- 1" Width



BL 2568

- 15 7/8" Projection
- 15 7/8" Height
- 2" Width

1 • 8 0 0 • 6 8 5 • 9 9 8 1



Blocks may come with
hollows in tops and/or backs

BLOCKS, BRACKETS & GINGERBREADS



GINGERBREADS



GB 3300
 • 1 1/8" Projection
 • 8 3/8" Height
 • 11 3/8" Width
 • Apply to BL 2456



GB 3301
 • 1 1/8" Projection
 • 10 3/8" Height
 • 10 1/2" Width
 • Apply to BL 2456



GB 3302
 • 1 1/8" Projection
 • 8 1/4" Height
 • 9 1/8" Width
 • Apply to BL 2457



GB 3303
 • 1 1/2" Projection
 • 7 1/2" Height
 • 6 1/2" Width
 • Apply to BL 2457



GB 3304
 • 1 1/8" Projection
 • 6 5/8" Height
 • 7 5/8" Width
 • Apply to BL 2458



GB 3305
 • 1 1/8" Projection
 • 7 5/8" Height
 • 7 5/8" Width
 • Apply to BL 2458

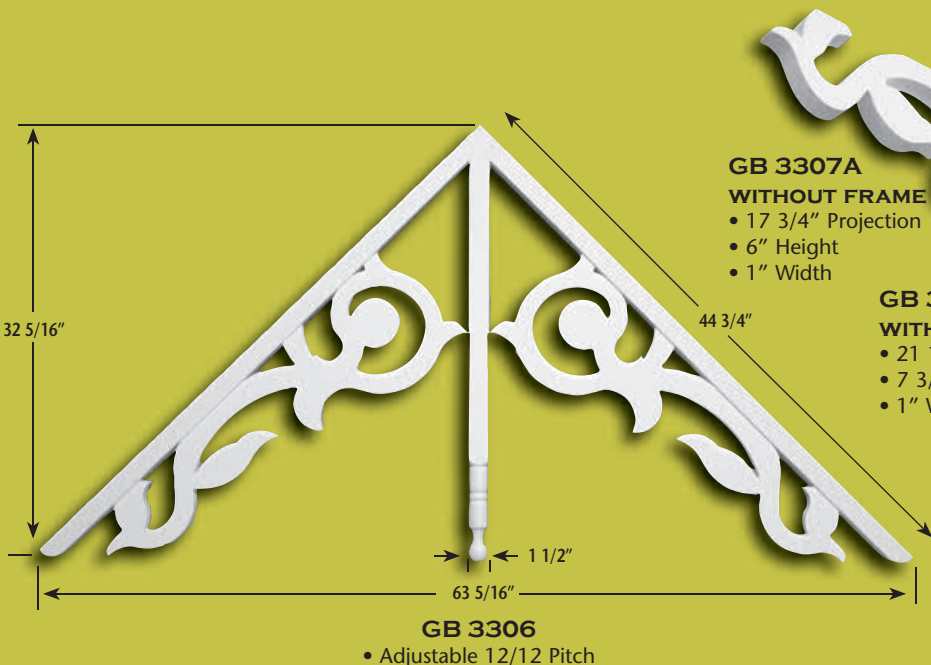

GB 3306
 • Adjustable 12/12 Pitch



GB 3307A
WITHOUT FRAME
 • 17 3/4" Projection
 • 6" Height
 • 1" Width

GB 3308A
WITHOUT FRAME
 • 21 15/16" Projection
 • 7 3/8" Height
 • 1" Width

GB 3307B
WITH FRAME
 • 20 1/4" Projection
 • 8 1/2" Height
 • 1 1/2" Width

GB 3308B
WITH FRAME
 • 24" Projection
 • 9 7/8" Height
 • 1 1/2" Width





BLOCKS, BRACKETS & GINGERBREADS

NOTICE :

SPECTIS ADHESIVE MUST BE USED ON ALL BEDDING/BUTT JOINTS.



GB 3309
 • 9 1/4" Projection
 • 18 3/4" Height
 • 3/4" Width



GB 3310
 • 13 1/4" Projection
 • 5 5/8" Height
 • 1 3/4" Width



GB 3311
 • 19" Projection
 • 8 1/2" Height
 • 1 3/4" Width

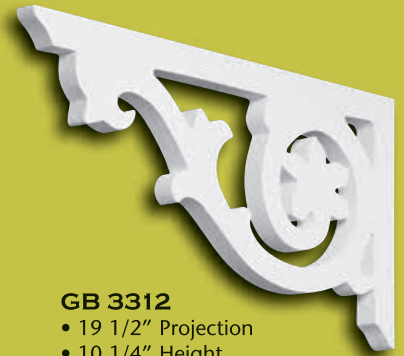

GB 3312
 • 19 1/2" Projection
 • 10 1/4" Height
 • 2" Width

GINGERBREADS

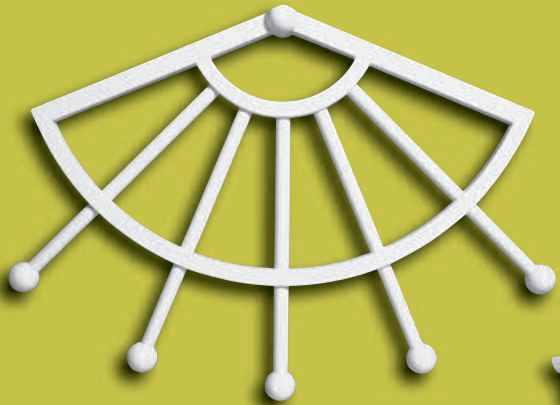

GB 3313 - 5/12
 Gable Bracket
 • 24 1/4" Height
 • 35 7/16" Width
 • 5/12 Pitch



GB 3314
 • 10" Projection
 • 6 1/16" Height
 • 1" Width



GB 3315
 • 20 1/2" Projection
 • 13 1/2" Height
 • 1 1/2" Width

GB 3313 - 6/12
 Gable Bracket
 • 24 1/4" Height
 • 34 5/16" Width
 • 6/12 Pitch



GB 3316
 • 17 1/2" Projection
 • 18" Height
 • 1 1/4" Width



GB 3317-3/12
 • 13 1/2" Projection
 • 16" Height
 • 2" Width
 • 3/12 Pitch

GB 3317-6/12
 • 13 1/2" Projection
 • 16" Height
 • 2" Width
 • 6/12 Pitch



GB 3318
 • 1/4" Projection
 • 7 15/16" Height
 • 8 3/4" Width



GB 3319
 • 1/4" Projection
 • 7 15/16" Height
 • 8 3/4" Width

1 • 8 0 0 • 6 8 5 • 9 9 8 1



Blocks may come with
hollows in tops and/or backs

BLOCKS, BRACKETS & GINGERBREADS



GB 3320
 • 20 1/16" Projection
 • 24 7/8" Height
 • 1" Width



GB 3321
 • 21 1/2" Projection
 • 21 7/8" Height
 • 1" Width



GB 3322
 • 18 1/4" Projection
 • 18 3/4" Height
 • 2 1/2" Width



GB 3324
 • 24" Projection
 • 24" Height
 • 3" Width



GB 3330
 • 25" Projection
 • 18" Height
 • 2" Width

GINGERBREADS



GB 3331
 • 19 3/4" Projection
 • 7 7/8" Height
 • 2" Width



GB 3332
 • 11 1/2" Projection
 • 7 3/4" Height
 • 1" Width



GB 3333
 • 12" Projection
 • 12" Height
 • 2 1/16" Width



Photo above shows the use of a custom Spectis lattice with porch post PP 3201, baluster BAL 2028-9 and gingerbread GB 3315.





BLOCKS, BRACKETS & GINGERBREADS

NOTICE :

SPECTIS ADHESIVE MUST BE USED ON ALL BEDDING/BUTT JOINTS.

GINGERBREADS

GB 3323

• 2 1/2" Projection

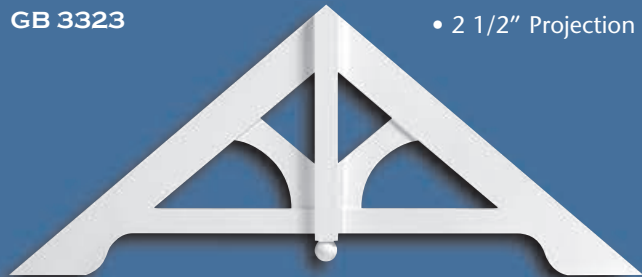

PRODUCT NUMBER	PITCH	WIDTH	HEIGHT
GB 3323 - 4/12	4/12	132"	22"
GB 3323 - 5/12	5/12	108"	22 1/2"
GB 3323 - 6/12	6/12	103 1/2"	25 7/8"
GB 3323 - 7/12	7/12	96"	28"
GB 3323 - 8/12	8/12	87 1/4"	29"
GB 3323 - 9/12	9/12	86"	32 1/4"
GB 3323 - 10/12	10/12	81"	33 3/4"
GB 3323 - 11/12	11/12	75"	34 3/8"
GB 3323 - 12/12	12/12	70"	35"
GB 3323 - 13/12	13/12	66"	35 3/4"
GB 3323 - 14/12	14/12	64 1/8"	37 7/16"
GB 3323 - 15/12	15/12	65"	40 5/8"
GB 3323 - 16/12	16/12	60 3/4"	40 1/2"
GB 3323 - 18/12	18/12	60"	45"

GB 3325

• 1" Projection



PRODUCT NUMBER	PITCH	WIDTH	HEIGHT
GB 3325 - 4/12	4/12	132"	22"
GB 3325 - 5/12	5/12	105 5/8"	22"
GB 3325 - 6/12	6/12	103 1/2"	25 7/8"
GB 3325 - 7/12	7/12	95 1/8"	27 3/4"
GB 3325 - 8/12	8/12	87 3/4"	29 1/4"
GB 3325 - 9/12	9/12	85 5/16"	32"
GB 3325 - 10/12	10/12	79 1/2"	33 1/8"
GB 3325 - 11/12	11/12	75"	34 3/8"
GB 3325 - 12/12-68	12/12	68"	34"
GB 3325 - 12/12-81	12/12	81"	40 1/2"
GB 3325 - 13/12	13/12	62 5/16"	33 3/4"
GB 3325 - 14/12	14/12	65 1/8"	38"
GB 3325 - 15/12	15/12	65"	40 5/8"
GB 3325 - 16/12	16/12	61 1/8"	40 3/4"
GB 3325 - 18/12	18/12	60"	45"

GB 3326

• 1" Projection

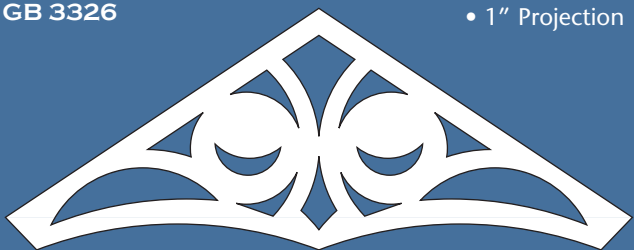

PRODUCT NUMBER	PITCH	WIDTH	HEIGHT
GB 3326 - 4/12	4/12	121"	22 1/8"
GB 3326 - 5/12	5/12	98"	22 1/8"
GB 3326 - 6/12	6/12	97"	25 1/2"
GB 3326 - 7/12	7/12	90 1/2"	28"
GB 3326 - 8/12	8/12	82 1/2"	29"
GB 3326 - 9/12	9/12	82 3/8"	32 1/4"
GB 3326 - 10/12	10/12	79 1/4"	34 1/4"
GB 3326 - 11/12	11/12	72 1/4"	34 1/4"
GB 3326 - 12/12 - 48	12/12	45 7/8"	24"
GB 3326 - 12/12 - 74	12/12	74 7/8"	38 1/2"
GB 3326 - 13/12	13/12	64 1/4"	35 3/4"
GB 3326 - 14/12	14/12	63"	37 5/8"
GB 3326 - 15/12	15/12	63 3/4"	40 5/8"
GB 3326 - 16/12	16/12	59"	40 1/16"
GB 3326 - 18/12	18/12	59 1/4"	45"

GB 3327

• 1 3/4" Projection

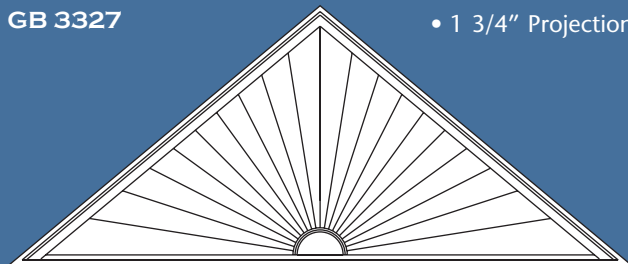

PRODUCT NUMBER	PITCH	WIDTH	HEIGHT
GB 3327 - 5/12 - 98	5/12	98"	20 7/16"
GB 3327 - 5/12 - 148	5/12	148"	30 13/16"
GB 3327 - 6/12	6/12	92"	23"
GB 3327 - 7/12	7/12	84"	24 1/2"
GB 3327 - 8/12	8/12	84"	28"
GB 3327 - 9/12	9/12	88 5/8"	33 1/4"
GB 3327 - 10/12	10/12	78"	32 1/2"
GB 3327 - 12/12 - 36	12/12	36 1/4"	18 1/8"
GB 3327 - 12/12 - 68	12/12	67 3/4"	33 7/8"
GB 3327 - 12/12 - 132	12/12	132"	66"
GB 3327 - 14/12	14/12	66"	38 1/2"
GB 3327 - 16/12	16/12	60"	40"

1 • 800 • 685 • 9981



Blocks may come with
hollows in tops and/or backs