



***2023***  
***Product Guide***

# Thank you for choosing Advanced Sports Supply!

For the past few years, it has been a priority to start new relationships all while rekindling some old ones and bring high quality products that our customers are looking for. In 2022, we took a giant leap and look forward to continuing to grow in 2023!

At Advanced Sports Supply, we take pride in getting to know our customers personally. Building and sustaining relationships will always be at the top of our list, along with supplying the top products you need, even as we continue to grow.

We'd like to thank all our loyal customers and vendors that have allowed us to continue to work with them and help us grow into what we are today! We sincerely enjoy working with all of you, and we look forward to working with you and many more throughout the future.

Sincerely,



Corey Scherer – President/CEO



**WE ARE THE EXCLUSIVE DISTRIBUTOR FOR THESE GREAT PRODUCTS!**

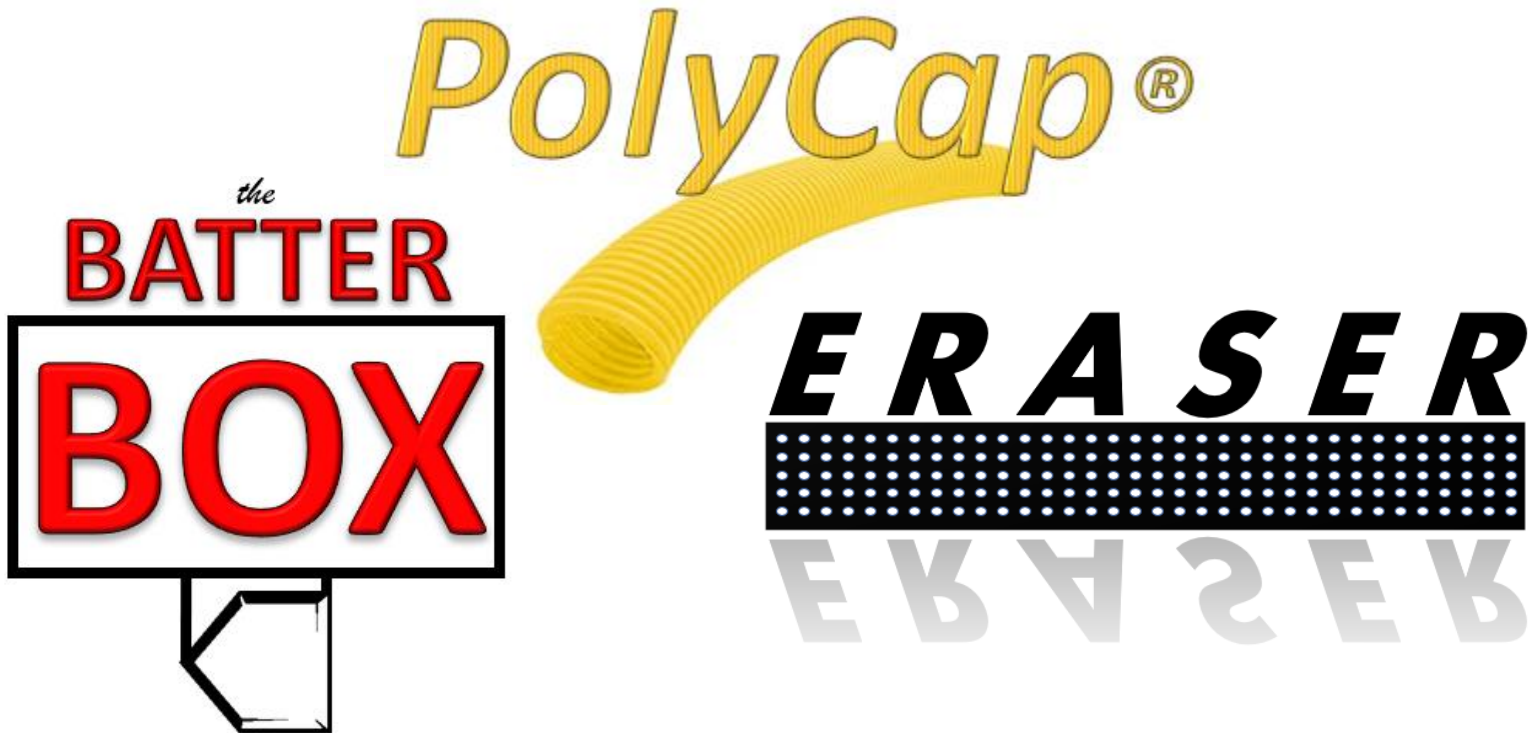

@advancedsportssupply



@advsportssupply



@advancedsportssupply

# CONTENTS

## Field Maintenance & Facility.....Pages 1-17

FENCE CAP	1
HAND TOOLS	2
DRAGS	3
FIELD MARKING	4-7
FIELD MATERIALS	8-9
WINDSCREEN	10-11
FIELD TARPS	12
WATER REMOVAL	13
PADDING	14
NETTING	15-16
TURF	17

## Baseball/Softball.....Pages 18-44

TURF MATS	18
BASES	19-23
FOUL POLES	24
SCREENS	25-26
BATTING CAGES	27
TRAINING AIDS	28-32
BALLS	33-37
COACHING	38
PLAYERS	39-44

## Soccer.....Pages 45-57

GOALS	45-49
NETS	50-51
CORNER FLAGS	52
SEATING/SHELTER	53-55
COACHING	56
SOCCER BALLS	57

## Football.....Pages 58-73

FOOTBALLS/TEES	58-59
SHIELDS/SLEDS	60-62
FIELD EQUIPMENT	63
PROTECTIVE GEAR	64-71
FLAG FOOTBALL	72
GOAL POSTS	73

## Hydration.....Pages 74-75

## Basketball.....Pages 76-87

BALLS/STORAGE	76
GOALS/SYSTEMS	77-80
RIMS/BOARDS/NETS	81-86
COACHING	87

## Sports Medicine.....Pages 88-89

## Racquet Sports/Pickleball.....Pages 90-92

POLES	90
NETS	91
BALLS/RACQUETS	92

## Apparel & Uniforms.....Pages 93-100



## LANDSCAPE/FIELD RAKES

24" - #10024

36" - #10036

48" - #10048

- 66" HD aluminum handle
- Has teeth on one side and a leveling blade on the other



## BASERUNNER TELESCOPIC RAKE

36" - #12503

- 70" handle telescopes down to 39"
- Has teeth on one side and a leveling blade on the other



## DOUBLE PLAY GROOMING RAKE

36" - #12536

- 66" HD aluminum handle
- Short scarifire teeth on one side, long landscaping teeth on the other



## SCARIFIER/LUTE RAKE

36" - #52936

- 66" HD aluminum handle
- Has teeth on one side and a leveling blade on the other



## LOOP/TWO-WAY HOE

#40100

- 60" handle, 6" head
- Dual action head cuts with minimal surface disruption



## PROFESSIONAL DRAG BROOM

84" - #83084

- Three rows of 3.5" bristles

## TOOLITE SIFTING SHOVEL

#49500

- 48" fiberglass handle
- 14-gauge steel head



Other models are available! We can get what you need!

# ERASER

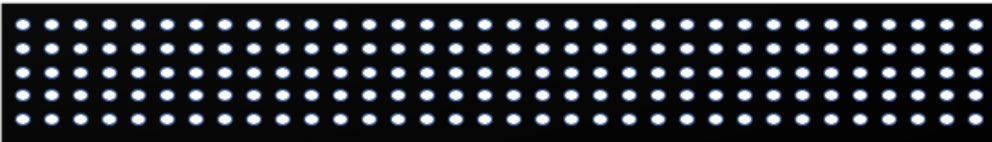

## ERASER 2.0

6.5'W x 4'D - #ERASE64

6.5'W x 2'D - #ERASE62

4'W x 3'D - #ERASE43

The ERASER 2.0 has a lightweight design and heavy-duty impact for your field dragging needs. Made of industrial strength rubber, the ERASER 2.0 gives a pro finish! The holes in the mat allow your material to percolate through! It will not harm grass, mounds, home plates, or golf greens when coming in contact. The industrial rubber won't kink like steel drags! Easy to roll up and transport!

- Tow Rope INCLUDED!

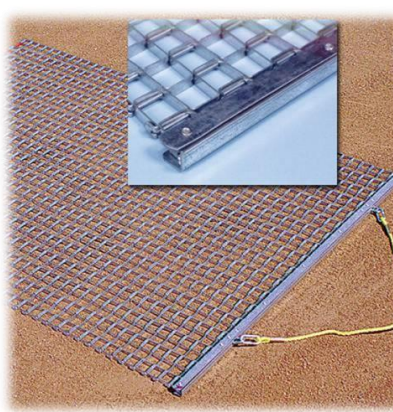
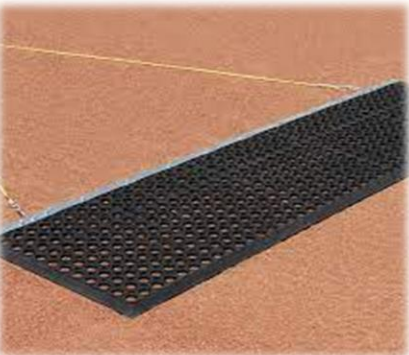

## FLEXIBLE STANDARD DUTY STEEL DRAG

3'W x 5'D - #STD3X5DRAG

6'W x 3'D - #STD6X3DRAG

6'W x 6'D - #STD6X6DRAG

- 1" x 1" steel mesh
- Rolls up for easy storage
- Includes steel drag attachment and tow rope
- Other sizes available!

## STEEL FLEX DRAG MOP

#BSFDM

- Designed for finish grooming small areas
- Powder-coated aluminum handle is 66" long with aluminum head and wrap around bracing
- Flex drag size measures 24"W x 18"L

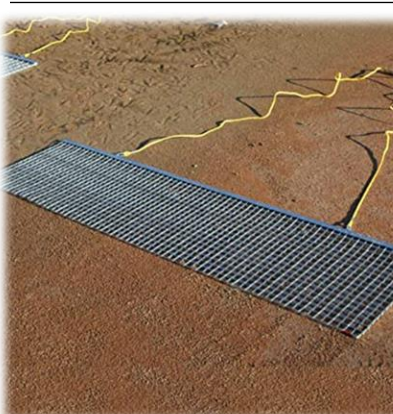

## RIGID STEEL DRAG

4'W x 18"D - #RIG4X2DRAG

6'W x 18"D - #RIG6X2DRAG

- 1" x 1" steel mesh
- Does not flex to provide enhanced leveling
- Includes steel drag attachment and tow rope
- Other sizes available!



## COCOA MOP

#220-100-020

- Excellent on mounds and tight maneuvering
- Constructed from high quality cocoa mat
- Size: 27"W x 16"L



## COCOA MAT DRAG

4'W x 2'D - #205-100-020

6'W x 2'D - #205-100-030

6'W x 4'D - #205-100-050

- 1" thick natural fiber surface
- Heavy Duty rubber backing
- Includes drag bar and pull rope w/ plastic handle

*the*  
**BATTER**

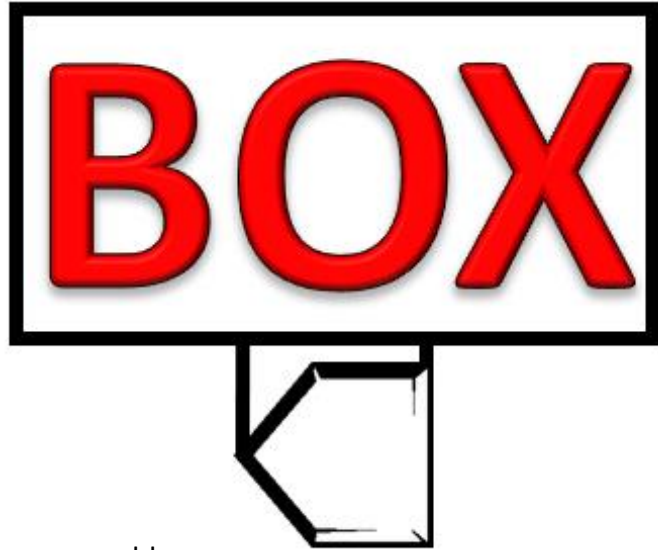

**THE BATTER BOX TEMPLATE**

Baseball (4' x 6') - #01015

Youth Baseball (3' x 6') - #01017

Softball (3' x 7') - #01016

- HD 1" square galvanized steel with quick push pins for easy assembly
- Official Home Plate locator

**THE BATTER BOX ADJUSTABLE TEMPLATE**

#02500

- HD 1" square galvanized steel with quick push pins for easy assembly
- Official Home Plate locator
- Adjusts from baseball to youth baseball to softball with telescoping push pin construction



**THE BATTER BOX HEAVY DUTY TEMPLATE**

Baseball (4' x 6') - #01635

Youth Baseball (3' x 6') - #01634

Softball (3' x 7') - #01640

- Lightweight channel aluminum
- Clearly marks the outline for the batter's box
- Line up the easy guide handle with the side of your home plate
- Folds for easy transport



**THE BATTER BOX E-Z CHALKER**

Baseball (4' x 6') - #01591

COMBO Youth Baseball (3' x 6') Softball (3' x 7') - #01592

- Marks regulation batter's box in seconds
- Marks a 2" wide line
- Durable and lightweight aluminum
- Handles fold in for storage



## MARKING CHALK 50LB

#084425

- Skid quantities (60 bags)
- 100% natural, non-toxic



## ATHLETIC MARKING PAINT

White - #20-644

- Case of 12
- Other colors – yellow, blue, red, orange
- Inverted tip
- **FREE SHIPPING!** on 50+ cases



## STREAMLINER 70LB

#240-100-190

- 70lb capacity
- (4) no-flat tires
- 2" and 4" setting
- Nylon brush agitator
- Multi position flow rate control



## ATHLETIC WHITE 5-GAL PAIL

#5-844 - 5-gal pail

- **FREE SHIPPING!** on 18 pails (90 gal)



## STREAMLINER 35LB

#240-100-150

- 35lb capacity
- (3) no-flat tires
- 2" and 4" setting
- Nylon brush agitator
- Multi position flow rate control

## DOUBLE PLAY PAINT ATTACHMENT

#240-100-050



## ATHLETIC MARKING MACHINE

#Z-607

- 10" Wheels
- Built-in case storage
- Universal spray tip activator



## STRING WINDER KITS

Caddy Style KIT - #01631K

Handheld KIT - #01651K

- 740' of nylon twine and 10" spike included

Caddy Winder - #K-100

Handheld Winder - #KW-110

740' Twine - #P3233-0023

10" Spike - #B019



## GRACO FIELDLAZER

Gas Powered - #S100

Battery Powered - #ES100

FieldLazer ES100 and S100 walk-behind models feature durable, lightweight construction for effortless straight lines over even the roughest terrain.



## OPEN REEL TAPE MEASURE

50' - #A170

100' - #A171

165' - #A172

200' - #A173

300' - #A174



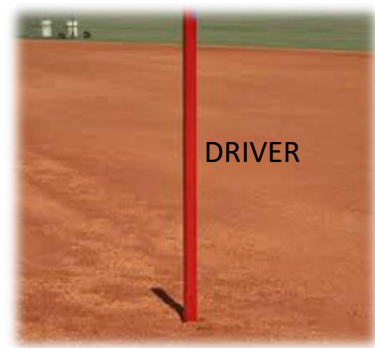

DRIVER

### CH BASE ANCHOR

#21202

- Deluxe Heavy Duty Powder coated
- 1 1/2" Hollywood Style

#19999

- Standard Duty Galvanized
- 1 1/2" Hollywood Style

#DRIVER

- Anchor Driver
- Deluxe Heavy Duty Powder coated
- Requires no digging or concrete



### DOUBLE GROUND ANCHOR

#B003G

- Fits Official size Dual Stanchion pitching rubbers and Double First Base



### 1 1/2" FEMALE GROUND ANCHOR

#B005



### DIGOUT TOOL

#B007

- Effectively cleans dirt from ground anchors



### BIG LEAGUE BASE PLUG

#BLBP

- Tassel color may vary based on stock
- Fits 1 1/2" anchor only



### ECONOMY FOAM BASE PLUG W/ TASSEL

#B008F

- Fits 1 1/2" anchor only



### RUBBER BASE PLUG

#B008

- Plug color may vary
- Fits both male and female anchors



### RUBBER BASE PLUG W/ TASSEL

#B008S

- Fits both male and female anchors



# ADVANCED SPORTS SUPPLY

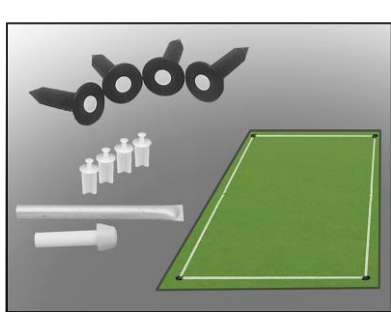

### MarkSmart™ 4 CORNER FIELD LINING SYSTEM

#CLK-4

**Includes**

- 4 Ground sockets with plugs
- 4 Lining Pegs
- 1 Socket Setter
- 1 Installation tool & instructions



### MarkSmart™ BASIC FIELD LINING SYSTEM

#BLP-6

**Includes**

- 6 Ground sockets with plugs
- 4 Lining pegs
- 1 Socket Setter
- 1 Roll of twine
- 1 Installation tool & instructions

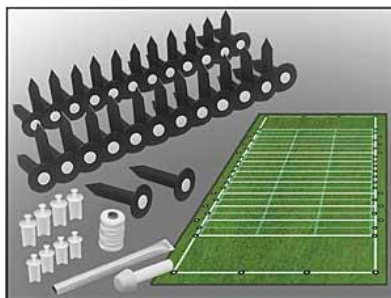
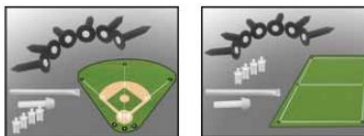

### MarkSmart™ FOOTBALL FIELD MARKING SYSTEM

#FLP-50

**Includes**

- 50 Ground Sockets with plugs
- 8 Lining Pegs
- 1 Socket Setter
- 1 Roll of twine
- 1 Installation tool & instructions

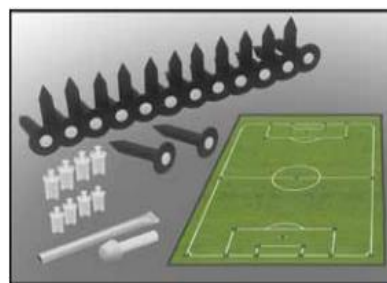

### MarkSmart™ SOCCER FIELD MARKING SYSTEM

#SLP-25

**Includes**

- 25 Ground Sockets with plugs
- 10 Lining Pegs
- 1 Socket Setter
- 1 Roll of twine
- 1 Installation tool & instructions



### MarkSmart™ FOOTBALL EZ FOLD HASHMARK STENCIL

#EZHASH

- Edge cut notches allow for fast, easy and accurate placement.
- Unique accordion fold design compacts the guide down to 45" x 29" for easy storage and handling



### MarkSmart™ EZ FOLD NUMBER SET STENCIL

#EZNUM

**Includes**

- 0-1-2-3-4-5 and direction arrow



### OUTDOOR DRAIN COVER

Square 37" - #37-SG

Round 30" - #30-RG

Cover your hazardous iron field drains and utility boxes with NON-SKID recycled rubber covers. Designed to allow water to flow through... these covers diminish the risk of injury to players and spectators alike. Standard green 37" square and 30" Round with recessed bottom fits over the drain and stays in place. They're EASY to install and last for years and years!



### PRO MOUND PACKING CLAY

50lb bags - #A56799G50

Bricks - #A56797G320

- A unique blue gumbo packing clay, Pro Mound bonds to form a solid subsurface that allows players to “dig in” and establish footing without leaving large holes
- Also available in pre-formed bricks (4” x 8” x 2½”) 312 bricks/skid



### EASY MOUND PACKING CLAY

40lb bags - #A86299G40

Bricks - #A86297G304

- This deep reddish brown packing clay is ideal for quick and easy building and repairing common wear areas on pitcher’s mounds and batter’s boxes
- Also available in pre-formed bricks (4” x 8” x 2½”) 304 bricks/skid



### RAPID DRY

50lb bags - #A45216G40

- Stay in the game with Rapid Dry drying agent. These sand-like granules are designed to quickly wick away excess water from your infield, keeping your games playing safely and without delay



### RED CONDITIONER

50lb bags - #A45201G40

- Designed to meet the challenges of wet, dry, or compacted infields. Helps create passageways for drainage and eliminate compaction for safer play



### SELECT CONDITIONER

50lb bags - #A45202G40

- This premium conditioner keeps infields smooth, safe, and resilient. Special size granules and color makes the perfect infield topdressing



### PRO RED CONDITIONER

50lb bags - #A45503G40

- The only deep red conditioner that keeps its color to maintain that championship look
- Uniform particle size and durability



### WASHINGTON BALL MIX

Sold by Truckload - #WBM

Mar-Co’s Washington Ball Mix gives you the best play for the best price. It’s the standard in baseball clay mixes, offering both quality and value. One of our most popular baseball infield mixes, Washington Ball Mix offers low maintenance and repair costs, optimal moisture control, professional-looking red clay, and softer footing for safety.

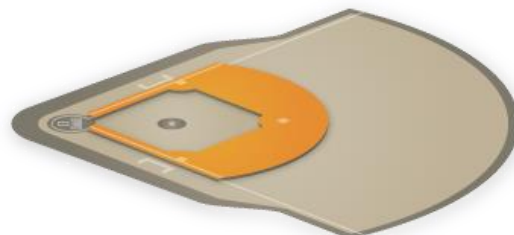

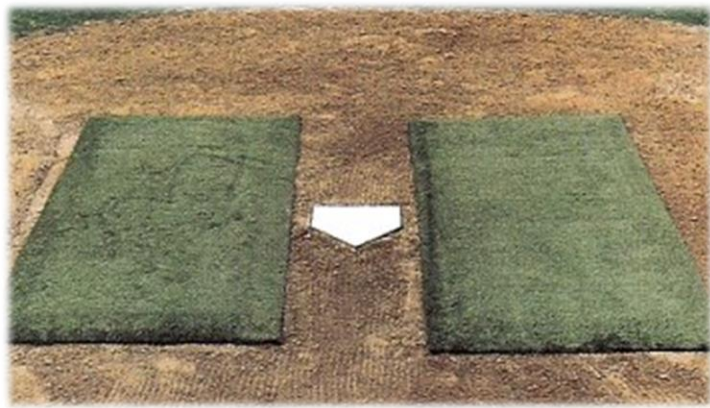

## ORIGINAL JOX BOX

Set - #OJBSET

One Panel - #OJSINGLE

- Gives players a level, solid surface
- Natural feel allowing players to dig in
- Easy to install
- 3" thick
- Tapered to ensure safety when sliding
- Cover with ½" infield mix

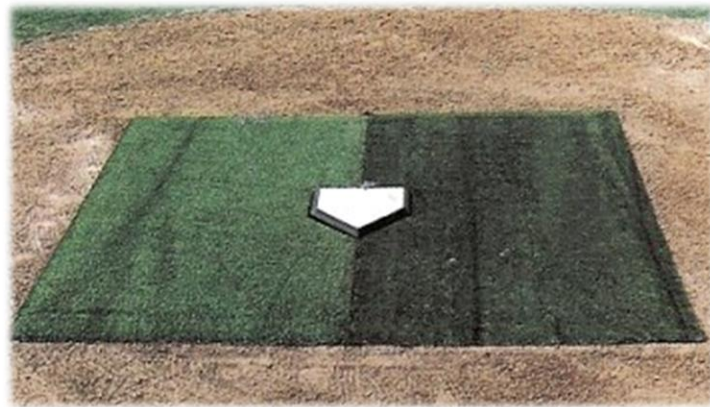

## DELUXE JOX BOX

Set - #DJBSET

Left Panel - #DJBRIGHT

Right Panel - #DJBLEFT

- Gives players a level, solid surface
- Natural feel allowing players to dig in
- Easy to install
- 3" thick
- Tapered to ensure safety when sliding
- Cover with ½" infield mix



## SOFTBALL MOUND JOX BOX

#JBSB

- Gives players a level, solid surface
- Natural feel allowing players to dig in
- Easy to install
- 3" thick
- Cover with ½" infield mix

## BASE JOX BOX

#JBB

- Gives players a level, solid surface
- Natural feel allowing players to dig in
- Easy to install
- 3" thick
- Tapered to ensure safety when sliding
- Cover with ½" infield mix





## CUSTOM IMPRINT AVAILABLE



### Tuffy® WINDSCREEN

- Construction: 1,000 denier x 800 denier Vipol® Matrix Mesh (18 x 14 ends/inch).
- Fabric Weight: 10oz./sq. yd. Shading: 78% Shading.
- Tensile Strength: 360 x 320 lbs.
- Sewn Hems: Three-Ply hem with ends and corners sewn and finished with two rows of lock stitched thread.
- Thread: High heat bonded polyester with UV inhibitors built into yarn.
- Grommets: #2 brass Grommets every 12".
- Seams: 6' Screens are a solid panel with no horizontal seams. 9' Screens are two panels prayer seamed together with a reinforced weld and one row of black UV treated thread at the center of the screen. They include grommets every 12".



### 8" REPLACEMENT TIES

100 Pack - #L850UV100

1000 Pack - #L850UV1000

- 50 lb tensile strength
- 8" long



## Aer-Flo®VINYL WINDSCREEN

- Construction: 1,000 denier x 1,300 denier (18 x 17 ends/inch).
- Fabric Weight: 18oz./sq. yd.
- Shading: 100% Shading.
- Cold Crack: Minus 40 degrees F°.
- Sewn Hems: Three-Ply hem with ends and corners sewn and finished with two rows of lock stitched thread.
- Thread: High heat bonded polyester with UV inhibitors built into yarn.
- Grommets: #2 brass Grommets every 12".
- Seams: 6' Screens are a solid panel with no horizontal seams. 9' Screens are two panels prayer seamed together with a reinforced weld and one row of black UV treated thread at the center of the screen. They include grommets every 12".



## Aer-Flo®VCP WINDSCREEN

- Construction: 1,000 denier x 1,000 denier vinyl coated polyester mesh (9 x 12 ends/inch).
- Fabric Weight: 8oz./sq. yd.
- Shading: 70% Shading.
- Sewn Hems: Three-Ply hem with ends and corners sewn and finished with two rows of lock stitched thread.
- Thread: High heat bonded polyester with UV inhibitors built into yarn.
- Grommets: #2 brass Grommets every 12".
- Seams: 6' Screens are a solid panel with no horizontal seams. 9' Screens are two panels prayer seamed together with a reinforced weld and one row of black UV treated thread at the center of the screen. They include grommets every 12".



## BALLASTED WINDSCREEN

As winds exceed 20 mph, units billow to allow potentially damaging high wind velocities to blow through, helping to PROTECT FENCE and WINDSCREEN

- Vipol® Matrix Mesh Fabric
- Construction: 1,000 denier x 800 denier (18 x 14 ends/inch). 10oz./sq. yd.
- 78% Shading
- Tensile Strength: 360 x 320 lbs.





**WIND WEIGHTED ®TARPS**

- 12' Diameter - #WWTARP12**
- 18' Diameter - #WWTARP18**
- 20' Diameter - #WWTARP20**
- 26' Diameter - #WWTARP26**
- 30' Diameter - #WWTARP30**
- Set of (3) 10' Diameter - #WWTARP310**



- Vinyl Covering: 18oz./sq. yd. fully COATED vinyl on base fabric scrim of 1,000 denier x 1,300 denier polyester. Fabric meets following tests: Tear Strength Tests: Warp 100 lbs., Fill 100 lbs., Grab Tensile Strength: Warp 410 lbs., Fill 410 lbs., Weft Insertion: 18 x 17. Vinyl compounded with UV inhibitors and mold inhibitors. Cold Crack: minus 40 degrees F°.
- Perimeter Pocket Weight: 1/4" Hot Dipped Galvanized Grade 30 Proof Coil Chain. Material Diameter is 0.276". Working Load Limits 1,300 lbs. Proof Load Test 2,600 lbs. Minimum Breaking Load 5,200 lbs. Inside Length 1.24" Inside Width 0.38" Weight Per Foot 0.63 lbs.



**NON-WEIGHTED TARPS - 6oz**

- 10' Diameter - #6TARP10**
- 12' Diameter - #6TARP12**
- 18' Diameter - #6TARP18**
- 20' Diameter - #6TARP20**
- 26' Diameter - #6TARP26**

- Color: White/Silver Only

**NON-WEIGHTED TARPS - 18oz**

- 10' Diameter - #18TARP10**
- 12' Diameter - #18TARP12**
- 18' Diameter - #18TARP18**
- 20' Diameter - #18TARP20**
- 26' Diameter - #18TARP26**



- Made of durable 18 oz. vinyl-polyester or 6 oz. polyethylene, these quality tarps have grommets installed every 3' around perimeter and include low profile ground stakes. Both models covered by a 2-year prorated warranty against UV sunlight breakdown. This is baseball's most widely used type of cover.



- J STAKES**  
**#JS15**  
 ○ Pack of 15

**CUSTOM IMPRINT AVAILABLE ON TARPS!**

## PUDDLE SPONGE

#245-100-030

- Built to last through several seasons of use
- Keeps the integrity of your infield soil in tact, no unnecessary displacement of infield material
- Includes handy quick-dry hanger loop for easy drying
- Hydrophilic foam and filter design
- Excellent for ballfields, athletic courts or playgrounds
- Sold in cases of (3)



## STRAIGHT BLADE SQUEEGEE

36" - #76603

- 60" handle



## ABSORBENT ROLLER SQUEEGEE

36" - #72036

- 60" handle

## REPLACEMENT ROLLER 36" -

#SA10051



## DIAMOND PUMP

#BDPUMP

- Tough, lightweight ABS construction
- Pump water into a bucket or off the field with the specially designed Diamond Pump Hose



## NON-ABSORBENT ROLLER SQUEEGEE

36" - #70936

- 60" handle





## Aer-Cushion™ OUTDOOR PADDING

- Choose from models to fit any specific installation:
- Foams: Polyurethane or Cross-link Polyethylene
- Choice of outdoor plywood backing thickness: 1/2" or 3/4"
- Foam thicknesses from 1" to 4"
- Attachments to fit onto walls, chain link fences, or concrete.
- Z-Channel attachments for wood or concrete walls.
- Washer attachments for chain link fences.
- Sizes: Standard and Customized
- Padding is covered with 18 oz. vinyl in choice of 17 colors.
- Chroma-Bond® and Chroma-Bond® Digital Imprinting available

## Aer-Cushion™ INDOOR PADDING

- Standard Sizes: 2' x 5', 6' or 7' Optional Cutouts for switches/outlets. 16 colors can be mixed or alternated for dramatic effect. Order aluminum channeling separately.
- Quality pads are constructed of 18 oz. fire rated (FR) Vinyl Covering, either 1 3/8" thick Crosslink Polyethylene Foam OR 2" HD Urethane Foam, and 7/16" thick OSB board backing.
- 1" lip at top and bottom for attachment to wall, easily attach to wall with bolts OR aluminum channeling.
- Don't forget to add Chroma-Bond® Digital Imprinting on Wall Pads to support your school brand.



## SQUARE RAIL PADDING

- Backing: 3/4" B/C Exterior Grade Plywood
- Vinyl Covering: 18oz./sq. yd. fully COATED vinyl
- Filler Foam: 1 3/8" thick cross-link polyethylene foam.
- Attachment: 1/8" x 1 1/2" x 6" Aluminum Flat Bar, 2" x 2" zinc plated "L" bracket, 2" zinc plated EMT strap, #10 x 1 zinc plated hex screw and 1/4" zinc plated washer

## RAIL PADDING

- Vinyl Covering: 18oz./sq. yd. fully COATED vinyl on base fabric scrim of 1,000 denier x 1,300 denier polyester.
- Filler Foam: 1" thick polyurethane high impact foam.
- Attachment: #2 brass grommets every 8".



## PORTABLE BACKSTOP SYSTEM

15' H x 60' L - #7E201

- All-surface friendly
- Aluminum construction
- Secure anchoring system
- Ground bars to prevent balls from rolling under net

### Includes

- 1 ¾" mesh net (3B4901)
- 4 upright poles, 3 ground bars
- 16 Heavy Duty Anchor Bags (10B7011)
- Net Clips



## 20' MULTI-SPORT BASKSTOP SYSTEM

20' H x 80' L - #7E501

- Stainless steel cable tensioning system
- Hoist system for easy net handling
- Aluminum construction
- HTPP, 1 3/4" mesh net
- Professional, powder-coated finish

### Includes

- Five 4" round aluminum support poles
- 5 ground sleeves with caps
- Net (3E501)



## 20' SOCCER BASKSTOP SYSTEM

20' H x 65' L - #7B101

- Hoist system for easy net handling
- Professional, powder-coated finish
- Four, 4" round support poles
- Durable, aluminum construction
- 4" mesh net (sized to ensure soccer balls cannot slip through)

### Includes

- Four 4" round aluminum support poles
- 4 ground sleeves with caps
- Net (3B2866)



Other models are available!  
We can get what you need!



## CUSTOM BARRIER NETTING

- Dipped and Treated for UV protection and Increased Abrasion Strength
- Thick Rope Border for Easy Installation
- High-Grade Nylon Material versus low-end Poly Netting
- Fastest Turnaround Times in the Industry
- Woven rope border or sewn rope border available
- GOLF and SOCCER mesh available

- ✓ **ANY SIZE**
- ✓ **ANY FIELD**
- ✓ **ANY PROJECT**
- ✓ **INDOOR OR OUTDOOR**

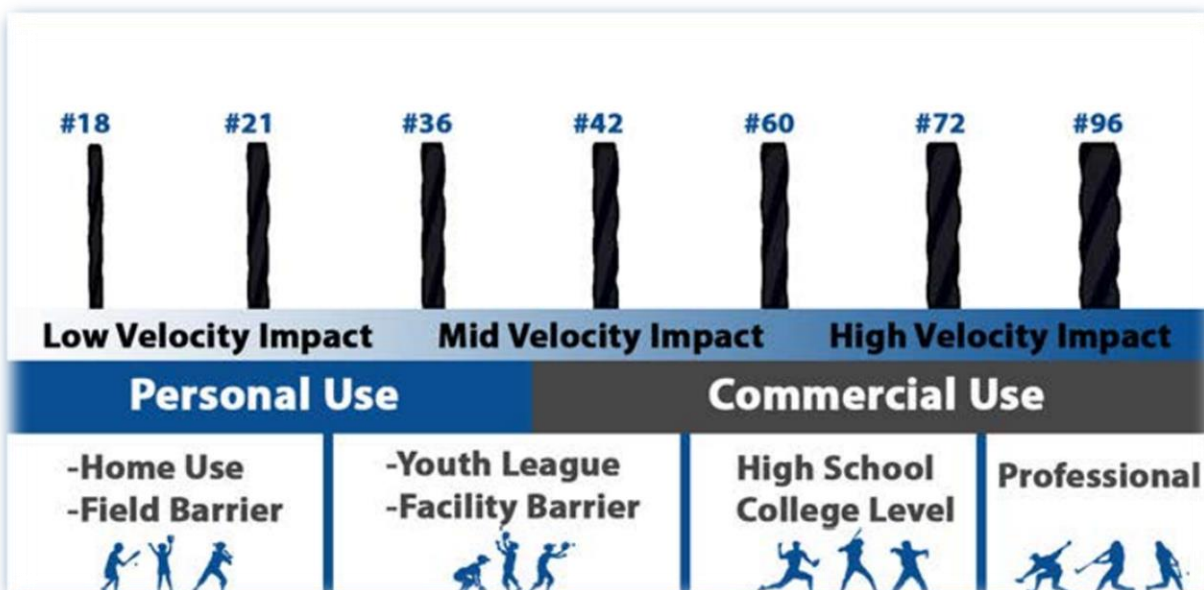

#PL705



- One of our most popular and versatile surfaces.
- No infill needed, making it ideal for indoor and portable applications.
- This product can be installed indoors or outdoors on concrete or a compacted aggregate base

#T40



- GameChanger T40 is a multi-sport field product that should be installed over a compacted aggregate base. It was designed to capitalize on the well-known existing benefits of a monofilament and slit film blend while adding an infill trapping texturized thatch. The shorter pile and thatch layer are perfectly suited for newer style alternative infill solutions.
- Ideal for Football & Soccer

#T52



- GameChanger T52 is a multi-sport field product that should be installed over a compacted aggregate base. It was designed to capitalize on the well-known existing benefits of a monofilament and slit film blend while adding an infill trapping texturized thatch. The shorter pile and thatch layer are perfectly suited for newer style alternative infill solutions.
- Ideal for Football & Soccer

#PL357U

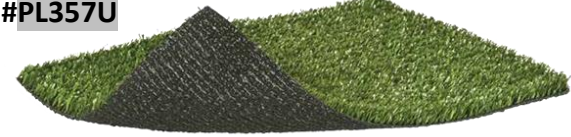

- Urethane
- This is an excellent batting cage product. This product is available in 15 ft. widths and is ideal for batting cage use.

#PL357



- 3mm Pad, or 5mm Pad
- This is an excellent batting cage product. This product is available in 15 ft. widths and is ideal for batting cage use.

#3C-46Q



- This is a field product. This product should be installed outdoors on a compacted aggregate base. The GameChanger series is the world's first tufted fabric utilizing 3 ends per needle. The 3C "Triple Coverage" system allows for more face yarn to show off its beautiful colors. This 14,000 denier system will keep your field looking newer, longer with over 50% more yarn denier above the rubber infill.
- Ideal for Football, Soccer, and Lacrosse



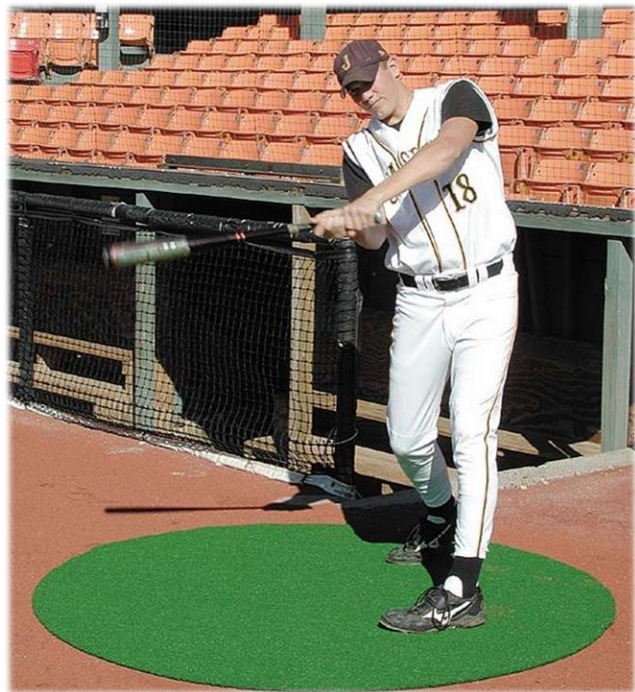

## ON DECK TURF CIRCLES

**4' GREEN - #ODC4**

**4' COLOR - #ODC4-COLOR?**

**5' GREEN - #ODC5**

**5' COLOR - #ODC5-COLOR?**

**6' GREEN - #ODC6**

**6' COLOR - #ODC6-COLOR?**

- Sold in PAIRS
- Turf with 5mm padding
- Colors available: Clay , White , Blue , Orange, Yellow , Red , Black, Purple , Crimson , Maroon , Brown , Navy

**ADVANCED  
SPORTS SUPPLY**



## STANCE TURF MATS

**3' X 7' - #TMAT3X7**

**4' X 6' - #TMAT4X6**

**6' X 12' - #TMAT6X12**

- Turf with 5mm padding
- GREEN ONLY

Other sizes are available! We can get what you need!

## 6' X 12' BATTER'S BOX TURF MAT W/ HOME PLATE

**GREEN - #BBMAT6X12**

**COLOR - #BBMAT6X12-COLOR**

- Turf with 5mm padding
- Tufted lines
- Inserted turf home plate
- Colors available: Green , Brown , Terra Cotta , Florida Blue , Orange , Red , Black

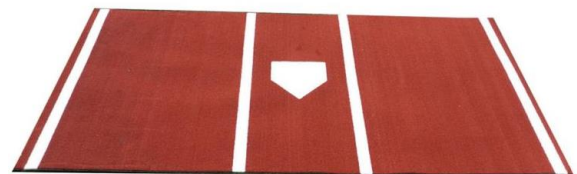

## Ultimate Pitcher's and Catcher's Plate

**#TA2043A**

- Expands the zone to 22" instead of 17"
- Sets up soft toss target
- Includes instructions to stake down (stakes not included).
- Scuff- and stain-resistant.
- Stress-cracking resistant, with its rubber design, high-gloss finish.
- Weighs under 2 lb.





## “THE HALL” BASE SET

### #B001PW

- Set of 3 bases
- Brute-strength, pebble embossed, UV-resistant, molded white rubber pro-style base
- HD P.U. foam pad
- Welded steel anchor system, powder coated, rust-resistant
- Reinforced side walls
- Ground anchors and base plugs included



## PRO BASE SET

### #B001x

- Set of 3 bases
- Pebble embossed, UV-resistant, molded white rubber pro-style base
- HD P.U. foam pad
- Triple reinforced steel anchor, nickel-plated, rust-resistant
- Reinforced side walls
- Ground anchors and base plugs included



## CHAMPRO IMPACT BASE SET

### #B002

- All rubber base and post enhances safety
- Pillar construction provides vertical stability and horizontal flexibility
- Pebble embossed, UV-resistant
- Ground anchors and base plugs included



## CHAMPRO DOUBLE FIRST BASE

### #B004

- All rubber construction
- Pebble embossed, UV-resistant
- Steel double anchor and base plugs included

Don't forget your base plugs!





## A SERIES SoftTouch® BASES

### #A1500

- (3) 15" bases with in-ground mounting system

### #A15DBL-SET

- 15" Double first, 2<sup>nd</sup> and 3<sup>rd</sup> base with in-ground mounting system and disk with spike

### #A150L

- (3) 15" bases – COVERS ONLY

### #A15DBL/NM

- 15" double first base – COVER ONLY

## C SERIES SoftTouch® BASES

### #C1500

- (3) 15" bases with convertible tees

### #C15DBL-SET

- 15" Double first, 2<sup>nd</sup> and 3<sup>rd</sup> base with convertible tees

### #C150L

- (3) 15" bases – COVERS ONLY

### #C15DBL/NM

- 15" double first base – COVER ONLY



## S SERIES SoftTouch® BASES

### #S1500

- (3) 15" bases with convertible tees

### #S15DBL-SET

- 15" Double first, 2<sup>nd</sup> and 3<sup>rd</sup> base with convertible tees

### #S150L

- (3) 15" bases – COVERS ONLY

### #S15DBL/NM

- 15" double first base – COVER ONLY



## Soft Touch® Bases

- Great for game or practice
- Material: Durable cut resistant polyurethane
- Dimensions: (Double) 30 x 15 x 2 3/8  
(Single) 15 x 15 x 2 1/2
- These sets are also available with two 14" single bases
- Made in the USA
- Replacement parts available
- TURF MODELS AVAILABLE!



## CHAMPRO DISLODGING BASE SET

#B072

- Set includes 3 single bases
- Official size to meet Little League requirements
- HD all rubber pad
- Complies with Little League rule 1.06
- Ground anchors and base plugs included



## CHAMPRO DISLODGING DOUBLE FIRST BASE

#B073

- Official size to meet Little League requirements
- HD all rubber pad
- Complies with Little League rule 1.06
- Steel Double ground anchor and base plugs included

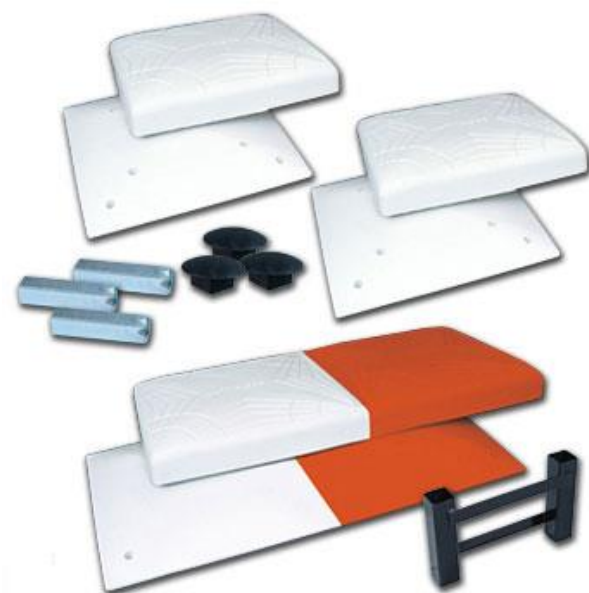

## CHAMPRO DISLODGING DOUBLE FIRST BASE SET

#B072S

- Set includes 2 single bases and 1 double first
- Official size to meet Little League requirements
- HD all rubber pad
- Complies with Little League rule 1.06
- Ground anchors and base plugs included



- Heavy-duty all rubber construction
- Bases insert into standard anchor system (no special installation required)
- Includes steel anchor system and rubber base plugs



On impact, the top pad dislodges from the bottom plate. The pad of the base is engineered to maintain vertical rigidity, to support a player standing on the base, while maximizing horizontal flexibility so that the pad will flex on impact.

The plate of the base is designed to be streamlined and low to the ground to allow the player to smoothly slide over the plate after the pad dislodges.



To reset the pad after it has dislodged from the plate, the posts on the pad may simply be aligned with the holes in the plate and inserted. The pad can be reset on the plate in seconds.

**CHAMPRO**





### IN-GROUND HOME PLATE SOLID WOOD

#B035R

- Official size
- Moisture resistant solid wood construction is designed for professional use
- Extra durable UV resistant rubber shell

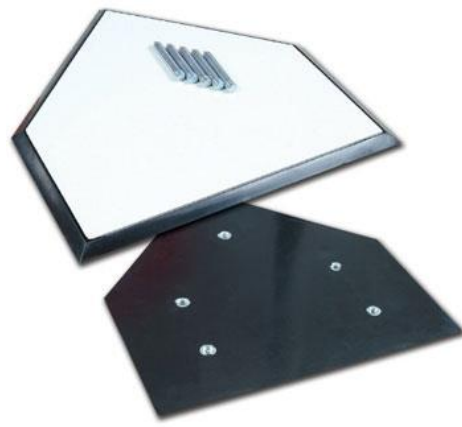

### 5-SPIKE HOME PLATE

#B031

- Five nickel plated steel threaded spikes



### IN-GROUND HOME PLATE WOOD

#B035

- Official size
- Constructed so plate can be buried for permanent installation
- UV resistant rubber won't break down from prolonged exposure to sunlight
- Wooden bottom



### STANCHION MOUNT HOME PLATE

#B030I

- Official size
- Tough molded rubber with beveled black border
- Fits same ground anchor as B001X Hollywood style base
- Includes all hardware for assembly plus anchor & base plug



### IN-GROUND HOME PLATE WAFFLE BOTTOM

#B035W

- Official size
- Constructed so plate can be buried for permanent installation
- All-rubber construction
- UV resistant rubber

### CLEAT CLEANER

#ACCB



### BULLDOG DOUBLE SIDED HOME PLATE

#BDHP

- Official size
- Double sided for maximum use



- Perfect for use outside a locker room, near a team bench or on the backside of a pitcher's mound
- Durable all-rubber construction
- 84 spikes for removing mud from cleats
- Can be mounted to treated wood and buried for permanent installation



### 3-SPIKE PITCHING RUBBER

Youth - #B041

Official - #B040

- Reinforced threaded steel spike fixtures
- Three nickel-plated steel spikes
- Heavy duty, 1.75 cm thick UV resistant rubber construction



### DUAL SPIKE PITCHING RUBBER

Youth - #B048

Official - #B047

- Double spike anchor system allows for quick installation and removal
- Heavy duty rubber construction



### STEP DOWN PITCHING RUBBER – WOOD BOTTOM

Youth - #B046

Official - #B045

- Two-level molded construction prevents uneven holes in front of rubber
- Buries for permanent installation
- Heavy duty UV resistant rubber construction



### STEP DOWN PITCHING RUBBER – ALL RUBBER

Youth - #B046W

Official - #B045W

- Two-level molded construction prevents uneven holes in front of rubber
- Buries for permanent installation
- Heavy duty UV resistant rubber construction

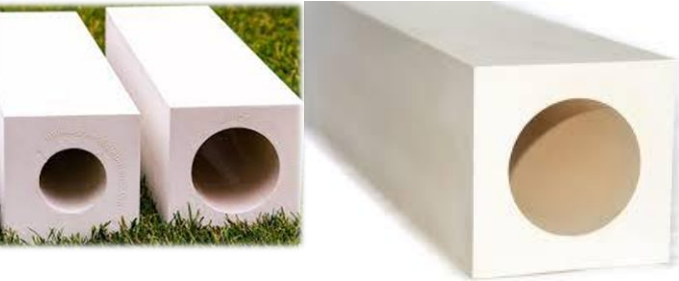

### BULLDOG 4-WAY PITCHING RUBBER

Official, 4" Center - #BDPR4A

Official, 3" Center - #BDPR3A

Youth, 2" Center - #BDPR3A

- Solid rubber construction



### 4-WAY PITCHING RUBBER

Youth - #B044

Official - #B043

- Heavy duty UV resistant rubber construction
- Heavy duty four-side construction ensures flat surface can be rotated for many years of use



### DUAL STANCHION PITCHING RUBBER

Youth - #B049

Official - #B042

- In-ground dual stanchion system
- Rubber secures to anchor with two bolts
- UV resistant rubber





### STADIUM FOUL POLES INGROUND

- 12'
- WHITE - #BSPOLE-12PW
- YELLOW - #BSPOLE-12P
- ORANGE - #BSPOLE-12PO
- 15'
- WHITE - #BSPOLE-15PW
- YELLOW - #BSPOLE-15P
- ORANGE - #BSPOLE-15PO
- 20'
- WHITE - #BSPOLE-20PW
- YELLOW - #BSPOLE-20P
- ORANGE - #BSPOLE-20PO
- 30'
- WHITE - #BSPOLE-30PW
- YELLOW - #BSPOLE-30P
- ORANGE - #BSPOLE-30PO

### STADIUM FOUL POLES SURFACE-MOUNT

- 12'
- WHITE - #BSPOLE-12SMW
- YELLOW - #BSPOLE-12SM
- ORANGE - #BSPOLE-12SMO
- 15'
- WHITE - #BSPOLE-15SMW
- YELLOW - #BSPOLE-15SM
- ORANGE - #BSPOLE-15SMO
- 20'
- WHITE - #BSPOLE-20SMW
- YELLOW - #BSPOLE-20SM
- ORANGE - #BSPOLE-20SMO
- 30'
- WHITE - #BSPOLE-30SMW
- YELLOW - #BSPOLE-30SM
- ORANGE - #BSPOLE-30SMO

### GROUND SLEEVE - #BSPOLE-GS35

- 12'
- 4' L x 18" W steel mesh wing
- 3 1/2" O.D. tubular steel 12' tall galvanized steel post
- Powder coated
- 15'
- 8' L x 18" W steel mesh wing
- 3 1/2" O.D. tubular steel 15' tall galvanized steel post
- Powder coated
- 20'
- 12' L x 18" W steel mesh wing
- 3 1/2" O.D. tubular steel 20' tall galvanized steel post
- Powder coated
- 30'
- 18' L x 18" W steel mesh wing
- 5 9/16" O.D. tubular steel 30' tall galvanized steel post
- Powder coated



Other models are available!  
We can get what you need!  
Check us out online at  
[advancedsportssupply.com!](http://advancedsportssupply.com)





## PITCHER'S POCKET

- WORK ON PITCH LOCATIONS IN AND OUT OF THE STRIKE ZONE
- VERSATILE DESIGN FOR INFIELD DRILLS AND THROWING PRACTICE
- PAIRS WELL WITH BATTING CAGES AND PITCHING MACHINES



SIDE BY SIDE COMPARISON

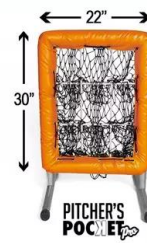

## PITCHER'S POCKET Pro

- HONE IN ON PITCH ACCURACY IN THE STRIKE ZONE
- ACCURATE AND REALISTIC STRIKE ZONE
- IDEAL FOR BULLPENS AND PITCHING PRACTICE

### Pitcher's Pockets

9 Hole - #PITCHERSPOCKET9

12 Hole - #PITCHERSPOCKET12

16 Hole - #PITCHERSPOCKET16

Pro (shown) - #BBPPRO

- Vinyl Colors: Black, Navy, Royal Blue, Columbia Blue, Maroon, Red, Purple, Dark Green, Green, Orange, Yellow

- Industrial Gauge #60 Net with Galvanized Steel Frame. Perfect for outdoor/indoor use
- Challenge the player by ensuring they hit their spots with the individual pockets
- Perfect size to teach players to throw strikes but also big enough to leave the ball out of the zone
- No need for a catcher to ensure you get your daily reps. The nine targets keeps players engaged
- Ships fully Assembled. Adjustable legs change height and detachable for easy storage
- PRO dimensions - 22"W x 30"H
- Regular dimensions - 35"W x 45"H



### Bullet L Screen 7'x7'

Standard - #BULLETL

w/ Padding - #BULLETLP

w/ Wheels - #BULLETLW

w/ Padding & Wheels - #BULLELPW

- Vinyl Colors: Black, Navy, Royal Blue, Columbia Blue, Maroon, Red, Purple, Dark Green, Green, Orange, Yellow
- 5-Year Warranty on Frame
- 14 Gauge Galvanized Steel Frame
- #60 UV Treated Nylon, Double Layer Pillowcase Netting
- Heavy Duty 18oz Vinyl & 1 1/2" Impact Foam Padding
- 10" Solid Wheel Kit with Steel Plate Cover Option



### Bullet Front Toss 7'Hx5'W

Standard - #BULLEFT

w/ Padding - #BULLEFTP

w/ Wheels - #BULLEFTW

w/ Padding & Wheels - #BULLEFTPW

- Vinyl Colors: Black, Navy, Royal Blue, Columbia Blue, Maroon, Red, Purple, Dark Green, Green, Orange, Yellow
- 5-Year Warranty on Frame
- 14 Gauge Galvanized Steel Frame
- #60 UV Treated Nylon, Double Layer Pillowcase Netting
- Heavy Duty 18oz Vinyl & 1 1/2" Impact Foam Padding
- 10" Solid Wheel Kit with Steel Plate Cover Option





## Bullet L Screen Combo 7'x7'

Standard - #BULLETCOMBO

w/ Padding - #BULLETCOMBOP

w/ Wheels - #BULLETCOMBOW

w/ Padding & Wheels - #BULLETCOMBOPW

- Vinyl Colors: Black, Navy, Royal Blue, Columbia Blue, Maroon, Red, Purple, Dark Green, Green, Orange, Yellow
- 5-Year Warranty on Frame
- 14 Gauge Galvanized Steel Frame
- #60 UV Treated Nylon, Double Layer Pillowcase Netting
- Heavy Duty 18oz Vinyl & 1 1/2" Impact Foam Padding
- 10" Solid Wheel Kit with Steel Plate Cover Option

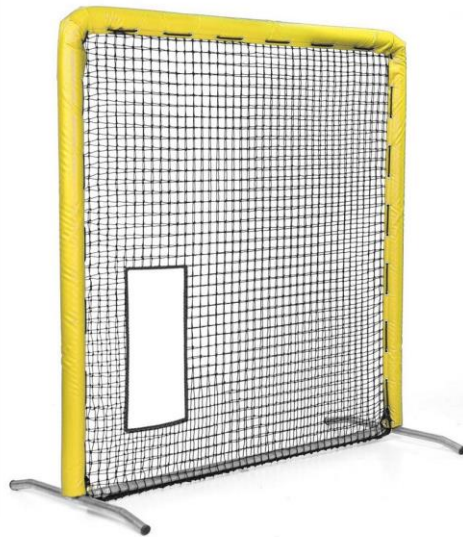

## Protective Screens

7'x7' Standard - #PROTECTIVE7X7

7'x7' w/ Padding - #PROTECTIVE7X7P

7'x7' w/ Wheels - #PROTECTIVE7X7W

7'x7' w/ Padding & Wheels - #PROTECTIVE7X7PW

10'x10' Standard - #PROTECTIVE10X10

10'x10' w/ Padding - #PROTECTIVE10X10P

10'x10' w/ Wheels - #PROTECTIVE10X10W

10'x10' w/ Padding & Wheels - #PRTOECTIVE10X10PW

- Vinyl Colors: Black, Navy, Royal Blue, Columbia Blue, Maroon, Red, Purple, Dark Green, Green, Orange, Yellow
- 5-Year Warranty on Frame
- 14 Gauge Galvanized Steel Frame
- #60 UV Treated Nylon, Double Layer Pillowcase Netting
- Heavy Duty 18oz Vinyl & 1 1/2" Impact Foam Padding
- 10" Solid Wheel Kit with Steel Plate Cover Option
- Sock Net Available for the 7' x 7'!
- Fastpitch Cutout Net Available for the 7' x 7'!

Other models are available! We can get what you need!

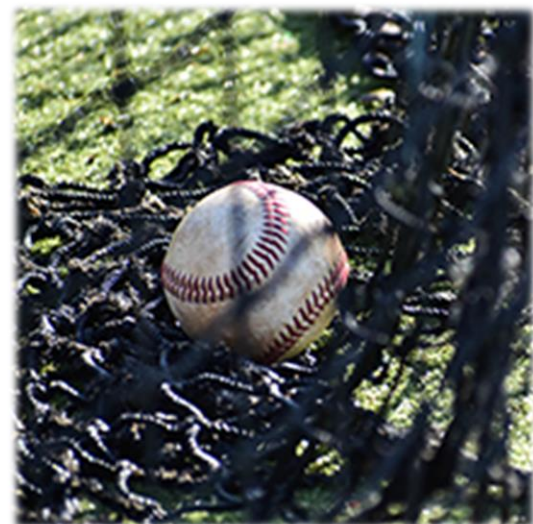
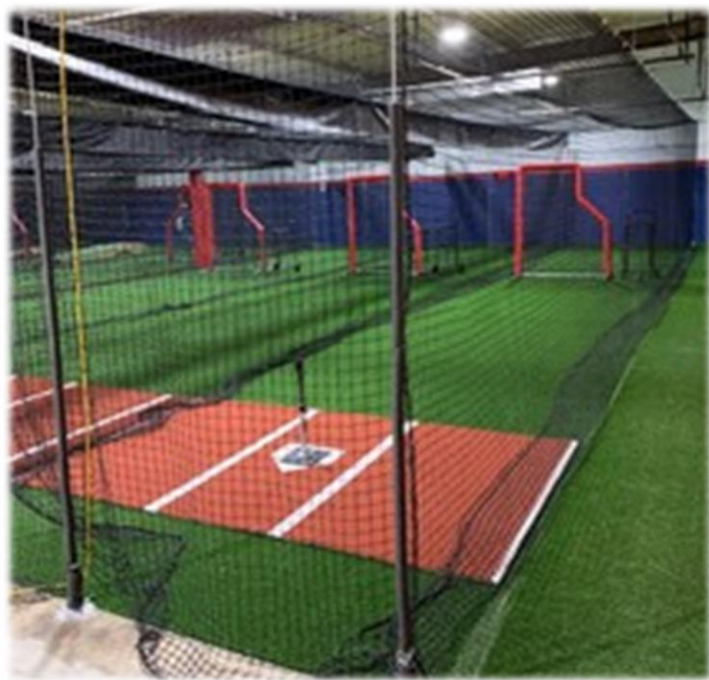

**#21 Batting Cage (Netting Only)**

**NYLON**

**12'x12'x55' - #21NYLON1255**

**12'x14'x55' - #21NYLON1455**

**12'x12'x70' - #21NYLON1270**

**12'x14'x70' - #21NYLON1470**

**POLY**

**12'x12'x55' - #21POLY1255**

**12'x14'x55' - #21POLY1455**

**12'x12'x70' - #21POLY1270**

**12'x14'x70' - #21POLY1470**

**#36 Batting Cage (Netting Only)**

**NYLON**

**12'x12'x55' - #36NYLON1255**

**12'x14'x55' - #36NYLON1455**

**12'x12'x70' - #36NYLON1270**

**12'x14'x70' - #36NYLON1470**

**POLY**

**12'x12'x55' - #36POLY1255**

**12'x14'x55' - #36POLY1455**

**12'x12'x70' - #36POLY1270**

**12'x14'x70' - #36POLY1470**

- Square, Knotted, UV Treated, and Weather Treated Nylon and Poly Netting
- Entry Flap for Easy Access
- Double Net Baffle Behind Batter for Added Durability
- Sewn Rope Border on All Edges
- Snap Hooks at Corners for Easy Installation
- Weighted Lead Rope Bottom

Custom cage sizes and designs are available! At Advanced Sports Supply, we can design it for you, and get what you need!





## Heavy Duty Batting Tee

#B0501

- Heavy-duty, official size rubber plate
- Telescoping rubber tubes adjust height from 21" to 36"
- Bottom tube features PE insert for increased durability



## Brute Spring Loaded Batting Tee

#B083

- Spring loaded batting tee rebounds after every hit
- Portable and easily collapses for transport
- Flexible top reduces swing resistance
- 8lb weighted base with feet for added support and grip on all surfaces
- Height adjusts from 23" to 43"
- Includes 2-year warranty



## 5-Position Batting Tee

#B063

- Train for every pitch with 5 hitting positions
- Heavy-duty, official size rubber plate
- Telescoping tubes adjust height from 21" to 36"
- Tubes snap onto plate for easy transport



## Attack Angle Batting Tee

#B085

- Position the Attack angle adapter in 5 different positions to achieve varying degrees of attack
- Enhance toughness to achieve a higher level of durability
- Tubes snap onto plate for easy transport
- Height adjusts from 27" to 42"

## PV Tee Batting Tee

#TA2401

- Flexible pivot joint tee rebounds after every hit
- Unique magnet system allows to break down in one second for easy transport
- Weighted rubber base
- Height adjusts from 27" to 47"

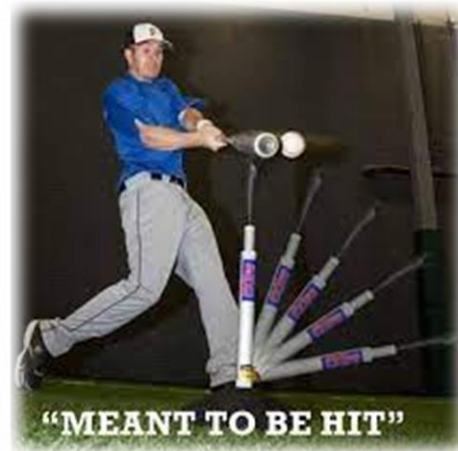



## Weighted Baseball Set

#CBB7S

- Set of 6 (7 oz, 8 oz., 9 oz., 10 oz., 11 oz. & 12 oz.)
- Full grain leather covers
- Raised Seams
- Training Program included



## Weighted Softball Set

#CSB7S

- Set of 4 (9 oz., 10 oz., 11 oz. & 12 oz.)
- Full grain leather covers
- Raised Seams
- Training Program included



## Reaction Ball

#CBBRB

- Designed to bounce randomly to enhance coordination and reaction time
- Train solo against a wall or with a partner
- Ideal training tool for any sport



## 7.5" Training Baseball Set

#CBB775S

- 7.5" baseballs improve batter focus and accuracy.
- Cork and rubber core
- Metered tension 5% wool yarn
- Genuine leather cover

## Control Flight Ball - DZN

Baseball 9" - #CBB91

Softball 10" - #CSB93

- 15 oz. weighted ball increases power and contact rate
- Durable, limited flight construction
- Miss-hits provide immediate feedback



WITNESS IMMEDIATE FEEDBACK FOR ALL LEVELS OF SOFTBALL/BASEBALL PRACTICES

## Poly Balls

#CBB-51 – 9" White

#CBB-51Y – 9" Optic Yellow

#CSB-51 – 12" White

#CSB-51Y – 12" Optic Yellow

- Ideal for batting practice
- Colors: white & optic yellow



## JUGS Bulldog Poly Balls

#B6005 – White Baseball DZN

#B6006 – White Baseball BULK (box of 100)

#B7010 – Optic Yellow Softball DZN

#B7011 – Optic Yellow Softball BULK (box of 84)

- Ideal for batting practice
- Great for Pickleball
- Colors: white (Baseball) & optic yellow (softball)
- Sold in Dozens or Bulk Box

## Poly Golf Balls

#CBB-52 – White

#CBB-52Y – Optic Yellow

- Ideal for batting practice







## Designated Hitter – PRO & YOUTH

#TA2131 – PRO

#TA2132 – YOUTH

- Can be used indoors or outdoors
- Allows pitchers to practice without live batter
- Builds confidence for pitchers facing different kinds of hitters
- Simulates a left or right-handed batter
- Pro Model Stands 5'9" tall, Youth Model Stands 5'2"
- Is portable and easy to transport
- Comes in red, blue or gray color

## CPX Series Fielder's Training Glove

#CPX

- All cowhide leather construction
- Adjustable wrist with hook and loop fastener
- Right Hand Thrower



## JUGS Radar Gun

#R2050

- Operates in two user-friendly modes—Trigger mode and Continuous mode.
- FAST, LAST and FAST/LAST Functions: FAST captures readings at the release point. LAST captures readings at the plate. FAST/LAST captures both.
- Five pitch recall
- Data port for transmitting data to a display or computer.
- 6 NiMH rechargeable batteries - Batteries recharge in just 2 hours.

## SMART COACH RADAR™ APP SYSTEM

#SR1100

- Instant Feedback with Remote Speed Display and Audio Speed Announcement
- Track Results over time with Instant History Review and Data Export
- Get Speeds Instantly and Record Video with Embedded Speeds at the Same Time
- Review Mechanics and Results with Speed Embedded in Video
- Capture and Share Video with Speed for Remote Coaching
- Share Videos of Results/Improvement Socially to Friends, Coaches and Recruiters
- Upload Your Videos to other training/recruiting software and apps
- Compatible with Pocket Radar App
- Apple Devices Running iOS 14 and above.
- Leading Android Devices Running OS 6.0 and above.
- Bluetooth Connectivity 4.0 and above.
- Product Includes: Radar, Soft-Shell Belt Holster Case, Wrist Strap, 2 AAA alkaline batteries, Quick Start Guide and 2 Year Warranty



## BALL COACH RADAR

#PR1000-BC

- The Ball Coach Radar™ is a pro-level radar gun and speed training tool for smart player development through one-on-one coaching or self-guided drills, and hands-free operation keeps it simple.
- NOTE: NOT COMPATIBLE with Pocket Radar App
- Product Includes: Radar, Soft-Shell Belt Holster Case, Wrist Strap, 2 AAA alkaline batteries, Quick Start Guide and 2 Year Warranty





## JUGS BP3 Baseball Pitching Machine

### #M1030

- Select-A-Pitch™ Dial: The BP®3 throws 9 different pitches at the turn of a dial including fastballs, split-finger fastballs, changeups, and right- and left-handed curveballs, sliders, and cutters.
- Micro-Adjustment: Pinpoint™ control at your fingertips—the most advanced and easy-to-use pitch targeting system ever developed for a pitching machine.
- Fastball/Changeup Hitting Circuit: 3 preset hitting circuits allows the machine to automatically change between fastball and changeup giving your hitters a "real" pitcher vs. hitter experience.
- Patented Grip-Tite™ 12" non-marking pneumatic tires—Average 20-year life expectancy compared to 5-year solid-tire life expectancy.
- Grip-Tite™ tires provide superior pitch accuracy compared to any other 3-wheel machine. Grip-Tite® tires will not melt, crack or chunk like solid tires.
- Always see the ball™ delivery system: A clear and uninterrupted view of the ball throughout the entire pitch process allows the hitter to realistically time their stride.
- Throws baseballs, JUGS Pearl®, Sting-Free® baseballs, Lite-Flite® baseballs, Softie® baseballs and Bulldog™ poly balls.
- Runs on 110-volt AC or the Powerhorse® Portable Inverter Generator—2000.



## JUGS BP2 Baseball Pitching Machine

### #M1020

- Realistic delivery height of 64" for a downward plane on the pitch
- Digital speed adjustment allows you to adjust speed with the turn of a knob (Speed range of 45-90 mph)
- Pinpoint Micro-Adjustment locates pitches instantly - right to left, up or down with a quick turn of the wrist
- 6 pre-set pitch positions - Tire chassis rotates around the feed chute for fast and easy setup
- Select-A-Pitch Dial - change between 6 pitches with a turn of the dial for fastballs, split-fingers, left or right handed curveballs, and left or right handed sliders
- Easy to move and setup
- Trusted and used at any level of baseball play



## JUGS MVP Combo Pitching Machine

#M1601

- Throw at the speed you desire (20-60 mph) with a digital readout display
- For baseball: The MVP® comes with a baseball chute and long straight legs
- For softball: The MVP® comes with a 12" softball chute and curved legs
- Throws baseballs, softballs, sting-free, dimpled, and seamed balls
- Special non-marking pneumatic tire
- Patented "always see the ball"™ delivery system
- Weight: 56 lbs



## JUGS Combo Pitching Machine

#M1300

- This machine has the ability to throw 20-104 mph
- Lets you switch from baseball to softball in a matter of seconds
- Portable, easy to set up, and perfect for tight budgets.
- Patented goose neck design provides full range of movement to adjust for all types of pitches - fastballs, curveballs, sliders and split-finger fastballs
- The swivel-design base provides 360 degree movement to produce fly balls, ground balls, and pop-ups



## DIMPLED MACHINE BALLS

- #CBB-58 – **Baseball Yellow**
- #CBB-58Y – **Baseball Optic Yellow**
- #CBB-56 – **Baseball White**
- #CSB-59 – **12" Softball Yellow**
- #CSB-57 – **11" Softball Yellow**

- Soft dimple molded baseball
- Ideal for Jugs® machine



## JUGS Pearl Machine Baseball

- #B5200 – **Dozen**
- #B5210 – **Bucket of 4 DZN**

- Sold by the dozen and by the bucket (4-dozen)
- The first leather baseball designed specifically for pitching machines
- FULL GRAIN LEATHER COVER, cushion-corked center, wool winding
- KEVLAR SEAM lasts 5 times longer than any other brand of baseball when used with machines
- Regulation size and weight: 9 in./5 oz



## Diamond Machine Baseball

#DMPB

- Full grain leather
- Dual color stitching
- Kevlar reinforced flat seams
- Blended cork and rubber core

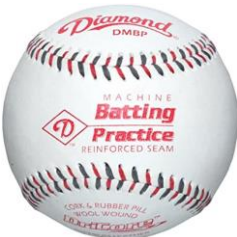

## NFHS/NOCSAE Tournament Baseballs



### Wilson A1010 PRO-SST **NFHS**

#WTA1010BPROSST

- NFHS stamped/approved
- A-grade full grain leather and Super Seams
- Premium gray wool/double cushioned cork pill
- Dura-Core technology



### Diamond D1-PRO HS **NFHS**

#D1-PRO HS

- NFHS stamped/approved
- A-grade full grain leather
- Raised Diamond seams
- Premium A-1 grade gray wool
- Double cushioned cork pill



### Rawlings R100-H1 **NFHS**

#R100-H1

- NFHS stamped/approved
- Full grain leather
- Superstitch high seam technology
- Cushioned cork center



### Rawlings R100-H2 **NFHS**

#R100-H2

- NFHS stamped/approved
- Full grain leather
- Rawlings raised seam technology
- Cushioned cork center



### Rawlings R100-H3 **NFHS**

#R100-H3

- NFHS stamped/approved
- Full grain leather
- Rawlings raised seam technology
- Cushioned cork center



### Rosin Bag - DZN **NFHS**

#A020

- Powdered rosin dries hands immediately for better grip
- Can be used on hands or bat handle
- Long lasting rosin mixture in cloth bag

## NFHS/NOCSAE Game Baseballs



### Wilson A1010 HS1-SST **NFHS**

#WTA1010BHS1SST

- NFHS stamped/approved
- A-grade full grain leather and Super Seams
- Gray wool/double cushioned cork pill
- Dura-Core technology

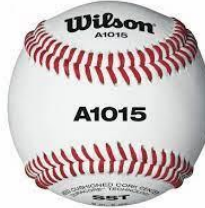

### Wilson A1015 SST **NFHS**

#WTA1015BSST

- NFHS stamped/approved
- B-grade full grain leather and Super Seams
- Gray wool/double cushioned cork pill
- Dura-Core technology



### Diamond D1-HS **NFHS**

#D1-HS

- NFHS stamped/approved
- Premium grade leather
- Raised Diamond seams
- Select grade gray wool
- Double cushioned cork pill



### Diamond DOL-A **NFHS**

#DOL-A HS

- NFHS stamped/approved
- Premium grade leather
- Raised Diamond seams
- Select grade gray wool
- Double cushioned cork pill



### Champro CBB300 HS **NFHS**

#CBB300HS

- Ideal for HS game or College Practice
- Full grain leather
- MTB moisture barrier technology
- Cushioned cork center
- Raised seams



### Rawlings ADV-1 **NFHS**

#ADV-1

- NFHS stamped/approved
- Full grain leather
- Rawlings raised seam technology
- Cushioned cork center



### Rawlings ADV-2 **NFHS**

#ADV-2

- NFHS stamped/approved
- Full grain leather
- Rawlings raised seam technology
- Cushioned cork center

# Practice Baseballs



## Wilson A1010S

#WTA1010S

Bucket of 3dzn - #WTA1098 X-OUT

- A1010 balls with minor imperfections
- Super seams with A-grade full grain leather
- Gray wool/double cushioned cork pill
- Dura-Core technology



## Wilson A1030 (Batting Practice)

#WTA1030B

Bucket of 3dzn - #WTA1098 1030

- College and HS practice
- Super seams with full grain leather
- Gray wool/double cushioned cork pill
- Dura-Core technology



## Diamond DOL-DBA

#DOL-DBA

- Duracover synthetic cover
- Raised seams
- Yarn wound
- Cushioned cork pill



## Diamond Bucket Combos

#BKT B DOL-A OL

#BKT B DBX 30

- Premium grade leather with blems
- Diamond seams
- Select wool
- Cushioned cork pill
- (30) Balls per bucket



## Ball Bucket with Padded Lid

#BUCKET-B

- Durable plastic construction
- Foam padded lid for comfortable sitting
- Fits 4 dzn baseballs or 18 softballs
- 6-Gallon capacity



## Easton MEGA Ball Bag

#A159061BK

- Holds 132 baseballs or 51 softballs
- Large zipper opening for easy access
- Main opening flap designed for team embroidery
- Five strategically placed for added durability
- 11.5" L x 11.5" H x 17" H



## Champro Ball Caddy

#NB33

- Two-in-one design combines stand for batting practice with a removable drawstring storage bag
- Shock corded steel poles form tri-pod for greater stability
- Assembles and collapses in minutes
- Carrying capacity: 60 baseballs, 30 softballs; standing capacity: 120 baseballs; 60 softballs

## Diamond Ball Bag

#BALL BAG – COLOR?



- Heavy-duty water resistant fabric
- Reinforced side panels to keep bag upright
- Holds 5 dozen baseballs or 2 dozen softballs
- Durable plastic base
- Heavy-duty zippers
- 7" x 10" x 16"
- Available in Black, Scarlet, Royal, Navy

## Champro Ball Bag

#E7



- Water-resistant, 600D polyester with inner lining
- Main compartment has zipper closure
- 2" web handles
- Holds 48 baseballs or 24 softballs

Other models are available! We can get what you need!

# Youth League Baseballs



## Diamond Youth Tournament

- #DSLL – Senior LLL
- #DLL – Little League
- #DBR – Babe Ruth
- #DPL – Pony League
- #DCR – Cal Ripken
- #DDB – Dixie Boys and Majors
- #DDY – Dixie Youth

- Tournament Grade, Official Stamp/Approved
- Premium full grain leather with Diamond seams
- A-grade wool blend with double cushioned cork pill



## Diamond Youth Regular Season

- #DSLL-1 – Senior LL
- #DLL-1 – Little League
- #DBR-1 – Babe Ruth
- #DPL-1 – Pony League
- #DCR-1 – Cal Ripken
- #DDB-1 – Dixie Boys and Majors
- #DDY-1 – Dixie Youth

- Competition Grade, Official Stamp/Approved
- Premium grade leather with Diamond seams
- Select wool blend winding with blended core



## Wilson Youth Tournament

- #WTA1072BSST – Senior LL
- #WTA1074BSST – Little League
- #WTA1082BSST – Babe Ruth
- #WTA1075BSST – Pony League
- #WTA1062BSST – Dixie Youth

- Tournament Grade, Official Stamp/Approved
- B-grade full grain leather with Super Seams
- Grey wool blend with double cushioned cork pill
- Dura-Core technology



## Wilson Youth Regular Season

- #WTA1072BSLL1 – Senior LL
- #WTA1074BLL1 – Little League
- #WTA1082BBR1 – Babe Ruth
- #WTA1075BPL1 – Pony League
- #WTA1078BCR1 – Cal Ripken
- #WTA1066BDM1 – Dixie Boys and Majors
- #WTA1062BDY1 – Dixie Youth

- Competition Grade, Official Stamp/Approved
- C-grade full grain leather with Super Seams
- Grey wool blend with double cushioned cork pill



## Rawlings Youth Tournament

- #RSLL – Senior LL
- #RLLB – Little League
- #RBRO – Babe Ruth
- #RPLB – Pony League
- #RCAL – Cal Ripken

- Tournament Grade, Official Stamp/Approved
- Premium full grain leather with Rawlings raised seams
- Select wool blend with double cushioned cork pill



## Rawlings Youth Regular Season

- #RSLL1 – Senior LL
- #RLLB1 – Little League
- #RBRO1 – Babe Ruth
- #RPLB1 – Pony League
- #RCAL1 – Cal Ripken
- #RDYB1 – Dixie Youth

- Competition Grade, Official Stamp/Approved
- Full grain leather with Rawlings raised seams
- Select wool blend winding with blended core



## Champro Youth Tournament & Regular Season

- #CBB-300LL – Tournament Little League

- #CBB-200LL – Regular Season Little League



## Reduced Compression & Tee Ball Baseballs



### Diamond FlexiBall Low Compression

#DFX-LC1LL – Level 1

#DFX-LC5LL – Level 5

- Excellent for indoors and out, Official Stamp/Approved
- Synthetic covers with FlexiBall Core
- Designed for tee ball games or indoor practice



### Wilson Soft Compression

#WTA1217 – Level 1

#WTA1228 – Level 5

- Excellent for indoors and out, No league stamp
- Ultra grip cover and solid sponge rubber core
- Designed for tee ball games or indoor practice



### Champro Safe-T-Soft Low Compression

#CBB-61 – Level 1

#CBB-65 – Level 5

- Excellent for indoors and out, No league stamp
- Solid sponge rubber core
- Designed for tee ball games or indoor practice

## Reduced Compression & Tee Ball Softballs



### Champro Safe-T-Soft 10"

#CSB67 – 10" Durahide

- Ideal for indoor training & t-ball
- Optic yellow durahide cover
- Solid foam rubber core
- Flat red seam
- RIF 1



### Champro Safe-T-Soft 12"

#CSB62 – 12" Durahide

- Ideal for indoor training & t-ball
- Optic yellow durahide cover
- Solid foam rubber core
- Flat red seam
- RIF 3



### Champro Safe-T-Soft 11"

- Ideal for indoor training & t-ball
- Optic yellow durahide cover
- Solid foam rubber core
- Flat red seam
- RIF 3

#CSB63 – 11" Durahide



Other models are available! We can get what you need!

## NFHS Fastpitch Softballs



### Wilson A9011

#WTA9011BSST – 12" Leather

- NFHS stamped/approved
- Solid polyurethane core
- Optic yellow cover
- 47 COR, 375 compression, red stitch
- Raised super seams



### Rawlings NFHS & ASA

#C12RYLAH – 12" Leather

- NFHS/ASA stamped/approved
- Solid polyurethane core
- Optic yellow cover
- 47 COR, 375 compression, red stitch
- Raised Dream Seams



### Dudley 43147

#43147 – 12" Leather

- NFHS stamped/approved
- Solid polyurethane core
- Yellow cover
- 47 COR, 375 compression, red stitch
- Raised seams



### Champro NFHS

#CSB5LYN – 12" Leather

#CSB5DYN – 12" Durahide

- NFHS stamped/approved
- Solid polyurethane core
- Optic yellow cover
- 47 COR, 375 compression, red stitch
- Raised seams

## Little League Fastpitch Softballs



### Dudley Little League

#4L-915Y – 12" Synthetic

#4L-713Y – 11" Synthetic

- Little League stamped/approved
- Solid polyurethane core
- Yellow cover
- 47 COR, 375 compression, red stitch
- Raised seams



### Champro Little League

#CSB28 – 12" Durahide

#CSB27 – 11" Durahide

- Little League stamped/approved
- Solid polyurethane core
- Optic Yellow cover
- 47 COR, 375 compression, red stitch
- Raised seams

## Recreational Fastpitch Softballs



### Champro Rec League

#CSB65 – 12" Durahide

#CSB66 – 11" Durahide

- Practice core
- Optic yellow durahide cover
- Raised seam, red stitch
- Perfect for outdoor practice



### Champro Rec League GAME

#CSB18 – 12" Durahide

- Solid polyurethane core
- Optic yellow durahide cover
- .44 COR, 375 compression, red stitch
- Raised seam

Other models are available! We can get what you need!





## Champro Line-up Cards

#AF61

- Four Part Form
- Packaged in sets of 12



## Wilson Line-up Cards

#WTA6761

- 30 pack of line-up cards
- Hard Case with clipboard included

## Champro Baseball/Softball Scorebook

#A07

- Includes scoring sheets for 28 games
- Each game includes 18 player scores per team
- Includes scoring instructions and line-up cards
- Heavy-duty cardstock backing

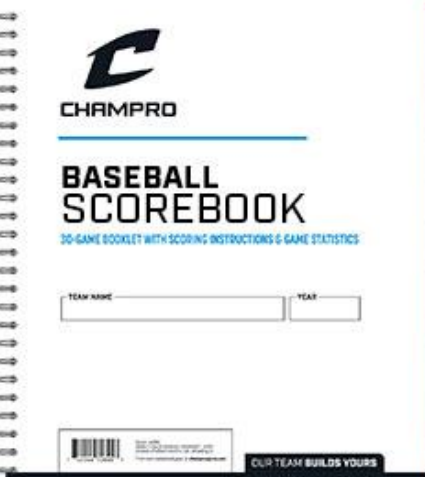

## Wilson Baseball/Softball Scorebook

#WTA3753

- Easy to read landscape format
- Includes rules, scorekeeping, guide, and pitch count
- 17 player slots

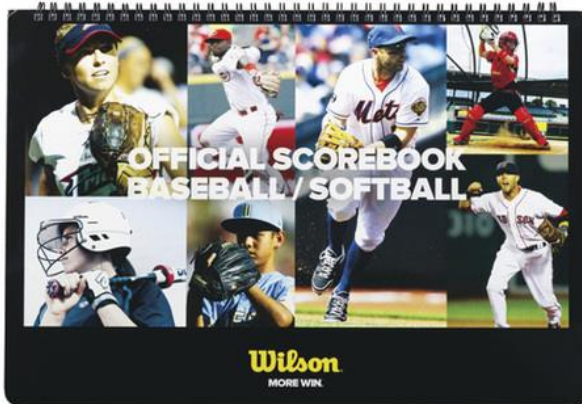

## Diamond Bucket Sleeve

#BKT SLEEVE – COLOR?

- Designed for Diamond 6-gallon bucket
- Heavy-duty water resistant fabric
- Padded seat top and adjustable shoulder strap
- Pockets for water bottle, cell phone, sunglasses, scorebook, line-up card and pens
- Mesh pocket for game balls
- Team name ID window
- 18" x 13"
- Available in Black, Scarlet, Royal, Navy





## The Grill - Defensive Fielder's Facemask

#CM01 – Adult

#CM01Y – Youth

- Dual "Grill" guards for full facial protection
- Durable low-profile steel wire construction
- Wide eye opening for enhanced sightlines
- Customize the fit with repositionable chin cup and forehead liner
- Adjustable harness with ponytail slot
- Available colors: Black, Heather Pink, Heather Lime Green, Heather Optic Blue, Royal, Scarlet, Silver, White



## Rampage Softball Fielder's Facemask

#CM02 – Adult

#CM02Y – Youth

- Max sight lines let you see the entire field
- 30% lighter than bent wire style masks
- 8 oz. premium, molded magnesium frame
- Removable and washable moisture wicking pads
- Adjustable harness with ponytail slot
- Available colors: Black, Forest Green, Gold, Heather Black, Heather Pink, Maroon, Navy, Optic Pink, Optic Yellow, Purple, Royal, Scarlet, Silver, White



### MAX SIGHT-LINES

let you see the entire field

### 30% LIGHTER

than bent wire style masks

### UNBENDABLE MAGNESIUM FRAME

in testing at 60mph





### HX Legend Plus

#HXM2JG??S – Senior

#HXM2JG??J – Junior

- Exclusive design maximizes airflow and visibility
- Weight-optimized shell with impact foam for ideal fit and feel
- Jaw pads are wrapped with soft-touch, moisture-wicking fabric for comfort and durability
- BioFresh/DRI-GEAR® moisture wicking pad liner
- Meets NOCSAE standard
- Patent pending HX Jaw guard included
- Two-tone matte finish
- Available colors: Black/White, Charcoal/Black, Navy/White, Royal/White, Scarlet/White, White/Black



### HX Rookie

#HXU?S– Senior

#HXU?J – Junior

#HXU?T – T-Ball



- Exclusive design maximizes airflow and visibility
- Weight-optimized shell with impact foam for ideal fit and feel
- BioFresh/DRI-GEAR® moisture wicking pad liner
- Meets NOCSAE standard
- Uncoated finish
- Available colors: Black, Navy, Royal Scarlet

### HX Baseball Mask

#HXFM

- Installs in minutes with simple Phillips or flat-blade screwdriver
- Precision-welded, tempered steel frame optimizes sight lines
- Includes HXCS chinstrap



### HX Rise Pro Fastpitch

#HXFPG2?S – Senior

#HXFPG2?J – Junior

- Exclusive design maximizes airflow and visibility
- Weight-optimized shell with impact foam for ideal fit and feel
- Mesh-wrapped pads for comfort and durability
- BioFresh/DRI-GEAR® moisture wicking pad liner
- Meets NOCSAE standard
- All sizes include HXMS facemask
- Two-tone graphics with glossy finish
- Available colors: White/Black, White/Navy, White/Pink, White/Royal, White/Scarlet



### HX Rookie Fastpitch

#HXFPU?S– Senior

#HXFPU?J – Junior

#HXFPU?T – T-Ball

- Exclusive design maximizes airflow and visibility
- Weight-optimized shell with impact foam for ideal fit and feel
- BioFresh/DRI-GEAR® moisture wicking pad liner
- Meets NOCSAE standard
- All sizes include HXMS facemask
- Solid color uncoated finish
- Available colors: Black, White



### Triple Crown Open Bottom Pant

#BP9UA – Adult

#BP9UY – Youth

- Loose fit, straight leg, open bottom pant
- 2 1/2" knit waistband with super-grip gel strips keep your jersey tucked
- Seven pro-style tunnel belt loops
- Reinforced double-ply sliding seat & knee
- Two inset back pockets
- Perfect inseam allows instant inseam length adjustment that secures with hook and loop
- Tek-Knit 100% polyester, 14 oz. pro-weight fabric with 4-way stretch
- Available colors: Black, Graphite, Grey, White

### Triple Crown Knicker

#BP10A – Adult

#BP10Y – Youth

- Tek-Knit 100% polyester, 14 oz. pro-weight fabric with 4-way stretch
- Modern "knicker" cut with elasticized leg openings
- 2 1/2" knit waistband with super-grip gel strips keep your jersey tucked
- Seven pro-style tunnel belt loops
- Reinforced double-ply sliding seat & knees
- Two inset back pockets
- Available colors: Black, Graphite, Grey, White

### Brute Belt

#A060 – Adult

#A060Y – Youth

- Genuine bonded leather tab
- Measured tab 9-gauge thickness
- Brute strength reinforced rivet buckle
- Adult adjusts from 24" to 48"
- Youth adjusts from 18" to 34"
- Includes 1 year warranty
- Available colors: Black, Brown, Light Blue, Cardinal, Forest Green, Gold, Grey, Kelly Green, Maroon, Navy, Optic Pink, Orange, Pink, Purple, Royal, Scarlet, Teal, White



Piping & Pinstripes are available!



### Tournament Low Rise Softball Pant

#BP11A – Adult

#BP11Y – Youth

- Tek-knit 100% polyester, 14 oz. pro-weight fabric with 4-way stretch
- Traditional low-rise pant with tapered leg and elastic leg openings
- Reinforced double-ply knees
- 2.5" knit waistband with super-grip gel strips keeps jersey tucked
- Seven pro-style tunnel belt loops
- Two inset back pockets
- Available colors: Black, Graphite, Grey, Navy, Scarlet, White

### Fireball Softball Pant

#BP39W – Adult

#BP39G – Youth

- Tek-knit 100% polyester, 14 oz. pro-weight fabric with 4-way stretch
- Low-rise softball knicker with zippered fly and double snap closure
- 2" printed elastic waistband with contrast color inner drawcord
- Reinforced double-ply knee
- Elastized leg openings
- Available colors: Black, Graphite, Grey, Royal, Scarlet, White

## ADULT APPAREL

## WOMEN'S APPAREL

	CHEST SIZE	WAIST SIZE
XS	32	26
SMALL	34-36	28-30
MEDIUM	38-40	32-34
LARGE	42-44	36-38
XL	46-48	40-42
2L	50-52	44-46
3XL	54-56	48-50
4XL	58-60	52-54

	BUST	WAIST	HIP
XS	31-33	24-26	34-36
SMALL	33-35	26-28	36-38
MEDIUM	35-37	28-30	38-40
LARGE	37-39.5	30-33	40-43
XL	39.5-42	33-36	43-46
2XL	42-45	36-40	46-49
3XL	45-48	40-44	49-52

## YOUTH APPAREL

## GIRLS' APPAREL

	CHEST SIZE	WAIST SIZE
XXS	22-24	19-21
XS	24-26	21-23
SMALL	26-28	23-25
MEDIUM	28-30	25-27
LARGE	30-32	27-29
XL	32-34	29-31
2XL	34-36	31-33

	BUST	WAIST	HIP
XS	22-24	20-21.5	22-25
SMALL	24-26.5	21.5-23	25-29
MEDIUM	26.5-29	23-25	29-32
LARGE	29-32	25-27	32-35
XL	32-35	27-29	35-37

Piping is available!



## Demarini Voodoo OG Batpack

#WB57117??

- Large main compartment fits helmet, glove, and more
- Neoprene bat sleeves hold up to 2 bats
- Padded shoulder straps and back paneling 2 additional front valuables pockets
- Fleece-lined cell phone pocket
- Removable decoration panel
- Separate shoe compartment
- Mesh water bottle slot
- Water-resistant bottom
- Integrated fence hook
- Corded zipper pulls
- Dimensions: 19" H x 12.25" W x 12" D, Weight: 2.2 lbs
- Available colors: Black, Charcoal, Dark Green, Light Gold, Maroon, Navy, Orange, Purple, Royal, Scarlet, White, USA, Victory Blue, Texas Orange, Cardinal, Vegas Gold



## Demarini Momentum 2.0 Wheeled Bag

#WB57117??



- Bat sleeves holds up to 4 bats
- Two interior shelves to separate players gloves or cleats from other gear
- Interior support bracket
- Side accessory pocket
- Interior L bracket to help prevent bag blowouts
- Inline wheels for smooth roll
- Two integrated fence hooks
- Removable decoration panel
- Dimensions: 36" L x 12" W x 12" H
- Available colors: Black, Navy, Royal, Purple, Victory Blue, Maroon, Orange, White, Light Gold, Scarlet, Dark Green

## Easton Dugout Wheeled Bag

#A159055??



- 38" L x 14" W x 13" H
- Durable construction
- 1-piece molded base allows bag to stand upright
- Long-Lasting YKK® zippers on main compartments
- Large mouth opening for easy access to main compartment
- Rugged inline wheels
- Personal side pocket
- Removable panel for embroidery
- Padded compartment w/ fence hooks
- Holds up to five bats
- Reinforced carry straps
- Available colors: Black, Navy, Royal, Scarlet



**EVOLUTION SOCCER GOAL**

- 1.1 Elliptical - #2B3306**
- 1.1 Elliptical SW - #2B3306SW**
- 2.1 Round - #2B3406**
- 2.1 Round SW - #2B3406SW**

- NCAA and NFHS approved
- Aluminum post and crossbar and includes the Kwik Lock® Net System around the entirety of the frame for added net security.
- Evolution 1.1 features a 4"x 5" elliptical post and crossbar
- Evolution 2.1 features a 4-3/8" round post and crossbar

**Includes:**

- 3mm, 120mm mesh, black/white net (3B2162)
- Net Support Strap (10B4406)
- Kwik Lock® Net Clips (10B31)
- 4 semi-permanent ground anchors (10B103)
- \*If you choose an **SW** model, you have chosen the Swivel Wheel option. Includes 4 removable swivel wheels with no-flat tires and 6 Saddle Anchor Bags (10B1605)



Elliptical



Round

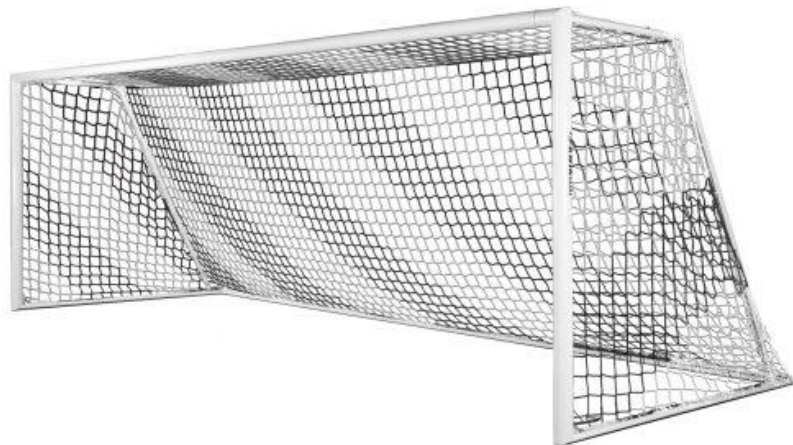



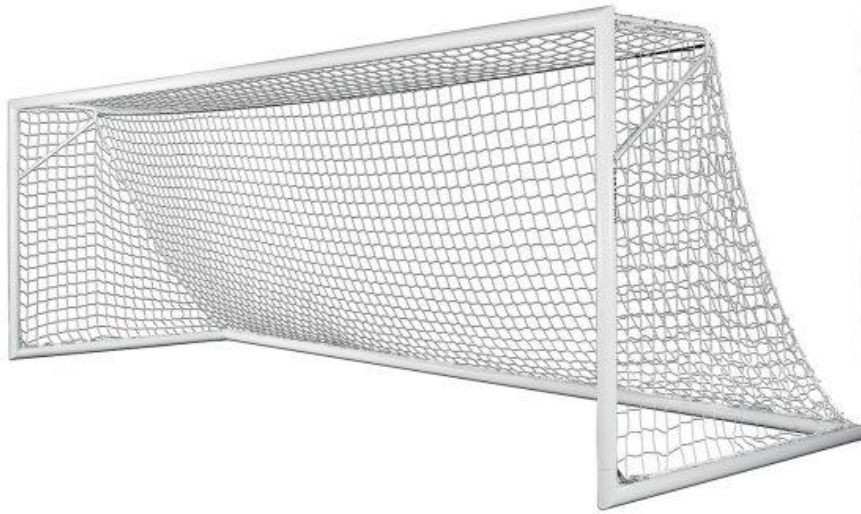

## FUSION® SOCCER GOAL

**8' x 24' SW (wheeled) - #2B3806SW**

**8' x 24' - #2B3806**

**7' x 21' - #2B3805**

**6.5' x 18.5' - #2B3804**

- NCAA and NFHS approved
- 4" round, aluminum frame
- White, powder-coated finish

### Includes:

2B3806 (8' x 24')

- 3mm, 3 1/2" mesh, white net (3B6826)
- Net Support Strap (10B4406)
- Kwik Lock® Net Clips (10B31)
- 4 semi-permanent ground anchors (10B103)

2B3804 (6.5' x 18.5')

- 3mm, 3 1/2" mesh, white net (3B6824)
- Kwik Lock® Net Clips
- Net Support Strap (10B4404)
- 4 semi-permanent ground anchors (10B103)

2B3805 (7' x 21')

- 3mm, 3 1/2" mesh, white net (3B6825)
- Kwik Lock® Net Clips
- Net Support Strap (10B4405)
- 4 semi-permanent ground anchors (10B103)



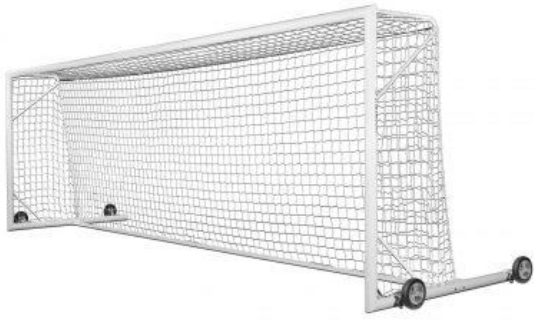

**FUSION® 120 SOCCER GOAL**

**8' x 24' #2B3906**

- NCAA and NFHS Approved
- Designed to fit perfectly in front of almost any set of football uprights
- 4" round, aluminum frame
- Professional, white powder-coated finish

**Includes:**

- 3mm, 120mm mesh, white net (3B5921)
- Net Support Strap (10B4406)
- Kwik Lock® Net Clips (10B31)
- 4 no-flat, flip-up tires (10B409)
- 4 semi-permanent ground anchors (10B103)
- 6 Saddle Anchor Bags (10B1605)

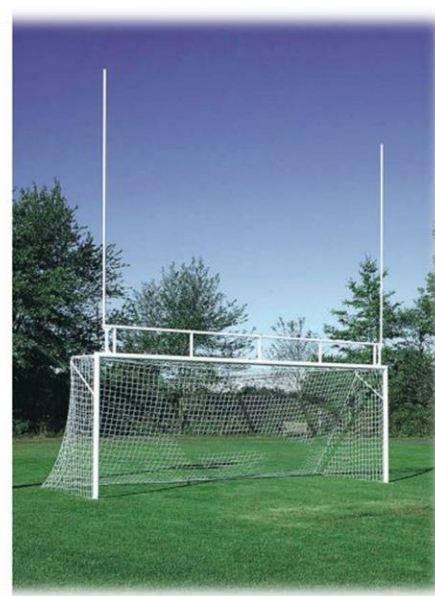

**COMBINATION FOOTBALL/SOCCER GOAL**

**8' x 24' #2D301**

The 2D301 Combination Football/Soccer Goal meets NFHS and USSF standards.

**Includes:**

- 3mm, 3 1/2" mesh, white net (3B6826)
- Kwik Lock® Net Clips (10B31)
- 2 ground sleeves with caps

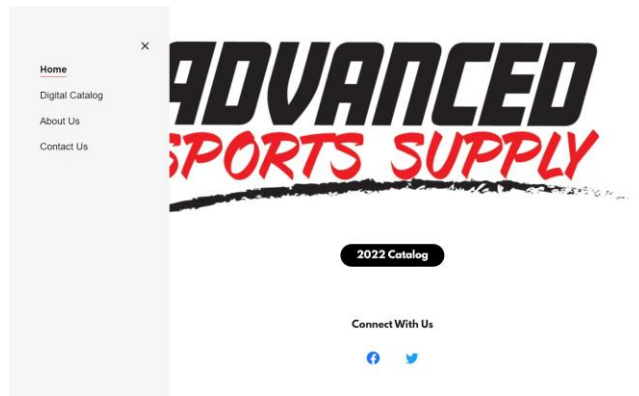

Check us out online at  
[advancedsportssupply.com](http://advancedsportssupply.com)  
 or call  
**812-556-2036!**



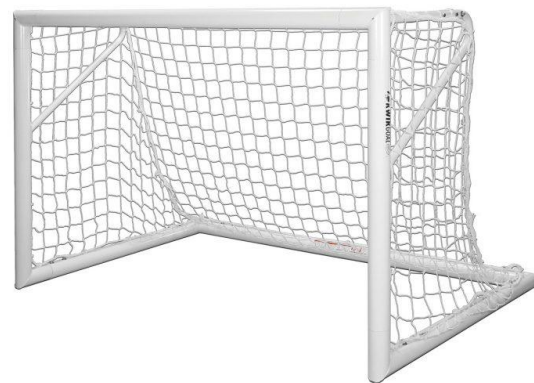
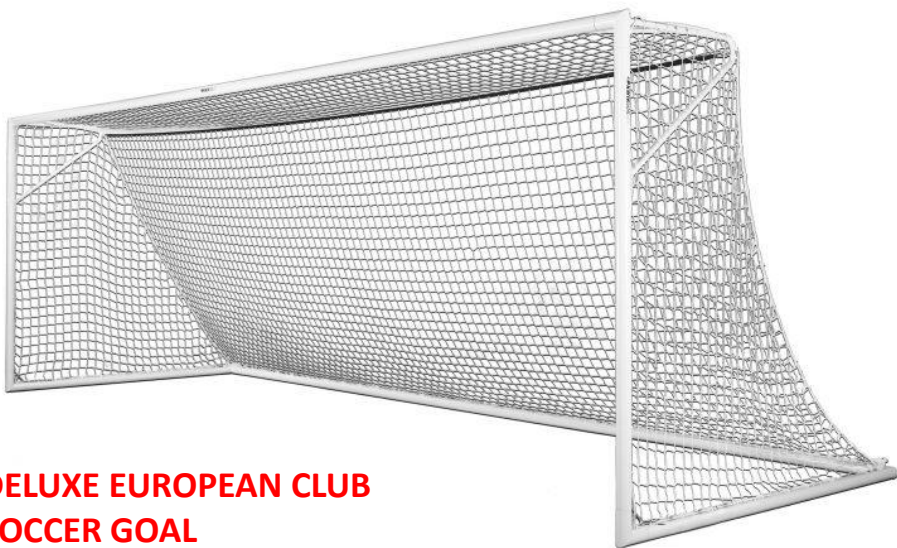

## DELUXE EUROPEAN CLUB SOCCER GOAL

8' x 24' - #2B3006

7' x 21' - #2B3005

6.5' x 18.5' - #2B3004

6.5' x 12' - #2B3003

4.5' x 9' - #2B3002

4' x 6' - #2B3001

- o NFHS approved
- o All-aluminum construction
- o European-style backstays give this goal an international look

### Includes:

- 3mm, 3 1/2" mesh, white net
- Net Support Strap
- Kwik Lock® Net Clips
- Anchors



## OFFICIAL FUTSAL GOAL

#2P201

The Official Futsal Goal meets both the international Futsal standards and ASTM Safety Standard F2950-14 – making it both a safe and ideal choice for futsal matches around the world. This Official Futsal Goal features an all-surface friendly design and a 3.15" x 3.15" square, all-aluminum frame with the unique Kwik Lock net system. This futsal goal is 6'7"H x 9'10"W.

### Includes:

- 4mm, 120mm mesh, white net (3B5001)
- Kwik Lock® Net Clips (10B31)
- Protective floor pads (10B601)
- 4 Saddle Anchor Bags (10B1605)
- 4 semi-permanent ground anchors (10B103)





**SADDLE ANCHOR BAG**

**#10B1605**

- Stainless steel clasp and “D” ring
- Used for portable indoor/outdoor installation
- Straddles bottom bar for clean, secure fit
- Bag top openings allow for continuous net attachment
- Plastic center strip for additional support
- Reinforced stitching and zipper
- Fill with up to 40 lbs. of sand
- Sand not included

**BEST SELLER\***  
**ADVANCED**  
**SPORTS SUPPLY**  
**\*BEST SELLER\***



**GROUND ANCHORS**

**#10B103**

- Zinc-plated, steel anchors
- Stainless steel hardware
- Semi-permanent, outdoor installation
- 1 set of 4 anchors secures one goal



**EURO MATCH/FUSION® GOAL WHEEL OPTION**

**#10B409**

- Rotating wheel bracket
- No-flat tires
- 1 set of wheels per 1 goal
- Fits Pro Premier®, European Match and Fusion® Goals



**KWIK LOCK® NET CLIPS (100 pack)**

**White - #10B3101**

**Black - #10B3106**

**Blue - #10B3104**

**Red - #10B3112**

- Fits goals with Kwik Lock® and Evolution Net Systems
- 100 clips attach 1 net to an 8' x 24' goal



**HEAVY DUTY ANCHOR BAG**

**#10B7011**

- PVC coated polyester bladder
- Used for portable indoor/outdoor installation
- Rigid plastic handle for easy carrying
- Openings in handle area offer continuous net attachment
- Fill with up to 40 lbs. of sand
- Sand not included

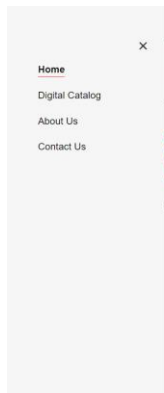

2022 Catalog

Connect With Us



**Check us out online at [advancedsportssupply.com](http://advancedsportssupply.com) or call 812-556-2036!**

# GOAL NETS

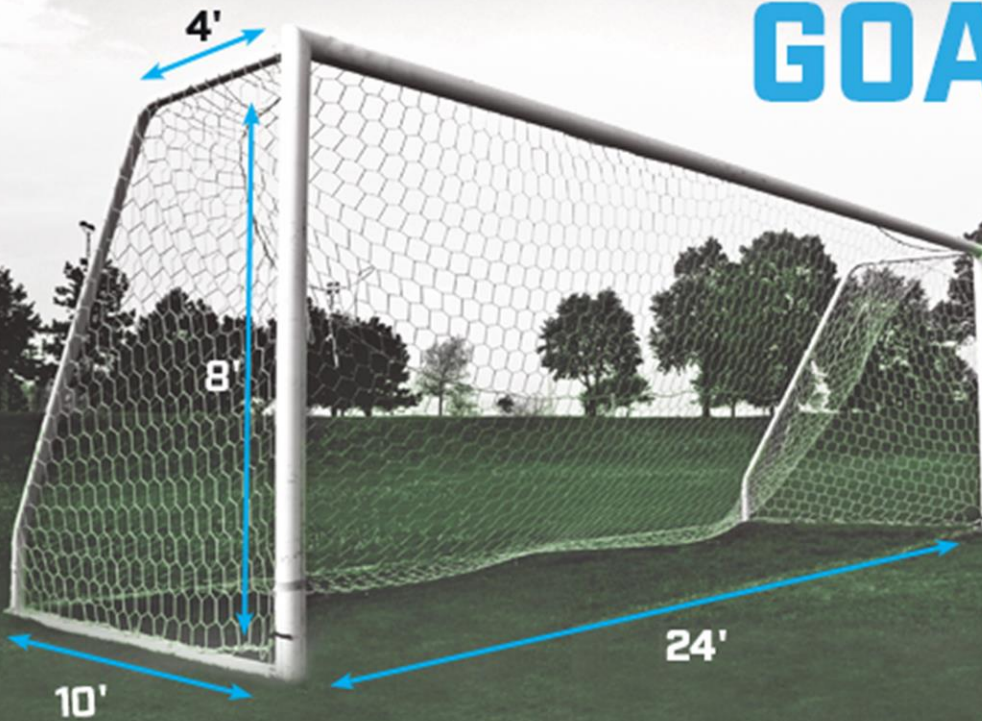

## BRAIDED SOCCER GOAL NET 4.0MM

BLUE - #NS1-BLUE

ORANGE - #NS1

RED - #NS1-RED

YELLOW - #NS1-Y

- 4mm braided polyethylene net
- Salvaged border
- 24' wide, 8' tall, 10' deep



## TWISTED SOCCER GOAL NET 3.0MM

BLUE - #NS3T-BLUE

ORANGE - #NS3T-O

RED - #NS3T-RED

YELLOW - #NS3T-Y

WHITE - #NS3T-W

- 3mm twisted polyethylene net
- 5" mesh
- 24' wide, 8' tall, 10' deep
- Overlocked border finish



## BRAIDED SOCCER GOAL NET 4.0MM HEXAGON PATTERN (WHITE ONLY)

#NS2

- 4mm braided polyester hexagonal pattern
- Braided, knotless construction
- 24' wide, 8' tall, 10' deep
- Overlocked border finish



ITEM#	SIZE	THICKNESS	COLOR	MESH
3B2162	8' X 24' X 3' X 8.5'	3MM	BLACK/WHITE STRIPED	120MM
3B5001	6'7" X 9'10" X 2'8" X 3'4"	3MM	WHITE	4"
3B5301	4' X 6' X 2' X 4'	3MM	WHITE	120MM
3B5501	4.5' X 9' X 2' X 5'	3MM	WHITE	120MM
3B5721	6.5' X 18.5' X 2' X 6'	3MM	WHITE	120MM
3B5921	8' X 24' X 3' X 5'	3MM	WHITE	120MM
3B6823	6.5' X 12' X 2' X 7.5'	3MM	WHITE	3.5"
3B6824	6.5' X 18.5' X 2' X 6.5'	3MM	WHITE	3.5"
3B6825	7' X 21' X 3' X 8'	3MM	WHITE	3.5"
3B6826	8' X 24' X 3' X 9'	3MM	WHITE	3.5"
3B7226	8' X 24' X 0' X 8'	2.4MM	WHITE	120MM

More sizes available!  
 Call us today 812-556-2036!

**ADVANCED**  
**SPORTS SUPPLY**

**OFFICIAL CORNER FLAG  
(SET OF 4)**

**#A199**

- Steel peg for easy ground insertion
- 1" Diameter pole
- 60" height
- Set of 4



**REPLACEMENT FLAGS (SET OF 4)**

**#A197RSE**

- Flags only



**DELUXE OFFICIAL CORNER FLAG (SET OF 4)**

**#A197**

- Steel peg base with spring
- 1" Diameter pole
- 60" height
- Set of 4

**CORNER FLAGS WITH RUBBER BASES**

**½" Pole w/ Spring - #A193RB**

**1" Pole - #A197RB**

- 60" height
- Weight of base is 2.5lbs
- Black, high-density, durable rubber base
- Ideal for turf
- Indoor/outdoor use





CLUB SHELTER  
**COVER OPTIONS**

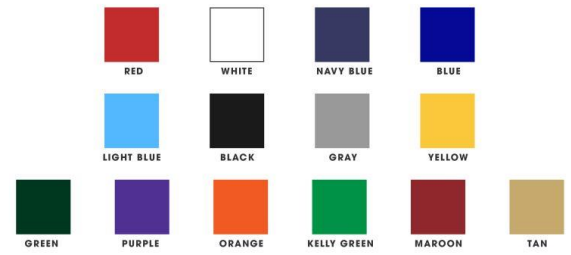

**CLUB SHELTER**

**15' - #9B6305**

**24' - #9B6308**

The Club Shelter is the perfect seating solution for clubs and schools. With swivel wheels permanently mounted to its frame, this shelter was designed with effortless portability in mind. The vinyl-coated polyester cover is attached to the front of the frame with uniquely designed clips, while the base and sides are attached to the frame with bungees to ensure a proper fit. Choose from a variety of available stock colors or select a specific RAL color to match your Club Shelter's frame to your organization's color scheme. The vinyl-coated polyester cover is available in stock gray, with an additional 13 colors available upon request. Note: seating products are not included

Windows can be added as an additional feature for our Club Shelter to increase airflow and keep the heat down during the hot summer months, if you need to shut the vented panel simply roll down the cover and keep your team safe from the elements outside.

Customization is available not only on the panel cover but on the vented panel as well to create 8 total areas to add your team's logo or branding.



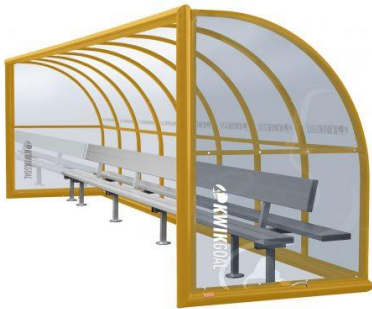

## CUSTOM SHELTER

#9B5

Custom shelters from Kwik Goal offer a wide range of options to fit your team and club needs.

Rows options – 1 row, 2 rows

Size options – 30', 24', 21', 18', 15', 12', 9'

Seating options – Bench, Molded Seats, Luxury Seating

Color options – Yellow, Black, Blue, Green, Red, White

Call us today to discuss  
your custom shelter needs!  
812-556-2036



**PLAYER BENCHES**

**WITH BACK**

**21' - #9B25**

**15' - #9B22**

**6' - #9B21**

**WITHOUT BACK**

**21' - #9B26**

**15' - #9B24**

**6' - #9B23**

- All Aluminum
- Planks clear anodized; Frames and braces mill finish

**6 SEAT KWIK BENCH**

**BLUE - #9B9064**

**BLACK - #9B906**

**RED - #9B9061**

From tournaments to training sessions, the 6-Seat Kwik Bench is an absolute necessity for on-the-go seating. It features connected, nylon seats and a sturdy, collapsible steel frame. For extremely easy transportation and storage, the 6-Seat Kwik Bench includes a rugged, woven-fabric carry bag. This bench is available in red, blue and black.



**PORTABLE SHOE DRYER**

**#30B0801**

- Antibacterial UV light
- Compact design travels easily
- UL plug for typical 120V/60Hz household outlet



**SHOE DRYER**

**#30B0901**

- Cord length: 63"
- Odor fighting ozone setting
- Control pane with LCD display and timer
- UL plug for typical 120V/60Hz household outlet (100 W)
- Includes unit base and 2 each vent tubes



**COACH'S SEAT**

**#9B901**

- Collapsible, steel frame
- Single-seat
- Lightweight
- Portable
- Durable, woven-fabric seat
- Carry bag included



**INFINITY POP-UP GOAL**

**Non-weighted, Round, 6' BLUE - #2B71L**

**Non-weighted, Round, 4' RED - #2B71M**

**Non-weighted, Square, 4' RED - #2B7304**

**Weighted, Square, 4' RED - #2B7404P**

With the simple action of crossing and uncrossing your arms, the Infinity Pop-up Soccer Goals can be ready for play or get packed away. Infinity goals are ideal for small-sided training or simple backyard play. These goals includes a Polyester travel bag, Nylon pegs (for anchoring on grass surfaces), Elastic anchor tethers and Velcro fasteners (to hold goal in folded position).

**Includes:**

- Polyester carry bag
- Elastic anchor tethers
- Nylon pegs (10B1301)
- Velcro fasteners to hold in folded position



**KWIK FLEX™ LITE GOALS**

**6.5' x 12' - #2B1505**

**4' x 6' - #2B1503**

**3' x 5' - #2B1502**

The KWIK FLEX™ Lite line includes 4 different sizes. The goals are constructed with a fiberglass and metal material, making them durable yet lightweight. No tools are needed for set up or teardown. This line features similar higher-quality as our regular KWIK FLEX™ goals but offers a more budget-friendly option for coaches and players.



**FOLDING MAGNETIC BOARD**

**18" x 24" - #18B502**

**24" x 36" - #18B503**

- carry bag
- 2 markers
- Eraser
- 27 magnets



**SOCCER MAGNETIC CLIPBOARD**

**#MB-2**

- Player magnets
- Training Session Planner
- Vinyl magnetic folder



**SOCCER CLIPBOARD**

**#18B301**

- Includes a Dry Erase Pen



### AURORA THERMAL BONDED SOCCER BALL "1800"

Size 4 OPTIC BLUE - #SB1804OB

Size 5 OPTIC BLUE - #SB1805OB

Size 4 OPTIC ORANGE - #SB1804

Size 5 OPTIC ORANGE - #SB1805



- Ideal for high school and college games
- Thermal-bonded PU cover
- 3.00mm TPE backing
- Nylon and polyester winding
- Butyl bladder
- Size 5 is NFHS approved



### BRINE PHANTOM X SOCCER BALL

Size 5 BLACK - #1397721B

Size 5 ROYAL BLUE - #1397721RB

Size 5 RED - #1397721R

- High retention latex bladder system
- Ultra abrasion-resistant PU cover with texture
- Hand-stitched
- NFHS approved



BRINE



### WILSON NCAA VIVIDO SOCCER BALL

Size 5 WHITE - #WS1000901XB05

Size 5 OPTIC YELLOW - #WS1000902XB05

- 20-unique panel design
- Micro-texture surface
- Performance hybrid material
- Visual spin technology
- NFHS, NCAA, and FIFA approved



### 3STAR INDOOR BALL

Size 4 - #3STAR4

Size 5 - #3STAR5

- Custom hand-stitched suede cover for exceptional softness during game play
- 2-Ply butyl bladder for exceptional air retention and durability during regular use in indoor and outdoor conditions
- 32 hand-sewn panels for added quality and durability
- Indoor official size and weight
- Yellow/Black



### FUTSAL BALL

#SBF

- Machine stitched TPU cover with EVA backing for soft feel without sacrificing weight
- Butyl bladder for added air retention
- Size: 62cm circumference
- Ideal for Futsal match play or training





### WILSON GST LEATHER



Official Size TAN - #3F1003

Official Size RED- #1167931

Official Size TAN, BLEM - #1167939

- GST is the softest leather football on the market, with a unique feel and distinct light brown color. The ball is also easier to control thanks to a high level of tack.
- Patented sewn-on stripes are composite material instead of paint and provides 82% more grip to aid release for more accurate throws.
- Official size is NFHS Approved



Wilson

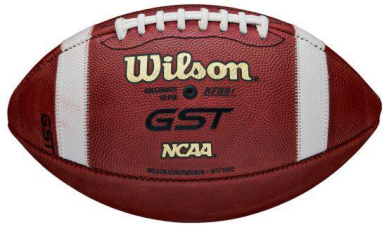

### NIKE VAPOR ONE 2.0

Official Size - #1454495

Youth, 12-14 - #1454496

Junior, 9-12 - #1454497

- Custom crafted premium tacky leather
- Innovative stitched-in TEXTURED half-strip
- Official Size is NFHS approved



### SPALDING ALPHA

Official Size - #WC726758

Youth, 12-14 - #WC726748

- Horween® "S" tack leather cover with two-ply TPU bladder
- Boxed sewn strip and raised diamond lace
- Official size is NFHS approved

### WILSON GST PRIME



Official Size - #WLWTF1103IB

- Extra grip-point stitching for more accurate passing
- Sewn-on stripe and composite pebbled laces for added control
- Prep gauge signifies when ball is fully broken-in for game play
- NFHS and NCAA approved



Other models are available!  
We can get what you need!

Wilson

FOOTBALL



## 1" HEAVY RUBBER KICKOFF TEE

#A100S

- 1" heavy rubber kickoff tee
- Made with high-visibility orange PVC
- Non-slip texture on top of tee provides ball grip
- Injection molded construction for use in all conditions

## HEAVY BLACK FIELD GOAL TEE

1" - #A101S

2" - #A101

- Durable ridges on bottom of tee prevent slippage
- Waffle texture on top of tee provides ball grip
- Injection molded construction for use in all conditions



## FOOTBALL KICKING HOLDER

#FHK

- Allows players to practice kicking like the pros on their own time
- Heavy-duty enameled steel base can stand up to regular use both indoors and outdoors
- Flexible rubber tube holds the tip of the ball in the desired position



## GROUND ZERO® KICKOFF TEE

1" - #GZ1

2" - #GZ2

- Authentic Ground Zero® kickoff tee
- Most popular tee in college football and professional play
- Textured top surface grips ball securely
- Forward rectangular recess holds the ball in ideal angle for kicking
- Black
- Ball not included

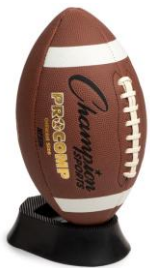

## PRO DOWN VARSITY KICKING CAGE

Complete Unit - #1052480

Replacement Net - #1052473

Carry Bag - #1363685

- 1.5 in., 17-gauge, galvanized steel frame offers a heavy-duty design that withstands kick after kick
- Kicking cage captures punts and kicks for players to warm up with on the sidelines during a game or during practice
- Bright yellow sides resemble field goal posts for heightened and familiar visual reference
- Measures 41 in. x 41 in. x 82 in. for a compact footprint on the edge of the playing field
- Can be assembled and disassembled easily for storage and portability



## PRO DOWN RUNNING ROPES

Complete Unit - #1201987

Replacement Grid - #1201994

- 17-gauge powder-coated tubular steel frame withstands heavy use
- Bright yellow grid makes it easy to identify where feet should be placed
- Frame doesn't obstruct movement across the path
- Grid adjusts from 6 in. up to 15 in. tall to meet the varying needs of training athletes
- Nylon netting offers a 14 ft. 10 in. x 3 ft. 3 in. grid for stepping



## VARSITY LINEMAN CHUTE

#FBVCHUTE

- Heavy-duty steel construction provides teams with reliable practice equipment
- Used to position linemen into the proper form for drive blocks
- Framework encourages athletes to stay low, elevate their hips and find their balance as they move forward
- Equipped for additional chutes for a multi-player lineup



## SNAPPER STICK

#1299939

- Lightweight, durable aluminum pole enables easy maneuvering
- Special teams coaches can stand rather than kneel for a clear view and reduced back strain
- Sturdy foam football is bright yellow for enhanced visibility
- Telescoping design extends from 30 - 60 in. to allow the coach to stand in different positions
- Trains offensive linemen to react quickly to the snap

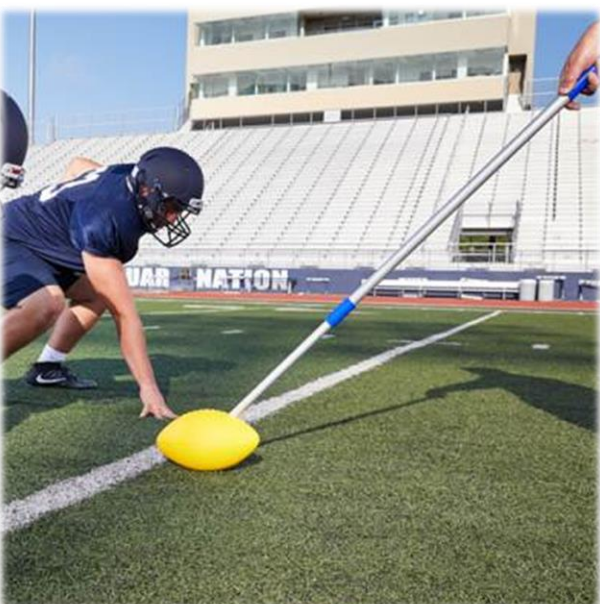



### PRO DOWN COLLEGIATE SHIELD

#200232812

- 2 reinforced handles
- 16"W x 26"L - 4 lbs.
- BLACK



### PRO DOWN SQUARE BLOCKING DUMMY

#200235012

- 2 reinforced handles
- 14"W x 50"L - 15 lbs.
- BLACK



### PRO DOWN MAN SHIELD

Royal - #1384302

Black - #1384303

- 4 reinforced handles
- 22"W x 26"L - 5 lbs.



### PRO DOWN FOREARM SHIVER PADS

#200232412

- 24"W x 11"L x 3"T
- BLACK



### PRO DOWN STEP-OVER DUMMY

17"B X 8"H X 51"L, 10lbs - #200230812

17"B X 12"H X 51"L, 20lbs - #200231212

- BLACK



Other shapes, styles, and models are available! We can get what you need! Call us at 812-556-2036!

# ADVANCED SPORTS SUPPLY



## PRO DOWN VARSITY M-SERIES BLOCKING SLED

2-Man - #1378632

3-Man - #1378633

4-Man - #1378634

5-Man - #1378635

6-Man - #1378636

7-Man - #1378637

Optional Coach Platform - #1362618

- All steel powder coated frame construction
- Modular frame construction allows for convenient expansion or removal of a man when needed
- Features 52" splits
- Super-Duty flat leaf springs absorb initial shock and recoils with equal force
- Round tubular steel "all surface" skids
- Optional Coaches Platform available
- Comes stock with royal blue pads



## PRO DOWN VARSITY M-SERIES 1-MAN SLED

#1271522

- Powdercoat steel frame is durable enough to withstand outdoor use and hits from large players
- Designed to help offensive and defensive football players in physical leagues and programs practice one-on-one blocks
- Super-duty flat-leaf spring mimics real game situations by absorbing the recoil from player blocks and using it to put resistant pressure on the blocker
- Vinyl pads provide a safe and protective surface for players to practice making hits and blocks on life-size opponents
- Tubular steel skids can move on nearly any type of field or turf surface
- Comes stock with royal blue pads





## PRO DOWN PYLONS

### #MSWPYLON

- Safe foam filler softens potential impacts when players are reaching for the goal line
- Weighted bottom pylons allows the pylons to stand on their own without the need for anchors
- Fluorescent orange color ensures the end zone can be easily seen from the field, sidelines and stands
- Each pylon measures 18 in. high for added visibility on the gridiron
- Includes 4 pylons to mark one end zone



## SOLID WEIGHTED YARD MARKERS

### #A102S

- 13" x 13" vinyl covered construction with weighted bottom
- Fluorescent orange marker with 10" black numbers on each side
- Sewn-in nylon handles on top for easy portability
- Set includes two of each "G" (Goal) through "40" and one "50"



## NON-WEIGHTED YARD MARKERS

### #A102

- 13" x 13" PVC covered foam construction, self-supporting markers
- Orange marker with black numbers on each side
- Set includes two of each "G" (Goal) through "40" and one "50"



## DELUXE DOWN INDICATOR AND CHAINS

Down Indicator and Bullseye Chain Set - #A103

Bullseye Chain Set - #A103B  
Down Indicator - #A103A



## DIGITAL DOWN INDICATOR

### #A103D

- One button adjusts LED numbers
- Double sided LED digital number display height 14"
- Pole height: 7'5"
- Weight: Under 8lbs
- 10+ hour rechargeable 800mAh polymer lithium battery with battery power light indicator(charging cord included)



# LIGHT™ HELMETS



PLAYERS RELY ON THE LS2 BECAUSE IT ALLOWS THEM TO MOVE FASTER AND MORE EFFICIENTLY ON THE FIELD. TRADITIONAL FOOTBALL HELMETS CAN WEIGH UP TO 6 POUNDS, BUT AT JUST 3 POUNDS, THE LS2 MAKES IT EASIER TO MAINTAIN SITUATIONAL AWARENESS AND TRACK THE BALL AND OTHER PLAYERS ON THE FIELD.

THE LS2'S ULTRA STRONG & LIGHT OUTER-SHELL IS FORGED FROM THE SAME TRI-WEAVE COMPOSITE MATERIAL USED BY THE U.S. MILITARY. ITS LIGHTWEIGHT COMPOSITE CONSTRUCTION IS HALF THE WEIGHT OF OTHER HELMETS, WHICH REDUCES THE MASS CARRIED ON THE HEAD AND NECK AND MINIMIZES PLAYER FATIGUE.

BORROWED FROM AEROSPACE TECHNOLOGY ORIGINALLY LICENSED BY NASA, OUR ARMOR FOAM INNER-LINING IS ENGINEERED TO ABSORB IMPACT, RATHER THAN SIMPLY REDIRECTING IT. UNLIKE OTHER HELMETS THAT USE FOAM CUBES, THE INTERIOR OF THE LS2 IS 100% COVERED, MEANING ENERGY CAN DISSIPATE SAFELY & EFFICIENTLY OVER THE ENTIRE LINING OF THE HELMET.

## **LIGHT FOOTBALL COMPOSITE HELMET**

**VARSITY COMPOSITE - #LS2-CV**

**YOUTH COMPOSITE - #LS2-CY**

- COMPOSITE SHELL
- ADVANCED MILITARY MATERIALS
- ULTRA-STRONG
- LIGHTWEIGHT
- ARMOR FOAM TECHNOLOGY
- 100% LINED INTERIOR
- ABSORBS IMPACT

## **LIGHT FOOTBALL POLYCARBONATE HELMET**

**YOUTH POLYCARBONATE - #LS2-PY**

- POLYCARBONATE SHELL
- ADVANCED MILITARY MATERIALS
- ULTRA-STRONG
- LIGHTWEIGHT
- ARMOR FOAM TECHNOLOGY
- 100% LINED INTERIOR
- ABSORBS IMPACT

## LIGHT FOOTBALL FACEMASKS

- Lightweight
- Chrome-Moly Steel Tubing Facemask

#SKP1



#P1



#SK1



**LIGHT**<sup>™</sup>  
H E L M E T S



**VICTORY, T-REX HURRICANE CHIN STRAP**

#VICTORY CHINSTRAP



**X1, T-REX HURRICANE CHIN STRAP**

#X1 CHINSTRAP

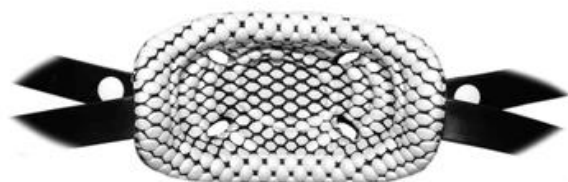

CALL US for more details!  
We can get what you need!

**ADVANCED**  
**SPORTS SUPPLY**

## RAZOR RZ7 (SKILL) SHOULDER PADS

#1388367



- Injection Molded Components
- SAS-TEC Impact Zone Protection
- Dynamic R.O.M. Arch Hinge
- Adjustable Protective Channel Pads
- Sternum/Spine Protective Pads
- Moisture Wicking Fabrics
- PAD-LOC Buckle/Strap System
- Compressed HEX Foam Comfort Liner
- Patented Z-Cool (#7,168,104) Plastic Inner Arch Design

SIZE	SM	MED	L	XL	2XL
SHOULDER	16"-17"	17"-18"	18"-19"	19"-20"	20"-21"
CHEST	36"-38"	38"-40"	40"-42"	42"-44"	44"-46"

## RAZOR RZ15 (MULTI POSITION) SHOULDER PADS

#1388373



- Injection Molded Components
- SAS-TEC Impact Zone Protection
- Dynamic R.O.M. Arch Hinge
- Adjustable Protective Channel Pads
- Sternum/Spine Protective Pads
- Moisture Wicking Fabrics
- PAD-LOC Buckle/Strap System
- Compressed HEX Foam Comfort Liner
- Patented Z-Cool (#7,168,104) Plastic Inner Arch Design

SIZE	SM	MED	L	XL	2XL
SHOULDER	16"-17"	17"-18"	18"-19"	19"-20"	20"-21"
CHEST	36"-38"	38"-40"	40"-42"	42"-44"	44"-46"

## RAZOR RZ55 (OL/DL) SHOULDER PADS

#1388380



- Injection Molded Components
- SAS-TEC Impact Zone Protection
- Dynamic R.O.M. Arch Hinge
- Adjustable Protective Channel Pads
- Sternum/Spine Protective Pads
- Moisture Wicking Fabrics
- PAD-LOC Buckle/Strap System
- Compressed HEX Foam Comfort Liner
- Patented Z-Cool (#7,168,104) Plastic Inner Arch Design

SIZE	MED	L	XL	2XL	3XL
SHOULDER	17"-18"	18"-19"	19"-20"	20"-21"	21"-22"
CHEST	38"-40"	40"-42"	42"-44"	44"-46"	44"-48"

### X3 ADULT X7 (SKILL) SHOULDER PADS

#1454175



- Light weight low profile flat pad design for greater mobility
- Built-in back plate
- Recommended for QB/WR/DB or similar Skill positions requiring greater mobility
- Antimicrobial arch fabric
- Compressed Hex Foam delivers first in class moisture management and superior protection
- Vent holes throughout arch offers increased air flow
- Full 180-degree arms up motion
- Integrated Deltoid Pad and fixed cap pad
- Rigid plastic sternum protection
- 1.5" biothane belt with no-snap buckles

SIZE	SM	MED	L	XL
SHOULDER	16"-17"	17"-18"	18"-19"	19"-20"
CHEST	36"-38"	38"-40"	40"-42"	42"-44"

### X3 ADULT X15 (MULTI POSITION) SHOULDER PADS

#1454181



- Flat pad design provides optimum combination of protection and mobility for multiple positions
- Short front arch for extended range of motion and extended rear arch for added protection
- Multi-Position pad recommended for RB/DB/TE/DE requiring mobility and added protection
- Antimicrobial arch fabric
- Vent holes throughout arch offers increased air flow
- Full 180-degree arms up motion
- Integrated Deltoid Pad and fixed cap pad
- Rigid plastic sternum protection
- 1.5" biothane belt with no-snap buckles
- Secondary 1.5" elastic belt for more secure fit

SIZE	SM	MED	L	XL	2XL
SHOULDER	16"-17"	17"-18"	18"-19"	19"-20"	20"-21"
CHEST	36"-38"	38"-40"	40"-42"	42"-44"	44"-46"

### X3 ADULT X55 (OL/DL) SHOULDER PADS

#1454187



- 1.5" biothane belt with no-snap buckles
- Secondary 1.5" elastic belt for more secure fit
- Antimicrobial arch fabric Vent holes throughout arch offers increased air flow
- Full 180-degree arms up motion
- Integrated Deltoid Pad and fixed cap pad
- Rigid plastic sternum protection
- specially designed for larger players such as OL/DL/DE/TE positions

SIZE	MED	L	XL	2XL	3XL
SHOULDER	17"-18"	18"-19"	19"-20"	20"-21"	21"-22"
CHEST	38"-40"	40"-42"	42"-44"	44"-46"	44"-48"

## JV/YOUTH Z-COOL 2.0 SHOULDER PAD

#1454455

- Extremely light weight all position pad
- Z-Cool moisture transfer system and plastic inner arch design
- NEW cosmetic Carbon Fiber updates on external poly components
- Adjustable clavicle pads
- Fixed cap pad system
- AC joint notch-out with AC cradle pads
- Adjustable deltoid pad system
- Rigid plastic sternum protection
- 1.5" belt with no-snap buckles

SIZE	XSM	SM	MED	L	XL	2XL	3XL
SHOULDER	12"-13"	13"-14"	14"-15"	15"-16"	16"-17"	17"-18"	18"-19"
WEIGHT	30-45lbs	40-60lbs	60-80lbs	75-100lbs	95-120lbs	115-140lbs	135-160lbs

## JV/YOUTH X3 SHOULDER PAD

#1454463

- For Youth, Middle School or JV
- Perforated arch foam system allows for quick drying
- Low profile flat pad construction with vented arch plastic
- Rigid plastic sternum protection
- AC joint notch-out with cradle pads
- 1.25" Belts with non-cut buckles

SIZE	XSM	SM	MED	L	XL	2XL	3XL
SHOULDER	12"-13"	13"-14"	14"-15"	15"-16"	16"-17"	17"-18"	18"-19"
WEIGHT	30-45lbs	40-60lbs	60-80lbs	75-100lbs	95-120lbs	115-140lbs	135-160lbs

## 4 STACK SHOULDER PAD RACK

#1378670

- Base with rectangular channel design increases strength and stability
- 4 heavy duty swivel casters for easy movement
- Holds up to 60-80 pads (Depending on pad size)
- Assembled Dimensions - 68"H x 24"W x 60"L
- Weight - 65 lbs.

**ADVANCED**  
**SPORTS SUPPLY**



## 5-STAR RATED SH7 SOFT SHELL HELMET

**Small - #SSH2BS**

**Medium - #SSH2BM**

**Large - #SSH2BL**

- Light, breathable headgear for 7 on 7 or other non-tackle football, lined with Champro's exclusive PRS Foam System
- 5 Star rated "Best Available" in Virginia Tech flag football headgear ratings
- Bio-Fresh® anti-microbial treatment guards against deterioration from mold, mildew stains, and bacterial odors
- Sides of helmet have space to print team logos



## 7-SERIES SOFT SHELL HEADGEAR

**Small - #SSHS**

**Medium - #SSHM**

**Large - #SSHL**

- Lightest, most breathable 7 on 7 helmet on the market!
- Inner lining with Bio-Fresh® antimicrobial & DRI-GEAR® moisture wicking treatment
- Venthholes added in key areas for breathability
- Lace closure system ensures a secure fit
- Sides of helmet left blank for decoration

Size	Hat Size	Head Circumference
<b>S</b>	6 - 6 1/2	19 - 20 1/2
<b>M</b>	6 5/8 - 7 1/4	20 7/8 - 22 3/4
<b>L</b>	7 3/8 - 7 3/4	23 1/8 - 24 1/4

## 7-SERIES SHOULDER PAD

**2XSmall - #FSP7040**

**XSmall - #FSP7060**

**Small - #FSP7080**

**Medium - #FSP7100**

**Large - #FSP7130**

**XLarge - #FSP7150**

**2XLarge - #FSP7180**

**3XLarge - #FSP7200**

- Made with lightweight, impact-reducing EVA foam
- Breathable mesh inner lining
- Perforated shoulder caps provide upper arm protection
- Premium neck collar provides comfort
- Side and under arm straps keep pad locked for a secure fit

Size	Weight	Chest Size
<b>XXS</b>	Under 40 lbs.	22"-24"
<b>XS</b>	40-60 lbs.	24"-26"
<b>S</b>	60-90 lbs.	26"-28"
<b>M</b>	80-110 lbs.	28"-30"
<b>L</b>	130-150 lbs.	32"-34"
<b>XL</b>	130-150 lbs.	32"-34"
<b>2XL</b>	150-180 lbs.	34"-36"
<b>3XL</b>	180-200 lbs.	36"-38"

## LIGHT HELMET SOFT SHELL HEADGEAR

**#SS1**

- Armor Foam technology absorbs impact rather than simply redirecting it
- #1 impact score, Five Star Rating, and Best in class coverage (100% flag football / 96% Soccer) per Virginia Tech
- Vented design keeps players cool
- Closed-cell foam repels dirt, water and sweat
- Comfortable & adjustable fit
- Multi-sport applications: flag football, soccer, 7v7 passing football, no-contact practices, women's lacrosse, women's field hockey and more
- Free mesh drawstring carrying case included with every order







### TRI-FLEX COMPRESSION SHIRT WITH CUSHION SYSTEM - WHITE(W), CHARCOAL(B)

- Youth Small - #FJU6Y?S
- Youth Medium - #FJU6Y?M
- Youth Large - #FJU6Y?L
- Small - #FJU6?S
- Medium - #FJU6?M
- Large - #FJU6?L
- XLarge - #FJU6?XL
- 2XLarge - #FJU6?2X
- 3XLarge - #FJU6?3X
- 4XLarge - #FJU6?4X

- The TRI-FLEX cushion system provides the ultimate combination of protection and flexibility
- Grip-Tech dots gives shoulder pads traction and prevents slippage
- High-compression, Polyester/Spandex DRI-GEAR® moisture management fabric



### BULL RUSH COMPRESSION SHIRT - WHITE(W), CHARCOAL(GR)

- Youth Small - #FJU10Y?S
- Youth Medium - #FJU10Y?M
- Youth Large - #FJU10Y?L
- Small - #FJU10A?S
- Medium - #FJU10A?M
- Large - #FJU10A?L
- XLarge - #FJU10A?XL
- 2XLarge - #FJU10A?2X
- 3XLarge - #FJU10A?3X
- 4XLarge - #FJU10A?4X

- Poly/spandex, 4-way stretch fabric with high-compression fit
- Low-profile integrated pads provide maximum protection to the rib and shoulders
- Featuring DRI-GEAR® technology
- Tank top cut allows for full range of motion



### FORMATION PADDED COMPRESSION SHIRT

- Youth Small - #FJU18YWS
- Youth Medium - #FJU18YWM
- Youth Large - #FJU18YWL
- Small - #FJU18AWS
- Medium - #FJU18AWM
- Large - #FJU18AWL
- XLarge - #FJU18AWXL
- 2XLarge - #FJU18AW2X
- 3XLarge - #FJU18AW3X
- 4XLarge - #FJU18AW4X

- Poly/spandex, 4-way stretch fabric with high-compression fit
- Integrated pads with perforated holes provide maximum protection and breathability
- Tank top cut allows for full range of motion

## ADULT APPAREL

	CHEST SIZE	WAIST SIZE
XS	32	26
SMALL	34-36	28-30
MEDIUM	38-40	32-34
LARGE	42-44	36-38
XL	46-48	40-42
2L	50-52	44-46
3XL	54-56	48-50
4XL	58-60	52-54

## YOUTH APPAREL

	CHEST SIZE	WAIST SIZE
XXS	22-24	19-21
XS	24-26	21-23
SMALL	26-28	23-25
MEDIUM	28-30	25-27
LARGE	30-32	27-29
XL	32-34	29-31
2XL	34-36	31-33



### BULL RUSH 5-PAD GIRDLE - WHITE(W), CHARCOAL(GR)

- Youth Small - #FPGU10Y?S
- Youth Medium - #FPGU10Y?M
- Youth Large - # FPGU10Y?L
- Youth XLarge - # FPGU10Y?XL
- Small - # FPGU10A?S
- Medium - # FPGU10A?M
- Large - # FPGU10A?L
- XLarge - # FPGU10A?XL
- 2XLarge - # FPGU10A?2X
- 3XLarge - # FPGU10A?3X
- 4XLarge - # FPGU10A?4X

- Poly/spandex, 4-way stretch fabric with high-compression fit
- Low-profile integrated pads are flexible and ridged to provide maximum protection to the hips, thighs and knees
- DRI-GEAR® technology
- Girdle includes cup pocket



### BULL RUSH 7-PAD GIRDLE - WHITE(W), CHARCOAL(GR)

- Youth Small - #FPGU17Y?S
- Youth Medium - #FPGU17Y?M
- Youth Large - # FPGU17Y?L
- Youth XLarge - # FPGU17Y?XL
- Small - # FPGU17A?S
- Medium - # FPGU17A?M
- Large - # FPGU17A?L
- XLarge - # FPGU17A?XL
- 2XLarge - # FPGU17A?2X
- 3XLarge - # FPGU17A?3X
- 4XLarge - # FPGU17A?4X

- Poly/spandex, 4-way stretch fabric with high-compression fit
- Low-profile integrated pads are flexible and ridged to provide maximum protection to the hips, thighs and knees
- DRI-GEAR® technology
- Girdle includes cup pocket



### FOMATION PROTECTIVE COMPRESSION GIRDLE

- Youth Small - #FPGU28YWS
- Youth Medium - #FPGU28YWM
- Youth Large - #FPGU28YWL
- Small - #FPGU28AWS
- Medium - #FPGU28AWM
- Large - #FPGU28AWL
- XLarge - #FPGU28AWXL
- 2XLarge - #FPGU28AW2X
- 3XLarge - #FPGU28AW3X
- 4XLarge - #FPGU28AW4X

- Poly/spandex, 4-way stretch fabric with high-compression fit
- Integrated pads with perforated holes provide maximum protection and breathability
- 2" jaquard elastic waistband includes cup pocket

## ADULT APPAREL

	CHEST SIZE	WAIST SIZE
XS	32	26
SMALL	34-36	28-30
MEDIUM	38-40	32-34
LARGE	42-44	36-38
XL	46-48	40-42
2L	50-52	44-46
3XL	54-56	48-50
4XL	58-60	52-54

## YOUTH APPAREL

	CHEST SIZE	WAIST SIZE
XXS	22-24	19-21
XS	24-26	21-23
SMALL	26-28	23-25
MEDIUM	28-30	25-27
LARGE	30-32	27-29
XL	32-34	29-31
2XL	34-36	31-33



### FOOTBALL FLAG BELT - 1 DOZEN

Gold- #A105DZGO

Kelly Green - #A105DZKG

Royal Blue- #A105DXRY

Scarlet - #A105DZSC

- Each belt includes two regulation flags
- Flags slide to allow distance to be adjusted
- Flags attach with hook and loop fasteners
- Adjustable 45" length web belt



GOLD



KELLY GREEN



ROYAL



SCARLET



### QUICK-DOWN "POP" FLAG BELT

Gold- #A108GO

Royal Blue- #A108RY

Scarlet - #A108SC

- Belt "pops" when a flag is pulled
- Individual belt includes three regulation flags
- Web belt adjusts up to 50"
- Flags slide to allow distance to be adjusted



GOLD



ROYAL



SCARLET

### 7 ON 7 YARD MARKERS

#A102F

- 13" x 13" PVC covered foam construction, self-supporting markers
- Orange marker with black numbers on each side
- Set includes 2 pieces of "G" and "20", and one "40"
- Ideal for 7 on 7 football or flag football



Other options are available! We can get what you need!

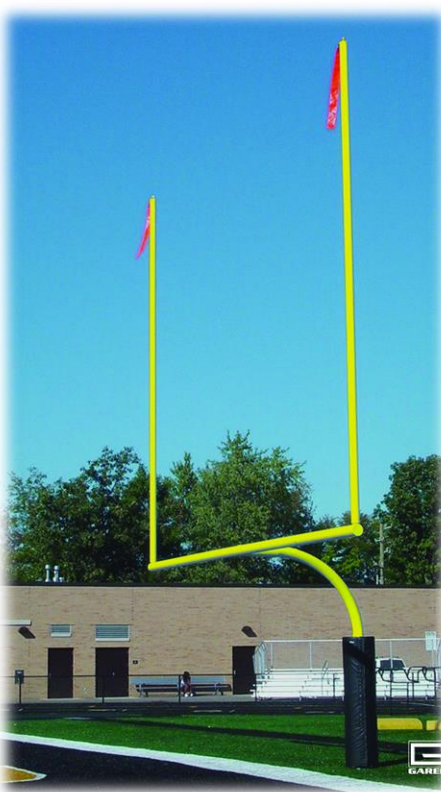

### HIGH SCHOOL FOOTBALL GOALPOST

- 4 1/2" O.D. PERMANENT/SLEEVE

WHITE - #FGHS45IGW

YELLOW - #FGHS45IGY

GROUND SLEEVES - #FGP400GS

- 4 1/2" O.D. SURFACE-MOUNT

WHITE - #FGHS45SMW

YELLOW - #FGHS45SMY

- 5 9/16" O.D. PERMANENT/SLEEVE

WHITE - #FGHS606IGW

YELLOW - #FGHS606IGY

GROUND SLEEVES - #FGP600GS

- 5 9/16" O.D. SURFACE-MOUNT

WHITE - #FGHS606SMW

YELLOW - #FGHS606SMY

- 23' 4" wide crossbars meet official specifications for high school play
- The offset allows multiple sports to share the field.



### COLLEGE FOOTBALL GOALPOST

- 5 9/16" O.D. PERMANENT/SLEEVE

WHITE - #FGC606IGW

YELLOW - #FGC606IGY

GROUND SLEEVES - #FGP600GS

- 5 9/16" O.D. SURFACE-MOUNT

WHITE - #FGC606SMW

YELLOW - #FGC606SMY

- 18' 6" wide crossbars meet official specifications for collegiate play

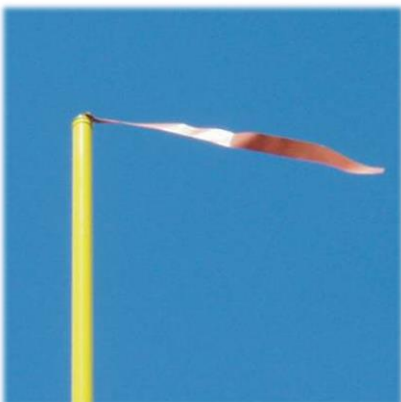

### WIND DIRECTION FLAGS (SET OF 4)

#1197747DS

- High visible Orange color
- Set of (4)



## SPORTS COOL PORTABLE COOLING SYSTEM

#1240405

- Portable cooling systems for sports and recreation
- Fits in the back of a school bus, trailer, truck or van
- Easy to operate! Requires 115V electrical outlet
- Powder coated steel frame. 20-gallon FDA, NSF approved tank. 24" fan, 8550 CFM cools up to 75' away, no water hose needed
- Warranty - Fan: (2) Two Years; Pumps: (1) One Year, Parts: (1) One Year, Frame: (5) Five Years



## POWER TANKER WITH CART

#1378677

- Powder coated steel frame and aluminum deck
- Retractable, non-corrosive PVC drinking tubes with a coiled design deliver safe and clean drinking water to players
- 35-gallon tank and eight drinking stations let the entire team quickly quench their thirst, and an
- Aluminum utility shelf
- Four 10 in. pneumatic tires
- Adjustable shut-offs are powered by a 12-volt, 12-amp rechargeable battery that runs for up to eight hours on a single charge



## GAME DAY HYDRATION PACKAGE

#1371360

- The perfect solution for keeping athletes cool, hydrated and ready for peak performance on game day
- Package includes: 2 - Portable Mister Cooling Systems (1240405) and 1 - Power Tanker with Cart (1378677)



## SPORTS COOL DRINKING STATION WITH FILTER

#1453185

- Galvanized steel tubing frame with removable legs for easy transport and storage
- Drinking tube is made of non-corrosive PVC
- In-line filter for cleaner fresher water
- Includes 8 drinking stations with shut-off nozzles
- Connects to a standard water hose (not included)
- Dimensions: 43"H x 53"L - 25 lbs



## SPORTS COOL POWERED TEAM DRINKER

#1240412

- Powder coated steel cart withstands rain, snow and sunshine for all-weather use
- Six retractable-coil drinking hoses with quick shut-off nozzles promote efficient hydration
- 20-gallon FDA, NSF approved tank with an extra-wide threaded top allows quick, easy refilling
- No-flat tires offer simple transportation over a variety of field and court surfaces, so the cart moves to follow the team
- Included trickle charger and sanitizing tablets deliver clean water and lasting performance



## PRACTICE HYDRATION PACKAGE

#1371361

- Hydrate more players faster, so more time can be spent practicing, with 20 total drinking stations
- Package includes: 2 - Powered Team Drinkers (1240412) and 1 - Drinking Station (1453185)





### SPALDING TF-1000 LEGACY

Official Size 29.5" - #768131

Intermediate Size 28.5" - #768141

- NFHS APPROVED: Official high school ball in NY, CT, ME, PA, TX, IA, KS, KY, MA, MO, MN, RI, VT, WI, WV, N Central CIF, SC
- Micorfiber composite leather
- Deep channel design for superior control



### HEAVY DUTY BALL CART W/ CASTERS

#CART315

- 1" powder-coated square steel tubing & 4 heavy duty rotating casters
- Black finish
- Holds 15 balls
- Easy to assemble
- 49"L x 16"W x 35"H



### SPALDING TF-1000 PRECISION

Official Size 29.5" - #768158

Intermediate Size 28.5" - #768168

- NFHS APPROVED: Official high school ball in MD and ID
- Micorfiber composite leather
- Deep channel design for superior control



### HEAVY DUTY BALL LOCKER

#BLOCKS

- 1" powder-coated square steel tubing
- Black finish
- Lockable hinged lid (lock not included)
- Easy to assemble
- Holds 28-30 basketballs
- 47"L x 24"W x 38"H



### WILSON EVOLUTION

Official Size 29.5" - #WTB0516

Intermediate Size 28.5" - #WTB0586

- #1 Indoor Ball
- NFHS APPROVED
- Micorfiber composite leather
- Patented Aqua Grip laid in channels
- Patented cushion core technology



### 10" DUAL ACTION PUMP W/ GAUGE

#A146

- Durable aluminum cylinder
- Gauge measures air pressure during inflation



### NEEDLES

#A145B



## GARED ALL PRO JAM ADJUSTABLE

#GP12A72DM

- Recommended Play Level: NIRSA, Recreation, Youth
- Premium adjustable basketball system is a popular choice for residential use, playgrounds, and recreational play environments
- Includes 6" x 8" post, BB72A38 acrylic board, and 2000+ breakaway rim
- Actuator mechanism allows easy adjustment from 7' to 10' rim height



## GARED PRO JAM ADJUSTABLE

#GP10A72DM

- Recommended Play Level: NIRSA, Recreation, Youth
- Premium adjustable basketball system is a popular choice for residential use, playgrounds, and recreational play environments
- Includes 6" square post, BB72A38 acrylic board, and 2000+ breakaway rim
- Actuator mechanism allows easy adjustment from 7' to 10' rim height



## GARED COLLEGIATE JAM ADJUSTABLE

#GP8A60DM

- Recommended Play Level: NIRSA, Recreation, Youth
- Premium adjustable basketball system is a popular choice for residential use, playgrounds, and recreational play environments
- Includes 5" square post, BB60A38 acrylic board, and 1000 breakaway rim
- Actuator mechanism allows easy adjustment from 7' to 10' rim height



## SQUARE POST PADDING

5" Post - #PP5SQF

6" Post - #PP6SQF

The Fitted Post Pad protects players from injury due to contact with basketball, volleyball, tetherball, or other game poles. Features mitered corners to fit snugly on the post without spinning and has Velcro strips for closure. Constructed of 2" foam covered in UV-resistant vinyl for maximum protection and long life. Available in BLACK only.

Other options are  
available! We can get what  
you need!





## ECONOMY 3-1/2" O.D. REAR-MOUNT GOOSENECK PACKAGE

#PK3545

Maximize physical education and park budgets with a commercial grade PK3545 playground basketball system. This package features a 3-1/2" O.D. rear-mount gooseneck post with 36" safe play area, fan-shape rear-mount white steel backboard, and economy fixed single rear-mount rim.

- Recommended Play Level: NIRSA, Recreation, Youth
- Package includes GN35R post, 1266 board, and 66T rim



## STANDARD DUTY 4-1/2" O.D. GOOSENECK PACKAGE

#PK4560

Designed for schoolyards, municipal parks, and recreation facilities, the PK4560 standard-duty gooseneck playground system perfectly completes outdoor basketball courts. This package features a 4-1/2" O.D. gooseneck post with 48" safe play area, 42" x 60" marked steel backboard, and fixed double rim.

- Package includes GN45 post, 1260B board, and 240 rim



## STANDARD DUTY 4-1/2" O.D. REAR-MOUNT GOOSENECK PACKAGE

#PK4570

Designed for schoolyards, municipal parks, and recreation facilities, the PK4570 standard-duty gooseneck playground system perfectly completes outdoor basketball courts. This package features a 4-1/2" O.D. rear-mount gooseneck post with 48" safe play area, fan-shape marked rear-mount backboard, and fixed double rear-mount rim.

- Package includes GN45R post, 1266B board, and 266 rim

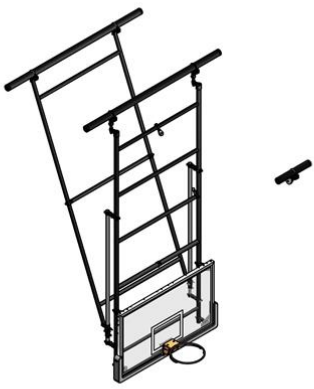

## DUAL POST REAR-BRACED FRONT-FOLDING CEILING HUNG

#2203

Customized to a facility building design, the ceiling hung backstop features direct goal attachment for optimal backboard strength and performance. Approved for competition play, the 2203 steel welded structure provides maximum clearance for facilities with ceilings heights between 18' and 31'.

- Dual post rear-braced front-folding unit provides ultimate stability with maximum clearance over the court
- Fully welded frame for heights up to 24'



## DUAL POST REAR-BRACED STATIONARY CEILING HUNG

#2211

Customized to a facility building design, the 2211 ceiling hung backstop features direct goal attachment for optimal backboard strength and performance.

- Dual post rear-braced stationary unit for courts more than 14' from a wall
- Fully welded frame for ceiling heights up to 24'



## DUAL POST REAR-BRACED REAR-FOLDING CEILING HUNG

#2205

Customized to a facility building design, the 2205 ceiling hung backstop features direct goal attachment for optimal backboard strength and performance. Approved for competition play, the 2205 steel welded structure provides maximum clearance for facilities with ceilings heights between 18' and 24' with rear court storage.

- Dual post rear-braced rear-folding unit for areas with minimum clearance over the court
- Fully welded frame for ceiling heights up to 24'



## SINGLE POST REAR-BRACED ROLL-FOLD CEILING HUNG

#3304

Customized to a facility building design, the ceiling hung backstop features direct goal attachment for optimal backboard strength and performance. Approved for competition play, the 3304 steel clamped structure provides maximum clearance for facilities with ceilings above 32' with rear court storage.

- Straight post rear-braced front-folding unit is track-mounted with compact folding for areas with limited space to fold up in front and rear of backstop
- Bolt-together frame for ceiling heights 32' and above



## DUAL POST WALL-BRACED STATIONARY CEILING HUNG

### #2215

Customized to a facility building design, the ceiling hung backstop features direct goal attachment for optimal backboard strength and performance. Approved for competition play, the 2215 steel clamped non-folding structure provides maximum clearance for facilities with ceilings heights between 18' and 24' allowing up to 14' from face of backboard.

- Dual post wall-braced stationary unit for courts within 14' of wall
- Fully welded frame for ceiling heights up to 24'

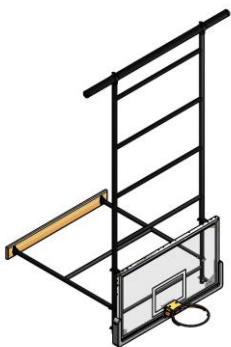

## DUAL POST WALL-BRACED STATIONARY CEILING HUNG

### #2615

Customized to a facility building design, the ceiling hung backstop features direct goal attachment for optimal backboard strength and performance. Approved for competition play, the 2615 steel clamped non-folding structure provides maximum clearance for facilities with ceilings heights between 24' and 32', allowing up to 14' to face of backboard.

- Dual post wall-braced stationary unit for courts within 14' of wall
- Bolt-together frame for ceiling heights from 24' to 32'



## SINGLE POST WALL-BRACED STATIONARY CEILING HUNG

### #3114

Customized to a facility building design, the ceiling hung backstop features direct goal attachment for optimal backboard strength and performance. Approved for competition play, the 3114 steel clamped non-folding structure provides maximum clearance for facilities with ceilings above 32', allowing up to 14' to face of backboard.

- Straight post wall-braced stationary unit for courts within 14' of wall and wall will not support a wall mount unit
- Bolt-together frame for ceiling heights from 32' to 36'



## SINGLE POST REAR-BRACED STATIONARY CEILING HUNG

### #3110

Customized to a facility building design, the ceiling hung backstop features direct goal attachment for optimal backboard strength and performance. Approved for competition play, the 3110 steel clamped structure provides maximum clearance for facilities with ceilings above 32' without wall attachment options.

- Straight post rear-braced stationary unit for courts more than 14' from a wall and wall will not support a wall mount unit
- Bolt-together frame for ceiling heights from 32' to 36'



Other options are  
available! We can get what  
you need!



## JUNIOR JAMMER MULTI-HEIGHT YOUTH BACKBOARD ADAPTER

#JJ5A

The JJ5A Junior Jammer is designed to allow younger players to play on competition systems by lowering the goal to 5 different fixed youth heights. Adapter includes a fiberglass board which is securely attached to existing goal, and a fixed stationary rim.



## REBOUNDING SKILL RING TRAINER

#RB

The RB Rebound Ring is designed to develop rebounding skills by allowing the ball to fall through only on a perfect shot. Reduces goal from standard 18" to 10-1/2". The ring attaches to any 18" goal and is powder coated orange for maximum durability.



## VARSITY TOSS BACK TRAINING AID

#VARSITY

The Varsity Toss Back® is recognized as the best basketball training aid and skill development tool available. The Varsity can dramatically improve a player's quickness, strength, stamina, and passing accuracy, and some of the best basketball programs in the country own as many as 14 Toss Backs® for individual player workouts. Net frame adjusts to varying angles for different types of practice drills. Net frame is 38" x 51", and height can be adjusted from 4' 5" to 7' 4". The roll-around base uses casters for easy mobility and stability. Unit easily locks into place using a hand lever brake.



## SHOOTING RING TRAINER

#PR

The PR Practice Ring reduces the size of the basketball goal to help improve shooting accuracy. Reduces goal from standard 18" to 17". Attaches to any 18" rim. Goal attaches to any 18" rim and is powdercoated orange for maximum durability.

## ELECTRIC HOIST W/ KEY SWITCH

#1194

The 1194 Electric Hoist is the most convenient way to raise and lower your gymnasium equipment. Designed for ceiling-hung basketball backstops and fold-up wall-mounted systems.





**PROFESSIONAL PRO-MOLD® BACKBOARD PADDING**

**#PMCE-COLOR?**

Safeguard your players with our PMCE PRO-MOLD® bolt-on basketball backboard padding. Pads will universally fit any 72" backboard with a 2" channel. One pad kit protects one backboard. Offered in an array of 16 vibrant colors.

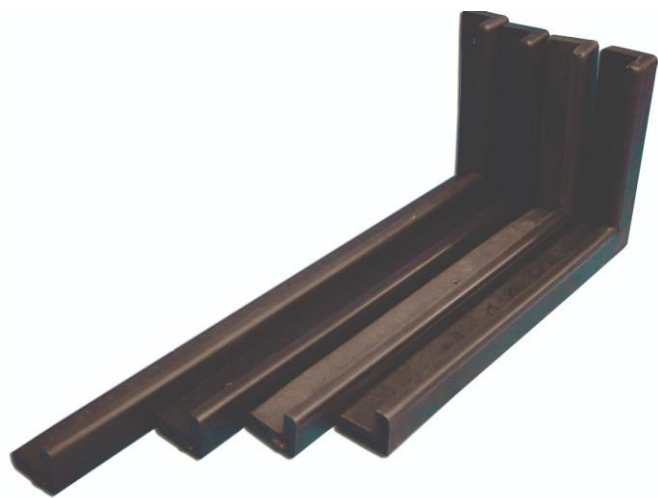

**RECREATIONAL PRO-MOLD® OUTDOOR BACKBOARD PADDING**

- 48" - #LSCE48
- 54" - #LSCE54
- 60" - #LSCE60
- 72" - #LSCE72

The LSCE recreational PRO-MOLD basketball backboard padding provides protection to decrease risk of player head injury. Durable polyurethane foam is designed for long life in heavy play settings and resistance to weather elements. Bolts to metal framing using self-tapping screws on outdoor rectangular glass and acrylic backboards.

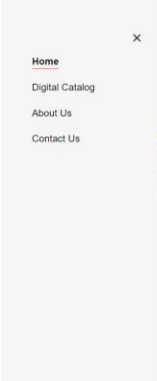

2022 Catalog

Connect With Us



Check us out online at [advancedsportssupply.com](http://advancedsportssupply.com) or call 812-556-2036!

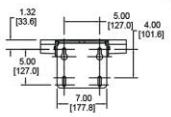
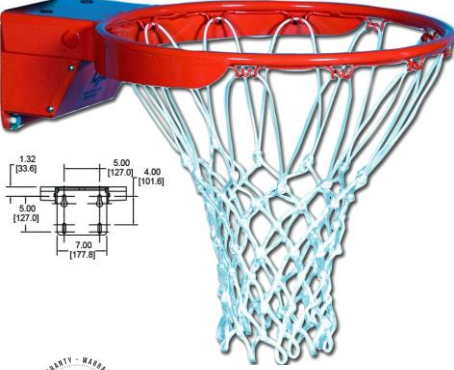

## SCHOLASTIC FLEX BREAKAWAY RIM

#1000

- Recommended Play Level: NAIA, NIRSA, Recreation, Youth
- Top quality flex goal without a positive lock mechanism
- No-Tie net attachments
- Anti-whip net and hardware included

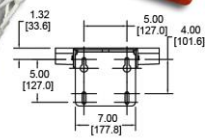
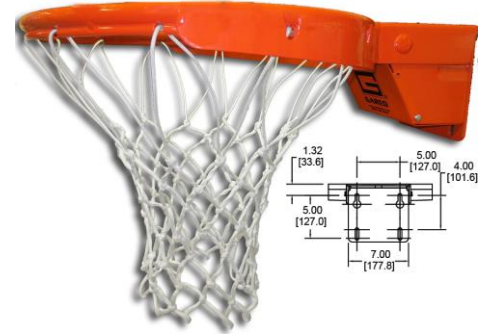

## COLLEGIATE PREMIUM BREAKAWAY RIM

#2500

- Recommended Play Level: NCAA, NFHS, AAU, NAIA, NIRSA
- Same superior quality as our 2000+, but includes a tube-tie net attachment to prevent hand injury
- Anti-whip net, hardware, and tie cable included

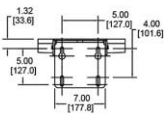

## COLLEGIATE 2000+ PREMIUM BREAKAWAY RIM

#2000+

- Recommended Play Level: NCAA, NFHS, AAU, NAIA, NIRSA
- Best selling positive lock breakaway rim designed for competition play environments
- No-Tie net attachments
- Anti-whip net and hardware included

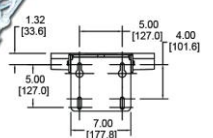
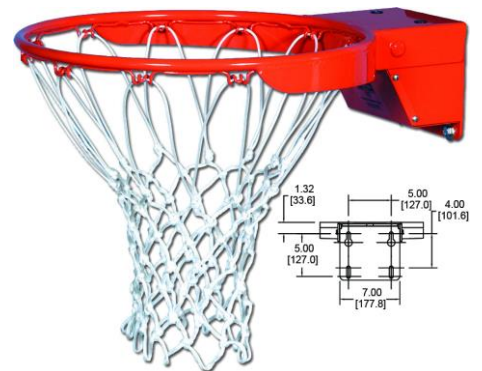

## MASTER 3000 PROFESSIONAL BREAKAWAY RIM

#3000

- Recommended Play Level: NBA, NCAA, AAU, IOC
- Premium breakaway rim set to break at 160 lbs of pressure
- No-Tie net attachments
- Anti-whip net and hardware included

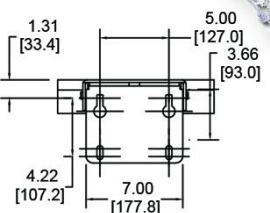
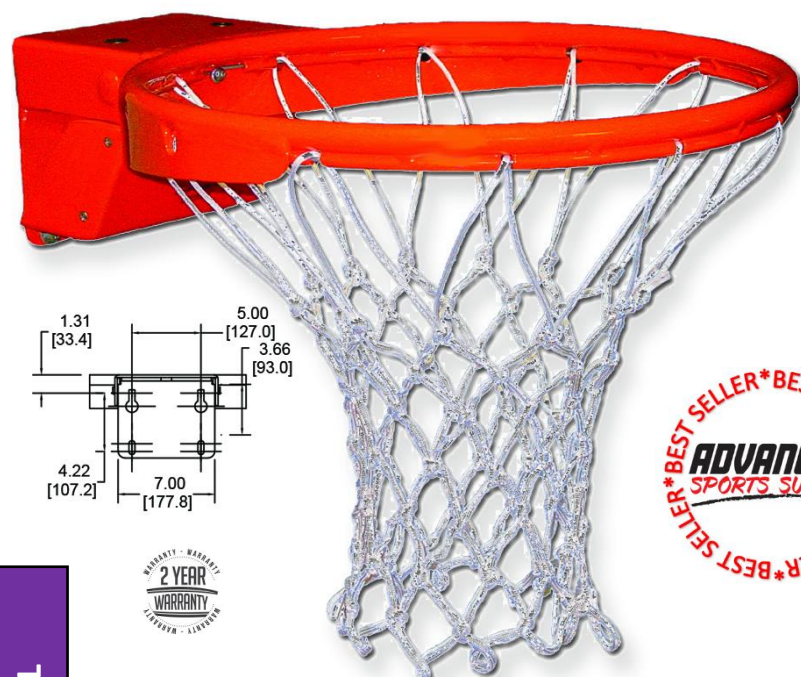

## MASTER PROFESSIONAL BREAKAWAY RIM

#3500

- Recommended Play Level: NBA, NCAA, AAU, IOC
- Designed with a tube tie net attachment to lower risk of hand injury
- Anti-whip net, hardware, and tie cable included

BASKETBALL

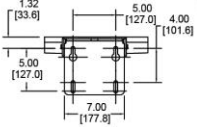
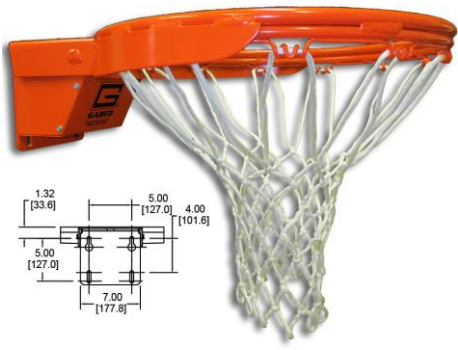

## PLAYGROUND DOUBLE RING BREAKAWAY RIM

#5500

- Recommended Play Level: NIRSA, Recreation, Youth
- Durable double rim breakaway goal for playground environments
- Anti-whip net and hardware included

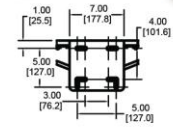
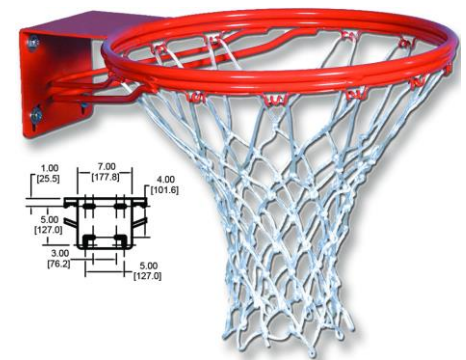

## SUPER GOAL FIXED RIM

#240

- Recommended Play Level: NIRSA, Recreation, Youth
- Affordable and durable double rim playground goal
- GGN net and hardware included



## ENDURANCE SLAM BREAKAWAY RIM

#8800

- Recommended Play Level: NIRSA, Recreation, Youth
- Beefy double rim, continuous wing brace = strongest double rimmed goal in the industry
- T-style net attachment lowers risk of hand injury and increases net security
- Anti-whip net and hardware included

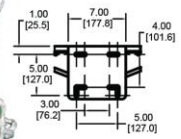
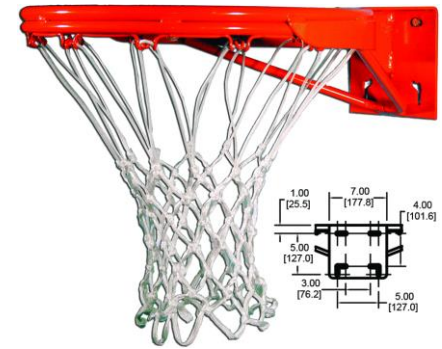

## TITAN PLAYGROUND FIXED RIM

#7550

- Recommended Play Level: NIRSA, Recreation, Youth
- Our strongest traditional-style double rim playground goal
- GGN net and hardware included

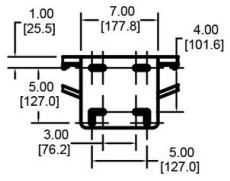
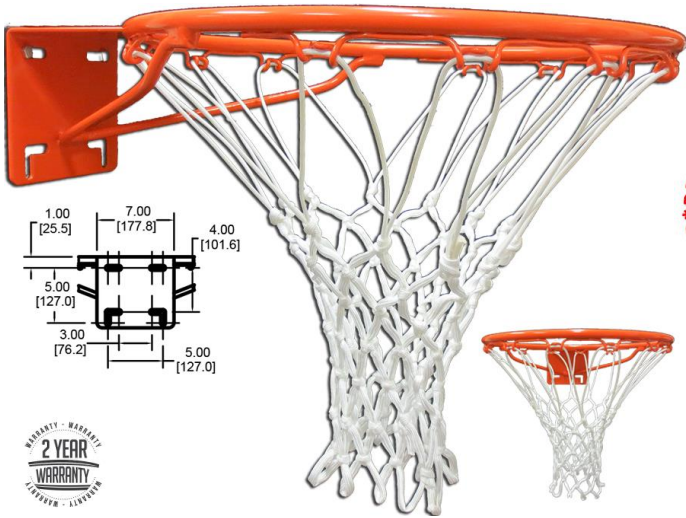

## INSTITUTIONAL FIXED RIM

#39WO

- Recommended Play Level: NIRSA, Recreation, Youth
- Our best-selling economical goal for indoor and outdoor use
- GGN net and hardware included

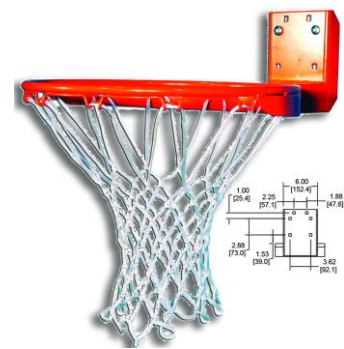

## REAR-MOUNT INSTITUTIONAL FIXED RIM

#66T

- Rear mount construction increases life span of backboard
- Compatible with any rear mount backboard
- GGN net and hardware included





**“BRUTE” ANTI-WHIP  
BRAIDED NYLON NET**

#NG07

- Engineered design prevents net whip
- Heavy 220g braided nylon construction
- 12 loops x 7 knot
- 21" long net



**ANTI-WHIP NYLON  
NET**

#NG02

- Engineered design prevents net whip
- 110g braided nylon construction
- 12 loops x 7 knot
- 21" long net



**STEEL CHAIN NET**

#NG01

- Rust-proof nickel-plated steel
- Hooks allow for easy attachment
- 12 loops
- 21" long net



**BRAIDED NYLON NET**

#NG03

- 50g braided nylon construction
- 12 loops x 7 knot
- 21" long net



**“BRUTE” BRAIDED NYLON NET**

#NG05

- The most durable nylon basketball net made
- Heavy 220g braided nylon construction
- 12 loops x 7 knot
- 21" long net



**BRAIDED NYLON NET  
RED/WHITE/BLUE**

#NG04

- 50g braided nylon construction
- 12 loops x 7 knot
- 21" long net
- Red, white & blue





## FRONT-MOUNT FAN-SHAPED STEEL

**Marked Target - #1245T**

**Unmarked - #1245**

- Recommended Play Level: NRSA, Recreation, Youth
- Strongest board option for outdoor use and heavy play environments
- 12-gauge steel
- Powder coat white
- RIM SOLD SEPERATELY

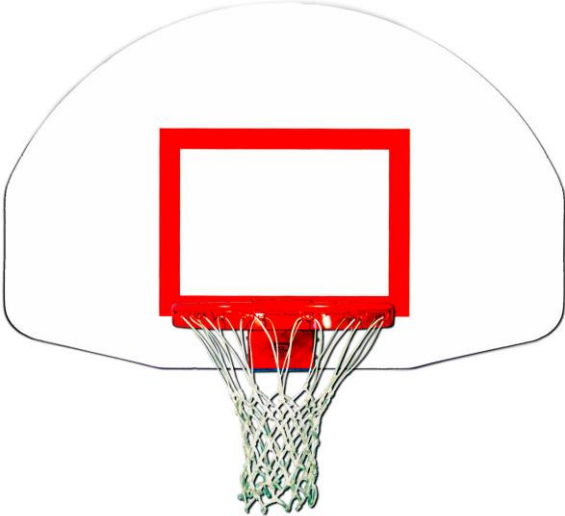

## REAR-MOUNT FAN- SHAPED STEEL

**Marked Target & Boarder - #1266B**

**Unmarked - #1266**

- Recommended Play Level: NRSA, Youth, Recreation
- Strongest board option for outdoor use and heavy play environments
- 12-gauge steel
- Powder coat white
- RIM SOLD SEPERATELY



## REAR-MOUNT FAN- SHAPED STEEL

▪ 42" x 72"

**Marked Target & Boarder - #1272B**

**Unmarked - #1272**

**Perforated - #1272PS**

▪ 42" x 60"

**Marked Target & Boarder - #1260B**

**Unmarked - #1260**

**Perforated - #1260PS**

▪ 48" x 72"

**Marked Target & Boarder - #1270B**

**Unmarked - #1270**

- Recommended Play Level: NRSA, Recreation, Youth
- Strongest board option for outdoor use and heavy play environments
- 12-gauge steel
- Powder coat white
- RIM SOLD SEPERATELY

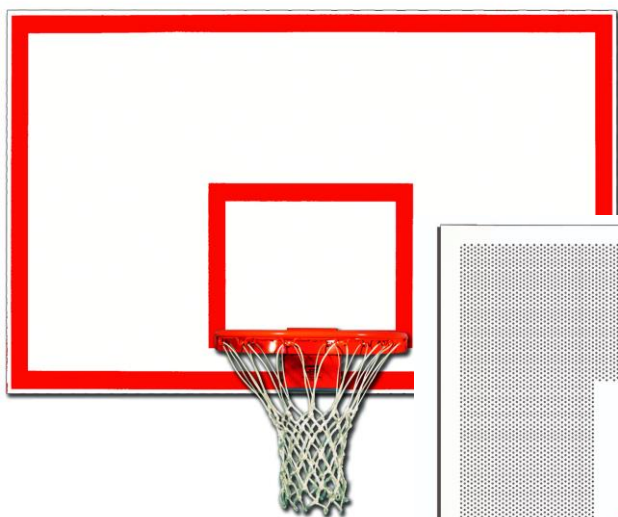
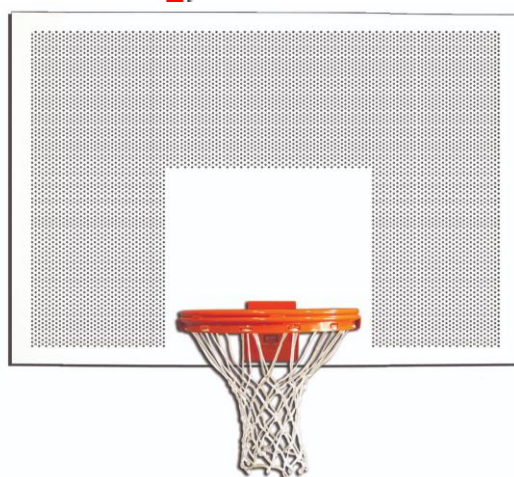



## HARDWOOD TRACTION MAT

#ACT

- Ideal for all indoor conditions to provide cleaner and improved shoe grip
- Works on all gym floors
- Great for basketball, volleyball and physical education
- Base dimensions: 19"H x 19"W
- Sheet dimensions: 15"H x 18"W
- 60 sheets included

## TRACTION MAT REPLACEMENT SHEETS

#ACTR

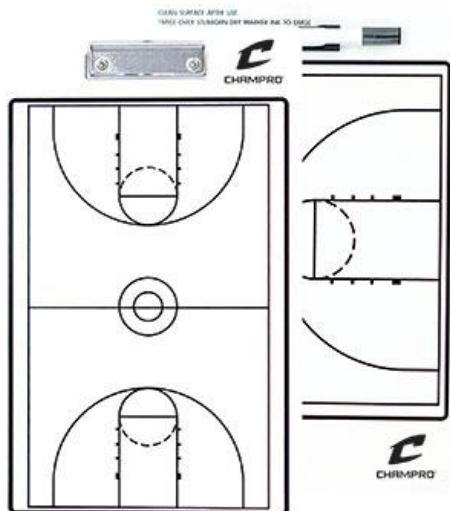

## BASKETBALL COACH'S BOARD

#A092

- 10" x 16"
- Two sided board with full field/court on one side and half field/court on the opposite side
- Easy wipe-off surface for use with dry erase marker
- Dry erase marker is included and clips onto board



## WHISTLE W/LANYARD & MOUTH CUSHION

#A336CL

- Recommended for official use
- Pealess
- Wind chambers produce a high pitch sound
- Pierces through high noise

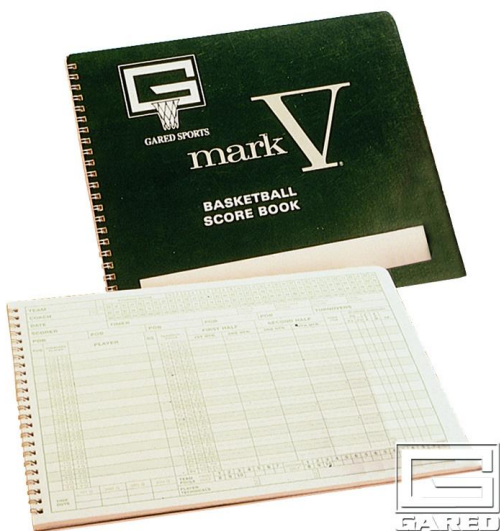

## BASKETBALL SCOREBOOK

#MARKV

- Includes scoring sheets for 30 games with running scores
- Includes scoring instructions and season totals
- Heavy-duty cardstock backing



## WATER RESISTANT STOPWATCH

#A152

- Large display
- Split 1-2 finish
- 1/100 second
- Alarm
- 12/24 hour time/calendar



## Mueller MTape

#130105

- Mueller® MTape is a top-quality athletic tape ideal for all sports medicine applications
- Easy to tear and unwinds to the core for fast and effective taping
- Provides firm support and compression
- Made of hospital-grade, 100% cotton backcloth with a zinc oxide based adhesive
- High tensile strength, excellent tackiness and conformability
- CASE WHITE - 1.5" X 15 YD - 32 ROLLS



## Mueller MWrap

#130702

- Provides a protective barrier between skin and athletic tape
- Used to hold pads, socks and cold packs in place
- Versatile enough to hold up sleeves, create a knee strap or protect feet under boots and athletic footwear
- CASE NATURAL – 2.75" X 30 YD – 48 ROLLS



## Mueller Icebags & Dispenser

#030801 – Ice Bags

#030851 – Steel Ice Bag Dispenser

- Mueller® Disposable Plastic Bags for quick cold therapy of minor sports injuries
- 10"x18" bag. 1500 bags per roll.
- Items sold separately



## Mueller Kold® Instant Cold Packs

#030102

- The Mueller® Kold® Instant Cold Packs are convenient and ready whenever you need them
- No refrigeration is needed, and they activate instantly
- Fast-acting cold compresses are ideal for sports injuries or first aid
- CASE – 16 Ice Packs



## Mueller Refill Kit

#200750

- Restock your Medi Kits™ properly with a Mueller® Refill Kit
- Contents (may change) -(10) 3" x 3" Gauze Pads,(4) 4" x 4" Gauze Pads,(6) M Strips® X-large,(12) M Strips® Regular,(10) Nasal Plugs,(1) 3 oz Lubricating Ointment,(1) M Cutter™,(1) 2 oz Germa Spray,(1) 3 oz Medi Stat™ Spray,(1) 4 oz Tuffner® Pre-Tape Spray,(1) 2.75 oz Abrasion Ointment,(10) StaphASeptic™ 1/16 oz packets,(1) Elastic Bandage roll,(1) Glove Canister,(3) Pair Exam Gloves,(1) MuellerKold® Instant Cold Pack,(1) M Wrap® roll,(1) 1.5" M Tape® roll,(1) Tape Tote™,(1) 4 oz Coolant Cold Spray,(1) Wonder Wrap™ (3" Elastic Wrap),(1) 4 oz Tape & Tuffner® Remover Spray,(1) 3" Gauze Roll



## Mueller Ice Bag Wrap

#230676

- The soft, adjustable ice bag wrap is ideal for applying cold therapy to small or large body parts
- The long straps provide a custom fit with firm, comfortable compression
- The ice bag is made with a high-tech liner that won't drip or leak - INCLUDED



## Mueller Mouth Guards – CASE of 100

#1310?? - Muellerguard™ without strap

#1310?? – Strapguard™ with strap

- Designed by a dentist, Muellerguard® Mouthguard helps reduce the risk of dental injury during the toughest of sports
- Thin front wall construction won't interfere with speech or breathing, while thickened posterior area helps absorb impact
- Fast-fitting co-polymer resin for comfortable fit
- Oral trauma reduced via an aerated shock absorbing "pillow"
- Perfect fit gives better blunt-blow protection
- Low profile helps reduce gagging
- Available colors: Clear, White, Yellow, Orange, Red, Pink, Maroon, Kelly Green, Dark Green, Royal, Navy, Purple, Black





## EDWARDS CLASSIC ROUND POSTS

### 3" POSTS – STANDARD HEIGHT

GREEN - #1234404

BLACK - #1234411

GROUND SLEEVES - #1234473

### 2 7/8" POSTS – STANDARD HEIGHT

GREEN - #1234428

BLACK - #1234435

GROUND SLEEVES - #1235708

Your court will surely shine with the Edwards 3" Classic Round Post. Made of polyester powder-coated tubular steel with integral lacing bars. Comes complete with brass winder. Ground sleeves are not included. Designed to meet the demanding specs of the North American market.

- Constructed of round tubular steel
- Powder coated finish
- Complete with brass winder and lacing bars
- Ground sleeves sold separately

## EDWARDS 10 & UNDER TENNIS / PICKLEBALL POSTS

### 3" POSTS

GREEN - #1371705

BLACK - #1393373

GROUND SLEEVES - #1233473

- Sized right for 10 & Under Tennis and Pickleball
- Constructed of 3" round tubular steel
- Powder coated finish - 36" above ground height
- Complete with brass winder and lacing bars
- Ground sleeves and net sold separately



## EDWARDS WIMBELDON SQUARE POSTS

### 3" POSTS

GREEN - #1234459

BLACK - #1234442

GROUND SLEEVES - #1234480

- Constructed from 3" square "box-section" steel
- Powder coated finish
- Complete with brass winder and lacing bars
- Ground sleeves sold separately





## 2.8 MM TOURNAMENT TENNIS NET

#T1

- 42' Tournament
- 2.8 mm Braided polyethylene netting
- 2.5" Double reinforced headband
- Six rows of heavy nylon stitching
- 6 mm Vinyl coated steel cable
- Taped nylon bottom and side pockets and dowels



## 3 MM TOURNAMENT TENNIS NET

#T100

- 42' Tournament
- Heavy-duty 3 mm double braided polyethylene netting
- 2.5" Double reinforced headband
- 6 rows of heavy nylon stitching
- 6 mm Vinyl coated steel cable
- Taped nylon bottom and side pockets and dowels



## 3.6 MM TOURNAMENT TENNIS NET

#T200

- 42' Tournament
- Heavy-duty 3.6 mm double braided polyethylene netting
- First 5 rows of double netting
- 2.5" Double reinforced headband
- 8 Rows of heavy nylon stitching
- 6 mm vinyl coated steel cable
- Taped nylon bottom with side pockets and dowels

## TENNIS CENTER STRAP

#TCS

- Nylon webbing
- Adjustable heavy-duty snap and hook
- Measures 2"W and up to 36"L
- White



## 8 & UNDER TENNIS / PICKLEBALL NET 3MM

#PBN500

- Official pickleball tournament size
- Approximately 30" of cable on each side of the net for attaching to the posts
- Braided polyethylene
- 23 oz Vinyl headband steel cable
- 27' Steel cable
- Fiberglass dowels
- 36"H x 21'9"L



## 10 & UNDER TENNIS NET 3.5MM

#1296785

- 3.5mm braided, knotless nylon netting with 1-3/4" square mesh
- Heavy duty vinyl coated headband
- 5/8" diameter fiberglass dowels
- 42"H x 33'L

## PORTABLE PICKLEBALL NET

#PBNET

- Regulation size 22'W
- Steel frame for superior durability
- Adjustment straps maximizes tension
- Center support keeps the net taught at 34"H
- Heavy-duty carry bag





## PENN® CHAMPIONSHIP TENNIS BALLS

#MTPENCAN

- 3 balls per can – 24 Cans/Case



## PENN® PRACTICE/COACH TENNIS BALLS

#MTPENBAL

- 3 balls per can – 24 Cans/Case



## WILSON CHAMPIONSHIP TENNIS BALLS

#MTWILCAN

- 3 balls per can – 24 Cans/Case



## WILSON PRACTICE TENNIS BALLS

#MTWILBAL

- 3 balls per can – 24 Cans/Case



## WILSON ENERGY XL TENNIS RACQUET

#1388070

- V-Matrix™ Technology for larger sweet spot
- 112" Head, 27.5" length
- 10.3 oz strung weight(291g)
- 4 3/8" grip size



## RHINO PICKLEBALL APEX PADDLE

#APEX100

- Meets all USAPA Tournament guidelines
- Featuring the ProPolyCore2™ for optimum control and vibration dampening technology
- Poly surface for excellent spin control
- Ultra cushion texture grip
- Face: Fiberglass
- Weight: 7.8 to 8.5 oz
- Length: 15.5±" Width 7.75±"
- Handle: 4.75±"
- Grip Circumference: 4.25±"

## DILLER PADDLE & BALL PACK

2 PADDLES + 4 BALLS - #1450226

4 PADDLES + 4 BALLS - #1450227

SINGLE PADDLE ONLY- #1450225



## OUTDOOR PICKLEBALLS

#PB6RMOSET

- USAPA Approved
- Rotationally molded seamless design for the most accurate and straightest flight
- Weighted for straight and fast shots even in windy conditions
- Strategically aligned hole configuration for optimal balance
- 40 holes, 3"D, 0.9 oz
- Set of six





## SUPERIOR RECYCLED LIFESTYLE TEE

**YOUTH XS-XL - #BST108Y**

**WOMEN'S XS-2XL - #BST108W**

**ADULT S-3XL - #BST108A**

- Recycled, lightweight 100% polyester fabric body
- Ribbed crew neck
- Set-in sleeves, double needle hem
- Forward shoulders
- Straight bottom, double needle hem



**RECYCLED YARN - GARMENT MAY BE PRONE TO SLIGHT SHADE VARIATION**



## LEADER T-SHIRT

**YOUTH S-XL - #BST85Y**

**ADULT S-4XL - #BST85A**

- Impact-85, premium 100% polyester interlock fabric
- Self-material crew neck with back neck tape
- Technical cut shoulder insert
- 1/4 length set-in sleeve, double needle hemmed
- Straight bottom, double needle hemmed
- DRI-GEAR® technology



## STAR LADIES V-NECK T-SHIRT

**GIRLS' S-L - #BST21G**

**WOMEN'S XS-2XL - #BST21W**

- Impact 85, premium weight 100% polyester interlock jersey
- Self-material overlap V-neck with back neck tape
- Set-in cap sleeves, double needle hem
- Athletic cut and grade
- DRI-GEAR® technology



**STOCK DECORATION IS AVAILABLE. CALL US TODAY FOR PRICING!**



**VISION SHORT SLEEVE T-SHIRT**

- YOUTH XS-L - #BST99Y**
- WOMEN'S XS-2XL - #BST99W**
- ADULT S-4XL - #BST99A**

- Com-V-Tek, lightweight 100% Polyester interlock fabric
- Self-material crew neck
- 1/4 length set-in sleeve, double needle hemmed
- Straight bottom, double needle hemmed



**VISION LONG SLEEVE T-SHIRT**

- YOUTH XS-L - #BST99LSY**
- WOMEN'S XS-2XL - #BST99LSW**
- ADULT S-4XL - #BST99LSA**

- COM V-TEK, 100% polyester lightweight fabric
- Self-material crew neck
- Set-in long sleeves, double needle hem
- Straight bottom, double needle hem



**VISION SHORTS**

- YOUTH S-XL - #BBS44Y**
- GIRLS' S-L - #BBS44GY**
- WOMEN'S S-2XL - #BBS44W**
- ADULT S-3XL - #BBS44A**

- Com-V-Tek, lightweight 100% polyester interlock fabric
- 1 1/2" covered elastic waistband with drawcord
- Double needle hemmed leg openings
- 9" adult inseam, 5" women's & girls' inseam, 7" youth inseam



**STOCK DECORATION IS AVAILABLE. CALL US TODAY FOR PRICING!**

**SPORTSWEAR**

## REV REVERSIBLE TEE

YOUTH S-L - #BST10Y

ADULT S-2XL - #BST10A

- 100% polyester single ply reversible tee shirt
- Self-material crew neck color
- 1/4 length set-in sleeves
- Double needle hemmed sleeves and bottom



## DOUBLE STOCK REVERSIBLE TEE

YOUTH S-L - #BSTK9Y

ADULT S-2XL - #BSTK9A

- Reversible t-shirt available in stock color combinations
- Z-cloth, lightweight 100% polyester interlock fabric
- Self-material crew neck collar
- 1/4 length set-in sleeves with closed sleeve ends
- Straight bottom, double needle hemmed
- Left open at bottom for screen printing



STOCK DECORATION IS  
AVAILABLE. CALL US TODAY  
FOR PRICING!

**ADVANCED**  
**SPORTS SUPPLY**



**GUNNER SHOOTER SHIRT**

**YOUTH S-XL - #BST12Y**

**ADULT S-4XL - #BST12A**

- Impact-85, premium 100% polyester interlock fabric
- Crew neck collar with taped neck
- Technical cut shoulder insert
- Set-in full-length sleeves, self-material cuffs
- Straight bottom, double needle hemmed
- DRI-GEAR® technology



**PERFORMANCE 1/4 ZIP**

**YOUTH S-XL - #FLQ4Y**

**ADULT S-4XL - #FLQ4A**

- PERFORMANCE, 84% polyester, 16% spandex lightweight fabric body
- Self fabric 1/4 zip with stand up collar
- Set-in long sleeves with dropped shoulders, double needle hem
- Shaped, double needle hemmed bottom



**NEW in 2023!**



**LINEUP FLEECE HOODIE**

**YOUTH S-XL - #FLQ4Y**

**ADULT S-4XL - #FLQ4A**

- FLEECE, 100% polyester fabric body
- Traditional hoodie with lace
- Set-in long sleeves with self-material cuffs
- Self-material bottom band
- Kangaroo pocket



**NEW in 2023!**



BS25 GRYNVY

BS24: WHISCA



BS25

GRV/BLK GRV/ROY GRV/SCA

BS24

WH/BLK WH/NVY WH/ROY

## EXTRA INNINGS ¾ LENGTH

**YOUTH S-XL - #BS24Y**

**ADULT S-2XL - #BS24A**

**YOUTH S-XL - #BS25Y**

**ADULT S-2XL - #BS25A**

- BS25: CATIONIC Z-CLOTH, 100% polyester heather fabric body with Z-75 fabric sleeves
- BS24: Z-75, lightweight 100% polyester interlock fabric body and sleeves
- PRO-AIR 100% polyester mesh fabric inserts
- Crew neck collar with taped neck
- ¾ length raglan sleeves, double needle hemmed
- Straight bottom, double needle hemmed



**NEW in 2023!**

## WOVEN WARM-UP JACKET

**YOUTH S-L - #BSJ200Y**

**ADULT S-4XL - #BSJ200A**

- STRETCH WOVEN, Polyester / Spandex water repellent body
- Self material bomber collar with 1/4 front zip
- Stretch drawcord hemmed in bottom with barrel adjustment feature
- Set-in sleeves, double needle hem



BLK GRPH NVY ROY SCA WH



GRPH

## CAGE JACKET

**YOUTH M-L - #BSJ100Y**

**ADULT S-4XL - #BSJ100A**

- Poly/spandex stretch woven water-repellant body
- 100% poly mesh side inserts for breathability
- Self-material stand-up collar
- 1/4 zip front with zipper pull
- Stretch drawcord in hemmed bottom with plastic barrel adjustment feature
- 1/2 length set-in sleeve, double needle hemmed



BLK NVY ROY SCA



LTD

### VICTORIOUS SHORT

**YOUTH S-XL - #BBS33Y**

**ADULT S-3XL - #BBS33A**

- Z-Cloth, lightweight 100% polyester interlock fabric
- 1.5" covered elastic waistband with drawcord
- Double needle hemmed leg openings
- 9" adult inseam, 7" youth inseam, 8" women's inseam



CRD

### DYNAMIC TRICOT MESH SHORT

**YOUTH S-XL - #BBS55Y**

**ADULT S-3XL - #BBS55A**

**7" INSEAM ADULT S-3XL - #BBS557A**

- Zone, 100% polyester tricot mesh fabric
- Inner solid tricot fabric liner
- 1 1/2" covered elastic waistband with drawcord
- Double needle hemmed leg opening



ROY

### LIMITLESS SHORT

**YOUTH S-L - #BBS66Y**

**WOMEN'S XS-2XL - #BBS66W**

**ADULT S-4XL - #BBS66A**

- Active cloth 2.0, 100% polyester lightweight fabric body
- Pin-dot mesh, 100% polyester diagonal side inserts
- Exposed 2" internal branded waistband
- Deep side pockets
- 9" adult inseam, 5" women's inseam, 7" youth inseam



**STOCK DECORATION IS AVAILABLE.  
CALL US TODAY FOR PRICING!**



## PROFESSIONAL ATHLETIC SOCK

### S-L - #AS1

- 85% polyester/15% spandex
- Compression-style fit to perform better and recover faster
- Pro-quality construction is ideal for any sport
- Double cuff, double rib top and reinforced tailored toe
- Extra-long athletic cut

SOCK SIZE	SOCK SIZE				TUBE LENGTH (INCHES)
	GIRL'S	BOY'S	WOMEN'S	MEN'S	
XS: 3-5	7-13	N/A	N/A	N/A	14-16
S: 6-8	13-6	9-4	4-6	N/A	19-20
M: 9-11	6-9	4-9	6-9	4.5-9	23-24
L: 10-13	N/A	N/A	10-13	9-12	29-30



## FEATHERWEIGHT ATHLETIC SOCK

### XS-L - #AS5

- 88% nylon/12% elastane
- 50% lighter than traditional tube socks
- Tube style sock is ideal for any sport

SOCK SIZE	SOCK SIZE				TUBE LENGTH (INCHES)
	GIRL'S	BOY'S	WOMEN'S	MEN'S	
XS: 3-5	7-13	N/A	N/A	N/A	14-16
S: 6-8	13-6	9-4	4-6	N/A	19-20
M: 9-11	6-9	4-9	6-9	4.5-9	23-24
L: 10-13	N/A	N/A	10-13	9-12	29-30



## MULTI-SPORT ATHLETIC SOCK

### XS-L - #AS2

- 78% polyester/22% elastane
- Tube style sock is ideal for any sport
- Over-the-calf cut

SOCK SIZE	SOCK SIZE				TUBE LENGTH (INCHES)
	GIRL'S	BOY'S	WOMEN'S	MEN'S	
XS: 3-5	7-13	N/A	N/A	N/A	14-16
S: 6-8	13-6	9-4	4-6	N/A	19-20
M: 9-11	6-9	4-9	6-9	4.5-9	23-24
L: 10-13	N/A	N/A	10-13	9-12	29-30



# JUICE

## INFUSED GEAR

Full-dye, premium cut-and-sew sublimation!



- COLOR 1 CARDINAL
  - COLOR 2 VEGAS GOLD
  - COLOR 3 WHITE
- DESIGN SHOWN: DRIBBLE



UNDECORATED



- COLOR 1 ELECTRIC GREEN
  - COLOR 2 KELLY
  - COLOR 3 WHITE
- DESIGN SHOWN: CRASH



UNDECORATED



- COLOR 1 CHARCOAL
  - COLOR 2 ELECTRIC GREEN
  - COLOR 3 BLACK
  - COLOR 3 WHITE
- DESIGN SHOWN: TYPHOON



UNDECORATED



- COLOR 1 SCARLET
  - COLOR 2 ROYAL
  - COLOR 3 WHITE
- DESIGN SHOWN: SHOW TIME



UNDECORATED



- COLOR 1 ORANGE
  - COLOR 2 NAVY
  - COLOR 3 WHITE
- DESIGN SHOWN: FALCON



UNDECORATED

CHECK OUT OUR CUSTOM APPAREL/UNIFORM/CAP BUILDER AT [advancedsportssupply.com](http://advancedsportssupply.com)