

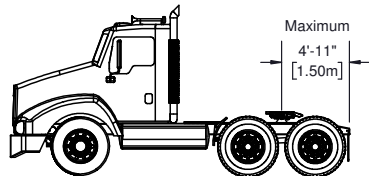

**SL260**  
**TECHNICAL DRAWINGS**  
2020

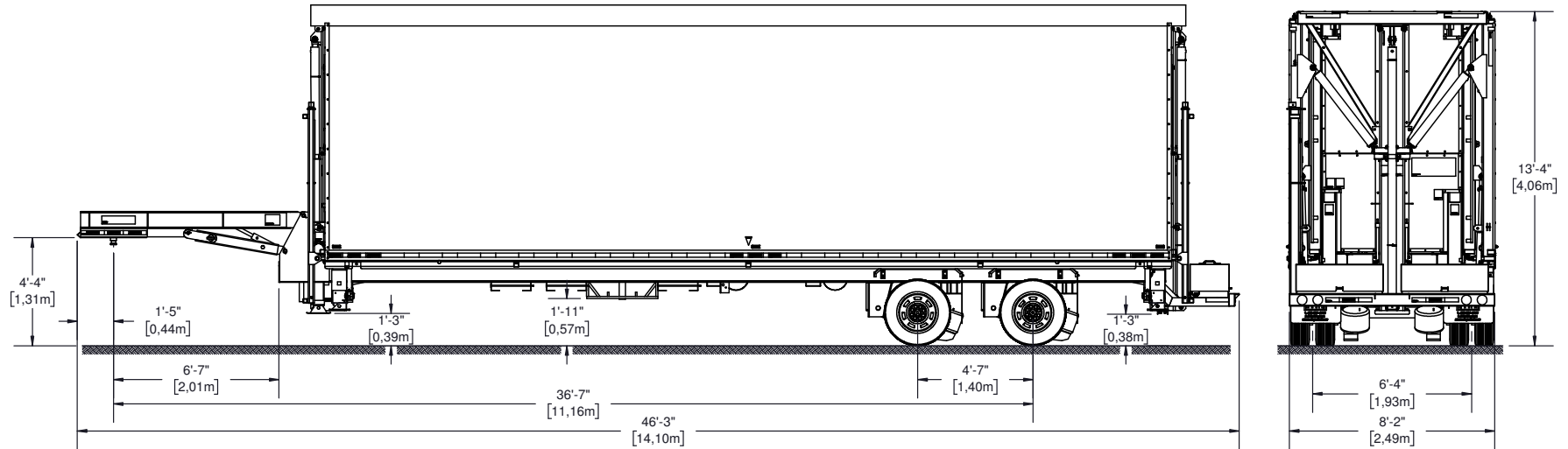

Mass SL260	Unladen		Standard Equipment		Maximum Capacity	
	Lbs	Kg	Lbs	Kg	Lbs	Kg
Total Mass	30115	13660	34921	15840	50000	22680
Mass on Axle	22223	10080	25309	11480	34000	15422
Mass on Hitch	7893	3580	9612	4360	-	-

Drawings may show stage equipped with optional accessories. May be sold separately.

© 2020 - All rights reserved, Stageline Mobile Stage Inc. Any and all forms of adaptation or reproduction of this document including the plans and drawings, in whole or in part, are strictly forbidden without the written authorisation of Stageline Mobile Stage Inc. Mass may vary depending on options. Technical specifications may change without notice. Stage specifications are subject to change without notice. Figures are nominal.

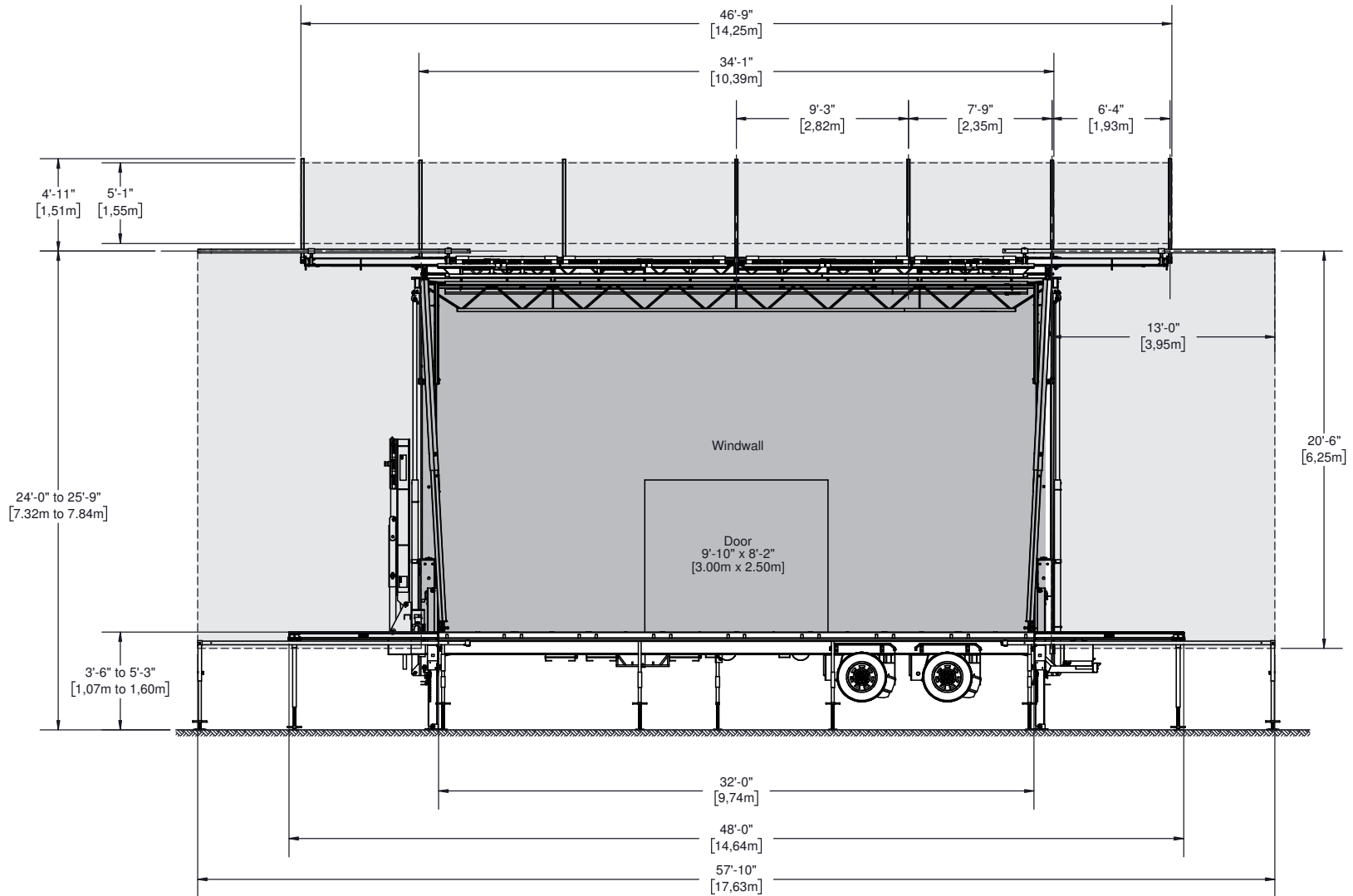

- WINDWALL
- BANNER (For dimensions, please refer to Banner Book)

Drawings may show stage equipped with optional accessories. May be sold separately.

© 2020 - All rights reserved, Stageline Mobile Stage Inc. Any and all forms of adaptation or reproduction of this document including the plans and drawings, in whole or in part, are strictly forbidden without the written authorisation of Stageline Mobile Stage Inc. Mass may vary depending on options. Technical specifications may change without notice. Stage specifications are subject to change without notice. Figures are nominal.

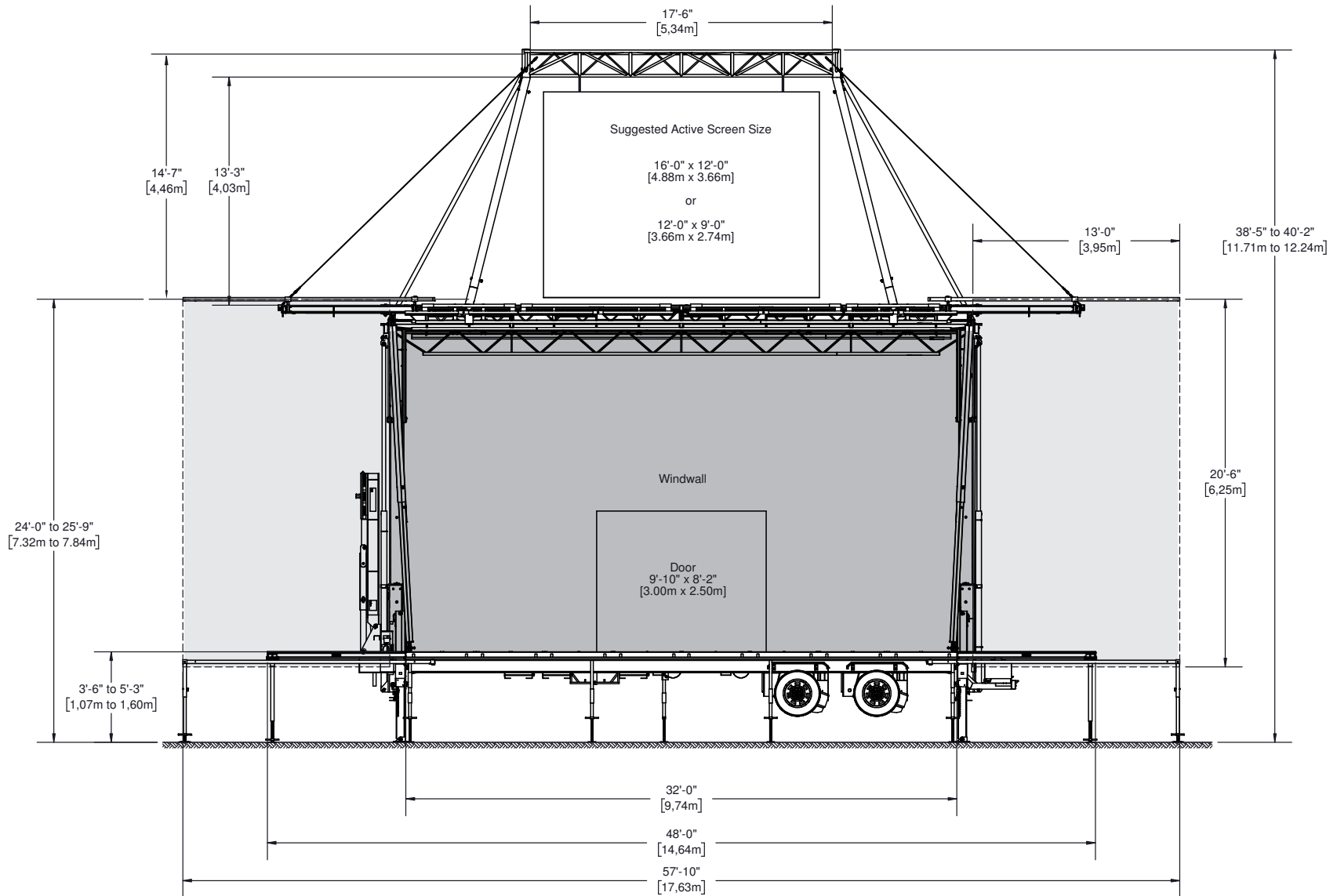

- WINDWALL
- BANNER (For dimensions, please refer to Banner Book)

Drawings may show stage equipped with optional accessories. May be sold separately.

© 2020 - All rights reserved, Stageline Mobile Stage Inc. Any and all forms of adaptation or reproduction of this document including the plans and drawings, in whole or in part, are strictly forbidden without the written authorisation of Stageline Mobile Stage Inc. Mass may vary depending on options. Technical specifications may change without notice. Stage specifications are subject to change without notice. Figures are nominal.

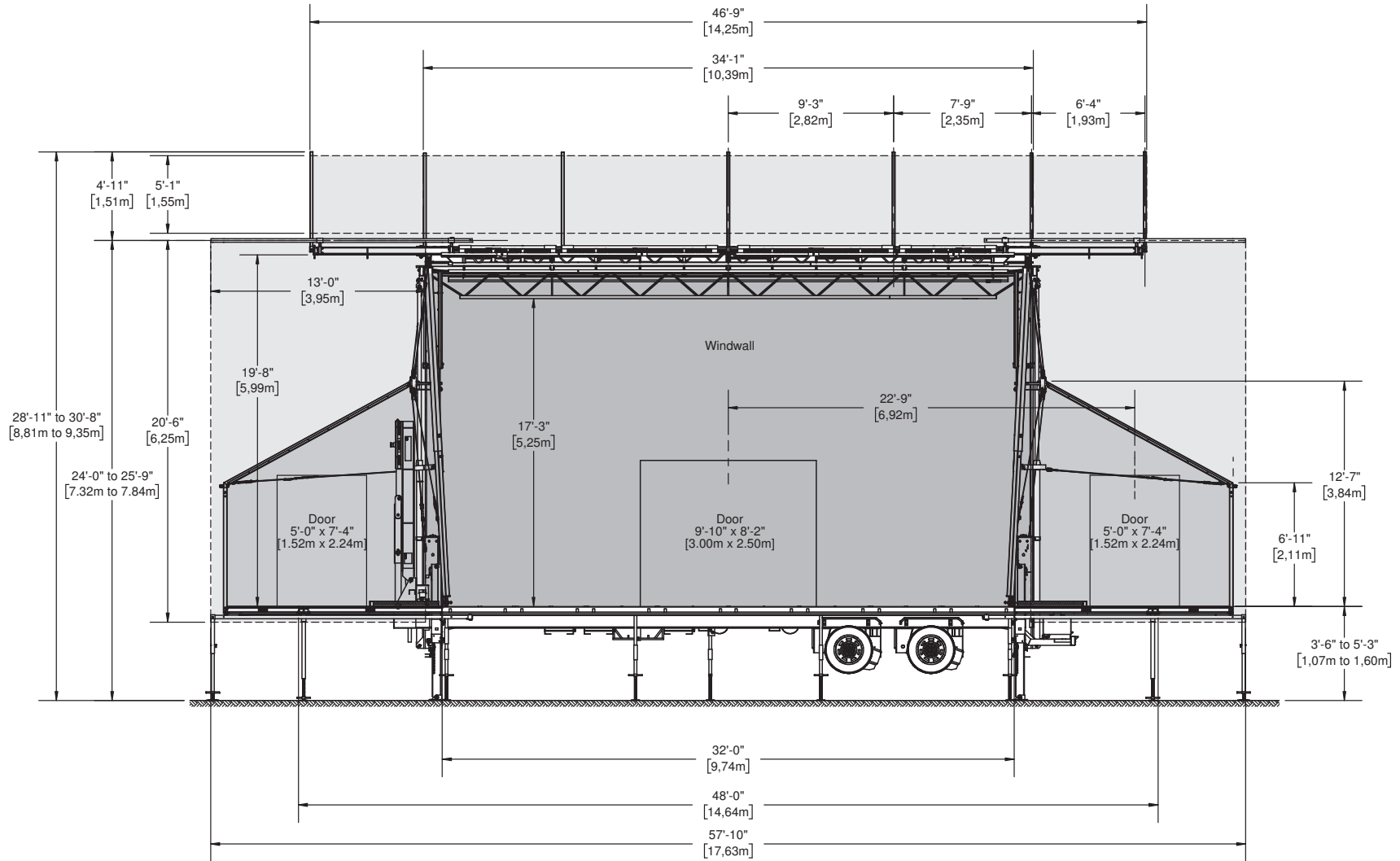

WINDWALL  
 BANNER (For dimensions, please refer to Banner Book)

Drawings may show stage equipped with optional accessories. May be sold separately.

© 2020 - All rights reserved, Stageline Mobile Stage Inc. Any and all forms of adaptation or reproduction of this document including the plans and drawings, in whole or in part, are strictly forbidden without the written authorisation of Stageline Mobile Stage Inc. Mass may vary depending on options. Technical specifications may change without notice. Stage specifications are subject to change without notice. Figures are nominal.

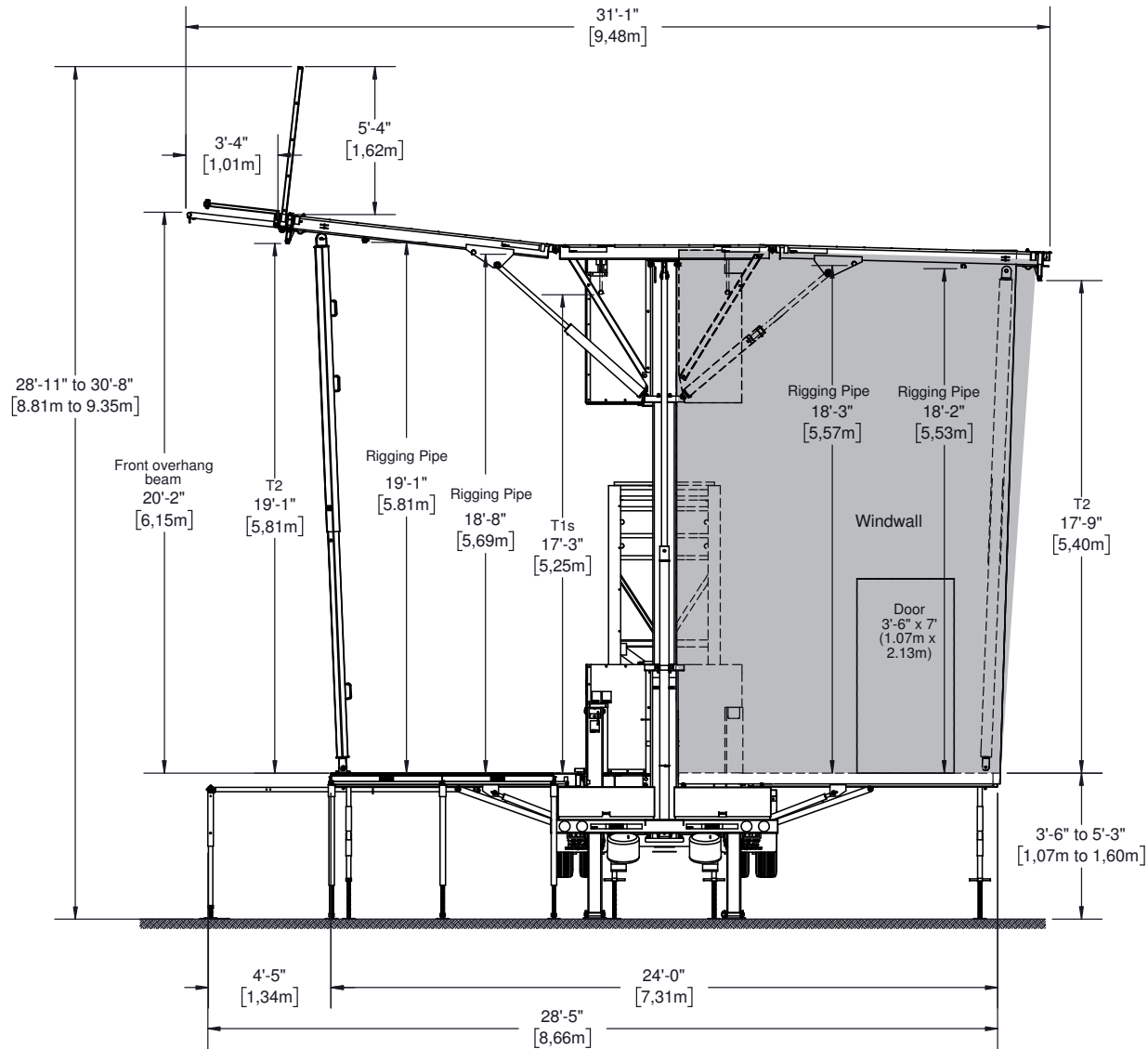

WINDWALL

Drawings may show stage equipped with optional accessories. May be sold separately.

© 2020 - All rights reserved, Stageline Mobile Stage Inc. Any and all forms of adaptation or reproduction of this document including the plans and drawings, in whole or in part, are strictly forbidden without the written authorisation of Stageline Mobile Stage Inc. Mass may vary depending on options. Technical specifications may change without notice. Stage specifications are subject to change without notice. Figures are nominal.

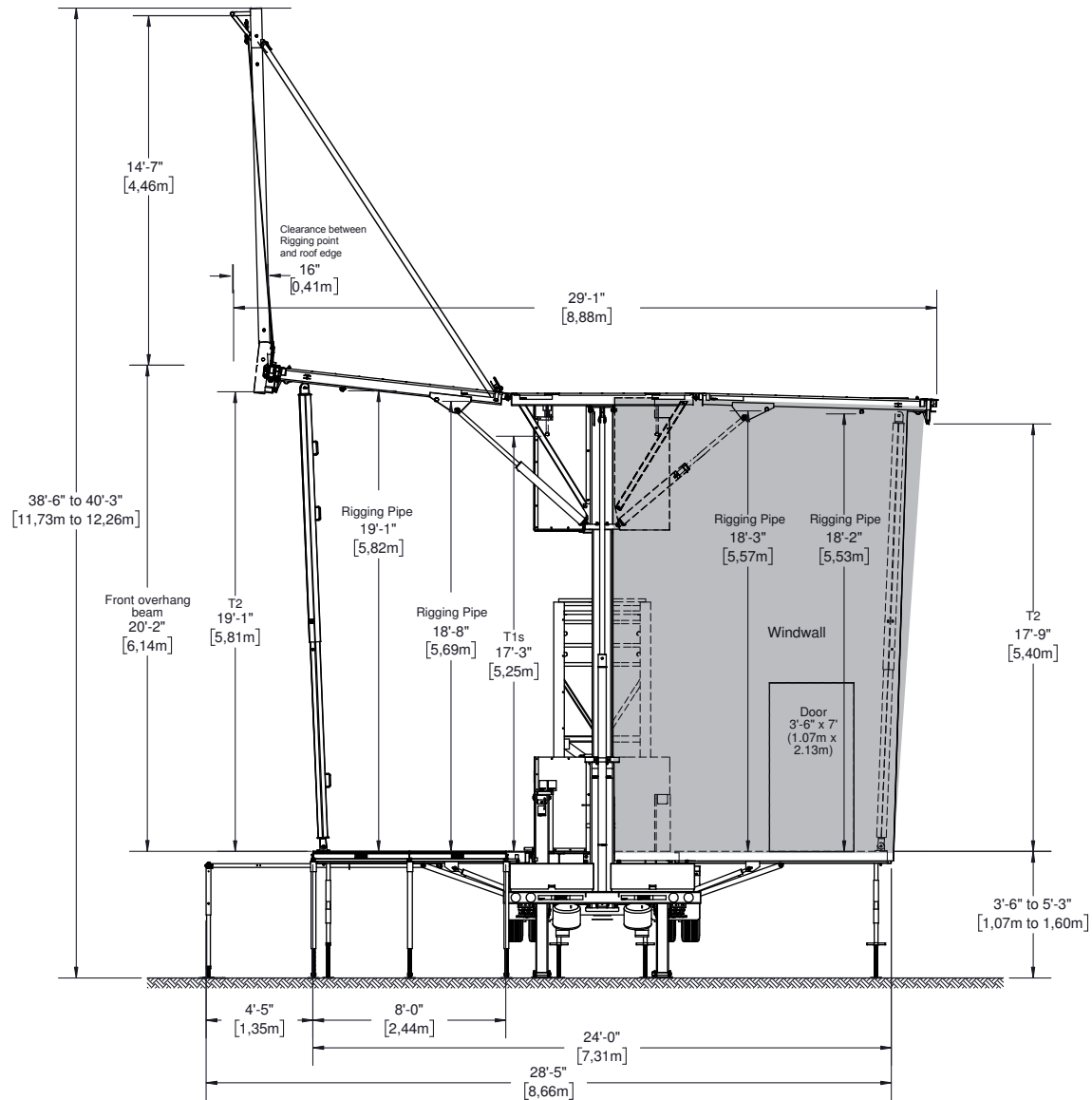

WINDWALL

Drawings may show stage equipped with optional accessories. May be sold separately.

© 2020 - All rights reserved, Stageline Mobile Stage Inc. Any and all forms of adaptation or reproduction of this document including the plans and drawings, in whole or in part, are strictly forbidden without the written authorisation of Stageline Mobile Stage Inc. Mass may vary depending on options. Technical specifications may change without notice. Stage specifications are subject to change without notice. Figures are nominal.

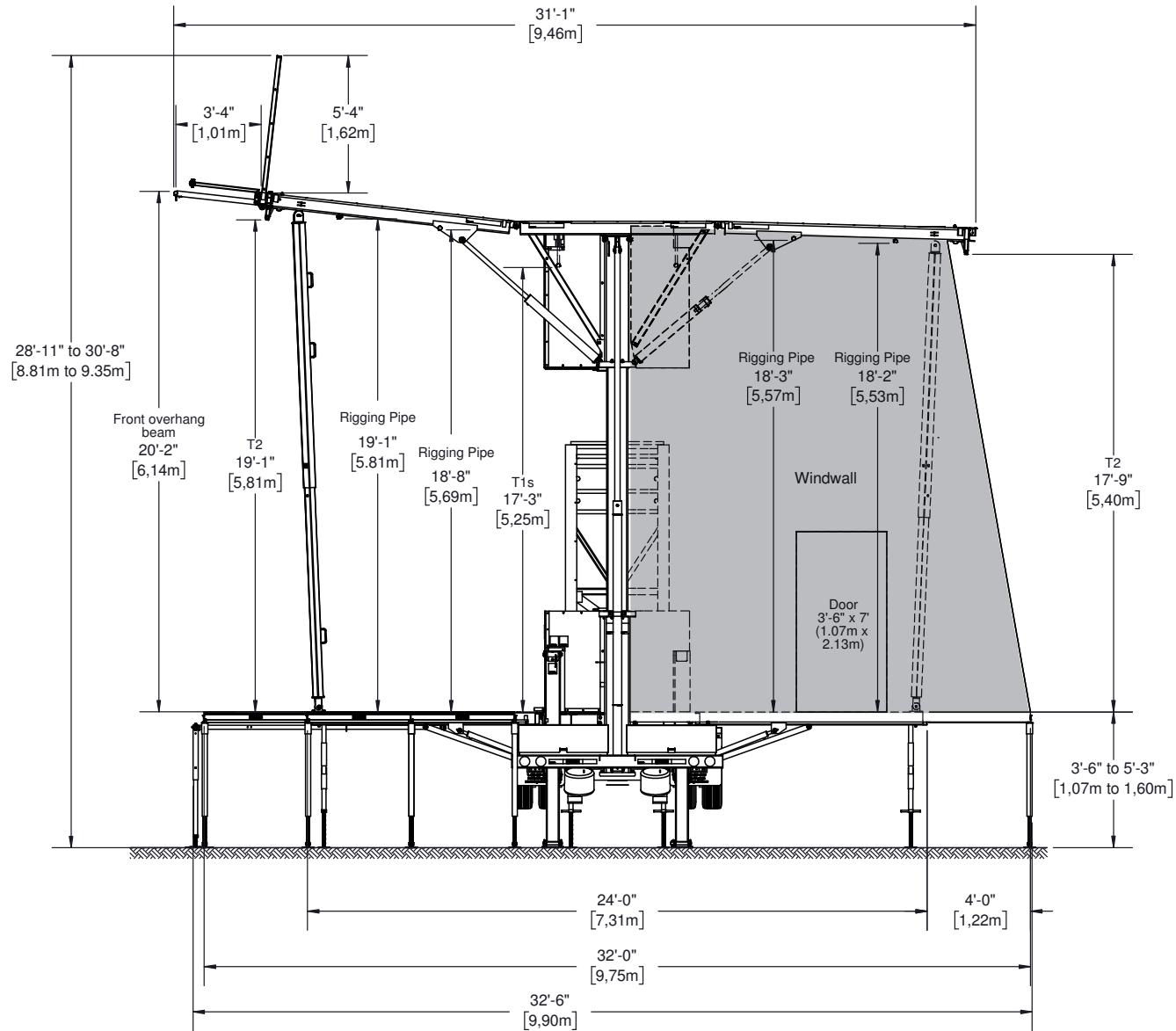

WINDWALL

Drawings may show stage equipped with optional accessories. May be sold separately.

© 2020 - All rights reserved, Stageline Mobile Stage Inc. Any and all forms of adaptation or reproduction of this document including the plans and drawings, in whole or in part, are strictly forbidden without the written authorisation of Stageline Mobile Stage Inc. Mass may vary depending on options. Technical specifications may change without notice. Stage specifications are subject to change without notice. Figures are nominal.



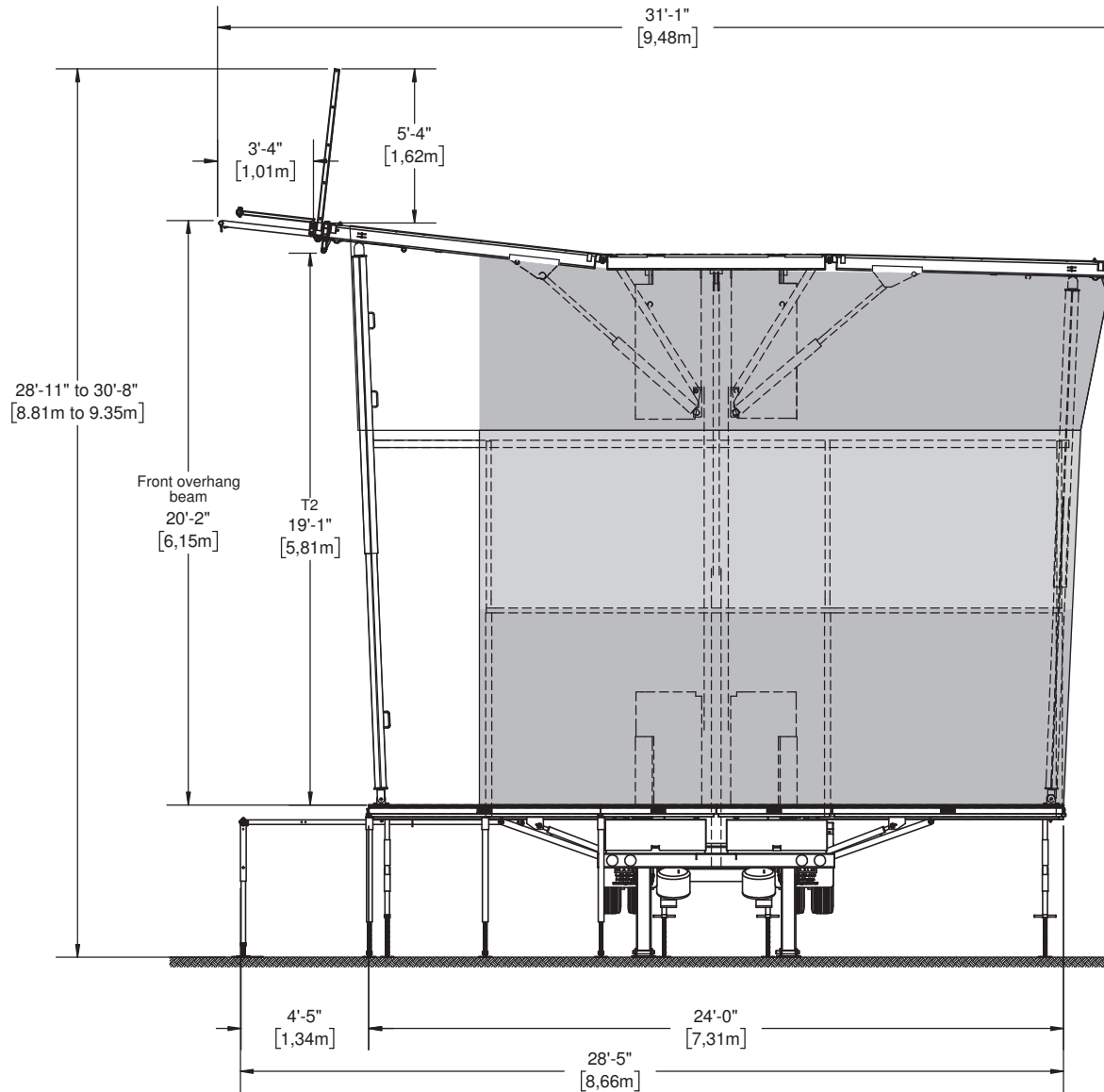

WINDWALL

Drawings may show stage equipped with optional accessories. May be sold separately.

© 2020 - All rights reserved, Stageline Mobile Stage Inc. Any and all forms of adaptation or reproduction of this document including the plans and drawings, in whole or in part, are strictly forbidden without the written authorisation of Stageline Mobile Stage Inc. Mass may vary depending on options. Technical specifications may change without notice. Stage specifications are subject to change without notice. Figures are nominal.

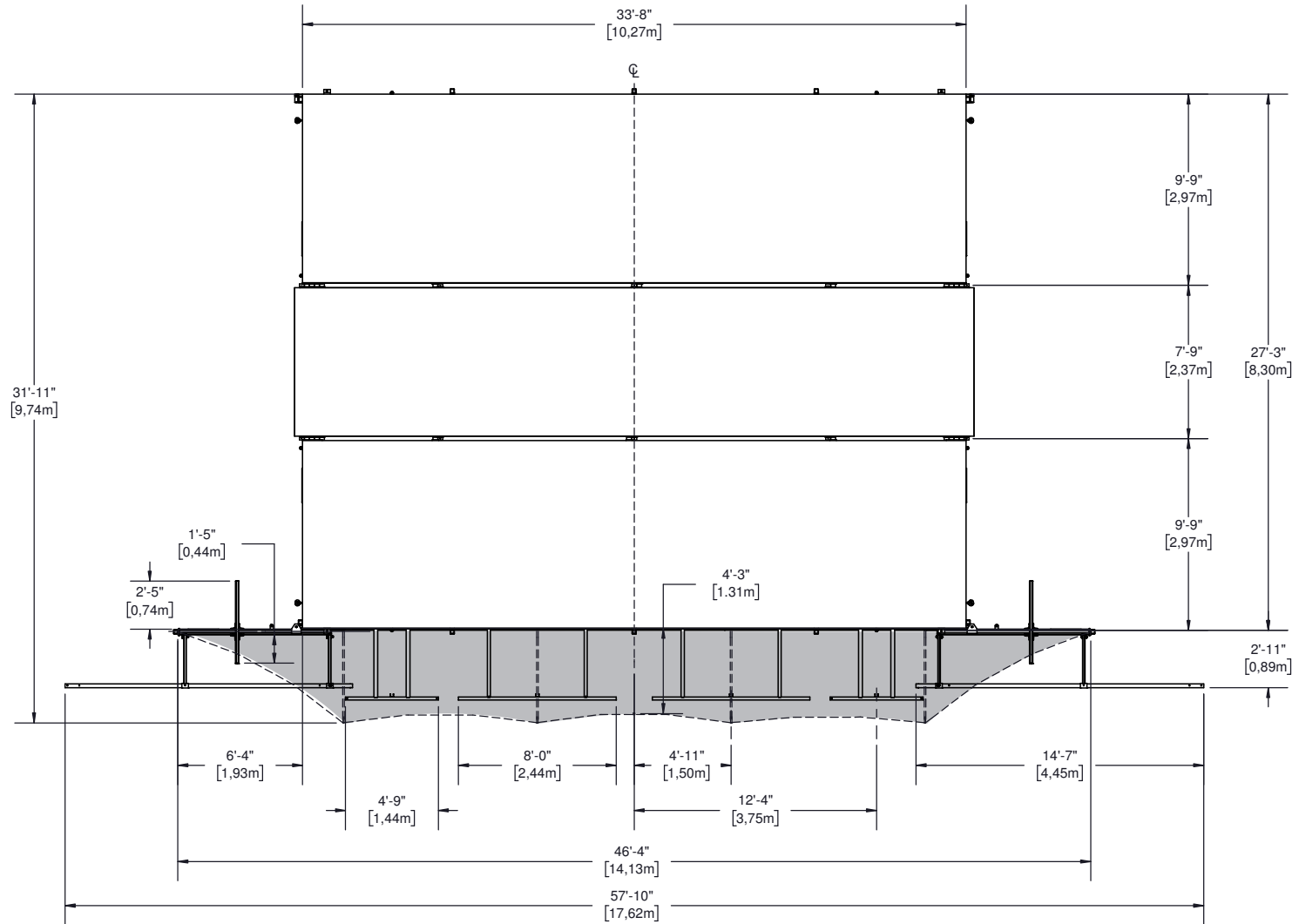

DOWNSTAGE

WINDWALL

Drawings may show stage equipped with optional accessories. May be sold separately.

© 2020 - All rights reserved, Stageline Mobile Stage Inc. Any and all forms of adaptation or reproduction of this document including the plans and drawings, in whole or in part, are strictly forbidden without the written authorisation of Stageline Mobile Stage Inc. Mass may vary depending on options. Technical specifications may change without notice. Stage specifications are subject to change without notice. Figures are nominal.

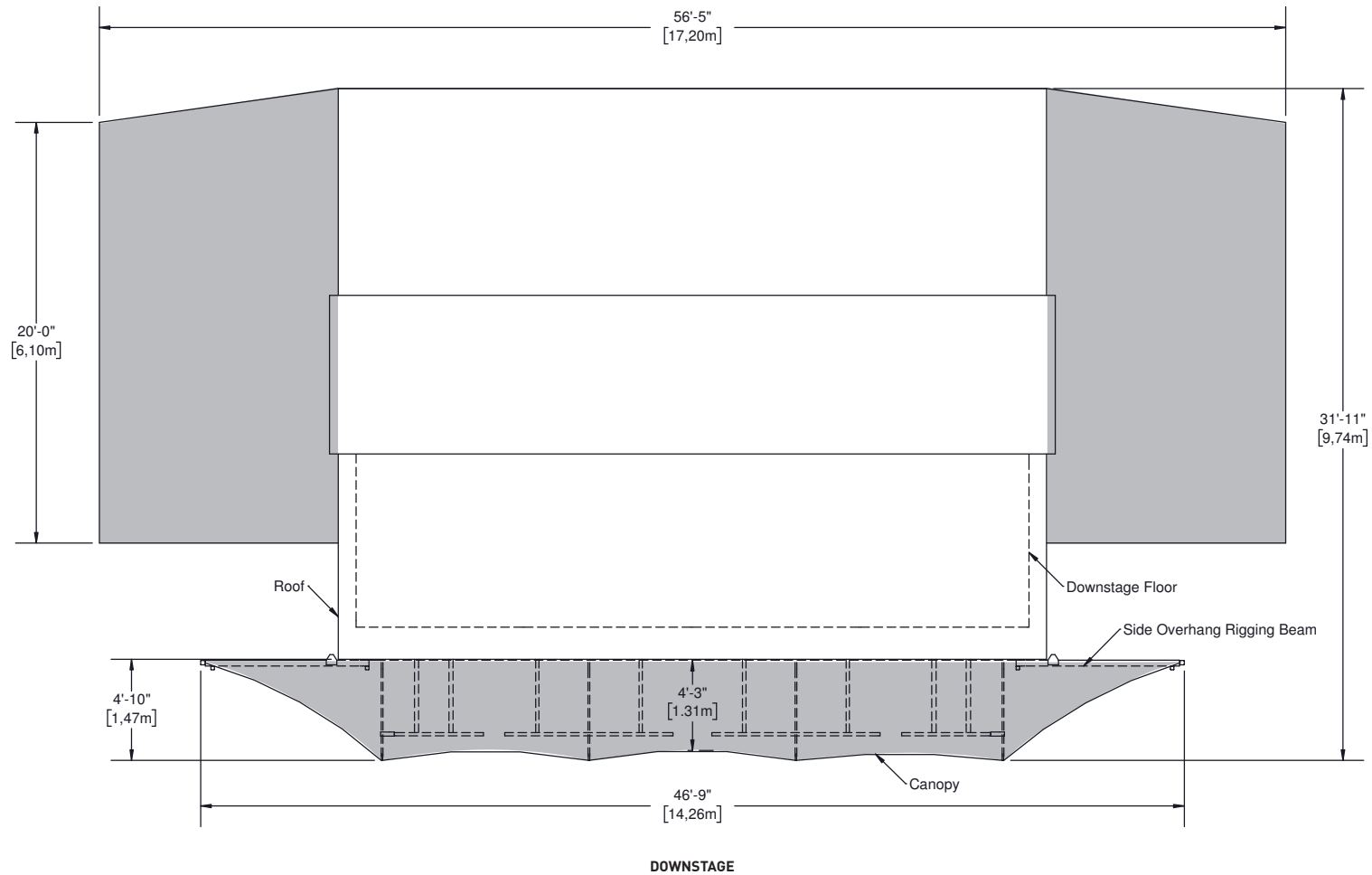

WINDWALL

Drawings may show stage equipped with optional accessories. May be sold separately.

© 2020 - All rights reserved, Stageline Mobile Stage Inc. Any and all forms of adaptation or reproduction of this document including the plans and drawings, in whole or in part, are strictly forbidden without the written authorisation of Stageline Mobile Stage Inc. Mass may vary depending on options. Technical specifications may change without notice. Stage specifications are subject to change without notice. Figures are nominal.

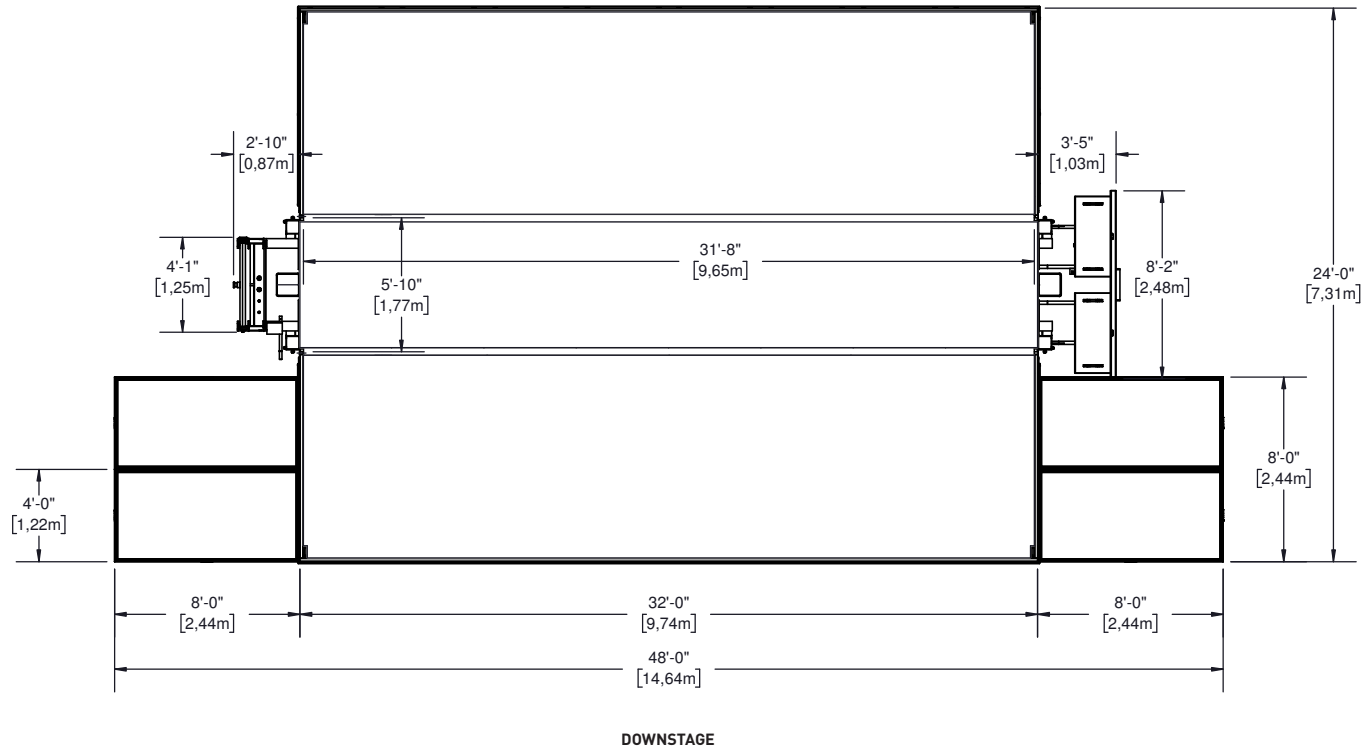

CAPACITY: 125lbs/ft<sup>2</sup> (610kg/m<sup>2</sup>)

Drawings may show stage equipped with optional accessories. May be sold separately.

© 2020 - All rights reserved, Stageline Mobile Stage Inc. Any and all forms of adaptation or reproduction of this document including the plans and drawings, in whole or in part, are strictly forbidden without the written authorisation of Stageline Mobile Stage Inc. Mass may vary depending on options. Technical specifications may change without notice. Stage specifications are subject to change without notice. Figures are nominal.

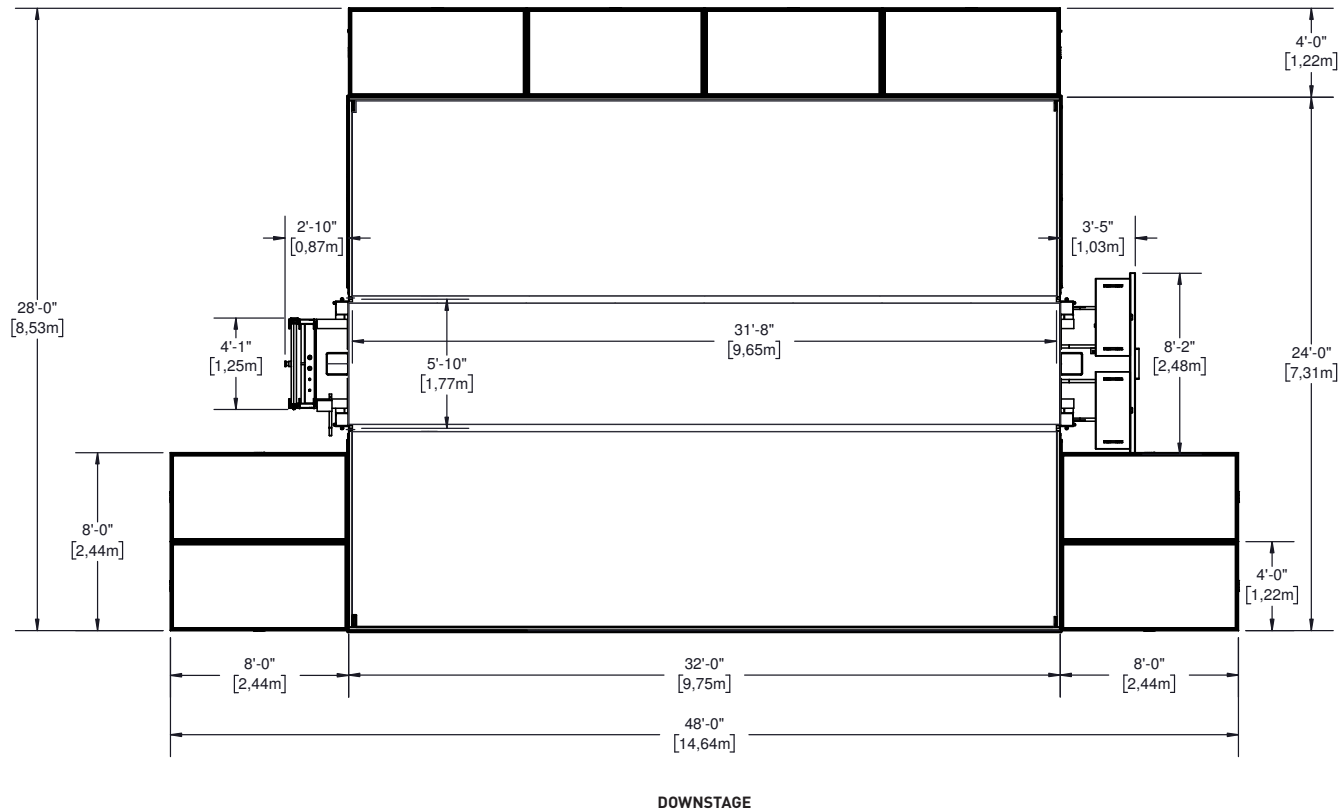

CAPACITY: 125lbs/ft<sup>2</sup> (610kg/m<sup>2</sup>)

Drawings may show stage equipped with optional accessories. May be sold separately.

© 2020 - All rights reserved, Stageline Mobile Stage Inc. Any and all forms of adaptation or reproduction of this document including the plans and drawings, in whole or in part, are strictly forbidden without the written authorisation of Stageline Mobile Stage Inc. Mass may vary depending on options. Technical specifications may change without notice. Stage specifications are subject to change without notice. Figures are nominal.

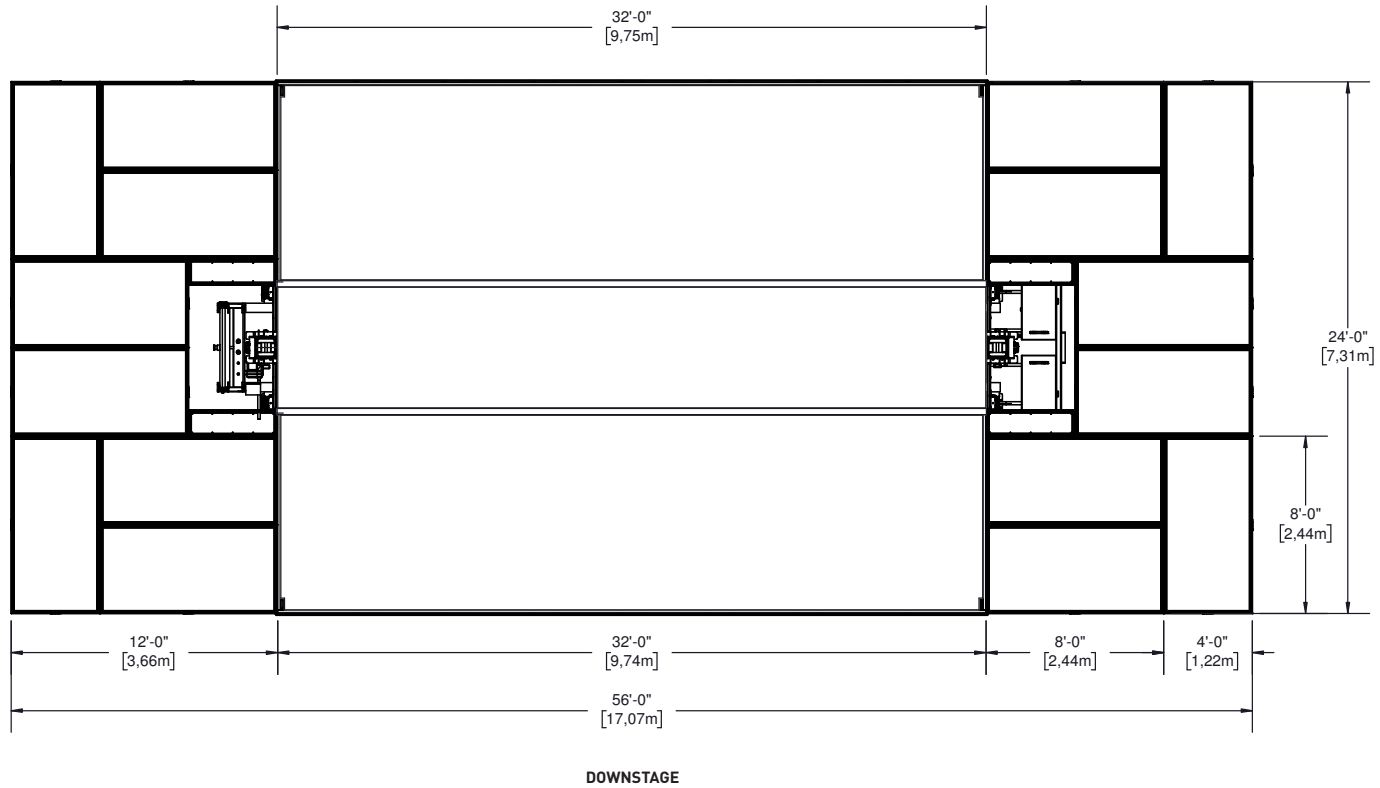

CAPACITY: 125lbs/ft<sup>2</sup> (610kg/m<sup>2</sup>)

Drawings may show stage equipped with optional accessories. May be sold separately.

© 2020 - All rights reserved, Stageline Mobile Stage Inc. Any and all forms of adaptation or reproduction of this document including the plans and drawings, in whole or in part, are strictly forbidden without the written authorisation of Stageline Mobile Stage Inc. Mass may vary depending on options. Technical specifications may change without notice. Stage specifications are subject to change without notice. Figures are nominal.

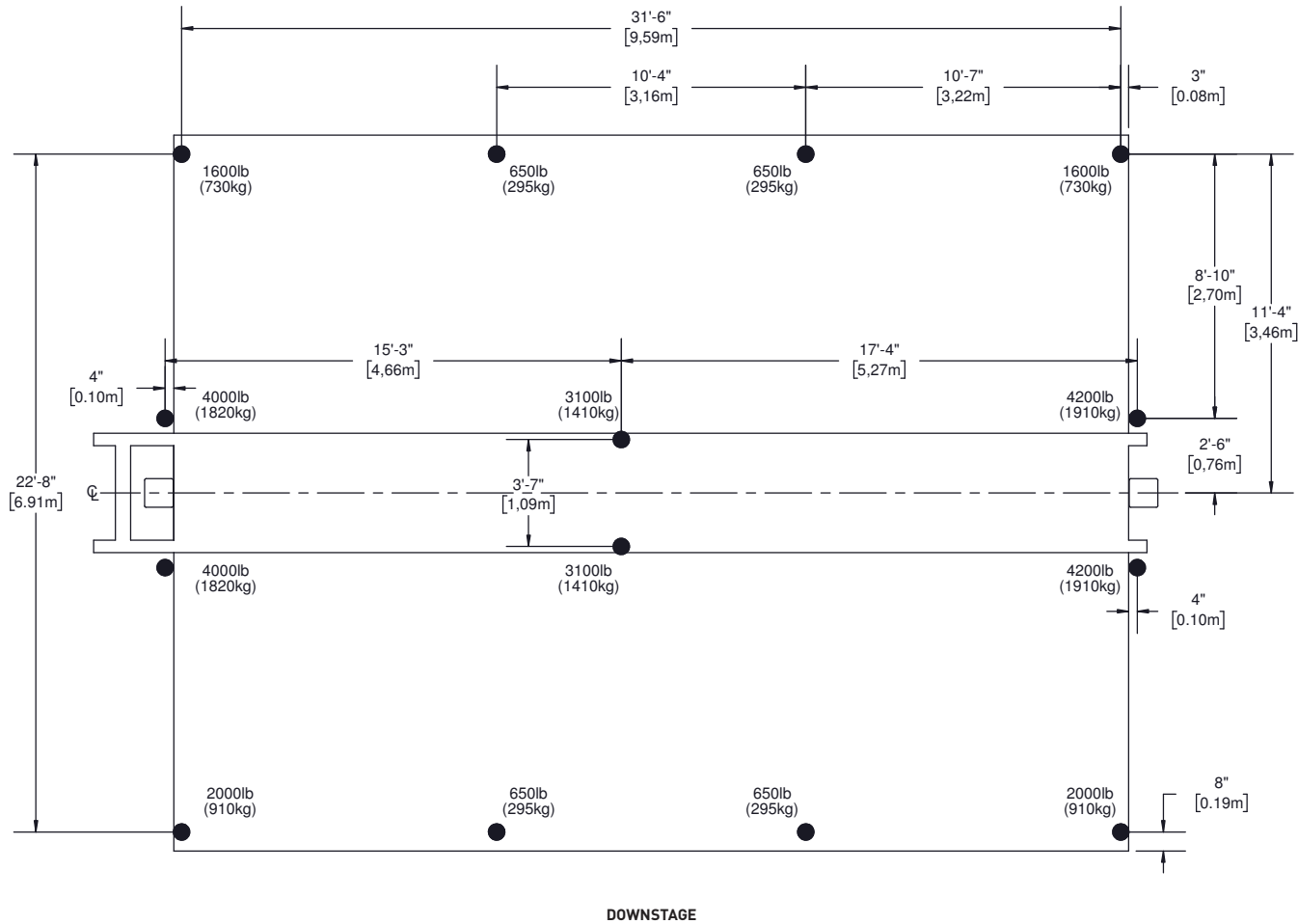

● FLOOR STABILIZERS, EXTENSIONS AND LEVELLING JACKS

Drawings may show stage equipped with optional accessories. May be sold separately.

© 2020 - All rights reserved, Stageline Mobile Stage Inc. Any and all forms of adaptation or reproduction of this document including the plans and drawings, in whole or in part, are strictly forbidden without the written authorisation of Stageline Mobile Stage Inc. Mass may vary depending on options. Technical specifications may change without notice. Stage specifications are subject to change without notice. Figures are nominal.

### Standard Configurations

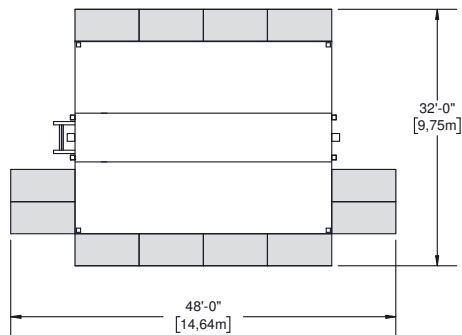
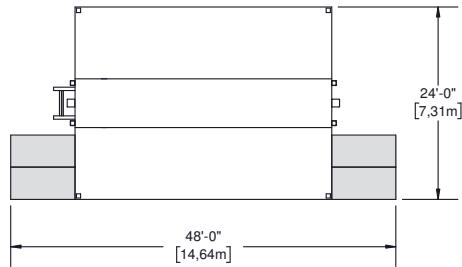
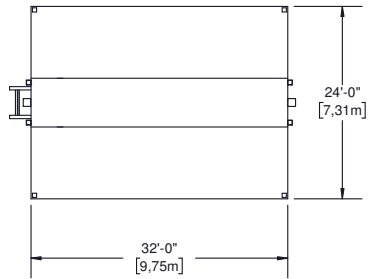

### Covered Wings Configurations

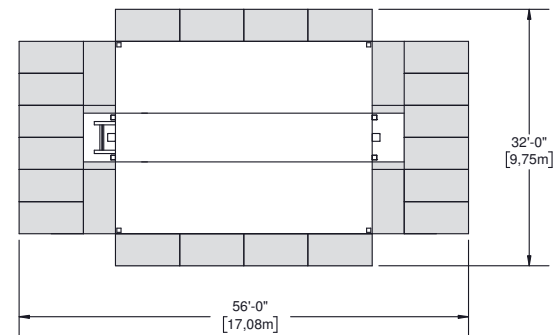
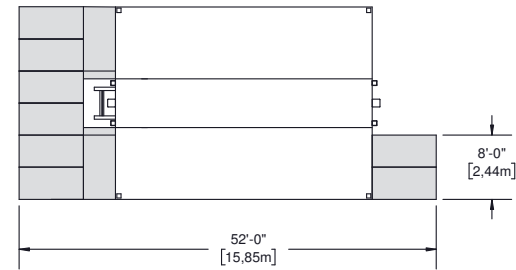
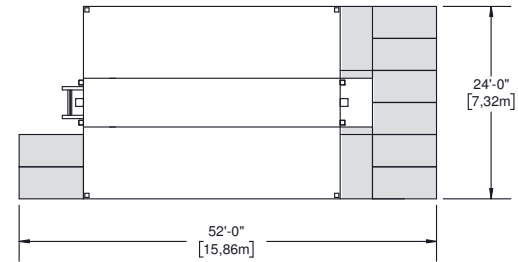

PLATFORMS

Drawings may show stage equipped with optional accessories. May be sold separately.

© 2020 - All rights reserved, Stageline Mobile Stage Inc. Any and all forms of adaptation or reproduction of this document including the plans and drawings, in whole or in part, are strictly forbidden without the written authorisation of Stageline Mobile Stage Inc. Mass may vary depending on options. Technical specifications may change without notice. Stage specifications are subject to change without notice. Figures are nominal.



**A THOROUGH UNDERSTANDING OF THE INTER-RELATED LOADINGS SHOWN IN THIS RIGGING PLAN IS NEEDED IN ORDER TO SAFELY USE THIS MOBILE STAGE ROOF AND TAKE FULL ADVANTAGE OF THE MANY RIGGING OPPORTUNITIES IT OFFERS.**

This mobile stage roof offers a variety of rigging options with regard to load capacity, placement and type.

There are rigging pipes, trusses, roof rigging points and side overhang rigging beams.

This rigging plan locates and defines these rigging features, includes load capacity for each and describes maximum combinations of loads amongst features.

Take note of exclusions, maximum sub-totals in a group, load balance requirements, maximum lifting capacity of roof and maximum rigging load on roof.

The maximum load on the roof is less than the sum of the maximum load on each rigging feature.

**Refer to Operator's Manual for procedures in regards to proper setup and setup methods of the stage and its options.**

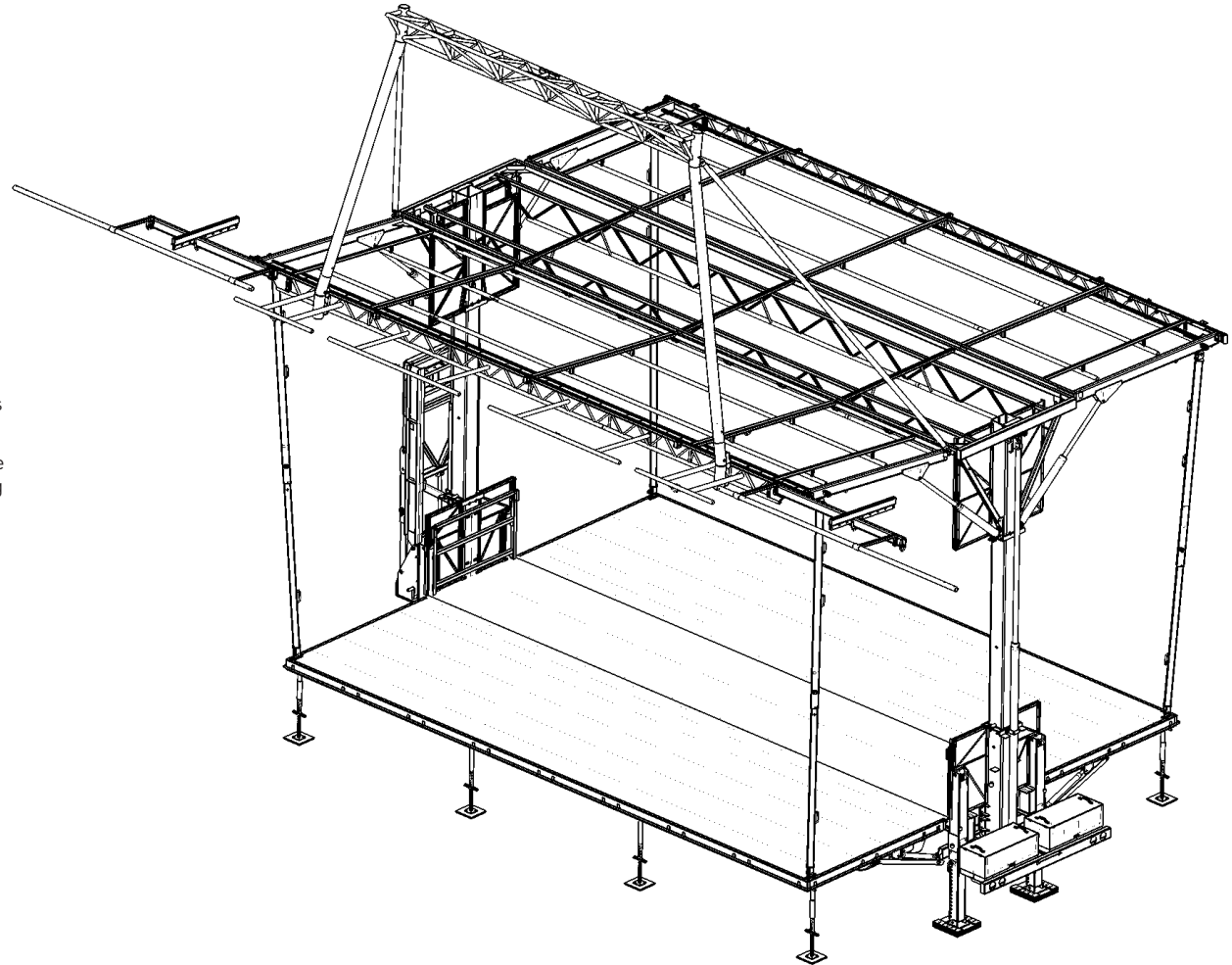

The information contained in the current document is final and must be considered as such. They are derived from design briefs and summarized to help the user plan rigging configurations safely. It is therefore mandatory that the user follows and respects the capabilities and limitations described herein. Overloading of stage components above their specified capacity may result in structural failure, equipment damage, injury or death. Stageline cannot be held responsible if the user, himself or subcontractors under his supervision, derogate from this document and/or the approved rigging plan. If a desired configuration cannot meet these requirements, the user must contact Stageline to analyse the case and obtain further instructions. Special restrictions and limitations may apply.

Certain authorities may require that a rig configuration plan, signed and sealed by a recognized member of a professional body, be available to allow the stage to be setup on their territory. This document was not intended to and cannot be used or considered as an official document or certificate to serve this purpose. Contact responsible authorities or Stageline for details.

**Drawings may show stage equipped with optional accessories. May be sold separately.**

© 2020 - All rights reserved, Stageline Mobile Stage Inc. Any and all forms of adaptation or reproduction of this document including the plans and drawings, in whole or in part, are strictly forbidden without the written authorisation of Stageline Mobile Stage Inc. Mass may vary depending on options. Technical specifications may change without notice. Stage specifications are subject to change without notice. Figures are nominal.

### RIGGING RESTRICTIONS

- **MAXIMUM LOAD BEARING CAPACITY:** 18000 lb (8391 kg). All corner posts must be installed and pinned, and telescopic columns pinned and secured.
- Total load of P14 to P17 on each side must not exceed 2225 lb (1009 kg) once all corner posts have been installed and lateral banners are installed. Capacity can be increased to 2500 lb (1134 kg) if all corner posts are installed and lateral banners are not installed.
- Never load downstage T2, P12 and P13 when using screen support.
- Maximum load capacity of the screen support is 4500 lb (2040 kg).
- Load on P12 FOHs must be uniformly distributed, with a maximum load of 350 lb (159 kg).
- Load on P13 FOHs must be concentrated at steel hook (location shown on diagram).
- Total load on both P12s and P13s must not exceed 1500 lb (680 kg).
- Do not load more than 30 lb/lin. ft (45 kg/lin. m) per rigging pipe.
- Never use rigging pipes concurrently with P11s on a given roof panel.
- T1 and T2 trusses may be used as rigging bars, i.e. with a distributed load of 30 lb/lin. ft (45 kg/lin. m).

### LIFTING RESTRICTIONS

- **MAXIMUM ROOF LIFTING CAPACITY:** 12000 lb (5443 kg).
- Maximum asymmetric load difference between downstage and upstage roof must not exceed 2000 lb (907 kg) including loads on T1 trusses.
- When lifting, make sure loads are evenly divided between right and left side of roof.
- Raise screen only when roof is lifted with corner posts and telescopic columns pinned and secured.

### NOTES:

- Outside diameter of rigging bars and of lower chord of trusses is 2" (5 cm).
- Distance between rigging pipe and roof is 4" (10 cm).
- Line array rigging beams are reversible.

\* Optional items, see stage specifications.

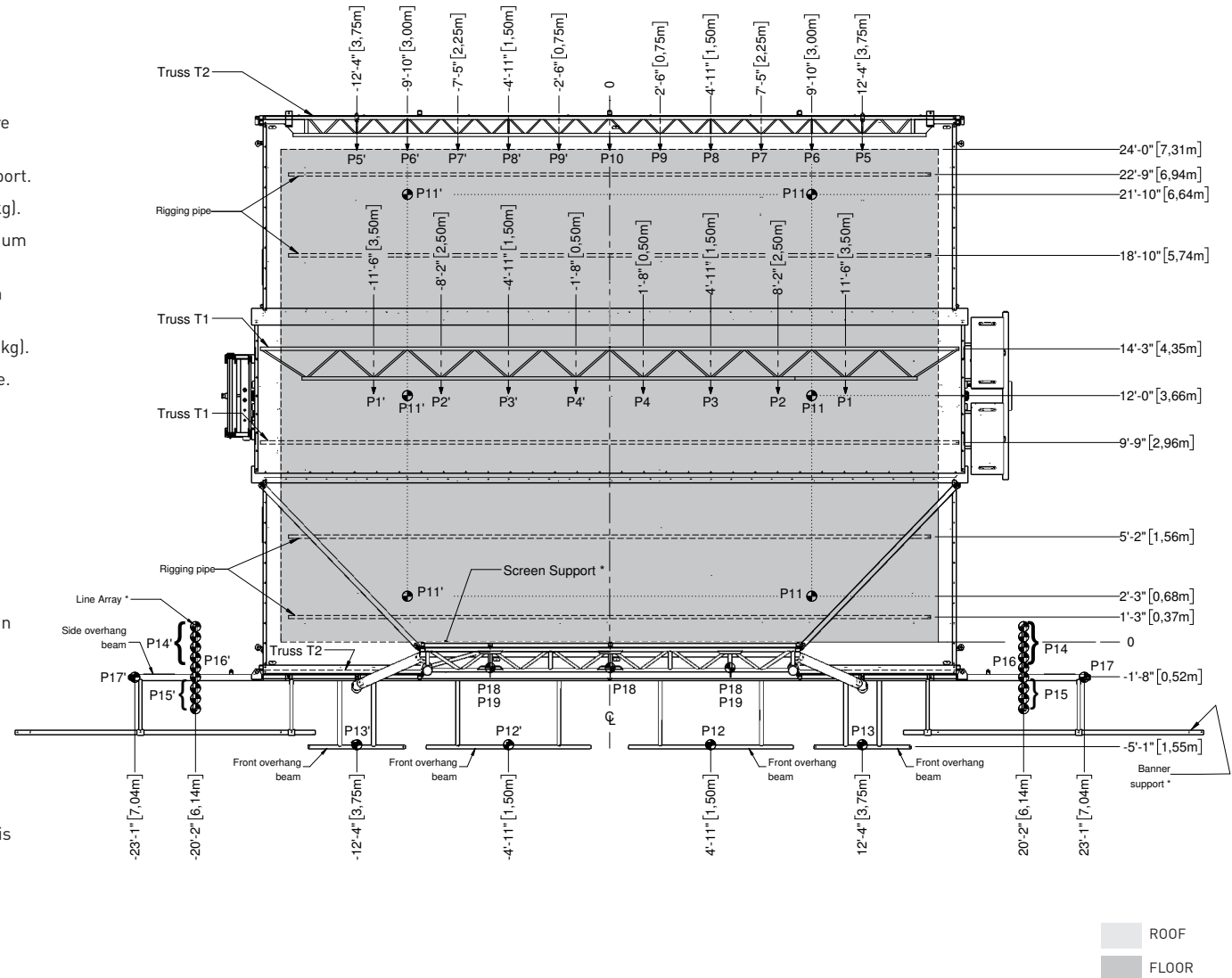

Drawings may show stage equipped with optional accessories. May be sold separately.

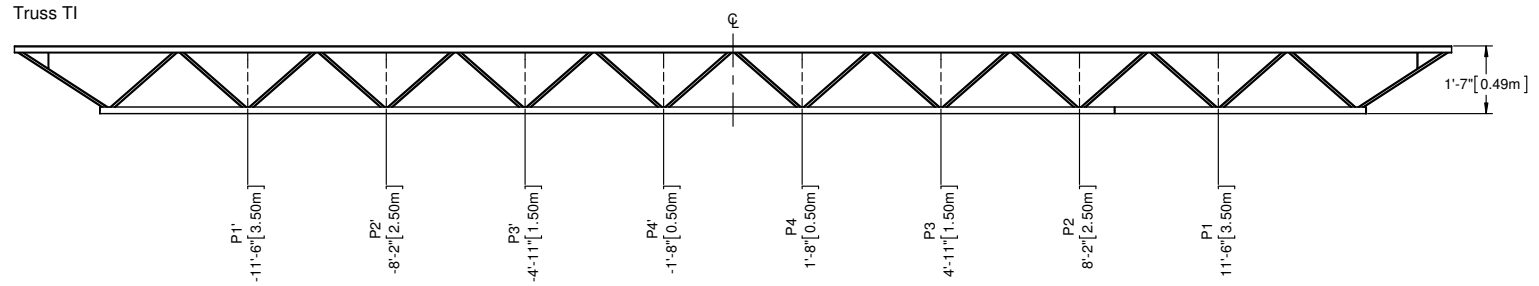

$$\text{Truss T1}^{**}: \frac{\text{Load P1}}{\text{Capacity P1}} + \frac{\text{Load P2}}{\text{Capacity P2}} + \frac{\text{Load P3}}{\text{Capacity P3}} + \frac{\text{Load P4}}{\text{Capacity P4}} \leq 1.00$$

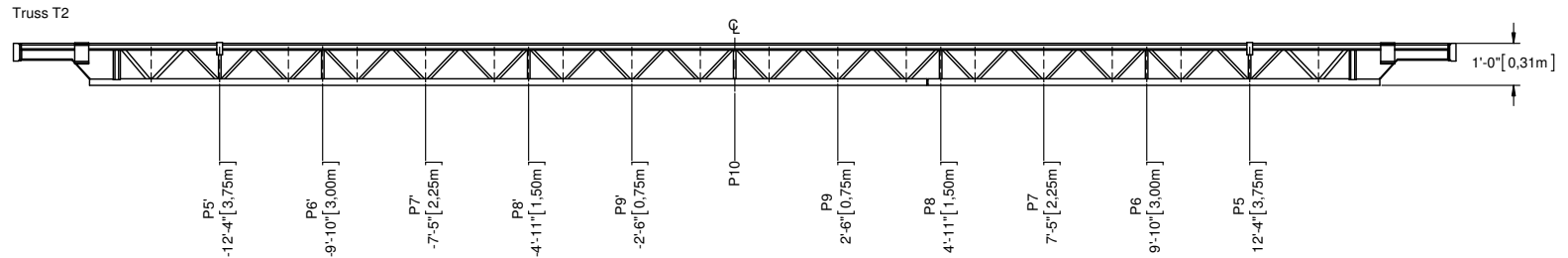

$$\text{Truss T2}^{**}: \frac{\text{Load P5}}{\text{Capacity P5}} + \frac{\text{Load P6}}{\text{Capacity P6}} + \frac{\text{Load P7}}{\text{Capacity P7}} + \frac{\text{Load P8}}{\text{Capacity P8}} + \frac{\text{Load P9}}{\text{Capacity P9}} + \frac{\text{Load P10}}{\text{Capacity P10}} \leq 1.00$$

MAXIMUM LOAD CAPACITY								
Point No.	Lbs	Kg	Point No.	Lbs	Kg	Point No.	Lbs	Kg
P1	1000	454	P9, P10	500	227	P18 *	1500	680
P2	750	340	P11	1000	454	P19 *	2250	1020
P3	600	272	P12	350	159			
P4	500	227	P13	750	340			
P5, P6	1000	454	P14 *, P15 *	2000	907			
P7	750	340	P16	2500	1134			
P8	600	272	P17	2000	907			

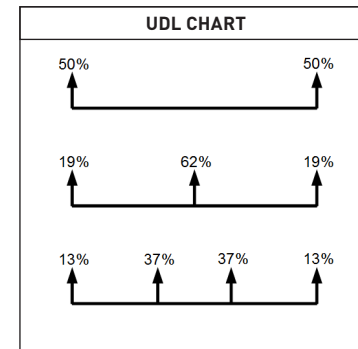

\* Optional items, see stage specifications.

\*\* Valid for symmetric loads only. In other cases, contact Stageline for assistance.

Drawings may show stage equipped with optional accessories. May be sold separately.

© 2020 - All rights reserved, Stageline Mobile Stage Inc. Any and all forms of adaptation or reproduction of this document including the plans and drawings, in whole or in part, are strictly forbidden without the written authorisation of Stageline Mobile Stage Inc. Mass may vary depending on options. Technical specifications may change without notice. Stage specifications are subject to change without notice. Figures are nominal.

### WHEN CALCULATING THE LOAD ON A SL260 TRUSS, USE FOLLOWING METHOD.

Each truss in the roof must be visualized as 2 trusses put together that share a center point.

**Example:** T2 on a SL260.

Points from left to right are P5', P6', P7', P8', P9', P10, P9, P8, P7, P6, P5. We will only verify loads on 1 side of the truss, Meaning P5 thru P10.

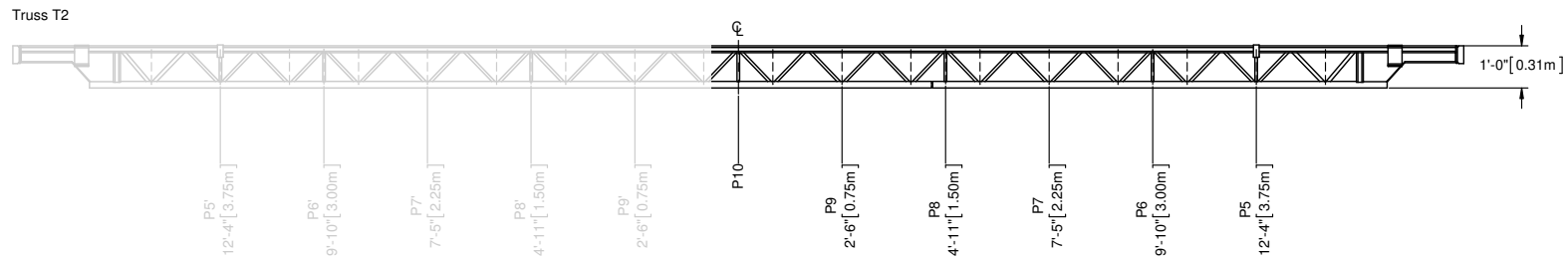

#### CALCULATION EXAMPLE #1:

1 lighting truss on 2 motors, total uniformly distributed weight of the truss is 1300lbs.

Each motor will be hung from the P5 points.

- $0.50 \times 1300$  (50% of weight, see UDL chart) / 1000 (the capacity of the P5 on the T2 truss) = 0.65
- $0.65 = 65\%$ , as 1.00 would equal 100 %.

**So the T2 truss is at 65 % of its total capacity.**

#### CALCULATION EXAMPLE #2:

1 lighting truss on 3 motors, total uniformly distributed weight of the truss is 1300lbs.

The motors will be hung from P5', P10, P5.

- **P5**  
 $0.19 \times 1300$  (19% of weight, see UDL chart) / 1000 (capacity P5) = 0.25, so this one point will use 25 % of the truss capacity.
- **P10**  
 $0.62 \times 1300$  (62% of weight, see UDL chart) / 500 (capacity P10) = 1.61, 161 % of truss capacity.

Now that we have the loads for both points, we add them together to determine the total load on the truss.

$$0.25 + 1.61 = 1.86$$

**So the T2 truss is at 186 % of its total capacity.**

#### CALCULATION EXAMPLE #3:

1 lighting truss on 4 motors, total uniformly distributed weight of the truss is 1300lbs.

The motors will be hung from P5', P8', P8 and P5.

- **P5**  
 $0.13 \times 1300$  (13% of weight, see UDL chart) / 1000 (capacity P5) = 0.17, so this one point will use 17 % of the truss capacity.
- **P8**  
 $0.37 \times 1300$  (37% of weight, see UDL chart) / 600 (capacity P8) = 0.8, 80 % of truss capacity.

Now that we have the loads for both points, we add them together to determine the total load on the truss.

$$0.17 + 0.8 = 0.97$$

**So the T2 truss is at 97 % of its total capacity.**