

# Walk Around

## B-25 Mitchell

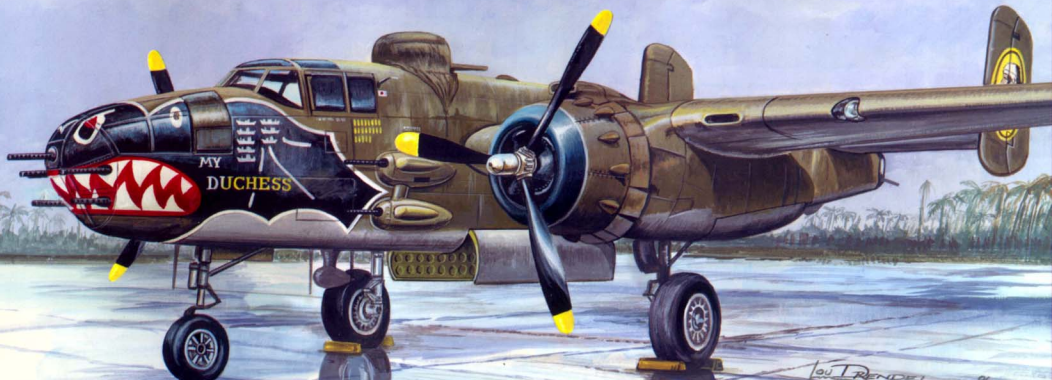

Walk Around Number 12  
squadron/signal publications

# Walk Around

By Lou Drendel

Color by Lou Drendel and Don Greer

Illustrated by Don Greer

## B-25 Mitchell



Walk Around Number 12  
squadron/signal publications

# INTRODUCTION

It was far and away the most popular medium bomber of World War II. It was named for the father of modern aerial bombardment, General Billy Mitchell, who sacrificed his career to prove that airplanes would have a significant impact on future wars. Nearly 10,000 B-25s were built during the war. Most were operated by the U.S. Army Air Corps, but versions were also flown by the US Navy and Marine Corps.

It fought in virtually every theater in World War II, performing a diverse series of missions, from medium altitude bombardment to low-altitude strafing, photo reconnaissance and as a VIP transport. It flew the first high-profile mission of the war — Jimmy Doolittle's daring daylight raid on Tokyo on April 18, 1942, which gave Americans a huge morale boost just when it was needed the most. Unlike many of its contemporaries, the B-25 soldiered on well after the war, surviving the change from US Army Air Corps to US Air Force, serving as a trainer and transport for nearly 20 years after the end of the war.

All of the B-25s illustrated on the following pages are C, D, G, H, or J models or modifications of these models. The details shown are for the most heavily produced versions, the H model gunship, and the J model bomber. The H model illustrated is the only flying B-25H in the world, undergoing an extensive and diligent restoration process. It is currently operated by a small group of enthusiasts who have dubbed themselves the "Weary Warriors".

The J model details are from a variety of the most widely produced version, which has survived in relatively large numbers, due in large part to its continued use by the USAF into the 1960s. The best example of a restored survivor is the magnificent restoration owned by the Cavanaugh Museum in Texas, dubbed "How Boot That?" This is an actual combat veteran which carries the same scheme it did 50 years ago during World War II.

The B-25 became the most widely used medium bomber of WW II because of its adaptability and durability. It flew a great variety of missions in all climates against all enemies and is one of the most widely recognized bombers of that era.

This book is a mixture of period photos illustrating the B-25 in military service, both wartime and post-war, and the many restored examples that have been brought back to flying status. Most of the detail photos are of restored Mitchell's. Some have been restored to a remarkable level of authenticity. Most have incorporated various degrees of compromise to modern operational realities. These are most evident in the area of avionics and in engine geometry. Where these differences occur, I have tried to point them out in the photo captions.

A last word on the obvious difference between the period photos and those of modern restorations. Most restorations are done to a level which would portray an airplane fresh out of the factory. The period photos are included to remind you that in operational service, these airplanes in no way resembled a factory-fresh airplane.

## Acknowledgements

As always, I am indebted to my good friend Norm Taylor for his generosity and unflinching support of all of my efforts. Most of the period photos in this book are from Norm's very extensive collection. Another long-time supporter and friend, Dave Mason, sent me his entire file on the B-25. Dave is a dedicated modeler and perennial IPMS award winner, so his input on these books has not been limited to photos. Peter Moll, Executive Director of the EAA Warbirds of America, loaned me photos from the EAA collection and some of the best shots of the Cavanaugh B-25 are courtesy of the talented Phil High, one of EAA's staff of ace aerial photographers. Nick Waters also contributed pictures of the Cavanaugh B-25. Ted Carlson, of Foto Dynamics, sent some great shots of restored B-25s. I am grateful to all for making this book possible.

**COPYRIGHT 1997 SQUADRON/SIGNAL PUBLICATIONS, INC.**

1115 CROWLEY DRIVE CARROLLTON, TEXAS 75011-5010

All rights reserved. No part of this publication may be reproduced, stored in a retrieval system or transmitted in any form by means electrical, mechanical or otherwise, without written permission of the publisher.

ISBN 0-89747-379-5

If you have any photographs of aircraft, armor, soldiers or ships of any nation, particularly wartime snapshots, why not share them with us and help make Squadron/Signal's books all the more interesting and complete in the future. Any photograph sent to us will be copied and the original returned. The donor will be fully credited for any photos used. Please send them to:

Squadron/Signal Publications, Inc.  
1115 Crowley Drive  
Carrollton, TX 75011-5010

Если у вас есть фотографии самолетов, вооружения, солдат или кораблей любой страны, особенно, снимки времен войны, поделитесь с нами и помогите сделать новые книги издательства Эскадрон/Сигнал еще интереснее. Мы перенесем ваши фотографии и вернем оригиналы. Имена приславших снимки будут сопровождать все опубликованные фотографии. Пожалуйста, присылайте фотографии по адресу:

Squadron/Signal Publications, Inc.  
1115 Crowley Drive  
Carrollton, TX 75011-5010

軍用機、装甲車両、兵士、軍艦などの写真を所持しておられる方はいらっしゃいませんか？どの国のものでも結構です。作戦中に撮影されたものが特に良いです。Squadron/Signal社の出版する刊行物において、このような写真は内容を一層充実し、興味深くすることができます。当方にお送り頂いた写真は、複写の後も返したいです。出版物中に写真を使用した場合は、必ず提供者のお名前を明記させていただきます。お写真は下記にご送付ください。

Squadron/Signal Publications, Inc.  
1115 Crowley Drive  
Carrollton, TX 75011-5010

**(Front Cover) "MY DUCHESS", a B-25J of the 499th Squadron, 345th Bombardment Group in the Philippines, 1945.**

**(Back Cover) "Barbie III", a B-25H of the 1st Air Commando Group, Burma, 1944.**



The recently completed NA-40 at Wright Field ready to undergo testing. The NA-40 was a high wing aircraft while the B-25 would be a mid-wing aircraft.

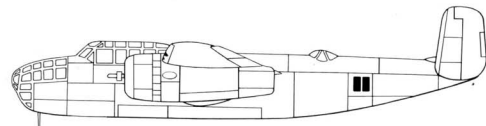

**NA-40**

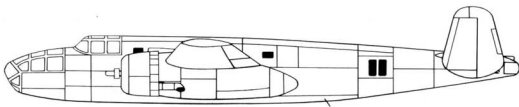

**B-25**

A B-25C (NA-82) fresh off the assembly line in 1942. The ventral turret was retracted into the fuselage, and appears as a slight bulge just under the aft end of the engine nacelle. This early C model was externally identical to the B model. B-25Bs, modified by removal of the ventral turret and addition of over 400 gallons of extra fuel in several tanks, were flown on the Doolittle raid. (North American via Norm Taylor collection)



A B-25C-5-NA (42-53357) of the 7th Photo Group at Mt. Farm Airfield, England during early 1944. Worthy of note is the exhaust configuration, one of several tried before the more efficient stacks version led to fairings on the engine cowling. (Robert Astrella via Norm Taylor Collection.)







The standard B-25J bomber nose configuration included one fixed, forward firing .50 caliber machine gun and one flexible mount machine gun operated by the bombardier. The large antenna on top of the nose is for modern radio equipment. (Dave Mason)



Some wartime aircraft, and many modern restorations, lack the fixed forward firing machine gun. While it carries USAF markings, it is armed like a WW II USAAF airplane (Mitchells were disarmed after the war.) Antennas under the nose are for modern avionics. (Lou Drendel)

Glazed noses were often equipped with a knockout plug in the event of severe fogging or icing. Another plug covers the hole left by the removal of a fixed gun. Cables and pulleys counterbalanced the nose gun.

Norden bomb sights were mounted behind a flat glass panel to prevent distortion. Machine gun ammunition was drawn from boxes along the starboard sidewall and fed to the gun via a feed chute to prevent jamming. (Lou Drendel)

A ball and socket mounted in a flat metal panel served to support the gun and its weight. The panel was equipped with its own wiper. (Lou Drendel)





The nose of the Cavanaugh Museum's B-25J has an oval metal panel over the position where an additional fixed forward-firing machine gun would be installed. (Nick Waters)

## Nose Hatch

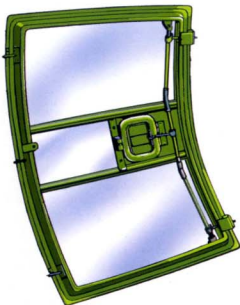

Interior



Exterior

B-25J "Show Me!", flown by the Missouri Wing of the Confederate Air Force, is equipped with two fixed forward-firing machine guns. (Lou Drendel)





Captain Grow and T/Sgt Galorte stand in front of "Shadrach", a B-25C that carries her mission scoreboard and a sinking ship on the side of her nose. (Maurice Guichard)

A formation of B-25Ds travels in concert with Martin B-26s on their way to a target. The B-25s lack side package guns and carry Medium Green 42 splotches on the wing leading and trailing edges.

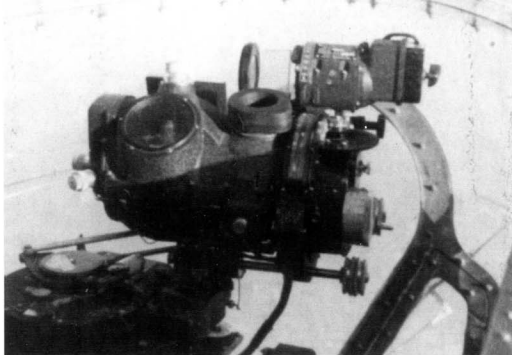

B-25s were equipped with Norden bomb sights, the best and most accurate bombsight of the war.

The Norden bombsight was installed in the extreme end of the nose where it could get an undistorted view through a flat glass panel.

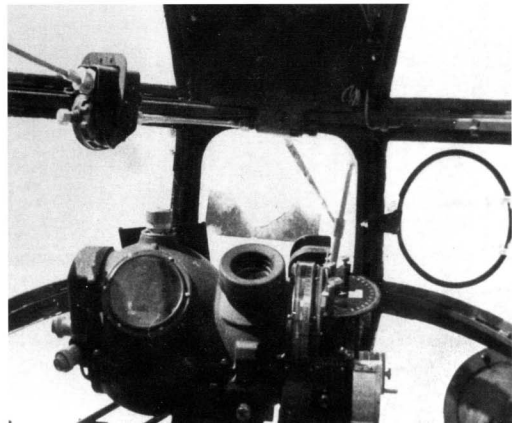

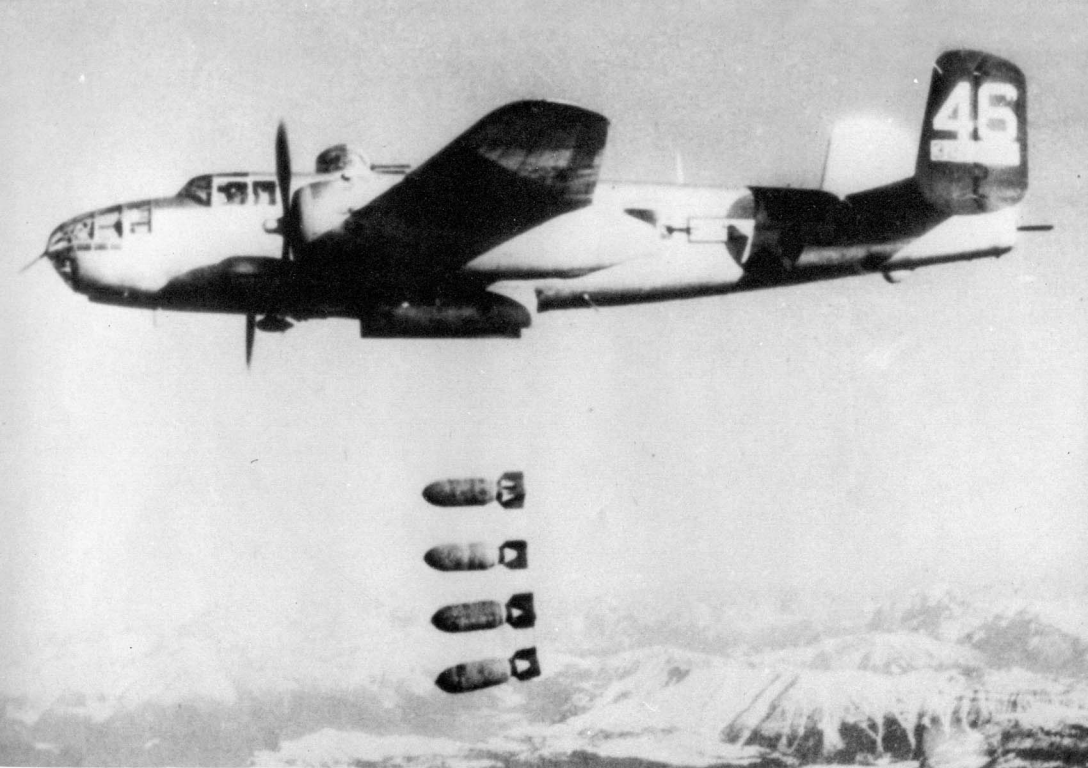

A B-25J of the 438th BS, 319 BG releases a load of 1000 lb. bombs over the Brenner Pass in December 1944. B-25s filled the role of level bomber, attack bomber, and straffer throughout the war. (via R.E. Casteel)





Solid 8-gun nose. The loop antenna mounted between the guns was not on the original version. The first gunships were glass-nosed C and D models packed with additional guns. As the nose was unmanned, the glazing was often painted over. (Lou Drendel)

## Lower Nose Assembly

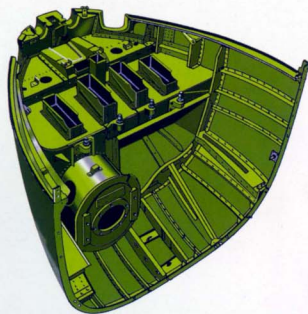

Nose of the well-restored B-25H "Barbie III". The H model was the ultimate strafing version, incorporating up to 10 forward-firing 50 caliber machine guns — four in the nose, four along the fuselage sides and two in the upper turret — and a nose-mounted 75mm cannon. (Lou Drendel)



## B-25H Nose Gun Installation



Ammunition belts lead to individual ammo boxes for each of the machine guns in the nose. Each box contained 400 rounds of 50 caliber ammunition. (Lou Drendel)



The clamshell nose fairing which enclosed the four machine guns is seen in the full open position for servicing the guns. (Lou Drendel)





The U.S. Army operated a number of B-25Gs in the submarine-hunting role, flying from bases in the Caribbean and along the U.S. coast. Many were painted in the sea-search scheme of Olive Drab over White. Early B-25Gs were armed with only two .50 caliber machine guns and the 75mm cannon in the nose. (North American)

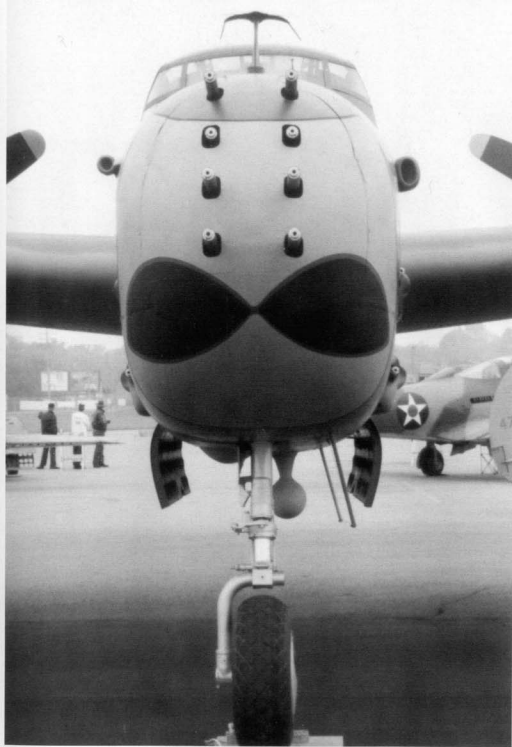

Front view of the 8-gun nose B-25J of the Kalamazoo Air Museum clearly shows the relative size and position of the airscoops on the sides of the nose. This is a very accurate non-flying exterior restoration, including the markings, which depict a B-25J of the 498th Bomb Squadron at Ie Shima in August, 1945. (Lou Drendel)

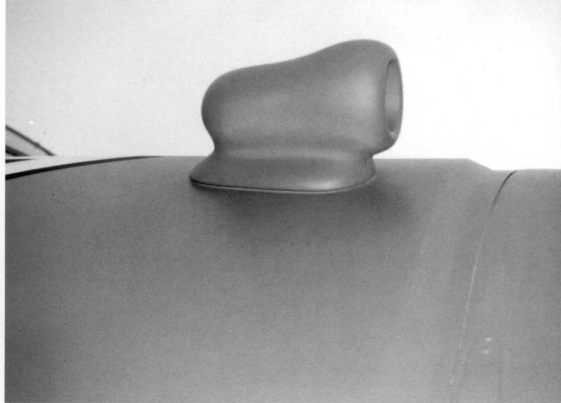

Air vents and scoops on the 8-gun nose of the Kalamazoo Air Museum B-25J. The scoop above is on the starboard side of the nose. The scoop below is on the port side. Airscoops and vents served to ventilate the crew spaces and prevent the buildup fumes and gases from the guns. Others were routed through a heater to warm the aircraft's interior when at high altitudes. (Lou Drendel)

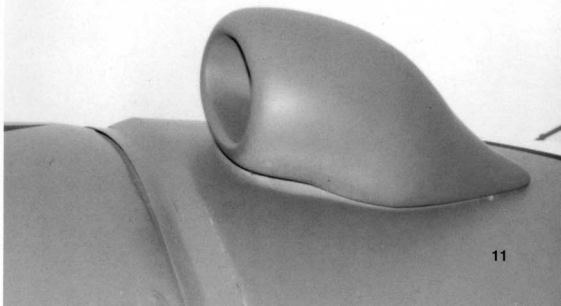



(Above) A Mitchell MK 3 of The Canadian Warplane Heritage at Toronto International Airport on 5 July 1996. (Lou Drendel)

(Below) A B-25J of the Yankee Air Force at Goshen, Indiana 8 August 1996. More highly polished than any warplane would have been, it also lacks a dorsal turret and wartime exhaust system. (Lou Drendel)





One of the most perfectly restored B-25Js in the world belongs to the Cavanaugh Flight Museum near Dallas, Texas. The restoration is as the actual airplane appeared in 1944, while assigned to the 308th Bomb Squadron, 310th Bomb Group. 44 28925 flew 85 combat missions in the MTO in World War II. The nose art painted on both the original and on the restoration was painted by Ray Kowalik, who used the same paint and paint kit to

paint the Cavanaugh restoration in 1995 as he used on this airplane in 1944! The commander of "How Boot That" for 71 of its missions in World War II was Lt. Harry Burmester, who was reunited with "his" B-25 at the EAA convention in Oshkosh in August, 1995. The magnificent restoration was performed by Aero Trader in Chino, California. (EAA photo by Phil High)



The second of 100 B-25G-5-NA (NA-92) serial number 42-64803 fresh off the assembly line. The stowed ventral turret is evident. National markings date this photo from 1942. External armor plate was added to both sides of the cockpit to protect the pilots. (Norm Taylor Collection.)

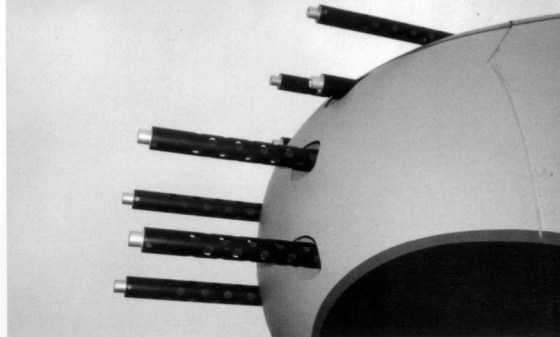
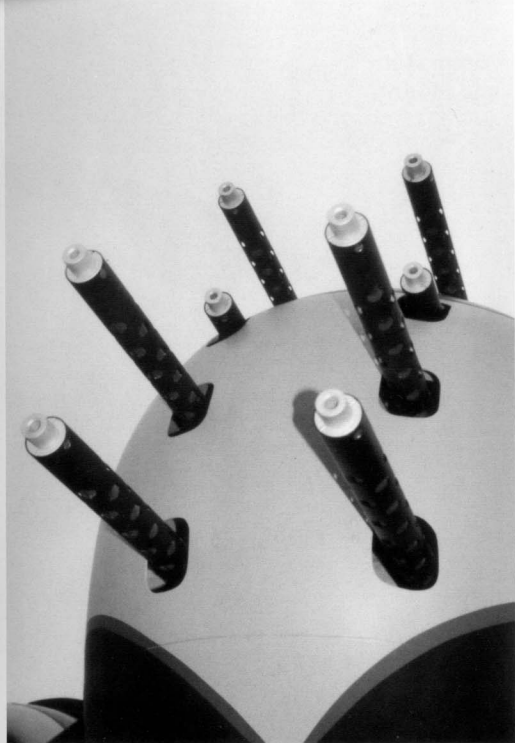

The initial 8-gun nose Mitchells were the result of field modifications in the Pacific Theater, where low altitude strafing was more effective than medium altitude bombing. Eventually, new B-25Js were manufactured in this configuration. (Lou Drendel)

## Nose Configurations

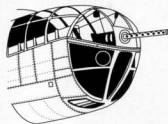

B-25B/C

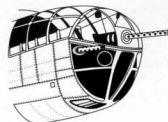

B-25C/D/J

B-25D Gunship

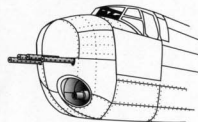
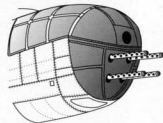

B-25H

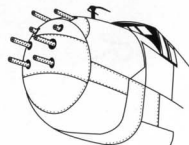

B-25J Gunship

The solid nose B-25J was the most heavily armed of all Mitchells, with eighteen 50 caliber machine guns and a bomb load of up to 4,000 lbs. Deliveries of the J model began in the spring of 1944 and by September almost all Js delivered to the Pacific were the factory installed 8-gun nose version. (Lou Drendel)



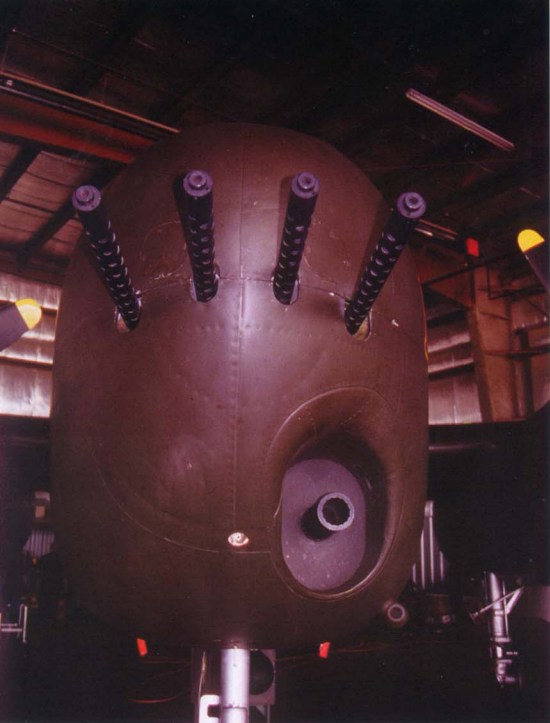

The G model carried two machine guns in the nose to augment the cannon. Another pair were added to the H model to augment the defensive fire needed because strafing with the cannon required a stable and predictable approach to the target. The tremendous volume of fire put out by the machine guns usually meant that enemy gunners kept their heads down. (Lou Drendel)

## 75mm Gun and Mount

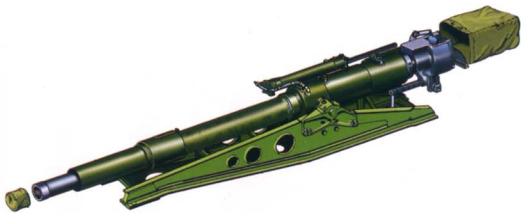

The 75mm T13E1 cannon carried by the B-25H was lighter than the original 900 lb. M-4 cannon carried in the B-25G. It fired a 3 inch, 15 lb. shell and was relatively accurate in spite of a less-than-flat trajectory. The gun recoiled 21 inches when fired. (Lou Drendel)



## 75mm Ammo Bin

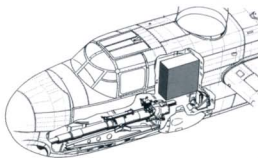
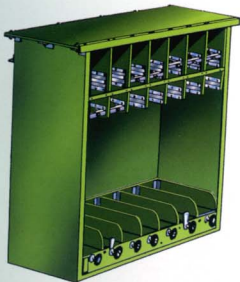

The top view of the B-25H nose shows a seldom-seen, slightly pointed shape. (Lou Drendel)



The business end of the 75mm cannon in the B-25H. The H model carried 23 rounds for the cannon, but being manually loaded usually only four shots per strafing run were fired. (Lou Drendel)



B-25D-20-NC serial number 41-30574 over Kansas in 1942. This is one of 2,290 Mitchells that rolled off the Kansas City production line during WW II. The exhausts have stained and bleached the paint. The paint on the fabric control surfaces has faded at a different rate than that of the painted metal surfaces. (USAF via Norm Taylor Collection.)

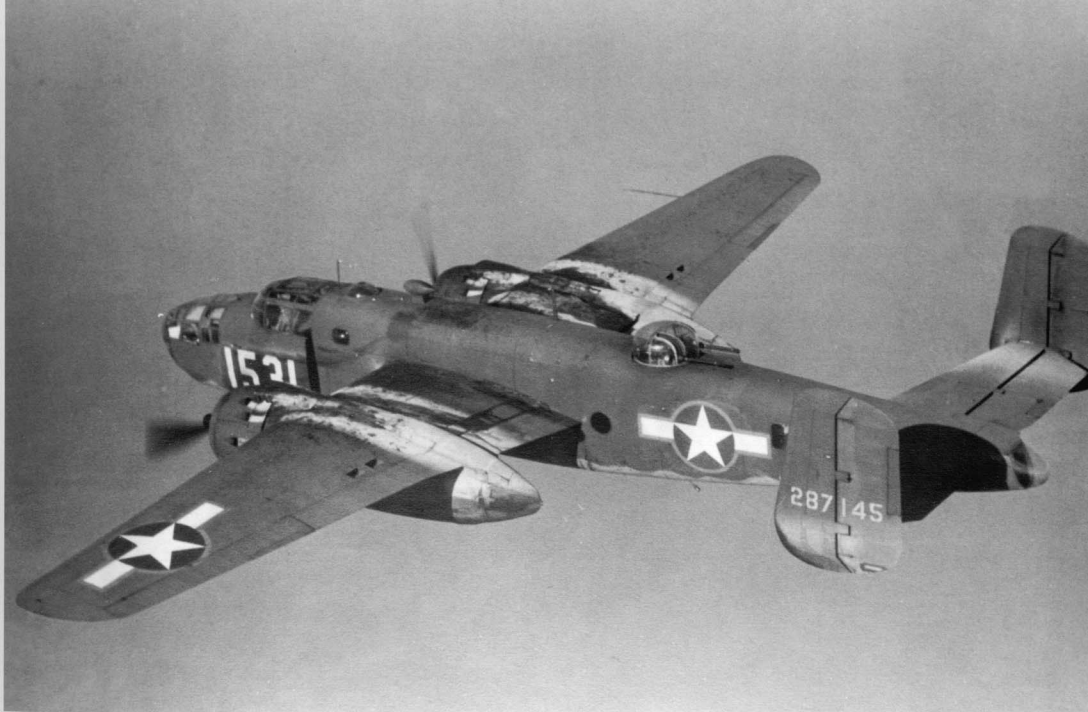

B-25D-25-NC (42-87145) of the 377th Bomb Squadron (M) of the 309th Bomb Group over Columbia Army Air Field, South Carolina in September 1943. This is the unit which supplied the Doolittle Tokyo Raiders. The effects of the hot exhaust gases reaches back to the vertical and horizontal flying surfaces, bleaching them to a pale gray-beige color. The aircraft also wears the red surround, mandated from June 1943 to September 1943, around the national insignia. (Norm Taylor Collection)



The USN and USMC also operated B-25 gunships using them against ships and shore installations. With the exception of some minor details, they were fairly similar to their U.S. Army counterparts and used the same weapons packages. Some late Marine B-25Gs also had a manned tail gun position with an overhead canopy. Due to their extensive over-water missions, the Navy and Marine's B-25Gs and Hs were camouflaged in the tri-color scheme of Sea Blue, Intermediate Sea Blue and White. In naval parlance, B-25s were known as PBJ-1s.



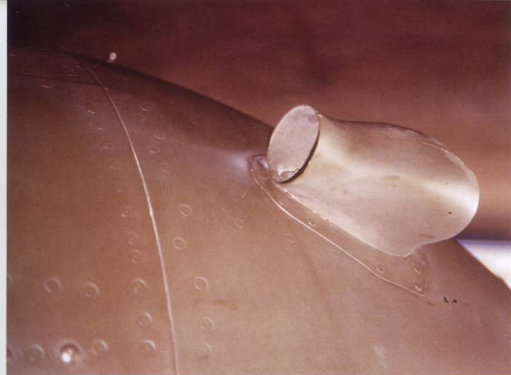

The air scoop on the starboard side of the B-25H nose. (Lou Drendel)



The port side of the canopy. Missing from this restoration is the metal armor panel in the lower half of the pilot's windscreen. (Lou Drendel)

Both pilots were provided a sliding side window for additional ventilation or in the event of extreme misting or icing. (Lou Drendel)

The view looking aft along the left side of the fuselage. A life raft hatch was placed along the upper fuselage in the event of ditching. The hatch could be released by the pilot or waist gunners. (Lou Drendel)

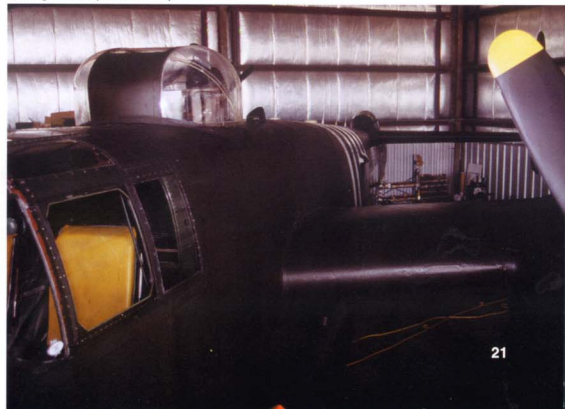





A B-25C-5-NA (42-43357) assigned to the 7th Photo Group, based at Mt. Farm Airfield, England in the Spring of 1945. It carries a local artists rendition of one of the more famous pinup poses of WW II. (Norm Taylor Collection.)

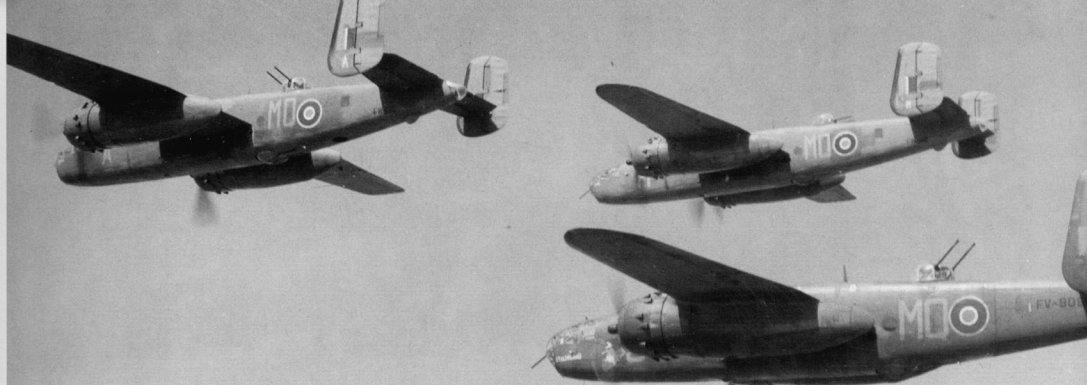

(Above) A formation of RAF 226 Squadron Mitchell IIs on their way to bomb railway yards in France in May 1944. The RAF operated over 850 B-25Cs and Ds as Mitchell IIs and B-25Js as Mitchell IIs primarily in the level bombing role. (Camberly)

(Below) A B-25C flies over the Midwestern U.S. on a training flight. The inner surface of the left rudder fabric covering appears faded, otherwise the aircraft is in a fairly clean condition. A football shaped fairing covers the Direction Finding antenna on the fuselage spine. The aircraft wears the U.S. insignia used from the Spring of 1942 through June of 1943. (Walt Holmes)

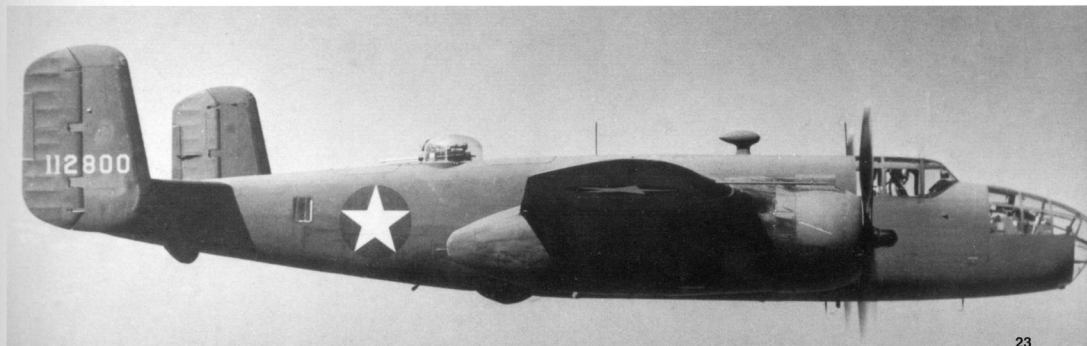



(Above) Camouflaged in Light Gull Gray over white, a B-25J at Jeffersonville, Indiana, 1994, carries post war USN utility squadron markings. B-25s saw extensive service after the war in the utility, training, and light transport roles. (Lou Drendel)

(Below) The B-25J of the Kalamazoo Aviation History Museum carries markings of the 498th Bomb Squadron, as it appeared on Ie Shima, August 1945. (Lou Drendel)



(Right) The first B-25 strafers were modified C/D models. The modifications were carried out under the direction of Major "Pappy" Gunn and Jack Fox in the Southwest Pacific at the 81st Air Depot in 1942. The fuselage gun packs were contained in one pod, with ammunition carried in the bomb bay. This replica is on a restored B-25, and is equipped with a strobe light to simulate firing at airshows. (Lou Drendel)



(Below Right) The B-25 gunships added .50 caliber machine guns to the fuselage sides in order to augment the nose guns. Initially, these were two guns covered with a single fairing. This configuration most often appeared on glass-nosed Cs and Ds. Later, twin fairings were added to the B-25 G, H and J gunships. The guns were bolted to the outside of the airframe. (Lou Drendel)

(Below) Top turret detail, looking aft from the left side of the nose. The top turret was moved to the Navigator's station in the B-25H and J, providing a broader field of fire and augmenting the forward-firing armament. (Lou Drendel)

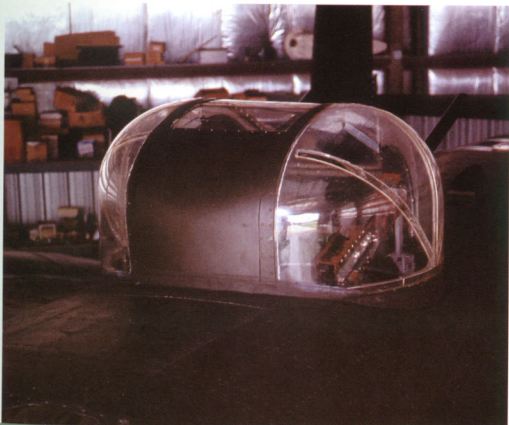

## B-25J Left and Right External Gun Packs

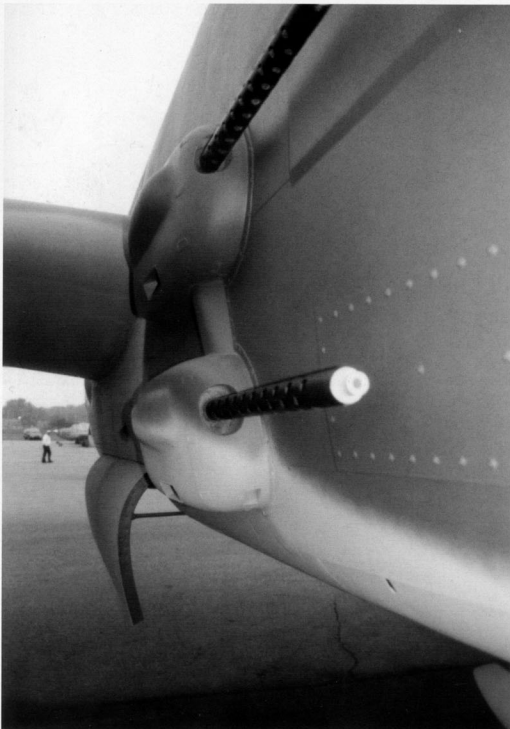

The guns were bolted to the aircraft frame. Cutouts in the fuselage skin allowed passage of the ammo feed and wiring. An additional panel riveted to the fuselage in front of the lower gun protected the fuselage from the muzzle blast. (Lou Drendel)

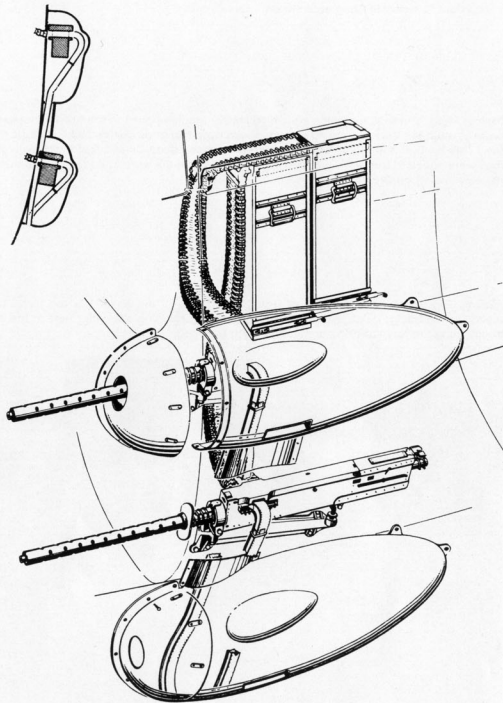



A B-25C, believed to be of the 500th BS, 345th BG, awaits its crew in New Guinea. The lower nose glazing has been altered to accept four additional nose guns. The remaining glazed area has been painted over. The aircraft is also equipped with the early style package guns on the fuselage sides as indicated by the single fairing over both weapons. Both crew hatches, with their retractable steps lowered, are open. Both main wheels are blocked with chocks connected by a rope for rapid removal.





Each gun was covered by a single fairing. Each fairing had a blister covering the shell ejection chute. Spent cartridges exited through the slot at the bottom of the fairing. (Lou Drendel)

"Pacific Princess" was one of several WW II warbirds which went aboard USS Carl Vinson in 1995 as part of a 50th anniversary celebration of the end of WW II. B-25s, Corsairs, Avengers, and a Bearcat were loaded aboard at Alameda, California, then transported to Hawaii. They launched offshore and flew to NAS Barbers Point, where they were head-quartered for a week of celebrations. (Dave Mason)

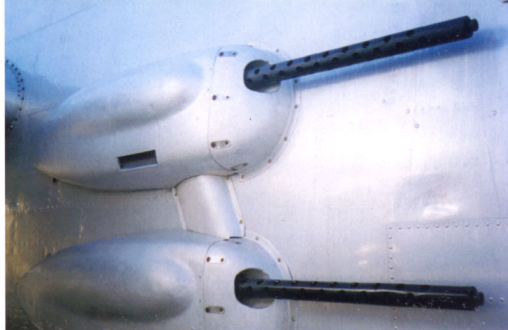

Five screws in front and three screws in back held the main fairing in place. The vertical fairing covers the upper gun's link chute. The link chutes for each gun joined together and exited at a common port at the front of the lower gun fairing. (Lou Drendel)

Each gun was provided with 400 rounds of ammunition held in boxes inside the fuselage. Suppressors were sometimes fitted to prevent flash blindness on night missions. (Dave Mason)





B-25J "In The Mood" on approach to NAF El Centro 11 March 1994. A Plexiglas dome covers the position of the dorsal turret. The B-25H and J had their DF footballs, when fitted, moved to the fuselage underside. (Ted Carlson/Fotodynamics)

The restored B-25J "Executive Sweet" takes off from Hawthorne Airport, California on 29 August 1993. The dorsal turret lacks the gun mounts, elevation and sighting mechanisms which would normally be visible through the turret's clear cover. (Ted Carlson/Fotodynamics)





A new B-25H, serial number 43-4448 and fresh out of the factory, sits on the North American ramp on 22 August 1944. A large fairing, covering a K24 camera, has been added to the nose. Cameras this large could take very detailed strike photos or could be used as a forward looking reconnaissance camera. (Norm Taylor Collection.)

"THE ALICE L" was a well-worn and disarmed combat veteran, assigned to the 486th Bomb Squadron, 340th Bomb Group at Columbia AAB, S.C. in 1945. Spots of fresh paint cover the patches placed over the holes left when the side gun blisters were removed. (B. Balogh via Norm Taylor Collection)





One can only guess at the mission of this civilian B-25J-15-NC, (44-28938) which carried civil registration N7946C at Merrill Field, Anchorage, Alaska, 26 May 1967. The original equipment DF football and wire antennas for the marker beacon (upper wire) and radio compass (lower wire) are still carried under the nose. These have been augmented by at least three modern whip antennas for VHF COM and a larger VOR antenna on top of the nose. (Norm Taylor)





B-25s employed tricycle landing gear. The nose gear, known as the auxiliary gear in USAAF parlance, was equipped with a 30 inch, 8 ply tire. The nose gear was not steerable but could caster up to 60 degrees left or right. The spoked wheels were often covered with a plate. (Lou Drendel)

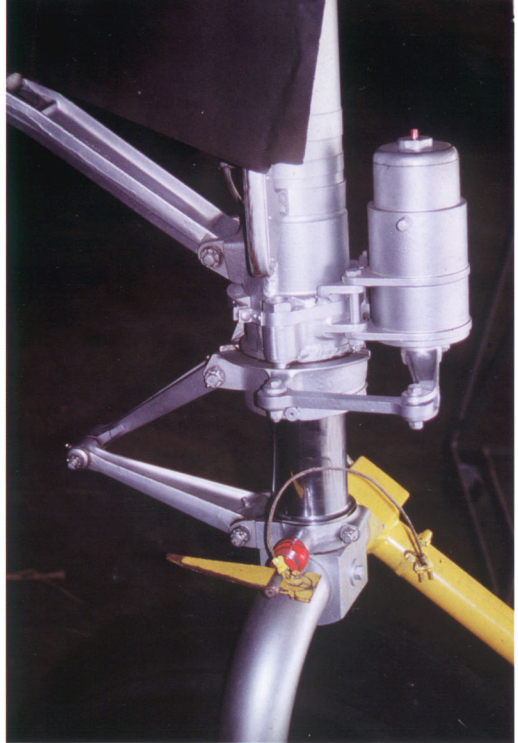

The cylindrical object on the strut was a shimmy damper designed to prevent the wheel from oscillating from side to side while rolling. The upper end of the wheel fork was hollow to allow insertion of a tow bar. (Lou Drendel)

## Nose Gear Components



## Nose Gear Doors



The nose gear strut was normally painted with a silver lacquer to prevent corrosion. Occasionally some struts, especially those up in the wheel well, were painted chromate green. Early B-25s used a smooth treaded tire. Later, block and diamond treaded tires were more commonplace. (Lou Drendel)



**B-25C Mitchell**

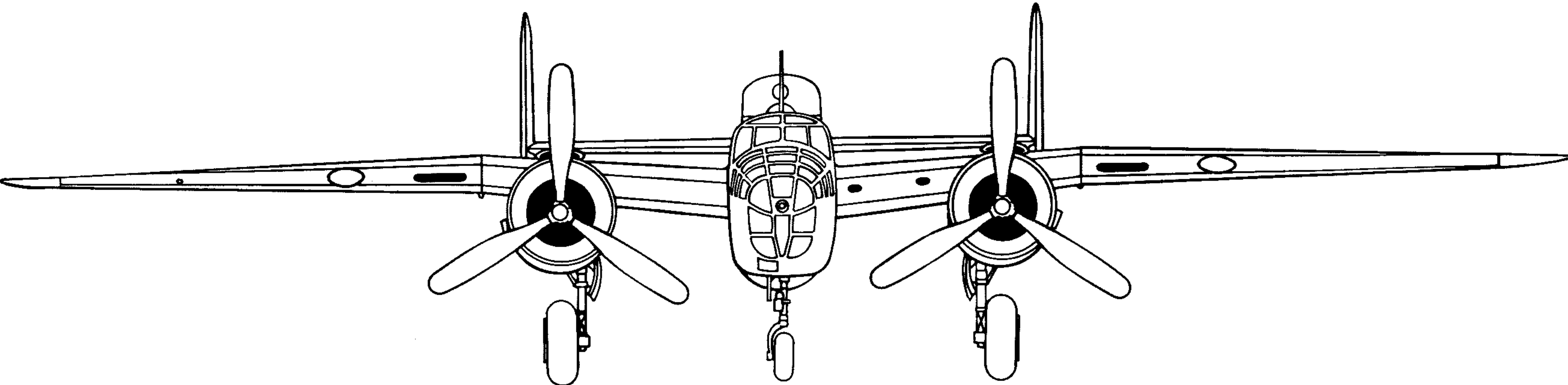
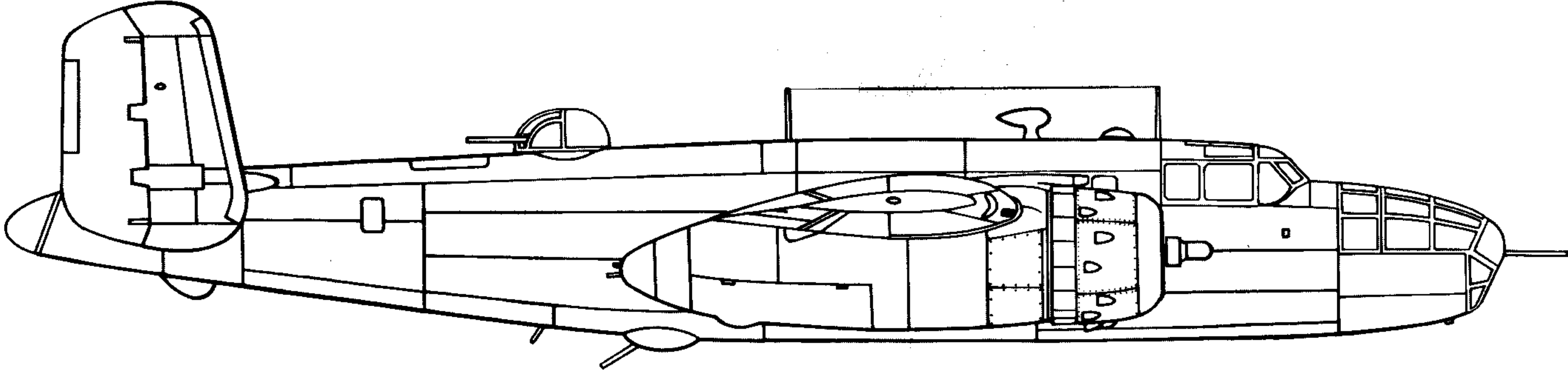
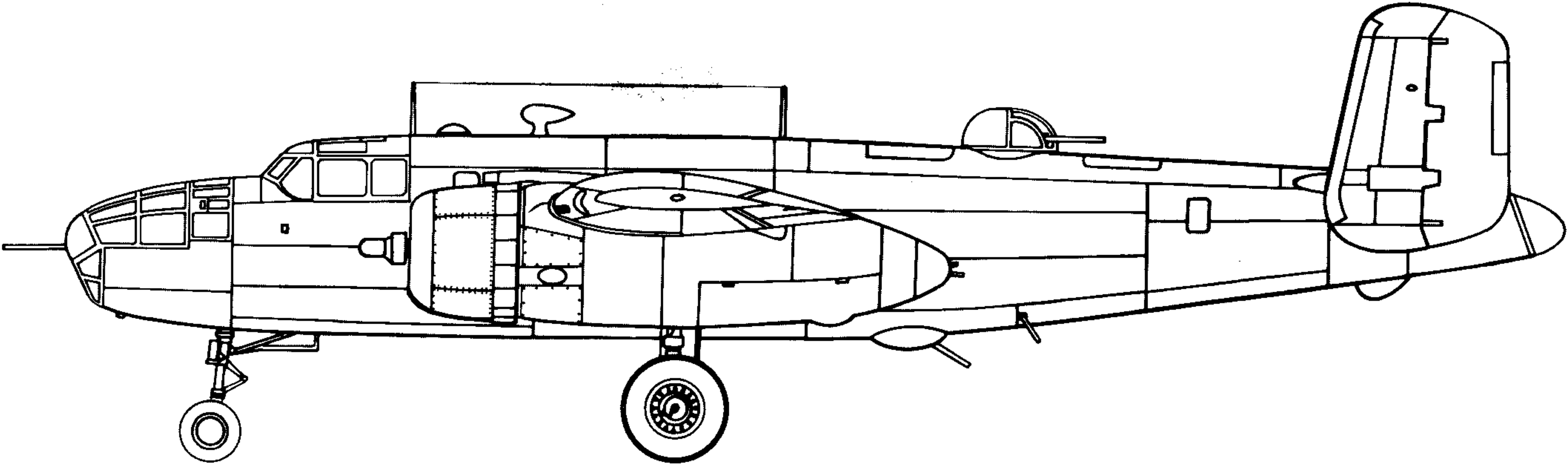

## B-25G Gunship

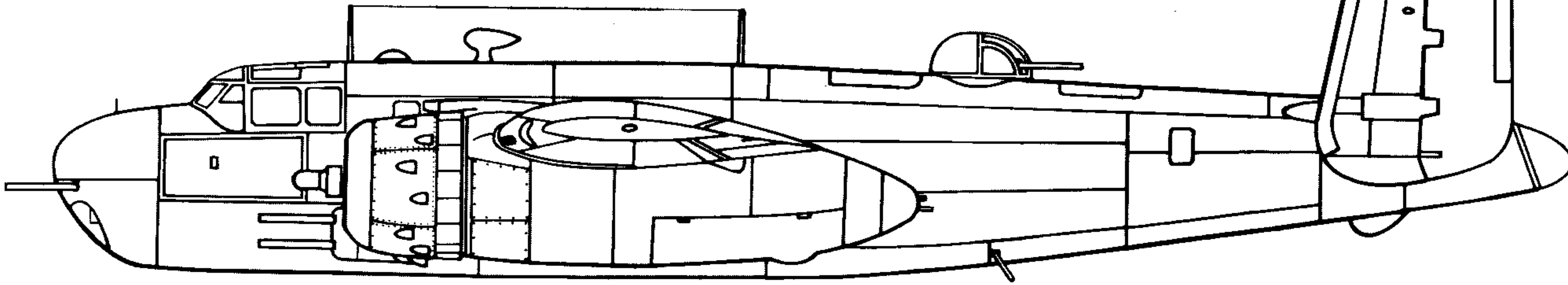

## B-25G Nose

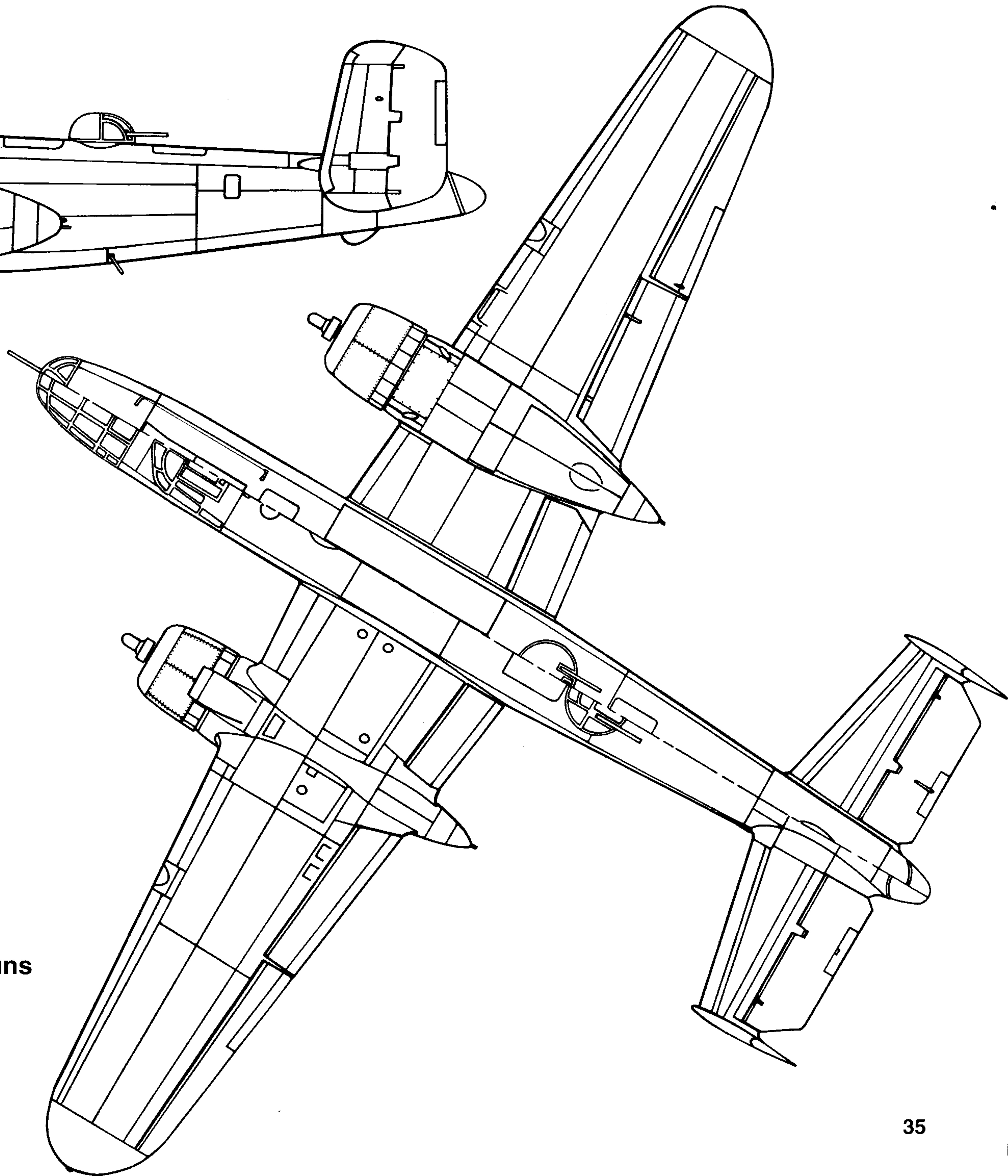
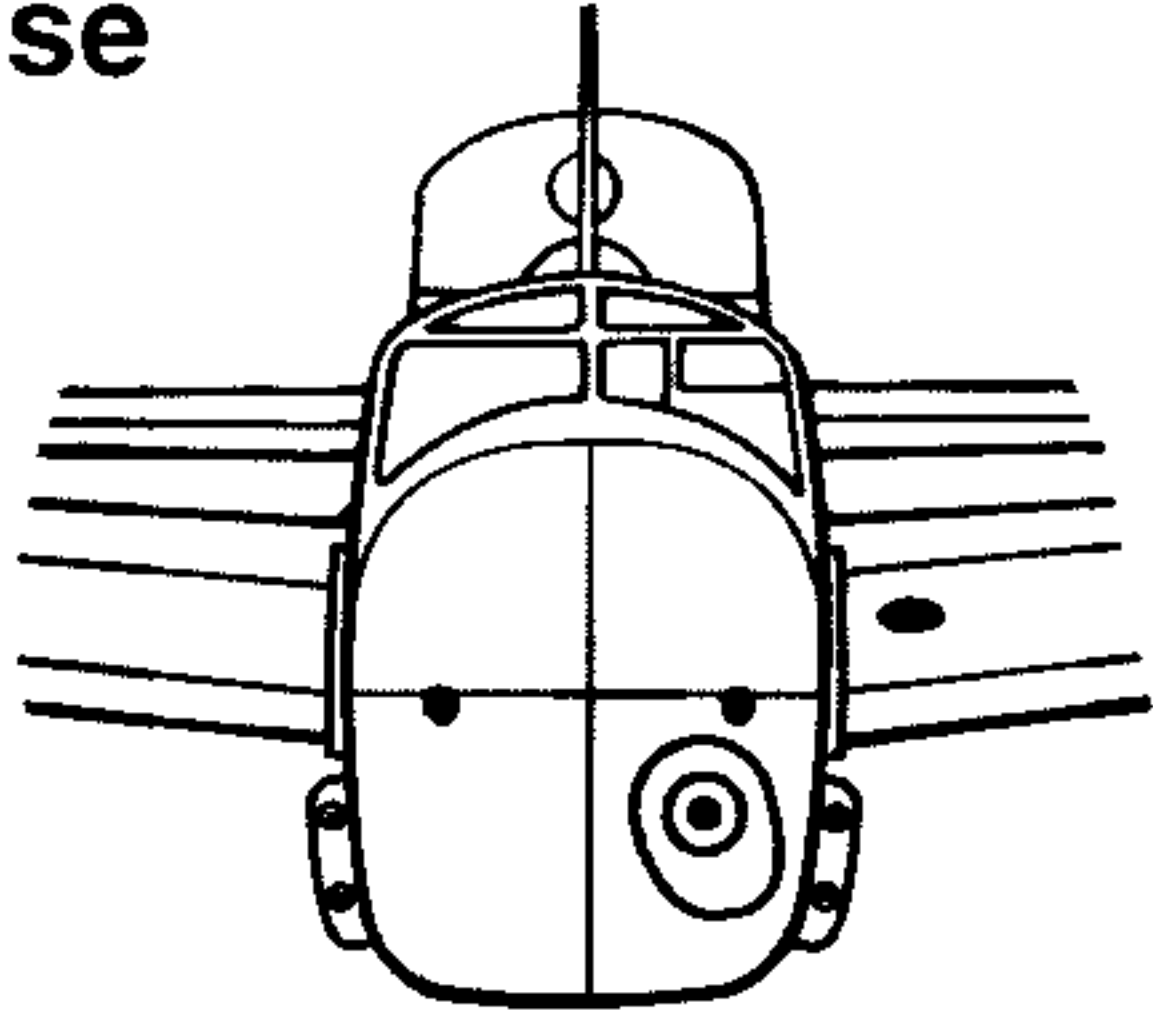

## B-25C Specifications

<b>Span:</b>	<b>67 feet, 7 inches</b>
<b>Length:</b>	<b>52 feet, 11 inches</b>
<b>Height:</b>	<b>15 feet, 10 inches</b>
<b>Gross Wt:</b>	<b>33500 lbs</b>
<b>Engines:</b>	<b>Wright R-2600-13</b>
<b>Crew:</b>	<b>5</b>
<b>Bomb Load:</b>	<b>3000 lbs</b>
<b>Armament:</b>	<b>6 x .50 Caliber Machine Guns</b>

## Main Landing Gear Components

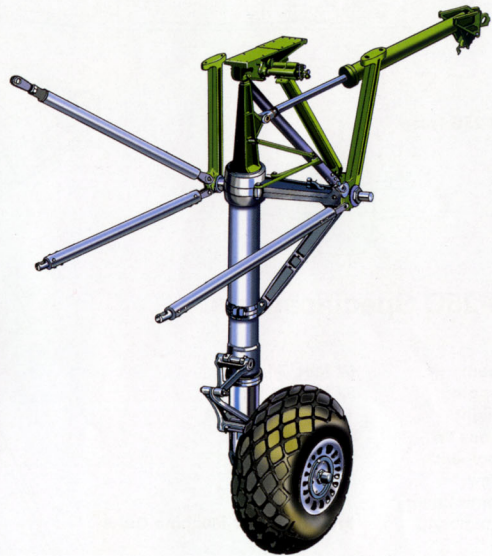

The B-25 landing gear is hydraulically operated. Each main gear consisted of a single shock absorbing strut with additional bracing struts, dual hydraulic brakes, and a 47 inch tire (Dave Mason)



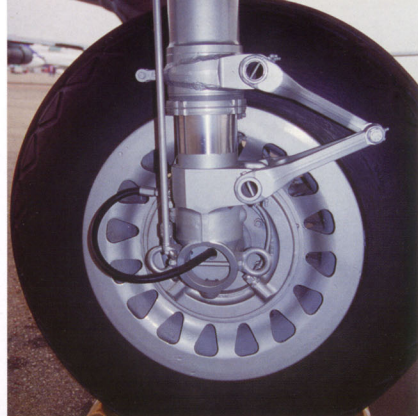

(Left) Narrow hydraulic piping running down the strut fed the dual brakes. One flexible hose ran through the hollow axle to the outside of the wheel. (Lou Drendel)



(Right) The brake hose exited at the hub and was joined to a metal fitting on the outer wheel. Each wheel had a pair of disc brakes operated via the rudder pedals. (Lou Drendel)



(Left) The flexible brake hose fed the second brake behind the outer wheel face. The main wheels normally did not use cover plates. (Lou Drendel)



(Right) Although wheel chocks are an aircraft's way of life, the B-25 was equipped with hydraulically operated parking brakes on each wheel. If the throttles are retarded to less than 16 inches of manifold pressure, landing gear warning lights flash in the cockpit to warn the pilots they are in danger of landing gear-up. (Lou Drendel)



The transitional position of the landing gear doors is visible as this B-25C-5-NA of the 7th Photo Group departs from Mt. Farm Airfield, England in the spring of 1945. The landing gear retracted aft in about 16 seconds and extended in about 10 seconds. The main and nose wheel doors opened only during the retraction or extension sequence. (Robert Astrella via Norm Taylor Collection.)

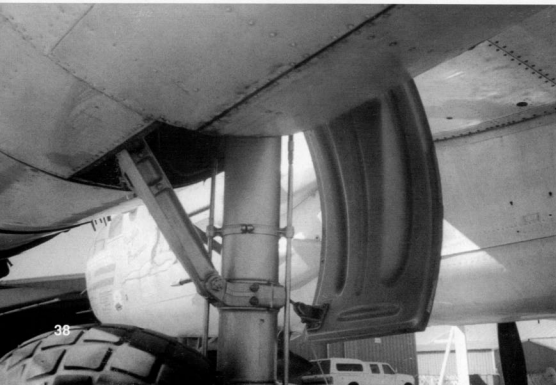

Left main gear strut and door. The interior of the nacelles and gear doors were normally painted chromate green. The struts were painted with a silver lacquer. While there is an emergency gear extension system, there is no way to manually retract the landing gear. (Dave Mason)





A very well-worn B-25C of the 12th Bomb Group landing in Italy during W.W.II. The use of unimproved forward airfields, with flying dirt and stones played havoc with propellers and paint in combat conditions. Under such conditions, having the main and nose gear doors closed to keep out debris was probably a good idea. (Norm Taylor Collection.)

The main landing gear wheels are equipped with dual, hydraulically operated, multiple-disc brakes, which are actuated by pressure from the hydraulic power supply system. The air valve stem is visible just to the left of the brake fitting. The wheels were normally painted silver. (Dave Mason)

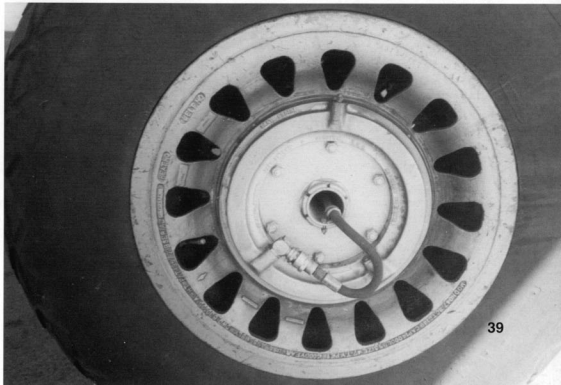



The nose gear is aligned with the centerline of the fuselage. The nosewheel was not steerable, but could caster up to 60 degrees left or right. Normal steering was accomplished via differential braking. In this view, the bomb bay doors are open. (Lou Drendel)



The engine nacelle fully enclosed the main landing gear. This aircraft, a restored B-25J, also has a modified exhaust arrangement. The engine crankcases and reduction gear housing were painted dark gray. The silver ring is part of the ignition system. Oil leaks are also an aircraft's way of life. (Lou Drendel)



The main gear strut doors were the only open doors when the landing gear was down. A single strut, connected to the main strut assembly, held the door open and closed it during the retraction sequence. (Lou Drendel)



(Above) Restored civil B-25J at Lakeland, Florida, April 1991. "Chapter XI" carries a modified 5th Air Force insignia. The name probably refers to the possible consequences of the operating costs of the B-25. (Lou Drendel)

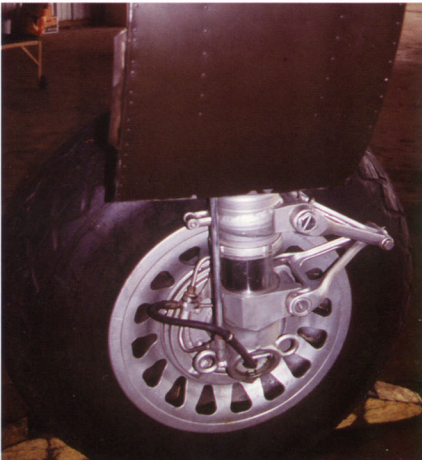

(Left) The open strut door provides limited access to the wheel well. The main and the nose wheel doors were normally closed, but could be unlatched and opened for maintenance access. (Lou Drendel)



(Right) The forward crew access door on a B-25H. A similar door was located aft in the waist compartment. Both doors could be jettisoned in an emergency. "LIMITED" refers to the current civilian certification classification, reserved for a few ex-military aircraft. (Lou Drendel)



(Above) Early production B-25D. The D model was assembled in Kansas City, with parts being supplied by the Inglewood Plant and by Fisher Body. The first B-25Ds were accepted in February 1942. Black de-icer boots, often removed in service, are on the leading edges of all flying surfaces. (Norm Taylor Collection.)

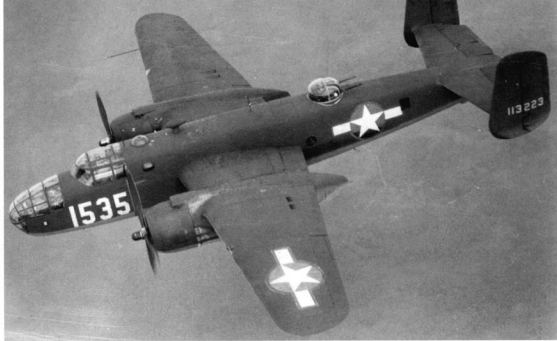

(Below) B-25C serial number 41-12861 of the 34th Photo Recon Squadron undergoes field maintenance at a forward combat base during 1944. C/D/G models had a Navigator's astrodome behind the cockpit. (Norm Taylor Collection.)

(Above) A B-25C-1-NA (41-13223) of the 377th Bombardment Squadron, 309th Bomb Group, Columbia Army Air Field, South Carolina as it appeared in September 1943. An RDF 'football' antenna is on top of the fuselage. The three fuselage side windows were eliminated on the H/J models. Other significant differences visible in this view include a smooth engine cowl and no tail gunner position. (Norm Taylor Collection.)





B-25J-1-NC (43-27729), assigned to the 488th Bomb Squadron/340th Bomb Group/12th Air Force, landing at an American base on Corsica in March 1944. This was among the first production J models and lacks the factory installed fuselage gun packages. (Norm Taylor Collection.)



B-25C-1-NC (41-30105) of the 310th Bomb Group on short final to an American base in Tunisia, 1944. The lack of armament indicates the aircraft is likely a squadron hack or transport. The late model exhaust system, characterized by the engine cowling fairings, was the ultimate wartime design. The landing gear has also been painted — probably chromate green (Norm Taylor Collection.)

B-25C-1-NA (41-13120) of the 434th Bomb Squadron, 12th Bomb Group (Medium) over the western North African desert, November 1942. An improved NAA exhaust collector ring design, evident by the absence of a large exhaust pipe behind the cowl flaps, has been installed. (Norm Taylor Collection.)

B-25C-5-NA (42-53357) of the 7th Photo Group undergoes field maintenance at Mt. Farm Airfield, England during 1945. For defensive purposes it retains the dorsal turret (though the retractable ventral turret is missing) and a nose gun. (Robert Astrella via Norm Taylor Collection.)

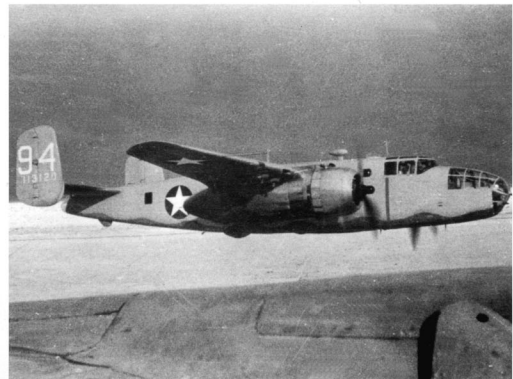



## Crew Boarding Ladder

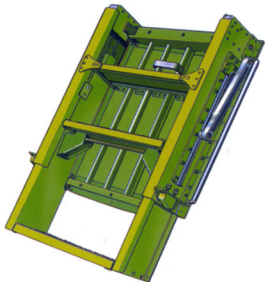

Aft crew boarding ladder of the B-25J. These hatches (front and rear) were the primary exits on the ground... or in the air. (Lou Drendel)

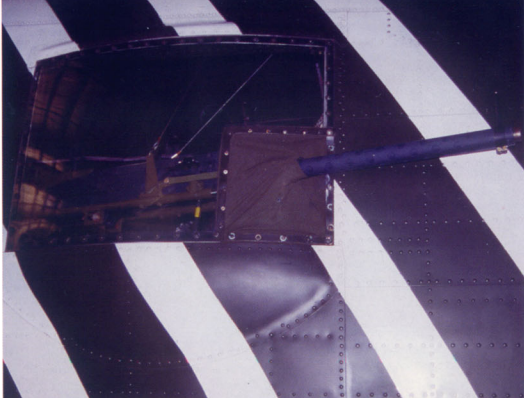

Left waist gun gondola of the B-25H "Barbie III". The waist guns were staggered and were first introduced on late D and G models. Blistered waist gun positions were standard on all H and J models of the B-25. (Lou Drendel)

Left waist gun blisters of two restored B-25Js. Antennae on top of both fuselages are for modern radios. The red rotating beacon on the top of the invasion-striped J is also a modern addition. (Dave Mason & Lou Drendel.)

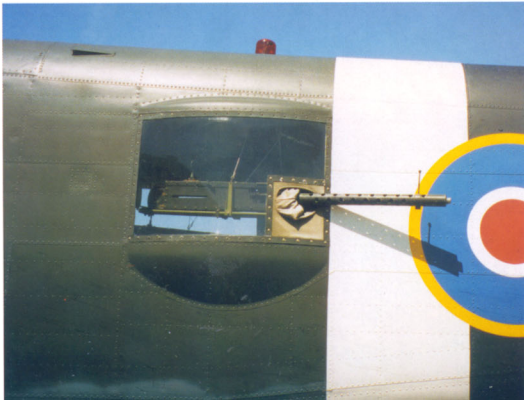

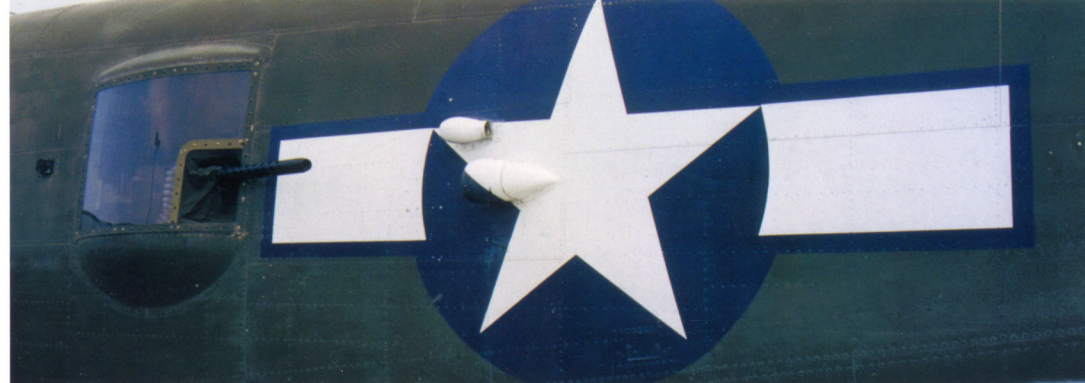

(Above) Left waist gun blister. B-25B through G were originally designed without waist guns. Combat experience resulted in field modifications adding a single .30 or .50 caliber weapon poking through the aft window. The field of fire was limited due to the small opening and the proximity of the tail surfaces. The new waist guns were usually operated by a single gunner. The air scoops provided air to the waist and aft fuselage area. (Lou Drendel)

(Below) Left waist gun gondola of the B-25J belonging to the Cavanaugh Flight Museum. Bulging the window and mounting the gun in the lower aft corner improved the field of fire, especially towards the rear of the aircraft. Waist guns were also used for suppressing AA fire during strafing runs. This style of waist blister was first introduced on late B-25D and H aircraft. (Nick Waters)

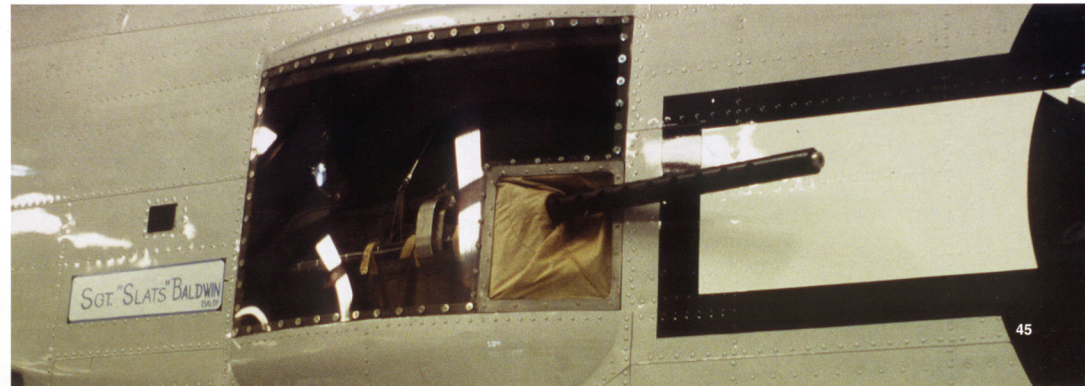

**B-25J Mitchell**

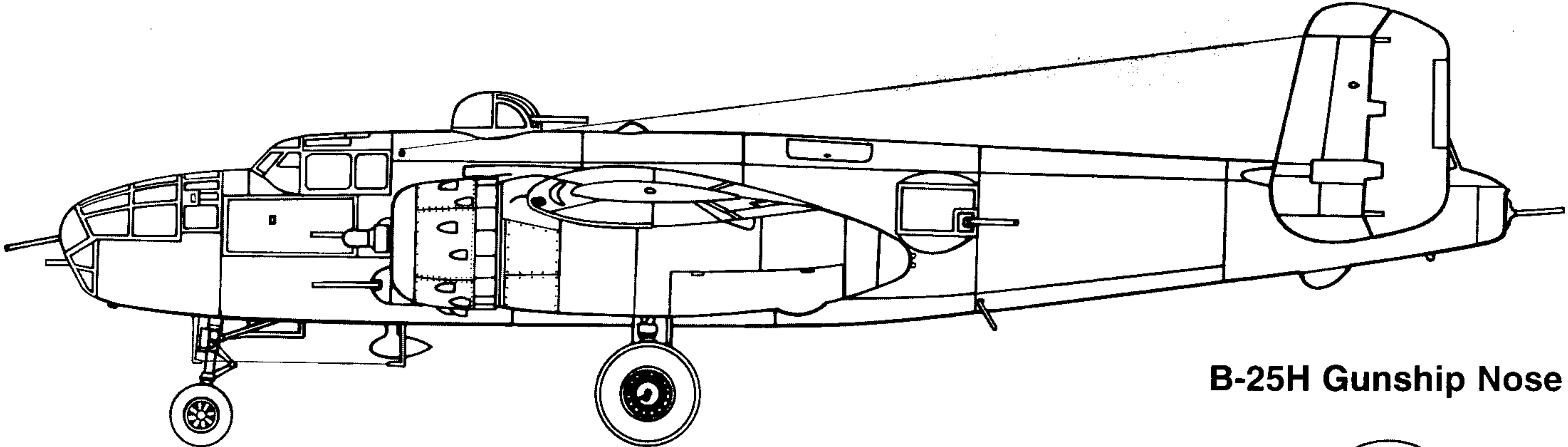

**B-25H Gunship Nose**

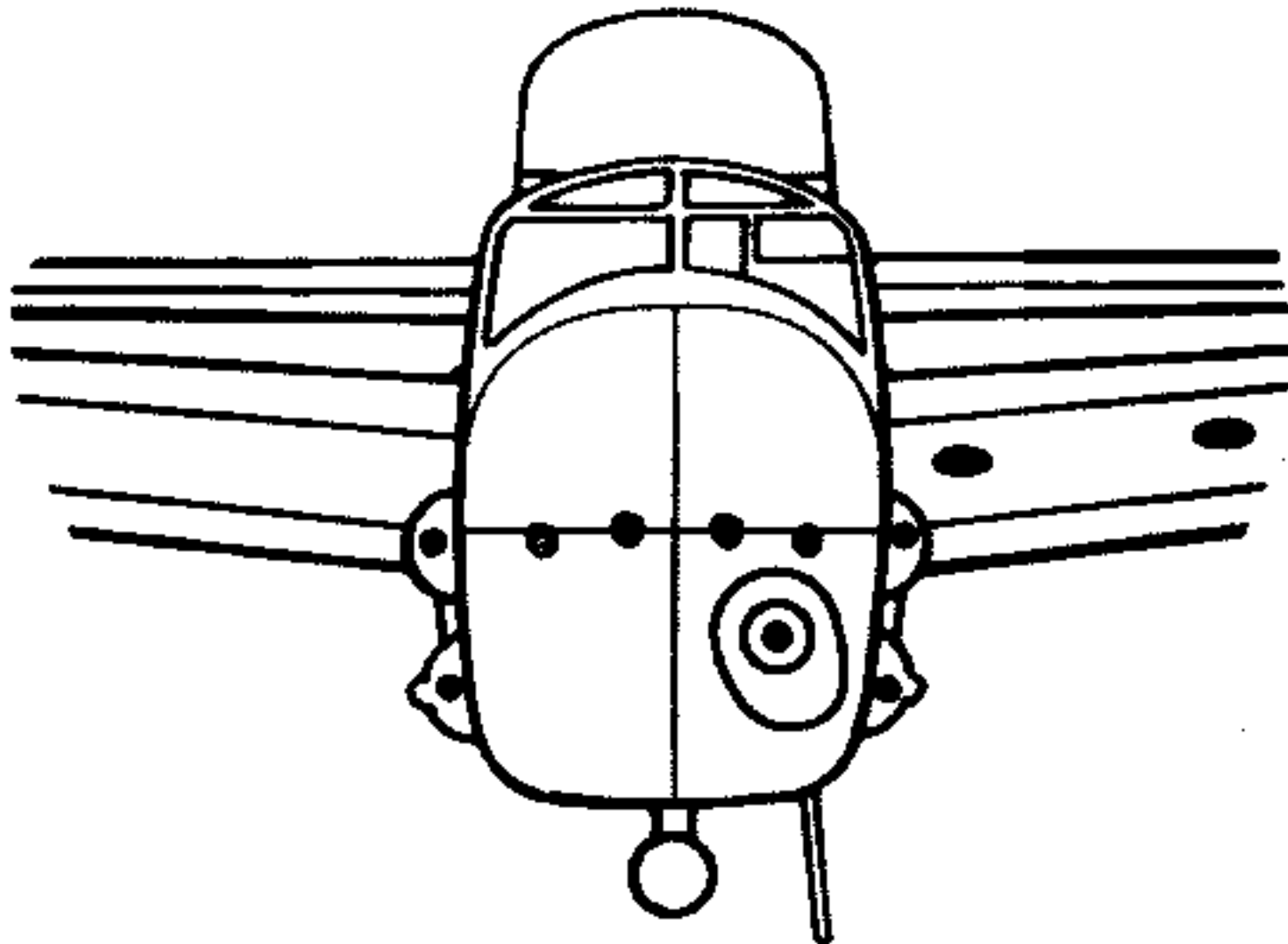

**B-25J Gunship**

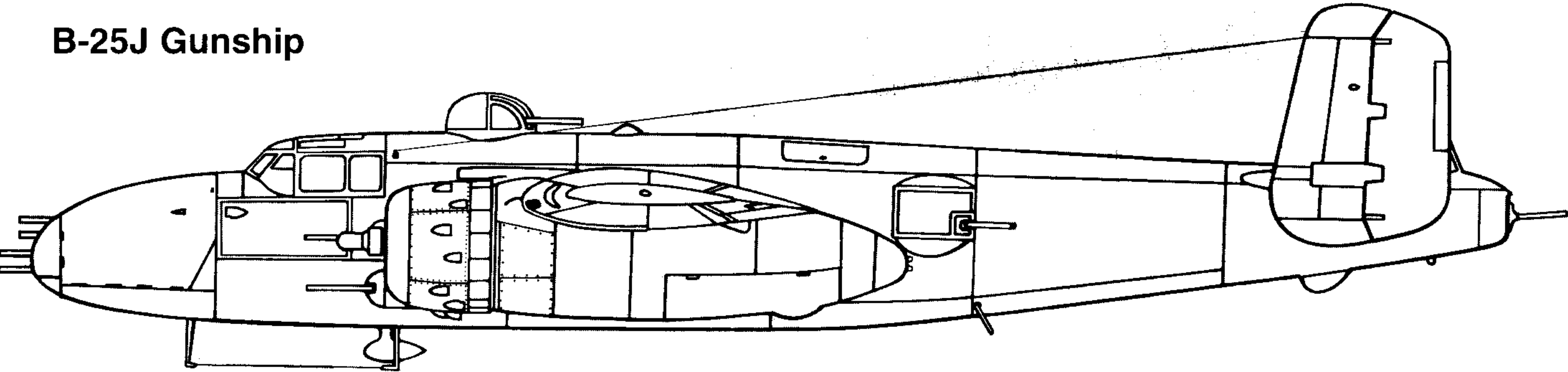

**B-25J Gunship Nose**

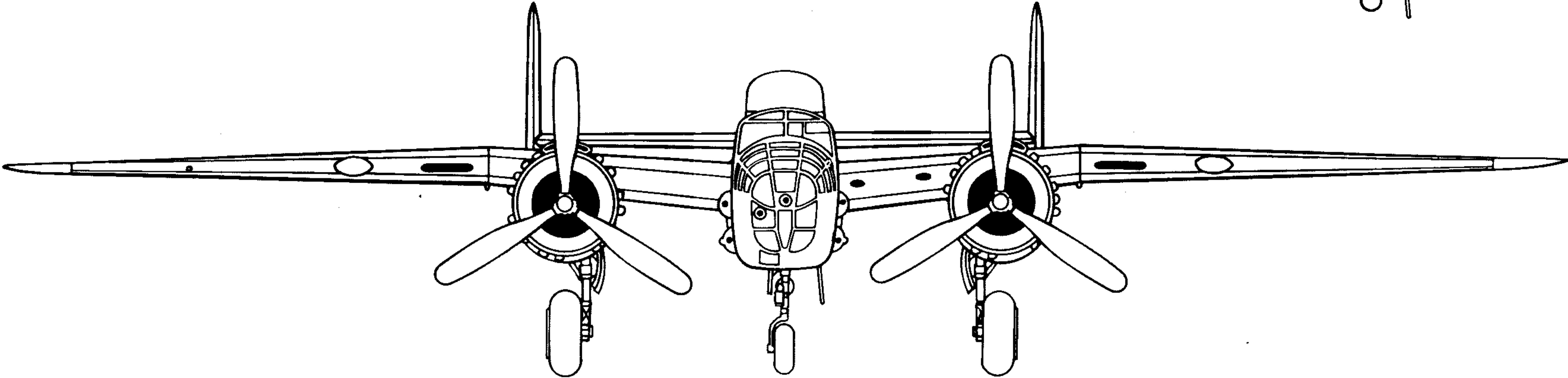
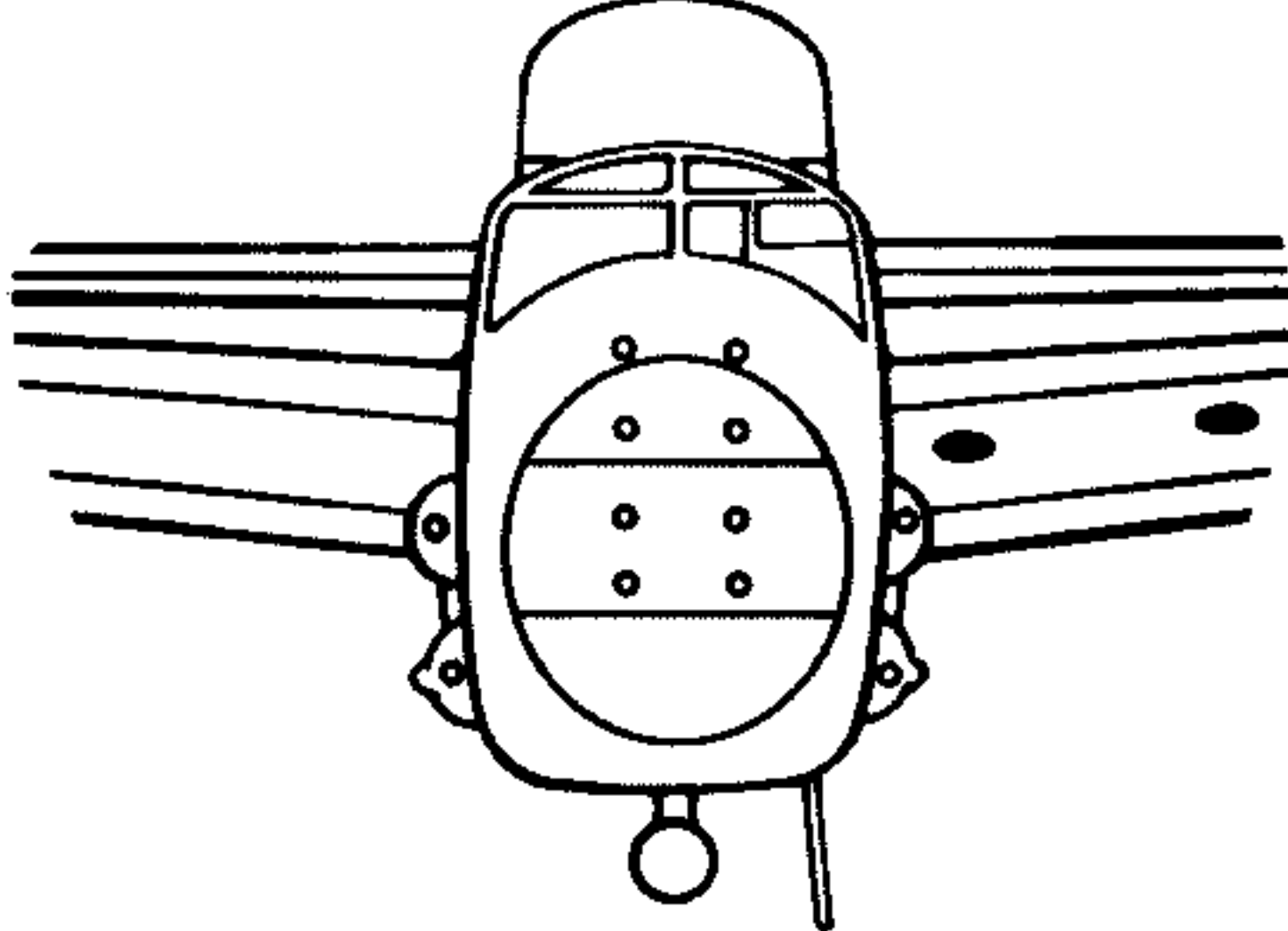



## B-25H Gunship

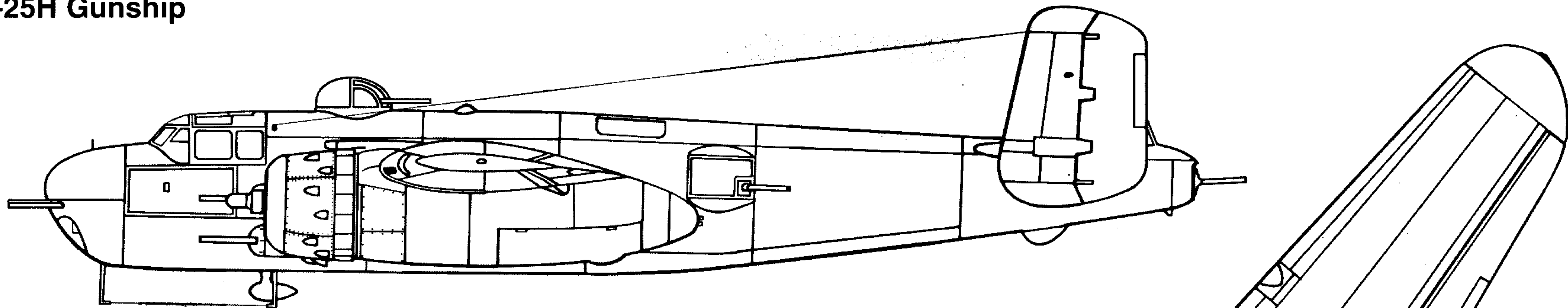

## B-25J Specifications

Span:	67 feet, 7 inches
Length:	52 feet, 11 inches
Height:	15 feet, 10 inches
Gross Wt:	33500 lbs
Engines:	Wright R-2600-13
Crew:	6
Bomb Load:	3000 lbs
Armament:	
Bomber:	13 x 50 .Caliber
Machine Guns	
Gunship:	18 x 50 Caliber
	Machine Guns

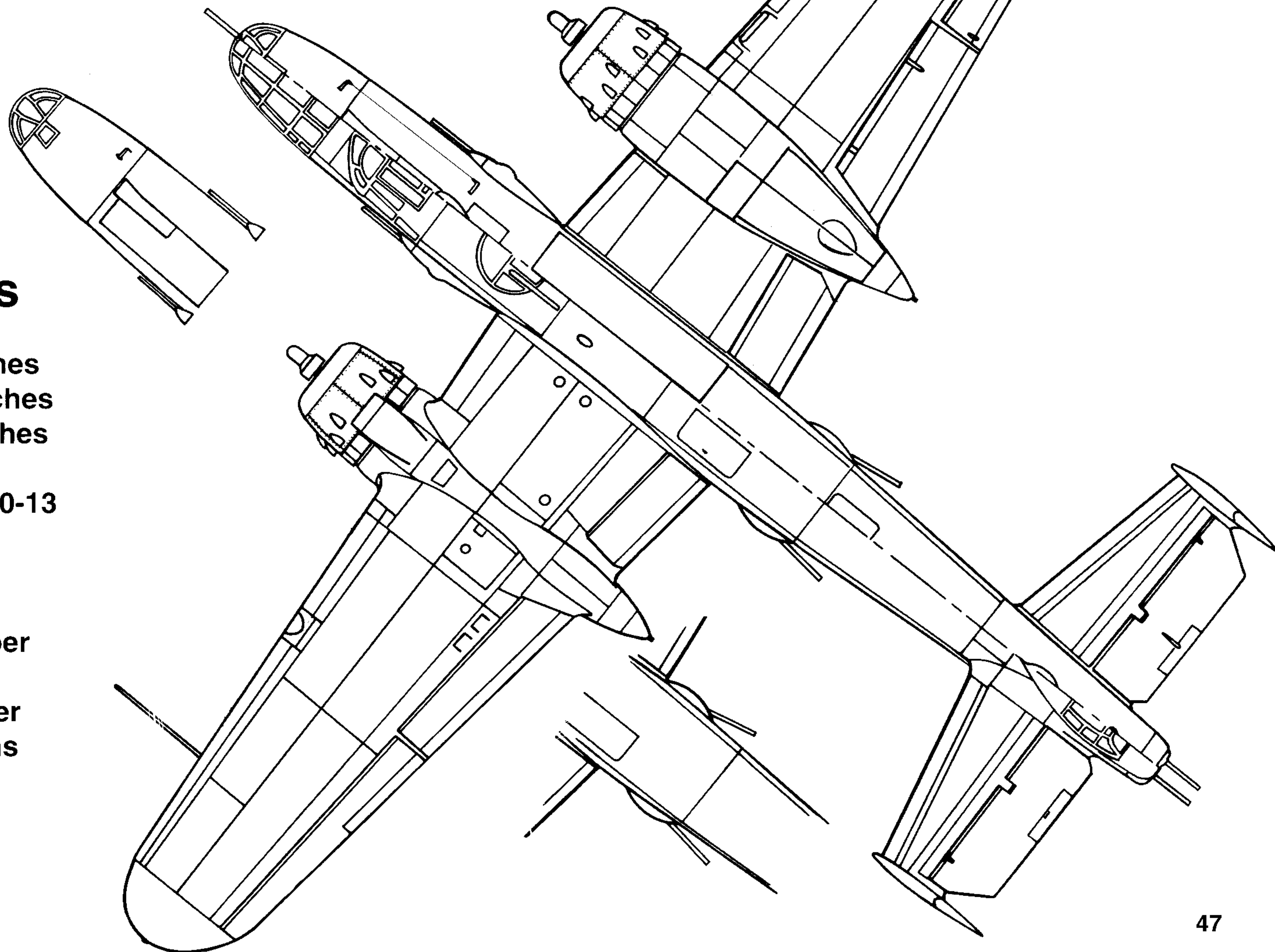

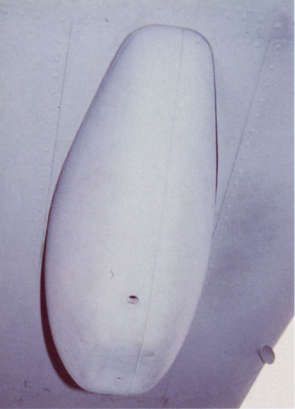

(Left and Below Left) A fixed tail skid protected the lower aft fuselage from damage in the event the pilot over rotated on take-off or landed tail low. The skid was firmly mounted on heavy longitudinal beams supported by transverse fuselage formers within the fuselage. The earliest B-25s used a retractable tail skid to protect the tail from overanxious pilots. (Lou Drendel)

(Below) The gunner was provided with two .50 caliber machine guns fed by ammo boxes in the aft fuselage. The boxes held 600 rounds per gun. Previous attempts at providing a tail gun had met with limited success. B-25B through G often had the rear dome removed and a jury rigged mount for a .30 or .50 caliber weapon added. The gunner was forced to lay in a prone position which resulted in a limited cone of fire to the rear. The new position provided more room and dramatically improved the rearward defensive capabilities of the B-25. (Lou Drendel)

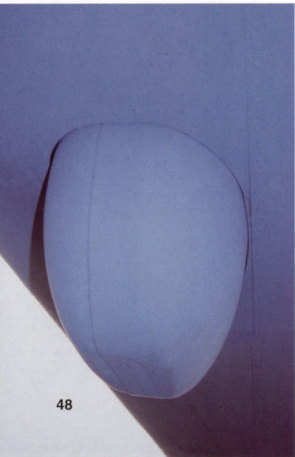



(Right and Below Right) B-25H and J models introduced a new style factory installed tail gun position. The new position required a deepening of the aft fuselage by seven inches. Canvas covers were standard fittings as the end of the fuselage was open to the elements. The guns were used for defense against fighters and were useful in sending a parting shot at the target after a strafing run. Late B-25Ds and Gs were factory fitted with a manned tail gun position using a similar style of canopy, but employing a single manual .50 caliber machine gun. The gunner kneeled to use the gun and sighted it using a ring and bead sight. The gun position also appeared on Navy/Marine PBJs. The new twin gun Bell turret doubled the firepower and provided the rear gunner with a far better operating environment. (Lou Drendel)



(Below) The gunner's canopy could be jettisoned in an emergency using the red handle on the forward upper bulkhead. In a controlled bail out, the gunner could use the lower aft crew hatch, but in a combat situation with the aircraft on fire, spinning or breaking up, up and out was the only way to go. The wind deflectors and extended platform are modern additions for aerial camera work. (Dave Mason)



# B-25H/J Waist Gun Position

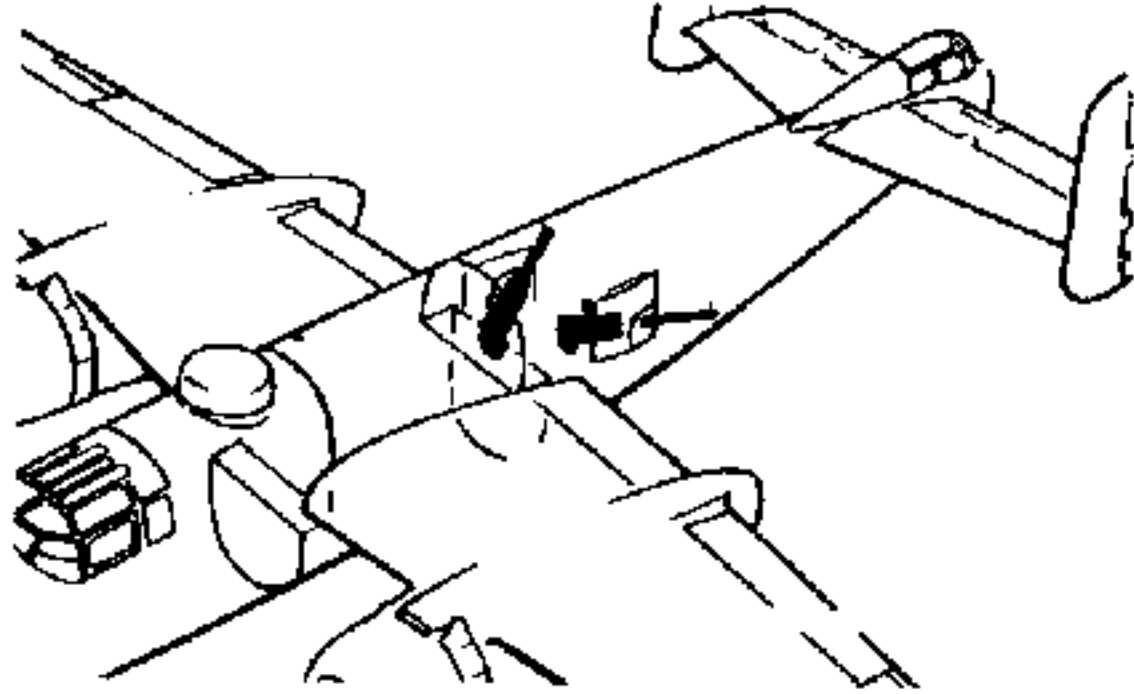

Ammunition Chutes

Ammunition Boxes

CounterBalance Cables and Pulleys

Spent Cartridge and Link Box

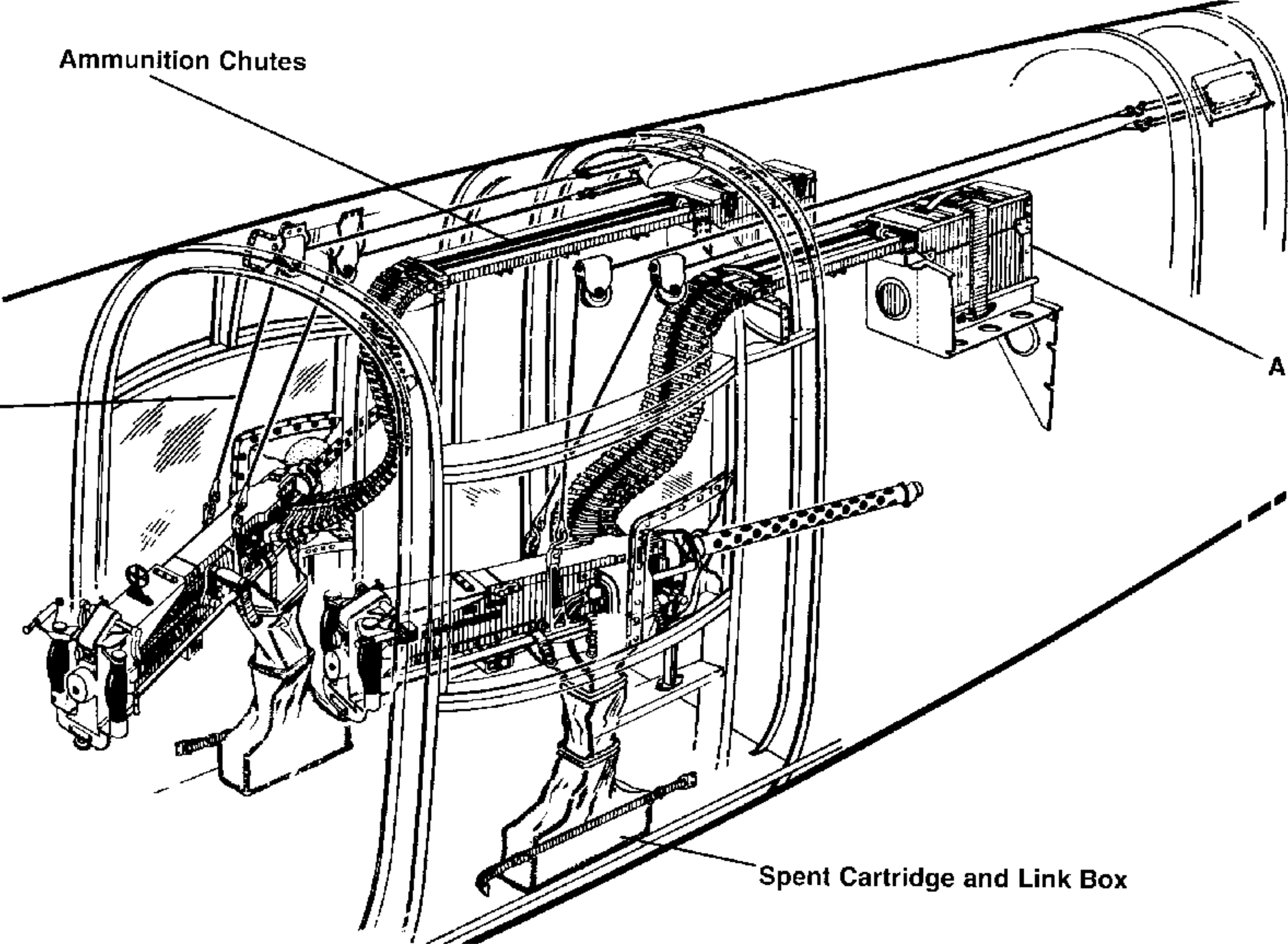

# B-25 Tail Gun Position and Ventral Turret

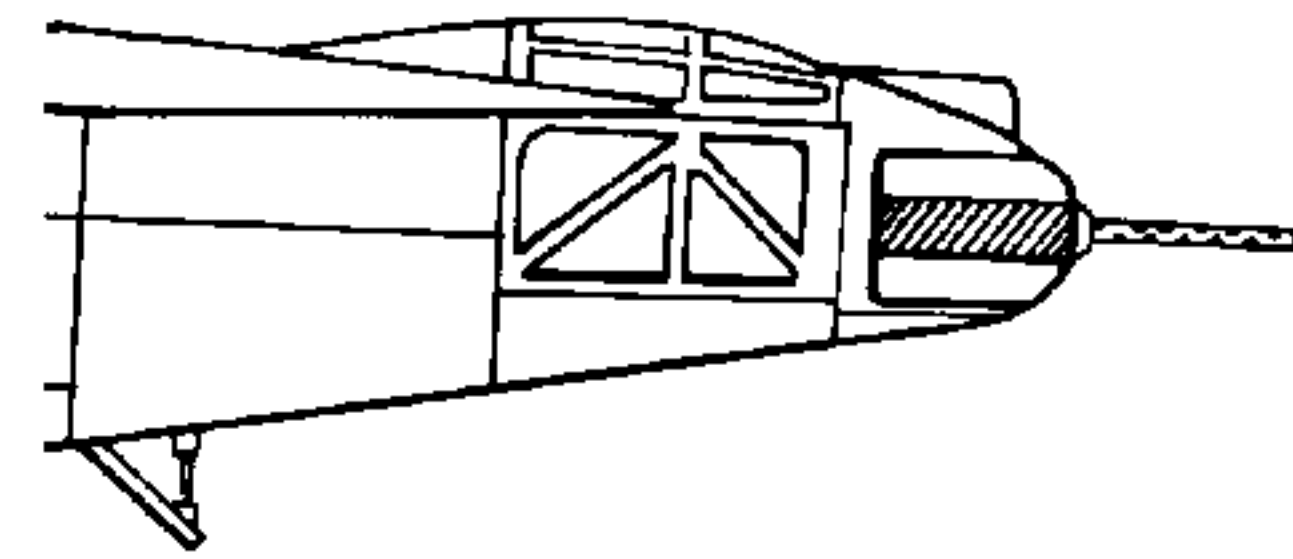
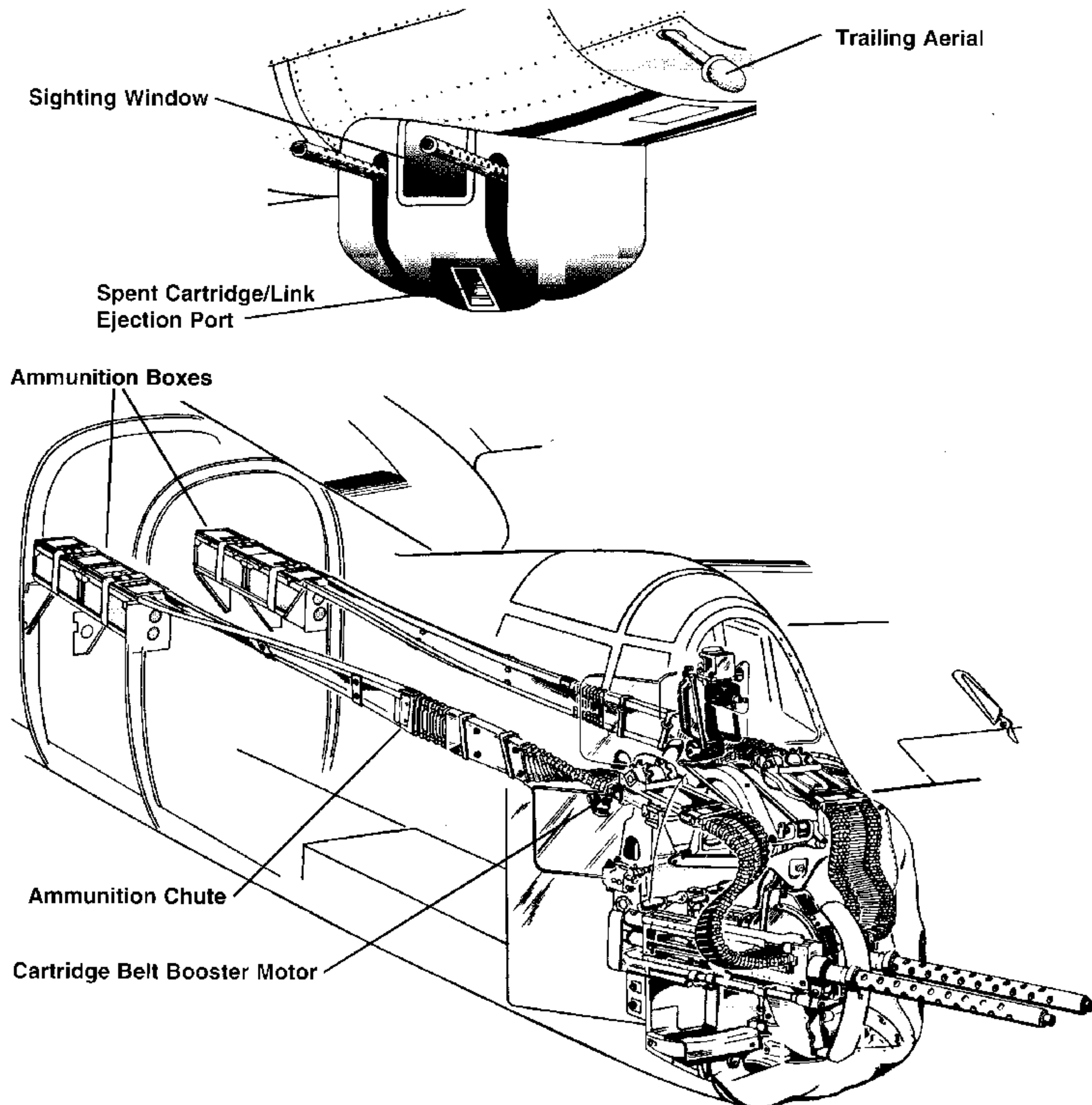

B-25

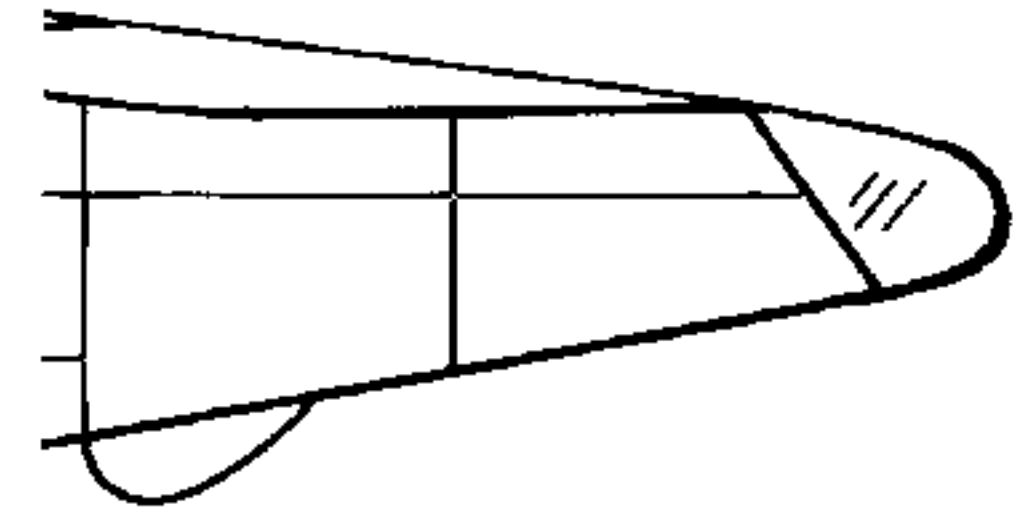

B-25B-G

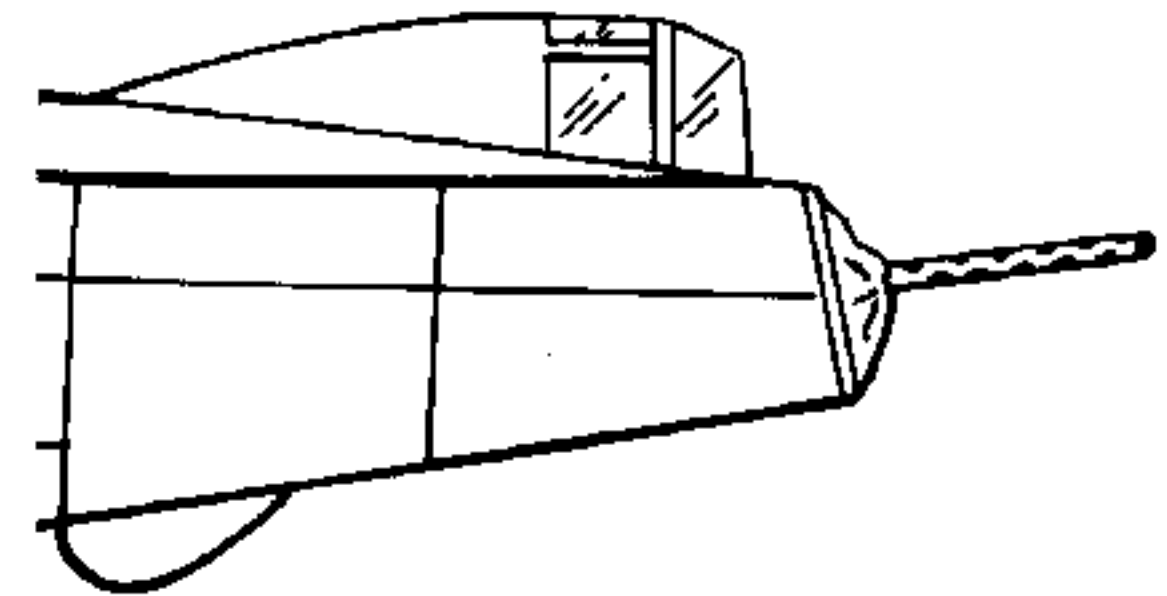

Late B-25D and G (Single Gun)

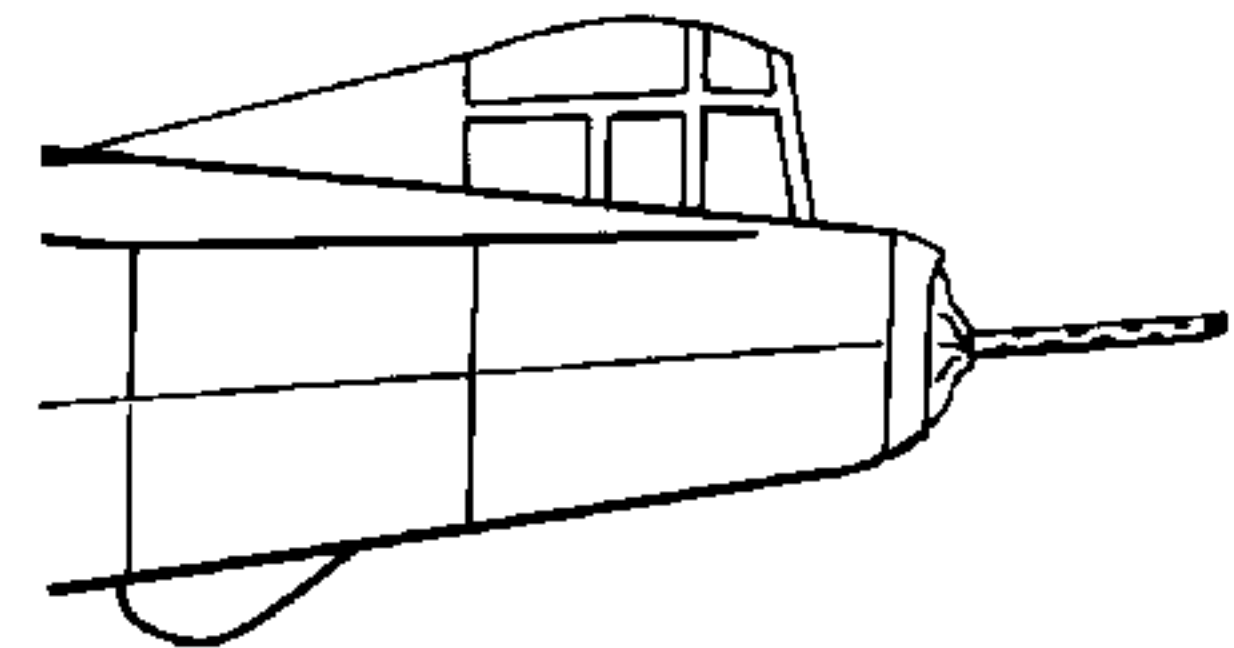

B-25H and J (Twin Guns)



(Left) Cowl flaps almost circled the entire rear edge of the cowl. The flaps were hydraulically actuated using a single pushrod on each flap. (Dave Mason)

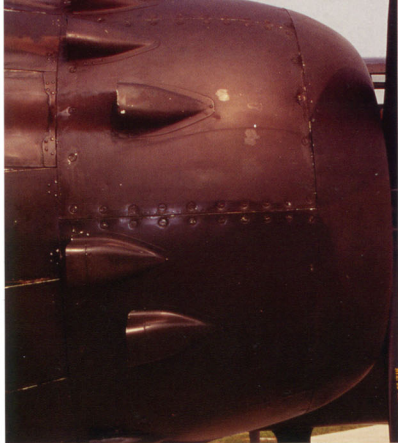

(Right) The "Clayton S Stack" configuration was introduced on the production line with the first B-25C-15, serial number 42-32383 and was standard on all subsequent B-25s. (Lou Drendel)



(Left) These exhaust stubs were the most efficient, but they were also the loudest and easiest to spot at night. The exhaust stacks covered by these fairings provided a weight savings of 53 pounds per engine. (Lou Drendel)



(Right) This exhaust system shows modifications made as a result of problems. The "S" stacks occasionally broke loose from the top cylinder, so a collector ring stack was fitted for the top cylinders, exiting in a single exhaust stack. The lower cylinders retained the original stacks. Cowl fairings were removed and patches installed for the top cylinders, a fairly common modification on post-war B-25s. (Lou Drendel)



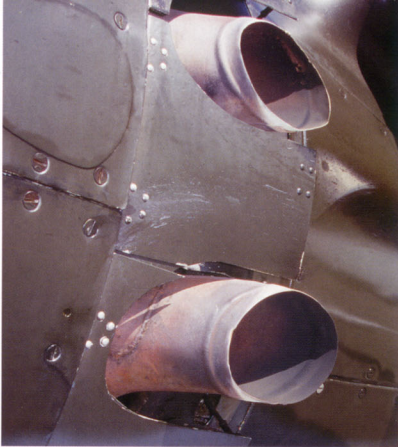

(Left) Engine nacelle of the Canadian Warplane Heritage B-25J. The low profile airscoop on top of the nacelle indicates an early model Bendix-Stromberg carburetor. (Lou Drendel)



(Above Right and Below Left) The CWH B-25J has a hybrid exhaust stack system, with upper and lower collector rings terminating in these large exhaust stacks. Some B-25C, and a few D and G models, had a single collector ring which dumped into a large exhaust stack in the approximate position of the lower stack in these photos. The patches on the cowlings indicate the replacement of the original Clayton S stacks (Lou Drendel)

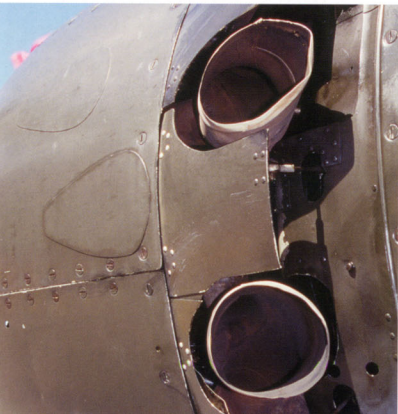

Fuel vent tubes at the rear of the engine nacelles were found all B-25s. Each of the B-25s engines have an independent fuel supply system, interconnected, which allows either engine to operate off of the fuel supply of the opposite engine. (Lou Drendel)



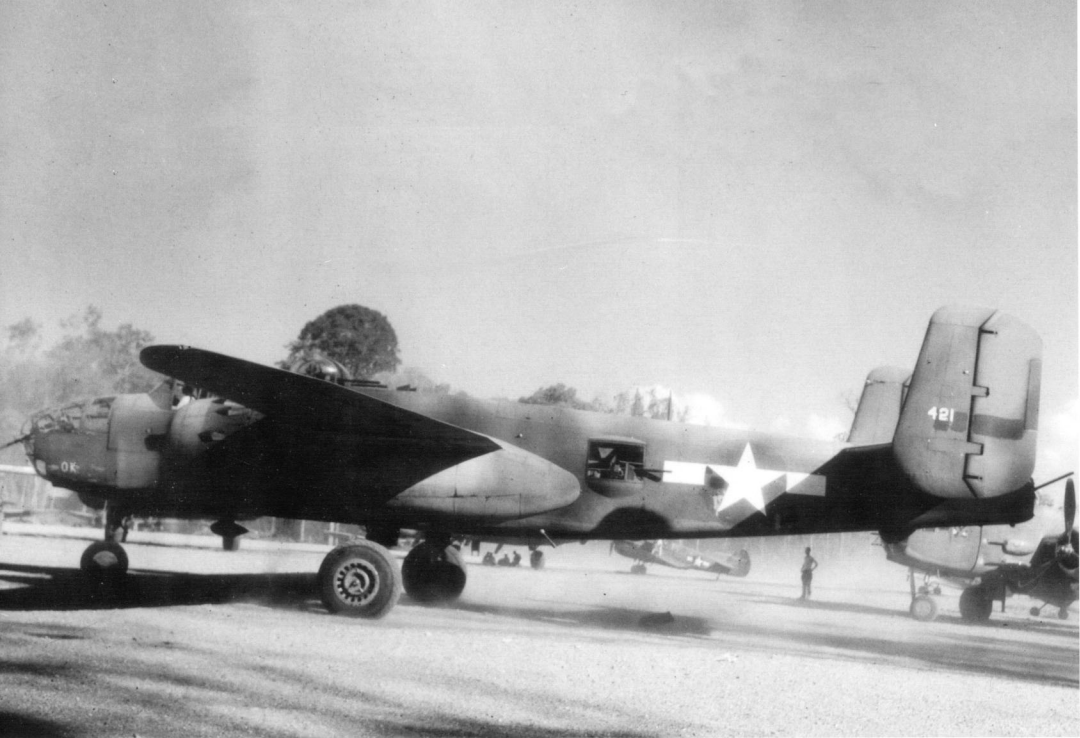

B-25J-20-NC (44-29421) of the 14th Air Force, at Tingkawk Sekan, Burma in July of 1944. The 1st Bomb Group of the 14th was comprised of the 1st, 2nd, 3rd, and 4th Squadrons of the Chinese American Composite Wing and the 341st Bomb Group, which was transferred from the 10th Air Force in 1944. (Norm Taylor Collection.)

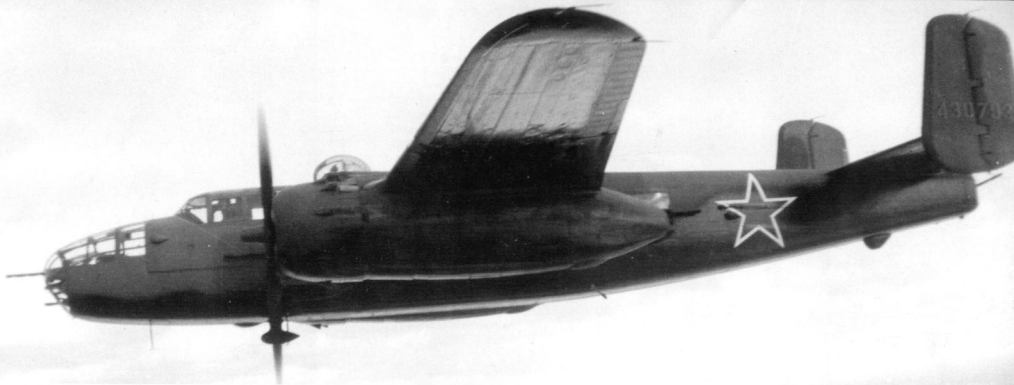

B-25J-25-NC (44-30793) fresh from the factory and enroute to Russia in 1944. The Russian scheme is Dark Green and Dark Earth over Black. 870 B-25B, C, D, H, and J models were delivered to Russia during World War II under the Lend Lease program. (Ben L. Brown via Norm Taylor Collection.)

B-25J-25-NC (44-29534) at Nome, Alaska during the winter of 1944. Lend-Lease supplied B-25s were ferried from the NAA factory in Columbus, Ohio. Standard USAAF upper surface camouflage, with gloss black under surfaces. The red star was applied on a white background for ferry missions only. Some Russian B-25s had the red star applied over the blue circle of the USAAC insignia for the trip. (Capt. Ben L. Brown via Norm Taylor Collection.)



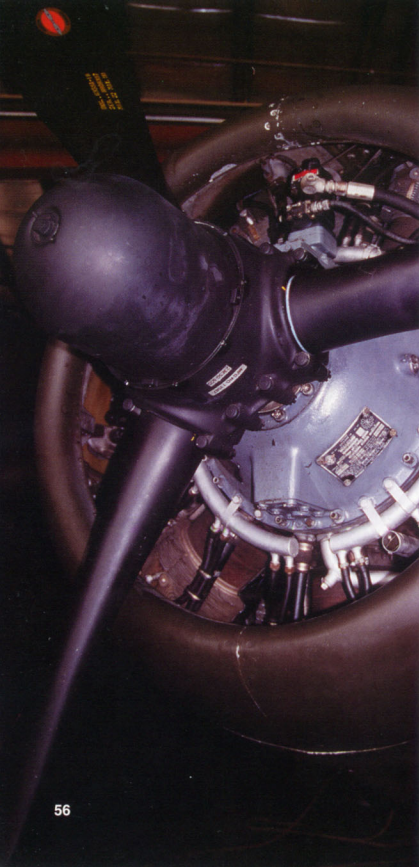

(Right) Propeller dome of the 3-bladed Hamilton Standard hydromatic constant speed propeller. Movement of the prop blades to maintain a constant RPM during varying flight conditions was achieved by increasing or decreasing oil pressure in the propeller dome. The propellers were full feathering, and this action was accomplished by the prop governor providing oil pressure from a 1.5 gallon reserve in each engines main oil tank. (Lou Drendel)

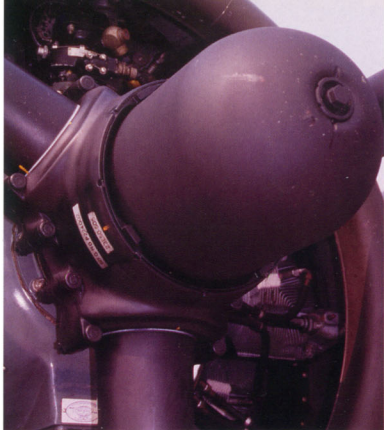

(Left) Propeller hub and front of the Wright R-2600-20 engine in the B-25H. This was the latest model of the R-2600. 14,620 of the R-2600-20 engines were produced. They produced a maximum of 1600 HP and weighed 2045 lbs. (Lou Drendel)

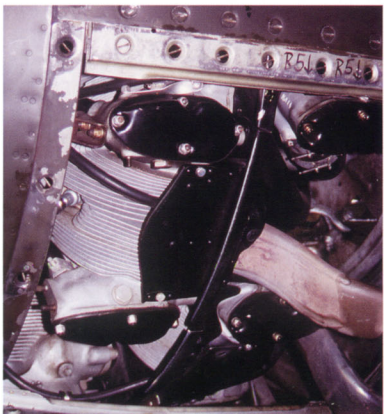

(Right) Open access panel on lower left side of the engine cowling, showing two of the 14 exhaust stubs from the twin row radial engine. Also visible are the cylinder heads. The R-2600 also powered several other aircraft, which brought total production of the Wright R-2600 to 47,420 engines. (Lou Drendel)

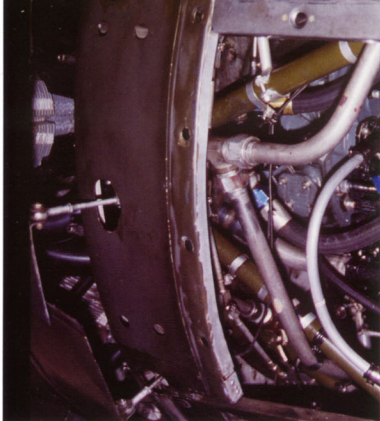

(Left) Open access panel on the right side of the R-2600 engine. The rear of the engine is visible, packed with accessories, piping and electrical wiring. All variants of the B-25 were powered by this engine. The oil lines are silver and the engine mount tubes are green. (Lou Drendel)



(Left) This large air intake on the leading edge of the wing, outboard of the engine nacelle, provides cooling air for the oil cooler located inside the wing. This area of the wing underside was also strengthened to carry a pair of bomb racks, each capable of holding 100 pound bombs. (Dave Mason)

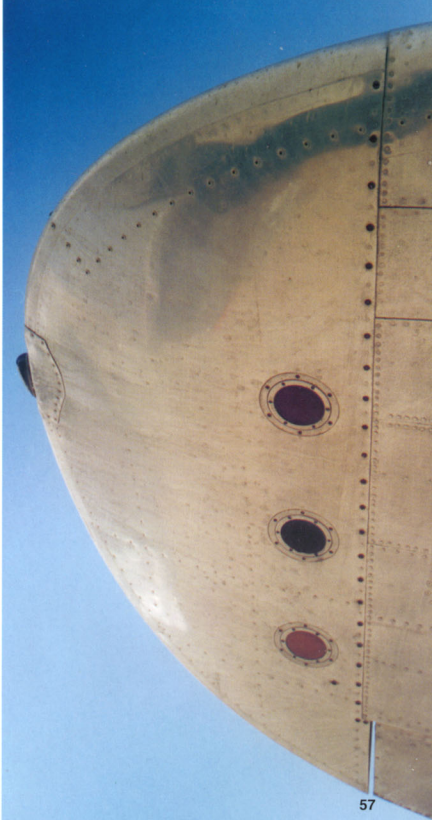

(Right) Red, green, and amber recognition lights on the underside of the right wing of a B-25J. (Lou Drendel)

## Cowl Flap Inner Surface

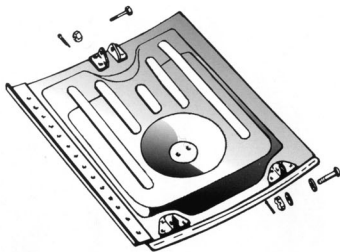

The landing lights, seen from the underside, were placed in the leading edges of both wings. (Lou Drendel)



## Barbie III

Barbie III above and on the back cover. MSgt Charles (Chuck) Baisden (standing fourth from left above) served aboard Barbie III as the top turret gunner and flight engineer. MSgt Baisden flew 58 missions in the China-Burma-India theater as part of the 1 Air Commando Group. In his words...

*Barbie was our pilot's wife's first name. Lt. Col. R. T. Smith, CO of the B-25 Squadron. He flew P-51s prior to flying the B-25 and the P-51 was Barbie I. We lost the nose hood which smashed in the pilot's cockpit, tore off part of my turret and then dropped a hung up 500 pound bomb through the bomb bay door on landing which about totaled out Barbie II. Hence, Barbie III.*

*Our crew was Pilot, Navigator/Cannoneer, Flight Engineer/Turret Gunner, Radio Operator/Waist Gunner, [and] Tail Gunner/Armorer. [Five crew members total.] In our H models (we had 11 and 1 J), the tail turret was a Bell Hydraulic (turret with) twin .50s. We had considerable trouble with this turret due to the location of the ammunition containers which required booster motors to force the belts through the feed chutes and the erratic operation of the hydraulic system. The tape on the left side of the fuselage is plain old masking tape which we put there to cut*



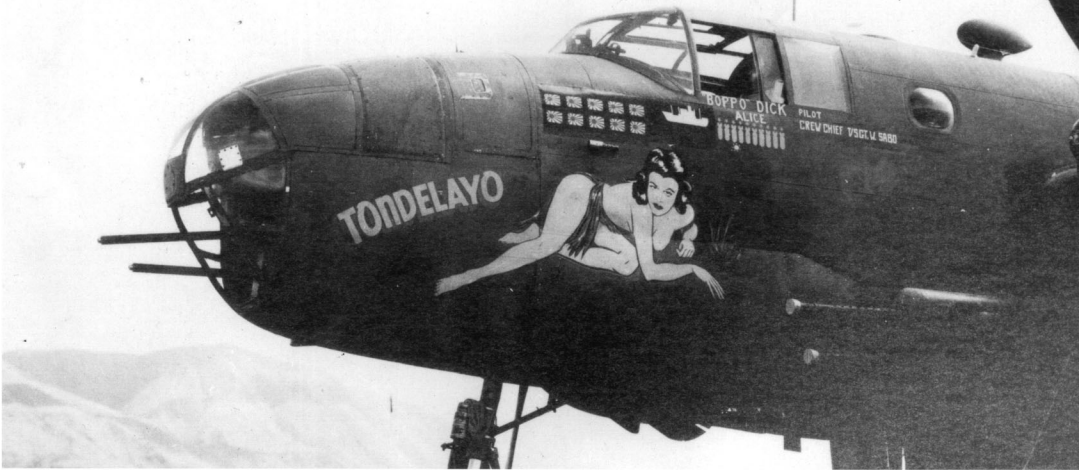

(Above) *TONDELAYO*, a B-25D of the 500th BS, 345th BG in New Guinea was field modified to gunship standards. The upper nose glazing has been painted over and additional guns poke through the Bombardier's front panel. The early style package guns are on the fuselage side.

*down on the corrosion between the armor plate and the fuselage skin. I later painted 47 bombs on this section.*

*We had no difficulties with the 75mm cannon. It was very effective on the river shipping, trains and truck convoys in the Burma Theater. The terrific recoil [sometimes] mentioned is pure garbage. You felt a jolt, some fumes in the top turret, and sometimes a little flicker in the air speed indicator. That's all. I loaded this weapon many times myself and it was not at all difficult to do. You did have to be careful about being pulled down behind the breech due to G forces on the pull-out from a run. Three rounds was [sic] the best I ever loaded with the 4th round in the weapon when we pulled out from our gunnery run.*

*As to our taking evasive action when firing the 75, you can't really be very accurate either with machine guns, low level bombs, etc., if you started jinking the aircraft around when you are making a run. It did take a damn good pilot to make hits with the 75 and we had these pilots in the 1st Air Commandos.*

(Below) The underside of the right horizontal stabilizer and elevator on a B-25J. There is virtually no difference in the tail from model to model, or left to right, of the B-25, from A to J. Each elevator was equipped with a rod actuated trim tab. (Lou Drendel)

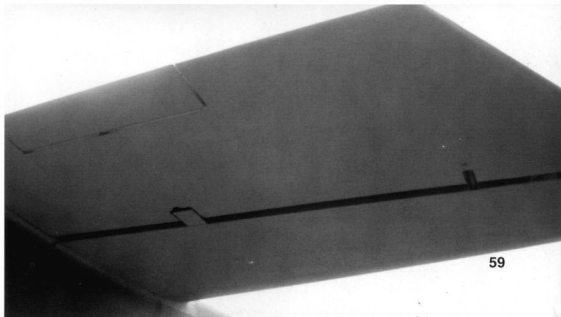



(Left and Right) Inboard and outboard views of the Cavanaugh Museum's B-25J starboard tail fin and rudder. The elevators, rudder and trim tabs consisted of an aluminum frame covered with fabric, a common practice in WW II bombers. A small white formation light was placed on the outer surface of the vertical fin. (EAA photo by Phil High)



(Below) B-25J of the Cavanaugh Museum. This Mitchell was restored by Carl Scholl and Tony Ritzman of Aero Trader, in Chino, California. The restoration took 3 years, and utilized all of the original parts of the original airplane. (EAA photo by Phil High)



Two .50 caliber machine guns, with 300 rounds per gun, were installed in the nose compartment. One fixed, forward-firing gun complemented the four fuselage pack guns and two upper turret guns, all with 400 rounds per gun. The flexible nose gun was operated by the bombardier. The fixed gun has separate bags for the collection of spent ammunition links (left) and shell casings (right). Early gunships deleted the bombardier, bombsight and flexible gun, substituting additional fixed machine guns and extra ammunition. Under the such circumstances, the nose glazing was usually painted over. The pulley and cable arrangement served to counterbalance the breech heavy machine gun. (EAA photo by Phil High)



The Cavanaugh Flight Museum's B-25J cockpit has been restored to its original configuration. The only visible evidences of modernity are the headset hanging near the Co-Pilot's control column and an ILS/GS indicator at the lower center of the panel. The levers on the pedestal between the seat, in pairs, are from left to right: Throttles, Propellers, and Mixture. The small knobs on the lower right are for carburetor air, and the larger knobs to the left control the superchargers. B-25 gunships used a fighter type gunsight mounted in front of the pilot. (EAA photo by Phil High)



## Flexible .50 Caliber Nose Gun

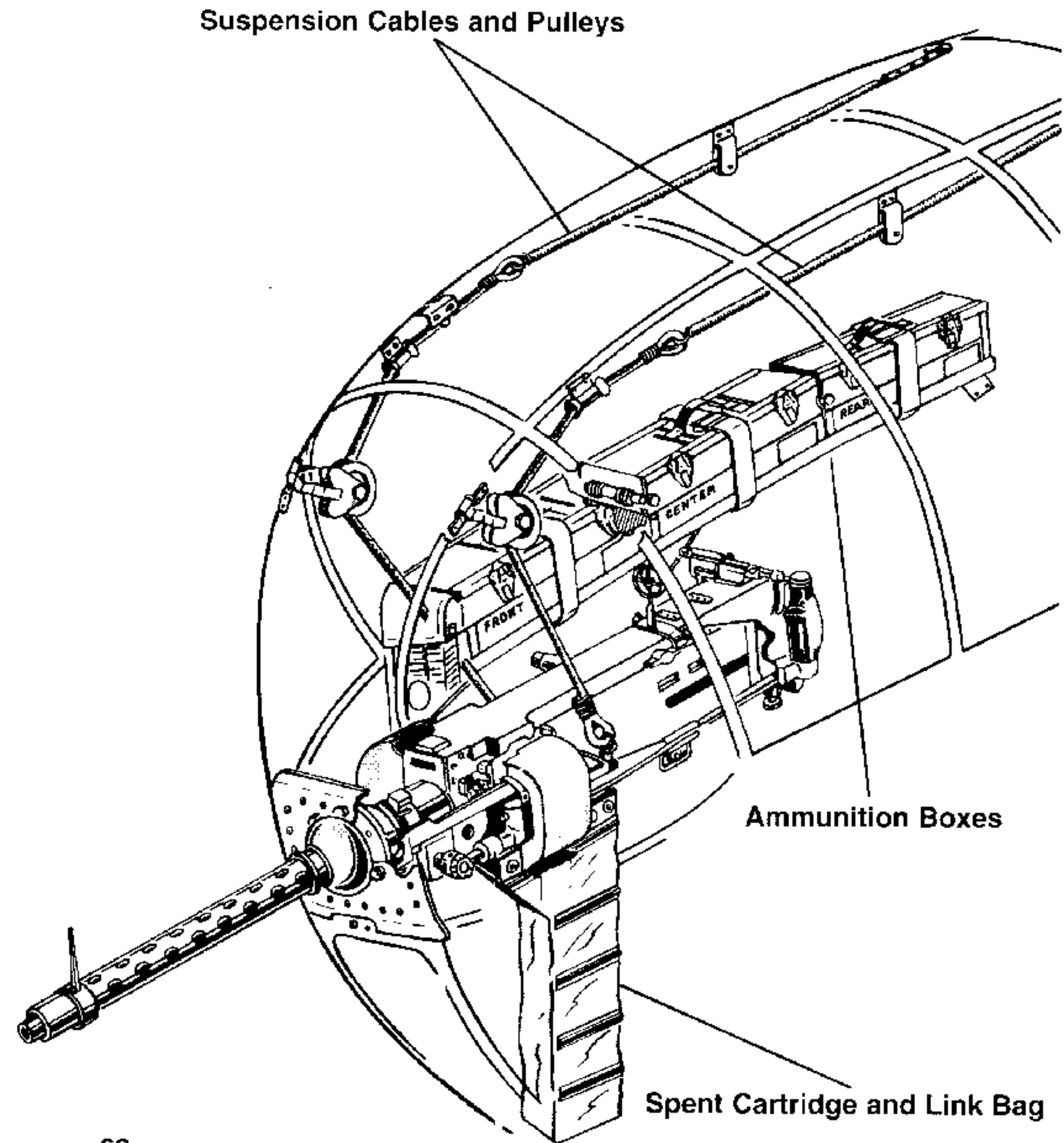

## Fixed .50 Caliber Nose Gun

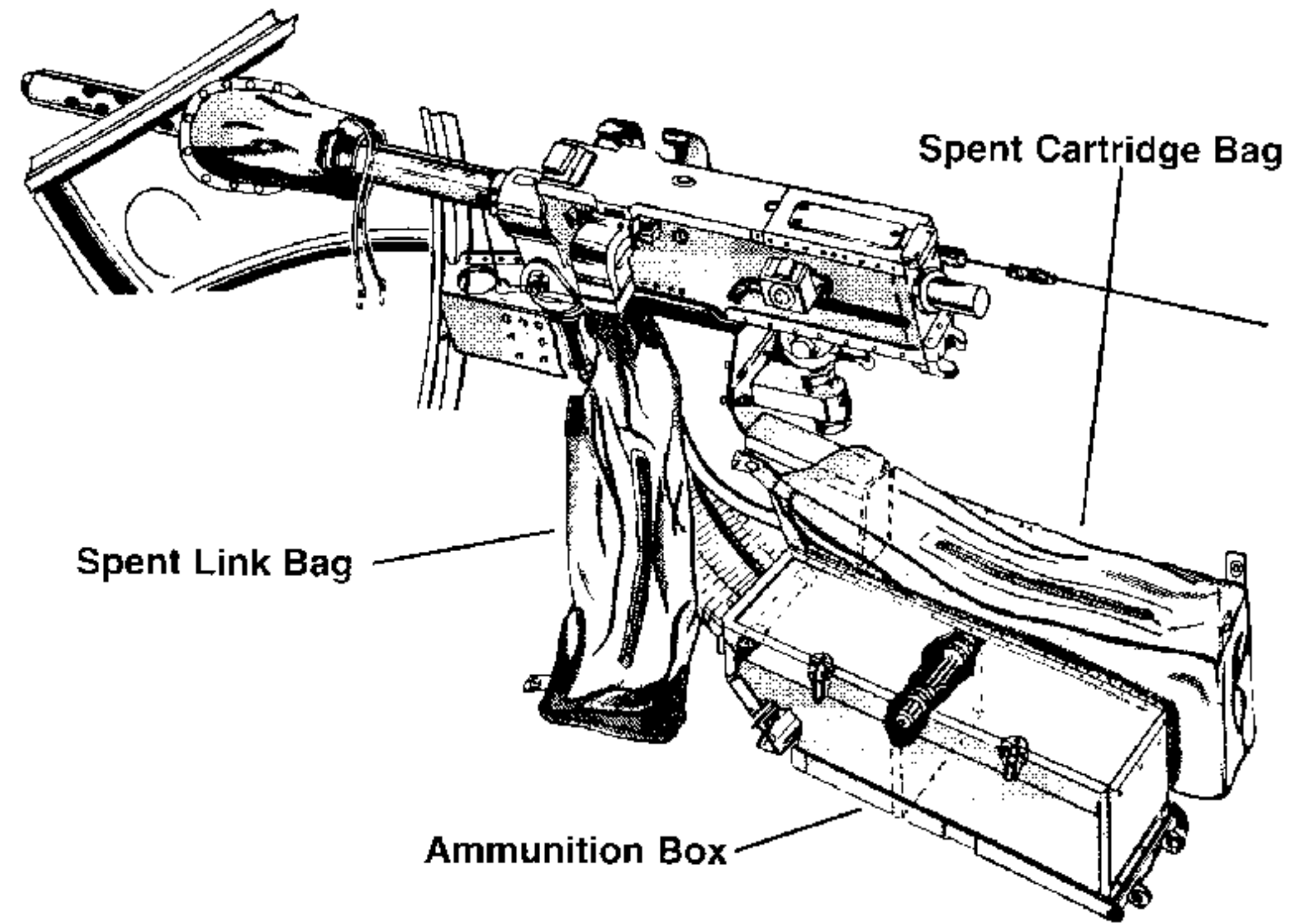

## Twin Fixed .50 Caliber Nose Guns

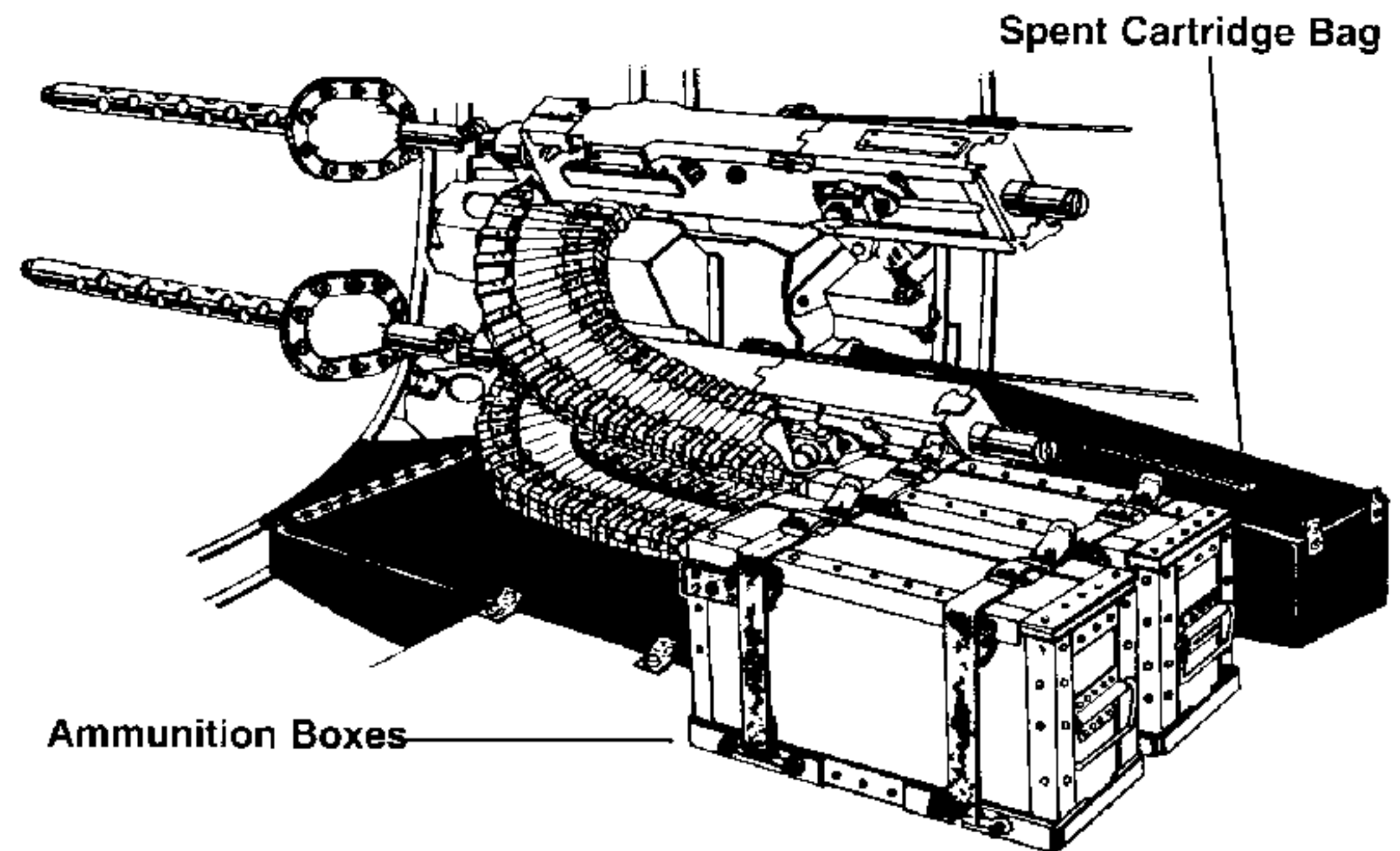



## Cockpit Engine Control Pedestal

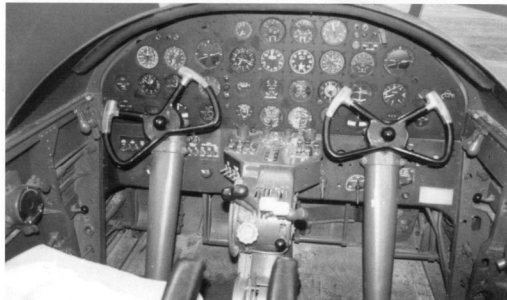
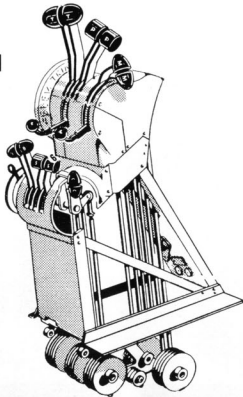

As a non-flying restoration, the Kalamazoo B-25 retains the original instrument layout, free of the historical contamination caused by modern navigation equipment necessary in flying restorations. The control pedestal switch panel (forward of the throttles quadrant) contains magneto switches for both engines, primer, fuel boost, and starter switches. The large "buttons" at the upper corners are prop feathering controls. (Lou Drendel)



The cockpit of the non-flying B-25J of the Kalamazoo Aviation History Museum. The seats were adjustable vertically as well as fore-and-aft. Gunships were usually flown by a single pilot — the co-pilot/cannoneer's seat being reduced to a simple padded bucket. The two black knobs at the lower left rear corner of the co-pilot seat control aileron and rudder trim tabs. (Lou Drendel)



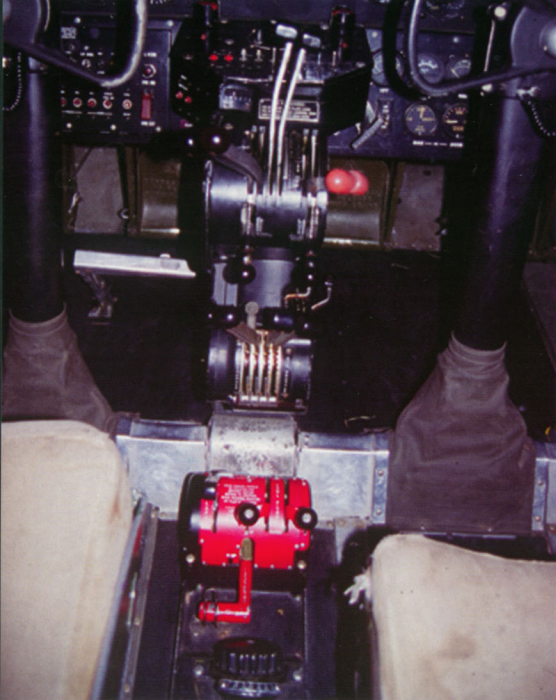

The central pedestal housed all of the engine controls. The red panel at the rear (bottom) of the pedestal contains levers for control of the engine cowl flaps, landing flaps, and landing gear. The levers immediately forward of this panel contain levers for control of the superchargers (left) and carburetor air (right). Most of what can be seen above the lower edge of the instrument panel has been changed from the original to accommodate the demands of flying in a modern air traffic control environment. (Lou Drendel)

## Pilots' Seats

B-25J Pilot's Seat



Wooden Seat



Co-Pilot/Cannoneer Metal Seat

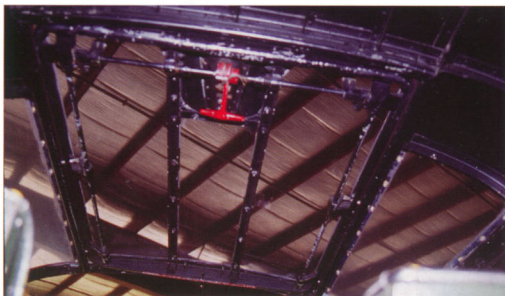
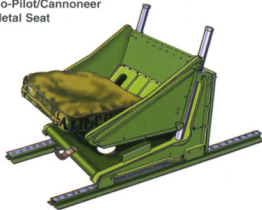

The top of the cockpit canopy had an emergency escape hatch. The red handle at the rear is the emergency release. This is a civilian restoration of the B-25H and lacks the vintage radio equipment which would be installed just forward of the escape hatch. (Lou Drendel)

## Turret Installation

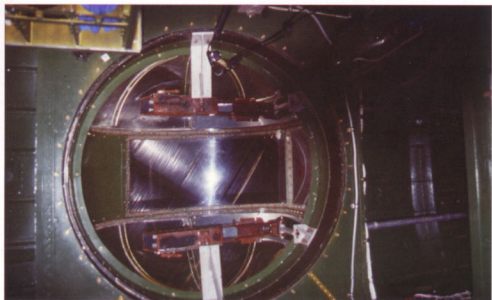
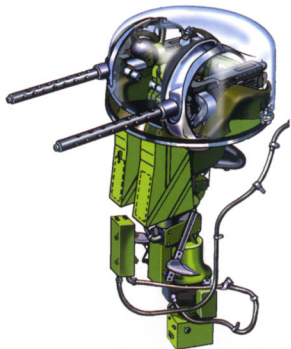

The B-25H top turret has been gutted and shows the canopy divisions, but little else. The replica machine guns look almost real from the exterior, but lack all interior detail. When fitted, the gunner's seat and turret drive mechanism would extend downward, occupying much of the front crew entry well. (Lou Drendel)

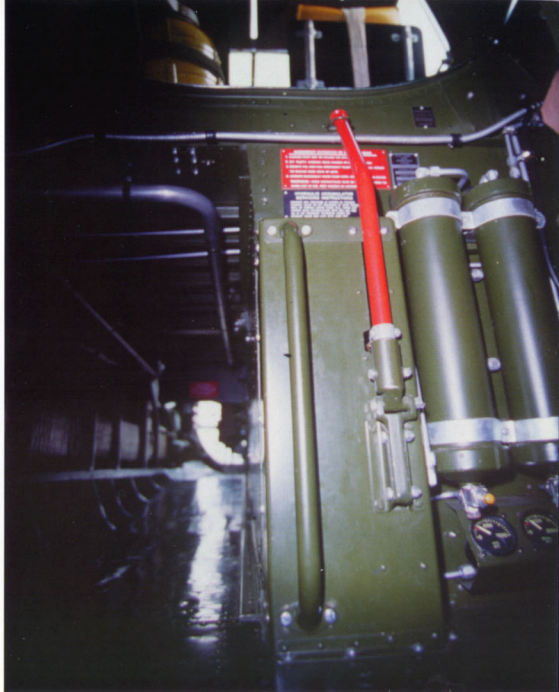

The red handle is the landing gear emergency hand-pump, while the two cylinders to the right are the Main Hydraulic System Accumulator and the Main Brake System Accumulator. The tunnel leads to the nose compartment. (EAA photo by Phil High)



"PANNELL JOB", a B-25C of the 500th BS, 345th BG, in the Pacific Theater. The aircraft has been field modified to the gunship configuration by deleting the bombardier, painting over the nose glazing, adding four 50 caliber machine guns to the nose and early style package guns to the fuselage sides. A wind deflector has been added to the window in the aft fuselage, indicating the likely presence of waist guns on missions. The 345th Bomb Group started operating in New Guinea and carved a path across the Western Pacific to the Philippines.

## Main Landing Gear Doors

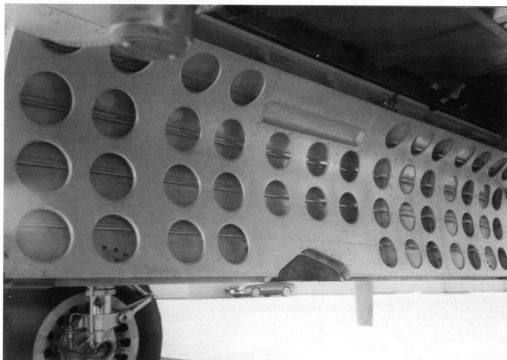
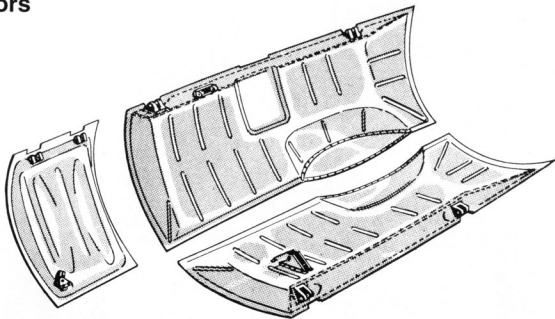

The inside of the bomb bay doors did not appreciably change from model to model. The dome at upper left is a rotating beacon installed on this civilian restoration. (Dave Mason)

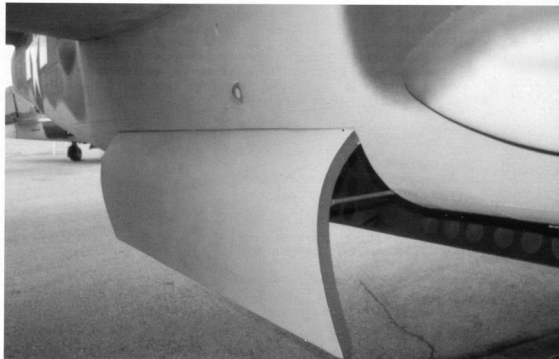

Right bomb bay door, looking aft. The B-25J carried a large variety of ordnance in its bomb bays, including bombs of 100, 300, 500, 600, 1100, and 2,000 pound sizes. A dropable fuel tank could also be carried in the bomb bay. (Lou Drendel)

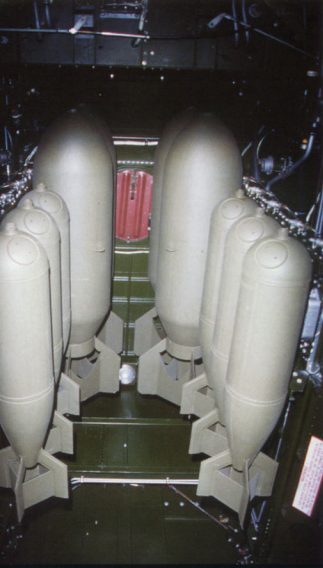

(Above) The mixed bomb load capability of the B-25J is demonstrated by the load of inert bombs carried in the bomb bay of the Cavanaugh B-25. Bombs could be hoisted into position using winches attached to the outside of the bomb bay. Alternatively, an electric winch carried in the aircraft could also be used. (EAA photo by Phil High)

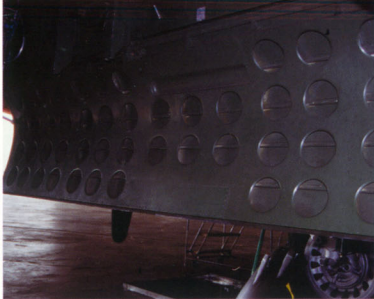

The bomb load of the B-25H consisted of 4,000 pounds, carried as 2,000 - 1,000 - or 500 pounders. The 2,000 pound bombs, requiring a special rack assembly, were deleted after the 151st B-25J came off the assembly lines. (Lou Drendel)

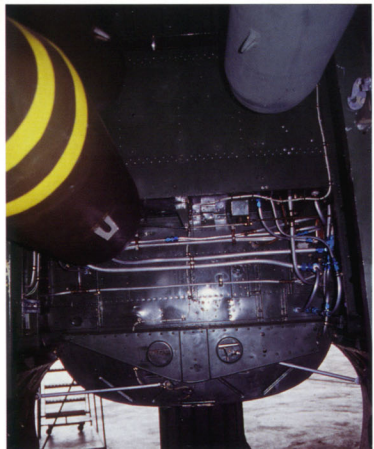

(Above) The area behind the pilot's seats held map and first aid cases, communications and navigation radios and oxygen bottles. Radio and navigation operating controls were on the left and right cockpit sidewalls respectively. Most of the radio and navigation sets themselves were in the navigator/turret gunner compartment behind the cockpit and waist compartment. (EAA photo by Phil High)

(left) The bomb bay of the B-25H looking forward. In case of hydraulic failure, the bomb bay doors could be cranked open or closed with a hand crank stored in the waist compartment. (Lou Drendel)



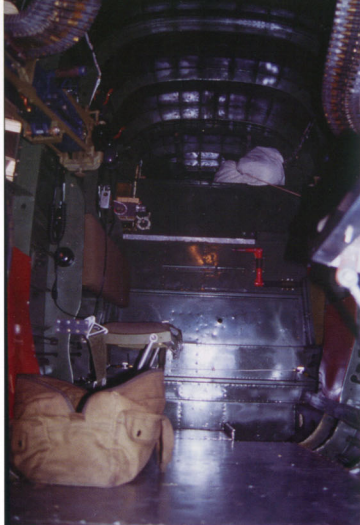

(Above) Looking forward from the rear crew entry hatch, the tail gunner's seat is in the right foreground, while the waist gunner's seats are forward and to the left. The red crank stowed on the rear panel is the emergency wing flap crank. A small compartment in the roof of the waist section held a life raft for the crew. The life raft compartment door could be released by the pilot or waist gunner. (Lou Drendel)



A circular emergency exit door was on the right side of the mid-fuselage compartment next to the waist gunner's position. (Lou Drendel)

The Browning 50 caliber M-2 machine gun replica mounted in the waist gun position of the B-25H is so accurate, it had to be registered with the Bureau of Alcohol Tobacco and Firearms (BATF). Ammo was supplied from boxes further aft on the fuselage side-walls and fed to the guns via feed chutes. (Lou Drendel)

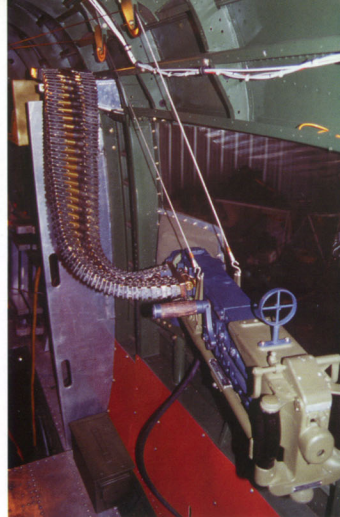

The Browning M-2 machine gun was used on a wide variety of aircraft in both fixed and flexible mounts. It fired a 12.7mm (50 cal) round at a rate of 750 to 850 rounds per minute. It has proven to be such a reliable gun that a faster firing (900-1,100 RPM) version (M-3) remained in production into the 1980s. (Lou Drendel)

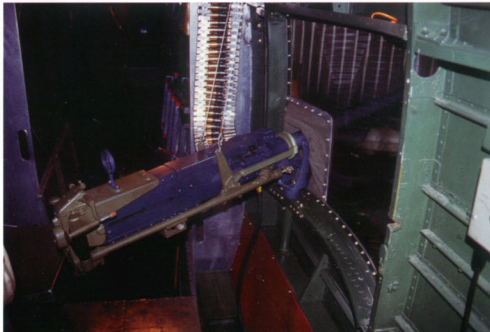



(Above) B-25J-1-NC (43-27475) of the 310th Bomb Group landing at an American base in Tunisia. The absence of all armament indicates that this bomber was used as a high-speed transport and courier. (Norm Taylor Collection.)

(Below) A factory fresh B-25J-5-NC (43-27793). The rear fuselage of the B-25H and J was deepened by 7" to make room for the tail gunner position. The bumps behind the dorsal turret are armored deflector plates designed to prevent the guns from firing into the back of the tail gunner's canopy. (Norm Taylor Collection)

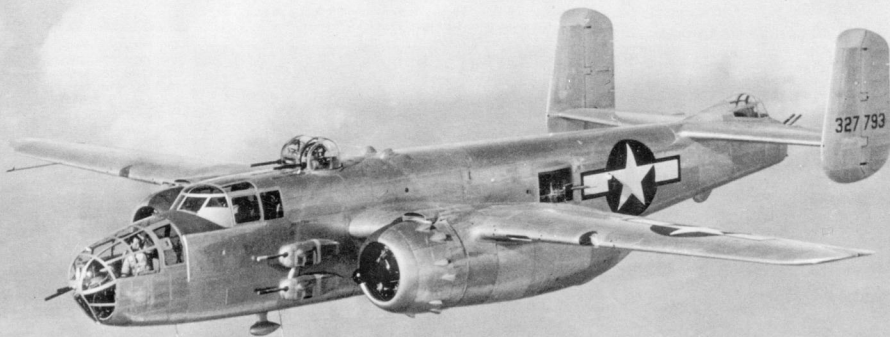

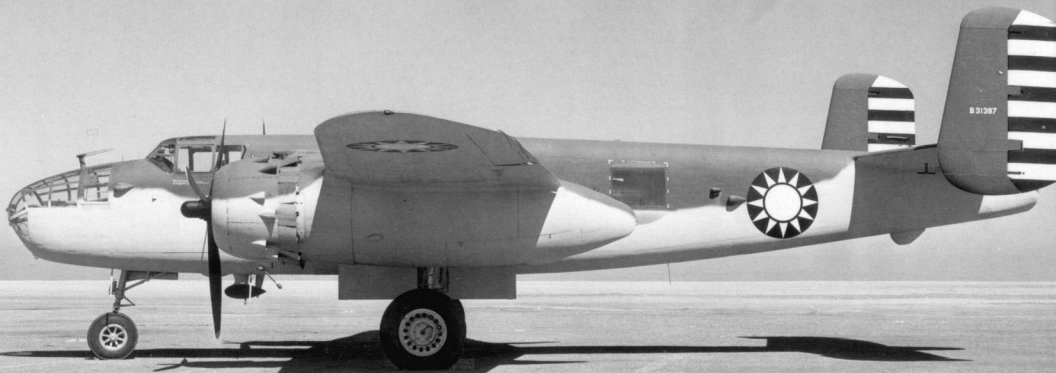

(Above) This B-25J-30-NC (43-31387) of the Nationalist Chinese Air Force is one of only six J models supplied to the Nationalist government. Static discharge wicks hang from the rudder and aileron. (B. Balogh via Norm Taylor Collection.)

(Below) A TB-25J-15-NC (44-28738) at Detroit Metropolitan Airport on 3 May 1950. The TB-25J was converted from the AT-24D advanced trainer which trained WW II pilots at Brooks Field, Texas, beginning in 1943. A small tie-down loop has been added to the tail bumper. (W. Balogh via Dave Menard via Norm Taylor Collection.)



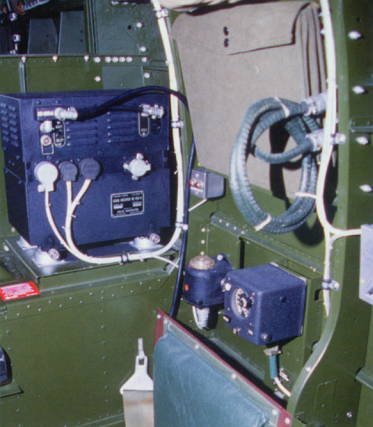

(Left) The area behind the cockpit contained space for the navigator and various radio communications and navigation equipment. The compartment also served as the cannoneer's station on B-25 G and H gunships. A bin containing twenty one 75mm cannon rounds was also stored here. (EAA photo by Phil High)

(Right) The waist gunners ride-along seat is located on the port side of the fuselage, just aft of the bomb bay. The round, black object at the left is a throwback to a bygone era...an ashrtry! (Lou Drendel)

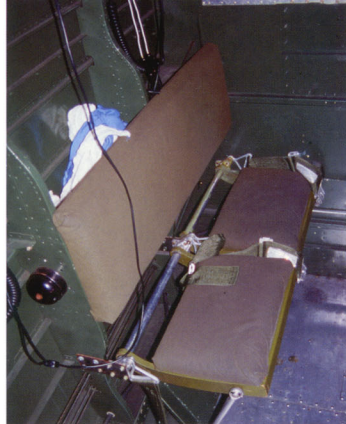

(Left) The navigator was given a folding table for maps and charts work. When the turret was moved forward on the B-25H and J, much of this space was taken up by the turret drive mechanism. Gunships had additional armor plating installed here to protect the cannoneer and the 75mm storage bin. (EAA photo by Phil High)

(Right) The extreme rear of the fuselage housed the tail gunner's position in the B-25H and J. The ammunition belt chutes for the twin 50 caliber machine guns in the hydraulically operated M-7 Bell tail turret are at upper left and right. They were fed by 400 round ammunition boxes in the rear fuselage. Electric motors were used to pull the rounds from boxes and provide a steady feed to the guns. The gunner is secured to the small seat (center) by a seat belt that encircles his waist completely and is strapped to the floor by twin belts. (EAA photo by Phil High)

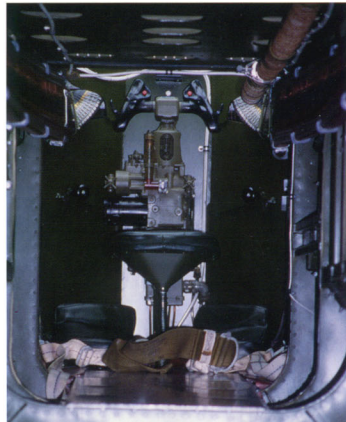



B-25A, 34th Bombardment Squadron, 17th Bombardment Group camouflaged in Olive Drab over Neutral Gray. The US insignia appears on the top and bottom of both wings. U.S. ARMY is painted under the wings.

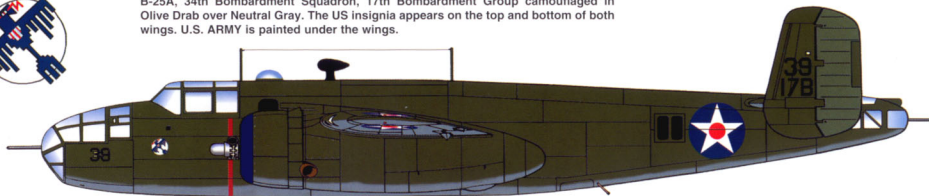

B-25B, aircraft number 11, of Doolittle's carrier borne strike force in April of 1942. Fresh Olive Drab paint covers the name "HARI CARRIER" on the nose. The ventral turret has been removed and replaced with a fuel tank. Fake tail guns have been added to the rear observation dome.

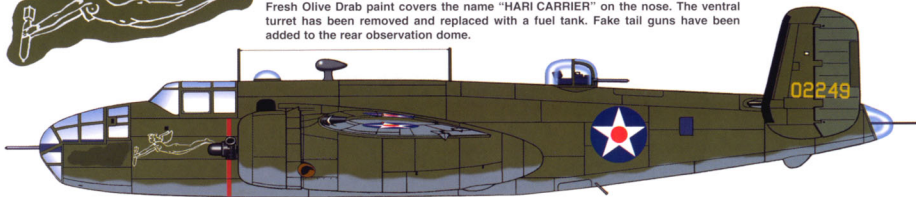

B-25C, 487th BS, 340 BG operating in the Western North African Desert during late 1942. The aircraft is camouflaged in Sand and Olive Drab. The US insignia is encircled with a yellow ring used on Allied aircraft associated with the Torch landings in November of 1942. The ringed insignia is also carried on the upper left and lower right wings.

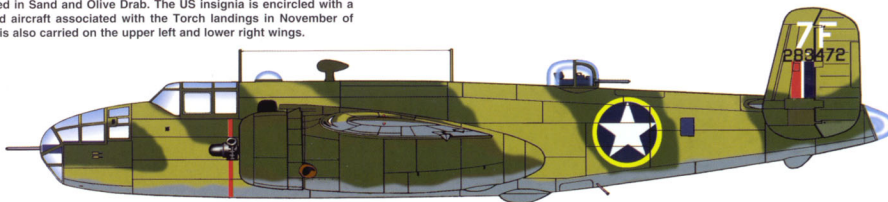



## Tail Gun Control Yoke

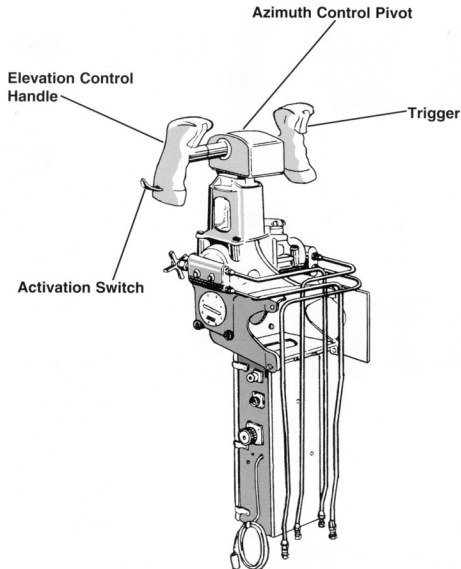

The gunner grasped the handles with both hands with each hand resting on the activation switches. These switches turned the system on and allowed the guns to move and fire. Azimuth control was induced by turning the handles left and right about the pivot point. Elevating the guns was accomplished by rotating the handles backwards (up) or forwards (down) much like a fighter control stick. Squeezing the triggers with the index finger fired the guns.



(Above) Post-war survivors at Dobbins AFB, Georgia in 1948 included F-47's (rear), Beech C-45 and this B-25J-25-NC, (44-30790). Weathered Dzus fasteners outline each of the removable cowl panels. Small patches cover the holes left after the side package guns were removed. (116th TFW, Georgia ANG via Norm Taylor Collection.)

(Below) TB-25K-25-NC (44-30643), of the 103rd Fighter Squadron, Pennsylvania ANG, during 1956. 117 B-25Js were modified as TF-25Ks by Hughes with the installation of the E-1 fire control system to train F-89 and F-94 radar operators. A rounded fairing has been placed over the tail position. (G. Sommerich via Norm Taylor Collection.)

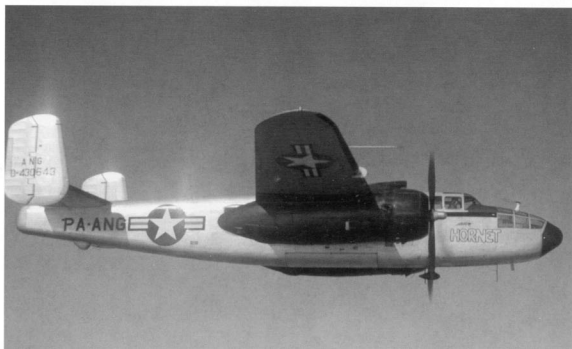



(Above) B-25J-30-NC (44-31178) of MATS, September 1955. The modified exhaust system was common to many post-war B-25s and included a Stromberg carburetor, as evidenced by the higher, narrower intake on top of the nacelle. The new exhaust system collected the exhaust of the top seven stacks and vented it through a single large exhaust port. The windshield wipers are also a post-war addition. (Dave Menard via Norm Taylor Collection.)

(Below) A VB-25J-30-NC (44-30971) of USAF Headquarters Command at Logan IAP, Boston, Massachusetts. It carries the flag of a Lieutenant General. Three VB-25s were operated by the 1100th Special Air Missions Group at Bolling Field near Washington, D.C. They were used as executive transports for the Pentagon. Aircraft dropping bombs or Generals are often met with the same reaction by base personnel... (Dave Menard via Norm Taylor Collection.)



Mitchell II (B-25C) of No.180 Squadron, Royal Air Force operating over northwestern Europe during late 1943 through 1944. The aircraft is camouflaged in an overall dark grey-green color with Medium Sea Grey under surfaces and Red codes. The standard RAF red and blue roundel is carried on the upper wings. No insignia is carried on the wing under surface.

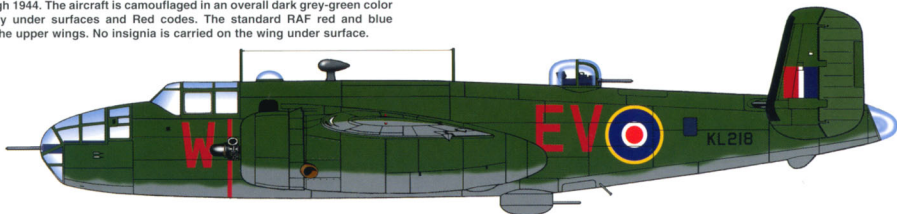

PBJ-1 (B-25D) of the US Marine Corps operating near Espirito Santo, New Hebrides island group during February of 1944. The aircraft is camouflaged in Blue-Gray over Light Gray. A field modified tail gunner's position has been added and 50 caliber guns poke through the waist hatches.

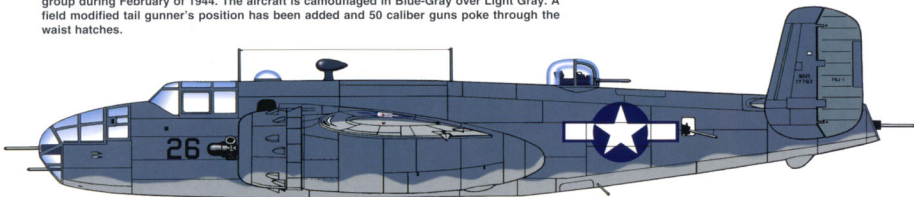

B-25D of No. 2 Squadron, Royal Australian Air Force. The aircraft is camouflaged in overall Foliage Green and carries the RAAF insignia in six positions and Medium Sea Grey codes. An older, larger insignia has been covered with fresh paint. This aircraft carries the new factory installed waist guns and tail guns fitted to late B-25Ds and Gs.

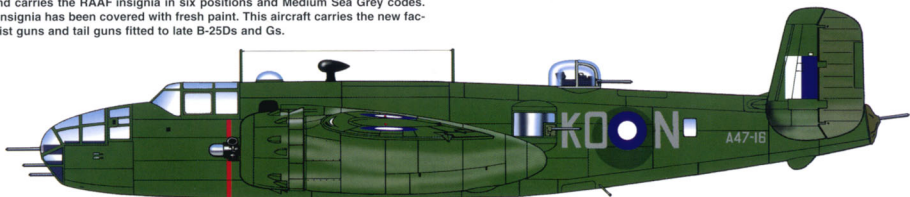

B-25J of the 445th BS, 321st BG, in Italy during 1945. The aircraft is camouflaged in Olive Drab over natural metal. The red fin tips denote the group, the "1" indicates the squadron, and the "3" is the plane-in-squadron number. This aircraft survived over 120 missions and was returned to the U.S.

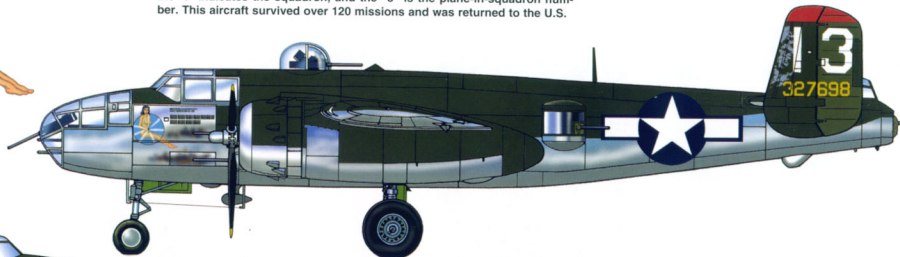

B-25D, "RED WRATH" of the 498th BS, 345th BG, Dobodura, New Guinea during 1944. Four 50 caliber machine guns poke through the over painted nose glazing. Early style package guns are on the fuselage sides while waist and tail guns have been added in the field.

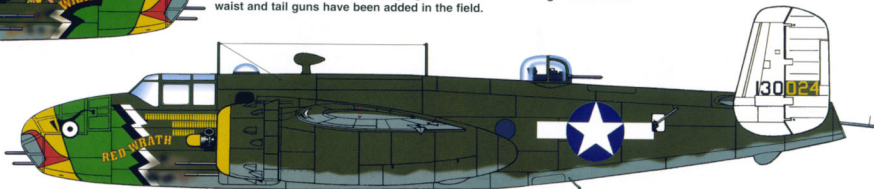

B-25J "Lady Lil" of the 498th BS, 345th BG, Clark Field, Philippines during 1945. The aircraft is overall natural metal and is equipped with a factory fitted 8-gun nose, but lacks the side package guns. Insignia on the starboard vertical stabilizer lacks the Olive Drab band and has black serial numbers.

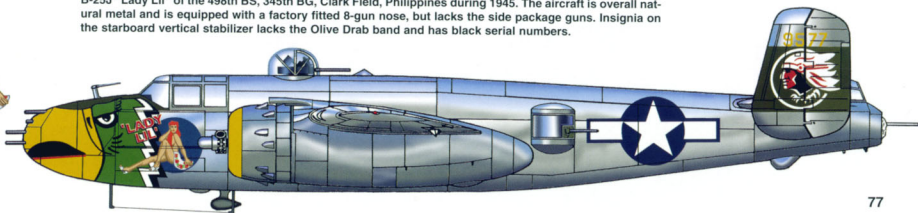

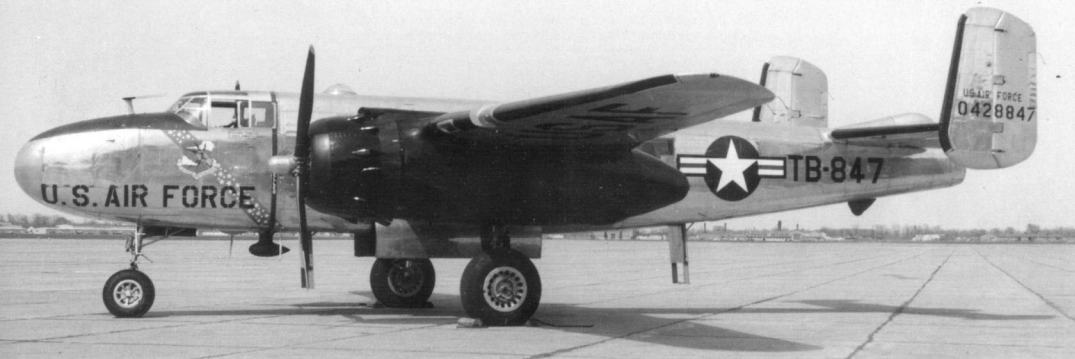

(Above) TB-25N-16-NC, (44-28847) is one of forty seven B-25N advanced pilot trainers produced by modifying B-25Js. This Mitchell carries the SAC star-spangled banner and shield and is judged to be obsolete, as evidenced by the "O" prefix to its serial number. Despite its obsolescence, the aircraft is highly polished and exquisitely marked. The tail gunner's canopy has been painted over. (B. Balogh via Norm Taylor Collection.)

(Below) TB-25N-16-NC (44-28833) at Peoria, Illinois in the 1950s. The last of the TB-25s were phased out of active service at James Connally AFB, Texas on 18 January 1960. The fin tips and fuselage band on this Mitchell are yellow with black trim and lightning bolt. TB-25Ns were all converted "J" models, both solid and glass-nosed versions. The glass nose has been painted over on this aircraft. (Dave Menard via Norm Taylor Collection.)







(Above) Beginning in 1948 over 600 B-25s were modified as advanced pilot trainers with seven additional seats in the fuselage to accommodate several students per flight (they took turns flying the airplane). Over 30,000 USAF multi-engine pilots were trained on TB-25s during the twelve years of TB-25 service. This TB-25J-20-NC (44-29115) was parked at Detroit Airport, in July of 1955. The remains of a larger insignia is still seen on the fuselage side. (Dave Menard via Norm Taylor Collection.)

(Below) B-25J-35-NC (45-8822) of the 1st Air Force at Detroit, Michigan, in July of 1955. This B-25 was 7th from the end of the line delivered to the Air Force in flyable condition. Seventy two B-25s were delivered flyable but not completed as part of the contract termination. Despite the USAF markings, the pilot appears to be wearing a white T-shirt — not exactly a regulation uniform. (Dave Menard via Norm Taylor Collection.)



B-25G Gunship of the 499th BS, 345th BG operating from Biak Island off northwest New Guinea, in 1944. The US insignia still lack the blue outline. The cowl rings are blue and the starboard cowl ring has a thin white outline. The 75mm nose gun has been replaced by two machine guns. The ventral turret has been deleted and waist guns added.

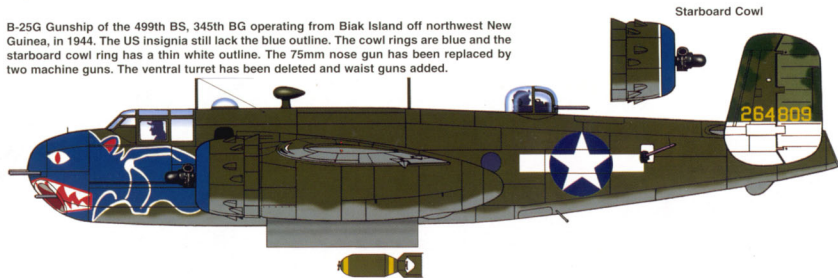

B-25H "CLANA LOUISE", 498th BS, 345th BG at Nadzab, New Guinea during 1944. The aircraft is camouflaged in standard Olive Drab over Neutral Gray, with yellow cowl rings and white vertical stabilizers. "CLANA LOUISE" is in yellow with black shadow edging. The aircraft is not equipped with the side package guns commonly used on gunships.

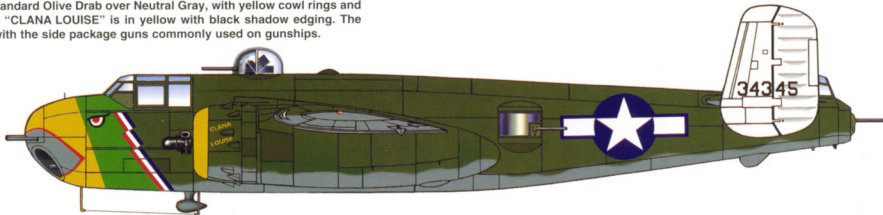

B-25D, "Tondelayo" of the 500th BS, 345th BG operating from Nadzab, New Guinea during 1944. Camouflage is Olive Drab over Neutral Grey with red cowl rings and a white stripe completely encircling the fuselage in front of the dorsal turret. The US insignia is believed to have been toned down with gray paint. Four machine guns protrude through the painted over nose glazing.

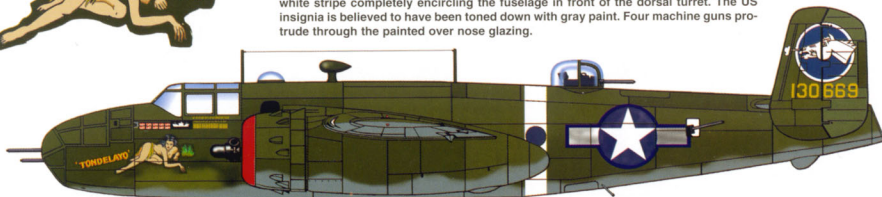



ISBN 0-89747-379-5  
90000>



9 780897 473798

Lowy D. D. 2002