

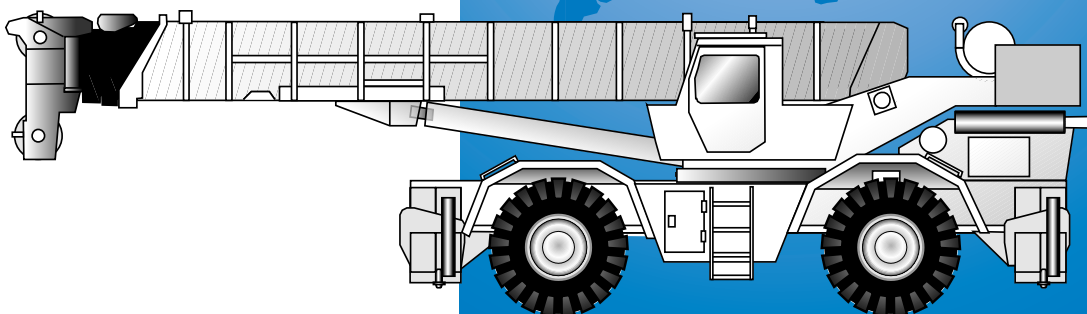

RT880



Rough Terrain Hydraulic Crane

Dimensions

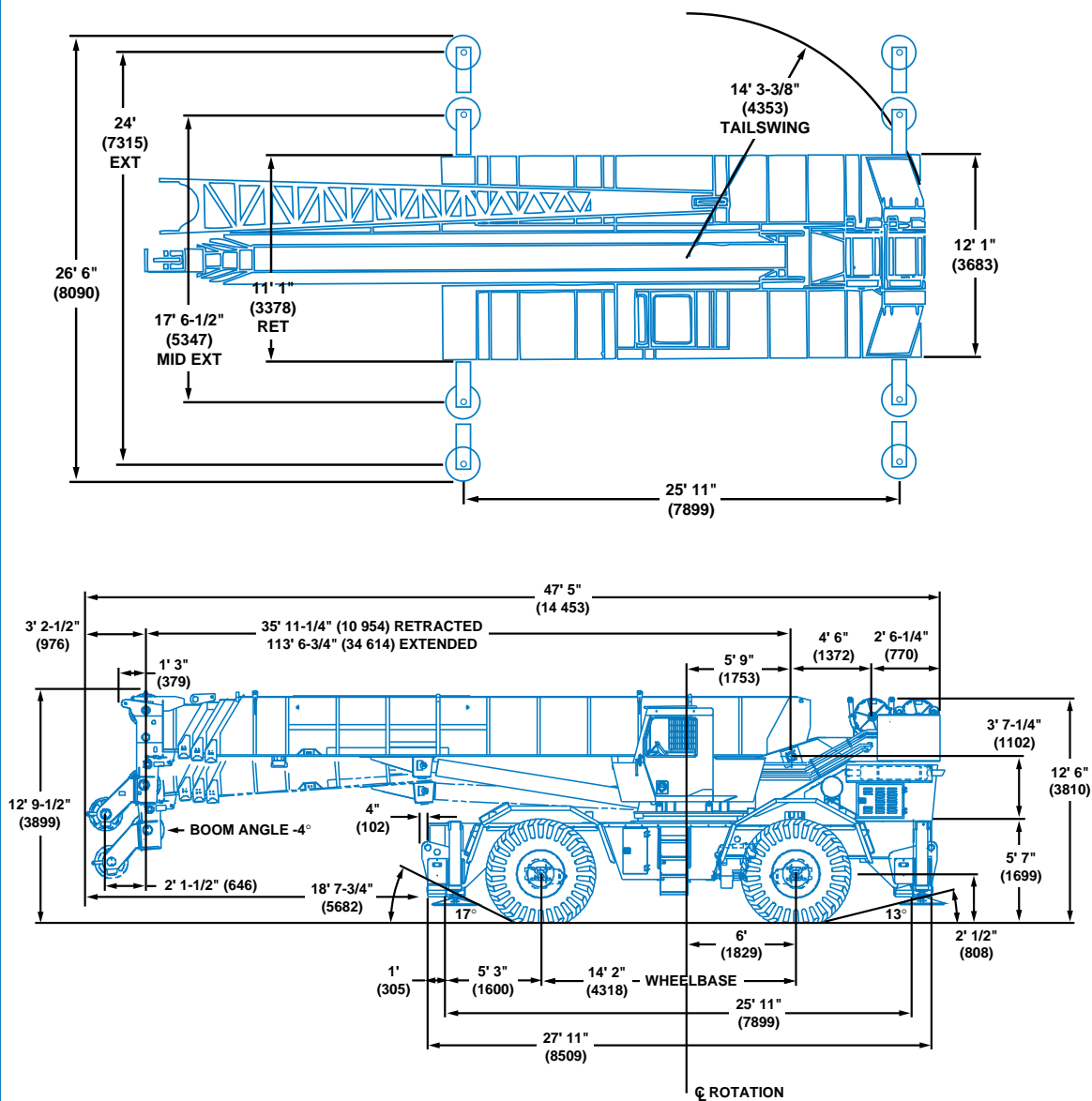

Note: () Reference dimensions in mm

- Turning Radius 25' (7620 mm)**
- Front Axle Load 51,829 lbs. (23 509 kg)**
- Rear Axle Load 58,045 lbs. (26 329 kg)**
- Gross Vehicle Weight 109,874 lbs. (49 838 kg)**



Working range



POWER PINNED
36 - 114 ft. (11.0 - 34.7 m)

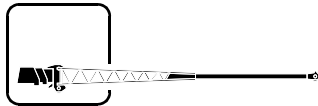

33 - 58 ft.
(10.0 - 17.7 m)

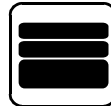

14,000 lbs.
(6350 kg)

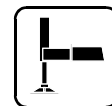

360°

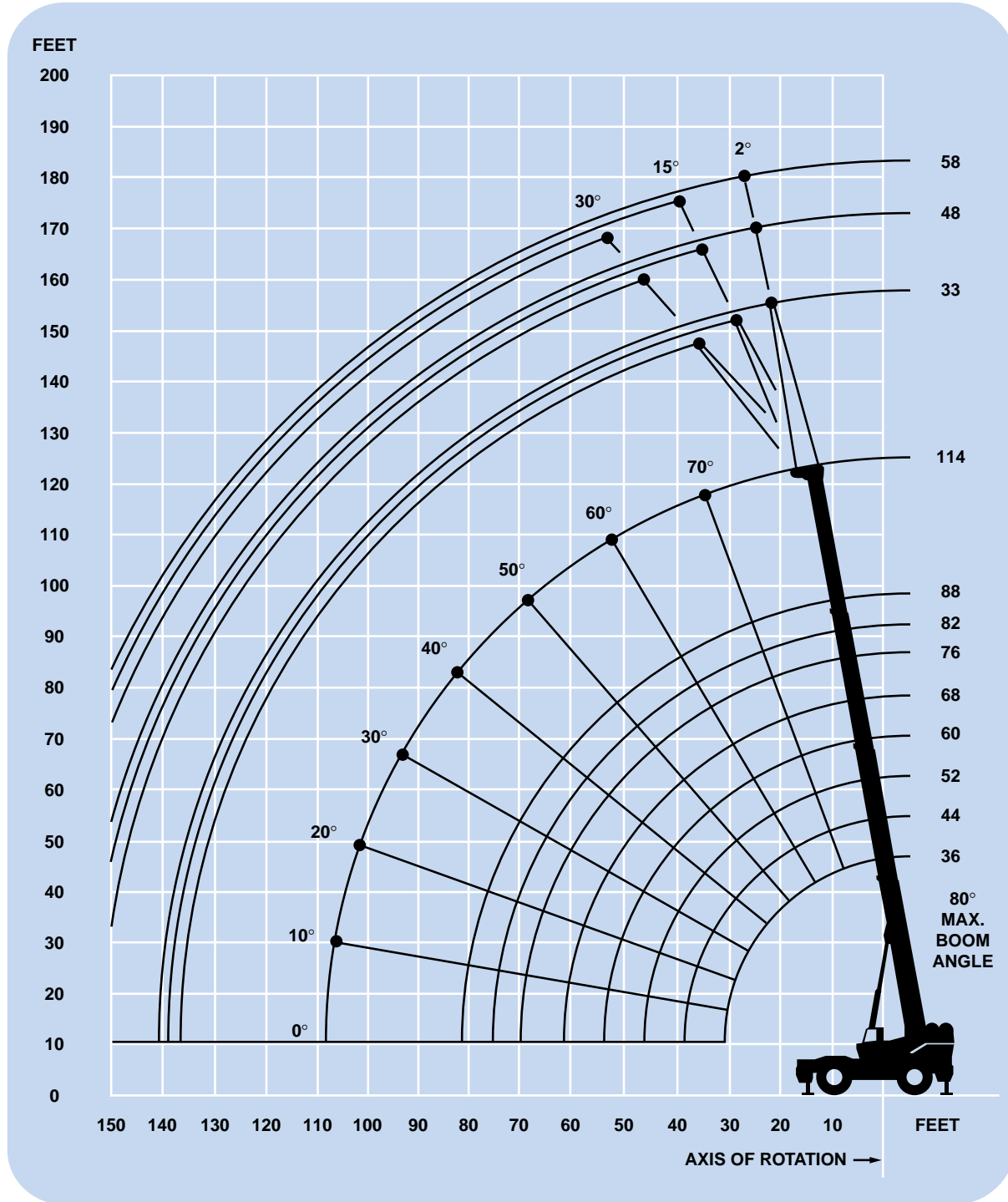

6'-6"

7'-9"

DIMENSIONS ARE FOR LARGEST GROVE FURNISHED HOOK BLOCK AND HEADACHE BALL, WITH ANTI-TWO BLOCK ACTIVATED.



Superstructure specifications

Boom

36 ft. - 114 ft. (11.0 m - 34.7 m) four-section power pinned boom. Maximum tip height: 122 ft. (37.1 m).

*Optional Boom

36 ft. - 114 ft. (11.0 m - 34.7 m) four-section full power boom. Maximum tip height: 122 ft. (37.1 m).

Swingaway Extension

33 ft. (10.0 m) lattice swingaway boom extension. Offsettable at 2°, 15° or 30°. Stows alongside base boom section. Maximum tip height: 153 ft. (46.6 m).

*Optional Telescopic Swingaway

33 ft. - 58 ft. (10 m - 17.7 m) telescoping lattice swingaway extension offsettable at 2°, 15° or 30°. Stows alongside base boom section. Maximum tip height: 178 ft. (54.2 m).

*Optional Jib

14 ft. (4.3 m) lattice sections combine with a 32 ft. (9.8 m) tip section to provide 46 ft. (14.0 m), 60 ft. (18.2 m), 74 ft. (22.5 m) and 88 ft. (26.8 m) jib lengths. Jib is cable suspended and can be offset at 5°, 17° and 30°. Maximum tip height: 206 ft. (62.7 m).

Boom Nose

Six Nylatron sheaves mounted on heavy duty tapered roller bearings with removable pin-type rope guards. Removable auxiliary boom nose with removable pin type rope guard.

Boom Elevation

Two double acting hydraulic cylinders with integral holding valves provide elevation from -4° to 80°.

Load Moment & Anti-Two Block System

Standard load moment and anti-two block system with audio-visual warning and control lever lockout. These systems provide electronic display of boom angle, length, radius, tip height, relative load moment, maximum permissible load, load indication and warning of impending two-block condition.

Cab

Full vision, all steel fabricated with acoustical lining and tinted safety glass throughout. Complete driving controls and engine instrumentation. Dash mounted control levers for all craning functions. Other standard features include: hinged skylight, sliding left side door and sliding right side window, electric windshield wash-wipe, propane heater, circulating air fan, fire extinguisher, seat belt and manual skylight wiper.

Swing

Ball bearing swing circle with 360° continuous rotation. Planetary glide-swing with foot applied multi-disc brake. Spring applied hydraulically released parking brake, one position mechanical house lock and hand operated 360° mechanical house lock, operated from cab. Maximum speed: 2.0 RPM.

Counterweight

Integral with turntable mast. (P.P. boom)

With main hoist only: 14,000 lbs. (6350 kg)

With main & aux.: 12,050 lbs. (5466 kg)

*Optional (F.P. boom)

With main hoist only: 13,200 lbs. (5988 kg)

With main & aux.: 11,250 lbs. (5103 kg)

Hydraulic System

Four main pumps with a combined capacity of 178 GPM (674 LPM).

Maximum operating pressure: 2500 psi (172.4 bar).

Four individual valve banks.

Return line type filter with full flow by-pass protection and service indicator. Replaceable cartridge with micron filtration rating of 7/17/22.

225 gallon (852 L) reservoir. Remote mounted oil cooler with thermostatically controlled electric motor driven fan/air to oil.

System pressure test panel with quick release type fittings for each circuit.

Hoist Specifications

Main and *Auxiliary Hoist

Planetary reduction with automatic spring applied multi-disc brake. Electronic hoist drum rotation indicator, and hoist drum cable followers.

	HO30B - 26G	
	High Range	Low Range
Maximum Single Line Pull: (1st Layer)	7,655 lbs. (3473 kg)	15,309 lbs. (6944 kg)
Maximum Single Line Speed: (5th Layer)	548 FPM (167 m/min)	140 FPM (43 m/min)
Maximum Permissible Line Pull w/5:1 Strength Factor:	12,920 lbs. (5860 kg)	
Rope Diameter:	3/4" (19 mm) 18 x 19 Class	
Rope Length:	750 ft. (229 m) Supplied with Basic Std. unit.	
Maximum Rope Stowage:	968 ft. (295 m) (3/4" 18 x 19 Class)	

*Denotes optional equipment

Carrier specifications

Chassis

Box section frame fabricated from high-strength, alloy steel. Integral outrigger housings and front/rear towing and tie down lugs.

Outrigger System

Four hydraulic telescoping single-stage, double box beam outriggers with inverted jacks and integral holding valves. Three position setting. All steel fabricated, quick release type outrigger floats, 30.5" (775 mm) diameter.

Maximum outrigger pad load: 110,973 lbs. (51 211 kg).

Outrigger Controls

Controls and crane level indicator located in cab.

Engine

Cummins 6CTA 8.3 L diesel, six cylinders, turbocharged, 250 bhp (186 kW) (Gross) @ 2,200 RPM.

Maximum torque: 794 ft. lbs. (1077 Nm) @ 1,500 RPM.

*Optional Engine

Caterpillar 3306C - DITA diesel, six cylinders, naturally aspirated, 250 bhp (186 kW) (Gross) @ 2,100 RPM.

Maximum torque: 845 ft. lbs. (1146 Nm) @ 1,400 RPM.

Fuel Tank Capacity

100 gallons (379 L)

Transmission

Full powershift with 6 forward and 6 reverse speeds.

Rear axle disconnect for 4 x 2 travel.

Electrical System

Two 12 V - maintenance free batteries.

12 V starting/lighting.

Drive

4 x 4.

Steering

Fully independent power steering:

Front: Full hydraulic steering wheel controlled.

Rear: Full hydraulic hand lever controlled.

Provides infinite variations of 4 main steering

modes: front only, rear only, crab and coordinated.

Rear steer indicating gauge.

Axles

Front: Drive/steer with differential and planetary reduction hubs rigid mounted to chassis.

Rear: Drive/steer with differential and planetary reduction hubs pivot mounted to frame at the center of chassis providing up to 12" (305 mm) oscillation.

Oscillation Lockouts

Automatic full hydraulic lockouts on rear axle permits oscillation only with boom centered over the front.

*Oscillation lockout override control.

Brakes

Full air split circuit operating on all wheels.

Spring-applied, air released parking brake operating on front axles.

Tires

29.5 x 25 - 28PR (E-3) Bias earthmover type, tubeless.

*Optional: 33.25 x 29 - 26PR.

Lights

Full lighting including turn indicators, head, tail, brake, and hazard warning lights.

Maximum Speed

18.7 MPH (30.1 kph).

Gradeability (Theoretical)

127% (Based on 118,000 lbs. [53 525 kg] GVW)

29.5 x 25 tires, pumps disengaged.

Miscellaneous Standard Equipment

Full width steel fenders, dual rear view mirrors, electronic back-up alarm, light package, air dryer, tire inflation kit, A/V warning system, 360° mechanical house lock, cab work lights.

*Optional Equipment

*Hookblocks/headache ball

*Spare wheel assembly

*Pintle hook front/rear

*Tow winch (front mounted - max. single line pull:

15,000 lbs. [6804 kg]; max. speed: 92 FPM [28 m/min])

*Cab spotlight

*360° flashing light

*Engine block heater

*Tool kit

*Dual base boom mounted flood lights

*Diesel heater/defroster

*Tire inflation kit

*Emergency steering pump

*Air conditioning

*LMI light bar

**Denotes optional equipment*



POWER PINNED
36 - 114 ft.
(11.0 - 34.7 m)



14,000 lbs. (6350 kg)
*12,050 lbs. (5466 kg)



100%
26' 6" (8.9 m)
Spread



360°



Pounds

(Feet)	36	44	52	60	68	76	82	88	Power Pin. Fly Ext. & 88 ft.	114
10	*160,000 (67)	106,700 (71.5)	101,600 (74.5)	100,000 (77)	96,700 (79)					
12	120,000 (63)	106,700 (68.5)	101,600 (72)	96,500 (75)	87,850 (77)	84,700 (78.5)				
15	103,450 (57.5)	103,450 (64)	95,300 (68.5)	84,900 (72)	79,180 (74.5)	77,550 (76)	70,250 (77.5)	64,500 (79)		
20	80,650 (47)	80,650 (56.5)	80,650 (62.5)	70,550 (66.5)	64,310 (70)	63,800 (72)	59,400 (74)	55,000 (75.5)	38,750 (80)	
25	62,200 (34)	62,200 (48)	62,200 (55.5)	60,150 (61)	54,000 (65.5)	49,700 (67.5)	47,150 (70.5)	45,600 (72)	34,000 (77)	
30		48,450 (38)	48,450 (48.5)	48,450 (55.5)	46,650 (60.5)	42,750 (63.5)	40,450 (66.5)	39,150 (68.5)	30,300 (74.5)	
35		39,500 (24.5)	39,500 (40.5)	39,500 (49.5)	39,500 (55.5)	37,300 (58.5)	35,200 (62.5)	34,050 (65)	27,250 (71.5)	
40			31,220 (30.5)	31,220 (42.5)	31,220 (50)	31,220 (54)	31,000 (58.5)	29,550 (61.5)	24,750 (69)	
45			24,800 (14.5)	24,800 (34.5)	24,800 (44)	24,800 (49)	24,800 (54)	24,800 (57.5)	22,650 (66)	
50				19,880 (24)	19,880 (37.5)	19,880 (43.5)	19,880 (49.5)	19,880 (53.5)	20,800 (63)	
60					13,280 (17.5)	13,280 (30.5)	13,280 (39)	13,280 (44)	17,050 (57)	
70							9,200 (24.5)	9,200 (33)	12,480 (50.5)	
80								6,180 (14)	9,100 (43)	
90									6,670 (34.5)	
100									4,710 (23)	
Minimum boom angle (deg.) for indicated length (no load)									0	0
Maximum boom length (ft.) at 0 deg. boom angle (no load)									88	114

NOTE: () Boom angles are in degrees.

*13 parts of line required to lift this capacity (using aux. boom nose). Refer to Operator's and Safety Handbook for reeving diagram.

A6-829-012485A

Boom Angle	36	44	52	60	68	76	82	88
0°	25,100 (30.2)	18,350 (38.3)	13,700 (46.3)	10,300 (54.3)	7,730 (62.3)	5,670 (70.3)	4,350 (76.3)	3,260 (81.9)

NOTE: () Reference radii in feet.

A6-829-009499B

THIS CHART IS ONLY A GUIDE AND SHOULD NOT BE USED TO OPERATE THE CRANE. The individual crane's load chart, operating instructions and other instructional plates must be read and understood prior to operating the crane.



POWER PINNED
36 - 114 ft.
(11.0 - 34.7 m)



14,000 lbs. (6350 kg)
*12,050 lbs. (5466 kg)



100%
26' 6" (8.9 m)
Spread



OVER FRONT



Pounds

(Feet)	36	44	52	60	68	76	82	88	Power Pin. Fly Ext. & 88 ft.	114
10	*160,000 (67)	106,700 (71.5)	101,600 (74.5)	100,000 (77)	96,700 (79)					
12	120,000 (63)	106,700 (68.5)	101,600 (72)	96,500 (75)	87,850 (77)	84,700 (78.5)				
15	103,450 (57.5)	103,450 (64)	95,300 (68.5)	84,900 (72)	79,180 (74.5)	77,550 (76)	70,250 (77.5)	64,500 (79)		
20	80,650 (47)	80,650 (56.5)	80,650 (62.5)	70,550 (66.5)	64,310 (70)	63,800 (72)	59,400 (74)	55,000 (75.5)	38,750 (80)	
25	62,200 (34)	62,200 (48)	62,200 (55.5)	60,150 (61)	54,000 (65.5)	49,700 (67.5)	47,150 (70.5)	45,600 (72)	34,000 (77)	
30		48,450 (38)	48,450 (48.5)	48,450 (55.5)	46,650 (60.5)	42,750 (63.5)	40,450 (66.5)	39,150 (68.5)	30,300 (74.5)	
35		39,500 (24.5)	39,500 (40.5)	39,500 (49.5)	39,500 (55.5)	37,300 (58.5)	35,200 (62.5)	34,050 (65)	27,250 (71.5)	
40			34,400 (30.5)	34,400 (42.5)	34,400 (50)	32,900 (54)	31,000 (58.5)	29,550 (61.5)	24,750 (69)	
45			29,250 (14.5)	29,250 (34.5)	29,250 (44)	29,250 (49)	27,500 (54)	26,550 (57.5)	22,650 (66)	
50				24,350 (24)	24,350 (37.5)	24,350 (43.5)	24,350 (49.5)	23,750 (53.5)	20,800 (63)	
60					17,060 (17.5)	17,060 (30.5)	17,060 (39)	17,060 (44)	17,900 (57)	
70							12,000 (24.5)	12,000 (33)	14,550 (50.5)	
80								8,560 (14)	11,250 (43)	
90									8,670 (34.5)	
100									6,560 (23)	
Minimum boom angle (deg.) for indicated length (no load)									0	0
Maximum boom length (ft.) at 0 deg. boom angle (no load)									88	114

NOTE: () Boom angles are in degrees.

*13 parts of line required to lift this capacity (using aux. boom nose). Refer to Operator's and Safety Handbook for reeving diagram.

A6-829-012489A

Boom Angle	36	44	52	60	68	76	82	88
0°	25,100 (30.2)	18,350 (38.3)	13,700 (46.3)	10,300 (54.3)	7,730 (62.3)	5,670 (70.3)	4,350 (76.3)	3,260 (81.9)

NOTE: () Reference radii in feet.

A6-829-009499B

THIS CHART IS ONLY A GUIDE AND SHOULD NOT BE USED TO OPERATE THE CRANE. The individual crane's load chart, operating instructions and other instructional plates must be read and understood prior to operating the crane.



POWER PINNED
36 - 114 ft.
(11.0 - 34.7 m)



14,000 lbs.
(6350 kg)



50%
17' 6-1/2" (5.35 m)
Spread



360°



Pounds

(Feet)	36	44	52	60	68	76	82	88	114	Power Pin. Fly Ext. & 88 ft.
10	126,000 (67)	106,500 (71.5)	101,500 (74.5)	100,000 (77)	96,700 (79)					
12	111,500 (63)	106,500 (68.5)	101,500 (72)	96,500 (75)	87,850 (77)	84,700 (78.5)				
15	95,050 (57.5)	95,050 (64)	95,000 (68.5)	84,900 (72)	79,150 (74.5)	77,550 (76)	70,250 (77.5)	64,500 (79)		
20	68,950 (47)	68,950 (56.5)	68,800 (62.5)	66,250 (66.5)	63,900 (70)	61,700 (72)	59,400 (74)	55,000 (75.5)	38,750 (80)	
25	45,000 (34)	45,000 (48)	45,000 (55.5)	45,000 (61)	45,000 (65.5)	43,800 (67.5)	42,900 (70.5)	42,050 (72)	34,000 (77)	
30		32,350 (38)	32,350 (48.5)	32,350 (55.5)	32,350 (60.5)	32,350 (63.5)	32,250 (66.5)	31,700 (68.5)	30,300 (74.5)	
35		23,950 (24.5)	23,950 (40.5)	23,950 (49.5)	23,950 (55.5)	23,950 (58.5)	23,950 (62.5)	23,950 (65)	25,550 (71.5)	
40			18,200 (30.5)	18,200 (42.5)	18,200 (50)	18,200 (54)	18,200 (58.5)	18,200 (61.5)	20,750 (69)	
45			14,050 (34.5)	14,050 (44)	14,050 (49)	14,050 (54)	14,050 (57.5)	14,050 (66)	17,100 (66)	
50				10,900 (24)	10,900 (37.5)	10,900 (43.5)	10,900 (49.5)	10,900 (53.5)	14,200 (63)	
60					6,470 (17.5)	6,470 (30.5)	6,470 (39)	6,470 (44)	9,880 (57)	
70							3,470 (24.5)	3,470 (33)	6,730 (50.5)	
80								1,320 (14)	4,360 (43)	
90									2,580 (34.5)	
100									1,190 (23)	
Minimum boom angle (deg.) for indicated length (no load)									0	22
Maximum boom length (ft.) at 0 deg. boom angle (no load)									88	

NOTE: () Boom angles are in degrees.

Boom Angle	36	44	52	60	68	76	82
0°	25,100 (30.2)	18,350 (38.3)	13,150 (46.3)	8,780 (54.3)	5,690 (62.3)	3,410 (70.3)	2,050 (76.3)

NOTE: () Reference radii in feet.

A6-829-015523

THIS CHART IS ONLY A GUIDE AND SHOULD NOT BE USED TO OPERATE THE CRANE. The individual crane's load chart, operating instructions and other instructional plates must be read and understood prior to operating the crane.



POWER PINNED
36 - 114 ft.
(11.0 - 34.7 m)



14,000 lbs.
(6350 kg)



0%
11' 1" (3.38 m)
Spread



360°



Pounds

(Feet)	36	44	52	60	68	76	82	88	114
10	105,000 (67)	105,000 (71.5)	99,250 (74.5)	93,200 (77)	87,800 (79)				
12	73,600 (63)	73,600 (68.5)	73,600 (72)	72,300 (75)	68,800 (77)	65,550 (78.5)			
15	47,800 (57.5)	47,800 (64)	47,800 (68.5)	47,800 (72)	47,800 (74.5)	47,800 (76)	47,400 (77.5)	46,100 (79)	
20	28,600 (47)	28,600 (56.5)	28,600 (62.5)	28,600 (66.5)	28,600 (70)	28,600 (72)	28,600 (74)	28,600 (75.5)	30,900 (80)
25	19,250 (34)	19,250 (48)	19,250 (55.5)	19,250 (61)	19,250 (65.5)	19,250 (67.5)	19,250 (70.5)	19,250 (72)	22,850 (77)
30		13,750 (38)	13,750 (48.5)	13,750 (55.5)	13,750 (60.5)	13,750 (63.5)	13,750 (66.5)	13,750 (68.5)	17,450 (74.5)
35		9,670 (24.5)	9,670 (40.5)	9,670 (49.5)	9,670 (55.5)	9,670 (58.5)	9,670 (62.5)	9,670 (65)	13,550 (71.5)
40			6,750 (30.5)	6,750 (42.5)	6,750 (50)	6,750 (54)	6,750 (58.5)	6,750 (61.5)	10,450 (69)
45			4,560 (14.5)	4,560 (34.5)	4,560 (44)	4,560 (49)	4,560 (54)	4,560 (57.5)	8,030 (66)
50				2,870 (24)	2,870 (37.5)	2,870 (43.5)	2,870 (49.5)	2,870 (53.5)	6,130 (63)
60									3,360 (57)
70									1,460 (50.5)
Minimum boom angle (deg.) for indicated length (no load)				0	36.5	42.5	48.5	52.5	56
Maximum boom length (ft.) at 0 deg. boom angle (no load)						60			

NOTE: () Boom angles are in degrees.

Boom Angle	36	44	52	60
0°	13,600 (30.2)	7,670 (38.3)	4,100 (46.3)	1,710 (54.3)

NOTE: () Reference radii in feet.

A6-829-015524

THIS CHART IS ONLY A GUIDE AND SHOULD NOT BE USED TO OPERATE THE CRANE. The individual crane's load chart, operating instructions and other instructional plates must be read and understood prior to operating the crane.



FULL POWER
36 - 114 ft.
(11.0 - 34.7 m)



13,200 lbs. (5988 kg)
*11,250 lbs. (5103 kg)



100%
26' 6" (8.9 m)
Spread



360°



Pounds

(Feet)	36	42	51	60	69	78	87	96	105	114
10	*160,000 (67)	106,700 (70.5)	101,600 (74)	100,000 (77)	96,700 (79)					
12	120,000 (63)	106,700 (67.5)	101,600 (71.5)	96,500 (75)	87,850 (77)	84,700 (79)				
15	103,450 (57.5)	103,450 (63)	95,300 (68)	84,900 (72)	79,200 (74.5)	77,550 (77)	64,500 (79)			
20	80,650 (47)	80,650 (54.5)	80,650 (61.5)	70,550 (66.5)	64,350 (70)	63,800 (73)	55,000 (75.5)	51,900 (77)	48,450 (78.5)	38,750 (80)
25	62,200 (34)	62,200 (45.5)	62,200 (55)	60,150 (61)	54,000 (65.5)	49,700 (69)	45,600 (72)	43,600 (74)	41,300 (76)	34,000 (77)
30		48,450 (34)	48,450 (47.5)	48,450 (55.5)	46,650 (61)	42,750 (65)	39,150 (68.5)	38,400 (71)	35,350 (73)	30,300 (74.5)
35		39,500 (16.5)	39,500 (39)	39,500 (49.5)	39,500 (56)	37,300 (61)	34,050 (64.5)	32,700 (67.5)	30,700 (70)	27,250 (72)
40			33,050 (28.5)	33,050 (42.5)	33,050 (50.5)	32,900 (56.5)	29,550 (61)	28,850 (64.5)	27,000 (67)	24,750 (69)
45				26,350 (34.5)	26,350 (45)	26,350 (51.5)	26,350 (57)	25,650 (61)	23,900 (64)	22,650 (66.5)
50				21,400 (24)	21,400 (38.5)	21,400 (46.5)	21,400 (52.5)	21,400 (57.5)	21,350 (61)	20,800 (63.5)
60					14,900 (20)	14,900 (35)	14,900 (43.5)	14,900 (49.5)	14,900 (54)	14,900 (57.5)
70							10,950 (32)	10,950 (40.5)	10,950 (46.5)	10,950 (51)
80							7,620 (12.5)	7,620 (29.5)	7,620 (38)	7,620 (44)
90									5,150 (27)	5,150 (35.5)
100										3,240 (24.5)

Minimum boom angle (deg.) for indicated length (no load)

0

Maximum boom length (ft.) at 0 deg. boom angle (no load)

114

NOTE: () Boom angles are in degrees.

*13 parts of line required to lift this capacity (using aux. boom nose).

A6-829-012385A

Boom Angle	36	42	51	60	69	78	87	96
0°	24,650 (30.2)	19,400 (36.3)	13,950 (45.3)	10,100 (54.3)	7,300 (63.3)	5,120 (72.3)	3,390 (81.3)	1,970 (90.3)

NOTE: () Reference radii in feet.

A6-829-009488



FULL POWER
36 - 114 ft.
(11.0 - 34.7 m)



13,200 lbs. (5988 kg)
*11,250 lbs. (5103 kg)



100%
26' 6" (8.9 m)
Spread



Over Front



Pounds

(Feet)	36	42	51	60	69	78	87	96	105	114
10	*160,000 (67)	106,700 (70.5)	101,600 (74)	100,000 (77)	96,700 (79)					
12	120,000 (63)	106,700 (67.5)	101,600 (71.5)	96,500 (75)	87,850 (77)	84,700 (79)				
15	103,450 (57.5)	103,450 (63)	95,300 (68)	84,900 (72)	79,200 (74.5)	77,550 (77)	64,500 (79)			
20	80,650 (47)	80,650 (54.5)	80,650 (61.5)	70,550 (66.5)	64,350 (70)	63,800 (73)	55,000 (75.5)	51,900 (77)	48,450 (78.5)	38,750 (80)
25	62,200 (34)	62,200 (45.5)	62,200 (55)	60,150 (61)	54,000 (65.5)	49,700 (69)	45,600 (72)	43,600 (74)	41,300 (76)	34,000 (77)
30		48,450 (34)	48,450 (47.5)	48,450 (55.5)	46,650 (61)	42,750 (65)	39,150 (68.5)	38,400 (71)	35,350 (73)	30,300 (74.5)
35		39,500 (16.5)	39,500 (39)	39,500 (49.5)	39,500 (56)	37,300 (61)	34,050 (64.5)	32,700 (67.5)	30,700 (70)	27,250 (72)
40			34,400 (28.5)	34,400 (42.5)	34,400 (50.5)	32,900 (56.5)	29,550 (61)	28,850 (64.5)	27,000 (67)	24,750 (69)
45				29,250 (34.5)	29,250 (45)	29,250 (51.5)	26,550 (57)	25,650 (61)	23,900 (64)	22,650 (66.5)
50				25,750 (24)	25,750 (38.5)	25,750 (46.5)	23,750 (52.5)	22,700 (57.5)	21,350 (61)	20,800 (63.5)
60					18,900 (20)	18,900 (35)	18,900 (43.5)	18,400 (49.5)	17,850 (54)	17,450 (57.5)
70							13,800 (32)	13,800 (40.5)	13,800 (46.5)	13,800 (51)
80							10,100 (12.5)	10,100 (29.5)	10,100 (38)	10,100 (44)
90									7,290 (27)	7,290 (35.5)
100										5,070 (24.5)

Minimum boom angle (deg.) for indicated length (no load)

0

Maximum boom length (ft.) at 0 deg. boom angle (no load)

114

NOTE: () Boom angles are in degrees.

*13 parts of line required to lift this capacity (using aux. boom nose).

A6-829-012386A

Boom Angle	36	42	51	60	69	78	87	96
0°	24,650 (30.2)	19,400 (36.3)	13,950 (45.3)	10,100 (54.3)	7,300 (63.3)	5,120 (72.3)	3,390 (81.3)	1,970 (90.3)

NOTE: () Reference radii in feet.

A6-829-009488

THIS CHART IS ONLY A GUIDE AND SHOULD NOT BE USED TO OPERATE THE CRANE. The individual crane's load chart, operating instructions and other instructional plates must be read and understood prior to operating the crane.



FULL POWER
36 - 114 ft.
(11.0 - 34.7 m)



13,200 lbs.
(5988 kg)



50%
17' 6-1/2" (5.35 m)
Spread



360°



(Feet)	36	42	51	60	69	78	87	96	105	114
10	125,000 (67)	106,700 (70.5)	101,600 (74)	100,000 (77)	96,700 (79)					
12	111,000 (63)	106,700 (67.5)	101,600 (71.5)	96,500 (75)	87,850 (77)	84,700 (79)				
15	94,450 (57.5)	94,650 (63)	94,850 (68)	84,900 (72)	79,200 (74.5)	77,550 (77)	64,500 (79)			
20	72,700 (47)	72,300 (54.5)	69,200 (61.5)	67,050 (66.5)	64,350 (70)	62,350 (73)	55,000 (75.5)	51,900 (77)	48,450 (78.5)	38,750 (80)
25	48,450 (34)	48,450 (45.5)	47,900 (55)	46,900 (61)	45,600 (65.5)	44,250 (69)	43,100 (72)	41,950 (74)	40,800 (76)	34,000 (77)
30		34,450 (34)	34,450 (47.5)	34,450 (55.5)	34,050 (61)	33,200 (65)	32,500 (68.5)	31,700 (71)	30,950 (73)	30,250 (74.5)
35		25,750 (16.5)	25,750 (39)	25,750 (49.5)	25,750 (56)	25,700 (61)	25,250 (64.5)	24,700 (67.5)	24,150 (70)	23,700 (72)
40			19,850 (28.5)	19,850 (42.5)	19,850 (50.5)	19,850 (56.5)	19,850 (61)	19,600 (64.5)	19,200 (67)	18,850 (69)
45				15,550 (34.5)	15,550 (45)	15,550 (51.5)	15,550 (57)	15,550 (61)	15,400 (64)	15,150 (66.5)
50				12,300 (24)	12,300 (38.5)	12,300 (46.5)	12,300 (52.5)	12,300 (57.5)	12,300 (61)	12,200 (63.5)
60					8,030 (20)	8,030 (35)	8,030 (43.5)	8,030 (49.5)	8,010 (54)	7,860 (57.5)
70							5,070 (32)	4,990 (40.5)	4,890 (46.5)	4,790 (51)
80							2,680 (12.5)	2,640 (29.5)	2,580 (38)	2,500 (44)

Minimum boom angle (deg.) for indicated length (no load)

0 28.5 37 43

Maximum boom length (ft.) at 0 deg. boom angle (no load)

87

NOTE: () Boom angles are in degrees.

Boom Angle	36	42	51	60	69	78	87
0°	24,650 (30.2)	19,400 (36.3)	13,950 (45.3)	10,100 (54.3)	6,710 (63.3)	4,260 (72.3)	2,420 (81.3)

NOTE: () Reference radii in feet.

A6-829-014558

THIS CHART IS ONLY A GUIDE AND SHOULD NOT BE USED TO OPERATE THE CRANE. The individual crane's load chart, operating instructions and other instructional plates must be read and understood prior to operating the crane.



FULL POWER
36 - 114 ft.
(11.0 - 34.7 m)



13,200 lbs.
(5988 kg)



0%
11' 1" (3.35 m)
Spread



360°



(Feet)	36	42	51	60	69	78	87	96	105	114
10	104,500 (67)	105,000 (70.5)	100,500 (74)	94,650 (77)	88,800 (79)					
12	85,100 (63)	81,850 (67.5)	77,000 (71.5)	73,350 (75)	69,600 (77)	66,100 (79)				
15	55,250 (57.5)	55,250 (63)	55,250 (68)	53,600 (72)	51,400 (74.5)	49,250 (77)	47,350 (79)			
20	32,750 (47)	32,750 (54.5)	32,750 (61.5)	32,750 (66.5)	32,750 (70)	32,750 (73)	31,950 (75.5)	30,950 (77)	29,950 (78.5)	29,100 (80)
25	21,800 (34)	21,800 (45.5)	21,800 (55)	21,800 (61)	21,800 (65.5)	21,800 (69)	21,800 (72)	21,800 (74)	21,550 (76)	21,000 (77)
30		15,350 (34)	15,350 (47.5)	15,350 (55.5)	15,350 (61)	15,350 (65)	15,350 (68.5)	15,350 (71)	15,350 (73)	15,350 (74.5)
35		11,050 (16.5)	11,050 (39)	11,050 (49.5)	11,050 (56)	11,050 (61)	11,050 (64.5)	11,050 (67.5)	11,050 (70)	11,050 (72)
40			8,050 (28.5)	8,050 (42.5)	8,050 (50.5)	8,050 (56.5)	8,050 (61)	8,050 (64.5)	8,050 (67)	8,050 (69)
45				5,780 (34.5)	5,780 (45)	5,780 (51.5)	5,780 (57)	5,780 (61)	5,780 (64)	5,780 (66.5)
50				4,030 (24)	4,030 (38.5)	4,030 (46.5)	4,030 (52.5)	4,030 (57.5)	4,030 (61)	4,030 (63.5)
60					1,710 (20)	1,710 (35)	1,710 (43.5)	1,700 (49.5)	1,620 (54)	1,530 (57.5)
Minimum boom angle (deg.) for indicated length (no load)				0	19	34	42.5	48.5	53	56.5
Maximum boom length (ft.) at 0 deg. boom angle (no load)							60			

NOTE: () Boom angles are in degrees.

Boom Angle	36	42	51	60
0°	15,100 (30.2)	10,050 (36.3)	5,610 (45.3)	2,820 (54.3)

NOTE: () Reference radii in feet.

A6-829-014559

THIS CHART IS ONLY A GUIDE AND SHOULD NOT BE USED TO OPERATE THE CRANE. The individual crane's load chart, operating instructions and other instructional plates must be read and understood prior to operating the crane.



POWER PINNED and FULL POWER
36 - 114 ft.
(11.0 - 34.7 m)



33 ft.
(10.0 m)



14,000 lbs. (6350 kg) **POWER PINNED**
13,200 lbs. (5988 kg) **FULL POWER**



100%
26' 6" (8.9 m)
Spread



360°



(Feet)	2° OFFSET	15° OFFSET	30° OFFSET
25	23,000 (80)		
30	20,250 (78)	*15,700 (80)	
35	17,950 (76)	14,200 (78)	*11,500 (80)
40	16,250 (74)	12,750 (76)	11,100 (79.5)
45	15,050 (71.5)	11,500 (74)	10,150 (77)
50	13,950 (69.5)	10,450 (72)	9,320 (75)
55	12,750 (67.5)	9,590 (69.5)	8,600 (72.5)
60	11,600 (65)	8,810 (67.5)	7,970 (70.5)
65	10,650 (63)	8,110 (65)	7,410 (68)
70	9,780 (60.5)	7,480 (63)	6,890 (65.5)
75	8,920 (58)	6,920 (60.5)	6,420 (63)
80	8,110 (55.5)	6,430 (58)	6,000 (60.5)
85	7,400 (53)	5,980 (55.5)	5,610 (58)
90	6,530 (50.5)	5,570 (53)	5,250 (55)
95	5,460 (48)	5,190 (50)	4,920 (52.5)
100	4,510 (45)	4,510 (47.5)	4,510 (49.5)
105	3,670 (42)	3,670 (44.5)	3,670 (46)
110	2,910 (39)	2,910 (41)	2,910 (42.5)
115	2,230 (35.5)	2,230 (37.5)	2,230 (39)

NOTE: () Boom angles are in degrees.
*This capacity is based on maximum boom angle.

A6-829-012490

THIS CHART IS ONLY A GUIDE AND SHOULD NOT BE USED TO OPERATE THE CRANE. The individual crane's load chart, operating instructions and other instructional plates must be read and understood prior to operating the crane.





POWER PINNED and FULL POWER
36 - 114 ft.
(11.0 - 34.7 m)



33 ft.
(10.0 m)



14,000 lbs. (6350 kg) **POWER PINNED**
13,200 lbs. (5988 kg) **FULL POWER**



50%
17' 6-1/2" (5.35 m)
Spread



360°



(Feet)	2° OFFSET	15° OFFSET	30° OFFSET
25	23,000 (80)		
30	20,250 (78)	*15,700 (80)	
35	17,950 (76)	14,200 (78)	*11,500 (80)
40	16,250 (74)	12,750 (76)	11,100 (79.5)
45	15,050 (71.5)	11,500 (74)	10,150 (77)
50	12,750 (69.5)	10,450 (72)	9,320 (75)
55	10,500 (67.5)	9,590 (69.5)	8,600 (72.5)
60	8,650 (65)	8,810 (67.5)	7,970 (70.5)
65	7,060 (63)	8,110 (65)	7,410 (68)
70	5,700 (60.5)	6,660 (63)	6,890 (65.5)
75	4,520 (58)	5,390 (60.5)	5,620 (63)
80	3,490 (55.5)	4,270 (58)	4,440 (60.5)
85	2,580 (53)	3,290 (55.5)	3,410 (58)
90	1,770 (50.5)	2,410 (53)	2,510 (55)
95	1,050 (48)	1,630 (50)	1,710 (52.5)
100			1,000 (49.5)

NOTE: () Boom angles are in degrees.

*This capacity is based on maximum boom angle.

A6-829-014561A

THIS CHART IS ONLY A GUIDE AND SHOULD NOT BE USED TO OPERATE THE CRANE. The individual crane's load chart, operating instructions and other instructional plates must be read and understood prior to operating the crane.

RT880

15





POWER PINNED and FULL POWER
36 - 114 ft.
(11.0 - 34.7 m)



33 - 58 ft.
(10.0 - 17.7 m)



14,000 lbs. (6350 kg) **POWER PINNED**
13,200 lbs. (5988 kg) **FULL POWER**



100%
26' 6" (8.9 m)
Spread



360°



(Feet)	33 ft. LENGTH			48 ft. LENGTH			58 ft. LENGTH		
	2° OFFSET	15° OFFSET	30° OFFSET	2° OFFSET	15° OFFSET	30° OFFSET	2° OFFSET	15° OFFSET	30° OFFSET
25	22,500 (80)			*15,500 (80)					
30	19,700 (78)	*15,150 (80)		14,850 (79.5)			*10,300 (80)		
35	17,400 (76)	13,650 (78)	*10,950 (80)	13,150 (77.5)	*10,000 (80)		9,890 (79)		
40	15,700 (74)	12,200 (76)	10,550 (79.5)	11,600 (75.5)	9,635 (79.5)		9,370 (77)	*7,780 (80)	
45	14,500 (71.5)	10,950 (74)	9,620 (77)	10,350 (74)	8,780 (77.5)	*7,140 (80)	8,860 (75)	7,540 (79.5)	
50	13,400 (69.5)	9,930 (72)	8,780 (75)	9,310 (72)	7,980 (75.5)	6,910 (79.5)	8,080 (73.5)	6,920 (77.5)	
55	12,200 (67.5)	9,050 (69.5)	8,060 (72.5)	8,430 (70)	7,290 (73.5)	6,390 (77.5)	7,320 (71.5)	6,330 (76)	5,530 (80)
60	11,050 (65)	8,270 (67.5)	7,430 (70.5)	7,650 (68)	6,690 (71.5)	5,910 (75.5)	6,640 (70)	5,820 (74)	5,110 (78)
65	10,100 (63)	7,570 (65)	6,870 (68)	6,970 (66)	6,160 (69.5)	5,480 (73)	6,070 (68)	5,370 (72)	4,750 (76)
70	9,240 (60.5)	6,940 (63)	6,350 (65.5)	6,360 (64)	5,680 (67.5)	5,110 (71)	5,570 (66)	4,970 (70)	4,420 (74)
75	8,380 (58)	6,380 (60.5)	5,880 (63)	5,820 (62)	5,250 (65.5)	4,760 (69)	5,130 (64)	4,610 (68.5)	4,130 (72)
80	7,570 (55.5)	5,890 (58)	5,460 (60.5)	5,340 (59.5)	4,860 (63.5)	4,430 (67)	4,730 (62.5)	4,280 (66.5)	3,860 (70)
85	6,860 (53)	5,440 (55.5)	5,070 (58)	4,910 (57.5)	4,500 (61)	4,130 (64.5)	4,360 (60.5)	3,970 (64.5)	3,610 (68)
90	5,760 (50.5)	5,030 (53)	4,710 (55)	4,530 (55.5)	4,170 (59)	3,860 (62)	4,030 (58.5)	3,700 (62.5)	3,370 (66)
95	4,690 (48)	4,650 (50)	4,380 (52.5)	4,180 (53)	3,880 (56.5)	3,600 (60)	3,730 (56)	3,440 (60)	3,160 (63.5)
100	3,740 (45)	3,740 (47.5)	3,740 (49.5)	3,860 (50.5)	3,600 (54.5)	3,370 (57.5)	3,450 (54)	3,200 (58)	2,960 (61)
105	2,900 (42)	2,900 (44.5)	2,900 (46)	3,560 (48.5)	3,350 (52)	3,160 (55)	3,200 (52)	2,980 (56)	2,780 (59)
110	2,130 (39)	2,130 (41)	2,130 (42.5)	3,290 (45.5)	3,120 (49.5)	2,950 (52)	2,970 (49.5)	2,770 (53.5)	2,600 (56.5)
115	1,450 (35.5)	1,450 (37.5)	1,450 (39)	2,690 (43)	2,690 (46.5)	2,690 (49.5)	2,760 (47.5)	2,580 (51)	2,440 (54)
120				2,040 (40)	2,040 (44)	2,040 (46.5)	2,560 (45)	2,410 (48.5)	2,280 (51.5)
125				1,450 (37)	1,450 (40.5)	1,450 (43)	2,240 (42.5)	2,240 (46)	2,140 (49)
130							1,690 (39.5)	1,690 (43.5)	1,690 (46)
135							1,190 (37)	1,190 (40.5)	1,190 (42.5)

NOTE: () Boom angles are in degrees.

*This capacity is based on maximum boom angle.

A6-829-012491A

THIS CHART IS ONLY A GUIDE AND SHOULD NOT BE USED TO OPERATE THE CRANE. The individual crane's load chart, operating instructions and other instructional plates must be read and understood prior to operating the crane.



POWER PINNED and FULL POWER
36 - 114 ft.
(11.0 - 34.7 m)



33 - 58 ft.
(10.0 - 17.7 m)



14,000 lbs. (6350 kg) **POWER PINNED**
13,200 lbs. (5988 kg) **FULL POWER**



50%
17' 6-1/2" (5.35 m)
Spread



360°



(Feet)	33 ft. LENGTH			48 ft. LENGTH			58 ft. LENGTH		
	2° OFFSET	15° OFFSET	30° OFFSET	2° OFFSET	15° OFFSET	30° OFFSET	2° OFFSET	15° OFFSET	30° OFFSET
25	22,500 (80)			*15,500 (80)					
30	19,700 (78)	*15,150 (80)		14,850 (79.5)			*10,300 (80)		
35	17,400 (76)	13,650 (78)	*10,950 (80)	13,150 (77.5)	*10,000 (80)		9,890 (79)		
40	15,700 (74)	12,200 (76)	10,550 (79.5)	11,600 (75.5)	9,635 (79.5)		9,370 (77)	*7,780 (80)	
45	14,500 (71.5)	10,950 (74)	9,620 (77)	10,350 (74)	8,780 (77.5)	*7,140 (80)	8,860 (75)	7,540 (79.5)	
50	11,900 (69.5)	9,930 (72)	8,780 (75)	9,310 (72)	7,980 (75.5)	6,910 (79.5)	8,080 (73.5)	6,920 (77.5)	
55	9,630 (67.5)	9,050 (69.5)	8,060 (72.5)	8,430 (70)	7,290 (73.5)	6,390 (77.5)	7,320 (71.5)	6,330 (76)	5,530 (80)
60	7,750 (65)	8,270 (67.5)	7,430 (70.5)	7,650 (68)	6,690 (71.5)	5,910 (75.5)	6,640 (70)	5,820 (74)	5,110 (78)
65	6,150 (63)	7,250 (65)	6,870 (68)	6,970 (66)	6,160 (69.5)	5,480 (73)	6,070 (68)	5,370 (72)	4,750 (76)
70	4,790 (60.5)	5,780 (63)	6,350 (65.5)	5,970 (64)	5,680 (67.5)	5,110 (71)	5,570 (66)	4,970 (70)	4,420 (74)
75	3,610 (58)	4,500 (60.5)	5,410 (63)	4,790 (62)	5,250 (65.5)	4,760 (69)	5,130 (64)	4,610 (68.5)	4,130 (72)
80	2,570 (55.5)	3,390 (58)	4,190 (60.5)	3,770 (59.5)	4,860 (63.5)	4,430 (67)	4,420 (62.5)	4,280 (66.5)	3,860 (70)
85	1,660 (53)	2,400 (55.5)	3,120 (58)	2,860 (57.5)	3,910 (61)	4,130 (64.5)	3,520 (60.5)	3,970 (64.5)	3,610 (68)
90		1,520 (53)	2,160 (55)	2,050 (55.5)	3,010 (59)	3,860 (62)	2,710 (58.5)	3,700 (62.5)	3,370 (66)
95			1,290 (52.5)	1,320 (53)	2,200 (56.5)	3,090 (60)	1,990 (56)	3,040 (60)	3,160 (63.5)
100					1,480 (54.5)	2,280 (57.5)	1,340 (54)	2,310 (58)	2,960 (61)
105						1,530 (55)		1,640 (56)	2,360 (59)
110								1,030 (53.5)	1,680 (56.5)
115									1,070 (54)

NOTE: () Boom angles are in degrees.
*This capacity is based on maximum boom angle.

A6-829-014560A

THIS CHART IS ONLY A GUIDE AND SHOULD NOT BE USED TO OPERATE THE CRANE. The individual crane's load chart, operating instructions and other instructional plates must be read and understood prior to operating the crane.



POWER PINNED
36 - 114 ft.
(11.0 - 34.7 m)



14,000 lbs.
(6350 kg)



Stationary



360°

29.5 x 25 (28 Ply) Tires



(Feet)



Pounds

	36	44	52	60	68
10	53,800 (67)	38,000 (71.5)			
12	43,210 (63)	31,000 (68.5)			
15	32,960 (57.5)	24,000 (64)			
20	21,630 (47)	17,000 (56.5)			
25	15,510 (34)	15,510 (48)	12,000 (55.5)	12,000 (61)	
30		10,670 (38)	8,000 (48.5)	8,000 (55.5)	
35		7,540 (24.5)	7,540 (40.5)	6,000 (49.5)	6,000 (55.5)
40			4,900 (30.5)	4,000 (42.5)	4,000 (50)
45			2,970 (14.5)	2,970 (34.5)	2,970 (44)
50				1,620 (24)	1,620 (37.5)

NOTE: () Boom angles are in degrees.

A6-829-009057A

Boom Angle	36	44	52
0°	10,552 (30.2)	5,820 (38.3)	2,550 (46.3)

NOTE: () Reference radii in feet.

A6-829-009499B

THIS CHART IS ONLY A GUIDE AND SHOULD NOT BE USED TO OPERATE THE CRANE. The individual crane's load chart, operating instructions and other instructional plates must be read and understood prior to operating the crane.





POWER PINNED
36 - 114 ft.
(11.0 - 34.7 m)



14,000 lbs.
(6350 kg)



Stationary



Defined Arc
Over Front
±6°

29.5 x 25 (28 Ply) Tires



(Feet)



Pounds

(Feet)	36	44	52	60	68	76	82	88
10	79,500 (67)	38,000 (71.5)						
12	67,500 (63)	38,000 (68.5)						
15	58,070 (57.5)	38,000 (64)						
20	46,850 (47)	38,000 (56.5)						
25	37,100 (34)	37,100 (48)	29,000 (55.5)	29,000 (61)				
30		27,760 (38)	24,000 (48.5)	24,000 (55.5)				
35		20,210 (24.5)	20,210 (40.5)	18,500 (49.5)	18,500 (55.5)	18,500 (58.5)	18,500 (62.5)	18,500 (65)
40			15,420 (30.5)	15,420 (42.5)	15,000 (50)	15,000 (54)	15,000 (58.5)	15,000 (61.5)
45			12,150 (14.5)	12,150 (34.5)	12,150 (44)	11,000 (49)	11,000 (54)	11,000 (57.5)
50				9,640 (24)	9,640 (37.5)	9,500 (43.5)	9,500 (49.5)	9,500 (53.5)
60					5,920 (17.5)	5,920 (30.5)	5,800 (39)	5,800 (44)
70							3,360 (24.5)	3,000 (33)
80								1,380 (14)

NOTE: () Boom angles are in degrees.

A6-829-009056A

Boom Angle	36	44	52	60	68	76	82	88
0°	25,100 (30.2)	16,750 (38.3)	11,400 (46.3)	7,840 (54.3)	5,220 (62.3)	3,310 (70.3)	2,110 (76.3)	1,000 (81.9)

NOTE: () Reference radii in feet.

A6-829-009499B

THIS CHART IS ONLY A GUIDE AND SHOULD NOT BE USED TO OPERATE THE CRANE. The individual crane's load chart, operating instructions and other instructional plates must be read and understood prior to operating the crane.



POWER PINNED
36 - 114 ft.
(11.0 - 34.7 m)



14,000 lbs.
(6350 kg)



Pick & Carry
Up to 2.5 MPH



Boom Centered
Over Front

29.5 x 25 (28 Ply) Tires



(Feet)



Pounds

(Feet)	36	44	52	60	68	76	82
10	68,830 (67)	38,000 (71.5)					
12	59,920 (63)	38,000 (68.5)					
15	49,740 (57.5)	38,000 (64)					
20	37,980 (47)	30,000 (56.5)	30,000 (62.5)	30,000 (66.5)	30,000 (70)		
25	30,830 (34)	26,000 (48)	26,000 (55.5)	26,000 (61)	23,000 (65.5)	23,000 (67.5)	
30		25,040 (38)	18,000 (48.5)	18,000 (55.5)	18,000 (60.5)	18,000 (63.5)	18,000 (66.5)
35		19,910 (24.5)	17,000 (40.5)	17,000 (49.5)	17,000 (55.5)	17,000 (58.5)	14,000 (62.5)
40			15,420 (30.5)	14,000 (42.5)	11,000 (50)	11,000 (54)	11,000 (58.5)
45			12,150 (14.5)	12,000 (34.5)	8,500 (44)	8,500 (49)	8,500 (54)
50				9,640 (24)	7,000 (37.5)	7,000 (43.5)	7,000 (49.5)
60					3,330 (17.5)	3,330 (30.5)	3,330 (39)
70							1,160 (24.5)

NOTE: () Boom angles are in degrees.

A6-829-009058A

Boom Angle	36	44	52	60	68	76
0°	24,800 (30.2)	16,750 (38.3)	11,400 (46.3)	4,860 (54.3)	2,760 (62.3)	1,110 (70.3)

NOTE: () Reference radii in feet.

A6-829-009499B

THIS CHART IS ONLY A GUIDE AND SHOULD NOT BE USED TO OPERATE THE CRANE. The individual crane's load chart, operating instructions and other instructional plates must be read and understood prior to operating the crane.





POWER PINNED
36 - 114 ft.
(11.0 - 34.7 m)



14,000 lbs.
(6350 kg)



Stationary



360°

33.25 x 29 Tires



(Feet)



Pounds

	36	44	52	60	68
10	64,800 (67)				
12	52,400 (63)				
15	39,850 (57.5)				
20	24,030 (47)	21,200 (56.5)	21,200 (62.5)		
25	16,680 (34)	16,680 (48)	15,350 (55.5)	15,350 (61)	15,350 (65.5)
30		11,160 (38)	11,150 (48.5)	11,150 (55.5)	11,150 (60.5)
35		7,770 (24.5)	7,770 (40.5)	7,770 (49.5)	7,770 (55.5)
40			5,210 (30.5)	5,210 (42.5)	5,210 (50)
45			3,170 (14.5)	3,170 (34.5)	3,170 (44)
50				1,780 (24)	1,780 (37.5)

NOTE: () Boom angles are in degrees.

A6-829-009521B

Boom
Angle

	36	44	52	60
0°	11,000 (30.2)	6,030 (38.3)	2,760 (46.3)	1,000 (54.3)

NOTE: () Reference radii in feet.

A6-829-009503B

THIS CHART IS ONLY A GUIDE AND SHOULD NOT BE USED TO OPERATE THE CRANE. The individual crane's load chart, operating instructions and other instructional plates must be read and understood prior to operating the crane.

RT880

21





POWER PINNED
36 - 114 ft.
(11.0 - 34.7 m)



14,000 lbs.
(6350 kg)



Stationary



Defined Arc
Over Front
±6°

33.25 x 29 Tires



(Feet)



(Feet)	36	44	52	60	68	76	82	88
10	94,000 (67)							
12	80,400 (63)							
15	67,300 (57.5)							
20	54,300 (47)	43,000 (56.5)	41,050 (62.5)					
25	39,060 (34)	39,060 (48)	32,100 (55.5)	32,100 (61)	32,100 (65.5)			
30		28,250 (38)	25,650 (48.5)	25,650 (55.5)	25,650 (60.5)			
35		20,600 (24.5)	20,600 (40.5)	20,600 (49.5)	20,600 (55.5)	20,600 (58.5)		
40			15,760 (30.5)	15,760 (42.5)	15,760 (50)	15,760 (54)	15,760 (58.5)	15,760 (61.5)
45			12,440 (14.5)	12,440 (34.5)	12,440 (44)	12,440 (49)	12,440 (54)	12,440 (57.5)
50				9,900 (24)	9,900 (37.5)	9,900 (43.5)	9,900 (49.5)	9,900 (53.5)
60					6,120 (17.5)	6,120 (30.5)	6,120 (39)	6,120 (44)
70							3,530 (24.5)	3,530 (33)
80								1,530 (14)

NOTE: () Boom angles are in degrees.

A6-829-009520B

Boom Angle	36	44	52	60	68	76	82	88
0°	25,100 (30.2)	17,150 (38.3)	11,700 (46.3)	8,070 (54.3)	5,440 (62.3)	3,480 (70.3)	2,270 (76.3)	1,150 (81.9)

NOTE: () Reference radii in feet.

A6-829-009503B

THIS CHART IS ONLY A GUIDE AND SHOULD NOT BE USED TO OPERATE THE CRANE. The individual crane's load chart, operating instructions and other instructional plates must be read and understood prior to operating the crane.





POWER PINNED
36 - 114 ft.
(11.0 - 34.7 m)



14,000 lbs.
(6350 kg)



Pick & Carry
Up to 2.5 MPH



Boom Centered
Over Front

33.25 x 29 Tires



(Feet)



Pounds

(Feet)	36	44	52	60	68	76	82
10	89,880 (67)						
12	78,630 (63)						
15	65,770 (57.5)						
20	50,940 (47)	33,200 (56.5)	33,200 (62.5)				
25	39,060 (34)	32,020 (48)	25,700 (55.5)	25,700 (61)	25,700 (65.5)		
30		28,250 (38)	20,300 (48.5)	20,300 (55.5)	20,300 (60.5)		
35		15,930 (24.5)	15,900 (40.5)	15,900 (49.5)	15,900 (55.5)	15,900 (58.5)	
40			12,720 (30.5)	12,700 (42.5)	12,700 (50)	12,700 (54)	12,700 (58.5)
45			10,330 (14.5)	10,300 (34.5)	10,300 (44)	10,300 (49)	10,300 (54)
50				8,360 (24)	8,190 (37.5)	8,190 (43.5)	8,190 (49.5)
60					5,140 (17.5)	4,860 (30.5)	4,860 (39)
70							2,730 (24.5)

NOTE: () Boom angles are in degrees.

A6-829-009522B

Boom Angle	36	44	52	60	68	76	82
0°	20,300 (30.2)	13,700 (38.3)	9,810 (46.3)	6,840 (54.3)	4,520 (62.3)	2,680 (70.3)	1,490 (76.3)

NOTE: () Reference radii in feet.

A6-829-009503B

THIS CHART IS ONLY A GUIDE AND SHOULD NOT BE USED TO OPERATE THE CRANE. The individual crane's load chart, operating instructions and other instructional plates must be read and understood prior to operating the crane.



FULL POWER
36 - 114 ft.
(11.0 - 34.7 m)



13,200 lbs.
(5988 kg)



Stationary



360°

33.25 x 29 Tires



(Feet)



Pounds

(Feet)	36	42	51	60	69
10	56,000 (67)				
12	48,000 (63)				
15	38,400 (57.5)				
20	23,250 (47)	21,250 (54.5)			
25	15,550 (34)	15,550 (45.5)	15,550 (55)		
30		10,900 (34)	10,000 (47.5)		
35		7,610 (16.5)	7,610 (39)	6,050 (49.5)	
40			5,300 (28.5)	5,300 (42.5)	4,120 (50.5)
45				3,570 (34.5)	2,510 (45)
50				2,210 (24)	2,210 (38.5)

NOTE: () Boom angles are in degrees.

A6-829-009721B

Boom Angle	36	42	51	60
0°	10,750 (30.2)	6,940 (36.3)	3,490 (45.3)	1,266 (54.3)

NOTE: () Reference radii in feet.

A6-829-009493A

THIS CHART IS ONLY A GUIDE AND SHOULD NOT BE USED TO OPERATE THE CRANE. The individual crane's load chart, operating instructions and other instructional plates must be read and understood prior to operating the crane.





FULL POWER
36 - 114 ft.
(11.0 - 34.7 m)



13,200 lbs.
(5988 kg)



Stationary



Defined Arc
Over Front
±6°

33.25 x 29 Tires



(Feet)



Pounds

(Feet)	36	42	51	60	69	78	87	96
10	88,000 (67)							
12	77,500 (63)							
15	64,300 (57.5)							
20	49,400 (47)	38,250 (54.5)						
25	37,850 (34)	37,850 (45.5)	30,000 (55)					
30		27,500 (34)	23,800 (47.5)					
35		20,650 (16.5)	20,650 (39)	19,350 (49.5)				
40			15,950 (28.5)	15,950 (42.5)	15,900 (50.5)	15,900 (56.5)		
45				12,500 (34.5)	12,500 (45)	12,500 (51.5)		
50				9,920 (24)	9,920 (38.5)	9,920 (46.5)		
60					6,210 (20)	6,210 (35)	6,210 (43.5)	
70							3,700 (32)	3,700 (40.5)
80							1,890 (12.5)	1,890 (29.5)

NOTE: () Reference radii in feet.

A6-829-009720A

Boom Angle	36	42	51	60	69	78	87
0°	24,650 (30.2)	19,300 (36.3)	12,350 (45.3)	8,150 (54.3)	5,290 (63.3)	3,250 (72.3)	1,690 (81.3)

NOTE: () Boom angles are in degrees.

A6-829-009493A

THIS CHART IS ONLY A GUIDE AND SHOULD NOT BE USED TO OPERATE THE CRANE. The individual crane's load chart, operating instructions and other instructional plates must be read and understood prior to operating the crane.



FULL POWER
36 - 114 ft.
(11.0 - 34.7 m)



13,200 lbs.
(5988 kg)



Pick & Carry
Up to 2.5 MPH



Boom Centered
Over Front

33.25 x 29 Tires



(Feet)



(Feet)	36	42	51	60	69	78	87	96
10	87,000 (67)							
12	76,000 (63)							
15	63,500 (57.5)							
20	49,400 (47)	35,850 (54.5)						
25	37,850 (34)	27,800 (45.5)	27,800 (55)					
30		27,500 (34)	22,300 (47.5)					
35		17,750 (16.5)	17,750 (39)	17,750 (49.5)				
40			14,450 (28.5)	14,450 (42.5)	14,450 (50.5)			
45				11,800 (34.5)	11,800 (45)			
50				9,670 (24)	9,670 (38.5)			
60					6,210 (20)	6,210 (35)	6,210 (43.5)	
70							3,700 (32)	3,700 (40.5)
80							1,890 (12.5)	1,890 (29.5)

NOTE: () Boom angles are in degrees.

A6-829-009722A

Boom Angle	36	42	51	60	69	78	87
0°	24,650 (30.2)	16,850 (36.3)	11,700 (45.3)	8,110 (54.3)	5,290 (63.3)	3,250 (72.3)	1,690 (81.3)

NOTE: () Boom angles are in degrees.

A6-829-009493A

THIS CHART IS ONLY A GUIDE AND SHOULD NOT BE USED TO OPERATE THE CRANE. The individual crane's load chart, operating instructions and other instructional plates must be read and understood prior to operating the crane.



Working range



POWER PINNED
36 - 114 ft. (11.0 - 34.7 m)

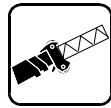

46 - 88 ft.
(14.0 - 26.8 m)



14,000 lbs.
(6350 kg)

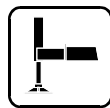

360°

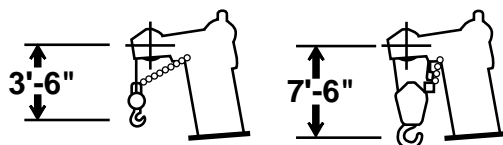
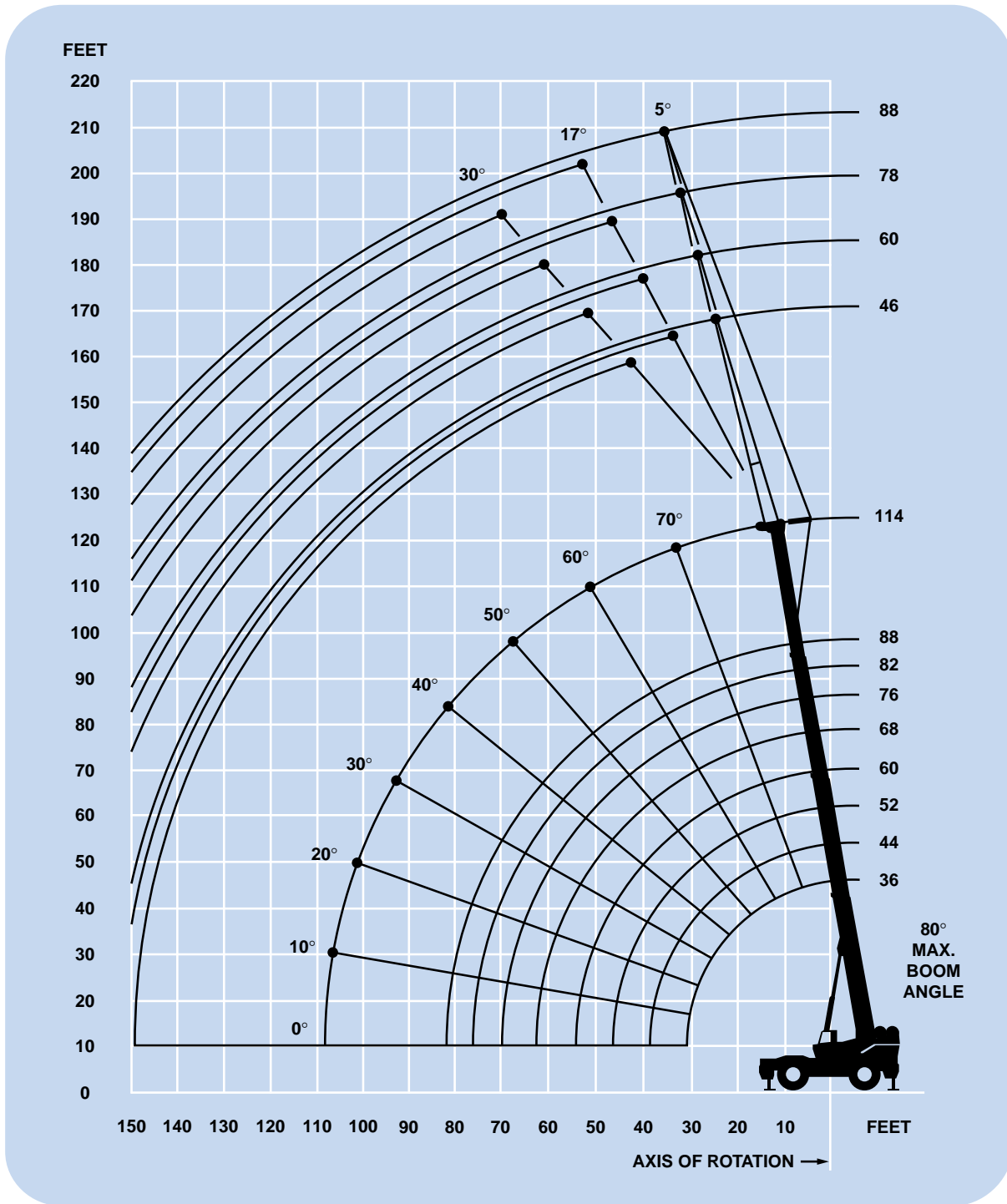

DIMENSIONS ARE FOR LARGEST GROVE FURNISHED HOOK BLOCK AND HEADACHE BALL, WITH ANTI-TWO BLOCK ACTIVATED.





POWER PINNED
36 - 114 ft.
(11.0 - 34.7 m)



46 - 88 ft.
(14.0 - 26.8 m)



14,000 lbs.
(6350 kg)



100%
26' 6" (8.9 m)
Spread



360°



Pounds

114 FT. BOOM + 46 FT. JIB

Boom Angle	5° OFFSET		17° OFFSET		30° OFFSET		5° OFFSET		17° OFFSET		30° OFFSET	
	Rad. Ref. (ft.)*	Cap. lbs.**	Rad. Ref. (ft.)*	Cap. lbs.**	Rad. Ref. (ft.)*	Cap. lbs.**	Rad. Ref. (ft.)*	Cap. lbs.**	Rad. Ref. (ft.)*	Cap. lbs.**	Rad. Ref. (ft.)*	Cap. lbs.**
80	32.0	14,000	41.0	11,950	49.0	8,480	36.3	10,600	48.2	8,160	58.0	5,680
77.5	38.4	13,350	47.2	11,550	55.2	8,080	43.3	9,970	54.5	7,790	64.7	5,320
75	44.9	12,800	53.2	11,150	61.2	7,690	50.3	9,490	60.9	7,450	71.3	5,020
72.5	51.2	12,250	59.6	10,300	67.2	7,350	57.2	8,930	67.5	7,130	77.8	4,760
70	57.5	9,930	65.4	8,390	72.9	7,020	63.9	8,380	74.1	6,830	84.2	4,540
67.5	63.7	7,970	71.4	6,870	78.6	6,100	70.6	6,710	80.6	5,610	90.3	4,340
65	69.7	6,450	77.1	5,640	84.1	5,080	77.1	5,380	86.8	4,580	96.3	4,030
62.5	75.6	5,240	82.8	4,640	89.5	4,220	83.4	4,320	92.7	3,730	102.1	3,310
60	81.3	4,250	88.2	3,800	94.7	3,490	89.6	3,460	98.6	3,010	107.8	2,700
55	92.4	2,750	99.0	2,490	104.4	2,320	101.4	2,130	110.0	1,870	118.3	1,700
50	102.7	1,660	108.2	1,520	113.4	1,420	112.5	1,160	121.9	1,010	128.1	920

114 FT. BOOM + 74 FT. JIB

Boom Angle	5° OFFSET		17° OFFSET		30° OFFSET		5° OFFSET		17° OFFSET		30° OFFSET	
	Rad. Ref. (ft.)*	Cap. lbs.**	Rad. Ref. (ft.)*	Cap. lbs.**	Rad. Ref. (ft.)*	Cap. lbs.**	Rad. Ref. (ft.)*	Cap. lbs.**	Rad. Ref. (ft.)*	Cap. lbs.**	Rad. Ref. (ft.)*	Cap. lbs.**
80	39.8	8,160	53.7	5,840	67.2	4,140	44.2	6,310	59.4	4,050	76.7	2,510
77.5	47.5	7,620	60.8	5,480	74.2	3,860	52.2	5,750	67.2	3,690	83.9	2,290
75	55.1	7,090	67.8	5,150	81.2	3,600	60.2	5,250	75.2	3,380	91.1	2,090
72.5	62.6	6,620	75.6	4,850	87.9	3,390	68.1	4,790	83.5	3,100	98.0	1,920
70	69.9	6,200	82.5	4,570	94.5	3,190	75.8	4,370	90.6	2,820	104.8	1,750
67.5	77.2	5,670	89.5	4,320	100.8	3,020	83.4	3,990	97.7	2,570	114.3	1,610
65	84.2	4,500	95.8	3,730	107.1	2,870	90.9	3,660	105.0	2,340	117.7	1,480
62.5	91.2	3,560	102.5	2,970	113.0	2,590	98.2	2,970	111.4	2,100	123.8	1,360
60	97.9	2,790	109.2	2,340	118.8	2,050	105.2	2,260	118.2	1,840		
55	110.9	1,590	121.3	1,340	129.7	1,170	118.8	1,170	131.0	940		

*Reference radius refers to fully extended boom and appropriate jib length.
**Capacities at loaded main boom angle.

A6-829-008615A

THIS CHART IS ONLY A GUIDE AND SHOULD NOT BE USED TO OPERATE THE CRANE. The individual crane's load chart, operating instructions and other instructional plates must be read and understood prior to operating the crane.

Rated lifting capacities

IMPORTANT NOTES:

WARNING: THIS CHART IS ONLY A GUIDE.

The notes below are for illustration only and should not be relied upon to operate the crane. The individual crane's load chart, operating instructions and other instruction plates must be read and understood prior to operating the crane.

1. All rated loads meet ANSI/ASME B30.5, Mobile and Locomotive Cranes. Testing and development were performed to SAEJ1063, Cantilevered Boom Crane Structures - Method of Test, and SAEJ765 Crane Stability Test Code.

2. Rated loads include the weight of hookblock, slings and auxiliary lifting devices and their weights shall be subtracted from the listed rating to obtain the net load to be lifted. When more than the minimum required hoist reeving is used, the additional rope weight shall be considered part of the load to be handled.

3. Defined Arc $\pm 6^\circ$ on either side of longitudinal centerline of machine.

4. Capacities appearing above the bold line are based on structural strength. Tipping should not be relied upon as a capacity indication.





































5. The machine shall be leveled on a firm supporting surface. Depending on the nature of the supporting surface, it may be necessary to have structural supports under the outrigger floats or tires to spread the load to a larger bearing surface.

6. When either boom length or radius or both are between values listed, the smallest load shown at either the next larger radius or next longer or shorter boom length shall be used.

7. Tires shall be inflated to the recommended pressure before lifting on rubber.

8. For outrigger operation, outriggers shall be properly extended with tires raised free of crane weight before operating the boom or lifting loads.

Symbols Glossary

	Frame		Steering
	Outriggers		Transmission
	Outrigger Controls		Axles
	Engine		Brakes
	Fuel Tank Capacity		Tires
	Electrical System		Suspension
	Drive		Rotation
	Lights		Boom Elevation
	Cab		Swing
	Boom		Counterweight
	Fixed Swingaway		Oil
	Tele-Swingaway		Hydraulic System
	Jib		Hoist
	Boom Nose		Radius
	Boom Extension		Boom Length
	Speed		Hookblock
	Grade		Gear
	Lattice Extension		Luffing Jib

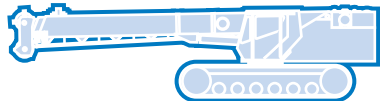
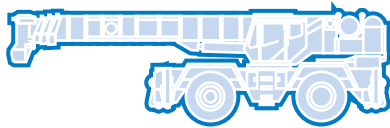
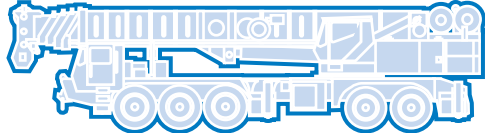
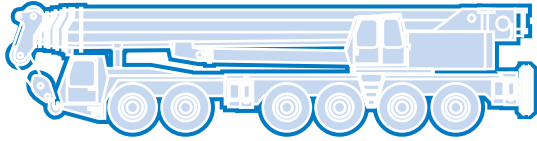
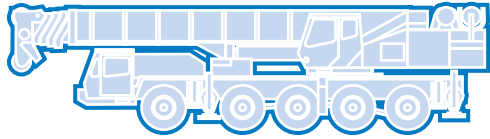

Grove Worldwide – World Headquarters

Grove North America
 1565 Buchanan Trail East
 P.O. Box 21
 Shady Grove, Pennsylvania 17256, U.S.A.
 Tel: [Int + 1] (717) 597-8121
 Fax: [Int + 1] (717) 597-4062
 Western Hemisphere, Asia/Pacific

Grove Europe Limited*

Sunderland SR4 6TT, England
 Tel: [Int + 44] 191 565-6281
 Fax: [Int + 44] 191 564-0442
 Europe, Africa, Middle East

Grove Europe Limited*

P.O. Box No. 268
 4A Kimber Road
 Abingdon, Oxfordshire, OX141SG
 Tel: [Int + 44] 1235 55-3184
 Fax: [Int + 44] 1235 55-3218
*Grove Europe Limited, Registered in England,
 Number 1845128, Registered office, Crown Works,
 Pallion, Sunderland, Tyne & Wear, England SR4 6TT

**Deutsche Grove GmbH
 Sales and Service**

Helmholtzstrasse 12, Postfach 5026
 D-40750 Langenfeld, Germany
 Tel: [Int + 49] (2173) 8909-0
 Fax: [Int + 49] (2173) 8909-30

Wilhelmshaven Works

Industriegelände West, Postfach 1853
 D-26358 Wilhelmshaven, Germany
 Tel: [Int + 49] (4421) 294-0
 Fax: [Int + 49] (4421) 294-301

Grove France S.A.

16, chaussée Jules-César, 95520 OSNY
 B.P. 203, 95523 CERGY PONTOISE CEDEX
 France
 Tel: [Int + 33] (1) 30313150
 Int: [Int + 33] (1) 30386085

Grove Asia/Pacific - Regional Office

171 Chin Swee Road
 #06-01 San Centre
 Singapore 0316
 Tel: [Int + 65] 536-6112
 Fax: [Int + 65] 536-6119
 Asia/Pacific, Near East

Grove China - Representative Office

Beijing Suite 6074
 No. 33 East Chang An Avenue
 Beijing, 100004, China
 Tel: [Int + 86] (10) 513-7766
 Fax: [Int + 86] (10) 513-7307

Grove Product Support

Western Hemisphere, Asia/Pacific
 1086 Wayne Avenue
 Chambersburg, Pennsylvania USA
 Tel: [Int + 1] (717) 263-5100
 Fax: [Int + 1] (717) 267-0404

Europe, Africa, Middle East
 Sunderland SR4 6TT, England
 Tel: [Int + 44] 191 565-6281
 Parts Fax: [Int + 44] 191 510-9242
 Service Fax: [Int + 44] 191 510-9560

<http://www.groveworldwide.com>

Bigge Crane and Rigging Co.

10700 Bigge Avenue
 San Leandro, CA 94577
 Phone: (888) 337-BIGGE or (510) 638-8100
 Fax: (510) 639-4053
 Email: info@bigge.com
 Web site: www.bigge.com

Constant improvement and engineering progress make it necessary that we reserve the right to make specification, equipment, and price changes without notice. Illustrations shown may include optional equipment and accessories and may not include all standard equipment.

Distributed By:

Form No.: SBRT880 Part No.: 3-816 198-10M Printed in U.S.A.

