

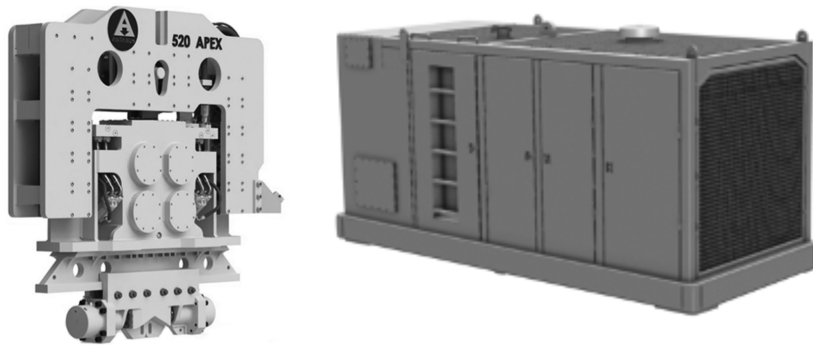

## OPERATION AND MAINTENANCE MANUAL

*Model 520 Apex with CAT C-18 Tier 4, Stage Power Unit*



ANTAEUS FOUNDATION EQUIPMENT LLC, 250 South Webster, Seattle, Washington 98132 [www.antaeususa.com](http://www.antaeususa.com)  
206 495-7030

## WARRANTY

### ANTAEUS FOUNDATION CONSTRUCTION EQUIPMENT LLC (ANTAEUS) Standard Warranty

ANTAEUS warrants new products sold by it to be free from defects in material and workmanship for a period of one year after date of delivery to the first user and subject to the following conditions:

ANTAEUS'S obligation and liability under this warranty is expressly limited to replacing, at ANTAEUS'S option, any parts that appear to ANTAEUS, upon inspection to have been defective in material or workmanship. Such parts shall be provided at no cost to the user at the business establishment of ANTAEUS or at the ANTAEUS distributor of the product during regular working hours.

This warranty shall not apply to component parts or accessories not manufactured by ANTAEUS and which carry the warranty of the manufacturer thereof or to normal maintenance parts (such as filters).

Replacements or repair parts installed in the product covered by this warranty are warranted only for the remainder of the warranty as if such parts were original components of said product.

ANTAEUS'S obligation under this warranty shall not include any transportation charges, costs of installation, duty, taxes TARRIFFS, or any other charges whatsoever, or any liability for direct, indirect, incidental, or consequential damage or delay.

If requested by ANTAEUS, products or parts for which a warranty claim is made are to be returned, transportation paid, to ANTAEUS.

Any improper use, including operation after discovery of defective or worn parts, operation beyond rated capacity, substitution of parts not approved by ANTAEUS or any alteration or repair by others in such manner as in ANTAEUS judgment affects the product materially and adversely shall void the warranty.

For impact pile hammers, driving in excess of 10 blows per inch (25mm) [set of 0.1 (2.5mm) per blow] is considered practical refusal. Driving in excess of 10 blows per inch (25mm) for more than 6 inches (150mm) or driving in excess of 20 blows per inch (25mm) at all is considered improper use and will void the hammer warranty.

For vibratory drivers, driving/extracting when the movement is less than 1" (25mm) per minute is considered practical refusal. Driving/extracting when movement is less than 1" (25mm) per minute for more than 5 minutes of driving/extracting or driving at all when penetration is less than 1" (25mm) per minute and amplitude is greater than 1" (25mm) [vibrator and pile are bouncing] is considered improper use and will void the vibrator warranty. Driving/extracting when bearing covers (paint removed) are above 210°F (100°C) is considered improper use and will void the vibrator warranty.

For limited-access drills and top-drive rotary heads, the use of a down-the-hole hammer without discussing the operation with ANTAEUS and getting prior written approval is considered improper use and will void the drill warranty.

For leads, use in lengths or at batters exceeding the initial set-up without ANTAEUS evaluating the new set-up and providing prior written approval is considered improper use and will void the leads warranty.

For power units, welding on power units or other equipment with electrical or electronic controls must be done with the battery leads disconnected. Welding with battery leads connected will void the warranty.

ANTAEUS MAKES NO OTHER WARRANTY, EXPRESSED OR IMPLIED, AND MAKES NO WARRANTY OF MERCHANTABILITY OR FITNESS FOR ANY PARTICULAR PURPOSE.

No employee or representative is authorized to change this warranty unless such change is made in writing and signed by an officer of ANTAEUS.

JULY 2016

PROPOSITION 65 WARNING LABEL

# CALIFORNIA

## PROPOSITION 65 WARNING

**Diesel engine exhaust and some of its constituents are known to the State of California to cause cancer, birth defects, and other reproductive harm.**



## INTRODUCTION

### Literature

This manual contains parts information for your ANTAEUS equipment. This manual should be stored in or near the power unit in a literature holder or literature storage area. Read, study and keep it with the equipment at all times.

English is the primary language for the ANTAEUS manuals. Continuing improvement and advancement of product design may have caused changes to your equipment which are not included in this manual. Whenever a question arises regarding your equipment or this manual, please consult ANTAEUS or your ANTAEUS distributor for the latest available information.

### Equipment Manual Set

This manual is for the Operation and Maintenance of your ANTAEUS equipment.

### Section 1 - General Information

This section provides a description of the equipment and specifications.

### Section 2 - Safety

The safety section lists the basic precautions and identifies hazardous and potentially dangerous situations. It is imperative that all operators and support staff read and understand the precautions listed before beginning operation, repair, or maintenance on the equipment.

### Section 3 - Loading, Unloading and Shipping

This section provides information for loading, unloading and shipping the equipment.

### Section 4 & 5 - Preparation for Operation and Operating Instructions

These sections are a reference for proper operation. Illustrations and proper procedures give guidance for operational preparation, handling, engine starting and equipment warm-up, operation, and stopping the equipment. Controls and gauges are explained. The operational description is basic. Operators gain knowledge and develop skills and techniques that enhance efficiency and economical production through experience and time dedicated to understanding equipment application and operation.

### Sections 6 & 7 - Maintenance and Torque Charts

These sections serve as a guide for equipment care. Service intervals, required lubrication, adjustments, and torque specifications for fasteners are listed. Major repairs are not detailed here or in the troubleshooting section. Major repairs should be entrusted only to experienced personnel.

### Section 8, 9 & 10 - Troubleshooting, Electrical and Hydraulic Information

These sections aid in resolving difficulties with the equipment. The information provided gives indications of possible causes for difficulties and the repairs required to correct malfunctions. Please contact International Construction Equipment, Inc. for assistance in diagnosing unresolved issues and corresponding repairs.







## Table Of Contents

Front Page of Manual	1
Warranty	2
California Approved Proposition 65 Warning Sticker	3
Introduction	4
Table of Contents	5
Table of Contents (Continued)	6
Section 1: General Information	7
Description of Hydraulic Hoses	8
ANTAEUS 325-6 Vibratory Pile Driver/Extractor Specifications-GENERAL	9
ANTAEUS TIER 4 800 HP STAGE 5 Hydraulic Power Unit Specifications	10
Section 2: SAFETY	11
Hazard Information-GENERAL	12
Hazard Information- Hoses, Tubes, Procedures, Hose Lines & Tubes Checklist, Precautions for Oils, Fire Extinguisher Requirements, Fire & Prevention	13
Hazard Information-Fire and Prevention (Continued)	14
Tasks BEFORE STARTING ENGINE	15
Section 3: Loading, Unloading, Shipping	16
Section 4: Preparation For Operation	17
Attaching Clamps and Beams To Vibrator	18
Connection Clamp Hoses	19
Connection of Hoses at Power Unit for Vibrator	20
Adjusting The Position of the Caissob Clamps with hydro Locks, bleeding The Clamp Hoses	21
Filling Vibrator Pressure Hoses	22
Purposely Blank Page	23
Control Panel Remote -Control Pendants-Exterior, Completion of Set-up and Maintenance	24
Control Panel Assembly-GENERAL NAMING OF COMPONENTS	25
How To Operate from Control Panel or from Hand Held Pendant	26
Full Speed Operation after warm up	27
Emergency Stop Button- How To Operate	28
Operation with Vibrator Driver/Extractor, Operating limits, Refusal, Rebounding, Maximum Bearing Temperatures, Safety Features	29
Operation with Vibratory Driver/Extractor using Remote Control Hand held Pendant	30
Pile Extraction, Underwater Operations	31
Section 6: MAINTENANCE- General, Maintenance Safety, CAT Maintenance	32



## Table Of Contents (Continued)

Daily Maintenance-Power Unit, After Engine Start-Up Checklist, Daily Maintenance-Vibrator, Before Start-Up Checklist	33
Service Intervals, Working In Severe Conditions, Air Conditions, Extended Inactive Periods	34
Lubrication of Diesel Engine, Engine Oil Types	35
Vibratory Gearbox Maintenance	36
Factory Installed Liquids	37
Draining and Filling Hydraulic Reservoir, Removing and Replacing Hydraulic Filters, Checking for Leaks	38
Recommended Hydraulic Oil, Operating in Sub-Freezing Conditions, Setting Clamp Relief Valve	39
Setting Clamp Relief Valve Step by Step Directions	40
Section 7: Torque Specs	41
Torque Specs (Continued)	42
Electrical System	43
Control Panel Assembly	44
Electrical System-Panel and Schematic A	45
Electrical System-Panel and Schematic B	46
Electrical System-Panel Internal, Vibrate Hour Meter & Proportional Control Adjustment	47
Hydraulic Schematic- Clamp System Explanation	48
Hydraulic Schematic - Vibrator Main Circuit	49
Hydraulic Schematic- Cooling Circuit-KIDNEY LOOP	50



**Section 1: GENERAL INFORMATION**

**Power Unit**

The ANTAEUS power unit is powered by a Tier 4 Caterpillar diesel engine and is mounted on a tubular sub-base that serves as a fuel tank. The power unit and vibrator are operated from the control panel or remote-control pendant. Hydraulic oil is stored in the main reservoir as well as a special spare reservoir called the "spare hydraulic tank" which is above the main reservoir. An oversized heat exchanger is mounted in front of the engine for engine cooling, hydraulic oil cooling, and turbocharger after-cooling. A large belt driven fan is rotated directly from the diesel engine crankshaft. All components are contained in a sheet metal enclosure with lockable doors and a central lifting point.

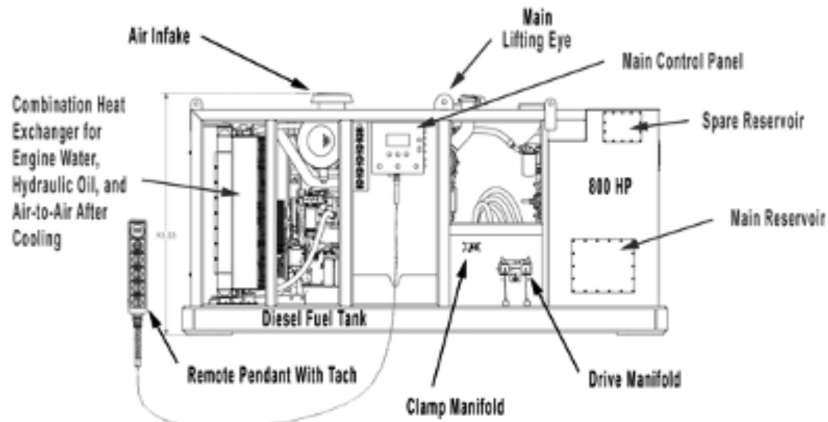

**Vibrator Driver/Extractor**

The Vibratory Driver/Extractor consists of three major components - the gear case, the vibration suppressor, and the hydraulic clamp. The gear case contains eccentric weights that rotate in a vertical plane to create vibration. Hydraulic motors drive the eccentric weights. The vibration suppressor contains rubber elastomers to isolate the vibration from the crane line. The hydraulic clamp attaches the vibrator to the pile.

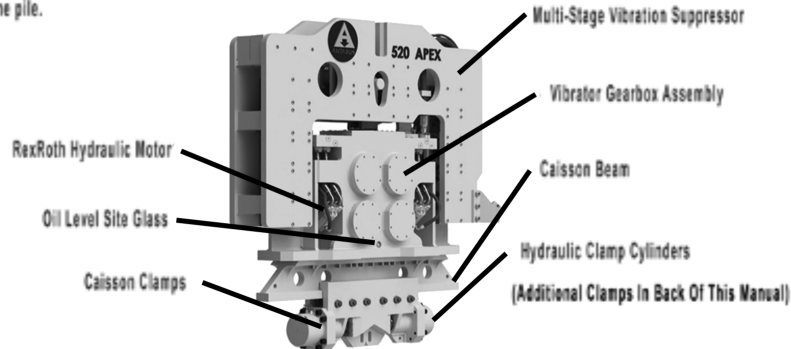



### Hydraulic Hoses

There are five hoses that connect at the power unit. Two large 2 inch (50 mm) hydraulic hoses connect the main circuit to the motors on the vibrator. Two small hydraulic hoses serve as the “clamp open” and “Clamp closed” lines. A hose is also provided for motor case drainage.

The hose bundle comes standard with 150-feet (45 meters) of hoses. The long hose bundle is actually three 50-foot (15 meter) sections coupled together to make up the 150-foot (45 meter) hose set.

### Clamps and Accessories

A variety of clamps and accessories are available for ANTAEUS vibrators. Clamps for driving or extracting wood piles, concrete piles, sheet piles as well as small and large diameter pipe are available. In addition, ANTAEUS can design and manufacture special clamps to fit the needs of a pipe driving or extracting task.

Please consult the ANTAEUS Clamps & Accessories Manual.

**NOTE:** The Antaeus vibratory pile driver/extractor can accept the APE , ICE, & MKT Clamps, since the Antaeus vibro is drilled with all the necessary bolt patterns used by its main competitors. Please consult the factory before attaching clamps manufactured by others.

Vibrator Specifications



**Tier 4**

## ***Model 520 Apex***

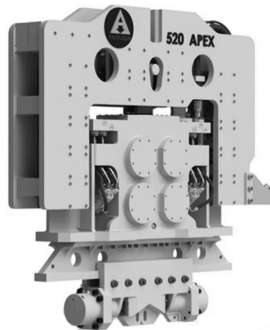

SPECIFICATIONS	DATA
Eccentric Moment	5,200 inch pounds
Drive Force	200 Tons
Frequency Maximum (VPM)	0 - 1,650 vpm
Max Line Pull	125 Tons
Suspended Weight with Sheet Clamp	18,000 lbs
Throat Width	16.75 in
Length	102 inches
Height w/o Clamp	105 inches

Antaeus Foundation Equipment LLC 250 South Webster, Seattle, Washington 98108 (206) 495-7030  
[www.antaeususa.com](http://www.antaeususa.com)

Power Units Specifications



## Model 800 Hydraulic Power Unit Tier 4, Stage 5 Dual Flow

SPECIFICATIONS	DATA
Engine Type	Tier 4, Stage 5 Caterpillar C18
Horse Power	800 HP (597 kW)
Drive Pressure	0 - 4,500 psi (310 bar)
Drive Flow	220 gpm (833 lpm)
Clamp Pressure	4,800 psi (331 bar)
Clamp Flow	10 gpm (3 lpm) (350 Bar)
Engine Speed	1800 rpm with 1.38 updrive 2484 rpm
Weight	20,000 lbs (9,072 kg)
Length	152 in (385 cm)
Width	82 in (208 cm)
Height	94 in (239 cm)
Hydraulic Reservoir	800 gal ( 3028 L)
Hydraulic Reservoir spare tank	55 gal ( 208 L)
Fuel Capacity	150 gal (568 L)

Specifications may vary due to site conditions, specific hammer conditions or product set up.  
Specifications may change without notice.

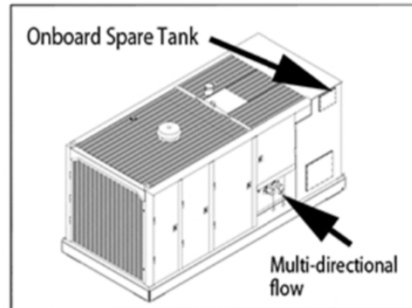

**Power Unit Features:**

**Operates Vibros, drills, Impact Hammers**

**On board spare hydraulic storage**

**Worldwide CAT Service**

**Full Forward & Reverse Flow**

**Meets European Regulations**

**Antaeus Foundation Equipment LLC 250 South Webster, Seattle, Washington 98108 (206) 495-7030**

**[www.antaeususa.com](http://www.antaeususa.com)**

Section 2: SAFETY  
Important Safety Information



Most accidents involving product operation, maintenance and repair are caused by failure to observe basic safety rules or precautions.

An accident can often be avoided by recognizing potentially hazardous situations before an accident occurs.

A person must be alert to potential hazards. This person should also have the necessary training, skills and tools to perform these functions properly.

Improper operation, lubrication, maintenance or repair of this equipment can be dangerous and could result in serious injury or death to you or other persons.

Do not operate or perform any lubrication, maintenance or repair on this equipment, until you have read and understood the operation, lubrication, and maintenance and repair information in both the ANTAEUS and Caterpillar Operation & Maintenance Manuals.

Safety precautions and warnings are provided in the manuals. If these hazard warnings are not heeded, serious bodily injury or death could occur to you or other persons.

Important Safety Information is marked as shown below.



This is the safety alert symbol. It is used to alert you to potential physical injury hazards. Obey all safety messages that follow this symbol to avoid possible injury or death.



DANGER indicates a hazardous situation which, if not avoided, will result in death or serious injury.



WARNING indicates a hazardous situation which, if not avoided, will result in death or serious injury.



CAUTION indicates a hazardous situation which, if not avoided, will result in minor or moderate injury.



Safety instructions (or equivalent) signs indicate specific safety-related instructions or procedures.

ANTAEUS and Caterpillar cannot anticipate every possible circumstance that might involve a potential hazard. The warnings in the manuals and on the equipment are therefore not all inclusive. If a tool, procedure, work method or operating technique not specifically recommended in writing by authorized personnel from ANTAEUS or Caterpillar is used, you must satisfy yourself that it is safe for you and others. You should also ensure that the equipment would not be damaged or made unsafe by the operation, lubrication, maintenance and/or repair procedures you choose.

The information, specifications, and illustrations in the manuals are on the basis of information available at the time it was written. The specifications, torques, pressures, measurements, adjustments, illustrations, and other items can change at any time. These changes can affect the service given to the product. Obtain the complete and most current information before starting any job. ANTAEUS and Caterpillar dealers have the most current information available.



## Hazard Information

Use caution when removing filler caps, grease fittings, pressure taps, breathers or drain plugs. Hold a rag over the cap or plug to help prevent being sprayed or splashed by liquids under pressure.

Wear a hard hat, protective glasses, hearing protection and other protective equipment as required by job conditions.

Do not wear loose clothing or jewelry that can catch on controls or other parts of the equipment. Make certain all protective guards and covers are secured in place.

Use all cleaning solutions with care.

Never put maintenance fluids into glass containers since glass containers can break.

Report all needed repairs.

## Maintenance Procedures

Stop the equipment. Stop the engine.

Ensure the protective locks or controls are in the applied position.

Disconnect the batteries whenever performing any maintenance or before servicing the electrical system. If the engine has an electric starter, disconnect and tape the battery ground leads to prevent accidental starting.

Disconnect the batteries before performing any welding. Failure to do so will cause serious damage to the power unit's operating system.

Do not attempt any repairs or adjustments to the engine or equipment while it is running.

Do not attempt any repairs that you do not understand or for which you are not qualified. Use proper tools; replace or repair broken or damaged equipment.

Block or restrain the equipment, if applicable before operating or performing maintenance.

Do not adjust, or set, hydraulic pressures higher or lower than those specified in the parts manual.

## Pressurized Air and Water Hazards

Pressurized air can cause personal injury. When using pressurized air for cleaning, wear a protective face shield, protective clothing and protective shoes.

The maximum air pressure must be below 30 psi (205 kPa) and maximum water pressure must be below 40 psi (275 kPa) for cleaning purposes.

Wear eye protection at all times when cleaning the cooling system. Pressurized water could cause debris and/or hot water to be blown and result in serious personal injury.

Do not spray pressurized water at the control box. Pressurized water could result in damage to the onboard computer module, which could cause the operating system to malfunction.

## Fluid Penetration Risk

Always use a board or cardboard when checking for a leak. Escaping fluid under pressure, even a pinhole size leak, can penetrate body tissue, causing serious injury or possible death.

If fluid is injected into your skin, a doctor familiar with this type of injury must treat it immediately.



## Hoses, Lines and Tubes Handling Procedures



Do not pull on, or attempt to move equipment, by force or pressure to the hydraulic hoses. The power unit will need to be moved closer to the work if hoses do not reach.

Do not operate this equipment with hydraulic hoses that are damaged or kinked. Replace damaged hoses immediately.

Do not lift or support hydraulic hoses with wire rope slings.

Do not pull kinks in the hoses. Kinks will reduce the hose safety factor by 50 percent.

Do not bend or strike high-pressure lines. Do not install bent or damaged lines, tubes or hoses.

Leaks can cause fires. Repair any loose or damaged fuel and oil lines, tubes and hoses.

Inspect all lines, tubes and hoses carefully. Do not use your bare hands to check for leaks. Tighten all connections to the recommended torque.

Make sure that all clamps, guards and heat shields are installed correctly to prevent rubbing against other parts and excessive heat during operation.

## Hoses, Lines and Tubes Check List

End fittings damaged, leaking or displaced.

Outer covering chafed or cut and wire reinforcing exposed.

Outer covering ballooning locally.

Evidence of kinking or crushing of the flexible part of the hose.

## Precautions for Oils

Hot oil and components can cause serious personal injury. Do not allow hot oil or components to contact the skin.

Keep all exhaust manifold and turbocharger shields in place to protect hot exhaust from oil spray in the event of a hose, tube or seal failure.

## Fire Extinguisher Requirements

Have a fire extinguisher of the appropriate type and size available and know how to use it. Inspect and have it serviced as recommended on its instruction plate.

## Fire or Explosion Prevention

All fuels, most lubricants, hydraulic oil, and some coolant mixtures are flammable.

Diesel fuel is flammable. Gasoline is flammable. The mixture of diesel and gasoline fumes is extremely explosive.

Do not weld or flame cut on pipes or tubes that contain flammable fluid(s). Clean them thoroughly with non-flammable solvent before welding or flame cutting on them.



### Fire or Explosion Prevention (continued)

Clean and tighten all electrical connections. Check regularly for loose or frayed electrical wires. Refer to maintenance schedules for inspection interval. Have all loose or frayed electrical wires tightened, repaired or replaced before operating the equipment. Wiring must be kept in good condition, properly routed and firmly attached. Routinely inspect wiring for wear or deterioration. Loose, unattached, or unnecessary wiring must be eliminated. All wires and cables must be of the recommended gauge and properly fused.

### Crushing or Cutting Prevention

Support equipment and attachments properly at all times and especially when working beneath them. Never attempt adjustments while the engine is running unless otherwise specified in this manual.

Stay clear of all rotating and moving parts. Guards should be in place whenever maintenance is not being performed.

Keep objects away from moving fan blades. They will throw or cut any object or tool that falls into their path. Wear protective glasses when striking objects to avoid injury to your eyes.

Make sure no one can be injured by flying debris before striking any object. Chips or other debris can fly off objects when struck.

### Mounting and Dismounting

Do not climb on, or jump off the equipment or stand on components that cannot support your weight. Use an adequate ladder. Always use steps and handholds when mounting and dismounting.

Clean steps, handholds and areas of the equipment you will be working on or around.

### Before Starting the Engine

Read "Before Starting the Engine" Instructions posted on the main panel door. Read the CAT engine manual.

Make sure the remote-control pendant (or radio control) is in a safe place. Do not leave the pendant (or radio control) unattended.

On the control panel, make sure the main circuit (REV-OFF-FOR) and auxiliary circuit (REV-OFF-FOR) switches are set to OFF.

On the remote-control pendant, make sure the main circuit (REV-OFF-FOR) and auxiliary circuit (REV-OFF-FOR) switches are set to OFF.

On the control panel and pendant, make sure the clamp OPEN-CLOSE switch is in the center (neutral) position. Make sure power unit is on level, stable ground.

Make sure equipment areas are clear for operation.

Do not smoke or use open flame in the vicinity when filling fuel tanks or when flammable vapors are present.



### Before Starting the Engine (continued)

Make sure that all lifting equipment, including cranes, wire rope, slings, hooks, shackles, etc., are properly sized for the worst case loads anticipated during operations. Check wire rope clips for tightness, and check wire ropes for wear or damage daily.

If there are any questions about the weights, specifications, or performance of the equipment, contact ANTAEUS before handling or operating the equipment.

Do not attempt to connect the quick-disconnect couplers when the power unit is running. Always make an inspection of the equipment before and after starting at the beginning of operations.

### During Engine Starting

Read "Engine Starting" in the Caterpillar Operation & Maintenance Manual. Equipment area should be clear before starting operation. Make sure no one is working on or close to equipment before starting.

#### Equipment Operation

Only well-trained and experienced personnel should attempt to operate or maintain this equipment. Do not leave the equipment control pendant (radio control) unattended.

Vibrator should be clamped to pile before starting vibrator.

Use tag line to control vibrator when possible.

Do not stand any closer to equipment than necessary when in operation. Parts may loosen and fall. Dirt or rocks may fall from auger flighting during drilling operations.

Do not operate this equipment with hydraulic hoses that are damaged or kinked. Replace damaged hoses immediately.

Do not lift, or support, hydraulic hoses with wire rope slings.

Do not pull on, or attempt to move equipment, with hydraulic hoses.

Do not operate the equipment within 15' (5m) of electrical power lines, transformers, and other electrical equipment, or within such distance as required by applicable safety codes.

Do not side-load crane boom. Dangerous crane boom damage may result. Always be sure that the crane line is aligned with the centerline of the equipment used.

Do not use the vibrator hydraulic clamp to handle piling.

Make sure that operations will not damage adjacent structures or excavations.

If the equipment is to be used for anything other than specified use, contact ANTAEUS before using the unit.

### Stopping Equipment

Make sure vibration has stopped before opening hydraulic clamp.

Make sure vibrator and power unit have completely stopped before moving equipment.

#### Stopping Engine

Read "Engine Stopping" in the Caterpillar Operation & Maintenance Manual.



### Section 3: LOADING, UNLOADING & SHIPPING

#### Power Unit

The power unit should be loaded with the heat exchangers facing to the rear of the truck to prevent damage to the heat exchangers from flying objects. The power unit is usually held to the truck by wrapping a chain around both ends of the fuel tank sub-base. Before shipping the power unit, tape the exhaust rain cap shut to prevent rainwater from entering. If quick-couplers do not have safety cables for the caps and plugs, store caps and plugs under the panel in the storage box rather than risk the possibility of them coming loose and falling off into traffic. Make sure all doors are fully closed and latched. Tighten fuel cap and close fuel petcock to prevent loss of diesel fuel.

#### Vibrator

The equipment should be shipped in its special travel stand. If shipping without travel stand, lay flat on the trailer deck. Lift the equipment by rigging one line to the lifting pin and one line to the hose bundle as one load. Avoid crushing hydraulic lines.

#### Final Inspection Once loaded

Check to make sure there is no dirt or rocks that may have been gathered on power unit or hoses. Be sure no tools or loose objects are left behind that could fall off and cause injury or death.

#### Damage During Shipment

Before the truck leaves, carefully inspect the equipment and hoses for any missing components or signs of damage that may have occurred during shipment or unloading. In the event of damage during shipment, notify the trucking agent at once. Note all damage on the bill of lading. Fax or email the information to ANTAEUS as soon as possible. CALL 206 495-7030 to report any accident asap. Any delay may make it difficult to identify the responsible party.

Section 4: PREPARATION FOR OPERATION  
General



When unloading and unpacking the power unit and equipment, use extreme care. For your protection, make a thorough inspection of the unit immediately upon delivery. In case of any damage or shortage, notify the transit agent at once and have the delivering carrier make a notation on the freight bill.

Rigging of Vibrator

A steel wire rope sling must be connected to the lifting pin of the vibration suppressor. The required strength of this sling depends on the capacity of the crane and the work to be carried out. A safety factor of five is recommended. Several turns of a smaller diameter cable will usually last longer than one turn of a larger diameter cable. Consult a rigging expert or rigging handbook for guidance. Be aware of governmental protocols, regulations, and guidelines for rigging.

The performance of fabric slings for vibrator operation is uncertain. Consult the sling manufacturer before using a fabric sling.

**! WARNING / ADVERTENCIA**

**Wire rope failure or cable clamp slippage may result in injury or death. Check cables and cable clamps daily.**

Attaching Hydraulic Clamp or Caisson Beam to Vibrator

The vibrator is often shipped with the hydraulic clamp or caisson beam already attached. If the clamp or beam is not attached, it will be necessary to attach it to the bottom of the vibrator. Run a flat gauge along the bottom surface of the gearbox to be sure it is flat.

**! WARNING / ADVERTENCIA NOTICE / AVISO**

**The bottom of the vibrator and the top of the clamp or caisson beam must be clean and free of rust or paint. Bolt holes must be free of rust and dirt. Dirt, rust or paint could cause bolts to loosen and the clamp or beam to come loose. Use only socket-head cap screws at attach clamp or beam.**

**! WARNING / ADVERTENCIA NOTICE / AVISO**

**Under-tightening or over-tightening may cause bolts to break and clamp or caisson beam to come loose. If one bolt breaks, others may be damaged and all must be replaced. Never use vibrator if one or more bolts are broken. Check bolt torque daily. See Section 7: TORQUE SPECIFICATIONS.**



#### Attaching Sheeting Clamp to Vibrator

Attach the clamp to the vibrator with the clamp cylinder end (moveable jaw) at the same end of the vibrator as the hose chute. All 1.5-6UNC x 5 socket-head cap screws with lock washers must be in place and tightened to approximately 2,700 ft-lbs (3600 N-m). Use Never-Seez or a similar anti-seize lubricant on bolt threads. Read Section 7 - TORQUE SPECIFICATIONS. See "Connection of Sheeting Clamp Hoses".

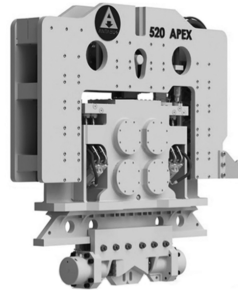

#### Attaching Caisson Beam to Vibrator

Attach the caisson beam to the bottom of the vibrator and tighten as above. Different caisson beam require different length bolts. Check Vibrator Clamp Parts Manual for correct length of bolts and whether lock washers are required. Bolts should allow for 1-1/2" (35-50 mm) of penetration into vibrator base. After caisson beam is attached to vibrator, slide the caisson clamps into position on the caisson beam and lock in place.

The mating surfaces of the caisson beam and clamps must be clean and free of dirt, rust or paint. See "Connection of Caisson Clamp Hoses". **CLAMPS MUST ALWAYS BE CENTERED ON THE PILE. CENTER LINE OF VIBRO IS CENTER OF OIL LEVEL SITE GLASS.**

**Caisson  
Clamps**

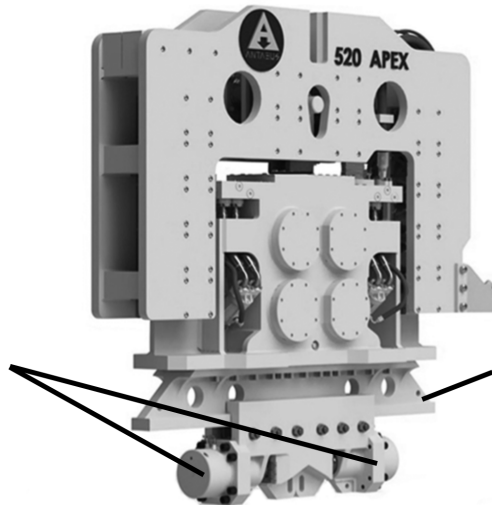

**Caisson  
Beam**



### Connection of Sheeting Clamp Hoses

1. Connect two hoses at end of the vibrator to the sheeting clamp at that end as shown at right.
2. Connect hose from fitting marked "C" on vibrator to fitting marked "C" on clamp. Connect hose from fitting marked "O" on vibrator to fitting marked "O" on clamp.

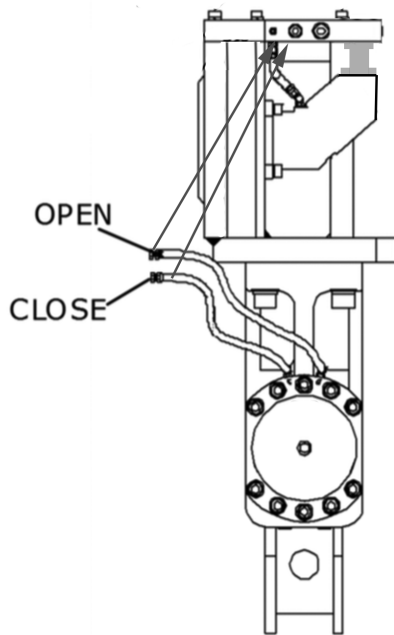

### Connection of Caisson Clamp Hoses

Connect two hoses at each end of the vibrator to the caisson clamp at that end as shown for sheeting clamp connection above.



### Connection of Hoses at Power Unit for Vibrator

The vibrator and hydraulic clamp are connected to the power unit by five hydraulic hoses. Connect hoses as shown below. The hoses connect to the power unit with quick-disconnect couplers. Hose couplers are arranged to insure correct connections at the power unit.

Clean couplers with a lint-free cloth before making connections.

Make sure that the couplers are fully run up and hand tightened prior to using an appropriate chain-type wrench.



**CAUTION / ATENCIÓN**

**NOTICE / AVISO**

**Power unit must be shut down during connection of hydraulic hoses. Improper hose connections can cause ruptured hoses or damaged components and poor equipment performance.**

### Connection of Hydraulic Hoses at Vibrator

The vibrator is usually shipped with the hoses attached. If hoses were shipped separately, they must be connected in the field. Connect hoses as shown below.

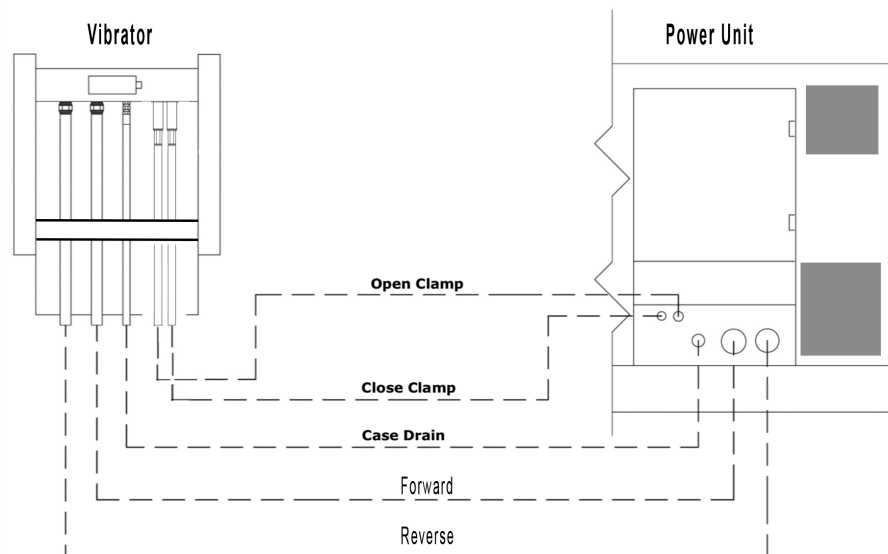



### Adjusting The Position of The Caisson Clamps with Hydro Locks

1. Diesel engine must be running.
2. Lift vibrator with clamps into the air.
3. With jaws open, loosen jam nut on HydroLock holding valve (see diagram below).
4. Back out Allen-screw to relieve pressure. It may be necessary to rest the weight of the vibrator on the clamps to release the HydroLock cylinders.
5. Adjust position of clamps on caisson beam.
6. Hand tighten Allen-screw. Tighten jam nut.
7. Close clamp jaws. Wait for CLOSED light to come on.
8. Open jaws. Clamps will be locked onto caisson beam.

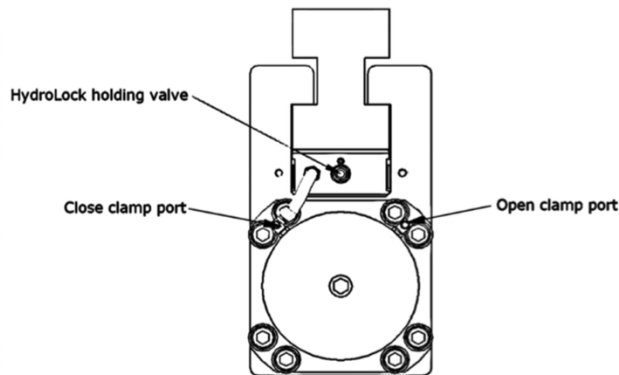

### Bleeding The Clamp Hoses

If the clamp hoses are connected at the job site or if air is present in these hoses, they must be bled prior to operation.



**Always use a board or cardboard when bleeding hoses. Escaping oil under pressure, even a pinhole size leak, can penetrate body tissue causing serious injury or possible death.**

1. Read Section 5: OPERATION. Also, see Caterpillar Operation & Maintenance Manual. Start and warm up the diesel engine in accordance with Section 5: OPERATION.
2. With the engine warmed up and running at 1200 RPM, loosen the close clamp line at the clamp or remove the setscrew in the end of the hydraulic cylinder. Turn the clamp switch on the remote-control pendant to CLOSE. Wait until oil flows from the connection at the clamp. When oil flows without air, tighten the connection. Use a catch basin for escaping oil and discard in an approved manner.
3. After the line has been bled, alternately turn the clamp switch to CLOSE and OPEN to insure that the clamp is working properly. It may be necessary to bleed the line more than once. The open-clamp line may also require bleeding.

## Filling Vibrator Pressure Hoses



**Vibrator may start if hoses are connected improperly.**

The vibrator is usually shipped with the hydraulic hoses full of oil, and the unit may be used immediately. However, if the pressure hose has been removed from the unit, the hose should be allowed to fill with hydraulic fluid prior to full-speed operation.

Read Section 5: OPERATION. Also, see Caterpillar Operation & Maintenance Manual.

Start and warm up the diesel engine in accordance with Section 5: OPERATION. Hold the vibrator in a vertical position.

With the engine warmed up and running at 1200 RPM, turn the MAIN (FOR-OFF-REV) switch to REV. The hoses will fill with oil in about five minutes. If the vibrator starts, stop power unit immediately and recheck hose connections.



## Control Panel & Remote-Control Pendants- Exterior

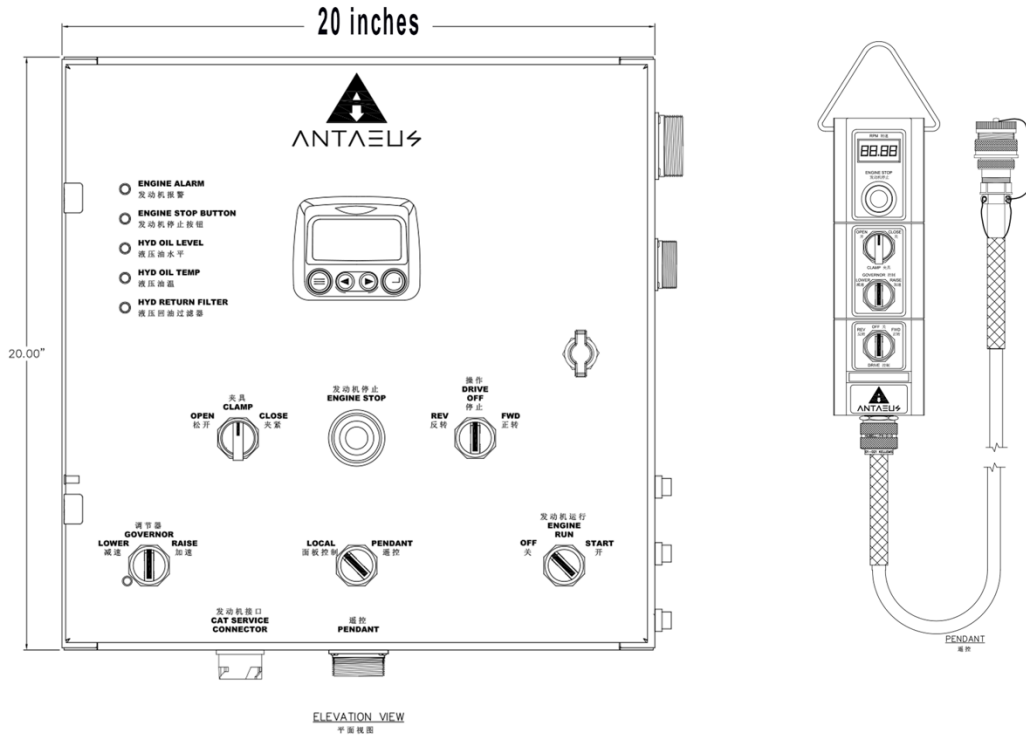

### Completion of Set-up and Maintenance

Complete all preparation as described in Section 4: PREPARATION FOR OPERATION.  
Read Section 6: MAINTENANCE and perform any required maintenance. See Caterpillar Operation & Maintenance Manual.

### Control Panel Components

The power unit control panel contains the controls for the diesel engine and displays operating parameters and fault lights & information. Local controls are provided for the vibrator and clamp. A remote-control pendant is provided as the primary control for vibrator and clamp.

# Control Panel Assembly

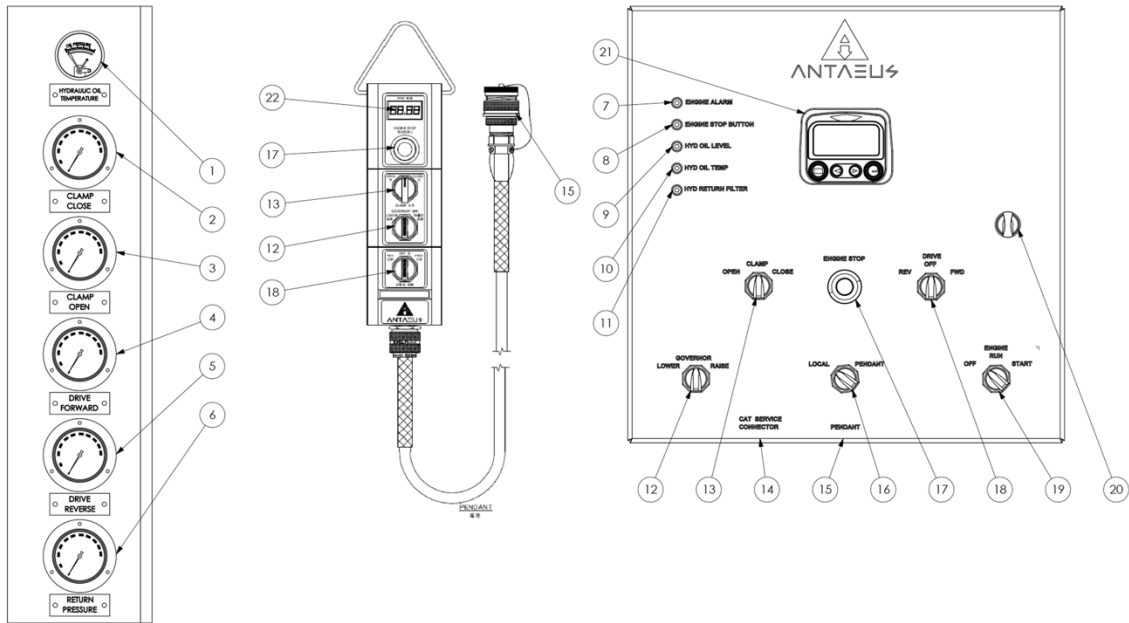

## Remote, Local or Radio-remote Operation

The vibrator may be operated from either the remote-control pendant (pendant) or the control panel (LOCAL). Pendant or Local operation is selected by the LOCAL-PENDANT switch at the bottom of the control panel.

### Operation using 50-foot (15 m) control pendant. (PENDANT)

The remote pendant is normally used to control the operation of the vibrator. The pendant is connected to the control cabinet with 50' (15 m) of electrical cable to permit operation from any position to best view the operation of the equipment. Optional pendant extensions are available upon request.

The LOCAL-PENDANT switch must be in the PENDANT position to operate the vibrator using the pendant. To use the controls on the control panel the LOCAL-PENDANT toggle switch must be in the LOCAL position.

### Operation From the Control Panel (LOCAL) if Pendant is Damaged or Missing

If the pendant is damaged, if the pendant line is cut, the equipment may be operated from the control panel.

To operate using the control panel instead of the pendant:

1. Change the LOCAL-PENDANT switch at the bottom of the control panel to LOCAL.

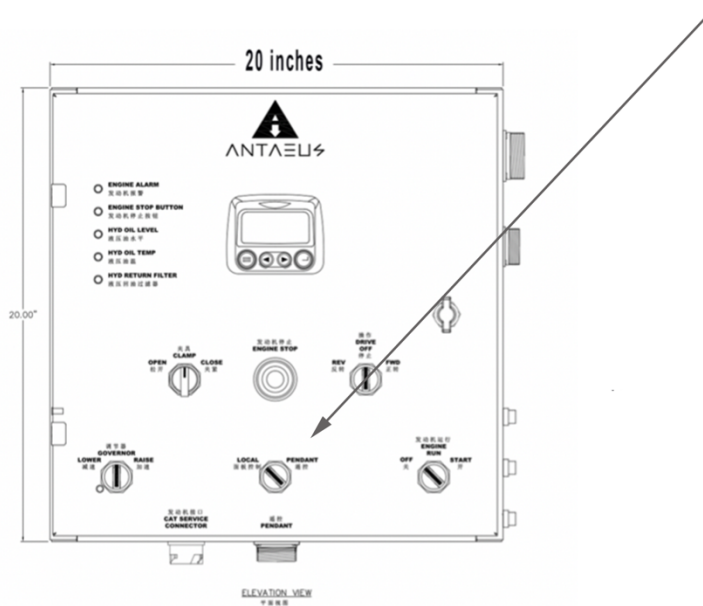



### **Full-speed operation after warm-up**

When the engine is warmed-up full speed operation may begin. Adjust the throttle so that the engine is running at the high idle rpm indicated below. The engine should maintain the full load rpm indicated below under load.

### **Engine Shutdown**

1. Stop the vibrator by turning the MAIN DRIVE (REV-DRIVE OFF-FOR) switch to OFF.
2. If the engine has not been warmed up, the engine may be shut down without a cool-down period. Turn the MAIN DRIVE switch to OFF.
3. If the engine has been warmed up (running at above 185oF [85oC] for 15 minutes or more), the engine should be cooled down before shut-down.
  - a. If the engine has not been idled down, reduce engine rpm to 1200 for 2 minutes, then reduce to 700 for 2 more minutes.
  - b. If the engine has been idled down, increase engine rpm to 1200 for 2 minutes, then reduce to 700 for 2 more minutes.
  - c. After the 4-minute cooling period, turn the DRIVE switch to OFF.
4. Turn the ENGINE RUN switch on the control panel to OFF.



## Emergency Stop

In an emergency, the engine and vibrator may be stopped by pushing the **EMERGENCY STOP** button on center of the control pendant or the control panel.

<b>! WARNING / ADVERTENCIA</b>	<b>NOTICE / AVISO</b>
<p><b>Engine shutdown may cause the hydraulic clamp to open.</b></p> <p><b>Use the EMERGENCY STOP button only in actual emergencies as the required engine cool-down period is eliminated.</b></p>	

### Resetting Emergency Stop Button After Use

Pushing the **EMERGENCY STOP** button will cause all operating functions to stop. Diesel engine and vibrator will stop immediately.

To reset the **EMERGENCY STOP** button, pull out the **EMERGENCY STOP** button. All **EMERGENCY STOP** buttons (pendant, control panel and optional radio-remote control) must be reset for engine start.

To restart the power unit, follow normal engine start procedure.

The hand held pendant **PUSH-PULL** Emergency stop

Panel  
The **PUSH-PULL**  
Emergency Stop Here

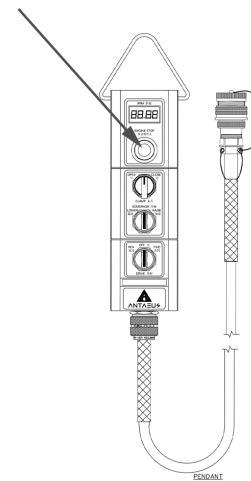
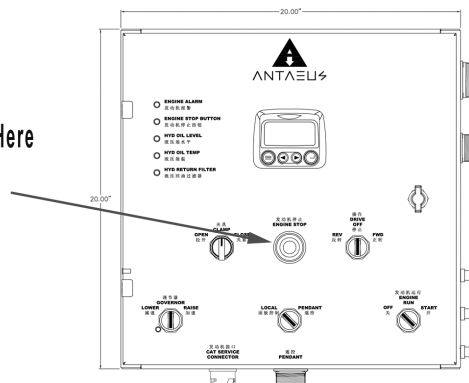





## Operation with Vibrator Driver/Extractor

### Operating Limitations

As with all equipment, there are limitations for operation where the equipment can be expected to operate in a long-lasting, safe and efficient manner.

For ANTAEUS vibrators, limits exist for refusal, rebound, and bearing temperatures. Exceeding these limits may result in unsafe or damaging operation. Operation beyond these limits will void the vibrator or power unit warranty.

### Refusal

Driving/extracting when the movement is less than 1" (25mm) per minute is considered practical refusal. Driving/extracting when movement is less than 1" (25mm) per minute for more than 5 minutes of driving/extracting is considered improper use and will void the vibrator warranty.

### Rebound (Bouncing)

Rebound can occur when the pile hits a nearly impenetrable layer or obstruction. Pile energy may be transferred back into the vibrator causing the vibration suppressor to move violently relative to the vibrator gear case. If rebound occurs, the vibrator should be stopped immediately.

Driving when amplitude is greater than 1" (25mm) [vibrator and pile are bouncing] is considered improper use and will void the vibrator warranty.

### Maximum Bearing Temperatures

Maximum bearing cover temperatures (paint removed) should not exceed 210°F (100°C).

Driving/extracting when bearing covers (paint removed) are above 210°F (100°C) is considered improper use and will void the vibrator warranty.

### Safety Features

The vibrator, when operated with an ANTAEUS power unit, has several features to insure safe, efficient, and environmentally-friendly operation.

1. The vibrator should not be started until the clamp is closed.
2. A check valve maintains clamping pressure if a clamp hose fails.
3. Pressure relief valves limit operating pressure in vibrator and clamp hydraulic circuits.
4. A Stop pin maintains a connection between vibrator gear case and suppressor if elastomers fail.
5. A warning light comes on if the hydraulic return filter is clogged.
6. The engine is shut down if the hydraulic oil level is low.
7. The engine is shut down if the hydraulic oil temperature is high.
8. The engine is shut down if the engine coolant temperature is high.



## Operation with Vibratory Driver/Extractor using Remote-control Pendant

### **WARNING / ADVERTENCIA**

**Make sure that crew has a clear view of vibrator and working area.  
Insure good communication between vibrator operator and crane operator.**

### **WARNING / ADVERTENCIA**

**Industry practice suggests a safety line should connect pile to crane or piling rig.  
Do not use the hydraulic clamp to carry piles.**

### Clamp to Pile

Position vibrator on pile. Turn the CLAMP (OPEN-CLOSE) switch on the pendant to CLOSE. The CLOSED light on the pendant and control panel will illuminate when the clamp has achieved adequate pressure to permit vibration to begin. The light should normally come on in a few seconds.

### Start Vibrator

1. Make sure engine is running at the proper speed.
2. Turn the MAIN (REV-OFF-FOR) switch to FOR position.

### Stop Vibrator

Turn the MAIN DRIVE (REV-OFF-FOR) switch to OFF position.

### Unclamp From Pile

1. Make sure the MAIN (REV-OFF-FOR) switch is in the OFF position and vibration has stopped.
2. Take slack from crane line holding vibrator.
3. Hold the CLAMP switch in the OPEN position to open the hydraulic clamp. Opening of clamp usually takes about ten seconds.

### Changing Frequency (vibrations per minute)

In order to provide maximum flexibility in achieving optimum pile penetration and extraction rates, the frequency of the vibrator is adjustable.

The frequency can be varied by changing the engine rpm on the pendant using the GOVENOR "LOWER-RAISE" switch. Engine RPM is displayed on the digital readout located on the top of the hand held pendant.

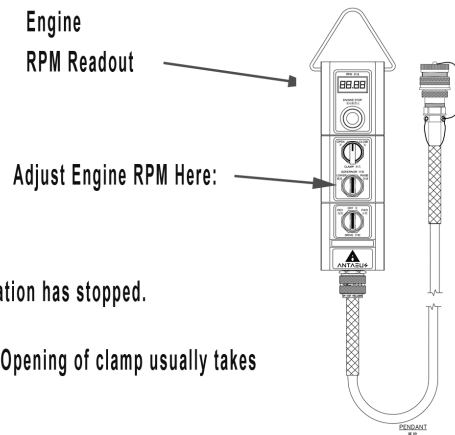



## Pile Extraction

The vibration suppressor has a safety stop pin to limit the load applied to the elastomers. When the maximum line pull capacity of the suppressor is reached, an audible metal-to-metal contact at the safety pin will occur. The most effective way to monitor extraction line pull is with the in-crane load indicator. Keep extraction pull below the line pull capacity of the vibration suppressor.

## Underwater Operation

ANTAEUS vibrators may be safely operated underwater provided proper preparation is made and certain precautions are taken. For operation at depths up to 15' (5m): Although ANTAEUS vibrators have been used at shallower depths many times without problems, it is recommended that the procedure below be used whenever operating underwater.

For operation at depths below 15' (5m):

1. Install a 15 psi (1 bar) relief valve into a gear case fill hole. On vibrators with only one fill hole, remove the centrifugal breather and attach relief valve there.
2. Air pressure is applied at the other gear case fill hole. The preferred method of pressure control is to use a diving regulator mounted on the suppressor housing to automatically regulate pressure.
3. Connect an air hose to the gear case fill hole on the top of the gear case. Use a 2-wire, 3/4" hose rather than an air hose to prevent crimping. Connect the hose to the regulator and thread hose through suppressor housing and add to hydraulic hose bundle running to power unit.
4. If air pressure is to be controlled manually rather than using a regulator, pressure must be increased by 0.5 psi per foot of water depth (1 atm per 8 m) as vibrator goes deeper. Pressure must be decreased by 0.5 psi per foot of water depth (1 atm per 8 m) as vibrator gets shallower.
5. Check gear oil level in sight glass every time the vibrator comes out of the water. If the oil level is increasing or appears milky, replace the gear oil immediately.
6. It is helpful to install a 1/4" line along with the air hose for connection to a diving pressure gauge.
7. At the end of the job, drain the gearbox oil, flush gearbox with AW 46 hydraulic oil, then drain and add standard oil.



## Section 6: MAINTENANCE

### General

Preventive maintenance includes normal servicing that will keep the power unit, vibratory driver/extractor and rotary head in peak operating condition and prevent unnecessary trouble from developing. This servicing consists of periodic lubrication and inspection of the moving parts and accessories of the unit.

Lubrication is an essential part of preventative maintenance, controlling to a great extent the useful life of the unit. Different lubricants are needed and some components in the unit require more frequent lubrication than others. It is important that the instructions regarding types of lubricants and frequency of their applications be closely followed.

To prevent minor irregularities from developing into serious conditions that might involve shutdown and major repair, several other services or inspections are recommended for the same intervals as the periodic lubrications. The purpose of these services or inspections is to assure uninterrupted operation.

Before servicing, be sure to clean all lubrication fittings, caps, filler and level plugs and their surrounding surfaces to prevent dirt from entering with lubricants and coolants.

The intervals given in the schedule are based on normal operating conditions. For operation under abnormal or severe conditions, such as heavy dust or severe cold, perform these services, lubrications and inspections more often and as needed.

#### **NOTICE / AVISO**

**Batteries must be disconnected before welding on power unit to avoid possible damage to electrical components. Welding on power unit without disconnecting batteries will void the equipment warranty.**

### Maintenance Safety

If the equipment must be operated or activated during maintenance:

1. Make sure two people are present both of whom are instructed on safety issues.
2. One person should supervise the safety of the other person.
3. The supervisor should have immediate access to the Emergency Stop.

The work area shall be properly illuminated. A permanent communication between serviceman and operator shall be maintained.

### Caterpillar Maintenance

Perform all maintenance checks and lubrication indicated in the Caterpillar Operation & Maintenance Manual.



### Daily Maintenance - Power Unit

It is absolutely imperative that no dirt or other impurities be permitted to contaminate the hydraulic oil. Any contamination will drastically shorten the life of the high-pressure hydraulic system.

#### Before Engine Start-up Checklist:

1. Check the entire set-up prior to starting the power unit.
2. Check the oil level in the hydraulic reservoir and refill if necessary.

#### After Engine Start-up Checklist:

1. Check all hydraulic hoses for leaks.
2. Check that all hydraulic hoses hang freely with no kinks.
3. Check all pumps and hydraulic manifolds for leaks.
4. Check that EMERGENCY STOP works.
5. Check the RETURN FILTER GAUGE located on the control panel with the diesel engine running at full speed and after hydraulic oil has reached 100o F (38o C).

### Daily Maintenance - Vibrator

#### Before Start-up Checklist:

1. Check the entire set-up prior to starting the power unit.
2. Visibly inspect and check tightness of all bolts, nuts and screws including the bolts fastening the hydraulic clamp to the vibrator gear case.
3. Check wire ropes connecting vibrator to crane or piling rig.
4. Check the oil level in the vibrator gearbox and add oil if required. The oil level should be in the middle of the sight glass with the vibrator level. Change oil if milky or contaminated. Do not over fill.



Vibration loosens bolts, nuts and screws. Loose or broken bolts or screws may cause components to loosen and fall from the vibrator or clamp resulting in injury or death. Check carefully. Recheck clamp or caisson beam bolt torque.

### NOTICE / AVISO

Low or contaminated oil in the gearbox can result in damage to gears and bearings. Too much oil in the gear case can result in over-heating and damage to gears and bearings.



## Service Intervals

### Every 100 Hours

#### Vibratory/Driver Extractor

Drain and refill vibrator gear case with new lubricant.

### Every 500 Hours

#### Vibratory/Driver Extractor, Engine

An oil testing program is encouraged for the vibrator. Follow Caterpillar's recommendations for engine testing.

### Power Unit Annual Maintenance

At least once a year, have the hydraulic oil tested by a local hydraulic service center or oil company and replace if required.

### Severe Conditions

The service intervals and daily maintenance specified prior to this section are based on normal operating conditions. Operation under severe or unusual conditions will require some adjustments in service intervals.

Example: 100 hours changes to 50 hours, 500 hours changes to 250 hours, annual changes to 6 months.

#### Extreme Temperature

Above 80° F (27° C) or below -10° F (-23° C), reduce service intervals to half of those specified.

### Air Conditions

Operating in dust or sand, reduce service intervals to half of those specified.

Operating in salt or high moisture, have hydraulic oil tested quarterly and use normal service intervals.

#### Extended Work Hours

Operating in excess of twelve hours per day, reduce service intervals to half of those specified.

### Extended Inactive Periods

Consult Caterpillar Operation and Maintenance Manual. Also see Storage Procedure for Caterpillar Products (CAT Publication Number - SEHS9031-04).

Consult ANTAEUS for Vibrator.



## Lubrication

### Crankcase - Diesel Engine

Follow the engine manufacturer's maintenance schedule and the lubricating oil specifications outlined in the Caterpillar Operation & Maintenance Manual.

The lubricant shall meet the performance requirements of API Service Classification CH-4.

New engines are shipped with Caterpillar CH-4 (10W-30). The table below gives oil viscosity requirements for varying ambient temperature. Use only engine oil that conforms to the requirements in the Caterpillar Operation and Maintenance Manual.

Caterpillar makes no recommendation for after-market additives to engine oils.

<b>CAT DEO Multigrade EMA LRG-1 API CH-4 and API CF-4 Viscosity Grade</b>	<b>Ambient temperature Minimum</b>	<b>Ambient temperature Maximum</b>
SAE 0W20	-40°C (-40°F)	10°C (50°F)
SAE 0W30	-40°C (-40°F)	30°C (86°F)
SAE 0W40	-40°C (-40°F)	40°C (104°F)
SAE 5W30	-30°C (-22°F)	30°C (86°F)
SAE 5W40	-30°C (-22°F)	40°C (104°F)
SAE 10W30	-20°C (-40°F)	40°C (104°F)
SAE 15W40	-40°C (-40°F)	50°C (122°F)

**Caterpillar recommended Viscosities**

### NOTICE / AVISO

**Caterpillar® Tier 4/Stage III engines require low sulfur fuel and low ash lube oil. Failure to comply with requirements, could effect engine wear, fuel efficiency, and void the warranty.**

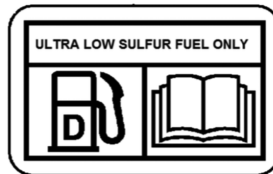



**Vibratory Gearbox Maintenance**

**Checking Oil Level:**

Check oil level in sight glass located on the lower center of the vibrator gearbox. Oil level should be in the middle of the sight glass.

**Adding Oil:**

On the vibrator gear case top plate, remove the 1" pipe plug to add oil.

**Draining Oil:**

Remove 3/4" pipe plug at either end of the gear case base plate. Tilt the case for complete drainage

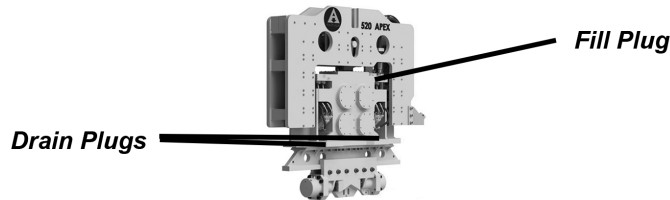

**Recommended Lubricating Oils for Vibrator & Multi-pump Drive Gear Case**

The recommended lubricating oil is SCHAEFFER 268, ISO 320.

It is our experience that Schaeffer 268 oil allows for longer intervals between oil changes and reduced maintenance time and cost. In addition, extensive tests have indicated that the use of SCHAEFFER 268, ISO 320 results in cooler operation and extended bearing life.

If Schaeffer 268, ISO 320 is not available, the following oils may be used. Check and change these oils at shorter intervals. Dipstick to check multi-pump drive mounted on engine

EXXON MOBIL	SHC-634
CHEVRON	Gear Comp. EP460
CITGO	Premium MP 85W-140
GULF	MP GL-5 SAE 85W-140
PHILLIPS	SMP 85W-140
SHELL	Omala 460





## Factory Installed Liquids

Engine oil	CAT CH-4 (10W-30)
Vibratory gear case	Schaeffer 268, ISO 320
Engine coolant	50% ethylene plus glycol 50% water

## Grease Clamp Plungers

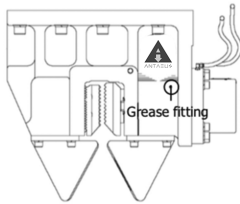

Grease the plunger in the with any good multi-purpose grease (2-3 pumps) at least once a day. If submerging the clamp in water or mud, frequently grease plunger to push out foreign matter. Dusty conditions also mandate frequent greasing.

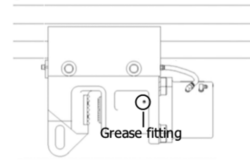

## Hydraulic System

To maintain the maximum operating efficiency in the precision parts of the hydraulic system, it is extremely important to eliminate factors that can cause breakdowns or unsatisfactory performance in the system.

Among the most common of these factors are rust, corrosion, contamination and products of oil deterioration.

Most problems can be minimized or avoided simply by maintaining a disciplined preventive maintenance program.



### Draining and Filling Hydraulic Oil Reservoir

Checking oil level: Make sure hydraulic oil is visible in the sight gauge on the reservoir.

Adding oil: Use the manual hand crank pump mounted on the lower reservoir.

Draining oil:

Drain by removing the plug on the bottom of the reservoir.

Changing Hydraulic Return Filter Element (spin-on filter housing is mounted on top of reservoir)

Removing return filter element

1. With the aid of a filter wrench, turn counterclockwise to remove spin on filters. Turn clockwise to spin on replacements.
2. Inspect for leaks when engine is running.

Note: Power Unit should not be operated if hydraulic oil is not visible in sight gauge.

### **NOTICE / AVISO**

**Inspect for leaks when engine is running.**

Aftermarket brands are widely available, including your local NAPA store.

### **NOTICE / AVISO**

**Foreign material in the hydraulic system can drastically affect the life and operation of hydraulic components.**

## Recommended Hydraulic Oil



ANTAEUS power units are shipped with CHEVRON Clarity™ AW46 hydraulic oil.

Mixing of different manufacturers' hydraulic oil is not recommended. However, it can be done only when the oils are miscible (contain the same base and additive). It is necessary to contact an oil supplier to determine if oils can be mixed. Do not add any other oil to CHEVRON Clarity AW46 hydraulic oil.

If an alternate oil is used, the following list contains recommendations that may be used to replace CHEVRON oil in the hydraulic system.

CHEVRON	CLARITY™ AW46
EXXON MOBIL	DTE 15M

**First Preference Group**

TEXACO	RANDO ASHLESS
CHEVRON	HYDRAULIC OIL AW ISO 32
EXXON	TERRASTIC EP 32
SHELL	Tellus PLUS 32

**Second Preference Group**

Whenever oils from the second preference group are used, it is necessary to test the oil more often to insure that viscosity remains within recommended limits while in service. The recommended oils in were chosen based on the hydraulic system operating temperature range being 0°F (-18°C) (cold ambient start-up) to 180°F (82°C) (maximum operating).

### Operating in Sub-freezing Conditions

Contact ANTAEUS for arctic or cold weather operating procedures. It may also be necessary in extremely cold or hot climates to use different viscosity oil which is better adapted to adverse conditions. Contact the nearest oil supply representative for suggested procedures.

### Setting Clamp Relief Valve

The Clamp Pressure Relief Valve is set at the factory. Contact ANTAEUS directly if clamp pressure is not working properly.



## Setting clamp relief valve directions:

To set clamp relief valve:

1. Clamp hoses do not have to be attached to set relief valve.
2. Start and warm up the diesel engine.
3. With the engine warmed up, increase engine speed to 1800 rpm.
4. While observing the CLAMP pressure on the CLAMP "OPEN" pressure gauge, turn the clamp (OPEN-CLOSE) switch to OPEN and hold.
5. The pressure should read 4800 psi (330 bar).
6. If the pressure does not read 4800 psi (30 bar):
  - a. Release the clamp (OPEN-CLOSE) switch.
  - b. While holding the clamp relief valve adjusting screw with a hex key, loosen the adjusting screw jam nut with an open-end wrench
  - c. Adjust the clamp relief valve by turning the adjusting screw approximately 1/8th turn in the desired direction. Turning the screw clockwise will increase the pressure setting. Turning counter-clockwise will decrease the pressure setting.
7. While observing the CLAMP "OPEN" pressure gauge, turn the clamp (OPEN-CLOSE) switch to OPEN and hold.
8. The pressure should read 5000 psi (345 bar).
9. If the pressure is not correct, repeat steps 6 through 8.

## Setting Clamp Restore Pressure

The Clamp Pressure Switch monitors clamp pressure when the clamp is closed. If clamp pressure drops below the standard setting of 4500 (310 bar), the pressure switch activates the clamp control valve to restore clamp pressure.

To set clamp pressure switch:

1. The Clamp Relief Valve must be set to 5000 psi (345 bar) prior to setting the Clamp Pressure Switch.
2. The Clamp Pressure Switch is located on the clamp manifold, which is located on the right behind the quick-disconnect couplers at the power unit.
3. Connect clamp hoses from clamp to the power unit. Make sure the quick disconnects are fully tightened.
4. Start engine and adjust to 1000 rpm.
5. Bleed clamp hoses before attempting to set the Pressure Switch.
6. With the power unit running and warmed up, turn clamp switch to CLOSE. It will take a few seconds for the clamp cylinder to move and begin building full pressure.
7. Observe the pressure reading on the Clamp "CLOSE" gauge. Adjust the adjusting screw of the pressure switch with a flat blade screw driver to 4500 (310 bar). Clockwise increases the pressure setting and counter-clockwise reduces the pressure setting.
8. It may be necessary to momentarily turn the Clamp switch to OPEN and release some of the pressure before bringing the pressure adjustment down. Make adjustments to the switch and then turn the Close Clamp switch to CLOSE again.
9. Once the pressure is adjusted, recheck your setting. Readjust if necessary.

**OILDYNE CLAMP PRESSURE SWITCH ADJUSTS CLOSE PRESSURE**  
**NOTE: MUST BE SET LOWER THAN CLAMP RELIEF**

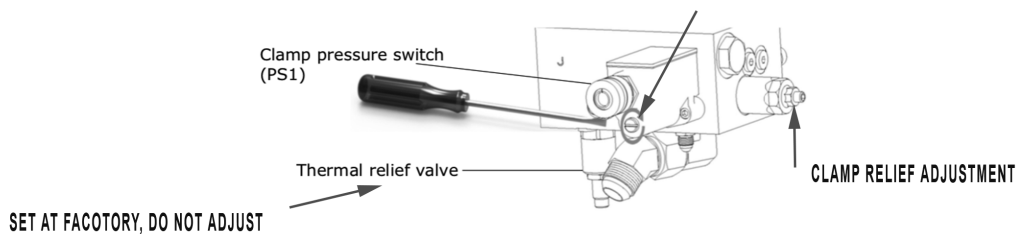



## Section 7: TORQUE SPECIFICATIONS

### NOTICE / AVISO

**Vibration from operation of equipment loosens bolts, nuts, and screws. Loose or broken fasteners may cause components to break away and fall resulting in injury, equipment damage or both. Check all fasteners daily.**

### NOTICE / AVISO

**Mismatched, dirty, damaged, or incorrect fasteners can result in damage, malfunction, or injury. Make sure fasteners are correct, clean, and undamaged. Check fasteners daily.**

### NOTICE / AVISO

**A torque wrench is necessary for assembly and maintenance of ANTAEUS equipment.**

Torque is measured in terms of force and distance. Force is the amount of pushing or pulling applied at the end of the lever. Distance is the length of the lever that is being used. Torque values are given in the following units: NEWTON meters (N-m), inch pounds (in-lb) and foot-pounds (ft-lb).

Be sure to use a torque wrench that has the proper range. Torque wrenches must be used properly in order to ensure that the correct torque is applied. Always use a smooth pull for torque wrenches. Do not jerk a torque wrench. Do not use adapters that change the length of the torque wrench. For the correct use of the torque wrench, refer to the instructions that were packaged with the torque wrench.

Prior to installation of any hardware, ensure that components are in near new condition. Bolts and threads must not be worn or damaged. Threads must not have burrs or nicks. Hardware must be free of rust and corrosion. Clean reused fasteners with a noncorrosive cleaner. Lightly lubricate the threads of reused fasteners. Lightly lubricate the mating surface of the head of reused fasteners.

Note: Too much tension on the bolt will cause the bolt to be stretched beyond the point of yield. The bolt will be permanently stretched. The bolt will loosen the grip on the parts that are being fastened. If the bolt is tightened again, the bolt will break. Do not reuse bolts that have been permanently stretched.

#### Torque Sequence

1. Hand tighten all fasteners. Larger connections may require the use of a small hand wrench.
2. Torque all fasteners to 40% of full torque.
3. Torque all fasteners to 70% of full torque
4. Torque all fasteners to full torque by using a cross pattern. Large flanges may require additional passes.
5. Apply at least one final full torque to all fasteners in a clockwise direction until all torque is uniform. Large connections may require additional passes.



**Section 7: TORQUE SPECIFICATIONS (continued)**

Torque values are for lubricated fasteners. Increase torque by 1/3 for dry fasteners.

UNC Screw Size	Allen Wrench Size	Standard Torque		UNF Screw Size	Allen Wrench Size	Standard Torque	
		Ft-lbs	N-m			Ft-lbs	N-m
1/4-20	3/16	10	14	1/4-28	3/16	12	16
5/16-18	1/4	22	30	5/16-24	1/4	24	32
3/8-16	5/16	38	52	3/8-24	5/16	43	58
7/16-14	3/8	61	83	7/16-20	3/8	68	92
1/2-13	3/8	93	126	1/2-20	3/8	105	142
5/8-11	1/2	179	243	5/8-18	1/2	202	274
3/4-10	5/8	317	430	3/4-16	5/8	354	480
7/8-9	3/4	511	693	7/8-14	3/4	564	765
1-8	3/4	767	1040	1-12	3/4	860	1166
1-1/4-7	7/8	1533	2078	1-1/4-12	7/8	1697	2301
1-1/2-6	1	2668	3617	1-1/2-12	1	3001	4069

**Torque for Socket Head Cap Screws**  
Source: Fastenal/Century

Thread Size	Standard Torque	
	N-m	Ft-lb
1/4	12 ± 3	9 ± 2
5/16	25 ± 6	18 ± 4
3/8	47 ± 9	35 ± 7
7/16	70 ± 15	50 ± 11
1/2	105 ± 20	75 ± 15
9/16	160 ± 30	120 ± 22
5/8	215 ± 40	160 ± 30
3/4	370 ± 50	275 ± 37
7/8	620 ± 80	460 ± 60
1	900 ± 100	660 ± 75
1 1/8	1300 ± 150	960 ± 110
1 1/4	1800 ± 200	1320 ± 150
1 3/8	2400 ± 300	1780 ± 220
1 1/2	3100 ± 350	2280 ± 260

**Torque for Grade 8 UNC Bolts & Nuts**  
Source: CAT SENR3130

Thread Size	Standard Torque	
	N-m	Ft-lb
M6	12 ± 3	9±2
M8	28 ± 7	21 ± 5
M10	55 ± 10	41 ± 7
M12	100 ± 20	75 ± 15
M14	160 ± 30	120 ± 22
M16	240 ± 40	1 75 ± 30
M20	460 ± 60	340 ± 44
M24	800 ± 100	590 ± 75
M30	1600 ± 200	1180 ± 150
M36	2800 ± 350	2100 ± 260

**Torque for Metric (ISO) Bolts & Nuts**  
Source: CAT SENR3130



## Electrical System

### Electrical Components and Operation

Components indicated in CAPITAL LETTERS below are shown on the Electrical Components Diagram and the Electrical Schematics.

### Optional Control

Duplicate vibrator and clamp switches are located on the CONTROL PENDANT and on the CONTROL PANEL. Turning the LOCAL-PENDANT switch on the control panel to PENDANT permits operation of the clamp and vibrator from the PENDANT. Turning the LOCAL-PENDANT switch to LOCAL on the control panel permits operation of the clamp and vibrator from the CONTROL PANEL.

The information below assumes operation from the PENDANT.

### Control Panel Display

The control panel DISPLAY shows engine speed, coolant temperature, charging voltage, oil pressure and fuel pressure. Engine fault codes are shown on the DISPLAY. These codes go out if the condition is corrected.

A SERVICE ENGINE light comes on after 2500 gallons of fuel is used indicating engine service (250 hour CAT service) is required.

### Control System and Engine Power

Turning the ENGINE RUN switch to START energizes the MAINPOWER RELAY which sends power to the control system and the ENGINE CONTROL MODULE (ECM).

### Engine Monitoring

The ENGINE CONTROL MODULE (ECM) monitors the engine for any of the following conditions:

1. Low oil pressure
2. High fuel temperature
3. High coolant temperature
4. Engine over speed

If any of these conditions occurs, a fault code is shown on the DISPLAY(D) on the control panel and a signal is sent to the ENGINE CONTROL MODULE (ECM) to shut down the engine. The fault code goes away if the condition is corrected.

After the condition is corrected, turn the ENGINE RUN (OFF-RUN-START) switch off and on to reset ECM. Follow normal engine start procedure.

Control Panel Assembly

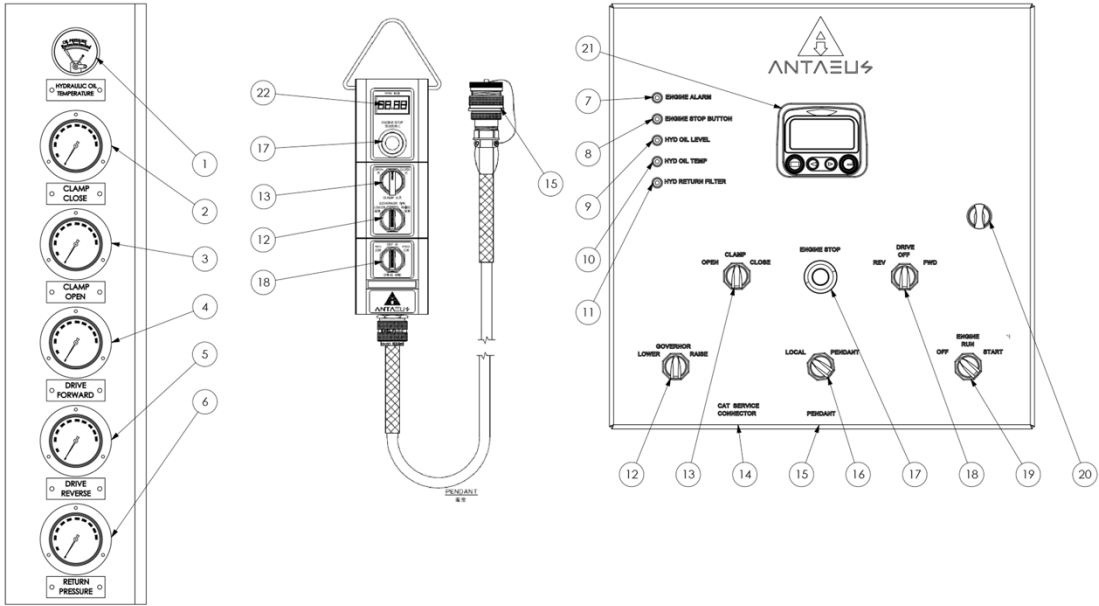



# Electrical System

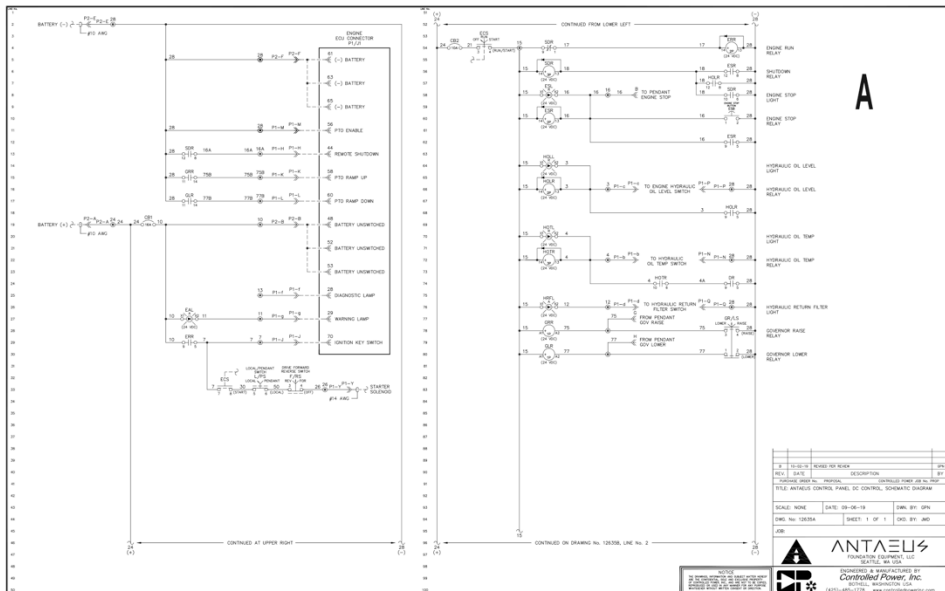
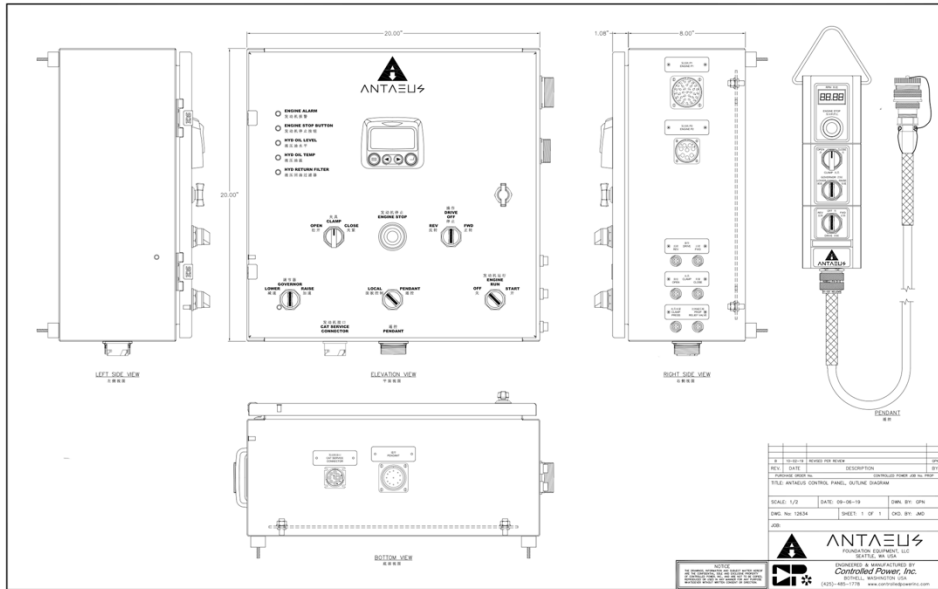

# Electrical System

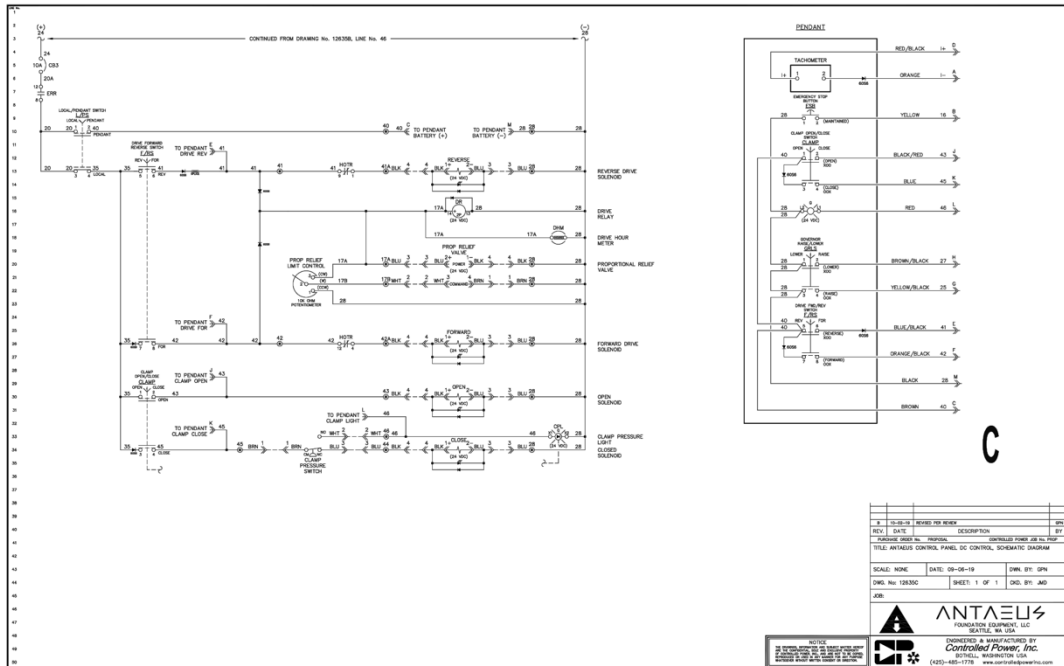
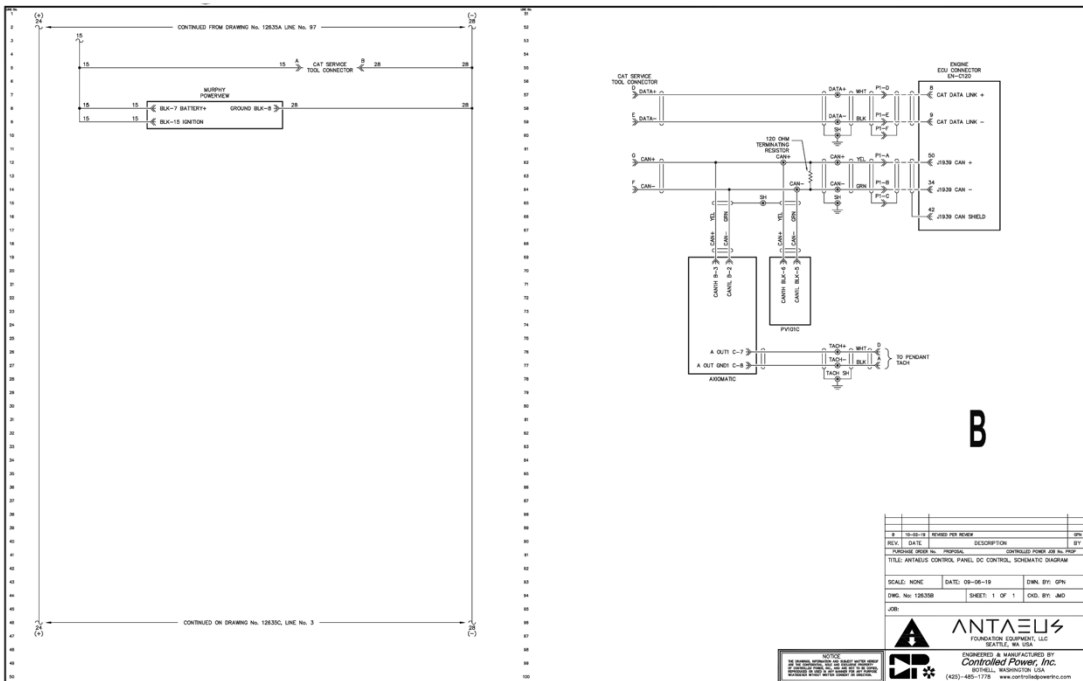

# Electrical System Internal

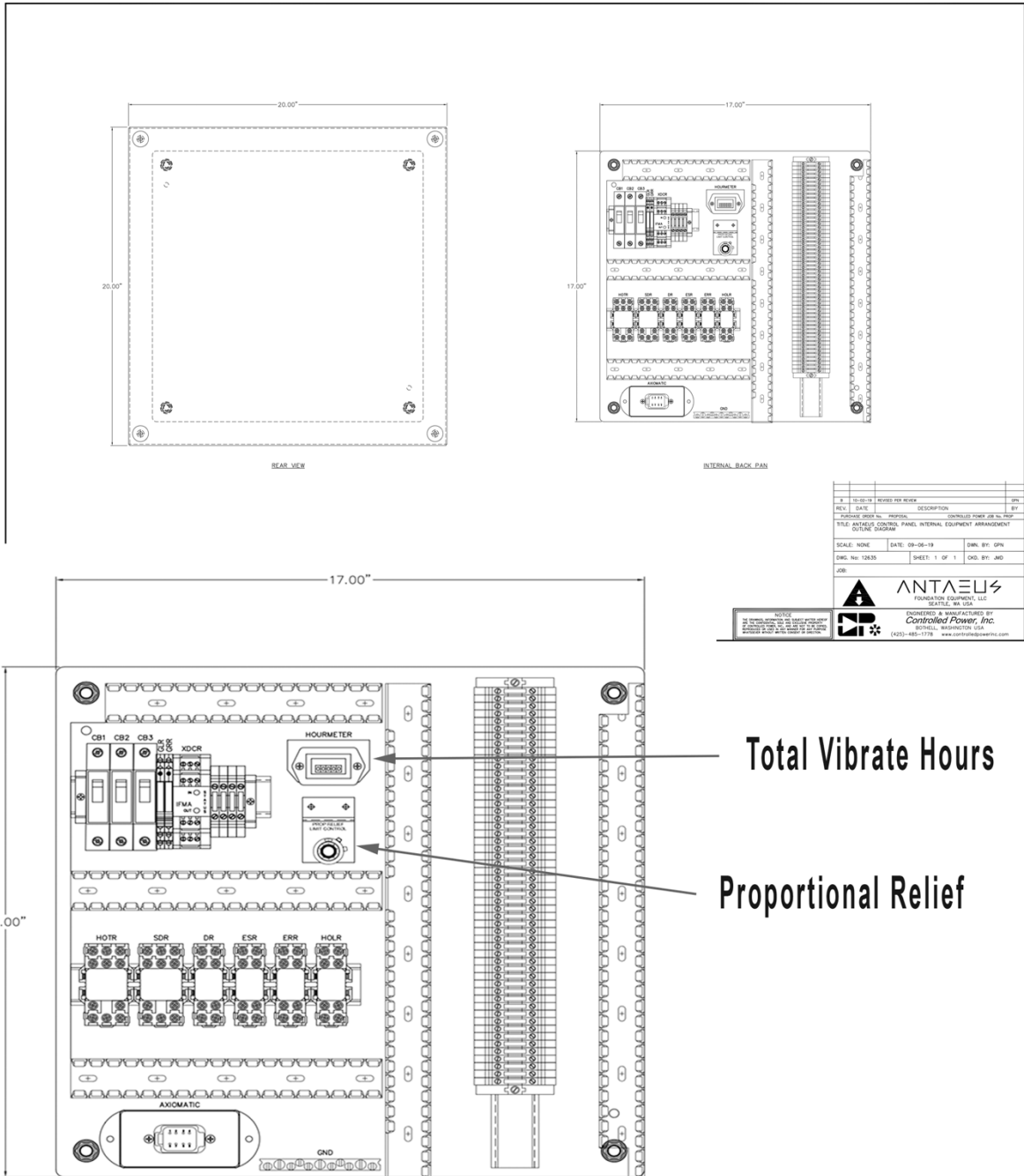

Total Vibrate Hours

Proportional Relief

REV.	DATE	DESCRIPTION	BY
1	09-26-19	ISSUED FOR NOISE	CPN
2	09-26-19	REVISED FOR NOISE	CPN
3	09-26-19	REVISED FOR NOISE	CPN
4	09-26-19	REVISED FOR NOISE	CPN
5	09-26-19	REVISED FOR NOISE	CPN
6	09-26-19	REVISED FOR NOISE	CPN
7	09-26-19	REVISED FOR NOISE	CPN
8	09-26-19	REVISED FOR NOISE	CPN
9	09-26-19	REVISED FOR NOISE	CPN
10	09-26-19	REVISED FOR NOISE	CPN
11	09-26-19	REVISED FOR NOISE	CPN
12	09-26-19	REVISED FOR NOISE	CPN
13	09-26-19	REVISED FOR NOISE	CPN
14	09-26-19	REVISED FOR NOISE	CPN
15	09-26-19	REVISED FOR NOISE	CPN
16	09-26-19	REVISED FOR NOISE	CPN
17	09-26-19	REVISED FOR NOISE	CPN
18	09-26-19	REVISED FOR NOISE	CPN
19	09-26-19	REVISED FOR NOISE	CPN
20	09-26-19	REVISED FOR NOISE	CPN
21	09-26-19	REVISED FOR NOISE	CPN
22	09-26-19	REVISED FOR NOISE	CPN
23	09-26-19	REVISED FOR NOISE	CPN
24	09-26-19	REVISED FOR NOISE	CPN
25	09-26-19	REVISED FOR NOISE	CPN
26	09-26-19	REVISED FOR NOISE	CPN
27	09-26-19	REVISED FOR NOISE	CPN
28	09-26-19	REVISED FOR NOISE	CPN
29	09-26-19	REVISED FOR NOISE	CPN
30	09-26-19	REVISED FOR NOISE	CPN
31	09-26-19	REVISED FOR NOISE	CPN
32	09-26-19	REVISED FOR NOISE	CPN
33	09-26-19	REVISED FOR NOISE	CPN
34	09-26-19	REVISED FOR NOISE	CPN
35	09-26-19	REVISED FOR NOISE	CPN
36	09-26-19	REVISED FOR NOISE	CPN
37	09-26-19	REVISED FOR NOISE	CPN
38	09-26-19	REVISED FOR NOISE	CPN
39	09-26-19	REVISED FOR NOISE	CPN
40	09-26-19	REVISED FOR NOISE	CPN
41	09-26-19	REVISED FOR NOISE	CPN
42	09-26-19	REVISED FOR NOISE	CPN
43	09-26-19	REVISED FOR NOISE	CPN
44	09-26-19	REVISED FOR NOISE	CPN
45	09-26-19	REVISED FOR NOISE	CPN
46	09-26-19	REVISED FOR NOISE	CPN
47	09-26-19	REVISED FOR NOISE	CPN
48	09-26-19	REVISED FOR NOISE	CPN
49	09-26-19	REVISED FOR NOISE	CPN
50	09-26-19	REVISED FOR NOISE	CPN
51	09-26-19	REVISED FOR NOISE	CPN
52	09-26-19	REVISED FOR NOISE	CPN
53	09-26-19	REVISED FOR NOISE	CPN
54	09-26-19	REVISED FOR NOISE	CPN
55	09-26-19	REVISED FOR NOISE	CPN
56	09-26-19	REVISED FOR NOISE	CPN
57	09-26-19	REVISED FOR NOISE	CPN
58	09-26-19	REVISED FOR NOISE	CPN
59	09-26-19	REVISED FOR NOISE	CPN
60	09-26-19	REVISED FOR NOISE	CPN
61	09-26-19	REVISED FOR NOISE	CPN
62	09-26-19	REVISED FOR NOISE	CPN
63	09-26-19	REVISED FOR NOISE	CPN
64	09-26-19	REVISED FOR NOISE	CPN
65	09-26-19	REVISED FOR NOISE	CPN
66	09-26-19	REVISED FOR NOISE	CPN
67	09-26-19	REVISED FOR NOISE	CPN
68	09-26-19	REVISED FOR NOISE	CPN
69	09-26-19	REVISED FOR NOISE	CPN
70	09-26-19	REVISED FOR NOISE	CPN
71	09-26-19	REVISED FOR NOISE	CPN
72	09-26-19	REVISED FOR NOISE	CPN
73	09-26-19	REVISED FOR NOISE	CPN
74	09-26-19	REVISED FOR NOISE	CPN
75	09-26-19	REVISED FOR NOISE	CPN
76	09-26-19	REVISED FOR NOISE	CPN
77	09-26-19	REVISED FOR NOISE	CPN
78	09-26-19	REVISED FOR NOISE	CPN
79	09-26-19	REVISED FOR NOISE	CPN
80	09-26-19	REVISED FOR NOISE	CPN
81	09-26-19	REVISED FOR NOISE	CPN
82	09-26-19	REVISED FOR NOISE	CPN
83	09-26-19	REVISED FOR NOISE	CPN
84	09-26-19	REVISED FOR NOISE	CPN
85	09-26-19	REVISED FOR NOISE	CPN
86	09-26-19	REVISED FOR NOISE	CPN
87	09-26-19	REVISED FOR NOISE	CPN
88	09-26-19	REVISED FOR NOISE	CPN
89	09-26-19	REVISED FOR NOISE	CPN
90	09-26-19	REVISED FOR NOISE	CPN
91	09-26-19	REVISED FOR NOISE	CPN
92	09-26-19	REVISED FOR NOISE	CPN
93	09-26-19	REVISED FOR NOISE	CPN
94	09-26-19	REVISED FOR NOISE	CPN
95	09-26-19	REVISED FOR NOISE	CPN
96	09-26-19	REVISED FOR NOISE	CPN
97	09-26-19	REVISED FOR NOISE	CPN
98	09-26-19	REVISED FOR NOISE	CPN
99	09-26-19	REVISED FOR NOISE	CPN
100	09-26-19	REVISED FOR NOISE	CPN

**ANTAELUS**  
 TRANSDUCER EQUIPMENT, LLC  
 SEATTLE, WA USA  
 ENGINEERED & MANUFACTURED BY  
**Controlled Power, Inc.**  
 80700th, WA 98148, USA  
 (425) 485-1778 www.controlledpowerllc.com



Hydraulic Schematic

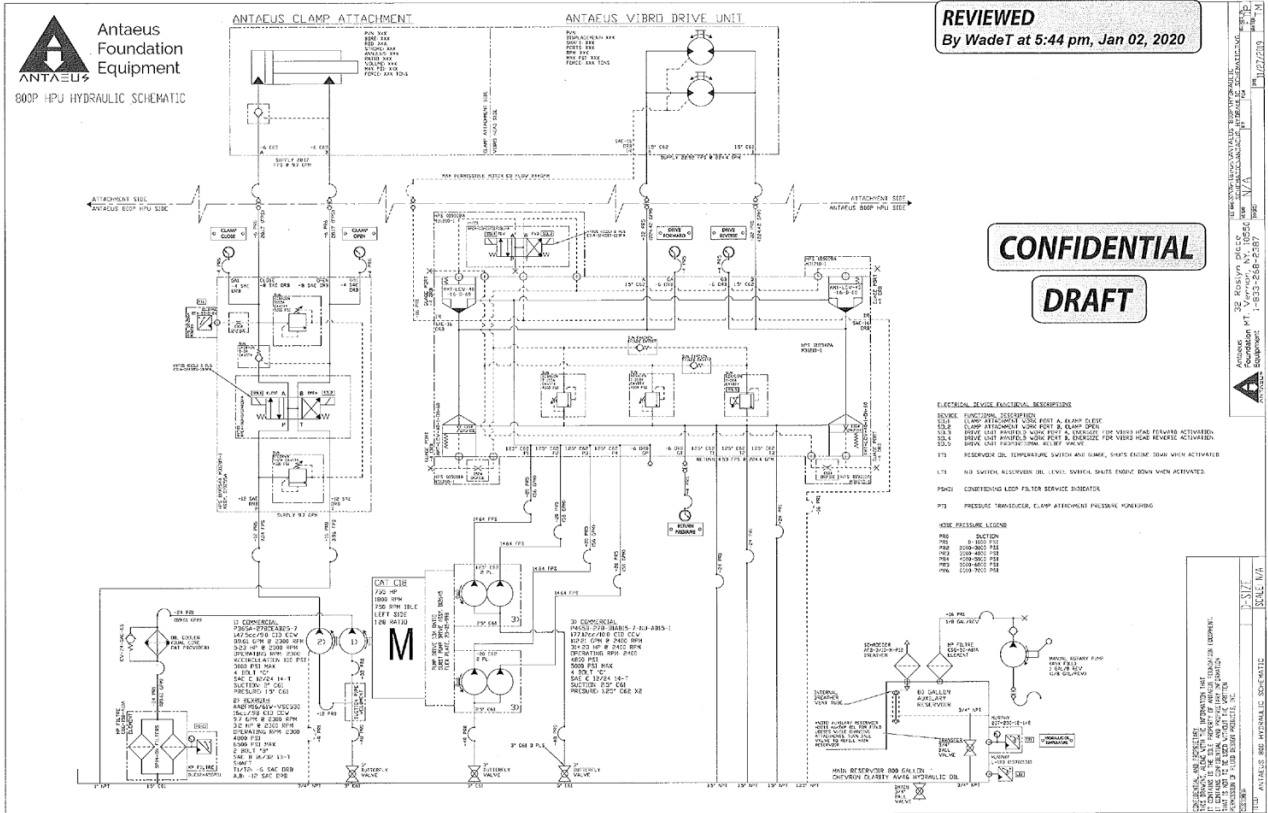

**REVIEWED**  
By Wade T at 5:44 pm, Jan 02, 2020

**CONFIDENTIAL**  
**DRAFT**

- ELECTRICAL DEVICE FUNCTIONAL DESCRIPTIONS**
- PS1 CLAMP PRESSURE SWITCH (PS1) - A CLAMP PRESSURE SWITCH THAT MONITORS CLAMP PRESSURE AND TRIPPS THE CLAMP CONTROL VALVE TO RESTORE PRESSURE IF CLAMP PRESSURE FALLS BELOW 4500 PSI (290 BAR).
  - PS2 CLAMP PRESSURE SWITCH (PS2) - A CLAMP PRESSURE SWITCH THAT MONITORS CLAMP PRESSURE AND TRIPPS THE CLAMP CONTROL VALVE TO RESTORE PRESSURE IF CLAMP PRESSURE FALLS BELOW 4500 PSI (290 BAR).
  - PS3 CLAMP PRESSURE SWITCH (PS3) - A CLAMP PRESSURE SWITCH THAT MONITORS CLAMP PRESSURE AND TRIPPS THE CLAMP CONTROL VALVE TO RESTORE PRESSURE IF CLAMP PRESSURE FALLS BELOW 4500 PSI (290 BAR).
  - PS4 CLAMP PRESSURE SWITCH (PS4) - A CLAMP PRESSURE SWITCH THAT MONITORS CLAMP PRESSURE AND TRIPPS THE CLAMP CONTROL VALVE TO RESTORE PRESSURE IF CLAMP PRESSURE FALLS BELOW 4500 PSI (290 BAR).
  - PS5 CLAMP PRESSURE SWITCH (PS5) - A CLAMP PRESSURE SWITCH THAT MONITORS CLAMP PRESSURE AND TRIPPS THE CLAMP CONTROL VALVE TO RESTORE PRESSURE IF CLAMP PRESSURE FALLS BELOW 4500 PSI (290 BAR).
  - PS6 CLAMP PRESSURE SWITCH (PS6) - A CLAMP PRESSURE SWITCH THAT MONITORS CLAMP PRESSURE AND TRIPPS THE CLAMP CONTROL VALVE TO RESTORE PRESSURE IF CLAMP PRESSURE FALLS BELOW 4500 PSI (290 BAR).
  - PS7 CLAMP PRESSURE SWITCH (PS7) - A CLAMP PRESSURE SWITCH THAT MONITORS CLAMP PRESSURE AND TRIPPS THE CLAMP CONTROL VALVE TO RESTORE PRESSURE IF CLAMP PRESSURE FALLS BELOW 4500 PSI (290 BAR).
  - PS8 CLAMP PRESSURE SWITCH (PS8) - A CLAMP PRESSURE SWITCH THAT MONITORS CLAMP PRESSURE AND TRIPPS THE CLAMP CONTROL VALVE TO RESTORE PRESSURE IF CLAMP PRESSURE FALLS BELOW 4500 PSI (290 BAR).
  - PS9 CLAMP PRESSURE SWITCH (PS9) - A CLAMP PRESSURE SWITCH THAT MONITORS CLAMP PRESSURE AND TRIPPS THE CLAMP CONTROL VALVE TO RESTORE PRESSURE IF CLAMP PRESSURE FALLS BELOW 4500 PSI (290 BAR).
  - PS10 CLAMP PRESSURE SWITCH (PS10) - A CLAMP PRESSURE SWITCH THAT MONITORS CLAMP PRESSURE AND TRIPPS THE CLAMP CONTROL VALVE TO RESTORE PRESSURE IF CLAMP PRESSURE FALLS BELOW 4500 PSI (290 BAR).
  - PS11 CLAMP PRESSURE SWITCH (PS11) - A CLAMP PRESSURE SWITCH THAT MONITORS CLAMP PRESSURE AND TRIPPS THE CLAMP CONTROL VALVE TO RESTORE PRESSURE IF CLAMP PRESSURE FALLS BELOW 4500 PSI (290 BAR).
  - PS12 CLAMP PRESSURE SWITCH (PS12) - A CLAMP PRESSURE SWITCH THAT MONITORS CLAMP PRESSURE AND TRIPPS THE CLAMP CONTROL VALVE TO RESTORE PRESSURE IF CLAMP PRESSURE FALLS BELOW 4500 PSI (290 BAR).
  - PS13 CLAMP PRESSURE SWITCH (PS13) - A CLAMP PRESSURE SWITCH THAT MONITORS CLAMP PRESSURE AND TRIPPS THE CLAMP CONTROL VALVE TO RESTORE PRESSURE IF CLAMP PRESSURE FALLS BELOW 4500 PSI (290 BAR).
  - PS14 CLAMP PRESSURE SWITCH (PS14) - A CLAMP PRESSURE SWITCH THAT MONITORS CLAMP PRESSURE AND TRIPPS THE CLAMP CONTROL VALVE TO RESTORE PRESSURE IF CLAMP PRESSURE FALLS BELOW 4500 PSI (290 BAR).
  - PS15 CLAMP PRESSURE SWITCH (PS15) - A CLAMP PRESSURE SWITCH THAT MONITORS CLAMP PRESSURE AND TRIPPS THE CLAMP CONTROL VALVE TO RESTORE PRESSURE IF CLAMP PRESSURE FALLS BELOW 4500 PSI (290 BAR).
  - PS16 CLAMP PRESSURE SWITCH (PS16) - A CLAMP PRESSURE SWITCH THAT MONITORS CLAMP PRESSURE AND TRIPPS THE CLAMP CONTROL VALVE TO RESTORE PRESSURE IF CLAMP PRESSURE FALLS BELOW 4500 PSI (290 BAR).
  - PS17 CLAMP PRESSURE SWITCH (PS17) - A CLAMP PRESSURE SWITCH THAT MONITORS CLAMP PRESSURE AND TRIPPS THE CLAMP CONTROL VALVE TO RESTORE PRESSURE IF CLAMP PRESSURE FALLS BELOW 4500 PSI (290 BAR).
  - PS18 CLAMP PRESSURE SWITCH (PS18) - A CLAMP PRESSURE SWITCH THAT MONITORS CLAMP PRESSURE AND TRIPPS THE CLAMP CONTROL VALVE TO RESTORE PRESSURE IF CLAMP PRESSURE FALLS BELOW 4500 PSI (290 BAR).
  - PS19 CLAMP PRESSURE SWITCH (PS19) - A CLAMP PRESSURE SWITCH THAT MONITORS CLAMP PRESSURE AND TRIPPS THE CLAMP CONTROL VALVE TO RESTORE PRESSURE IF CLAMP PRESSURE FALLS BELOW 4500 PSI (290 BAR).
  - PS20 CLAMP PRESSURE SWITCH (PS20) - A CLAMP PRESSURE SWITCH THAT MONITORS CLAMP PRESSURE AND TRIPPS THE CLAMP CONTROL VALVE TO RESTORE PRESSURE IF CLAMP PRESSURE FALLS BELOW 4500 PSI (290 BAR).

Hydraulic Clamp

With the DIESEL ENGINE running, hydraulic oil is taken from the RESERVOIR by the CLAMP PUMP. The clamp pump flow returns to the RESERVOIR if the clamp switch on the pendant is in the center position.

Turning the clamp switch on the control pendant to CLOSE activates the CLAMP CONTROL VALVE. Hydraulic oil is directed to the close-clamp side of the hydraulic CYLINDER on the clamp. The clamp closes.

Clamping pressure is displayed by the CLAMP CLOSED gauge next to the control panel. OPEN CLAMP and CLOSE CLAMP each have their own gauge. When clamping pressure reaches approximately 4500 psi (290 bar), the CLAMP PRESSURE SWITCH (PS1) centers the CLAMP CONTROL VALVE, which directs the flow from the CLAMP PUMP to the RESERVOIR. Pressure at the clamp is maintained by the CLAMP CHECK VALVE. If clamping pressure falls below 4500 psi (290 bar), the CLAMP PRESSURE SWITCH activates the CLAMP CONTROL VALVE to restore pressure. In the event of hose failure, the CLAMP HOLDING VALVE located in the clamp cylinder will hold the clamp cylinder closed. **WARNING, IF ENGINE SHUTS OFF CLAMP WILL LOSE PRESSURE OVER TIME. NEVER TRUST A CLAMP TO STAY CLOSED.**

Turning the clamp switch on the control pendant to OPEN activates the CLAMP CONTROL VALVE.

Hydraulic oil is directed to the open-clamp side of the hydraulic CYLINDER. The pressure in the open-clamp line opens the CLAMP CHECK VALVES. The clamp opens. Pressure in the clamping circuit is limited to 5000 psi (345 bar) by the CLAMP RELIEF VALVE. A TEMPERATURE RELIEF VALVE limits pressure in the close-clamp circuit caused by high ambient temperatures to 5800 psi (400 bar).

The quick disconnect couplers permit de-coupling of the clamp hoses at the power unit.

The clamp circuit on all ANTAEUS power units can be configured to operate auxiliary equipment, such as spotters, pile gates, etc. Contact ANTAEUS for instructions.



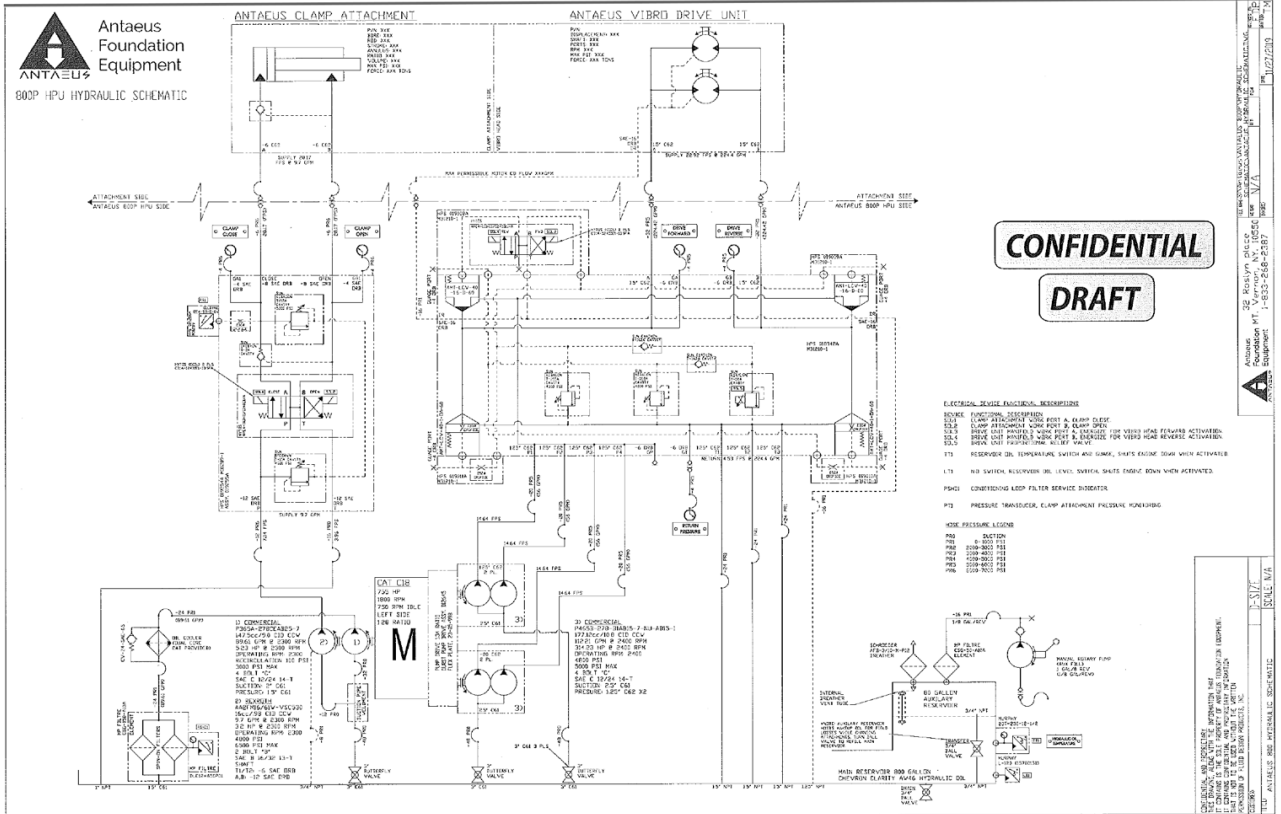

Hydraulic Cooling Circuit- KIDNEY LOOP

To avoid any hydraulic spikes in the main drive circuit that could cause damage to the heat exchanger, all cooling of hydraulic oil is on its own circuit. This circuit also filters the hydraulic oil in the reservoir. The "kidney Loop" pump is located on the front of the engine (Clamp pump is piggy backed on same). The cooling pump takes oil from the Reservoir, pumps it through the heat exchanger and then through the spin on hydraulic filters before returning to the reservoir.