

SINCE 2007

(Software Training & Placement Services)



140⁺
COMPANIES



175⁺
PLACED STUDENTS



• MECH. CAD • CIVIL CAD • BIM CAD • ELEC. CAD • ACCOUNTING • GRAPHICS • DIGITAL MARKETING

IN FOR TRAINING , DEVELOP SKILLS & LEAVE WITH JOB



**WELCOME TO
BIM CAD SOFTWARE
TRAINING & PLACEMENTS**

140⁺



175⁺



COMPANIES

PLACED STUDENTS

Managing Director

Varada Uday Bhaskar

ME Mechanical Engg. OU University

16+ Years of Exp

Ex-Employee of (Majorly worked with)

Cyient, Tech Mahindra, Quest Global & Caterpillar -Rail



Click our website for Software Course Programs

<https://caddeskbangalore-bommanhalli.com/>



Click our website for Placed students & Partners

<https://cadenggr.com/placement-services>



Uday Bhaskar Varada
ME Mechanical Engg. CAD/CAM (Osaka University)
16+ Years of Exp. Majorly Worked with
Cyient, Tech Mahindra, Quest Global & Caterpillar -Rail
Founder & Managing Head
Training & Placement





140⁺
COMPANIES



175⁺
PLACED STUDENTS



• MECH. CAD • CIVIL CAD • BIM CAD • ELEC. CAD • ACCOUNTING • GRAPHICS • DIGITAL MARKETING

Sincere thanks to all the respective Parents, Dedicated Faculty & Team Members. Appreciate Students Joining our centre from various places (Many districts of Karnataka, AP, Tamilnadu, Kerala, Westbengal, Bihar, Orissa, Arunachal Pradesh and other locations with the trust you have in our TRAINING & PLACEMENT process

Special thanks to the 140+ registered Organizations for recruiting our CAD/IT students from various domains and maintaing healthy longterm relationship



PRIDE MOMENT
ACHIEVED ANOTHER MILESTONE
520+ Organizations - Final Interviews
140+ Registered Companies
175+ Placed Students

140⁺ COMPANIES

175⁺ PLACED STUDENTS

Placement Partner

BHASKARS ENGINEERING DESIGN & IT CENTER

<https://cadenggr.com/placement-services>

+91 - 80500 91122 80500 41122



(Software Training & Placement Services)

140⁺
COMPANIES



175⁺
PLACED STUDENTS



• MECH. CAD • CIVIL CAD • BIM CAD • ELEC. CAD • ACCOUNTING • GRAPHICS • DIGITAL MARKETING

CONTENT

Page 4	About us & the softwares we teach
Page 5	Maste Diploma in BIM CAD Courses
Page 6 & 7	Content of the BIM CAD Courses
Page 8	Our Powerful Placement Strategy
Page 9 to 14	Sample modeling projects of our CAD Students
Page 15 & 16	Additional Important things for Interview and Career
Page 17	Course Fees & Structure (5 course, 6 Course & 7 Courses)
Page 18 & 19	Overview of our Placement Parnters
Page 20 to 22	Our Placed Students
Page 23	Glimpse of our Placement Thumb Sign rule
Page 24 & 25	Glimpse of our Skill Training Sessions
Page 26	Guest Visit to our center (Directors / CEO / VP /etc)
Page 27	Glimpse of our Social Service Events
Page 28 & 29	Awards, Events & Celebrations
Page 30	Best Training Quality Award
Page 31	Placement Category Course Programs
Page 32	Sample Certification
Page 33	Join & Refer for a bright career
Page 34	Important Question & Answers for Career
Page 35	Job Selection Criteria in Organizations
Page 36	Time for Registration and Contact



140 #

COMPANIES



175 #

PLACED STUDENTS

GUARANTEE

PLACEMENT



• MECH. CAD • CIVIL CAD • BIM CAD • ELEC. CAD • ACCOUNTING • GRAPHICS • DIGITAL MARKETING

We **Bhaskars Engineering Design & IT Center** in collaboration with **software Training Partner CADDESK/ITDesk** which is one the leading software training Institute in India - located in **Bommanhalli & Madiwala** Bangalore are providing Software Training & Job Placement.

We teach wide variety of Software's for Engineering & Degree Students **CIVIL/ARCH./INTERIOR/MECH./PRODUCTION/AUTOMOBILE/ELECTRICAL/PUC/DEGREE (B.com/BBA/BA/BSC/BCA/others)/ PG/MASTERS**

We aim to strengthen the students in the society, to help them reach their goals by providing **Skill Development**- Software Skills + Communication Skills + Domain Skills & Guaranteed Placement which long-last for their Career.



CIVIL ENGINEERING
SOFTWARES

- Auto CAD
- 3DS Max
- REVIT Structure
- REVIT Architecture
- REVIT MEP
- STAAD Pro
- Etabs
- V-Ray
- Google Sketch up
- Enscape
- Quantity Take off
- and others.

MECH.ENGINEERING
SOFTWARES

- Auto CAD
- SolidWorks
- Catia
- NX Cad
- Nx Cam
- CREO
- Ansys WB
- REVIT MEP
- INVENTOR
- GD & T
- and others.

ELECTRICAL ENGG.
SOFTWARES

- Auto CAD
- PLC/Scada
- Matlab
- Primavera
- And others.

IT ENGINEERING
SOFTWARES

- MS Office
- Photoshop
- Corel Draw
- C language
- C++
- Core Java
- Advance Java
- Python
- Tally
- PHP
- .Net
- AWS
- SAP FICO/MM
- HTML
- JQuery
- My SQL &
- Digital Marketing

Placement Partner

BHASKARS ENGINEERING DESIGN & IT CENTER

<https://cadenggr.com/placement-services>

+91 - 80500 91122 80500 41122



140
 COMPANIES



175
 PLACED STUDENTS



• MECH. CAD • CIVIL CAD • BIM CAD • ELEC. CAD • ACCOUNTING • GRAPHICS • DIGITAL MARKETING

MASTER DIPLOMA IN BIM CAD COURSES

AutoCAD 2d/3d: AutoCAD, allows for both 2D and 3D Civil-Arch.-Interior design and drafting. 2D drafting in AutoCAD offers precise control over lines, shapes, dimensions, and annotation.



AutoCAD 3D enables users to create detailed 3D models, analyze data, and visualize designs in a digital environment.

Sketch Up: SketchUp, a 3D modeling software, is widely used for architectural, interior design, engineering, 3D printing, and more. Its ease of use and versatility make it a popular choice for various applications. SketchUp users may upload and download 3D models from 3D Warehouse.



V-Ray: V-Ray is a powerful rendering plugin for SketchUp, crafted to help designers, architects, and creators transform their SketchUp models into lifelike visuals. From initial sketches to photorealistic renders, V-Ray supports you at every stage of the design process, enabling you to communicate your vision with clarity and impact.



Revit Arch: Revit Architecture is a software that helps architects and other professionals design, document, and manage building projects. It's known for its 3D modeling capabilities, parametric design, and collaborative features.



Revit is also used effectively in coordinating design with structural & MEP discipline. Revit's parametric approach, ensure consistency & accuracy.

Revit MEP: Revit MEP is a specialized version of the Autodesk Revit software, focused on modeling Mechanical, Electrical, and Plumbing (MEP) systems within a building information modeling (BIM) environment. It allows users to create



3D models of MEP systems including ductwork, piping, electrical conduits, and equipment. coordinate them with other architectural & structural models.

Revit Structure: Revit Structure is a software application specifically designed for structural engineering and design within the Revit Building Information Modeling (BIM) platform.



It allows users to create 3D structural models, generate documentation, and manage project information.



140
 COMPANIES



175
 PLACED STUDENTS



• MECH. CAD • CIVIL CAD • BIM CAD • ELEC. CAD • ACCOUNTING • GRAPHICS • DIGITAL MARKETING

CONTENT (AutoCAD, Sketch Up & V-Ray).

AutoCAD 2d/3d:

- AutoCAD Commands, Use of mouse and keyboard, File extensions, Limits (Li), Units (UN), selection, Views.
- 2d drafting: Drawing toolbar, Point (Po), Co-ordinate system, Line (L), Construction Line (XL), Polyline (PL), Ray, Point style.
- Circle (C), Ellipse (EL), Arc (A), Polygon (POL), Rectangle (Rec)
- Spline (SPL), Divide (Div), Measure (Mea), Donut (Do), Hatch (H), etc.
- Drafting Setting Tool bar constraint, Snap Grid, Ortho, Polar, Object Snap, Object Track, Dyn. UCS, Dynamic Input, Line weight, Quick property
- Modifying tool bar
- Editing tool bar
- Annotations
- Styles manager
- Layer
- Properties
- Tool Palettes
- Parametric constraints
- Linking & Extraction
- Plotting
- 3d Modeling tools
- Solid editing tools

SKETCH UP

- Student will be starting from the Interface of Sketch up - Zoom, Pan and rotate.
- Understanding the XYZ axis
- Selecting toolbars
- Applying templates
- Drawing and using the pencil tool
- Drawing basic geometric shapes
- Drawing with measurements
- Discovering layers
- Sticky Geometry benefits
- Measuring items inside Sketch Up
- Information and database
- Moving and move/copy
- Simple Array techniques
- Rotating objects
- Scale fractional and relative
- Making components & groups
- Re-loading components
- Creating a digital warehouse
- Modeling techniques
- Using Push Pull
- Intersecting Geometry
- Copy and Offset faces, edges and polygons in 2d
- Materials Editor, texture

V-RAY

- Generate basic materials glass, thin glass, solid glass, frosted glass 2. metal 3. gold 4. plastic & 5. Others
- Texture, materials
- Project 1 exterior view with V-Ray sun light
- Project 2 exterior view with V-Ray sun light & Render setting
- Project 2 exterior night view with V-Ray sun light & free light.
- Complete night scene
- Interior light Introduce
- Interior light, V-Ray light & Work on materials.
- Complete Interior light with V-Ray light, V-Ray Sun, V-Ray IES light
- Complete render setting
- Day scene, night scene both views
- Post production work on Exterior view
- Post production work on Interior view
- Solution & Project Submission



140
COMPANIES



175
PLACED STUDENTS



• MECH. CAD • CIVIL CAD • BIM CAD • ELEC. CAD • ACCOUNTING • GRAPHICS • DIGITAL MARKETING

CONTENT (Revit Arch., Revit MEP & Revit Structure)

REVIT ARCH.

- Starting of project template
- Tool palettes
- Project units & Dimensions
- Levels, Create grids & Edit
- Wall shapes, draw panel, Wall joins, Working with grids, Drawing plans
- Modifying commands, move, copy, paste, similar rotate, array, scale, trim / extend
- Doors, Windows, Component, managing views, Annotation command
- Model Text, model line
- Floor, Editing material in floor
- Floor properties & Roofs
- Roof by soffit, fascia, gutter
- Editing material in roof. Join/unjoin roofs
- Openings, multiple floor shaft
- Ceiling, Lighting, External & Internal
- Curtain walls
- Stairs, Ramp, Railing
- Rooms, area, schedule, material takeoff, Detailing
- massing, Sheet
- Visibility & graphics
- Site Design
- Legend, In-place families
- Family creation
- Introduction to new conceptual mass
- Short reminder of all commands
- Project work

REVIT MEP

- REVIT MEP starts with Interface of MEP, Working with files, Working with views, File concepts
- Opening of Revit MEP Project
- System tab, HVAC & Mechanical
- Systems Tab - Plumbing And Piping
- Systems Tab - Electrical
- Linked CAD Files - Elevations & Floor Plans
- Room Bounding objects, Creating Spaces, Space Separation Boundaries, Modifying Spaces, Space Tags, Area And Volume Calculations.
- Graphic Overrides, Checking Systems, System Inspector, Duct Sizing, Room Color fills, Creating Zoning, Adding HVAC Equipment's
- Mechanical Piping System, Pipe Fittings, Filters
- Electrical Components - Lighting Fixtures
- Electrical Components - Electrical Devices, Creating Power Circuits, Switch
- Conduit, Cable Tray
- Creating Plumbing views, Creating Fixture, Pipe Schedules etc
- Placeholder Pipes, Pipes, Parallel Pipes, Modifying Plumbing Fixtures.

REVIT STRUCTURE

- Introduction of foundation, Isolated footing, & Wall foundation,
- Introduced to concrete & steel column, Modeling concrete column, Placing column,
- Beam, Introduced to concrete & steel beams, Concrete arc beam, Draw beams
- Introduced to slab, Draw a slab using boundary line, Type properties of slab, Edit slab property,
- Introduced to reinforcement, Reinforcement in column & beam, Wall reinforcement, Stirrup reinforcement, Introduction to cover & editing cover
- Column Rebar, Column Covering, Beam Rebar, Beam covering
- Truss & Insert Tab
- Schedule, Beam schedule, Column Schedule
- Detailing, Callout views, Duplicate view, drafting & symbols
- Visibility & Graphics
- Fabric Reinforcement
- Legend, in place families & family creation



140⁺
 COMPANIES



175⁺
 PLACED STUDENTS



• MECH. CAD • CIVIL CAD • BIM CAD • ELEC. CAD • ACCOUNTING • GRAPHICS • DIGITAL MARKETING

OUR POWERFUL PLACEMENT STRATEGY

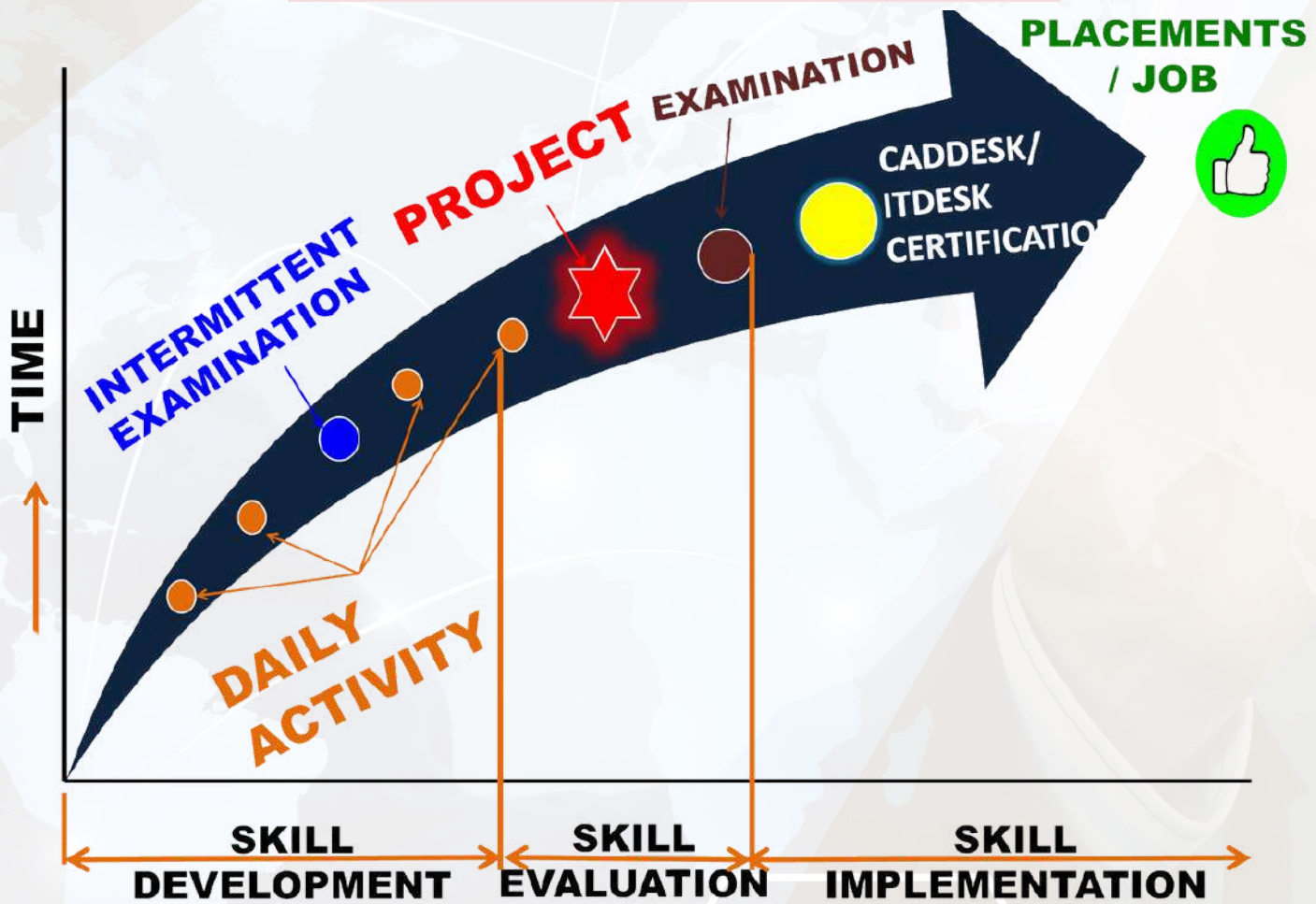

- 100+ ACTIVITIES ON VARIOUS SOFTWARES
- AMPLE AMOUNT OF PRACTICE TIME
- CAD & IT - SPEED UP EXAMINATION
- CREATIVE & INNOVATIVE PROJECTS
- TECHNICAL & PRACTICAL SESSIONS
- CAREER AWARENESS SESSIONS
- COMPLETE & CLEAR RESUME
- MULTIPLE INTERVIEW OPPORTUNITIES

Placement Partner

BHASKARS ENGINEERING DESIGN & IT CENTER

<https://cadenggr.com/placement-services>

+91 - 80500 91122 80500 41122



SINCE 2007

(Software Training & Placement Services)



140 #



175 #

GUARANTEE



PLACEMENT



COMPANIES

PLACED STUDENTS

• MECH. CAD • CIVIL CAD • BIM CAD • ELEC. CAD • ACCOUNTING • GRAPHICS • DIGITAL MARKETING

SAMPLE BIM MODELING PROJECTS OF OUR STUDENTS

Created by: Shaik Imtiaz Ali

ID: 8419 / 159

Exterior Design - 5 Star Hotel

Interior & Arch. Bim models

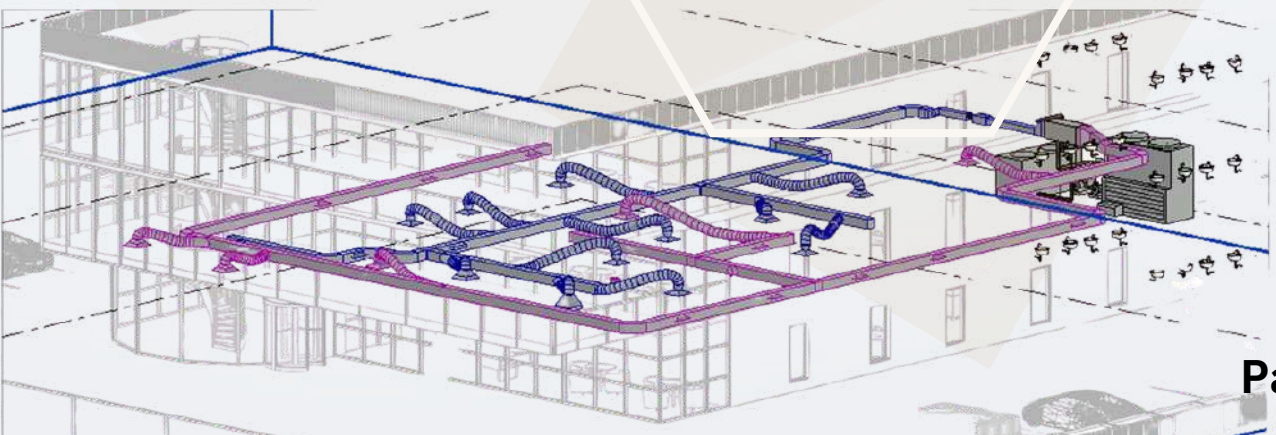
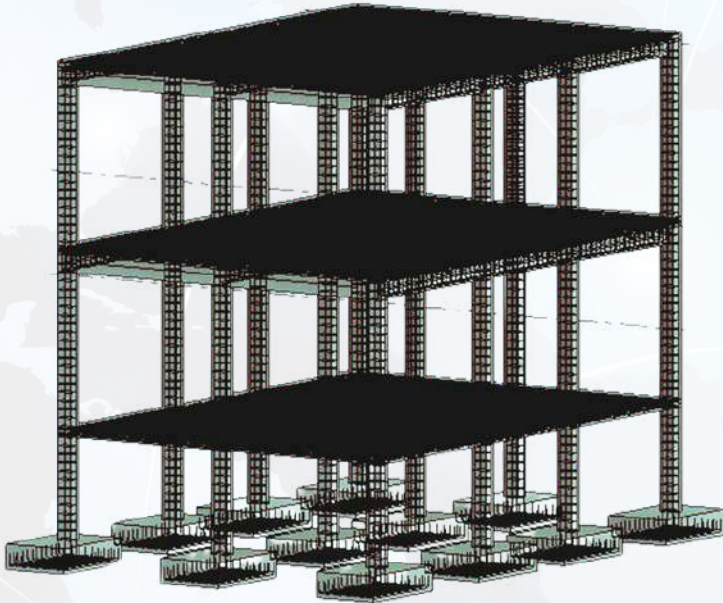



SINCE 2007

(Software Training & Placement Services)



140 #



175 #



COMPANIES

PLACED STUDENTS

- MECH. CAD • CIVIL CAD • BIM CAD • ELEC. CAD • ACCOUNTING • GRAPHICS • DIGITAL MARKETING

SAMPLE BIM MODELING PROJECTS OF OUR STUDENTS

Created by: Gali Preethika
ID: 8418 / 56
Interior, Architecture
Structural, MEP - BIM Models

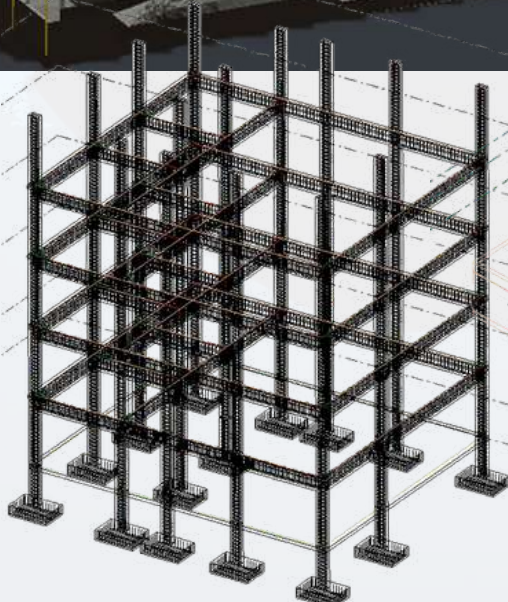



SINCE 2007

(Software Training & Placement Services)



140 #

COMPANIES



175 #

PLACED STUDENTS

GUARANTEE

PLACEMENT

- MECH. CAD • CIVIL CAD • BIM CAD • ELEC. CAD • ACCOUNTING • GRAPHICS • DIGITAL MARKETING

SAMPLE BIM MODELING PROJECTS OF OUR STUDENTS

Created by: Golla Abishek Yadav

ID: 8418 / 60

Interior, Architecture

Structural, MEP - BIM Models



SINCE 2007

(Software Training & Placement Services)



140 ⁺
COMPANIES



175 ⁺
PLACED STUDENTS



- MECH. CAD • CIVIL CAD • BIM CAD • ELEC. CAD • ACCOUNTING • GRAPHICS • DIGITAL MARKETING

SAMPLE BIM MODELING PROJECTS OF OUR STUDENTS

Created by: Golla Abishek Yadav

ID: 8418 / 60

Interior, Architecture

Structural, MEP - BIM Models

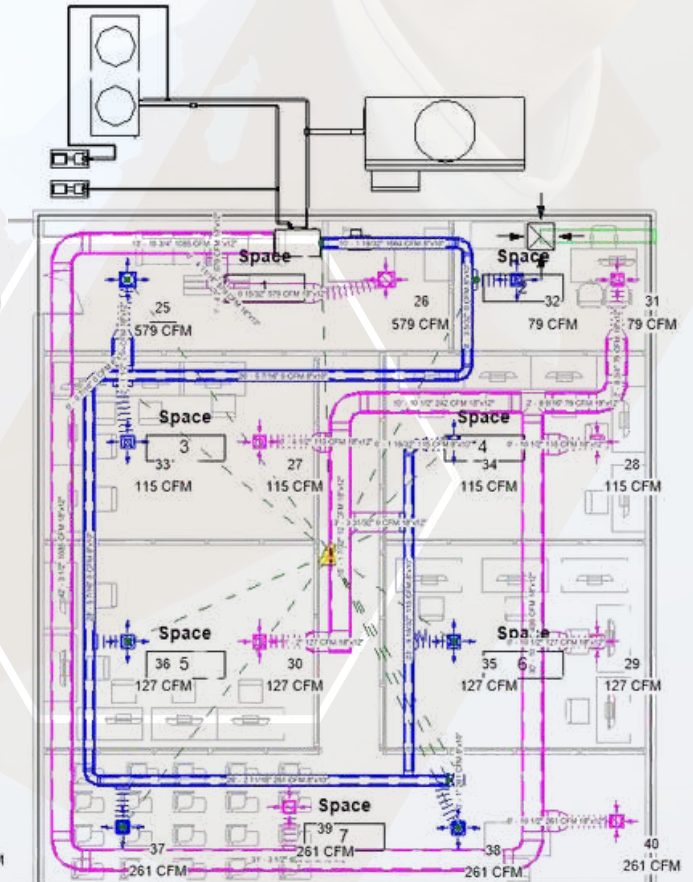
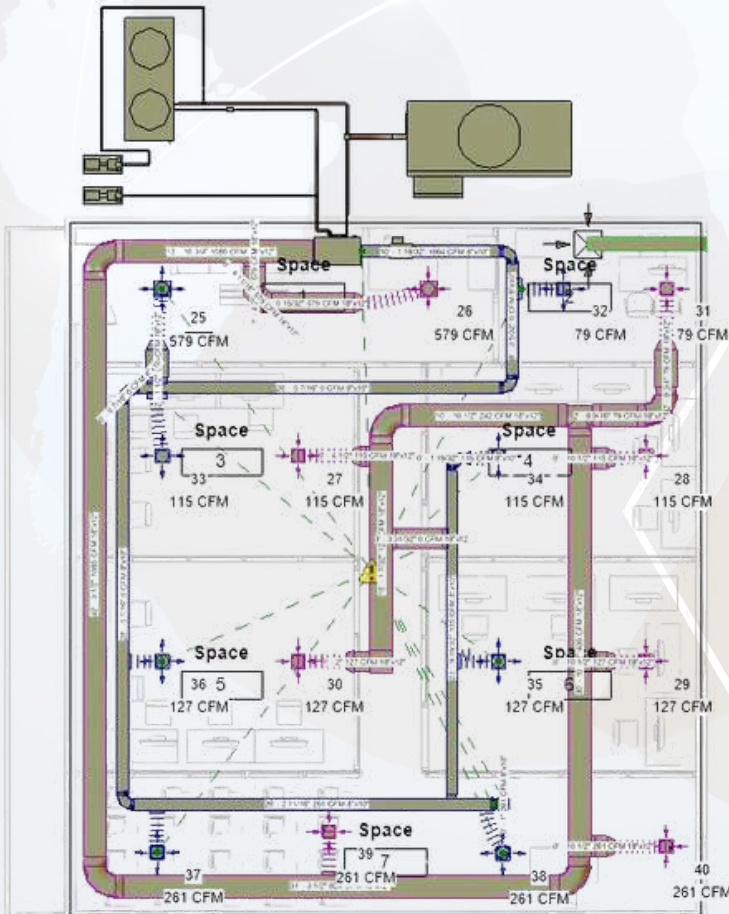
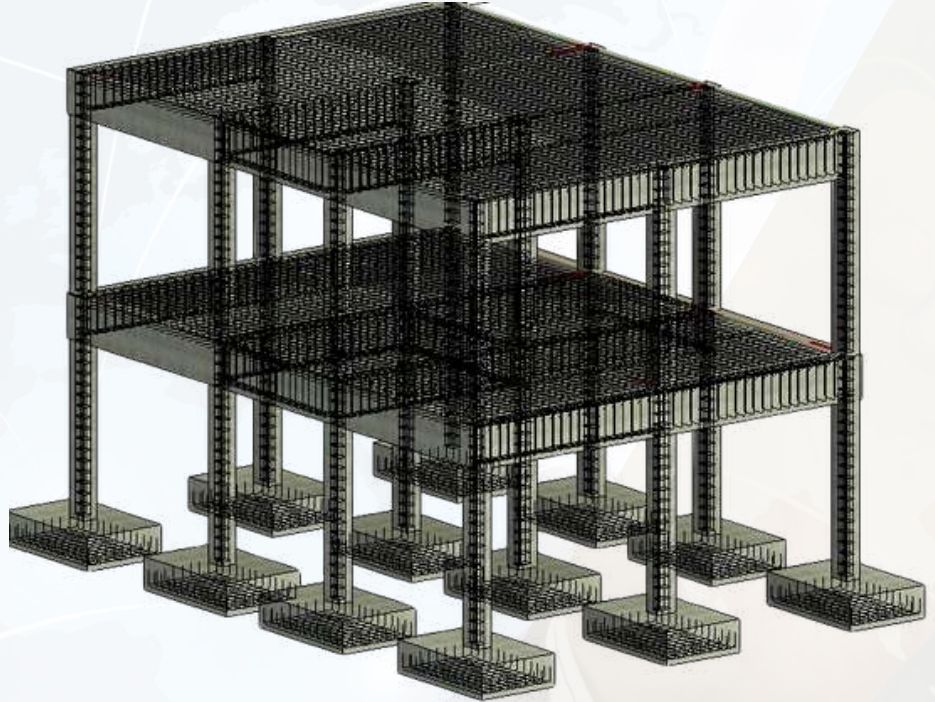
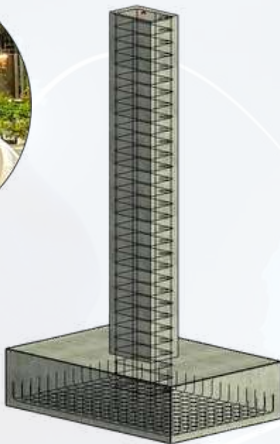



SINCE 2007

(Software Training & Placement Services)



140 ⁺
COMPANIES



175 ⁺
PLACED STUDENTS



- MECH. CAD • CIVIL CAD • BIM CAD • ELEC. CAD • ACCOUNTING • GRAPHICS • DIGITAL MARKETING

SAMPLE BIM MODELING PROJECTS OF OUR STUDENTS

Created by: **Thalluri Reshma**
ID: 8418 / 62
Interior, Architecture
Structural, MEP - BIM Models

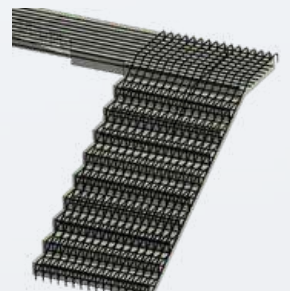
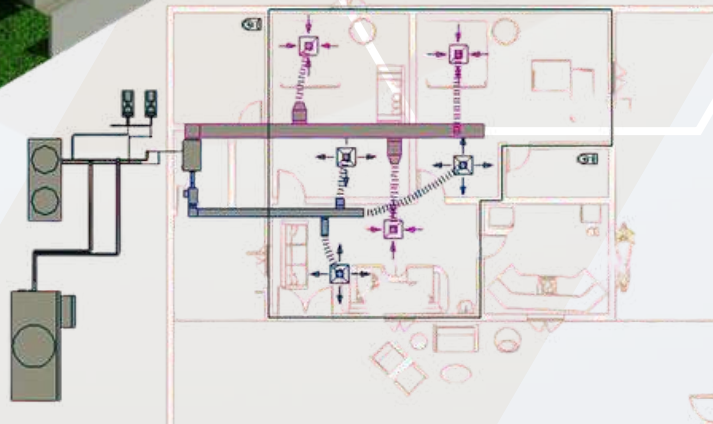
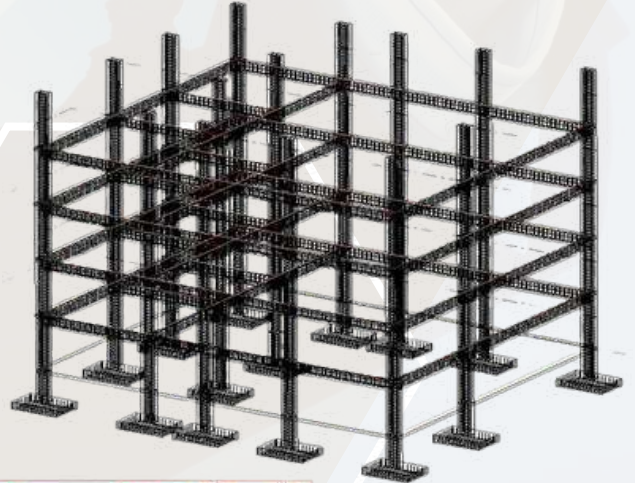



SINCE 2007

(Software Training & Placement Services)



140⁺
COMPANIES



175⁺
PLACED STUDENTS



• MECH. CAD • CIVIL CAD • BIM CAD • ELEC. CAD • ACCOUNTING • GRAPHICS • DIGITAL MARKETING

SAMPLE BIM MODELING PROJECTS OF OUR STUDENTS

Created by: N Venu Madhava
ID: 8418 / 61
Interior, Architecture
Structural, MEP - BIM Models

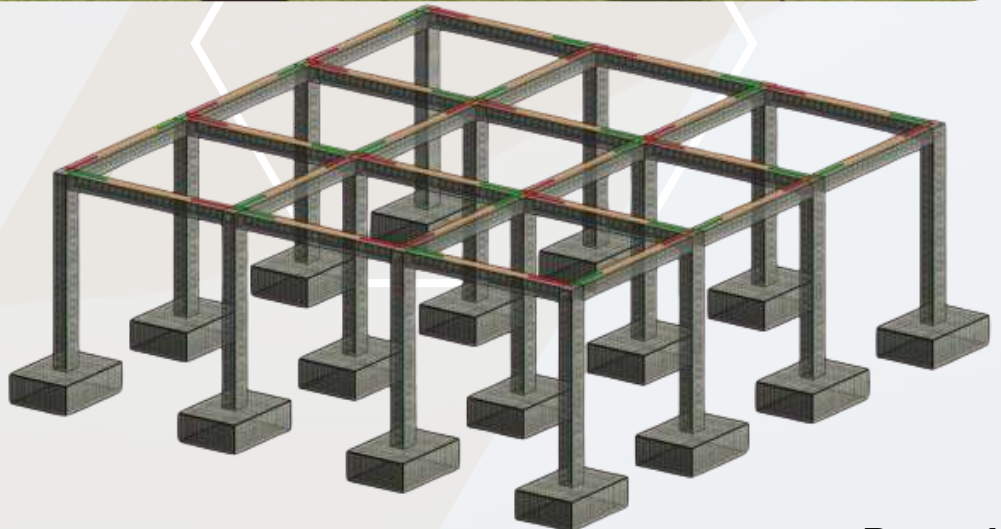
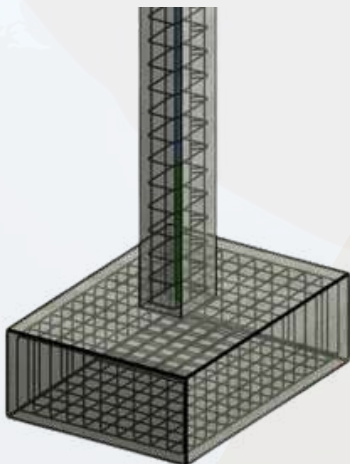



SINCE 2007

(Software Training & Placement Services)



140 ⁺
 COMPANIES



175 ⁺
 PLACED STUDENTS



• MECH. CAD • CIVIL CAD • BIM CAD • ELEC. CAD • ACCOUNTING • GRAPHICS • DIGITAL MARKETING

ADDITIONAL IMPORTANT THINGS FOR INTERVIEW & CAREER

- Student gains additional knowledge on structural designs & respective terminology
- Students will also be given knowledge on practical drawings beginning from foundation key plans, columns, beams, slab, staircase, etc.
- Practical drawings shown with Vastu, Setback, Carpet area
- Core fundamentals of Civil Engineering
- Tools & Terminology of Interior Design

With the knowledge on Architecture, Interior, Exterior, HVAC, Plumbing & Structural. Student can gain the complete knowledge on Building Information

SAMPLE REAL TIME EXECUTED DRAWINGS

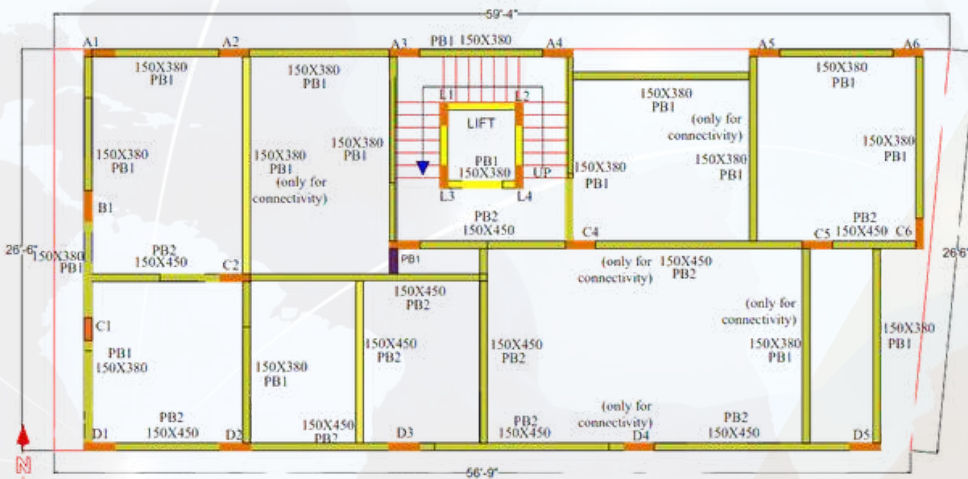

Key Plan for Plinth Beam

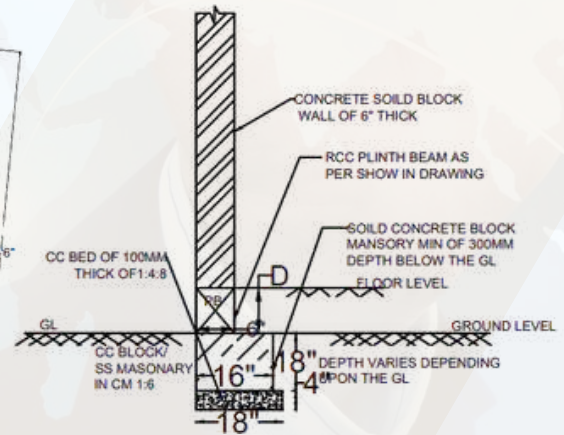

Typical Section Reinforcement Details for Pb1 & Pb2 beams

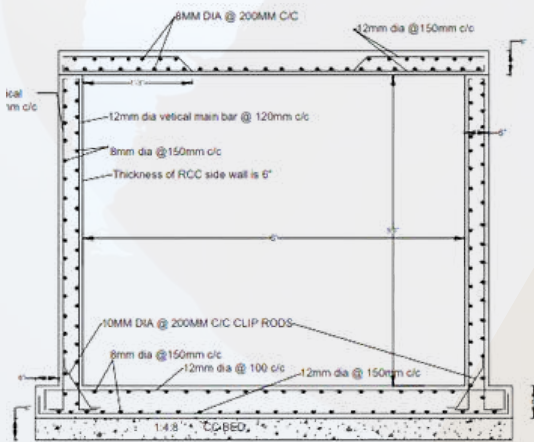

Reinforcement Details Sump

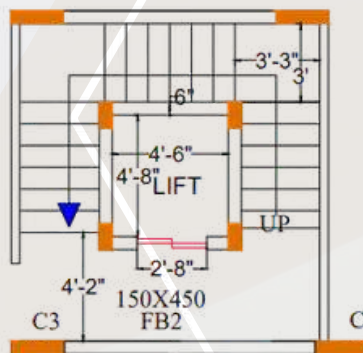

Key Plan for staircase & Reinforcement Details

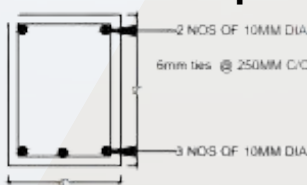
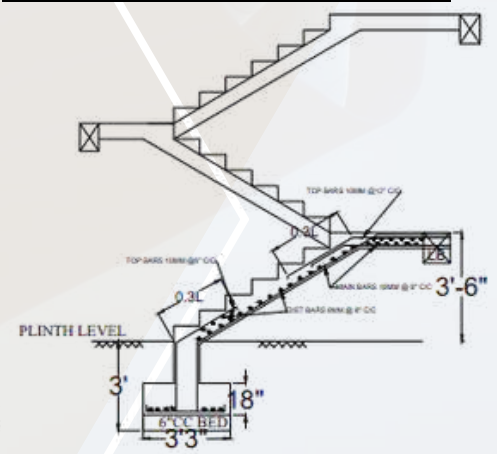

Typical Cross Section of RCC Chejja

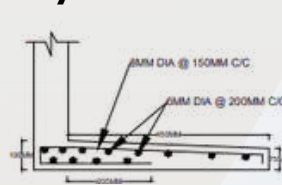



SINCE 2007

(Software Training & Placement Services)



140⁺
 COMPANIES



175⁺
 PLACED STUDENTS



- MECH. CAD • CIVIL CAD • BIM CAD • ELEC. CAD • ACCOUNTING • GRAPHICS • DIGITAL MARKETING

ADDITIONAL IMPORTANT THINGS FOR INTERVIEW & CAREER

With the knowledge on Architecture, Interior, Exterior, HVAC, Plumbing & Structural. Student can gain the complete knowledge on Building Information

SAMPLE REAL TIME EXECUTED DRAWINGS

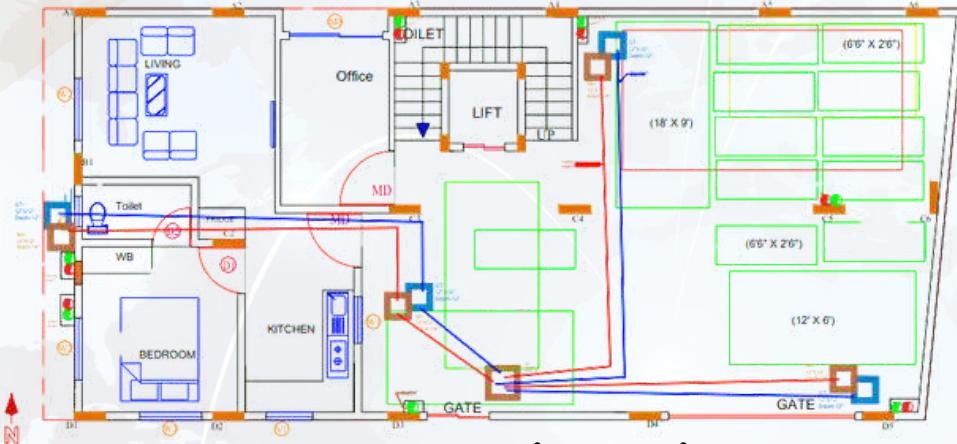

Sample Plumbing Drawing

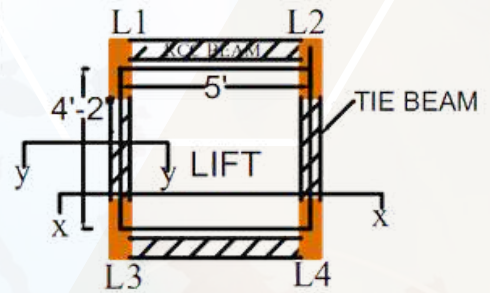

Lift pit

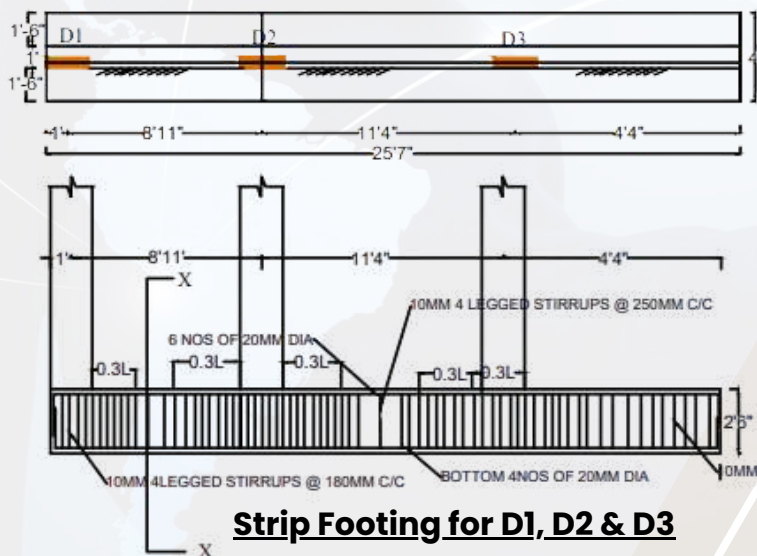

Strip Footing for D1, D2 & D3

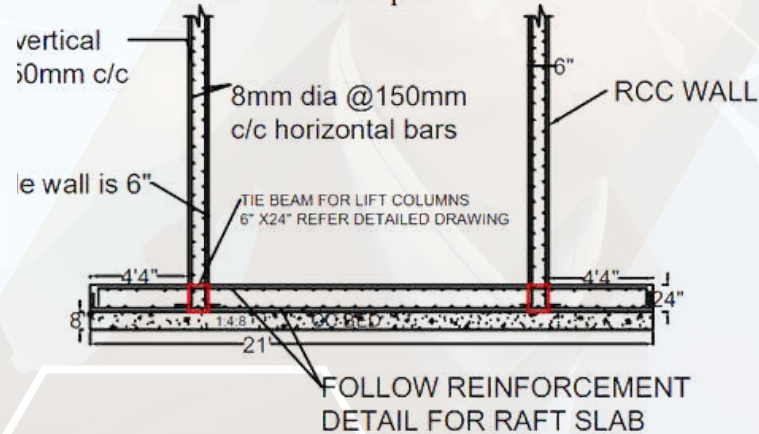

Section for Columns - Sample

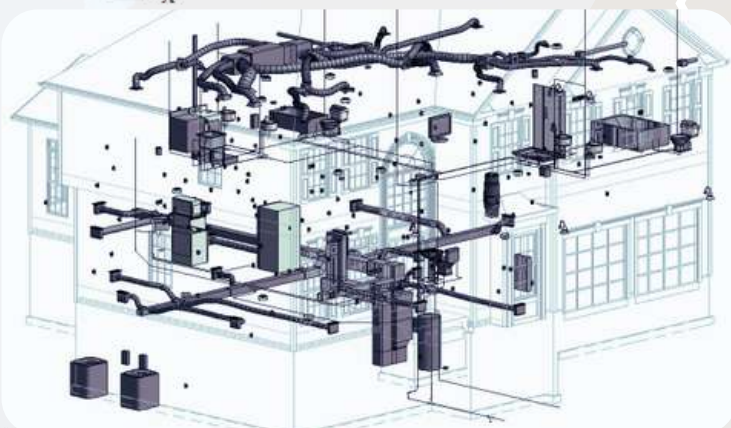

Practical HVAC Models





140⁺
COMPANIES



175⁺
PLACED STUDENTS



• MECH. CAD • CIVIL CAD • BIM CAD • ELEC. CAD • ACCOUNTING • GRAPHICS • DIGITAL MARKETING

MASTER CAD BIM – PLACEMENT COURSE FEE STRUCTURE

SL.No.	5 Course Program	*6 Course Program	*7 Course Program	8 Course Program
1	AutoCAD	AutoCAD	AutoCAD	AutoCAD
2	Sketch up	Sketch up	Sketch up	Sketch up
3	V-Ray	Enscape	Enscape	Enscape
4	Revit Arch.	Revit Arch.	Revit Arch.	Revit Arch.
5	Revit MEP	Revit MEP	Revit MEP	Revit MEP
6	-	Revit Structure	Revit Structure	Revit Structure
7	-	-	Navis Works	Navis works
8				Quantity take
Actual Course Fee	66,000/-Rs	81,000/-Rs	99,000/-Rs	1,07,000/-Rs
Final Course Fee (2 EMI)	47,000/-Rs	53,000/-Rs	64,000/-Rs	71,000/-Rs
Final Course Fee (1 EMI)	42,000/-Rs	49,000/-Rs	58,000/-Rs	65,000/-Rs

Note:

- All the above discounts are applicable for the Offline Students, Passout after 2022
- There will be no change in the course program structure once receipt is generated.
- All the course programs are included with books, related Technical Sessions, Skill sessions etc.
- Students who are coming from other districts and states will have add on discount of 2500/-Rs (Two thousand Rupees)



SINCE 2007

(Software Training & Placement Services)



140⁺
COMPANIES



175⁺
PLACED STUDENTS



• MECH. CAD • CIVIL CAD • BIM CAD • ELEC. CAD • ACCOUNTING • GRAPHICS • DIGITAL MARKETING

OUR PLACEMENT PARTNERS



MICRON ELECTRICALS



3D CONCEPT



IVORY SENSE



UNIT ALPHA



ELEMENT INFOMATICS



EMATRIX ENGG. LTD



PASOLITE



SOLID SYSTEMS



CONCEPT ENGINEERING



ROYAL LINKS



ENERGYAN LTD



CALIBER PVT. LTD



BAJAJ CAPITAL



VERVEE COURTURE



ENCLAVAR BUILDERS



ADARSH CONTROL



SHATHI FACADE'S



VARSHINORA DESIGN



AESTHETIX SPACES



140⁺
COMPANIES



175⁺
PLACED STUDENTS



• MECH. CAD • CIVIL CAD • BIM CAD • ELEC. CAD • ACCOUNTING • GRAPHICS • DIGITAL MARKETING

OUR PLACEMENT PARTNERS



ARCADIS



XNG AUTOMATION



NAUVATA ENGINEERING



FOCAL SYSTEMS



NEW FIELD ENGINEERING



BHILWARA INFOTECHNOLOGY LTD

BHILWARA INFOTECHNOLOGY



PINNACLE



STEEL KRAFT



ELEGANZ INTERIORS



MORPHLE LABS



CREATIVE TECHNOLOGY



SMART QUICK VENTURES



SANCTUM TECHNOLOGIES



GENESIS IT INNOVATIONS



CEA ENGG. AUTOMATION



STAR SWITCH GEARS



QUAD GEN



OLA ELECTRIC



SOBHA LIMITED

FOR MORE DETAILS ABOUT OUR PLACEMENT PARTNERS - PLEASE

VISIT THE BELOW WEBSITE LINK <https://cadenggr.com/placement-services>

SINCE 2007

(Software Training & Placement Services)



140⁺
COMPANIES



175⁺
PLACED STUDENTS



• MECH. CAD • CIVIL CAD • BIM CAD • ELEC. CAD • ACCOUNTING • GRAPHICS • DIGITAL MARKETING



Mr. Prasanna H.G.



Mr. Soumya Bhattacharya



Mr. PruthviRaj Singh K



Ms. Ruksana Banu



Mrs. Chaitra



Ms. Nikita Kumari Sah



Mrs. Sushmitha H M



Ms. Sneha Lakshmi CR

CONGRATULATIONS TO OUR PLACED STUDENTS



Devaki A M



K Akhilesh



Sumangala



Deepak M K



Prabhatika



A Meghana



Yuvraj N



Girish Kumar



Bheemanna



M Faras k P



Chidvilasya



Niranjana D



Prakash Das



Y Hemanth



Aromal SS



K Venu Gopal



B Dhinesh K



T Reshma



Mrunmay KS



Dhana Raj D



Krishna V



A Gaurav



G Preethika



Vigneash M



Padmapriya K



Yashik



A Charan



S Imtiaz Ali



Animesh M



Sujal C M



Mr. Uday Bhaskar Varada
Mrs. Priyanka Bhaskar Varada



Vijay AS



Airish J



Manohar MN



Gowripriya



C Sandhya



P Pavani



Munirathinam



Sambharam



Ramanunni



D Saleem



Suman F



Narayanan



Adi Krishna C



Vaishnavi G



Kiran D Patil



Niharika.B

Placement Partner

BHASKARS ENGINEERING DESIGN & IT CENTER

<https://cadenggr.com/placement-services>

+91 - 80500 91122 80500 41122

SINCE 2007

(Software Training & Placement Services)



140⁺
COMPANIES



175⁺
PLACED STUDENTS



• MECH. CAD • CIVIL CAD • BIM CAD • ELEC. CAD • ACCOUNTING • GRAPHICS • DIGITAL MARKETING

CONGRATULATIONS TO OUR PLACED STUDENTS



N Syedbasha



Vaishnavi



A Rahman



B Mohan



Amit Kumar



Venu Madhav



N Yogendra



VSai Venkat



Jeevitha



R Sateesh



P Firoz Khan



S Gowdhaman



D Ayisha



Girish C T



Ankitha G N



Neha K R



N Sai Sumathil



Deepak R



Niranjana R



Supreet K



Syed Saqib



Nagaraj R



Ganesh



M Charitha



K Pavan



Y G Sudhakar



P Vasantha



Tashvin



Pawan N S



Arun



Ayush



Vamsi J



Ravi Teja



Rohitha



Shahaji



Shuklodhana



Lokesh KA



Sai Chandana



RaviTeja



B Chandrasekhar



Monika S



Chandrasekhar



Y Thanuja



T Lokesh



Deepthi



R Sreeja



D Yugandhar



Manoj DN



Aishwarya N



VaniSree B



T Amarnath



BS Karthik



Asifulla Khan



Chandrashekar



Anil K



Krishnavasu



Shakthi K



Satish



Theja



Peter Joh



Adarsh G



M Alfaz



Vinay R



Megha D

Placement Partner

BHASKARS ENGINEERING DESIGN & IT CENTER

<https://cadenggr.com/placement-services>

+91 - 80500 91122 80500 41122



SINCE 2007

(Software Training & Placement Services)



140⁺
COMPANIES



175⁺
PLACED STUDENTS



• MECH. CAD • CIVIL CAD • BIM CAD • ELEC. CAD • ACCOUNTING • GRAPHICS • DIGITAL MARKETING

CONGRATULATIONS TO OUR PLACED STUDENTS



Vidya R



Pallavi B



P Mounika



Swathi R S



Manoj N S S



Suresh Babu



A Rekha



Elbin Jose



P Maneesha



Sandeep C



Abhishek K



B Mounika



Kavya R



R Azhar Ali



Thejasy



N Lokesh



H Vichitra



M Vinay



CR Pramoda



Vineeth N



Sivasankar



Dayanand



Venkat



M Gautham



B G Sunil



Abinraj



Pavan

Received Offers



Bhagyashree



Sharan B



Nitheesh N



Aasiya T



Tharun



Aasif khan



Dayananda G



M Hasheem



Vidya N



S Jaheer



Bhagyashree



Mausumi P



M Shireen



Rafi SM

FOR MORE DETAILS ABOUT OUR PLACED STUDENTS - PLEASE VISIT THE BELOW WEBSITE LINK <https://cadenggr.com/placement-services>

Placement Partner

BHASKARS ENGINEERING DESIGN & IT CENTER

<https://cadenggr.com/placement-services>

+91 - 80500 91122 80500 41122



140⁺
COMPANIES



175⁺
PLACED STUDENTS



- MECH. CAD • CIVIL CAD • BIM CAD • ELEC. CAD • ACCOUNTING • GRAPHICS • DIGITAL MARKETING

GLIMPSE OF OUR PLACEMENT THUMB SIGN RULE - OUR SIGNATURE PIC

When student gets Job Opportunity from our centre, to share our happiness we pose a Thumb sign as a symbol of success





140⁺
COMPANIES



175⁺
PLACED STUDENTS



• MECH. CAD • CIVIL CAD • BIM CAD • ELEC. CAD • ACCOUNTING • GRAPHICS • DIGITAL MARKETING

GLIMPSE OF OUR SESSIONS

Resume preparation Sessions:



Students Examination:



Technical Sessions:





140+
COMPANIES



175+
PLACED STUDENTS



• MECH. CAD • CIVIL CAD • BIM CAD • ELEC. CAD • ACCOUNTING • GRAPHICS • DIGITAL MARKETING

GLIMPSE OF OUR SESSIONS



Placement Partner

BHASKARS ENGINEERING DESIGN & IT CENTER

<https://cadenggr.com/placement-services>

+91 - 80500 91122 80500 41122



140 ⁺
 COMPANIES



175 ⁺
 PLACED STUDENTS



• MECH. CAD • CIVIL CAD • BIM CAD • ELEC. CAD • ACCOUNTING • GRAPHICS • DIGITAL MARKETING

GUEST VISIT TO OUR CENTER



BEST EMPLOYER RECRUITMENT AWARD
 (Sep, 2024 – Aug, 2025)
 for outstanding recruitment support

Sobha limited has recruited 7 resources in a short while

1. Vamsi J (8419/265) -
2. Shakthi (8418 / 95) -
3. Airish Jonas (8419/232) -
4. Vinay R (8419/266) -
5. BS Karthik (8418/120) -
6. G Venkata Raviteja (8419/306) -
7. D Yugandhar (8419/307) -



BEST EMPLOYER RECRUITMENT AWARD
 (Sep, 2023 – Aug, 2024)
 for outstanding recruitment support

TICS Engineering has recruited 7 resources with in 8 months, Interviewed most no. of students and supported us with Ontime communication.

1. Girish C T (8419/174)
2. Annangi Charan(8419 / 154)
3. N Lokesh (8419 / 142)
4. Sandeep Chandran (8419 / 125)
5. Elbin Jose (8419 / 112)
6. Girish Kumar(8419 / 92)
7. Yuvraj N (8419 / 86)





140
COMPANIES



175
PLACED STUDENTS



• MECH. CAD • CIVIL CAD • BIM CAD • ELEC. CAD • ACCOUNTING • GRAPHICS • DIGITAL MARKETING

GLIMPSE OF OUR SOCIAL SERVICE EVENTS

Initiated Blood Doantaion Campaign on reaching our 1st Mile Stone
100th Placement in our Centre



Placement Partner

BHASKARS ENGINEERING DESIGN & IT CENTER

<https://cadenggr.com/placement-services>

+91 - 80500 91122 80500 41122



SINCE 2007

(Software Training & Placement Services)



140⁺
COMPANIES



175⁺
PLACED STUDENTS



• MECH. CAD • CIVIL CAD • BIM CAD • ELEC. CAD • ACCOUNTING • GRAPHICS • DIGITAL MARKETING

GLIMPSE OF AWARDS, EVENTS & CELEBRATIONS





SINCE 2007

(Software Training & Placement Services)



140⁺
COMPANIES



175⁺
PLACED STUDENTS



• MECH. CAD • CIVIL CAD • BIM CAD • ELEC. CAD • ACCOUNTING • GRAPHICS • DIGITAL MARKETING

GLIMPSE OF AWARDS, EVENTS & CELEBRATIONS



Placement Partner

BHASKARS ENGINEERING DESIGN & IT CENTER

<https://cadenggr.com/placement-services>



SINCE 2007

(Software Training & Placement Services)



140⁺
COMPANIES



175⁺
PLACED STUDENTS



• MECH. CAD • CIVIL CAD • BIM CAD • ELEC. CAD • ACCOUNTING • GRAPHICS • DIGITAL MARKETING

BEST QUALITY TRAINING

In the all India CADDESK Software Training Summit held in March 2025, Caddesk Bommanhalli is Awarded as the “Best Quality Training Institute” & “Best Marketing Parctice centre”



Placement Partner

BHASKARS ENGINEERING DESIGN & IT CENTER

<https://cadenggr.com/placement-services>



SINCE 2007

(Software Training & Placement Services)



140+
COMPANIES



175+
PLACED STUDENTS



• MECH. CAD • CIVIL CAD • BIM CAD • ELEC. CAD • ACCOUNTING • GRAPHICS • DIGITAL MARKETING

PLACEMENT CATEGORY COURSE PROGRAMS & FEE STRUCTURE



TRAINING & PLACEMENT UNIT
PLACEMENT GUARANTEED COURSE PROGRAMS & FEE STRUCTURE

Master CAD BIM (5 / 6 / 7 / 8 Course Programs)

SL.No.	5 Course Program	6 Course Program	7 Course Program	8 Course Program
1	AutoCAD	AutoCAD	AutoCAD	AutoCAD
2	Sketch up	Sketch up	Sketch up	Sketch up
3	V-Ray	Enscape	Enscape	Enscape
4	Revit Arch.	Revit Arch.	Revit Arch.	Revit Arch.
5	Revit MEP	Revit MEP	Revit MEP	Revit MEP
6	-	Revit Structure	Revit Structure	Revit Structure
7	-	-	Navis Works	Navis works
8	-	-	-	Quantity take off
Actual Course Fee	65,000/-Rs	81,000/-Rs	99,000/-Rs	1,07,000/-Rs
Final Course Fee (2 EMI)	47,000/-Rs	53,000/-Rs	64,000/-Rs	71,000/-Rs
Final Course Fee (1 EMI)	42,000/-Rs	49,000/-Rs	58,000/-Rs	65,000/-Rs

Master CAD Civil/Arch./Interior (4 / 6 Course Programs)

SL.No.	4 Course Program	6 Course Program
1	AutoCAD	AutoCAD
2	Sketch Up	Sketch up
3	V-Ray / Enscape	Enscape
4	Revit Arch.	Revit Arch.
5	-	3ds Max
6	-	3ds Max-V-Ray
Actual Course Fee	48,000/-Rs	71,000/-Rs
Final Course Fee (2 EMI)	38,000/-Rs	51,000/-Rs
Final Course Fee (1 EMI)	35,000/-Rs	47,000/-Rs

Master CAD Mechanical (4 / 5 / 6 / 7 Course Programs)

SL.No.	4 Course Program	5 Course Program	6 Course Program	7 Course Program
1	AutoCAD	AutoCAD	AutoCAD	AutoCAD
2	Solidworks	Solidworks	Solidworks	Solidworks
3	Cre-O	Cre-O	Catia	Catia
4	Gd & T	Nx-CAD	Nx-CAD	Nx-CAD
5	-	Cre-O	Cre-O	Cre-O
6	-	Gd & T	Gd & T	Gd & T
7	-	-	Ansys WB	Ansys WB
Actual Course Fee	50,000/-Rs	65,000/-Rs	80,000/-Rs	1,00,000/-Rs
Final Course Fee (2 EMI)	38,000/-Rs	45,000/-Rs	51,000/-Rs	65,000/-Rs
Final Course Fee (1 EMI)	35,000/-Rs	42,000/-Rs	47,000/-Rs	61,000/-Rs

Full Stack Courses (Only Training)

SL.No.	Python Full Stack	Java Full Stack
1	Python	Java
2	Django	Adv. Java
3	HTML	HTML
4	CSS	CSS
5	Java Script	Java Script
6	My Sql	My Sql
Actual Course Fee	54,000/-Rs	49,000/-Rs
Final Course Fee (2 EMI)	45,000/-Rs	45,000/-Rs
Final Course Fee (1 EMI)	42,000/-Rs	42,000/-Rs

Adv. Diploma in Digital Marketing

SL.No.	3 Course Program
1	Digital Marketing
2	Photoshop
3	Illustrator
Actual Course Fee	54,000/-Rs
Final Course Fee (2 EMI)	46,000/-Rs
Final Course Fee (1 EMI)	43,000/-Rs

Adv. Diploma & Basic Diploma Accounting (2 / 3 / 4 Course Programs)

SL.No.	2 Course Program (Basic)	3 Course Program (Basic)	3 Course Program (Adv.)	4 Course Program (Adv.)
1	Ms Office	Ms Office	Tally Prime	Ms Office
2	Adv. Excel	Adv. Excel	Adv. Excel	Adv. Excel
3	-	Tally Prime	SAP Fico	Tally Prime
4	-	-	SAP Fico	SAP Fico
Actual Course Fee	20,000/-Rs	33,000/-Rs	51,000/-Rs	61,000/-Rs
Final Course Fee (2 EMI)	19,000/-Rs	30,000/-Rs	42,000/-Rs + Server Fee	48,000/-Rs + Server Fee
Final Course Fee (1 EMI)	18,000/-Rs	27,000/-Rs	39,500/-Rs + Server Fee	44,000/-Rs + Server Fee Exc.

Prof. Electrical CAD (2 / 3 Course Programs)

SL.No.	2 Course Program	3 Course Program
1	AutoCAD Electrical	AutoCAD Electrical
2	Revit MEP	Revit MEP
3	-	E-Plan
Actual Course Fee	33,000/-Rs	51,000/-Rs
Final Course Fee (2 EMI)	30,000/-Rs	42,000/-Rs
Final Course Fee (1 EMI)	27,000/-Rs	38,000/-Rs

Note:

- All the above discounts are applicable for the Offline Students, Passout after 2022
- There will be no change in the course program structure once receipt is generated.
- No placement guaranty for the course program bordered in Red lines
- General referral rewards only will be given for the course programs bordered in Blue lines.
- All the course programs are included with books, related Technical Sessions, Skill sessions etc.

Click the web link for Placement Category Courses / Rotate and See the details here

<https://caddeskbangalore-bommanhalli.com/software-discount>





SINCE 2007

(Software Training & Placement Services)



140⁺
 COMPANIES



175⁺
 PLACED STUDENTS



• MECH. CAD • CIVIL CAD • BIM CAD • ELEC. CAD • ACCOUNTING • GRAPHICS • DIGITAL MARKETING

CERTIFICATION

At CADDESK/ITDESK Bommanhalli & Madiwala, we strive to provide the highest quality Software training to individuals seeking to improve their skills in the field. Our mission is to ensure that our students receive the Software Education and Knowledge necessary to succeed in their Career with good Job Opportunity. Category of Certification (Sample certificates below):

1. Single Software Certification - CAD/IT Certification
2. Two Software Certification - Diploma CAD/IT Certification
3. Three Software Certification - Professional/Advance Diploma CAD/IT Certification
4. Four+ Software Certification - Master Diploma in CAD/IT Certification - (Highest Cer





140 ⁺
COMPANIES



175 ⁺
PLACED STUDENTS



• MECH. CAD • CIVIL CAD • BIM CAD • ELEC. CAD • ACCOUNTING • GRAPHICS • DIGITAL MARKETING

JOIN & REFER OTHERS



Dear upcoming students / CADDESK/ITDESK Bommanhalli & Madiwala students - appreciate your trust in our Training and Placement process.

★ Join & Refer your friend to gain good Software Knowledge

★ Join & Refer your friend to Develop Skills

★ Join & Refer your friend to Grab Good Job Opportunity

★ Join & Refer your friend for a Bright Career

★ Join & Refer your friend for a better society





140⁺
COMPANIES



175⁺
PLACED STUDENTS



• MECH. CAD • CIVIL CAD • BIM CAD • ELEC. CAD • ACCOUNTING • GRAPHICS • DIGITAL MARKETING

IMPORTANT QUESTION & ANSWERS

1. What is the amount of Practice time needed to gain skill in the software?

A Student who is willing to start the career in Software field, He/She needs to Spend atleast 2-3 hours quality time in practicing the software. (Expecting He/She has basic subject knowledge)

2. Is it really necessary to practice every day?

Practice develops 3 major important characteristics
- SPEED - PERFECTION & - ACCURACY

Having the Idea in software is basic, in reality when a CAD /IT student attend the Interview the main focus by Inteviewers is on the level Speed, Accuracy and Perfection.



3. Why does a student who come out from the college (Job less / No Campus Jobs) have tough situation outside? Why there is more competition for software Jobs?

Please understand the Hierarchy model of the Organizations & Colleges in the below link and answer for many questions related to Top level companies, Salary, Competition outside etc.

https://youtu.be/X4cJEw_4wmo

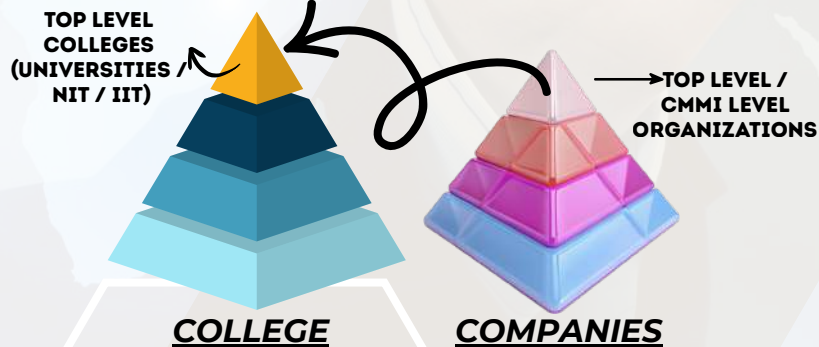

4. If the student is Good in Software only, wether he will get the right Job?

5. If the student is Good in Communication only, wether he will get the right Job?

6. If the student has 90% only in his academics, wether he will get the right Job?

7. Student has good skills but does not have perfect resume, wether he may get right Job?

8. What are the Expectation of the Organizations from the Job Seekers?

Click the link to see the Tour to Mechanical CAD Software class <https://youtu.be/IZB7UUn9aw0>

Click the link to see the Tour to Civil CAD Software class <https://youtu.be/6Ra29Gk3FIY>

Click the link to see Glimpse of English Class room session - <https://youtu.be/Wn9lIxsoQkM>

Click the link to see Glimpse of resume writing session <https://youtu.be/NqG1t7L73K8>

Click the link to see the Expectation of the Oranization from Job Seekers <https://youtu.be/RzyjMTCrheY>

"OUR AIM OVER ALL SKILL DEVELOPMENT"



140⁺
COMPANIES



175⁺
PLACED STUDENTS



• MECH. CAD • CIVIL CAD • BIM CAD • ELEC. CAD • ACCOUNTING • GRAPHICS • DIGITAL MARKETING

ORGANIZATION SELECTION CRITERIA



FINALLY THE ORGANIZATIONS LOOK FOR OVERALL SKILL IN THE RESOURCES

**In our training process we aim to develop Skills & Awareness
"OVER ALL SKILL DEVELOPMENT"**

**Communication skills + Software skills + Technical skills +
Behavior + Awareness of (Presentation + Commitment +
Responsibility & others)**





140⁺
COMPANIES



175⁺
PLACED STUDENTS



• MECH. CAD • CIVIL CAD • BIM CAD • ELEC. CAD • ACCOUNTING • GRAPHICS • DIGITAL MARKETING

TIME FOR REGISTRATION

Dear aspirants / career seekers who are interested in the Software Training and Placement, Please find the 3 steps.

Step 1: Feel free to contact us & clarify any query

Step 2: Please see the Domain (Civil/Mech/Elec/Accounting/Graphic etc.) related Brochure for Content, Student Projects, Course fee etc.

Step 3: With a nominal token registration fee Book your time and slot

Step 4: Now click the link here to register



**TRAINING
&
PLACEMENTS**



<https://caddeskbangalore-bommanhalli.com/payments-%26-registration>

CONTACT US

Placement Partner

 **BHASKARS ENGINEERING DESIGN & IT CENTER**

 <https://cadenggr.com/placement-services>

Training Website

 <https://caddeskbangalore-bommanhalli.com>

 **+91 - 80500 91122 80500 41122**