

# Supplemental Lessons and Practice Counting by Ones and Tens

e - Library

1.0

## Main Menu

Counting  
Level A

Counting  
Level B

Counting  
Level C-E

Counting by Tens  
Level A-D

## Free Supplement

Numeracy Consultants LLC

*To Purchase the remainder of the eLibrary 1.0  
Please visit:*

<https://numeracyconsultants.net/store>





## Numeracy Specialist Program (13 hours) - Level 3 (Expert)

The Numeracy Specialist Program is a level 3 (Expert) training that is designed for classroom, special ed, and math support teachers. This program is a **deep dive** into [math intervention](#). The 4 day course will help teachers develop a thorough understanding of primary numeracy, multiplication and division, and fractions. **Once an understanding of the learning frameworks is unlocked**, we will focus on creating **student groups, selecting target skills with differentiation , transitioning between programs, progress monitoring and data tracking, alternative forms of assessment, and planning lessons and activities for students.**

This training provides an opportunity for teachers to earn a certificate of completion for a 12 hour course (3 hours and 15 min. per day over the course of 4 days) that covers all 3 of our programs. **This program is taught live by a consultant in a virtual setting.**

This course is for individuals who already have **some experience with the administration and scoring of the assessments which are free on our website**. Participants will also receive **new resources** including new **progress monitoring** documents for observations and **materials for instruction**.

The training requires active participation. Throughout the training several real world scenarios with undetermined outcomes will be presented and the group will discuss and find the best path forward.

**Please see the agenda below. Though suggested, Level 2 training is not required to attend this training.**

If you have any questions about registration please email [info@numeracyconsultants.net](mailto:info@numeracyconsultants.net) .



# Counting by Tens

e - Library 1.0

e-Lessons

Level **A/D**



Counting By Tens On Decade- Level A

Counting By Tens On Decade- Level A

Counting By Tens off Decade - Level B

Counting By Tens off Decade to 120s  
Level C

Counting By Tens off Decade to >200  
Level D

Numeracy Consultants LLC

## Online Practice

Unlimited Number Line

Number Grid up to 200

100 Grid Hunt 10 more 10 less

10 more 20 more number grid

## eBook

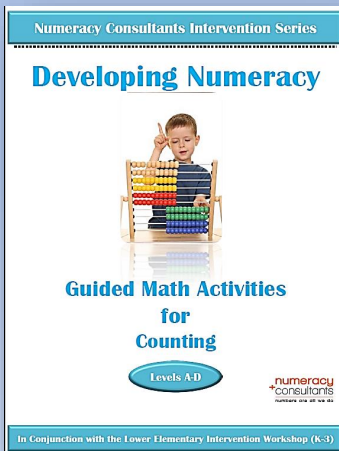

Count 10 Bundled Popsicle sticks



Count 10 Rods



Calculator Count by 10



Ten Catcher Number Line  
On Decade

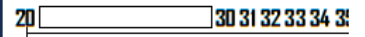

Bucket Count by 10's



Decade Number Cards  
10 more 10 less

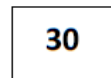

10 Finger Flashes



Add ones for Split Counting  
3 Flashes of 10 and 2 ones is what number?



**numeracy**  
**+ consultants**  
numbers are all we do

# Counting By Tens On Decade Level A

Count by Tens orally 3 times.

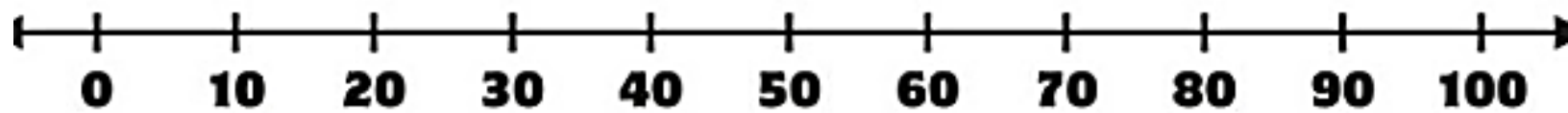

# Counting Items By Tens On Decade Level A

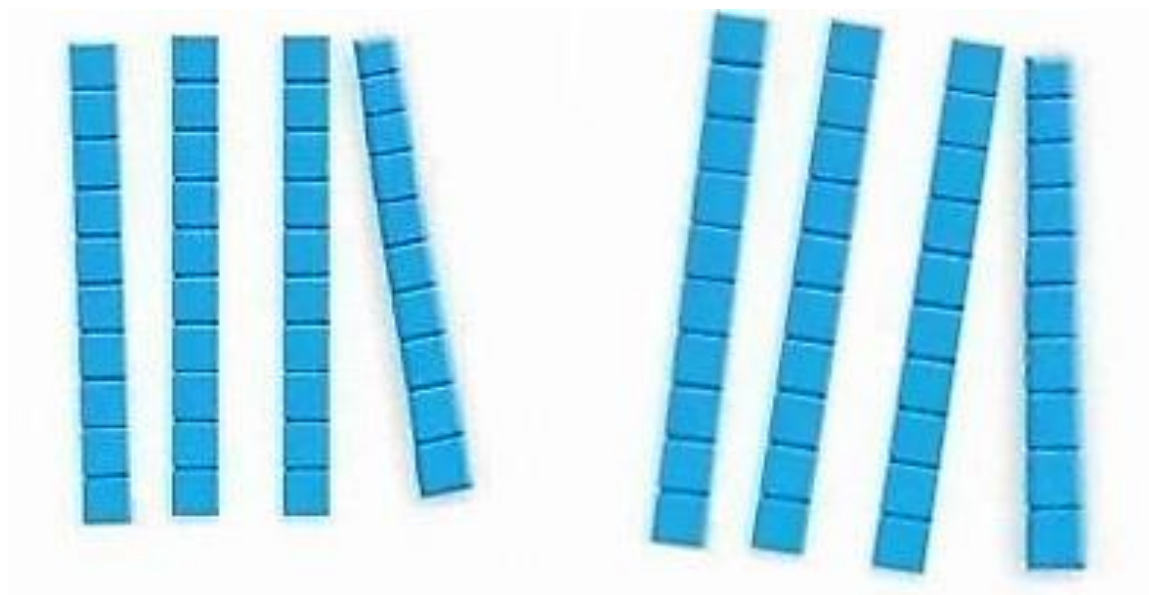

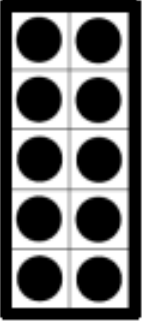
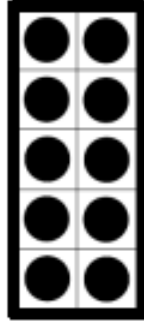
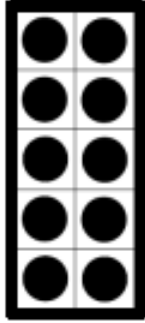
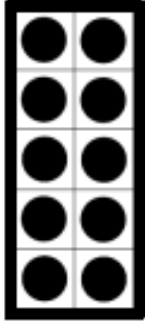
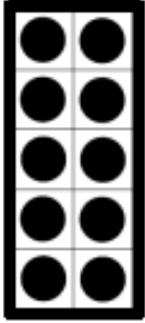
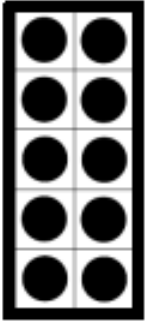
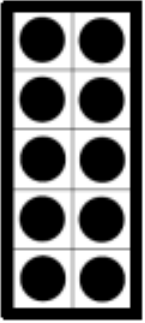



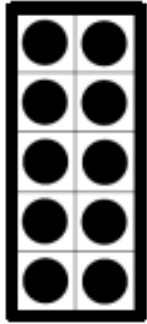
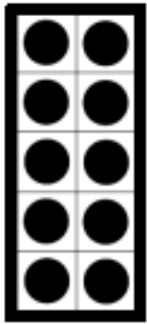
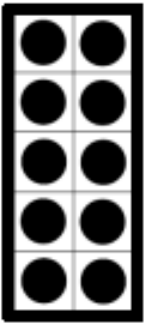
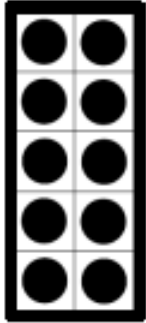
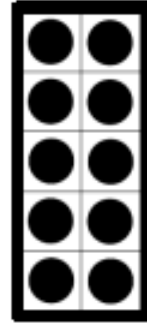
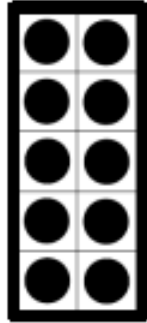
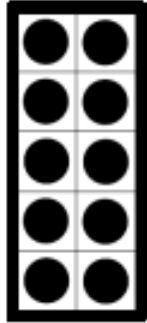
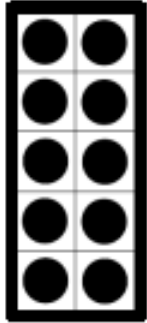
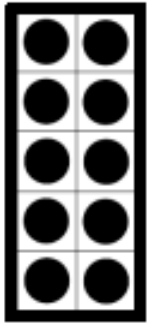
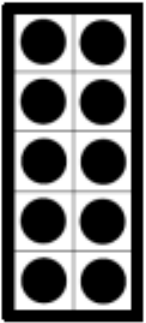

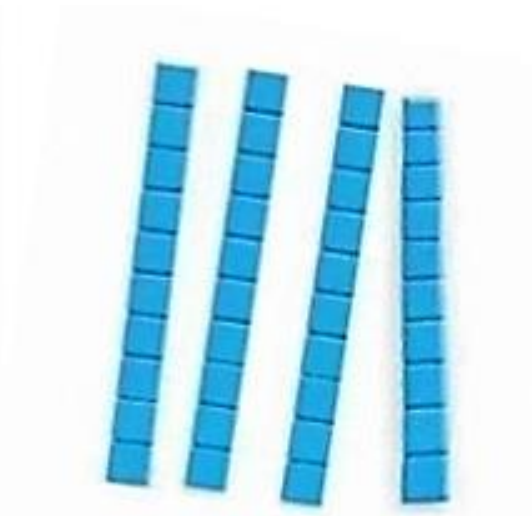
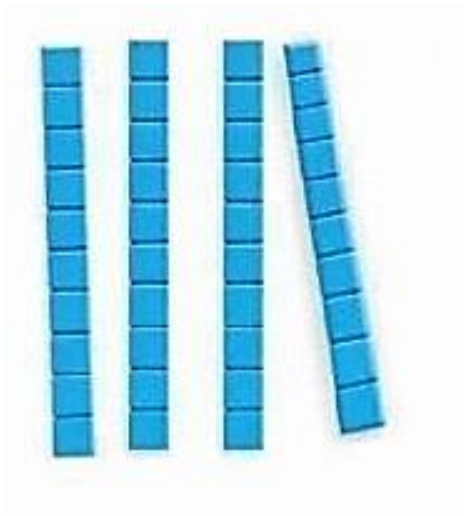

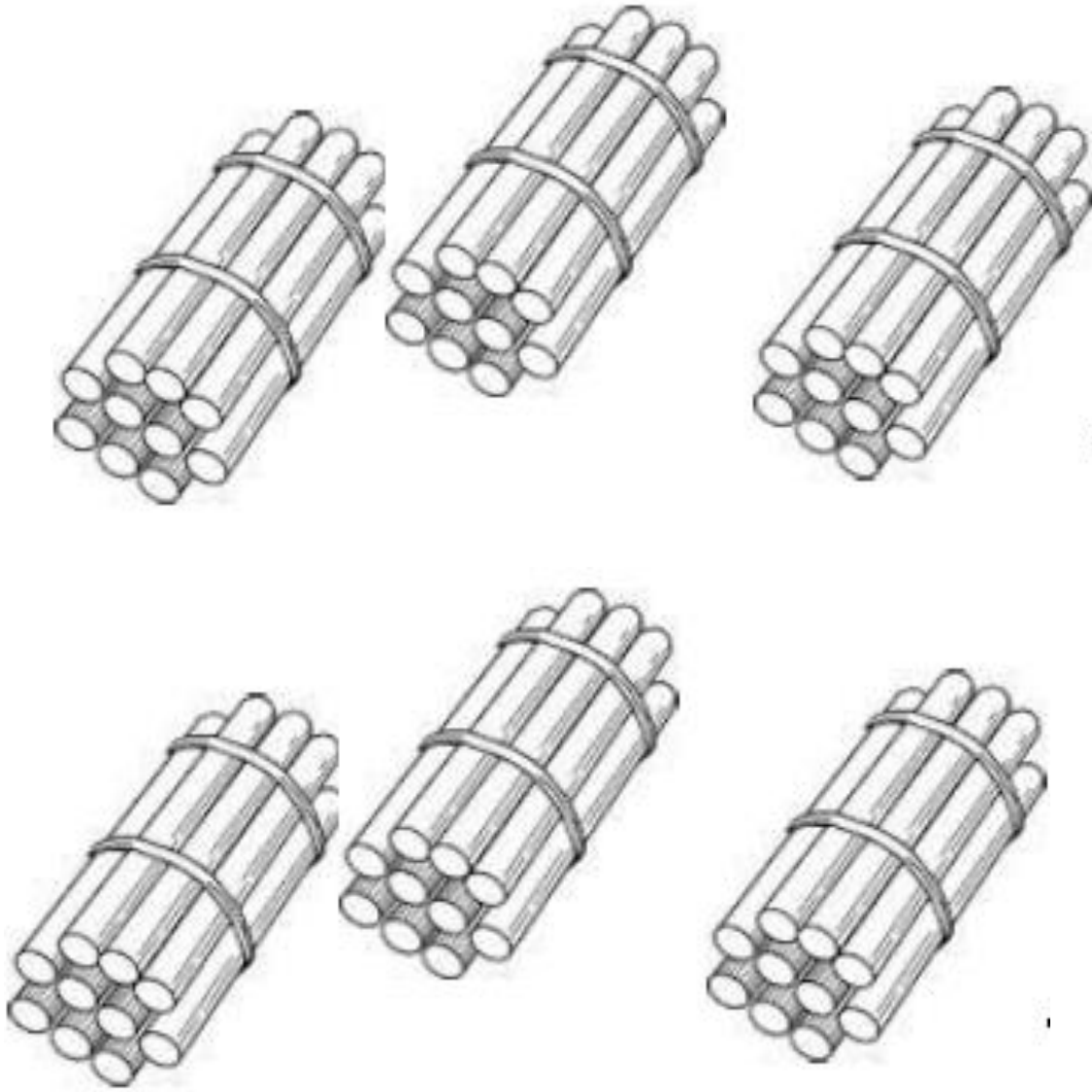

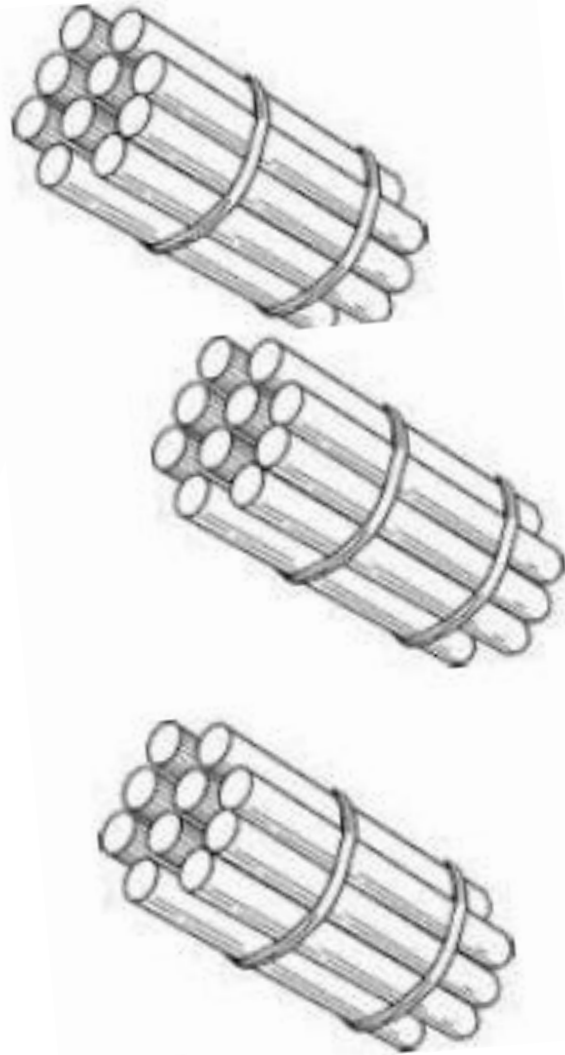
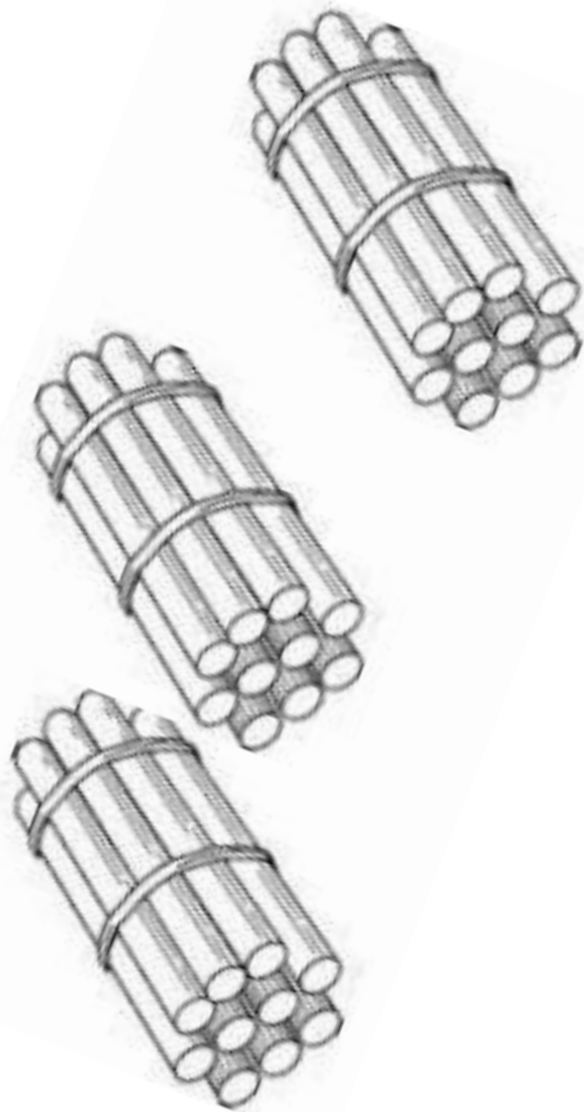
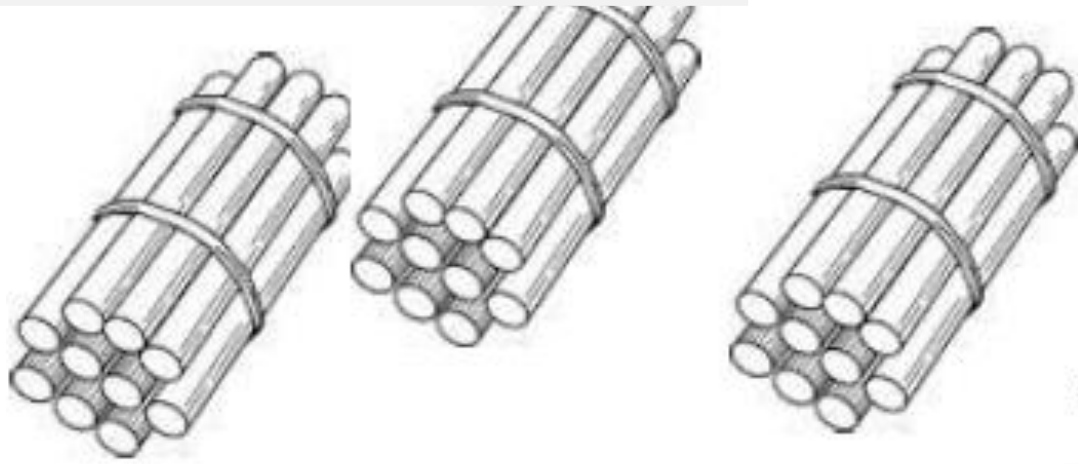

# Counting By Tens Off Decade Level B up to 90



3, \_\_\_\_\_, \_\_\_\_\_, \_\_\_\_\_, \_\_\_\_\_,



3, 13 23, 33, 43,



5, \_\_\_\_\_, \_\_\_\_\_, \_\_\_\_\_, \_\_\_\_\_,



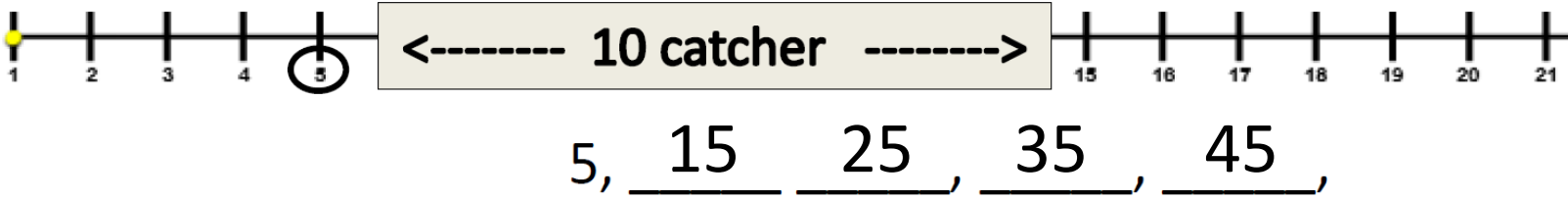

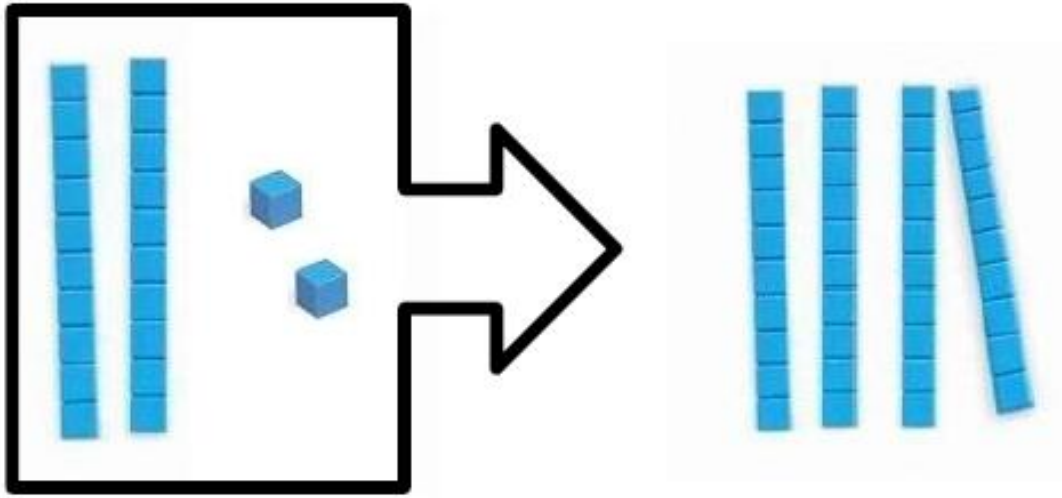

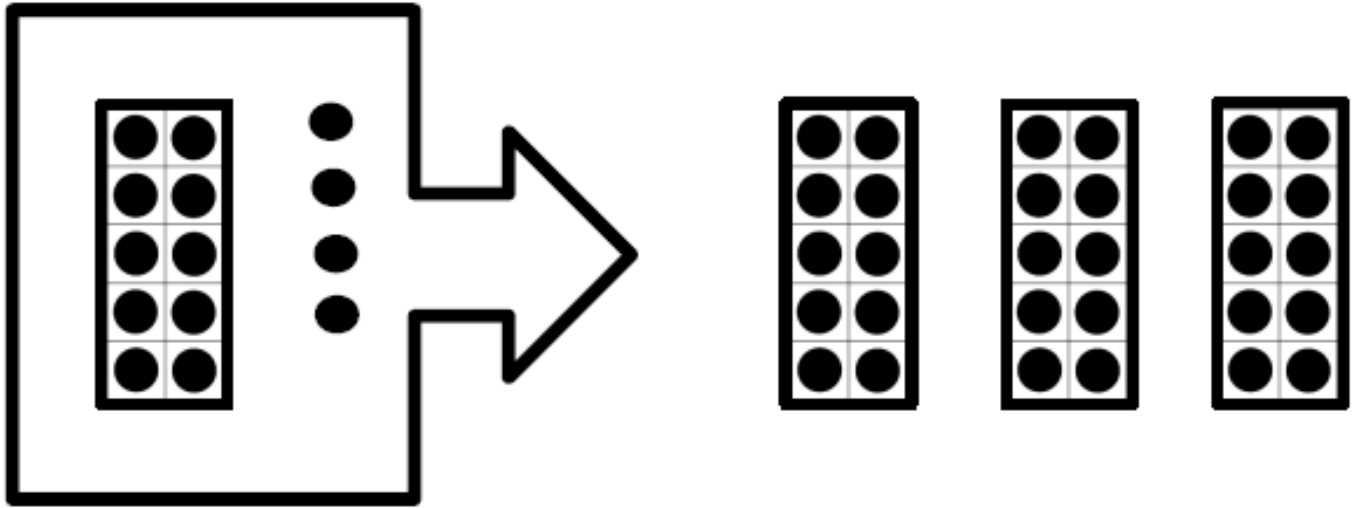

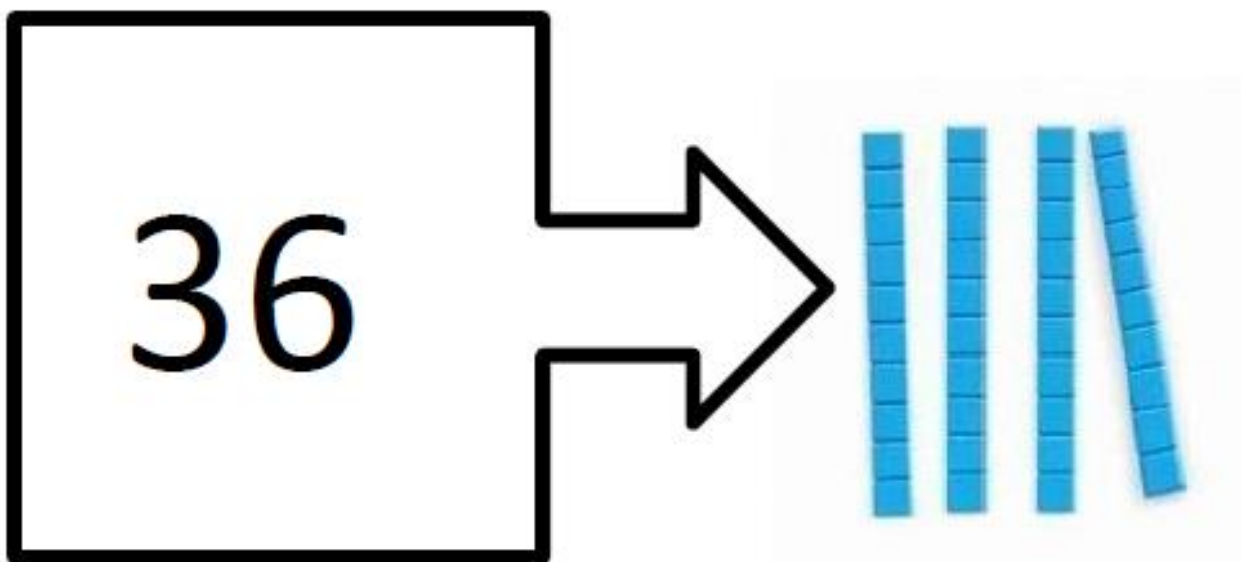

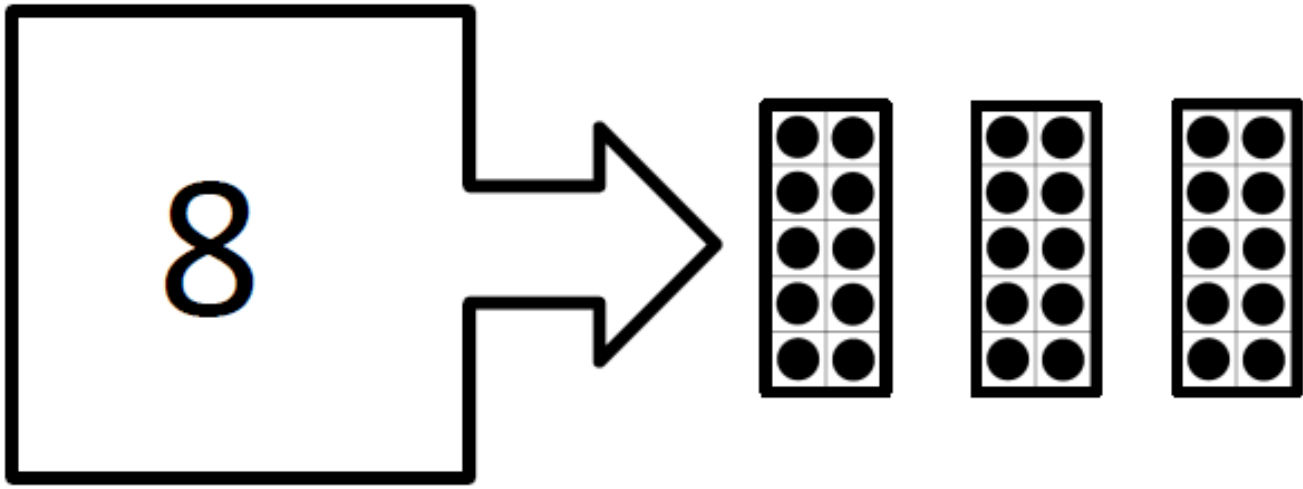

5		25				65			
---	--	----	--	--	--	----	--	--	--

5	15	25	35	45	55	65	75	85	95
---	----	----	----	----	----	----	----	----	----

4			34		54		74		94
---	--	--	----	--	----	--	----	--	----



4	14	24	34	44	54	64	74	84	94
---	----	----	----	----	----	----	----	----	----

9									
---	--	--	--	--	--	--	--	--	--

								89	
--	--	--	--	--	--	--	--	----	--

9	19	29	39	49	59	69	79	89	99
---	----	----	----	----	----	----	----	----	----

# Counting By Tens Off Decade Level C up to 120s



94, \_\_\_\_\_, \_\_\_\_\_, \_\_\_\_\_, \_\_\_\_\_



94, 104 114, 124, 134,

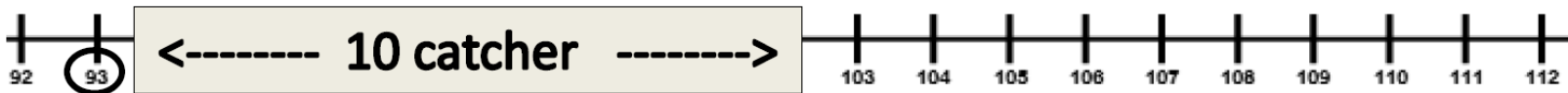

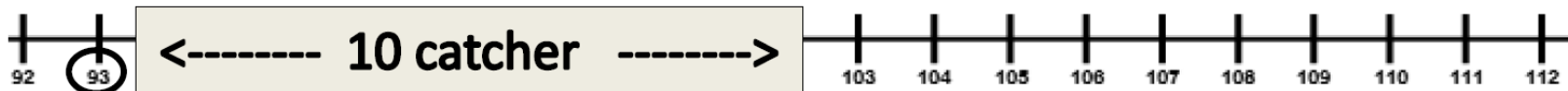

103, 113, 123, 133, 143





105, \_\_\_\_\_, \_\_\_\_\_, \_\_\_\_\_, \_\_\_\_\_



105, 115, 125, 135, 145,

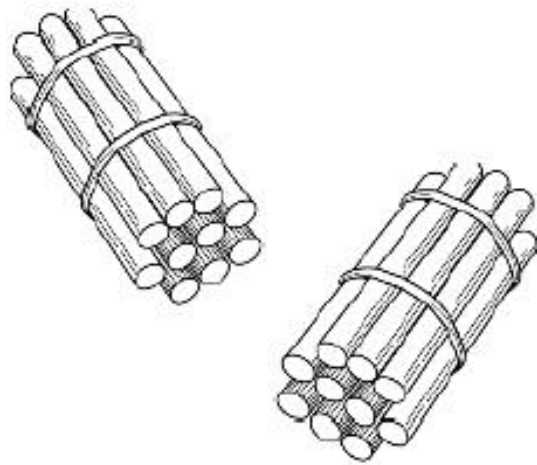

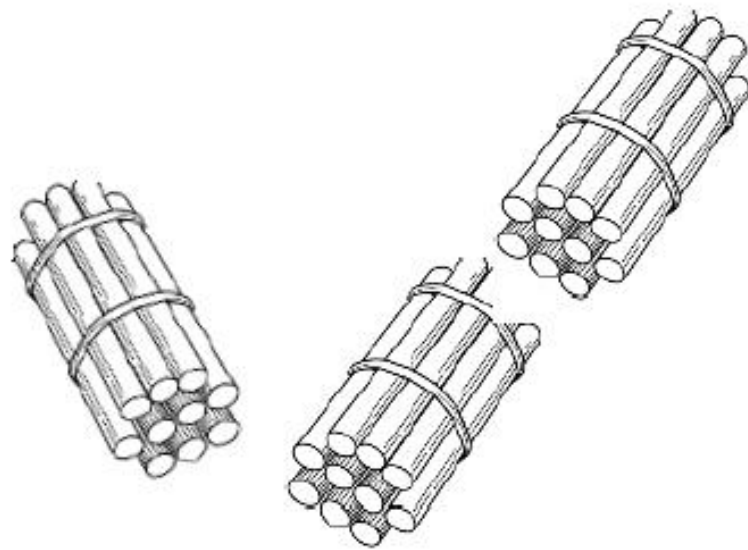

66		86			116	
----	--	----	--	--	-----	--

66

76

86

96

106

116

126

78			108			
----	--	--	-----	--	--	--

78

88

98

108

118

128

138



51		71			101	
----	--	----	--	--	-----	--

51

61

71

81

91

101

111

# Counting By Tens Off Decade

Level D up to 208

Level E up to 1000

140				180		
-----	--	--	--	-----	--	--

140

150

160

170

180

190

200

138			168			
-----	--	--	-----	--	--	--

138

148

158

168

178

188

198

155			185			
-----	--	--	-----	--	--	--



155

165

175

185

195

205

215

			698			
--	--	--	-----	--	--	--

668	678	688	698	708	718	728
-----	-----	-----	-----	-----	-----	-----

		396				
--	--	-----	--	--	--	--

376	386	396	406	416	426	436
-----	-----	-----	-----	-----	-----	-----



# Counting

e - Library 1.0

e-Lessons

Level

# A



Count the Stars (Up to 10)

Number Before Number After

Trace the Number With Your Finger

Count to 10 Forward and Backwards on a Number Line

**Count Counters on 10 or 20 Frame or 10 rack**



**Calculator Count up to 10 or 20**



**Count using Number Line**

1 2 3 4 5 6 7 8 9 10 11 12 13 14 15 16 17 18 19 20

**Sequence Number Cards 1-10 or 10-20**

3	4	7	5	6
---	---	---	---	---

**Number Before & After**

?	12	?
---	----	---

Numeracy Consultants LLC



## Online Practice

## Digital Book

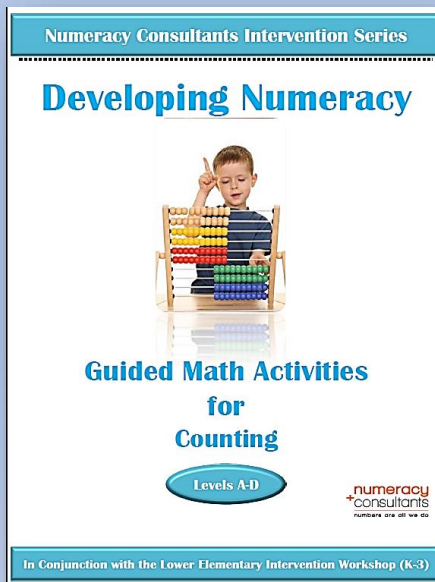

Counting and Matching to 10

Counting to Ten

Ordering and Sequencing to 10

Birthday Candle Counting to 10

Numeral Identification to 10:  
Number Bingo

Count to 10 Video Song



Numeracy Consultants LLC

**numeracy**  
**+ consultants**  
numbers are all we do

# Count to 10 Forward and Backwards on a Number line

1



1

2

1

2

3







1 2 3 4 5 6 7

1

2

3

4

5

6

7

8





1 2 3 4 5 6 7 8 9 10





9 10











4 5 6 7 8 9 10







1 2 3 4 5 6 7 8 9 10

Number Before Number After

What Number Comes Before?

What Number comes After?



6

7

8

What Number Comes Before?

What Number comes After?

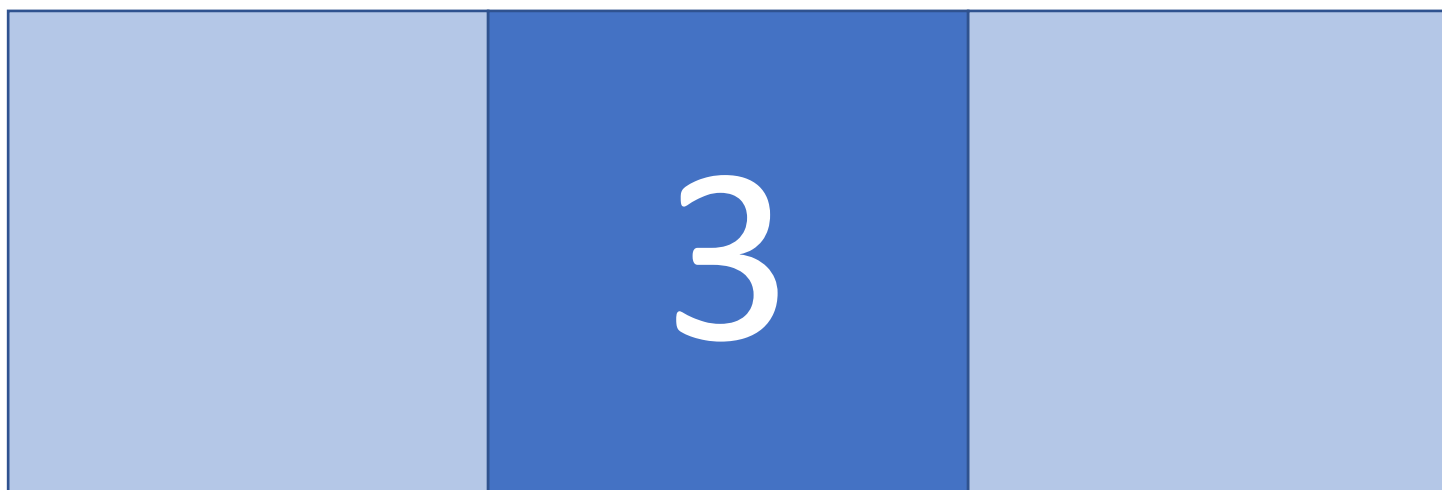

2

3

4



What Number Comes Before?

What Number comes After?

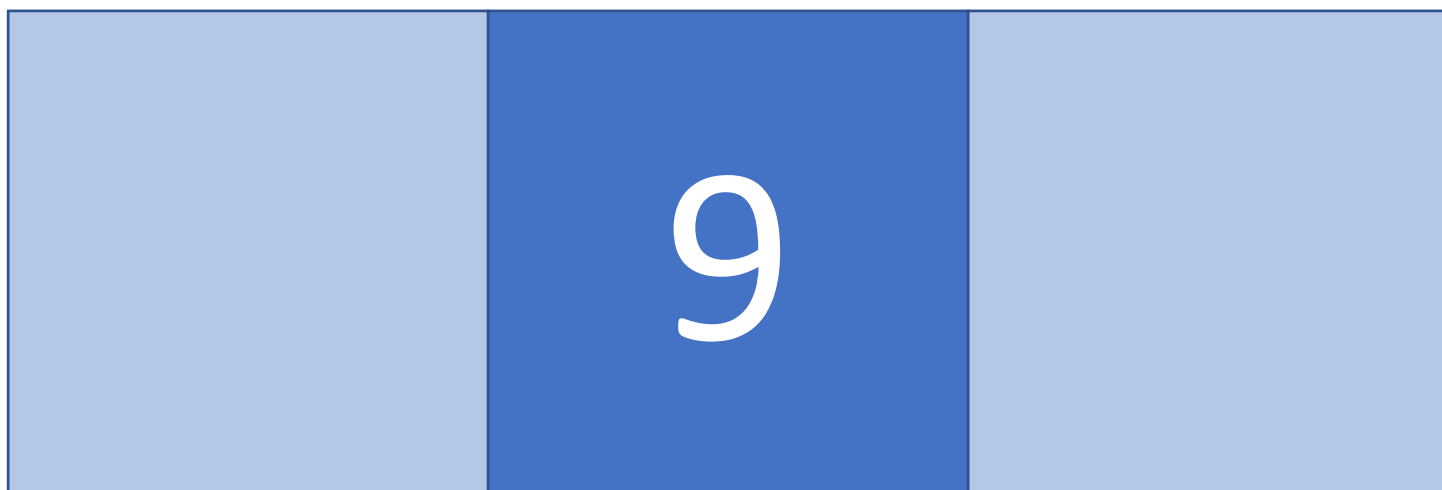

8

9

10

What Number Comes Before?

What Number comes After?

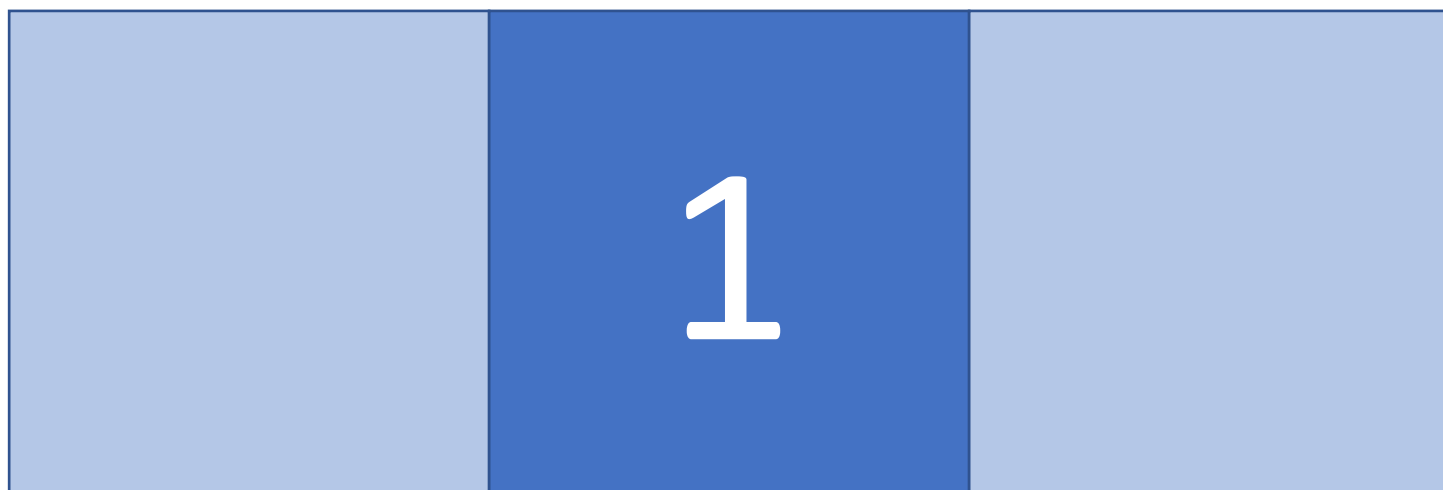

0

1

2

# Count the Stars











Numeracy Consultants LLC













# Trace the Numbers with Your Finger



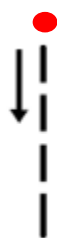





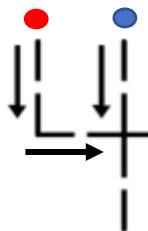

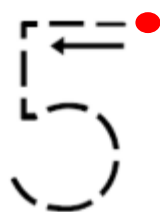



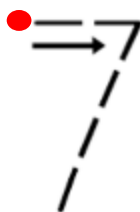





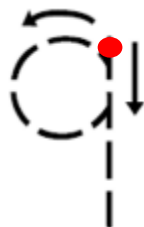

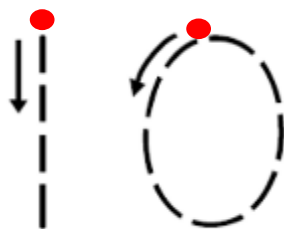



# Counting

e - Library 1.0

e-Lessons

Level

B



Count to 20 Forward and Backwards on a Number Line

Number Before Number After

Count the Objects (Up to 20)

Trace the Number With Your Finger

**Numeracy Specialist Program**  $+\frac{n}{c}$   
 Numeracy Specialization and Intervention K-5  
 CLICK HERE FOR MORE INFORMATION



## Online Practice

Counting to 20

Higher or Lower to 20

Ordering and Sequencing to 20

Find the Number

Numeral Identification to 20:  
Number Bingo

Count to 20 Video Song

Count and Match up to 20

**Count Counters on 10 or 20 Frame or 10 rack**



**Calculator Count up to 10 or 20**



**Count using Number Line**

1 2 3 4 5 6 7 8 9 10 11 12 13 14 15 16 17 18 19 20

**Sequence Number Cards 1-10 or 10-20**

3	4	7	5	6
---	---	---	---	---

**Number Before & After**

?	12	?
---	----	---

## Digital Book

Numeracy Consultants Intervention Series

**Developing Numeracy**



**Guided Math Activities for Counting**

Levels A-D

numeracy consultants numbers are all we do

In Conjunction with the Lower Elementary Intervention Workshop (K-3)

Numeracy Consultants LLC



Numeracy Consultants LLC

**numeracy + consultants**  
numbers are all we do

# Count to 20 Forward and Backwards on a Number line

## Count Forwards



## Count Backwards

Number Before Number After

What Number Comes Before?

What Number comes After?

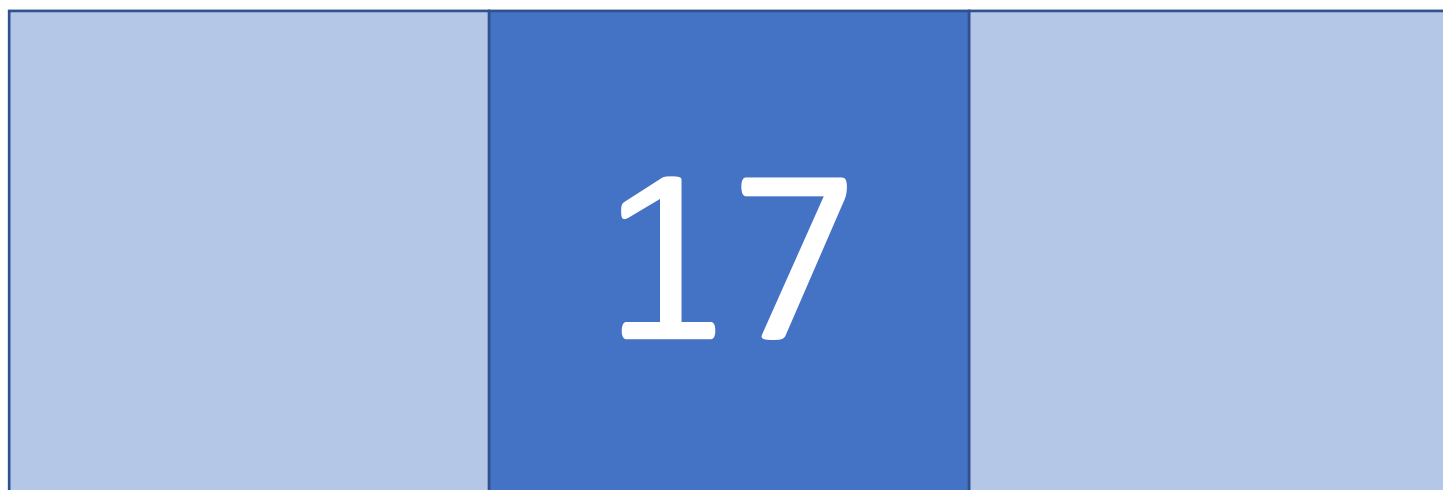

16

17

18



What Number Comes Before?

What Number comes After?



12

13

14

What Number Comes Before?

What Number comes After?

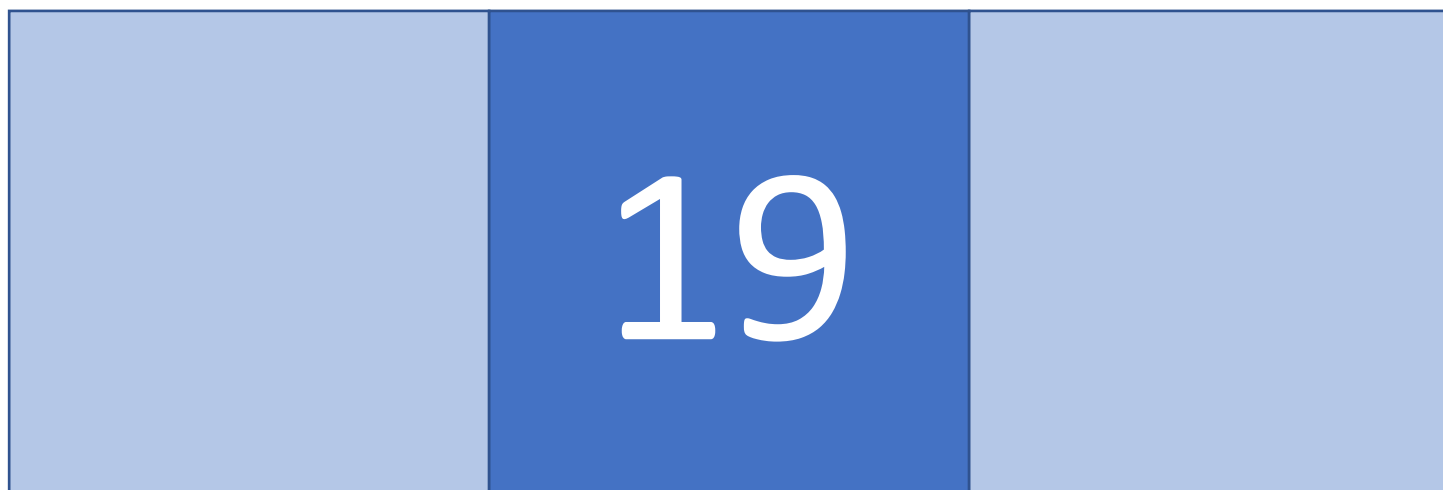

18

19

20

What Number Comes Before?

What Number comes After?



10

11

12



15

14

15

16





20

19

20

21

# Count the Objects

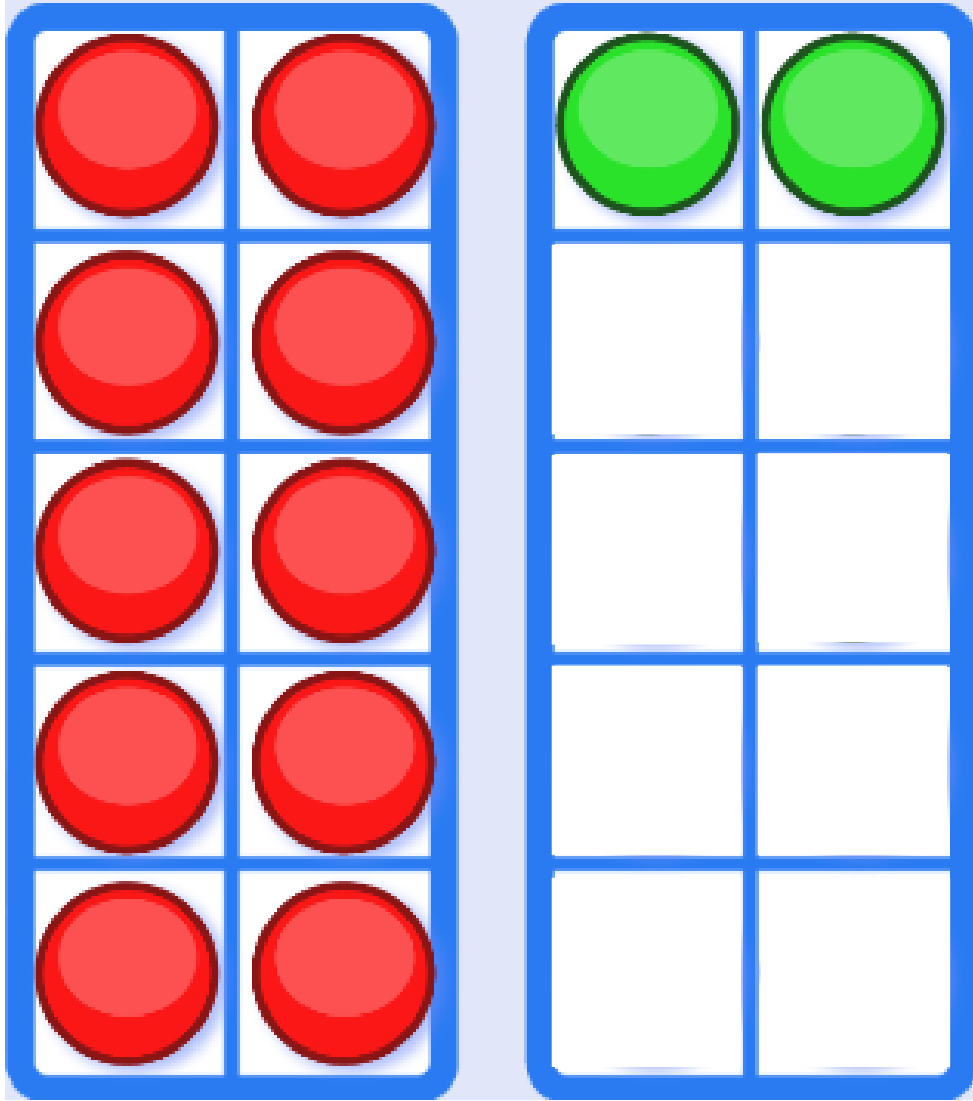

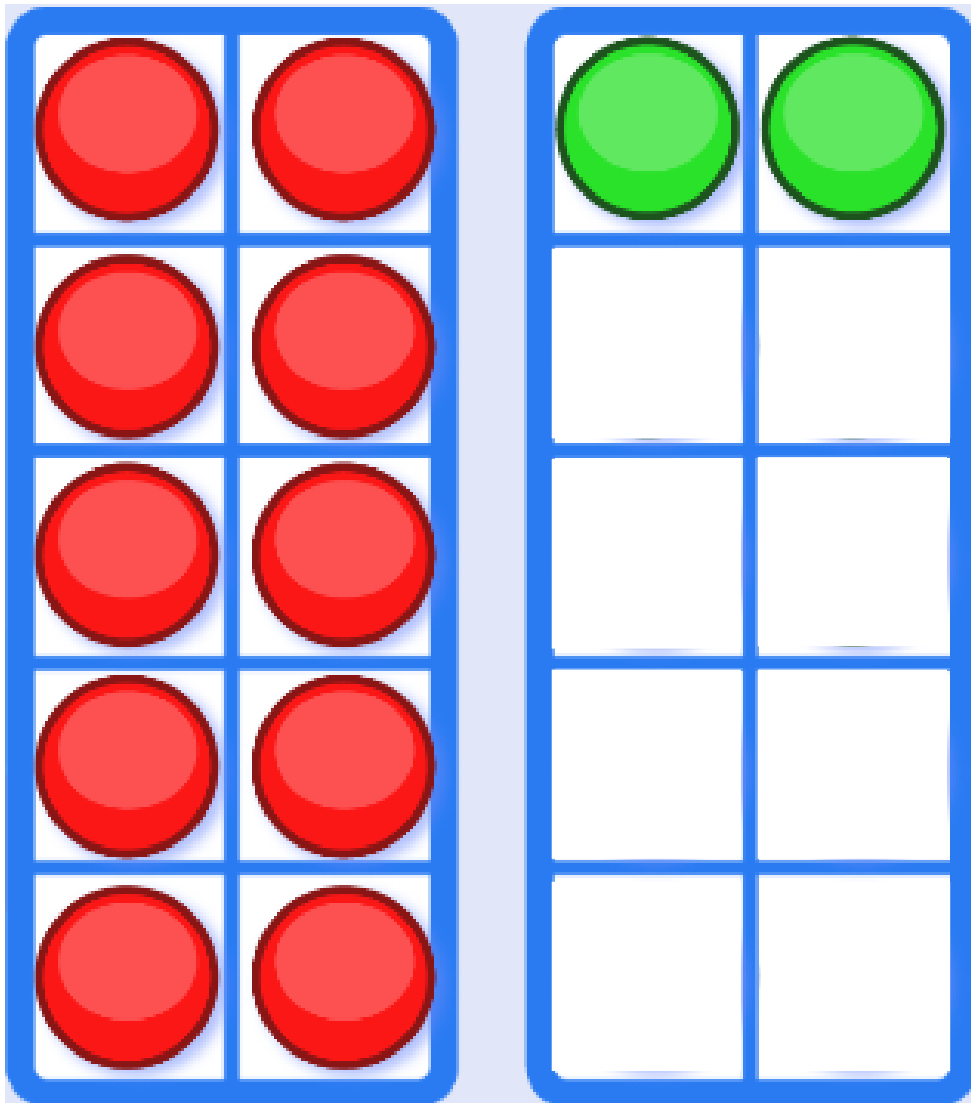

12

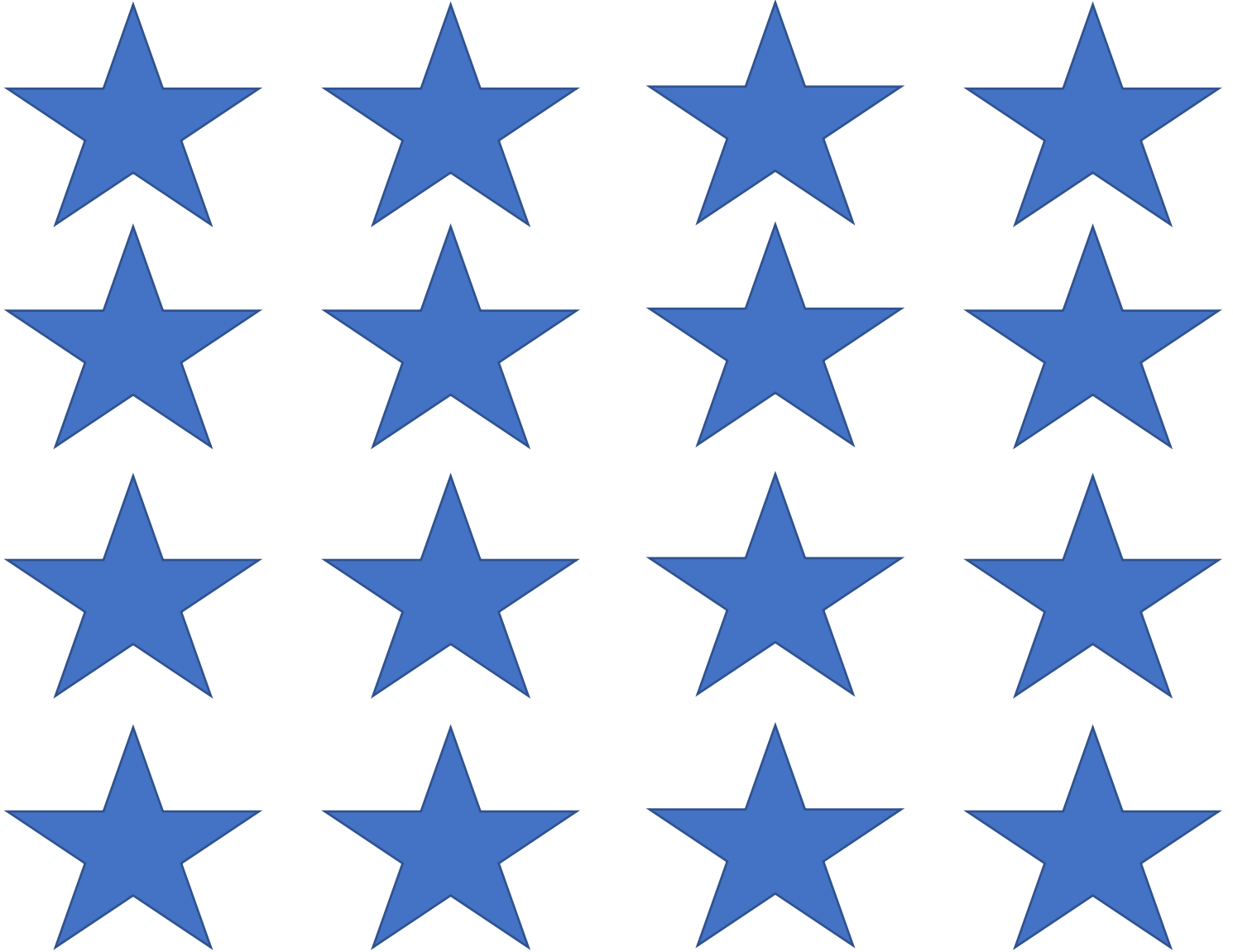

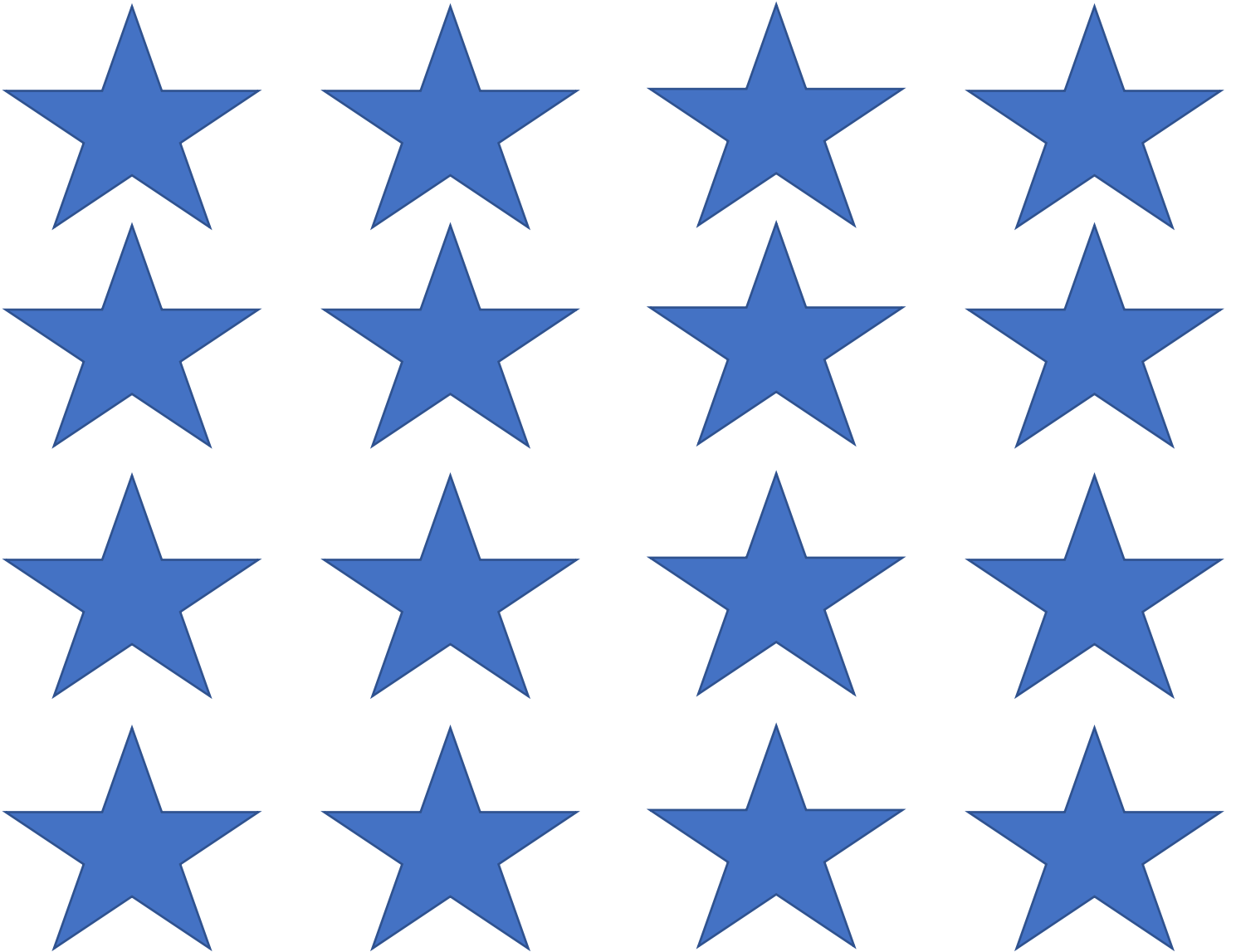

16







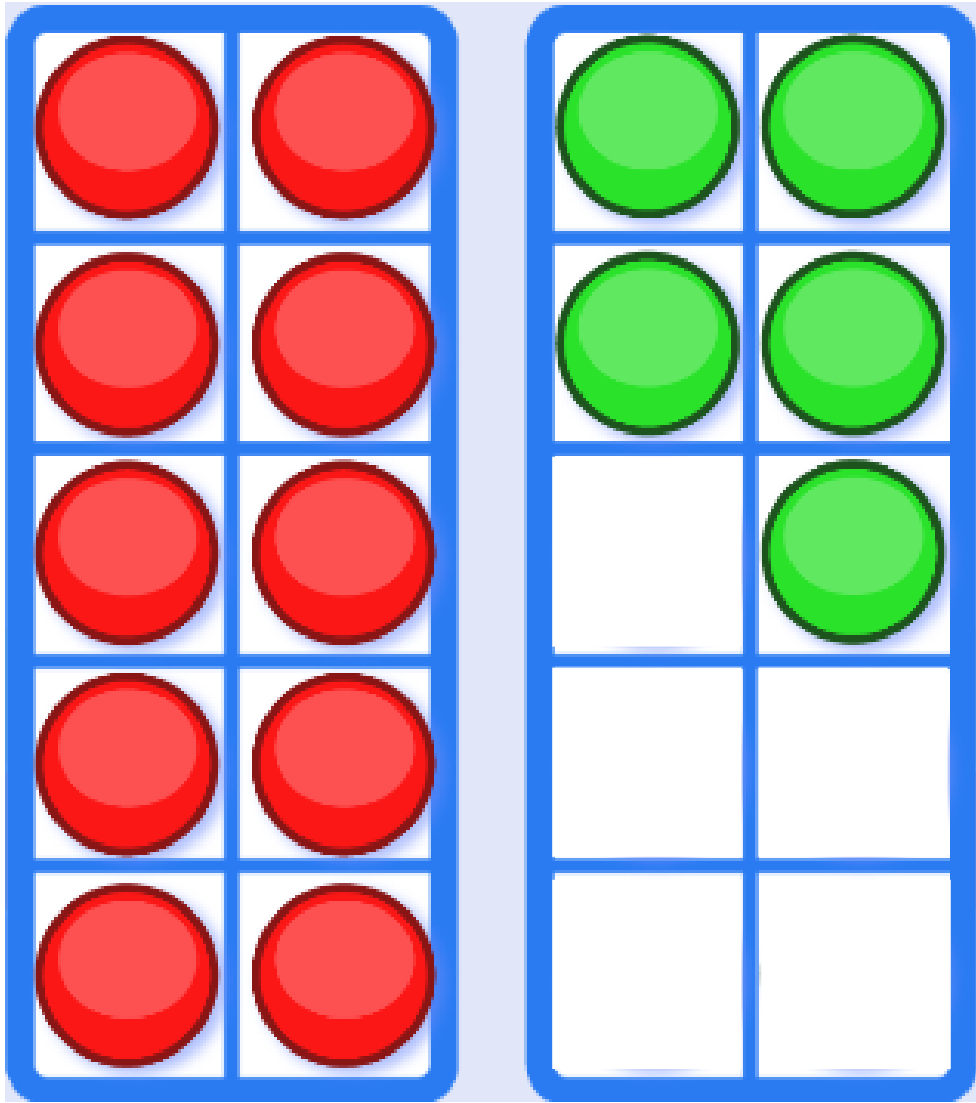

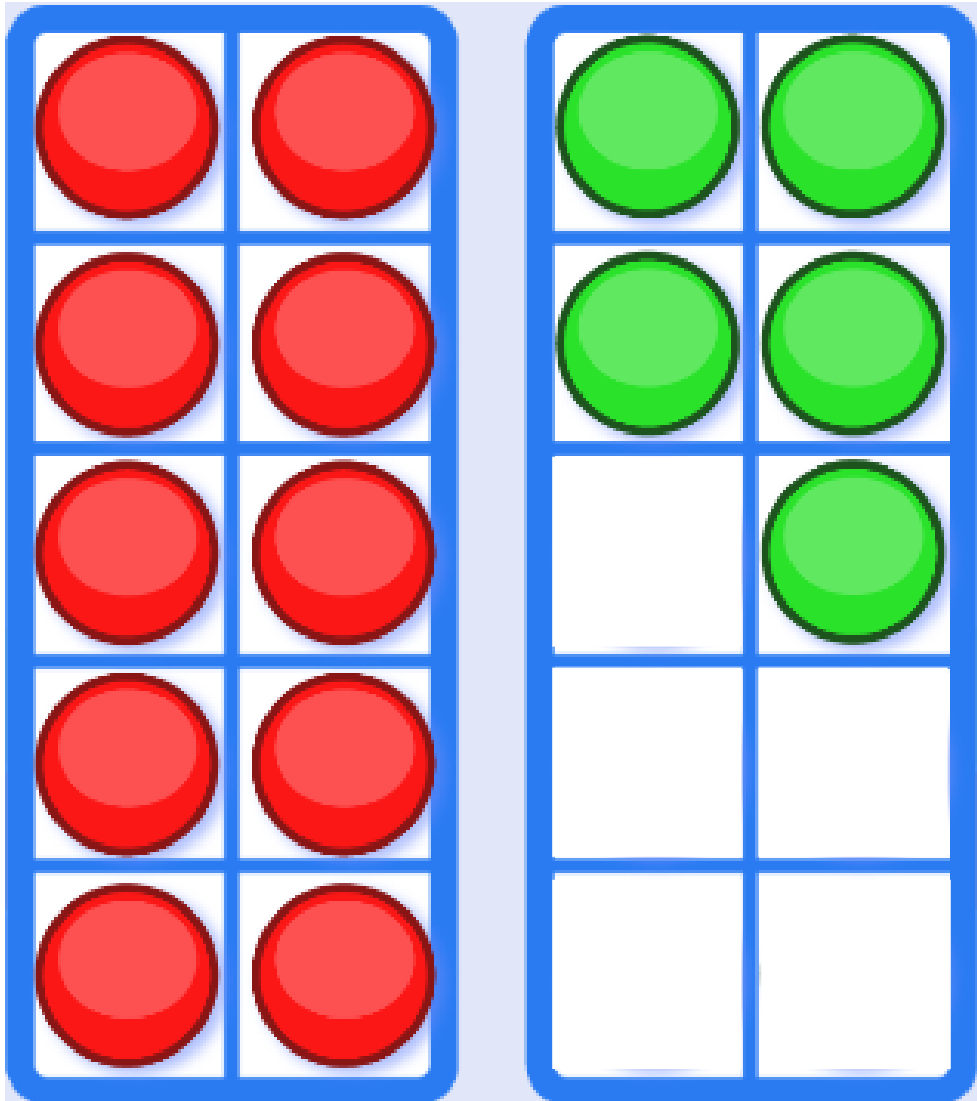

15



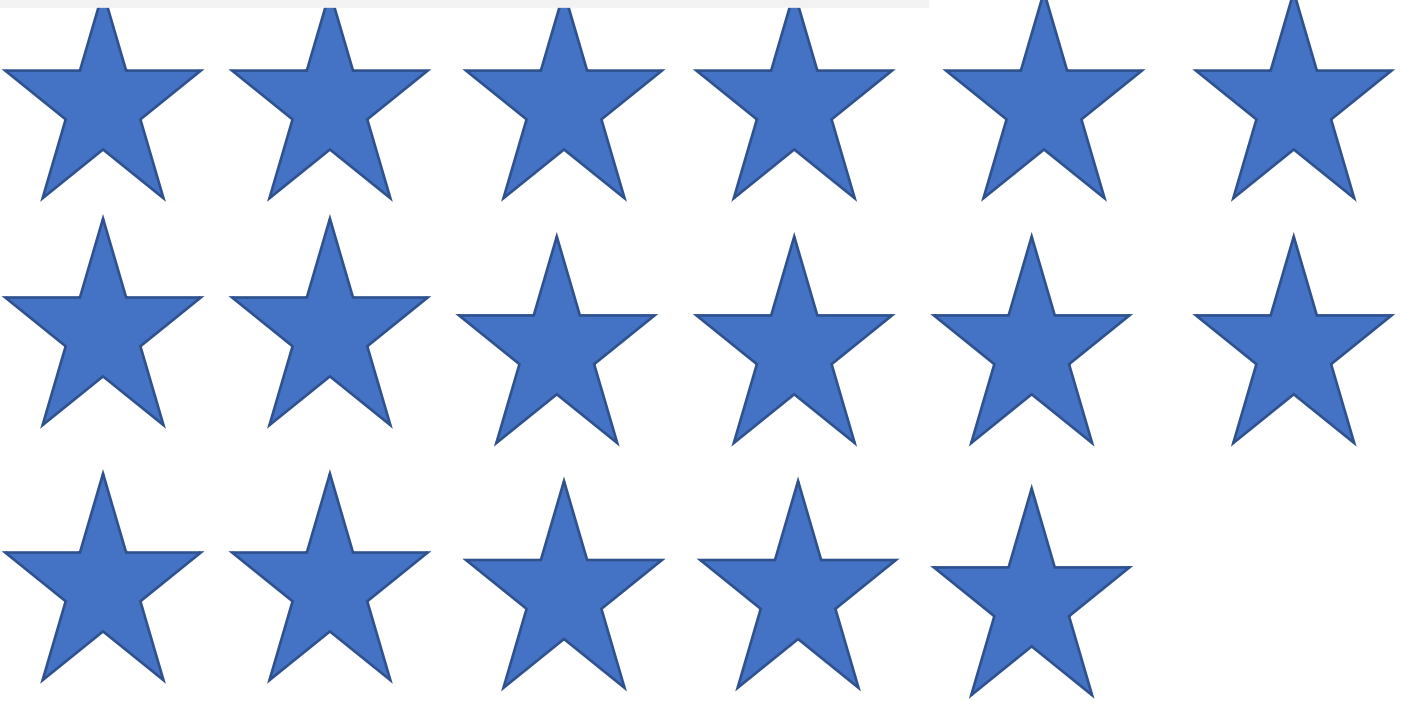

17

# Trace the Number with Your Finger



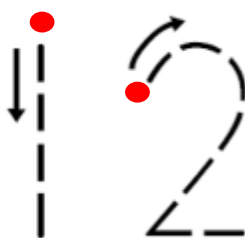



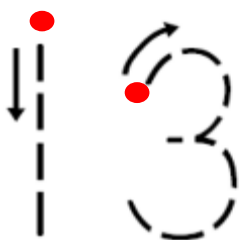

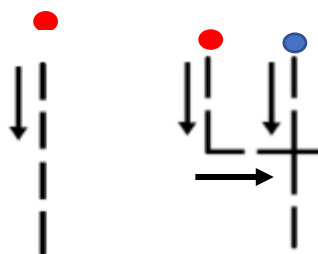

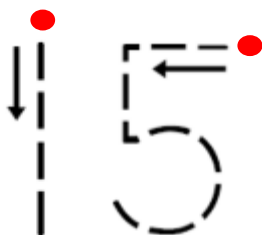

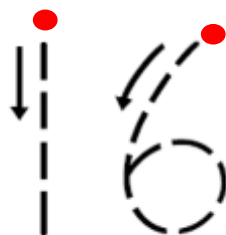

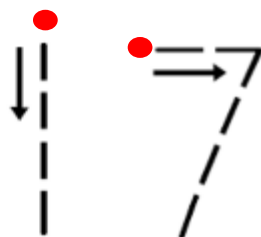

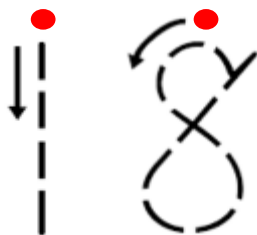

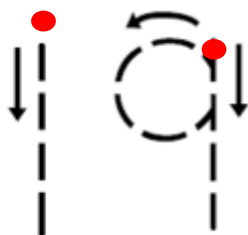

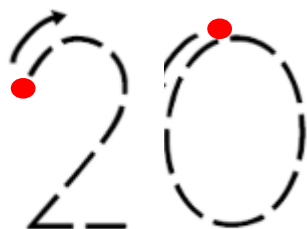





# Counting

e - Library 1.0

e-Lessons

Level **C/E**



Numeracy Consultants LLC

Number Before Number After -  
Level C

Fill in the Missing Number on the  
Number Line - Level C

Fill in the Missing Number on the  
Number Grid - Level C

Number Before Number After -  
Level D

200 Grid - Level D

Number Lines- Level D/E

## Online Practice

Counting on Number line to  
100

Unlimited Number Line

Number Line Battleship

Paint the 100 Grid

100 Grid Fireworks

Sequence up to 1000 +

Find the Number on the  
Number Line

Calculator Count >113



Count using Number Line > 113

110 111 112 113 114 115 116 117 118 119 120 121

Number Cards: Next Number  
"What number comes next"

127

Covered Number Line >113

110 112 113 115 117 118 120 121

Number Before & After

?

147

?

**Numeracy Specialist**  
**Program** <sup>n</sup>/<sub>c</sub>  
 Numeracy Specialization and Intervention K-5  
 CLICK HERE FOR MORE INFORMATION

## Digital Book

Numeracy Consultants Intervention Series

**Developing Numeracy**



**Guided Math Activities**  
for  
**Counting**

Levels A-D

numeracy  
consultants  
numbers are all we do

In Conjunction with the Lower Elementary Intervention Workshop (K-3)



Numeracy Consultants LLC

**numeracy**  
**+ consultants**  
numbers are all we do

# Number Before Number After Level C

What Number Comes Before?

What Number comes After?

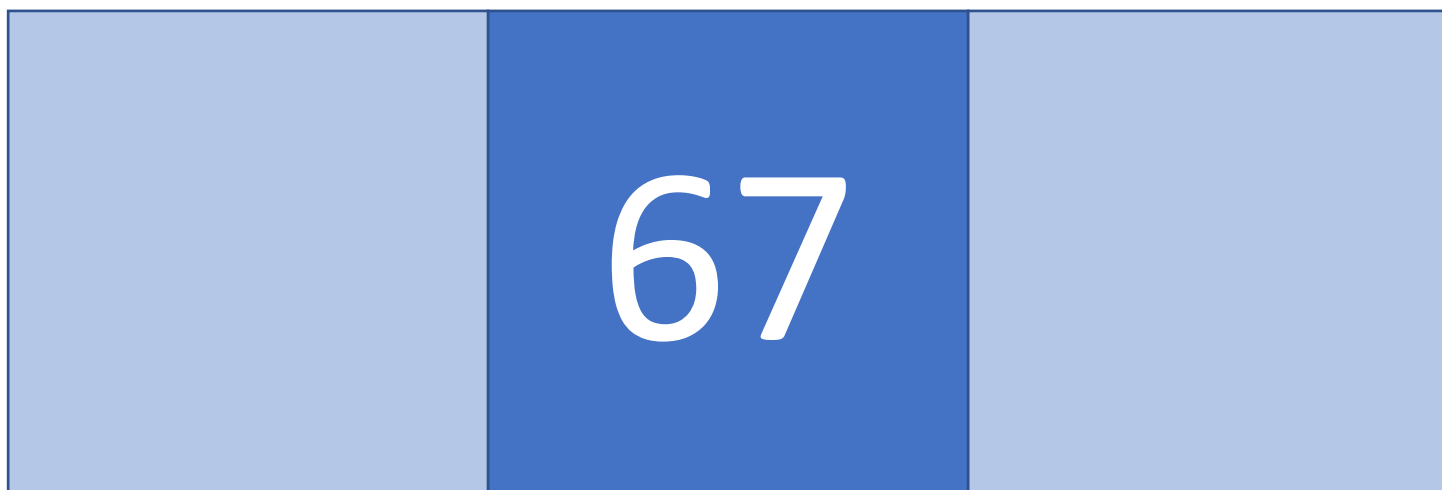

66

67

68

What Number Comes Before?

What Number comes After?

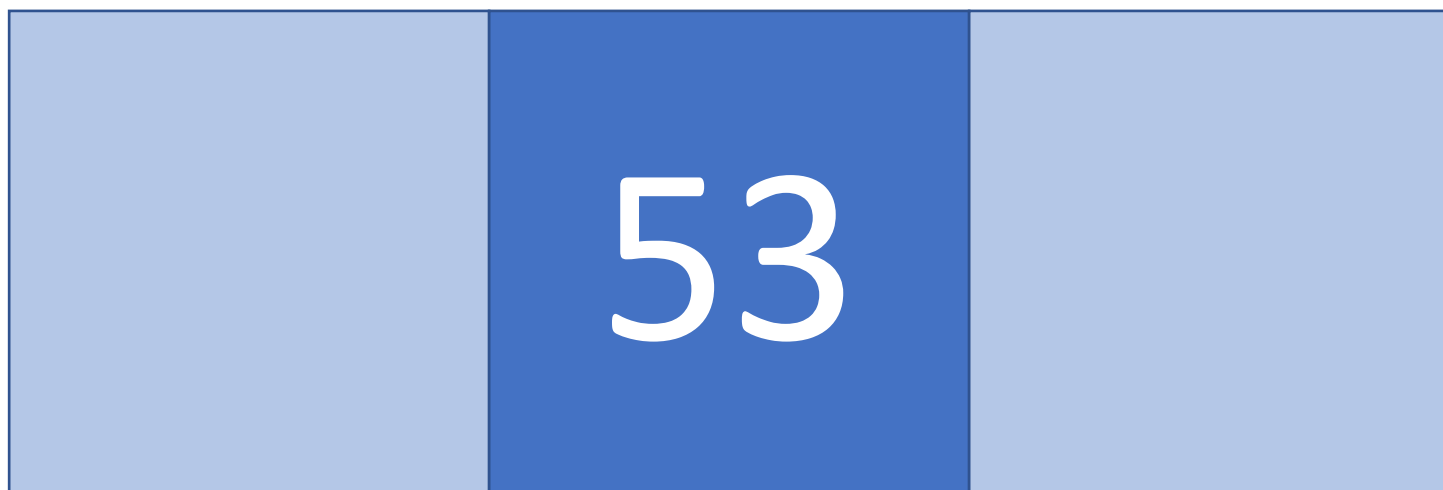

52

53

54

What Number Comes Before?

What Number comes After?

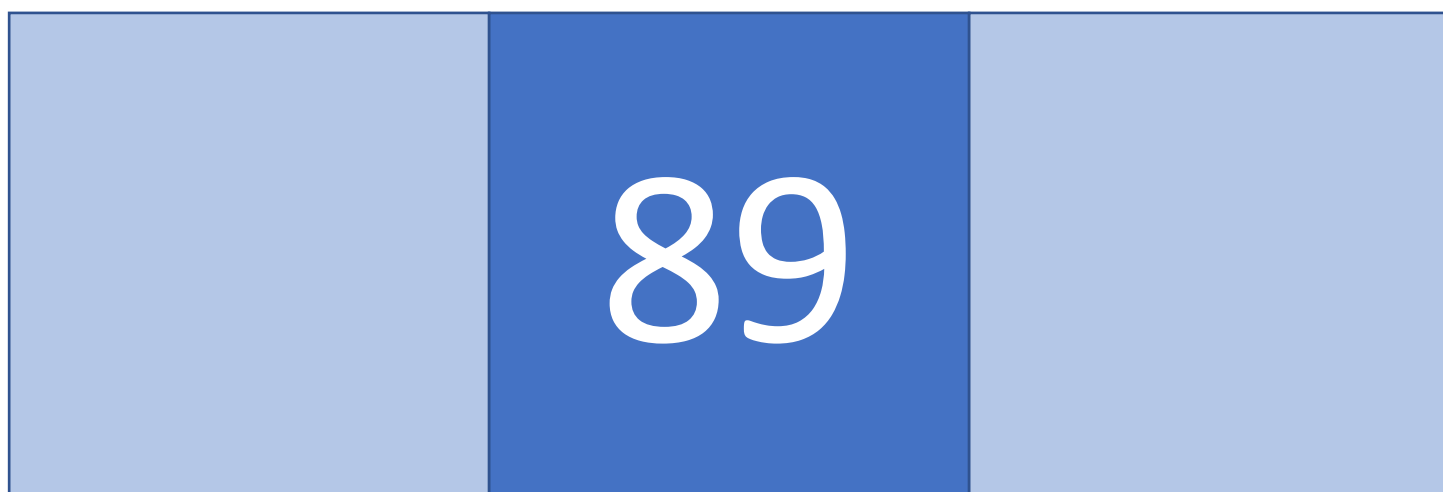

88

89

90



What Number Comes Before?

What Number comes After?

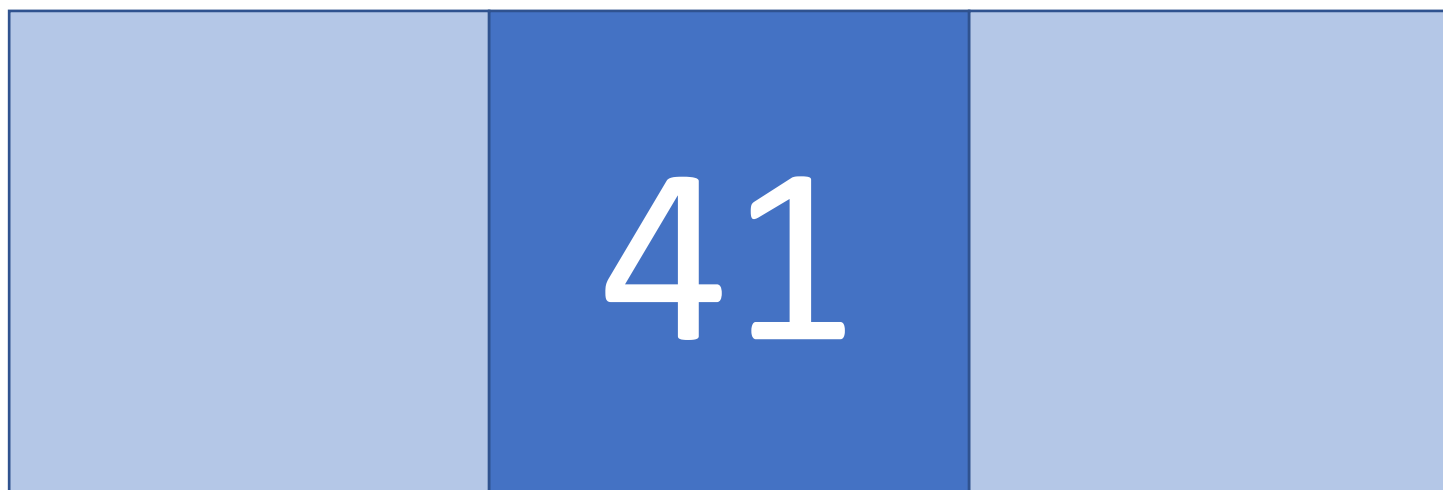

40

41

42



112

111

112

113



102

100

101

102



94

93

94

95



# Number Lines Level C

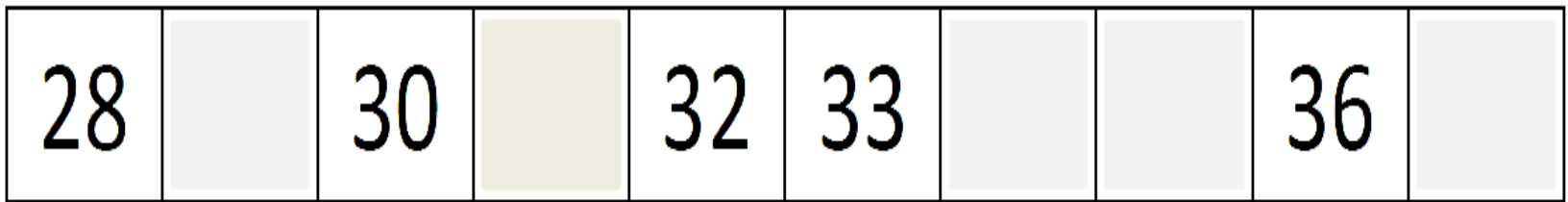

28	29	30	31	32	33	34	35	36	37
----	----	----	----	----	----	----	----	----	----

57

58

61

63

64

66

57	58	59	60	61	62	63	64	65	66
----	----	----	----	----	----	----	----	----	----

46

47

49

51

52

54

45	46	47	48	49	50	51	52	53	54
----	----	----	----	----	----	----	----	----	----

98

99

101

102

104



98

99

**100**

101

102

**103**

104

108

109

111

112

114

108

109

**110**

111

112

**113**

114

1		3		5	6	7		9	10
11	12	13		15	16		18		20
	22		24		26	27	28	29	
31	32	33		35	36	37		39	40
	42		44		46	47	48	49	
51	52	53		55	56		58	59	60
61		63	64	65		67	68	69	
71	72			75	76		78	79	80

1	2	3	4	5	6	7	8	9	10
11	12	13	14	15	16	17	18	19	20
21	22	23	24	25	26	27	28	29	30
31	32	33	34	35	36	37	38	39	40
41	42	43	44	45	46	47	48	49	50
51	52	53	54	55	56	58	58	59	60
61	62	63	64	65	66	67	68	69	70
71	72	72	73	75	76	77	78	79	80

# Number Before Number After Level D



199

198

199

200





201





118

117

118

119



121

120

121

122



209

208

209

210





179

178

179

180

# Number Lines Level D/E

180

183

180

181

182

183

184

185

186

206

209

206

207

208

209

210

211

212

191			194			
-----	--	--	-----	--	--	--



191

192

193

194

195

196

197

			191			
--	--	--	-----	--	--	--

188

189

190

191

192

193

194

			151			
--	--	--	-----	--	--	--

148

149

150

151

152

153

154

				480		
--	--	--	--	-----	--	--

476

477

478

479

480

481

482

			698			
--	--	--	-----	--	--	--



695

696

697

698

699

700

701

			785			
--	--	--	-----	--	--	--

[782](#)

[783](#)

[784](#)

[785](#)

[786](#)

[787](#)

[788](#)

	102	103	104		106	107		109	110
111	112		114	115	116	117	118	119	120
121	122	123	124	125		127	128	129	
	132	133	134	135	136	137	138	139	140
141		143	144		146	147	148	149	150
151	152	153	154	155	156	157		159	
161	162		164		166	167	168	169	170
171	172	173	174	175	176	177		179	180
	182	183	184	185		187	188	189	190
191	192		194	195	196	197	198	199	

101	102	103	104	105	106	107	108	109	110
111	112	113	114	115	116	117	118	119	120
121	122	123	124	125	126	127	128	129	130
131	132	133	134	135	136	137	138	139	140
141	142	143	144	145	146	147	148	149	150
151	152	153	154	155	156	157	158	159	160
161	162	163	164	165	166	167	168	169	170
171	172	173	174	175	176	177	178	179	180
181	182	183	184	185	186	187	188	189	190
191	192	193	194	195	196	197	198	199	200