

## Base Easy Reach

### ASSEMBLY INSTRUCTIONS

#### Getting started:

prepare a protection layer, a screwdriver

STEP 1: Joint right side panel with right back panel

STEP 2: Fix the bottom panel on

STEP 3: Joint right side panel with right back panel

STEP 4: Attach toe-kick on

STEP 5: turn the carcass stand

STEP 6: Attach face frame(long and short), then screw up

STEP 7: Attach top panel using screw

STEP 8: Insert back panel through the groove





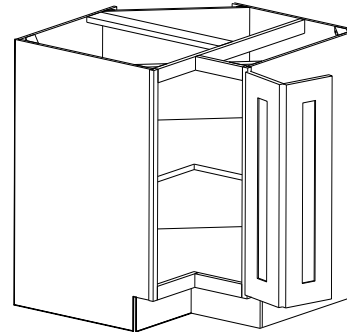

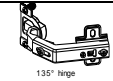

STEP 9: Install the wood block corner

STEP 10: Hinge the door onto the face frame and adjust the cover-space

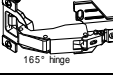
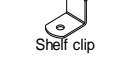

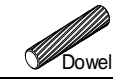
PARTS LIST		
NO.	Description	QTY
A	SIDE PANEL	2
B	BACK PANEL	2
C	TOP&BOTTOM PANEL	1
D	TOE KICK	1
E	TOE KICK	1
F	FACE FRAME	1
G	FACE FRAME	1
H	CONNECT STRIP	1
I	BACK PANEL	1
J	ADJUSTABLE SHELF	1
K	CABINETS DOOR	2

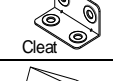
#### HARDWARE LIST

NO.	Description	QTY	PICTURE
11	135 DEGREE HINGE	2	
10	3/4" ROUND HEAD SCREW	8	
9	BUMPER	4	
8	165 DEGREE HINGE	2	
7	SHELF CLIP	6	
6	9/16" ROUND HEAD SCREW	72	
5	DOWEL	6	
4	1" FLAT HEAD SCREW FOR CARCASS	11	
3	CLEAT	18	
2	WOOD BLOCK	4	
1	1" FLAT HEAD SCREW FOR WOOD BLOCK	8	

