

Diagonal Corner Wall Cabinet

ASSEMBLY INSTRUCTIONS

Getting started:

prepare a protection layer, a screwdriver

STEP 1: Joint side panel with front face frame

STEP 2: Attach top panel with front face frame and side panel

STEP 3: Attach top panel with front face frame and side panel

STEP 4: Attach back panel on side panel





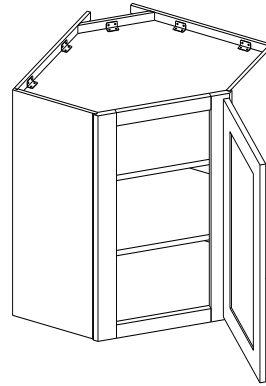

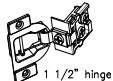

STEP 5: Insert back panel through groove, then screw up

STEP 6: Hing door on to front face frame and adjust the cover-space



PARTS LIST		
NO.	Description	QTY
A	FACE FRAME	1
B	SIDE PANEL	2
C	TOP&BOTTOM PANEL	2
D	BACK PANEL	2
E	BACK PANEL	1
F	ADJUSTABLE SHELF	2
G	CABINETS DOOR	1

HARDWARE LIST

NO.	Description	QTY	PICTURE
8	1 1/2" SOFTCLOSE HINGE	2	
7	3/4" ROUND HEAD SCREW	2	
6	BUMPER	2	
5	SHELF CLIP	10	
4	9/16" ROUND HEAD SCREW	92	
3	CLEAT	22	
2	1" FLAT HEAD SCREW FOR CARCASS	6	
1	135 DEGREE ANGLE	2	

STEP:1

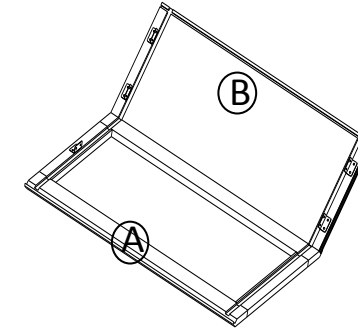

STEP:2

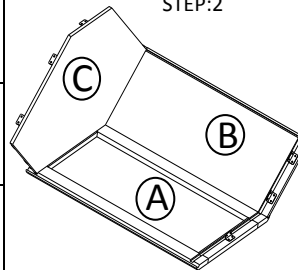

STEP:3

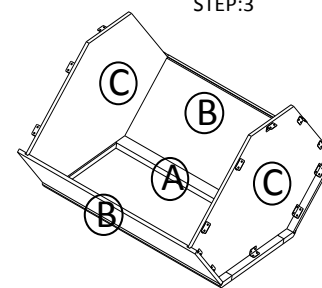

STEP:4

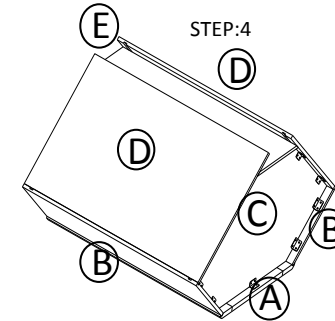

STEP:5

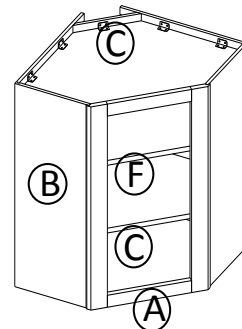

STEP:6

