

## Single Door/Single Drawer Base Cabinet

### ASSEMBLY INSTRUCTIONS

Getting started:

prepare a protection layer, a screwdriver

STEP 1: Joint side panel with back panel

STEP 2: Joint bottom panel with side panel

STEP 3: Joint side panel with bottom & back panel











STEP 4: Attach frame on and toe kick board

STEP 5: Joint the drawer together, then install the drawer guide.

STEP 6: Attach the wood block on the top corner, and put on the adjustable shelf

STEP 7: Fix drawer head on the drawer front and fix door onto the frame and adjust the cover-space

### HARDWARE LIST

NO.	Description	QTY	PICTURE
11	1 1/2" SOFTCLOSE HINGE	2	
10	3/4" ROUND HEAD SCREW	2	
9	BUMPER	6	
8	1" ROUND HEAD SCREW	4	
7	Selfclose slider	1	
6	SHELF CLIP	4	
5	9/16" ROUND HEAD SCREW	40	
4	CLEAT	10	
3	1" FLAT HEAD SCREW FOR CARCASS	2	
2	WOOD BLOCK	4	
1	1" FLAT HEAD SCREW FOR WOOD BLOCK	8	

PARTS LIST		
NO.	Description	QTY
A	BACK PANEL	1
B	SIDE PANEL	2
C	TOP&BOTTOM PANEL	1
D	TOE KICK	1
E	FACE FRAME	1
F	DRAWER BOX FRONT AND BACK	2
G	DRAWER BOX SIDE	2
H	DRAWER BOX BOTTOM	1
I	ADJUSTABLE SHELF	1
J	DRAWER HEAD	1
K	CABINETS DOOR	1

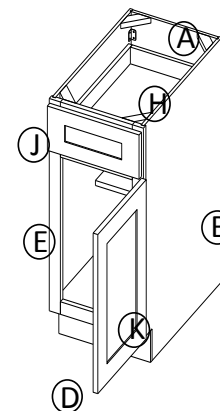
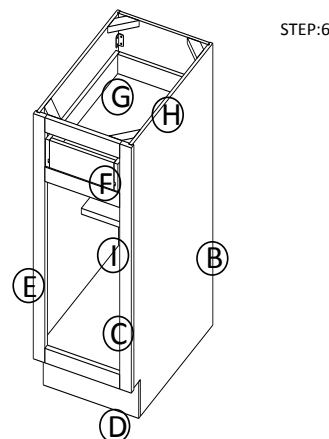
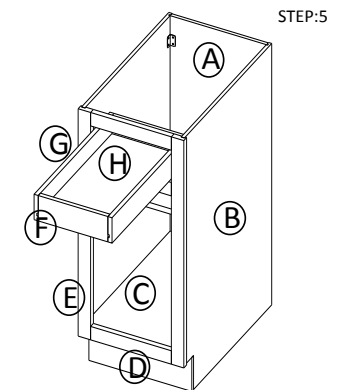
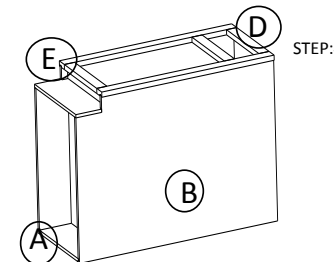
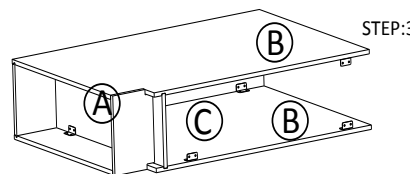
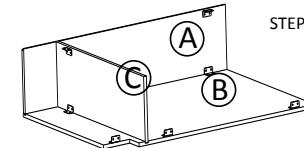
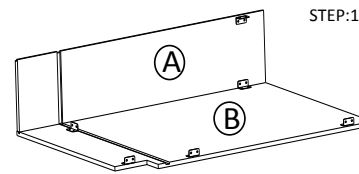
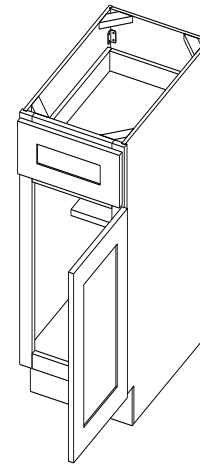

STEP:7

Full extension concealed drawer runners

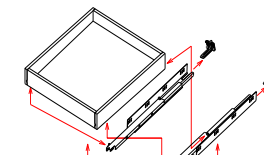

Drawer box  
Locking devices  
Runner profiles  
Rear mounting brackets(for frame applications)

