



**PW628 & DW625
MID RANGE LOADER
OPERATOR'S MANUAL**



LOADER IDENTIFICATION

Below is a quick reference for identifying your Kanga loader, the First letter represents the Fuel type D for Diesel and P for Petrol. The next letter represents wheeled, the first number represents the series of your kanga loader and the last 2 numbers indicates the gross horse power.

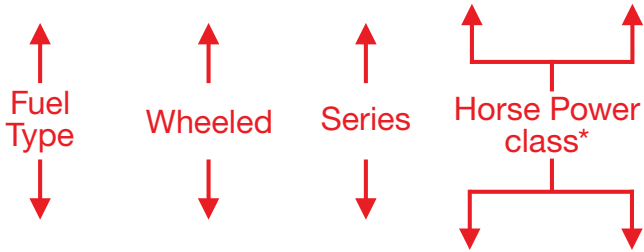

** Net power: the Power rating of the engine indicated in this document is the net power of the production engine only and is measured in accordance with SAE J 1349 at 3600 Rpm, Mass production engines may vary from this value, Actual power output for the engine installed in the final machine May vary depending on numerous factors, including operation speed of the engine in application, environmental conditions and other variables.*

Proprietary Statement

© Copyright 2019 Kanga Loaders Global Pty Ltd. All rights reserved. No part of this publication may be reproduced, photocopied, stored on a retrieval system, or transmitted without the express prior written consent of the publisher.

Disclaimer

While all care has been taken in the development of this product, no loss of any kind is accepted by Kanga Loaders Global Pty Ltd or its agents arising from the use of this document.

Kanga Loaders Global Pty Ltd makes no representations or warranties with respect to the contents of this document, and specifically disclaims any express or implied warranties or fitness for any particular purpose. Furthermore, Kanga Loaders Global Pty Ltd reserves the right to revise this publication and to make changes to its contents, at any time, without obligation to notify any person or entity of such revisions or changes.

Trademarks

KANGA LOADERS GLOBAL PTY LTD (ACN 087 977 660, ABN 14 087 977 660) 2019 ('we', 'us', 'our')
™ Trade mark of Kanga Loaders Global Proprietary Limited.

® Australia Registered trade marks include the Kangaroo logo, stylised 'Kanga Loaders', Kanga Kid, Earth Power, and ™Business on a Trailer.

© Kanga Loaders Global Pty Ltd

1 Copyright

1.1 This document, its contents, kangaloader.com, the material on kangaloader.com, the software, design, text and graphics comprised in kangaloader.com and the selection and layout of kangaloader.com are owned or licensed by us and protected by copyright under the laws of Australia and other countries.

1.2 You may view this document and our website and save an electronic copy of the website solely for the usual operation of your web browser visiting the site.

1.3 You must not otherwise reproduce, transmit (including broadcast), adapt, distribute, sell, modify or publish or otherwise use any of the material on this document or our website, including audio and video excerpts, except as permitted by statute or with Kanga Loaders prior written consent.

2 Trade Mark Notice

This document includes registered trade marks and trade marks which are the subject of pending applications or which are otherwise protected by law including, but not limited to the word KANGA LOADERS, and the Kanga Loaders logo. You may not use these trade marks or the names 'Kanga Loaders Global Proprietary Limited', 'Kanga Loaders Australia Pty Ltd', 'Kanga Loaders', or the name of any of our related companies.

3 Framing

You must not frame any of the material appearing on this document or on kangaloader.com except in accordance with the Kanga Loaders Global Pty Ltd Linking and Framing Policy or otherwise in accordance with Kanga Loaders Global prior with written consent.

Patents

Patents Pending US 6397967, 438218 & 10/096997 AU 65424/99, 2006101054
UK 2345046. AU Registered Design 138603

WARRANTY

TERMS AND CONDITIONS

KANGA

- 05 years unlimited warranty - Chassis structure faults.
- 02 years/or 1000 hours warranty - Workmanship & structural faults in arms and tilt assemblies.
- 12 months - All other loader components.

HONDA

- 36 months - Limited engine warranty for motors released after 1/4/10.
- 12 months warranty/or 1000 hours - Engine accessories (fuel, starter & charging system).

KUBOTA

- 24 months/or 2000 hours - Limited engine warranty.
- 12 months warranty/or 1000 hours - Engine accessories (fuel, starter & charging systems).

Purchaser's Responsibilities:

- The purchaser must ensure maintenance & minor adjustments, as detailed in the Operator's Manual and engine manufacturer's Manual, are carried out as per the schedule. If there is a discrepancy between the two, the Service Chart in the Operator's Manual will take precedence.
- The purchaser must notify Kanga Loaders or an authorized Kanga Loader service representative of the need for warranty repair.
- The purchaser must organise, and is financially responsible for the transport of the product to and from the place of warranty repair.

Product Registration:

The **Purchaser** must fill out and return the warranty registration card within 30 days of purchase in order to validate the warranty.

Repairs

Warranty repairs must be carried out by an **authorised Kanga Dealer**.
For details contact Kanga Loaders on 1300 4 KANGA (1300 4 52642).

Battery Warranty- Pro rata

- One to three months - Free replacement.
- Four to twelve months - Pro rata over 12 months.

Exclusions (No Warranty):

- Normal maintenance, servicing, and replacement items such as spark plugs, oil, oil filters, air filter, muffler, tyres, cutting blades and edges, chains, tracks, cables, etc. are not covered by this warranty.
- Any equipment which has been altered, misused, incorrectly assembled, improperly adjusted, neglected, or damaged by accident is not covered by this warranty.
- Service completed by someone other than an authorized Kanga Loader dealer is not covered by this warranty.
- Any attachment not approved by Kanga Loader or any parts that are not genuine Kanga Loader service parts are not covered by this warranty.
- Engines and engine accessories are covered under the terms of the warranty made by the engine manufacturer, and are not covered by this warranty.

The standard engine manufacturers warranty is for 2 years and is subject to their terms and conditions.

Kanga Loaders may from time to time change the design of its products. Nothing contained in this warranty shall be construed as obligating **Kanga Loaders** to incorporate such changes into previously manufactured products nor shall such changes be construed as an admission that previous designs were defective.

LIMITATION OF REMEDY AND DAMAGES

Kanga Loaders liability under this express warranty, and under any implied warranty that may exist, is limited to repair or replacement of any defective part. In no event shall **Kanga Loaders** be liable for incidental, special, or consequential damages (including lost profits).

DISCLAIMER OF FURTHER WARRANTY

Kanga Loaders makes no warranty other than what is expressly made in this warranty. If the law provides that an implied warranty of merchantability, or an implied warranty of fitness for a particular purpose, applies to **Kanga Loaders**, any such implied warranty is limited to the duration of this express warranty.

SPARE PARTS WARRANTY: 6 MONTHS

TERMS AND CONDITIONS

KANGA LOADERS LTD will warrant any part found to be defective within the conditions of normal usage. Breakage or damage to any part caused by abuse or misuse will not be considered. Hydraulic hoses will not be covered by warranty if any signs of external damage are apparent.

Consumables including tyres, tubes and S tracks are not covered by warranty.

The warranty period is for **six (6)** months from the delivery date and applies to only genuine spare parts.

This warranty does not cover any labour, freight, incidental or consequential charges.

The warranty claim will not be recognised without the return of the faulty part to Kanga Loaders Ltd and must include the Loader and attachment serial number.

A warranty claim for any engine part is covered by the engine manufactures standard warranty contained in the engine manual handbook.

It is the owner's responsibility to ensure that the correct hydraulic and engine oil levels are maintained and that maintenance is carried out as required in the manuals. Claims for damage as a result of insufficient oil levels will not be recognised.



We thank you for choosing the KANGA LOADER. This machine is the result of extensive design and development, and is acknowledged as being a superior product in its category. We congratulate you on your discerning choice and wish you many years of productive service.

Read this manual carefully before operating your machine it contains important technical information, safety precautions and operating instructions. Compliance with Safety Precautions and Risk Management standards together with the correct operation and attention to maintenance procedures are necessary to ensure a long, SAFE and trouble free working life for your KANGA LOADER.

Some illustrations in this publication show details or attachments that may be different from your machine. Guards and covers may have been removed for illustrative purposes, however, the machine in its operational state must always be operated with all guards and safety controls in place.

Continuing improvement and advancement of product design may have caused changes to your machine which are not included in this publication. We advise you to read study and understand this manual before undertaking any maintenance, and to keep it with your machine at all times as a ready reference.

SAFETY

The safety section lists basic safety precautions. In addition, this section identifies the text and locations of warning labels used on the machine. Read and understand the basic precautions listed in the safety section before operating or performing lubrication, maintenance and repair on this product.

TABLE OF CONTENTS

WELCOME

LOADER IDENTIFICATION	3
WARRANTY DETAILS	5
FOREWORD	7
TABLE OF CONTENTS	8
HOW TO CONTACT US	10
DELIVERY SHEET - pages removed at handover	33
WARRANTY REGISTRATION CARD - pages removed at handover	34
LOADER CHECKLIST - pages removed at handover	35
SERIAL NUMBER REGISTRATION - pages removed at handover	36

SAFETY

PREPARATION FOR USE	11
SAFETY LABEL IDENTIFICATION	12
SAFE OPERATION	13
FIVE STEPS TO EFFECTIVE JSEA	16
NO GO ZONES FOR UNDERGROUND UTILITY SERVICES	17
OPERATOR SAFETY - summary	18
TASK PLANNING FOR THE KANGA LOADER	19
PRE-OPERATIONAL RISK ASSESSMENT	20
RISK ASSESSMENT	21

OPERATING INSTRUCTIONS

OPERATING INSTRUCTIONS	25
------------------------	----

ATTACHMENTS

HYDRAULIC ATTACHMENT CONNECTIONS	29
4 IN 1 OPERATING INSTRUCTIONS	30
POWER HEAD OPERATING INSTRUCTIONS	31
TRENCHER OPERATING INSTRUCTIONS	32
BACK HOE OPERATING INSTRUCTIONS	33
BUCKET BROOM OPERATING INSTRUCTIONS	34
ROTARY HOE OPERATING INSTRUCTIONS	35
SAFETY - Rules for Attachments	36

TABLE OF CONTENTS

MAINTENANCE

DAILY OPERATOR MAINTENANCE	39
OPERATOR MAINTENANCE – Safety Checks	44
LOADER ARM MAINTENANCE	45
SERVICE TASKS	46
SERVICE TASKS - Engine	47
SERVICE TASKS - Hydraulics	49
SERVICE TASK - Trenching Valve	51
SERVICE TASKS - Visual	53
SERVICE TASKS - Grease Nipple	53
SERVICE TASK - Radiator (Diesel)	53
SERVICE TASKS - Battery	53
SERVICE TASKS - Pivot Pins	54
SERVICE TASKS - Tyre Pressure	55
DECALS	56
SERVICE CHART	59
MAINTENANCE SCHEDULE	60

SPECIFICATION

SPECIFICATIONS - Mid Range Loader	62
DIMENSIONS - Mid Range Loader	63

TROUBLESHOOTING

TROUBLESHOOTING	64
-----------------	----

HOW TO CONTACT US

SERVICE CENTRES - SPARE PARTS, SERVICE & SUPPORT

SALES

Phone: 08 9240 7844

SPARES

Email: spares@kangawa.com.au

SERVICE BOOKINGS

Email: admin@kangawa.com.au

VISIT OUR WEBSITE

www.kangawa.com.au

DEALER STAMP

Kanga Loaders WA
Unit 1 - 82 Christable Way
Landsdale WA 6065

SAFETY

PREPARATION FOR USE

INSPECTION AFTER DELIVERY

When the machine is delivered, it should be inspected for any evidence of damage caused as a result of shipment before it is declared ready for use. The preparation of the mini loader for use should only be undertaken by a responsible person who has read and understood this manual. The requirements are simple and coupled with the use of good common sense, together with general occupational health and safety knowledge and a visual inspection, should not pose any problems. The following checklist provides suggestions for detecting defective or damaged parts.

CHECK BEFORE USE

1	Inspect the machine chassis for any visible damage.
2	Visually inspect all components to ensure they are attached securely.
3	Inspect all areas for evidence of hydraulic oil, engine oil or fuel leakage.
4	Inspect Arm assembly area for firm attachment and sufficient lubrication. Check hydraulic cylinders for oil leakage and visible damage.
5	Check hydraulic oil lines for correct connection and for signs of leakage.
6	Check wheel and tyre assemblies for loose or missing wheel nuts, any visible damage and proper tyre inflation.
7	Check wheel drive motor assemblies for any visible damage and oil leakage.
8	Inspect all cylinders for rust, nicks, scratches or foreign material on shafts. Check for hydraulic oil leaks at the seal and fitting areas.
9	Inspect the engine compartment for loose or missing components and any evidence of damage or leakage.
10	Check the engine oil level is within operating limits as marked on the Dip Stick.

SAFETY LABEL IDENTIFICATION

The safety section lists safety precautions **required** to be taken when operating or maintaining a Kanga Loader. Read and follow **all** operating and safety instructions contained in this Manual and illustrated on the decals fitted to the Loader, and ensure that you assess the risk of any task by use of the attached Job Safety & Environmental analysis (JSEA) sheet.

If you are unable to identify hazards or do not understand the process for use of the JSEA chart, stop the job and consult a qualified Occupational Health and Safety consultant.

DANGER

THIS SYMBOL HAS BEEN USED THROUGHOUT THIS MANUAL TO HIGHLIGHT CRITICAL SAFETY INFORMATION TO PREVENT DEATH AND INJURY.



THIS SYMBOL HAS BEEN USED THROUGHOUT THIS MANUAL TO HIGHLIGHT IMPORTANT SAFETY INFORMATION. ENSURE YOU READ AND UNDERSTAND THE INFORMATION BEFORE EMBARKING ON ANY RELATED TASK.



THESE SYMBOLS ARE PICTOGRAMS AND REFER TO COMPULSORY PERSONAL PROTECTIVE EQUIPMENT (PPE) THAT MUST BE WORN AND/OR ACTIONS THAT MUST BE TAKEN BY THE OPERATOR TO ALLOW SAFE OPERATION OF THE MACHINE TO OCCUR.

SAFE OPERATION

The Kanga Loader is a versatile machine, capable of performing a variety of tasks in a safe and effective manner, when used in accordance with established procedures and supported by Risk Assessment. However, to ensure the safety of operators and others, it is important to ensure that the capacity of the machine is not exceeded and that the Loader is operated appropriately, and only after all tasks associated with the work at hand have been documented and the relevant risk control measures implemented.

To ensure the safe operation and transport of your Kanga Loader, the following basic Safety Rules must be understood and complied with at all times.

Safe Loading/Unloading and Transportation:

- When loading/unloading the Kanga from a trailer, it is important that the trailer remains attached to the towing vehicle on a firm even surface.
 - Never unload a trailer positioned on a slope.
 - Ensure the angle of ascent/descent is within safe operational limitations.
 - Ensure bystanders are sufficiently clear.
 - All loading/unloading is to be carried out at a slow speed with due care for personal safety and damage to equipment. Practice the manoeuvres first on flat ground if necessary.
 - When lifting the machine, use appropriately rated slings and shackles and attach securely to the lifting point on the top of the machine.
- 
- Always use the tie down points on each side of the machine to secure the Loader when transporting.
 - Always use witches hats, signage and traffic signals to control the unloading/loading zone, particularly when in close proximity to operational roads.

Before Commencing Work:

- Ensure all safety instructions are clearly understood, that operating manuals have been read and that operators are familiar with the controls of the Kanga Loader.
- Ensure that the daily inspection routine has been successfully conducted. It is particularly important to ensure that all attachment Locking Pins are fully engaged and secure.
- Ensure the driving platform is free from dirt, grease or mud before use.
- Check all controls for proper response. Shut down the machine if a fault is detected, tag the machine out with an “Out of Service” tag, remove the key and contact the local Service Agent.
- Review the working site for hazards through the use of a Job Safety Analysis and/or Risk Assessment and implement the risk control measures to eliminate or minimise their effects, such as:
 - Overhead power lines
 - Underground services
 - Excavations
 - Slopes or adverse cambers
 - Confined spaces
 - Other obstructions
 - Other people or animals accessing the working area or machine

ALWAYS

- Completely read and understand the Operator's Manual supplied with the machine.
- Undertake a Job Safety and Environmental Analysis (JSEA) and/or Risk Assessment before any use of both the Kanga Loader and the trailer upon which the Loader and/or attachments are carried. A blank JSEA is provided in Appendix A for use. Photocopy as required.
- Use the Job Safety and Environmental Analysis Checklist to check that the relevant safety procedures are in place before work commences.
- Position the trailer carrying the Kanga in an area free from traffic, establish a traffic control plan/zone, chock the wheels and ensure that people are not placed in a position where they can be struck by vehicles or equipment being loaded or unloaded.
- Demarcate the work area with barricades and/or witches hats before using the Kanga Loader.
- Identify, mark and delineate **all** underground services before any work commences.
- Have both feet planted firmly on the driving platform at all times when operating the Kanga Loader. This is especially important when carrying loads, as body weight provides additional counter-balance to the bucket load.
- Come to a complete stop before changing direction from forward to reverse and vice versa. Failure to do so can affect the stability of the Loader and may also damage the drive of your machine.
- Come to a complete stop before operating other hydraulic controls.
- Reverse down slopes at slow speed when carrying loads.
- Ensure the machine is fully stopped and turned off before alighting or exiting the machine. Never use control levers as hand holds, instead utilize the handholds, using the thumbs and forefingers to operate the control levers.
- Travel at speeds suitable for the conditions and as determined by the task JSEA or Risk Assessment.
- When traveling over undulating surfaces and/or rough terrain, it is essential that the operator ensures that the speed is appropriate to suit conditions and to creep over uneven terrain at minimum speed. The recommended normal operating speed is between 2/3 to 3/4 throttle; at a lower speed the noise levels are reduced to both the operator and bystanders.
- Wear approved, appropriate Personal Protective Equipment (**PPE**), such as:
 - Hearing protection
 - Safety footwear
 - Eye protection
 - Hard hat
 - Long, close fitting protective clothing
 - A high visibility vest or clothing, etc.
- Keep hands, feet and clothing away from all moving parts, including hydraulic rams.
- Keep body parts within the confines of the machine.
- Keep alert, and avoid being distracted whilst operating the loader.
- Remove the key and chock the wheels whenever the Loader is to be left unattended and/or unsupervised.



NEVER

- Operate this machine or the trailer without undertaking a Risk Assessment or JSEA.
- Operate this machine without Personal Protective Equipment (PPE).
- Exceed the Rated Operating Capacity (ROC) for the Mid range loader.
- Carry passengers on any part of the Loader or attachments.
- Place feet under the driving platform.
- Smoke (or approach the Loader with a naked flame) whilst operating or refuelling.
- Leave the engine running whilst refuelling.
- Tie or secure yourself to any part of the machine or attachment.
- Fool around while operating the Loader or attachments.
- Carry a load with the bucket raised. Carry all loads as close to the ground as practicable.
- Traverse across slopes, especially on uneven ground.
- Jerk the control levers. Always use a steady, even action to achieve proper control.
- Touch exhaust, engine parts, hydraulic pipes and fittings, drive chains, friction parts or guards.
- Park or leave Loader unattended on a slope.
- Remove safety decals.
- Remove safety guarding.
- During operation use mobile telephones or portable radios.
- Operate machine for extended periods at full throttle.



CAUTION

Always exercise care when operating on slopes. The Kanga Loader has been designed to be able to access restricted areas, due to its minimal width. This, however, reduces its stability when crossing slopes.

The Kanga Loader is designed to operate on slopes to a maximum of 20°, under no circumstance is this to be exceeded. The actual safe slope angle may need to be reduced depending on a number of variables, such as site conditions, attachments, condition and configuration of machine and operator experience.

Crossing slopes should be avoided wherever possible. If it is not possible, slopes should be traversed with loads lowered as far as possible, reduced speed and extreme caution.

FIVE STEPS TO EFFECTIVE JSEA

1	DOCUMENT THE ACTIVITY Assemble those involved in the activity and then, using the JSEA worksheet, write down in step by step form, the tasks that make up the activity.
2	IDENTIFY THE HAZARDS Next to each task, identify what part of the task may cause injury to those engaged in the task or others in the vicinity.
3	DOCUMENT THE CONTROL MEASURES For each identified hazard, assess the associated level of risk to those involved, and then list the control measures required to eliminate or minimise those risks.
4	IDENTIFY WHO IS RESPONSIBLE Document the name of the person responsible for implementing the control measure.
5	MONITOR AND REVIEW Ensure that the activity is supervised and that the documented process is being followed. The documentation should be reviewed whenever a documented activity changes or when there is a change of personnel or after an appropriate length of time.

NO GO ZONES FOR UNDERGROUND UTILITY SERVICES

No work is to commence on any worksite until you have checked if it contains underground services. Here is how you can find out.

- The “Dial Before You Dig” service (in Australia), **dial 1100**, provides free and easy access to the records of a large number of organizations, including telecommunications, water, electricity and gas.
- To see a list of organizations registered with the service or to log an enquiry electronically, visit the Dial Before You Dig website at www.1100.com.au, or telephone 1100 (otherwise consult with your local environment department).

If underground services are present, you must comply with the No Go Zones.

If the worksite contains or is suspected to contain ANY underground services, before any work commences, you must follow the relevant No Go Zone safety procedures:

- No Go Zone safety procedures are available from all gas, water, telecommunications, and electricity companies.

NO GO ZONES FOR UNDERGROUND UTILITY SERVICES

- You must follow these safe systems of work at all times. If you cannot comply with these safety procedures, then NO work shall be undertaken without written permission being received from the utility company.
- The Kanga Kid and attachments must be kept a minimum distance of 3 meters from all underground services.

MAINTAIN A MINIMUM OF 3 METRES DISTANCE FROM ANY UNDERGROUND OR OVERHEAD SERVICE.



OVERHEAD POWERLINES

- Do not operate Kanga loaders on the back of a truck near overhead powerlines or any electrical conductors.
- Do not drive with Kanga loader on the back of a truck or trailer with hydraulic arms elevated or with attachments connected as they could enter the exclusion zone. (3 meters)
- Avoid driving or working in or around exclusion zone for overhead and underground powerlines. Exclusion zone for unauthorised persons is 3 meters up to 132 kV and is 6 meters up to and including 330kV.
- If unsure of the exclusion zones including overhead and underground powerlines – consult maps, call dial before you dig, and talk to property owners and the local electrical entity.

OPERATOR SAFETY - SUMMARY



1. READ OPERATORS MANUAL
PRIOR TO USE



2. DAILY INSPECTION

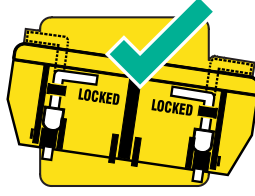

3. ENSURE BOTH (2) ATTACHMENT
LOCK PINS ARE FULLY ENGAGED



4. ENSURE HYDRAULIC HOSES
ARE CLEAN AND ATTACHED

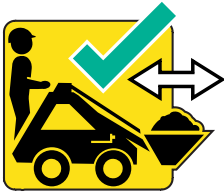

5. TRANSPORT MATERIAL WITH
BUCKET DOWN AND LEVEL

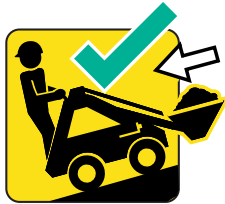

6. ALWAYS REVERSE DOWN SLOPES



7. WEAR APPROPRIATE
PROTECTION

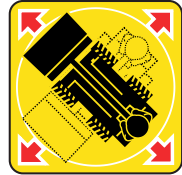

8. NO PERSONNEL WITHIN A
4M (12 ft.) DIAMETER



9. NO SMOKING
WHILE FILLING



WARNING

DANGER

FAILURE TO READ
THESE SAFETY RULES
PRIOR TO ANY MACHINE
OPERATIONS MAY LEAD
TO SERIOUS INJURY,
PROPERTY DAMAGE
OR DEATH.

TASK PLANNING & SAFETY CONSIDERATIONS

PERFORM A SITE ASSESSMENT

Is the terrain stable or suitable to work on?

- Unload Loader from a trailer with ramps.
- Conduct a thorough site inspection before entering site with Loader.
- Consider Wet or boggy conditions.
- Consider environmental factors.
- Consider steep slopes. Do not work side on to slopes.
- Dial before you dig (dial 1100) to check for services.
- Amend your plans and take precautions where necessary.
- Document your plans in the JSA/SWMS.

Personal safety

- Where other mobile plant and equipment is in use, wear high visibility garments.
- Read the Loader instruction manual – familiarise yourself with Loader features.
- Use Loader only as specified in instruction manual.
- Perform a pre-operational inspection of the Loader to identify any faults.
- Ensure all safety features are operable.
- Use bunting, flags or witches hats to demarcate or isolate work area.
- Wear additional PPE such as safety glasses, hearing protection and hard hat and steel capped boots.

Task execution

- Discuss work plans with other workers/persons in the area.
- Coordinate Loader activities with other trades/activities on site.
- Work in a logical sequence.
- Do not exceed weight/load and operational limitations of the Loader.
- Keep loads low to the ground when travelling.
- Keep bucket down when not in use.

Site Clean Up

- Remove Loader from site.
- Wash Loader down and inspect Loader for hydraulic leaks/damage.
- Return Loader and attachments to trailer.
- Remove bunting, flags, witches hats.
- Restore site conditions as required.

Perform a site assessment

ENGAGE YOUR MIND BEFORE USING THE LOADER

Assess the risks

STEP BACK - Take 5 X 5

Take 5 steps back

Take 5 minutes to reflect

- **Stop and think.**
- **Observe the work area and surroundings.**
- **Step through your mind what you are going to do.**
- **Think about what else is happening in the area or nearby.**
- **Identify what else could go wrong.**
- **Decide on control measures to prevent things going wrong.**
- **Make sure the hazards are controlled before starting work.**

Think about the consequences to your quality of life, your income, your family, your children and everything you value. Are these things worth the risk of rushing or cutting corners? It's not just your life that could be affected – you may shatter the lives of the ones you hold dear.

THINK SAFE ! ACT SAFE ! BE SAFE ! GO HOME

OHS&E Risk Assessment/SWMS – Powered Mobile Plant

Work Activity	
Principal Contractor's Name:	Project Reference #:
Contractor Name:	ABN:
Contractor Address:	Foreman and contact number:
Prepared By:	
Name 1:	Name 2:
Signature:	Signature:
Position:	Position:
Received and reviewed by:	
Name:	Date:
Signature:	Position:
Date work method prepared: (must be within last 12 months)	Date work to be commenced:
Actions before work commences: (e.g. signage, bunting, demarcation, isolation)	
Action during work:	
Actions after work is complete:	

Supervision:	Engineering details/certificates/ authority approval required:
Personnel qualification & experience required:	Permits e.g. excavation, hot work etc:
Training and instruction:	Warning signs and control measures:
Plant, equipment & materials to be used and the maintenance checks to be completed (details at back of SWMS also): <ul style="list-style-type: none"> • Loader • 	Personal protective equipment requirements:
Legislation, codes of practice, standards applicable:	List of attachments (e.g. material safety data sheets, diagrams etc):

RISK SIGNIFICANCE (Level of Risk)

C = Consequence	L = Likelihood	Risk control legend
5 = Catastrophic Death, disablement, significant incident, unacceptable risk, significant financial cost.	5 = Almost Certain Could occur in most circumstances	Risk control legend 16-25 Cease activity immediately and implement risk controls before commencing work activities. Make the work area safe & consult with competent/qualified personnel. 10-15 Plan and implement risk control measures after performing a Step Back 5 X 5 risk assessment. Seek advice from the manufacturer if any doubt exists. 6-9 No immediate risk. Assess overall risk in line with resources, instruction manual, and manufacturer's advice. 1-4 Accept level of risk
4 = Major Extensive injuries leading to lost time, major risk-damage to plant and equipment, major financial cost for repairs/reinstatement.	4 = Likely May probably occur in most circumstances	
3 = Moderate Medical treatment, medium risk-damage to plant and equipment, medium financial cost for repairs/reinstatement.	3 = Possible May occur at some time	
2 = Minor First Aid treatment, minor risk-damage to plant and equipment, minor financial cost for repairs/reinstatement.	2 = Unlikely Could occur at some time	
1 = Insignificant: No injuries, slight damage, low financial cost for repairs/reinstatement.	1 = Rare May occur only in exceptional circumstances	

Likelihood (L)	Consequences (C)					1 Insignificant
	5 Catastrophic	4 Major	3 Moderate	2 Minor	1 Insignificant	
5 – Almost Certain	25	20	15	10	5	5
4 – Likely	20	16	12	9	6	4
3 – Possible	15	12	9	6	4	3
2 – Unlikely	10	8	6	4	2	2
1 – Rare	5	4	3	2	1	1

ITEM #	WHAT ARE THE BASIC STEPS (List steps in logical sequence & include materials, equipment etc)	POTENTIAL HAZARDS (What may cause an injury/illness to occur)	RAW RISK RANKING L C R	HAZARD CONTROLS (What controls will be put in place to prevent an injury/illness) N.B. Control measures must not raise or create an increased risk	RESIDUAL RISK RANKING L C R	WHO WILL MONITOR & ENSURE THAT THIS IS DONE

OPERATING INSTRUCTIONS

BEFORE STARTING

Check the fuel level and fill up if necessary. Ensure that the fuel is the correct type, free from impurities or water. Check that both the crankcase oil and hydraulic oil levels are within operating limits.



CAUTION: Check that all control levers below are in the neutral centre position.

NOTE: Ensure The Auxiliary Power Lever (3) has automatically returned to the “Engine Start” position from the “Work” position. If this lever is not in neutral, the engine will attempt to start under full load. This will place strain on the starter motor potentially flattening the battery.

STARTING

Refer to the engine manual for correct throttle (7) starting positions in warm and cold conditions. Turn starter key switch to start engine.



CAUTION: Do not move any of the control levers unless standing with both feet on the driving platform and holding the grip handles, ensuring non-operating personnel are clear of the Loader.



CAUTION: First time users to use slow 1/3 throttle to practice safe operation before commencing work. The recommended normal operating speed of the machine is 2/3 to 3/4 Throttle.



CAUTION: The Kanga Loader is not fitted with a “seat belt”. The standing position is a safety feature which allows a quick exit from the machine in case of an emergency. Do not add a restriction system to the machine which will limit your ability to safely exit from the Kanga Loader.



CAUTION: Always exercise care when operating on slopes. The Kanga Loader is approximately 1 meter (39”) wide, which is a great benefit for providing access to confined spaces, however, the machine may become unstable if operating across a slope. If it is impossible to avoid crossing a slope keep the load close to the ground and travel at reduced speed.

The maximum safe angle of slope is 20°. This angle is a recommendation only. The actual safe slope angle will depend on site conditions, operator experience and activity.

CONTROLS

On the top face of the KANGA Loader are Six spring centred levers which control the basic functions. The table below indicates the levers with their corresponding functions:

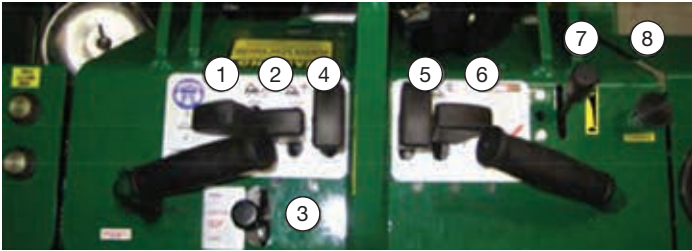

LEVER	PUSH	PULL
1	4 in 1 Open	4 in 1 Close
3	Aux Reverse	Aux Forward
2	Lower Arm	Raise Arm
4	Left Drive Forward	Left Drive Backward
5	Right Drive Forward	Right Drive Backward
6	Tilt Forwards	Tilt Backwards
7	Up Throttle Increase	Down Throttle Decrease
8	Choke Off	Choke On

MANOEUVERING

The forward and reverse levers should be thought of as softly operated clutches for engaging and disengaging the wheels. Use slow even movements of the control levers for smooth operation of the Loader. Practice slow starts and gentle stops in an open, safe area.

Manoeuvring is made possible by individual controls for the hydraulic motors on each side of the machine. A turn may be achieved by varying the amount and/or direction of power supplied to each side of the machine. The machine is capable of turning in its own length by applying equal forward and reverse power to opposite sides of the machine.

While moving forward, a gentle turn to the left for instance, can be made by slightly increasing the power to the right hand side or by reducing the power to the left hand side of the machine. This mode of steering allows the type of turn to be chosen to suit the situation.

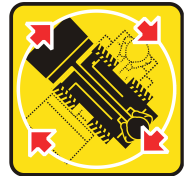

MANOEUVRING

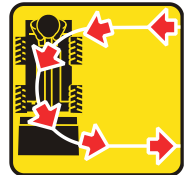

MANOEUVRING

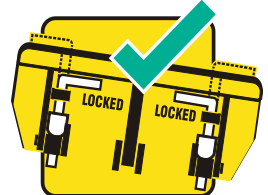

3. ENSURE BOTH (2) ATTACHMENT LOCK PINS ARE FULLY ENGAGED



CAUTION: Always ensure that the attachment Locking Pins are fully engaged at all times.

PARKING AND SHUTDOWN

When parking the Kanga always select level ground and lower any bucket or attachment fitted fully to the ground. To shut down, reduce the engine speed to idle and turn the key to the off position. Remove the key to prevent unauthorised use.

- When loading/unloading the Kanga from the trailer, it is important that the trailer remains attached to the towing vehicle on a firm even surface.
- Do not unload a trailer on a slope.
- Ensure bystanders are sufficiently clear.
- All loading/unloading to be carried out using a ramp must be done at a slow speed, with due care for personal safety and damage to equipment. Practice the manoeuvres first on flat ground if necessary.

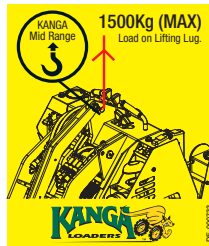

- Use appropriately rated slings and shackles, and attach to the lifting point on the top of the machine when lifting the machine.
- Always use the tie down points on each side of the machine to secure the Loader when transporting.
- Always use witches hats, signage and traffic signals to control the unloading/loading zone, particularly when in close proximity to operational roads.



CAUTION: Do not park or leave the machine on steep slopes.

ONLY KANGA DESIGNED AND APPROVED ATTACHMENTS ARE TO BE USED ON THIS MACHINE.

“No other attachment is to be used on this machine unless the design and use of the attachment has been assessed and authorised by Kanga; and has been supported by a compliant Risk Assessment, which has been verified and validated by the Risk Management Consultants.”



HYDRAULIC ATTACHMENT CONNECTIONS

Kanga Loaders are fitted with hydraulic quick release couplings (QRC) to connect the different attachments. The QRCs are paired as male and female to ensure correct hose connections.

COLOUR CODING OF QRC's FOR ATTACHMENTS

Left Side : Controlled by the Auxiliary lever on the Control Panel.

- Yellow** **B MALE QRC** - For Power Head, Under Road Borer, Cement Mixer, Wood-Chipper, Log Splitter, Rotating Log Grab, Rock Breaker.
- Black** **A FEMALE QRC** - For Power Head, Trenchers, Under Road Borer, Backhoe, Rotary hoe, Vibrating Plough, Cement Mixer, Wood Chipper, Log Splitter, Rotating Log Grab, Rock Breaker, Bucket Broom, Angle Bucket Broom, Rod Hammer & Drill.
- Red** **C MALE QRC TRENCHER VALVE** - For Trenchers, Trenching Valve, Rotary Hoe, Vibrating Plough, Bucket Broom, Angle Bucket Broom.

Right Side: Controlled by the 4in1 Lever on the Control Panel.

- Blue** **4in1 FEMALE QRC** - For 4in1 Bucket, Stump Grinder Slew, Backfill Blade, Rotating Log Grab, Kerb Clamp, Grapple Bucket, Plant Box Lifter, Angle Bucket Broom.
- White** **4in1 MALE QRC** - For 4in1 Bucket, Stump Grinder Slew, Backfill Blade, Rotating Log Grab, Kerb Clamp, Grapple Bucket, Angle Bucket Broom.
- Purple** **Tank return line** - Backhoe, Post Mast Rod Hammer & Drill. (If fitted).
- Green** **Case drain** - Hydraulic Stump Grinder, Poly Pipe Layer, Wood Chipper. (If fitted).

1/2' Male QRC	#HC-00009	Male Cover	#HC-00032
1/2' Female QRC	#HC-00010	Female Cover	#HC-00033

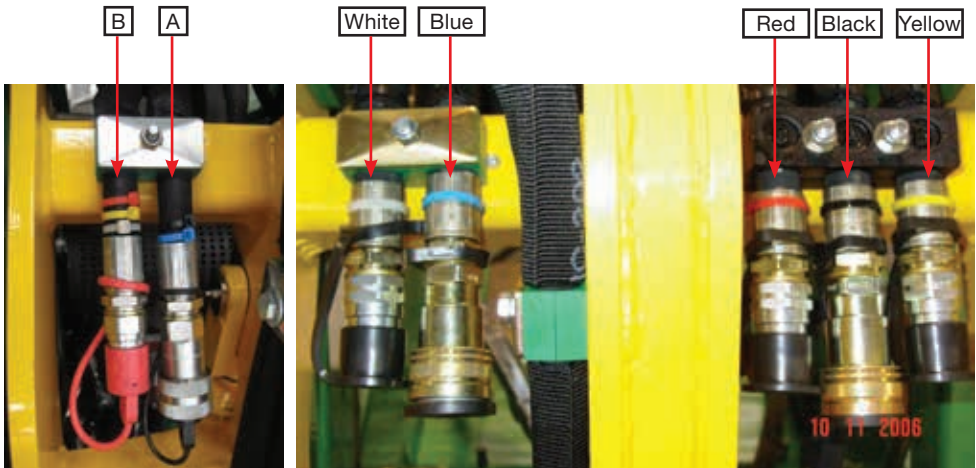

4 IN 1 BUCKET OPERATING INSTRUCTIONS

SAFE AND EFFICIENT USE OF BUCKETS

When lifting soil from a heap or pile, always have the bucket level. To achieve this, push the Loader arm downwards and use the tilt ram to bring the bucket level with the ground.



Towards the end of the run when the bucket is nearly full, gently tilt the bucket (rotate the bucket) towards the Loader. This decreases the lifting resistance when the arms are raised and promotes an efficient tear out.

When transporting material in the bucket on slopes or rough ground, always keep the bucket close to ground level. This lowers the centre of gravity of the Loader and maximises stability.



The material may then be dumped into a trailer or utility truck for removal or repositioning on the site.

When scraping, levelling and surface stripping, lower the bucket to the ground, tilt it down and so raise the front wheels slightly off the ground. Drive forward using the back wheels, the bucket will bite into the soil as you move forward.



CAUTION: Do not step off the operator platform with the load raised or the machine moving.



CAUTION: Always ensure that the attachment Locking Pins are fully engaged at all times.



1. READ OPERATORS MANUAL PRIOR TO USE



6. ALWAYS REVERSE DOWN SLOPES WITH LOAD



13. NO PERSONNEL IN BUCKET OR ATTACHMENTS



12. AVOID TRAVELLING ACROSS SLOPES



10. DO NOT PLACE FEET UNDER STANDING PLATFORM



14. PAY ATTENTION

POWER HEAD OPERATING INSTRUCTIONS

FITTING OF POWER HEAD:

Drive the Loader to the attachment and couple the attachment plate onto the attachment. Raise the Power Head slightly and engage the locking pins fully. Turn the engine off and push the AUX Control Lever forwards and backwards to release any hydraulic line pressure. Clean the hydraulic fittings (QRCs) and then connect them to connections A & B. (see “Hydraulics General Description” section).

Removal procedure is the reverse order of the above. Remember to always reconnect the attachment hoses into one another to stop dirt entering the hydraulic system, or fit the dust caps supplied.

FITTING THE AUGER

Once fitted to the Loader, raise the Power Head high enough to allow the auger to be positioned into the Power Head’s square drive shaft. Drive the Power Head forward positioning the drive into the auger, aligning the locking pin holes.



CAUTION: Large auger fitting is a 2 person operation.

PRE - OPERATION CHECK

Insert the locking pins and lock in place. Ensure that the Power Head is securely attached to the Kanga Loader. Check that the couplings are engaged and check for leaks. Tighten/repair as required.



CAUTION: Prior to commencing work, read the **Safety Rules** of this Kanga Loader Manual.

OPERATING INSTRUCTIONS:

Inspect the cutting tips and teeth. Ensure that they are in good condition and firmly attached.

Note: Teeth should display slight movement. Check that bolts securing the pilot are tight.

Start the auger turning in a clockwise direction by activating the “AUX” lever downwards. Lower the auger by pushing the “ARM” lever forward. If the ground is hard the front wheels of the Kanga Loader will lift off the ground. As the auger cuts into the ground the arc of the arm travel will move it out of vertical. To keep the auger vertical, move the Kanga Loader backward or forward slightly to compensate. Continually clear the hole during digging by raising the auger up (pull back on the “ARM” lever).

Drill a “trial” hole in a clear area to practice all operations and to become familiar with the procedure.



CAUTION: Prior to commencing any digging operations, check with the Local Authorities and the land owner that there are no buried services (Power, phone, water, gas, sewage etc) in the vicinity. **Australia ONLY: Phone 1100 “DIAL BEFORE YOU DIG”**

Read the Safety instructions in this Manual.

Keep clear of the auger at all times (4m minimum).

TRENCHER OPERATING INSTRUCTIONS

FITTING A TRENCHER

Drive the Loader to the attachment and couple the Attachment Plate onto the attachment. Raise the Trencher slightly and engage the locking pins fully. Turn the engine off and push the AUX Control Lever forwards and backwards to release any hydraulic line pressure. Clean the hydraulic fittings (QRCs) and then connect them to connections A & B (see “Hydraulic Attachment Connection” section).

Removal procedure is the reverse order of the above. Remember to always reconnect the attachment hoses into one another to stop dirt entering the hydraulic system, or fit the dust caps supplied.

PRE-OPERATION CHECK

Ensure that the Trencher is securely attached to the Kanga Loader. Check that the couplings are engaged and check all joints for leaks. Tighten/repair as required. Inspect the cutting teeth, ensuring that they are in good condition and firmly attached.

Chain Tensioning:

The Trencher chain requires 35-45mm of “lift” to have the correct tension and should be adjust as required. This is achieved by loosening the 16mm bolt, adjusting the adjustment wedge, and retightening the bolt.



CAUTION: Read all safety rules before operating. See safety chapter in this manual.

OPERATING INSTRUCTION



SETTING THE TRENCHING VALVE



Position the Trencher, and activate the AUX lever so that the chain runs along the top of the boom and returns back towards you on the underside. Engage the TILT lever so that the boom and chain arcs down to dig a trench. When the desired depth is achieved, slowly drive the Kanga Loader backwards along the trench line.

(LH side of the Loader). This is a load-sensing valve, which can be set to automatically regulate the speed of travel when trenching. Use the black knob to shut off the valve (turn clockwise). With the trencher cutting to the required depth start moving backwards using the drive levers, open the valve (½ a turn) and this will regulate the travel speed. Further adjustment of this valve will vary the cutting speed to suit the conditions and the operator’s experience.

NOTE: *Minor adjustments are required to maintain a straight line as the Loader will tend to “drift” to the left.*



CAUTION: Prior to commencing any digging operations, check with the Local Authorities and the land owner that there are no buried services (Power, phone, water, gas, sewage etc) in the vicinity.

Australia ONLY: Phone 1100 “DIAL BEFORE YOU DIG”

Read the Safety instructions in this Manual.

Keep clear of the Trencher at all times (4m minimum).

DELIVERY SHEET

Owner:		Date:
Address:		
City:		Post Code:
State/Territory:	Email Address:	
Owners Phone No: ()		Mobile:
Dealer/Delivered By :		
Loader Model and Serial No:		
Attachments:		Serial No.
(1)		
(2)		
(3)		
(4)		
(5)		
Customer's name)		Salesman / Owner to initial
1. Accept delivery of the equipment as detailed above. All equipment has been inspected and is accepted.	<input type="text"/>	
2. Have had the operational and safety procedures explained to me for the Loader and attachments and have been provided a copy of these procedures for reference and use.	<input type="text"/>	
3. Have received a copy and understand the Operators Manual and safety information contained therein for all equipment and attachments supplied.	<input type="text"/>	
4. Understand that I am required to perform a risk assessment/JSEA covering all tasks before I operate this machine and/or any attachment.	<input type="text"/>	
5. Understand the warranty conditions and maintenance requirements for the Loader and attachments.	<input type="text"/>	
Comments: (COMPLETE SERIAL NUMBER REGISTRATION ON PAGE 8)		
Purchaser's Signature:		Date:
.....	 / /

WARRANTY REGISTRATION CARD

Once you have read the Warranty section of this manual, please complete the **Warranty Registration Form** below. Check the details, then return within 30 days of the delivery date to the address as indicated below the respective country of purchase on the Registration Form.

Owner:	Phone: ()
Address:	Mobile:
Town/City:	Fax: ()
Country:	Post Code:
Delivery Date:	KANGA SERIAL NO:

Email:

Kanga Agent/Sales Person:

I (The Purchaser) have read and fully understand the Operator's Manual, Safety Instructions and warranty conditions.

Warranty will only be accepted if this Certificate is completed and returned to:

AUSTRALIA:
KANGA LOADERS GLOBAL, 4 OCTAL ST, YATALA, QLD 4207

Email: service@kangaloader.com

DEALER STAMP

Kanga Loaders WA
Unit 1 - 82 Christable Way
Landsdale WA

Purchaser's Signature:	Date:
..... / /

LOADER CHECKLIST

MODEL: _____	INSPECTOR'S NAME: _____
SERIAL No.: _____	MACHINE BUILT BY: _____
ENGINE No.: _____	DATE: _____

VISUAL CHECK	✓	✗	OPERATIONAL CHECK	✓	✗
1. Damage.			1. Gauges/switches and connections/dash lights.		
2. Loose bolts/nuts.			2. Attachment Plate.		
3. Rust.			3. Throttle Lever (not too tight or loose).		
4. Leakage oil or water.			4. Levers and linkages working correctly.		
5. Wiring / oil cooler connection.			5. Unusual noises or vibrations.		
6. Paint work			6. Petrol/ Diesel engine Idle 1350-1450 / 900-1000rpm.		
7. Any untidy weld spots or runs.			7. Petrol/ Diesel engine max 3550-3650 / 3800-3850rpm.		
8. Check of fittings alignment.			8. Is Loader easy to start?		
9. Is Loader clean and tidy?			9. Is Hour Meter working? Test time = hrs.		
10. Are pipes and hoses clear of parts on Loaders?			10. Check that lift cylinder stops in correct position.		
11. Are Hershel plugs clear of tank & hydraulic lift tubes?			11. Aux stop cable, check cable length is correct & test operation 5 times.		
SERVICE	✓	✗	GUIDANCE	✓	✗
1. Tie down lugs fitted on body.			1. Correct stickers applied (UK C/E sticker).		
2. Correct Attachment Plate/ operation ok with test jig.			2. Correct Tyre Pressure sticker attached.		
3. Lubricate Loader, grease all linkages.			3. Identification Plate -(correct number stamped).		
4. All pins and bushes fitted and tight.			4. Safety/Operating USB.		
5. Belt tension fan/alternator.			5. Engine Manual (Honda Warranty Form).		
6. Wheel condition/wheel nuts been tensioned 100 ft-lb.			FLUID COMPARTMENT CHECK	✓	✗
7. Is the track slot forward and tyre direction correct?			1. Battery condition.		
8. Is the tyre pressure to specification?			2. Engine oil level.		
9. Radiator core, hoses and fittings.			3. Hydraulic oil level.		
10. Air element and hose clearance and connections tight.			4. Fuel level.		
11. Sediment in fuel filter/tank (drain fuel tank).			5. Inspect fuel tanks for leaks.		
12. Is engine EPA compliant?			6. Hydraulic filter housing directions and elements tight.		
13. Is PTO direction correct?			7. Radiator water level (Diesel).		
14. Has valve tag been removed?			OTHER	✓	✗
15. Are QRCs correctly aligned and covers fitted?			1. Is the "Passed By" sticker attached and signed?		
16. Spare key fitted correctly to machine.			2. Check machine to be shipped against order.		
17. Ensure battery is secure and boot is on alternator.			3. Is the Loader ready for despatch?		
18. Is the Splash Plate fitted?			4. Ensure diesel Loader has oil funnel.		
19. Check oil cooler connection to fan.			5. Have back protection bars been ordered and fitted?.		
20. Ensure control knobs are not split and are secured.			6. Lights/Beacon operational (Where Fitted).		
21. Is the Control Knob on Trencher Valve clear of guard?			7. Horn/ Reverse beeper operational (Where Fitted).		
			8. Rear Legs Operational (Where Fitted).		

"Received the above Loader, attachments and documentation as stated above in good condition. The correct operation of the Loader has been explained to our satisfaction. We understand that this Loader should be operated by a properly trained operator. We are aware that the use of this Loader in any manner or place for which it is not designed will render it unsafe."

DISTRIBUTOR'S NAME: _____ INSPECTOR'S SIGNATURE: _____

SERIAL NUMBER REGISTRATION

MAIN COMPONENT SERIAL NUMBERS

KANGA Serial No: _____

Engine Type: _____

Serial No: _____

Wheel Motors: FRONT RIGHT: _____ REAR RIGHT: _____

FRONT LEFT: _____ REAR LEFT: _____

Lift Ram: _____

Tilt Ram: _____

Hydraulic Pump: _____

Control Valve: _____

Date Purchased: _____

BACK HOE OPERATING INSTRUCTIONS

FITTING THE ROTARY HOE

1. Refer to Backhoe Manual for complete installation instructions.
2. Turn the engine off, move the Aux Lever 3 back and forth to release hydraulic pressure. Connect the hoses of the Back Hoe to A & B QRC's on the right hand side of the loader when looking from the front of the machine.
3. Ensure the Loaders Main Arm is lowered with the 4 in 1 Bucket flat on the ground, for best results the backhoe works better if the bucket is full of dirt making the machine slightly more stable.



CAUTION: Prior to commencing work, read the Safety Rules of this Kanga Loader Manual

PLEASE NOTE: ALWAYS FIT THE DUST CAPS PROVIDED FOR THE QRC'S TO YOUR ATTACHMENT AND MACHINE WHEN NOT IN USE TO PREVENT DIRT ENTERING THE SYSTEM

PRE - OPERATION CHECK

1. Ensure the Back Hoe is securely attached to the Kanga Loader. Check the couplings are engaged and check all joints for leaks.
2. Tighten and Repair as required.
3. Inspect the Backhoe bucket teeth and hydraulic hoses and cylinders are in good condition.
4. Ensure the Backhoe wheels are in the locked position.

OPERATING INSTRUCTIONS:

1. Ensure Lever 3 is in the neutral Position.
2. Start the Diesel Engine.
3. Adjust engine rpm using Lever 7 which can be adjusted to suit the operation and hydraulic requirements.
4. Drive the loader into position then lower the loader main arms to position the bucket onto the ground.
5. While standing on the rear step of the loader pull Lever 3 of the mini loader towards you, this allows hydraulic power to go to the Backhoe Valve.
6. Turn around and operate the backhoe as per control details in the Back Hoe Operators Manual.



CAUTION: Once the "AUX" lever is engaged, the KANGA Back Hoe attachment is "Alive". Any movement of the KANGA Back Hoe control levers will cause the Back Hoe to move. Ensure that you are ready to operate the machine and have observed all safety regulations before moving the control levers.



CAUTION: Prior to commencing any digging operations, check with the Local Authorities and the land owner that there are no buried services (Power, phone, water, gas, sewage etc) in the vicinity.

Australia ONLY: Phone 1100 "DIAL BEFORE YOU DIG"

Read the Safety instructions in this Manual.

Keep clear of the auger at all times (4m minimum).

BUCKET BROOM OPERATING INSTRUCTIONS

FITTING THE ROTARY HOE

1. Connect the attachment plate of the loader to the Bucket Broom frame ensure the quick hitch / attachment locking pins are engaged.
2. Turn the engine off, move the Aux Lever 3 back and forth to release hydraulic pressure. Ensure the QRC's are clean then connect the hoses of the Bucket Broom to A & B QRC's on the right hand side of the loader when looking from the front of the machine.
3. Connect the hose bracket to the machine and secure the R Clip.
4. Install the chain onto the broom chain clamp (Supplied with the Broom) around the top of the lift arm cylinder and tighten onto the machine.
5. Place the bucket broom flat on the ground and adjust the chain to have about 4 links slack so when you lift the bucket up and tilt it forward it will open the bucket lid and empty out the debris.
6. To Remove the Bucket Broom please reverse the instructions above.



CAUTION: Prior to commencing work, read the Safety Rules of this Kanga Loader Manual.

PLEASE NOTE: ALWAYS FIT THE DUST CAPS PROVIDED FOR THE QRC'S TO YOUR ATTACHMENT AND MACHINE WHEN NOT IN USE TO PREVENT DIRT ENTERING THE SYSTEM.

OPERATING INSTRUCTIONS:

1. Ensure Lever 3 is in neutral.
2. Start the Engine and adjust the Engine RPM Lever 7 to suit the operation power you require.
3. Position the Bucket flat on the ground engage Lever 3 and pull towards the operator. This will start the Broom rotating and sweeping into the bucket base.
4. The Bucket can either be pulled or pushed with the mini loader drive system however the does work more efficiently when pulled.
5. Using levers 4 & 5 Drive the machine, Travel Speed is controlled by levers 4 & 5 by gently engaging both levers forward, The further forward they are the faster the machine will travel and slowing down is the exact reverse allowing the levers to gently return to centre will slow the machine down.
6. To empty debris from the bucket disengage Lever 3 tilt back slightly and drive to the location you would like to dump the debris, Raise the lift arm with Lever 2 and tilt the bucket forward to dump the debris out using Lever 6.

ROTARY HOE OPERATING INSTRUCTIONS

FITTING THE ROTARY HOE

1. Connect the attachment plate of the loader to the Rotary Hoe ensure the quick hitch/attachment locking pins are engaged.
2. Turn the engine off, move the Aux Lever 3 back and forth to release hydraulic pressure. Ensure the QRC's are clean then connect the hoses of the Rotary Hoe to A & B QRC's on the right hand side of the loader when looking from the front of the machine.
3. Connect the hose bracket to the machine and secure the R Clip.
4. To Remove the Rotary Hoe please reverse the instructions above.



CAUTION: Prior to commencing work, read the **Safety Rules** of this Kanga Loader Manual.

PLEASE NOTE: ALWAYS FIT THE DUST CAPS PROVIDED FOR THE QRC'S TO YOUR ATTACHMENT AND MACHINE WHEN NOT IN USE TO PREVENT DIRT ENTERING THE SYSTEM

PRE - OPERATION CHECK

1. Ensure the Rotary Hoe is securely attached to the Kanga Loader.
2. Check that the couplings are engaged and check all joints for leaks.
3. Tighten and repair as required.
4. Check the rotary hoe and cutting blades are in good condition.

OPERATING INSTRUCTIONS:

1. Ensure Lever 3 is in neutral.
2. Start the Engine and adjust the Engine RPM Lever 7 to suit the operation power you require.
3. Position the Rotary Hoe flat on the ground and engage Lever 3 and pull towards the operator to start the blades rotating.
4. The Rotary Hoe should only be pulled with the mini loader drive system. Using Levers 4 & 5 to drive the machine. Travel Speed is controlled by levers 4 & 5 by gently engaging both levers Rearward. The further Rearward they are the faster the machine will travel and slowing down is the exact reverse allowing the levers to gently return to centre will slow the machine down.
5. The travel speed of the loader will adjust the condition of the soil, slower travel speed will turn the soil over more making it softer. Fast speed will turn the soil over less allowing for a Chunkier texture.

SAFETY - RULES FOR ATTACHMENTS

The following safety requirements should be read in conjunction with the Safety Rules provided for the base model, i.e., Kanga Loader, Kanga Kid, and the corresponding Operating Instructions accordingly. All tasks and risks associated with the activity are identified using the Job Safety and Environmental Analysis (JSEA) or Risk Assessment (RA) and ALL risk controls are to be identified and implemented before the work commences.

FORK LIFT TYNES SAFETY RULES

Always...

- Establish and maintain a minimum 4 meter (12 foot) exclusion zone around the local working area and ensure no person other than the operator, enters this zone whilst the machine's engine is running.
- Keep the general working area clear of bystanders and other workers. Loader operations typically rely on rapid movement and direction changes. It is important, therefore, that the whole operation area is kept clear of other personnel and operators maintain vigilance about their immediate surroundings.



FORK LIFT TYNES

Never...

- Place any article or body part under the tynes at any time.
- Carry passengers, either on the machine or on the tynes of the forklift.
- Overload the machine or tynes.
- Travel with the tynes raised, especially when carrying loads.

ANGLED BACK-FILL BLADE SAFETY RULES

Always...

- Establish and maintain a minimum 4 meter (12 foot) exclusion zone around the local working area and ensure no person other than the operator, enters this zone whilst the machine's engine is running.
- Keep the general working area clear of bystanders and other workers. Loader operations typically rely on rapid movement and direction changes. It is important, therefore, that the whole operational area is kept clear of other personnel and operators maintain vigilance about their immediate surroundings.



BACK FILL BLADE

Never...

- Place any article or body part under or near the angled back-fill blade at any time.

4 IN 1 BUCKET SAFETY RULES

Always...

- Establish and maintain a minimum 4 meter (12 foot) exclusion zone around the local working area and ensure no person other than the operator, enters this zone whilst the machine's engine is running.
- Keep the general working area clear of bystanders and other workers. Loader operations typically rely on rapid movement and direction changes. It is important, therefore, that the whole operation area is kept clear of other personnel and operators maintain vigilance about their immediate surroundings.
- Check with Local Authorities and land owners about the presence of underground services within the prospective working area prior to commencement of work. (Dial **1100** to establish any existing underground services before work commences.)
- Ensure excavations are located a minimum of 2 meters away from any underground service.



FOUR IN ONE BUCKET

Never...

- Place any article or body part between the jaws of an open bucket, or under the bucket at any time.

TRENCHER SAFETY RULES

Always...

- Establish and maintain a minimum 4 meter (12 foot) exclusion zone around the local working area and ensure no person other than the operator, enters this zone whilst the machine's engine is running.
- Check with Local Authorities and land owners about the presence of underground services within the prospective working area prior to commencement of work. (Dial **1100** to establish any existing underground services before work commences.)
- Ensure trenches are located a minimum of 2 meters away from any underground service.

Never...

- Place any article or body part under the trencher at any time



TRENCHER

POST HOLE AUGER & TREE PLANTER AUGER SAFETY RULES

Always...

- Establish and maintain a minimum 4 meter (12 foot) exclusion zone around the local working area and ensure no person other than the operator, enters this zone whilst the machine's engine is running.
- Check with Local Authorities and land owners about the presence of underground services within the prospective working area prior to commencement of work. (Dial **1100** to establish any existing underground services before work commences.)
- Ensure excavations are located a minimum of 2 meters away from any underground service.

Never...

- Place any article or body part under the auger at any time



POST HOLE AUGER

ROTARY HOE (TILLER) SAFETY RULES

Always...

- Establish and maintain a minimum 4 meter (12 foot) exclusion zone around the local working area and ensure no person other than the operator, enters this zone whilst the machine's engine is running.

Never...

- Place any article or body part near or under the Rotary Hoe at any time.
- Carry out maintenance of any type whilst the Rotary Hoe is attached to the Loader or any other power source.



ROTOR TILLER

BUCKET BROOM SAFETY RULES

Always...

- Establish and maintain a minimum 4 meter (12 foot) exclusion zone around the local working area and ensure no person other than the operator, enters this zone whilst the machine's engine is running.
- Keep the general working area clear of bystanders and other workers. Loader operations typically rely on rapid movement and direction changes. It is important, therefore, that the whole operation area is kept clear of other personnel and operators maintain vigilance about their immediate surroundings.
- Wear respiratory and eye protection whilst using the Bucket Broom.

Never...

- Place any body part under the bucket broom at any time.



BUCKET BROOM

LOG SPLITTER SAFETY RULES

Always...

- Establish and maintain a minimum 4 meter (12 foot) exclusion zone around the local working area and ensure no person other than the operator, enters this zone whilst the machine's engine is running.
- Use leather gloves to protect hands from wood splinters.
- Clear split logs away from the base of the machine, to ensure they do not interfere with the operation of the log splitter. When clearing away the split logs, ensure that the machine is shut down and the pressure released from the hydraulic controls.
- Wear eye protection.



Never...

- Place any article or body part under the log splitter at any time.
- Place any attachment, article or body part in the zone of travel of the log splitter.

TERMINATOR STUMP GRINDER SAFETY RULES

Always...

- Establish and maintain a minimum 12 meter (40 foot) exclusion zone around the local working area and ensure no person other than the operator, enters this zone whilst the Loader engine and/or Stump Grinder is/are running.
- Keep the general working area clear of bystanders and other workers. Loader operations typically rely on rapid movement and direction changes. It is important, therefore, that the whole operation area is kept clear of other personnel and operators maintain vigilance about their immediate surroundings.
- Check with Local Authorities and land owners about the presence of underground services within the prospective working area prior to commencement of work. (Dial 1100 to establish any existing underground services before work commences.)
- Install effective perimeter hoarding/barricades 6ft high around the exclusion zone.
- Wear respiratory and eye protection.



Never...

- Place any article or body part under, or in close proximity to, the Stump Grinder at any time.
- Touch the exhaust, engine parts, hydraulic pipes and fittings, guards or Stump Grinder Wheel soon after use.

DAILY OPERATOR MAINTENANCE

INSPECTION AND CHECKS

Before each day's operation of the KANGA Loader, the **operator MUST** perform the inspection and checks as outlined below.

The purpose of the operator's inspection is to keep the equipment in a safe working condition and to detect any signs of malfunctioning during normal operations between scheduled maintenance checks.

While it may not be the operator's responsibility to perform mechanical maintenance, they should be thoroughly familiar with the unit, as this involves their own safety.

Many costly maintenance jobs can be prevented through observance of the following operator maintenance inspections and checks by KANGA Loader operators.

For expert advice and quality service, consult an expert repairer, we recommend an authorised kanga repairer.

The owner should retain evidence that proper maintenance has been performed as prescribed.

A claim against a warranty will not qualify if it results from lack of maintenance and not from defective material or authorised workmanship.



CAUTION: DO NOT operate a Kanga Loader that is known to be damaged or malfunctioning. Remove the key from the ignition and Tag Out the machine using an Out of Service tag and contact your Service Agent.

Defective components and/or equipment malfunctions can jeopardise the safety of the operator and other personnel and can cause extensive damage to the unit. Remember, a poorly maintained unit could become a great operational hazard.

DAILY CHECKS

Element		Yes	No	Comment
LOADER				
Wheels	Good condition/ adequate tread.			
	Adequate pressure.			
	Wheel nuts secure.			
Guarding	Good condition.			
	Secure.			
Hydraulics	Good condition of hoses (check for leaks).			
	Good condition of casings (check for leaks).			
	Good condition of rams (check for leaks).			
	Adequate hydraulic oil level.			
Controls	Correct operation.			
	Responsiveness.			
Structure	Adequate weld condition.			
	Free of cracks/damage.			
	Linkage Pins greased.			
Bolts and Fasteners	Check pivot pins for wear/damage.			
	Tight.			
	None missing or damaged.			
Battery	Terminals tight.			
	Free of corrosion.			
	Good condition (check indicator).			
Safety Decals	Legible.			
	All in place.			
Engine	Adequate crankcase oil level.			
	Check Air cleaner / Filter.			
Fuel	No Leakage.			
	Adquate Fuel Level.			
	Drain water tap if fitted (Optional Extra).			
Water (Diesel Loader)	Radiator Hoses/water level.			
Operating Manual	Present with machine.			
ATTACHMENT				
Guarding	Good condition.			
	Secure.			
Hydraulics	Good condition of hoses (Check for leaks).			
	Good condition of casings (Check for leaks).			
	Good condition of rams (Check for leaks).			
Controls	Correct operation.			
	Responsiveness.			
Structure	Adequate weld condition.			
	Free of cracks/damage.			
Bolts andFasteners	Tight.			
	None Missing.			
	Attachment locking pins in place.			
Decals	Legible.			
	All in place.			
Operating Supplement	Present with machine/attachment .			

LOADER ARM MAINTENANCE

INSPECTION AND CHECKS

Always...

- Secure the Arm using the supplied Locking Pins when carrying out maintenance activities, particularly when working with the Arm in the raised position.
- Keep a fire extinguisher on hand during maintenance operations.
- Ensure the working area is kept clean and free of oil, grease and debris.
- Designate the effective maintenance work area using witches hats.



BOOM MAINTENANCE

Never...

- Rely solely on the machine hydraulics to keep the Arm elevated whilst carrying out maintenance. Locking Pins should always be used to physically hold the boom in the raised position.
- Raise or lower the boom with the Locking Pins in place.



LOCKING PINS ARE KEPT TO THE LEFT SIDE OF THE CONTROLS.

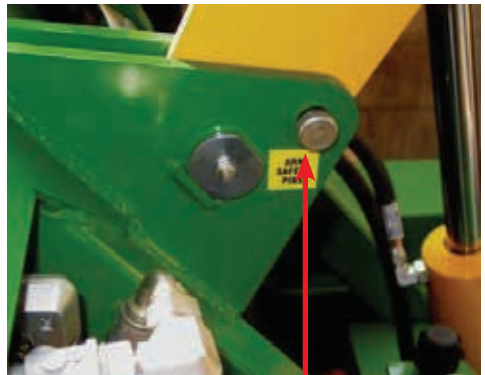

LOCKING PINS IN POSITION

Arm Safety Pin Replacement #DL-000782
Rubber Safety Pin Grommet #DL-000837

SERVICE TASKS

The following service work should only be carried out by a qualified Service Technician at intervals indicated on the Service Chart.

The operating hours are displayed by the Hour Meter on the Instrument Panel. The display will flash for 2 hours when a service is due. The flashing will cease after a two hour operating period has passed. Also displayed on the Instrument Panel on all Loaders are a Fuel Gauge, a Charge Warning Light and an Oil Warning Light. A Water Temperature Warning Light and Glow Plug Light are also included on the Instrument Panel for the Diesel Loaders only.

PETROL INSTRUMENT PANEL



Honda Replacement Key
#KS-000080 key

Hour Clock #DL-000817

LED LIGHTS

Amber #DL-000816

Green #DL-001442

Red #DL-000814

Blue #DL-001443

DIESEL INSTRUMENT PANEL



Kubota Replacement Key
#KS-000092

SERVICE TASKS - ENGINE

ENGINE OIL

Change the engine oil after the first 20 hours of operation and thereafter, after every 100 hours. Generally engine oil type SAE 10W-30 is recommended. See Engine Manual for details.

Ambient Temperature	Oil Type
Above 25°C (77°F)	SAE 30 or SAE10W-30/SAE10W-40
0°C to 25°C (32°F to 77°F)	SAE 20 or SAE10W-30/SAE10W-40
Below 0°C (32°F)	SAE 10 or SAE10W-30/SAE10W-40

ENGINE OIL FILTER (PETROL ENGINE) - Part Number #KS-000053

Replace the oil filter after every 100 hours of operation. See Engine Manual for details.

ENGINE OIL FILTER (DIESEL ENGINE) - Part Number #KS-000089

Replace the oil filter after every 100 hours of operation. See Engine Manual for details.

AIR FILTER (PETROL/DIESEL)

HONDA AIR FILTRATION - Part Number #KS-000034 (Element Only)

The pre cleaner foam should be washed out and re oiled when machine is working in dusty conditions every 8 hours of operation. Replace the air filter element after every 100 hours of operation, or sooner if operating in a dusty environment.

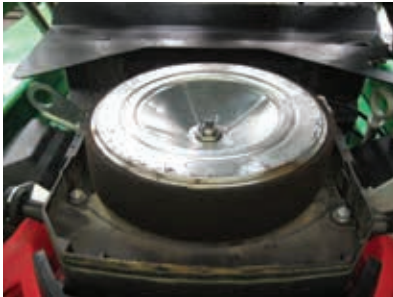

HONDA



DONALDSON

DONALDSON AIR FILTRATION – Part Number #DL-001227 (Element Only)

The pre cleaner bowl should be emptied out and when machine is working in dusty conditions every 8 hours of operation. Replace the air filter element after every 100 hours of operation, or sooner if operating in a dusty environment.

RADIATOR (DIESEL ENGINE) - Replacement Radiator Cap #KS-000081

The radiator fluid bottle should be checked every day and topped up where necessary and the system contains a pre mix of water and coolant to a 50/50 ratio, Water capacity is 3.1 litres. The radiator cap should be periodically checked for proper performance and replaced as required.

FAN BELT (DIESEL ENGINE) - Part Number #KS-000088

The Fan Belt should be checked regularly for signs of wear and changed in accordance with the Manufacturers recommendation (see engine manual).

FUEL FILTER FOR E 10 ETHANOL FUELS – Part Number # DL-001253

The Racor fuel filter if maintained daily and correctly will minimize the ingress of water and hard partials entering into the carburettor and causing corrosion and the engine to run rough. The 10 micron filter must be drained daily or at prior intervals if it becomes saturated with water so the operator must keep an eye on the filter saturation level, when water is visible in the see through bowl or engine performance is noticeably reduced service is required.

The aqua block filter can be cleaned and re used several times and replaced every 100 hours as per service chart however if it becomes dirty and completely blocked with hard partials it should be replaced sooner.

SERVICE INSTRUCTIONS

1. Make sure the engine is turned off and cool to touch.
2. Use a small catch container under the filter housing spin the see through bowl off the mounting head by turning in a counter clockwise motion.
3. Remove the aqua block filter and clean in a bath of Methylated spirits and thoroughly dry (do not use compressed air or you could damage the filter) re install or replace element if required with part number **DL-001253**.
4. Lubricate the filter bowl o-ring with motor oil and tighten by hand only don't use tools
5. Start engine and check for leaks correct any if necessary with the engine switched off.

NOTE: For Ethanol fuels that are stored for longer than 2 weeks and up to a Month a Fuel stabilizer additive is available P/N CONS-000732 and recommended to reduce phase separation of the Ethanol fuels.

FUEL FILTER FOR DIESEL FUELS – Part Number #DL-000500

Replace the fuel filter after every 100 hours of operation, or sooner if operating in a dusty environment.

IDLE SPEED

Check engine idle speed after every 200 hours of operation, and adjust if out of specification. See Engine Manual for details.

SPARK PLUGS (PETROL ENGINE) – Part Number #KS-000027

Replace after every 100 hours.

GLOW PLUGS (DIESEL ENGINE) – Part Number #KS-000341

See Engine Manual for details.

VALVE CLEARANCES (PETROL ENGINE)

Check and adjust engine valve clearances after every 200 hours of operation. See Engine Manual for details.

VALVE CLEARANCES (DIESEL ENGINE)

Check and adjust engine valve clearances after every 800 hours of operation. See Engine Manual for details.

SERVICE TASKS - HYDRAULICS

HYDRAULICS

Perform the following work after every 100 operating hours:

Check hydraulic fluid level (with arms down and oil cold) top up with Hydraulic Oil **ISO 68**

NOTE: A significant drop in fluid levels will indicate leakage. The appropriate cold fluid level is indicated on the site gauge.



Location of Filler Breather



Cold Fill Level

Hot Fill level

Inspect all hydraulic hoses, tubes, fittings, valves and rams for leaks and damage. Tighten loose fittings and replace damaged components. Check all three pressure settings every 200 hours (see procedure on following page) and adjust if necessary.)

HYDRAULIC FILTERS

Return line filter Replace the cartridge after every 200 operating hours.

PRESSURE FILTER

Replaced in line filter cartridge after every 500 operating hours.

Return Filter Element Part No: HA-000726

(Illustration shows housing)

Pressure Filter Element Part No: #KS-000381

(Illustration shows housing)

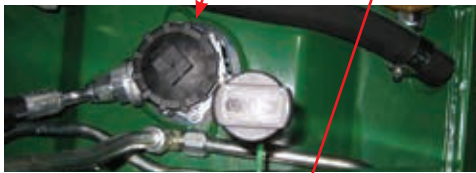

HYDRAULIC PRESSURE SETTINGS

The hydraulic system has three pressure settings which have to be set as follows:

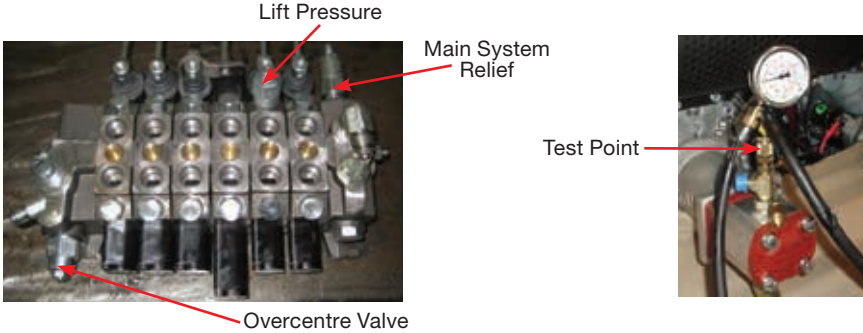

Before any testing is carried out run the engine and hydraulic system to warm the hydraulic oil. The oil cooler fan will engage at between 60 and 65°C (145°F).

All pressure settings are performed with the oil cooler fan on and engine running at full speed (3,600 rpm).

OVER CENTRE VALVE

Connect an accurate pressure gauge with a range **0-300 bar (0-4,300 PSI)** to the **Test Point**.
The pressure should be set at: 34-41 bar (500-600 PSI) for the 11.3cc Pump

NOTE: If adjustment is required slacken off the lock nut and using a 5mm hex key wind in the screw in to increase the pressure or out to reduce the pressure. Retighten the lock nut when adjustments are complete.

MAIN SYSTEM RELIEF PRESSURE

Connect an accurate pressure gauge with a range **0-300 bar (0-4,300 PSI)** to the **Test Point**.

Check the pressure while pulling the **tilt control lever** at the end of the ram's stroke.

The pressure should be set at: 207 bar (3,000 PSI) for the Petrol models and 220 bar (3,200 PSI) for Diesel Models.

NOTE: If adjustment is necessary slacken off the lock nut on the main pressure relief valve and wind in the screw to increase the pressure or back off the screw to reduce the pressure. Retighten the lock nut when adjustments are complete.

LIFT PRESSURE

Connect an accurate pressure gauge with a range **0-300 bar (0-4,300 PSI)** to the Test Point. Check the pressure while pulling the arm control lever at the end of the ram's stroke (boom fully raised).

The pressure should be set at: 165 bar (2,400 PSI) for Mid Range Loaders.

NOTE: If adjustment is necessary unscrew the cap lock nut on the lift pressure relief cartridge and wind in the screw using an allen key to increase the pressure or back off the screw to reduce the pressure. Refit and tighten the lock nut when adjustments are complete.

HYDRAULIC FLUID

Replace the hydraulic oil after every 1,000 operating hours.
(Hydraulic Oil ISO 68)

HYDRAULIC OIL DRAIN PLUG

Situated between the wheel motors on the left hand side of Loader



TRENCHING VALVE

DESCRIPTION

The trenching valve is specially designed to convert the Kanga Loader together with the trencher attachment into a high performance trenching machine. The valve provides load sensing to ensure the trencher travel speed stays balanced to the trencher cutting speed regardless of the ground conditions.

The trencher valve assembly comprises a group of cartridges forming a complex circuit. Servicing and repair to the trencher valve is usually restricted to cartridge element replacement.

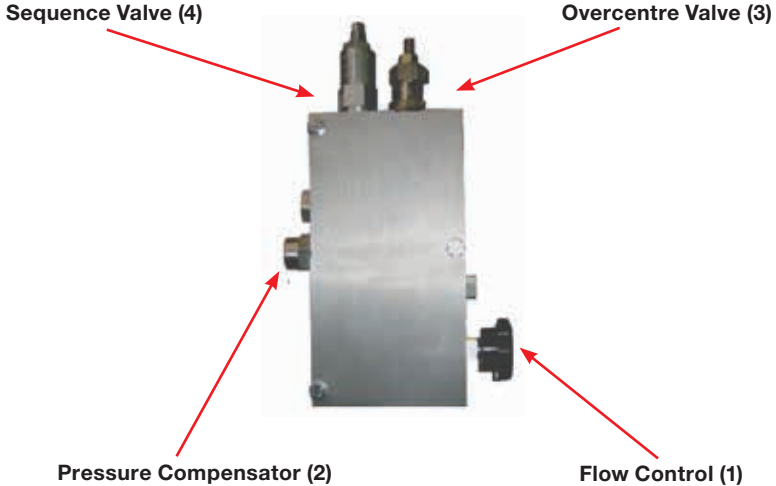

CIRCUIT DESCRIPTION

When starting the trenching chain (Aux. Lever down) oil is flowing to VLV A port of the trencher valve. Priority oil flows through the flow control valve (1) and pressure compensator (2) to VLV B port and back to the main control valve for use by the drive motors. Trenching travel speed is adjusted by the flow control valve (1) with speed being constant regardless of trenching and travel loads. Once the priority flow requirements are satisfied excess flow is permitted to flow through the pressure compensator (2) to the A port and to the trencher motor.

NOTE: If the flow control valve (1) is fully closed all flow is directed to the trencher motor and no oil can flow to the drive motors; no regulating occurs.

Return oil from the trencher motor flows through the C port and the over centre valve (3) to the Tank (T) port.

In the event of excessively hard trenching with the drive motor driving against the trenching chain the drive circuit pressure will rise above the setting of the sequence valve (4) and it oil will get diverted to the tank. In this condition a constant load is held against the trenching chain by the drive motors. When reversing the trencher chain (Aux. Lever up) eg. to clear the chain from rocks or wood, oil flow is directed to port VLV B. System pressure will rise to the setting of the sequence valve (4) and then flow will get diverted to port C and therefore reversing the trencher motor.

NOTE: If the flow control valve (1) is fully closed all flow is directed to the trencher motor and no oil can flow to the drive motors; no regulating occurs.

Return oil from the trencher motor flows through the C port and the over centre valve (3) to the Tank (T) port.

PRESSURE SETTINGS

Before adjusting anything on the trencher valve check all main pressure settings as outlined in chapter “Service Tasks - Hydraulics’ from the Operators Manual.

With the same setup as outlined there: hydraulic oil warmed up, pressure gauge (0-300 bar / 0-3400 PSI) plugged into test point, engine running at full speed (3600 rpm) do the following:

Over Centre Valve (3) Setting

Flow Control Valve (1) fully closed (turned clockwise).

Aux. Lever (3) on main control valve **down** (trencher chain running forward).

The pressure should be set at: 69 – 76 bar (1000-1100 PSI) on all models.

Sequence Valve (4) Setting

Flow Control Valve (1) fully closed (turned clockwise).

Aux. Lever (3) on main control valve up (trencher chain running backwards).

The pressure should be set at: 186 bar (2700 PSI) on Mid Range Petrol Models

186 bar (2700 PSI) on Mid Range Diesel Models

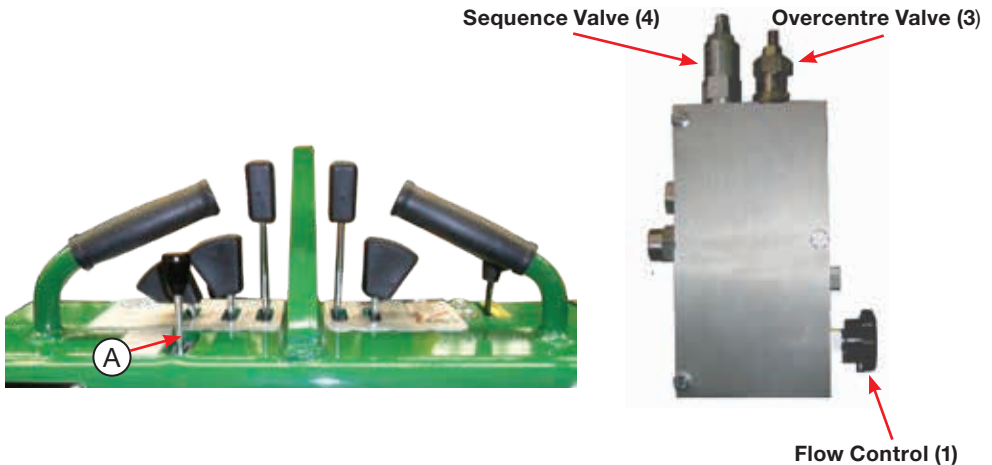

Checking Trenching Valve Function

- With trencher above ground and chain running forward (**Aux Lever (A) down**) pull both drive levers backwards (to reverse Loader) and then start opening **Flow Control valve (1)** slowly.
- The loader should start moving backwards.
- The more the valve is opened the faster the loader should move.

SERVICE TASKS - VISUAL

VISUAL CHECK

Check all over machine for loose bolts, cracks and dents after every 100 operating hours. Tighten loose bolts, and replace if worn or damaged.

SERVICE TASKS - RADIATOR (DIESEL)

RADIATOR

Radiator Hoses and connections should be checked on a regular basis for cracks and wear and the radiator checked for leaks, the radiator fluid should be changed every two years with a coolant to water ratio of 50/50, check the fan belt for wear and replace as required.

SERVICE TASKS - BATTERY

BATTERY- Part Number #DL-000605

The battery provided with the Loader is maintenance free. An indicator at the top of the battery displays its condition according to a displayed colour. Ensure that the terminals are tight and that covers and battery leads are not damaged.

SERVICE TASKS - GREASE NIPPLE

GREASE

Grease* and inspect for wear, all eleven (11) **linkage pins** after every 8-10 operating hours. (Grease type Castrol APX T or equivalent).

* The frequency for regreasing depends on the workload and the severity of the working conditions. Regreasing during the day of operation may be necessary (see Daily Checks).



Grease Nipples ○

SERVICE TASKS - PIVOT PINS

BOTTOM PIVOT PINS

Before every use, visually inspect all pivot pins for any signs of wear and damage or possible failure. Thoroughly inspect all pivot pins and bushes for wear and damage at an interval of 200 operating hours.

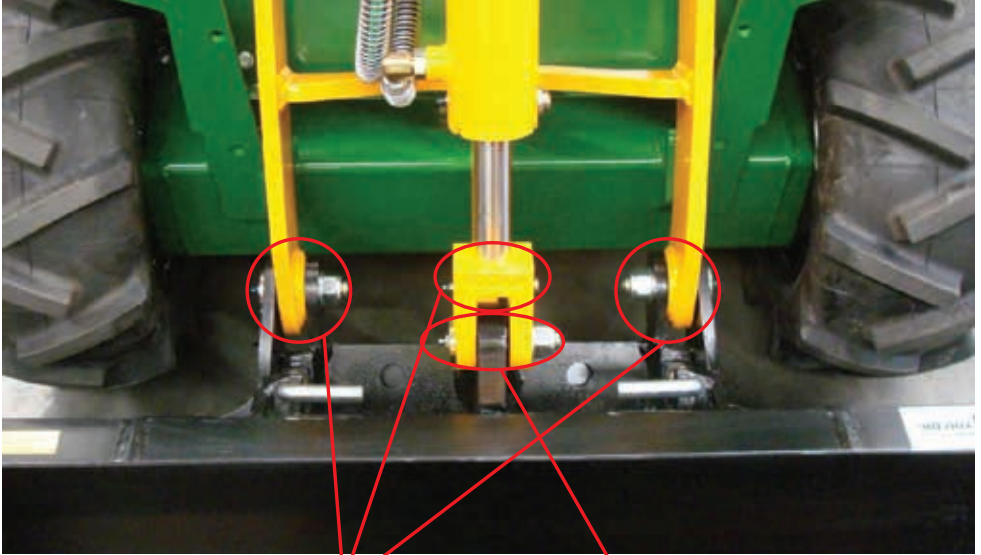

Part No. #0K10800

Part No. #0K10903

#0K10700
#0K10800
#0K10810
#0K10900
#0K10903
#DL-000222
#DL-000158

PIN A (44MM) KIT	x2
PIN B (51MM) KIT	x3
PIN D (55MM) KIT	x2
PIN C (60MM) KIT	x2
PIN G (65MM) KIT	x2 Piston End
BUSH IRB 1610	x2
TOP BUSH IRB 1616	x5

SERVICE TASKS - TYRES & PRESSURE

MID RANGE

TYRE 23 X 850 X 12 LUG

Part Number-#DL-000624

TYRE 23 TURF KENDA 23 X 10-5 X 12

Part Number-#DL-001502

TUBELESS VAL 10-12 RIM

Part Number-#DL-000995

7 X 12 RIM COMPLETE

Part Number-#DL-004014-BL

NUTS WHEEL 7/16 UNF

Part Number-#FA-000530

STUD WHL 7-16 KNOCK-IN

Part Number-#DL-000458

Visually check tyres on a daily basis and check tyre pressure every 50 operating hours, and check for wear and damage to tyres and tracks.

Tyre pressures:

KANGA LOADER TYRE PRESSURES GROSS				
Tyre	Size	Recommended Pressure		Gross weight Kgs (Water Filled)
		KPA	PSI	
Lug 23"	23 X 8.5 X 12	260	38	40
Turf 23"	23 X 8.5 X 12	150	22	40

DECALS - PETROL LOADER

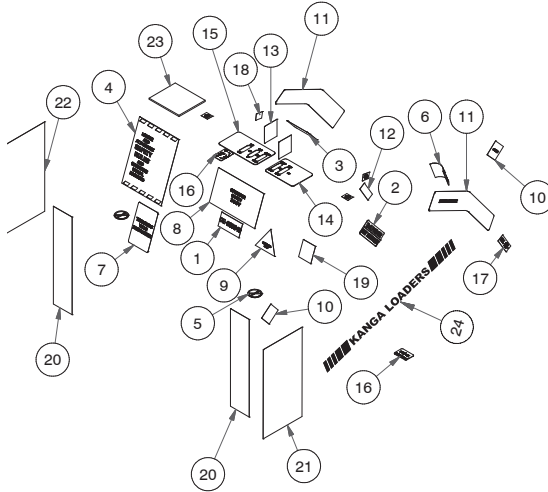

ITEM	QTY	PART NUMBER	DESCRIPTION	KMN
1	1	DE-000046	DECAL (DIAL 1100) - SMALL - 90MM x 35MM	L118594
2	1	DE-000176	DECAL - LOADER - DANGER HOT EXHAUST	L118571
3	1	DE-000177	DECAL - LOADER - WARNING SHUT OFF ENGINE	L118675
4	1	DE-000178	DECAL - LOADER - MANUAL HOLDER	L118572
5	2	DE-000183	DECAL - LOADER - NO SMOKING	L118596
6	1	DE-000185	DECAL - LOADER - CRUSH TRIANGLE	L118561
7	1	DE-000188	DECAL - LOADER - TRENCHER VALVE INSTRUCTIONS	L118599
8	1	DE-000190	DECAL - LOADER - OPERATOR SAFETY 2-5-6-7	L118550
9	1	DE-000191	DECAL - LOADER - AUSTRALIAN MADE	L118565
10	2	DE-000192	DECAL - LOADER - TIE DOWN	L118563
11	1	DE-000736	DECAL - DW625 MODEL LH SIDE	
12	2	DE-000239	DECAL - LOADER - SWL 250-550	L118579
13	2	DE-000733	DECAL - MID RANGE LIFTING LUG	
14	1	DE-000234	DECAL - LOADER - NAME PLATE R/H DRIVE LIFT	L118431
15	1	DE-000235	DECAL - LOADER - NAME PLATE L/H DRIVE LIFT	L118451
16	1	DE-000236	DECAL - LOADER - NAME PLATE AUXILLARY	L118460
17	1	DE-000237	DECAL - LOADER - NAME PLATE HYDRAULIC OIL	L118480
18	4	DE-000238	DECAL - LOADER - ARM SAFETY PIN	L118632
19	1	DE-000731	DECAL - KANGA SERVICE AND SPARES NUMBER	
20	2	DE-000735	DECAL - KANGA WITH WITH UNLEADED FUEL LEVEL	
21	1	DL-000993	DECAL - COMMON LOADER PART - SAFETY INSTRUCTIONS DVD	L118580
22	1	DE-000730	DECAL - DW625 MODEL RH SIDE	
23	2	DE-000734	DECAL - AUSTRALIAN MADE	
24	2	DE-000924	DECAL - KANGA LOADERS	

DECALS - DIESEL LOADER

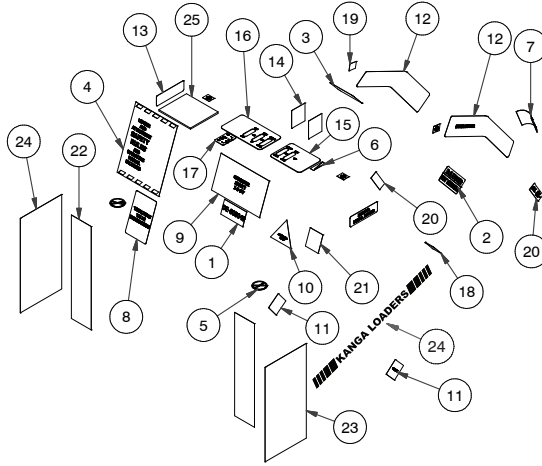

ITEM	QTY	PART NUMBER	DESCRIPTION	KMN
1	1	DE-000046	DECAL (DIAL 1100) - SMALL - 90MM x 35MM	L118594
2	1	DE-000176	DECAL - LOADER - DANGER HOT EXHAUST	L118571
3	1	DE-000177	DECAL - LOADER - WARNING SHUT OFF ENGINE	L118675
4	1	DE-000178	DECAL - LOADER - MANUAL HOLDER	L118572
5	2	DE-000183	DECAL - LOADER - NO SMOKING	L118596
6	1	DE-000184	DECAL -LOADER- THROTTLE STICKER	L118577
7	1	DE-000185	DECAL - LOADER - CRUSH TRIANGLE	L118561
8	1	DE-000188	DECAL - LOADER - TRENCHER VALVE INSTRUCTIONS	L118599
9	1	DE-000190	DECAL - LOADER - OPERATOR SAFTY 2-5-6-7	L118550
10	1	DE-000191	DECAL - LOADER - AUSTRALIAN MADE	L118565
11	2	DE-000192	DECAL - LOADER - TIE DOWN	L118563
12	1	DE-000737	PW628 MODEL LH SIDE	
13	2	DE-000221	DECAL - POWERED BY KUBOTA	L118646
14	2	DE-000733	DECAL - MID RANGE LIFTING LUG	
15	1	DE-000234	DECAL - LOADER - NAME PLATE R/H DRIVE TILT	L118431
16	1	DE-000235	DECAL - LOADER - NAME PLATE L/H DRIVE LIFT	L118451
17	1	DE-000236	DECAL - LOADER - NAME PLATE AUXILLARY	L118460
18	1	DE-000237	DECAL - LOADER - NAME PLATE HYDRAULIC OIL	L118480
19	4	DE-000238	DECAL - LOADER - ARM SAFETY PIN	L118632
20	2	DE-000239	DECAL - LOADER - SWL 250 - 550	L118579
21	1	DE-000731	DECAL - KANGA SERVICE AND SPARES NUMBER	
22	2	DE-000732	DECAL - KANGA WITH DIESEL FUEL LEVEL	
23	1	DL-000993	DECAL - COMMON LOADER PART - SAFETY INSTRUCTIONS DVD	L118580
24	1	DE-000729	DECAL - PW628 MODEL RH SIDE	
25	2	DE-000734	DECAL - AUSTRALIAN MADE	

DECALS - LPG LOADER

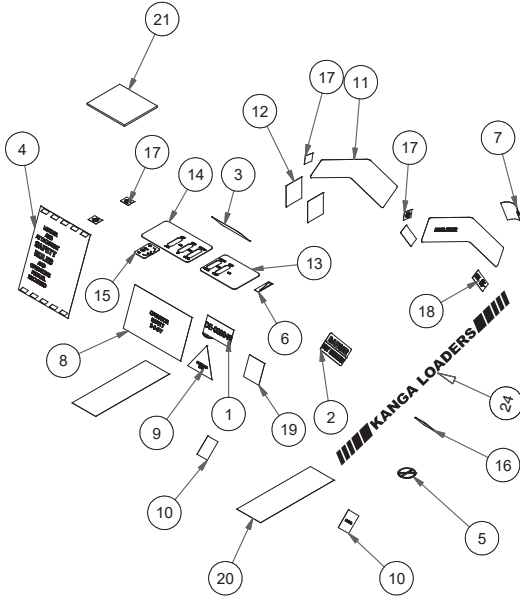

ITEM	QTY	PART NUMBER	DESCRIPTION	KMN
1	1	DE-000046	DECAL (DIAL 1100) - SMALL - 90MM x 35MM	L118594
2	1	DE-000176	DECAL - LOADER - DANGER HOT EXHAUST	L118571
3	1	DE-000177	DECAL - LOADER - WARNING SHUT OFF ENGINE	L118675
4	1	DE-000178	DECAL - LOADER - MANUAL HOLDER	L118572
5	2	DE-000183	DECAL - LOADER - NO SMOKING	L118596
6	1	DE-000184	DECAL -LOADER- THROTTLE STICKER	L118577
7	1	DE-000185	DECAL - LOADER - CRUSH TRIANGLE	L118561
8	1	DE-000190	DECAL - LOADER - OPERATOR SAFTY 2-5-6-7	L118550
9	1	DE-000191	DECAL - LOADER - AUSTRALIAN MADE	L118565
10	2	DE-000192	DECAL - LOADER - TIE DOWN	L118563
11	2	DE-000193	DECAL - LOADER - KANGA POWER	L118658
12	2	DE-000226	DECAL - LOADER - 5-6-7 SERIES LIFTING LUG	
13	1	DE-000234	DECAL - LOADER - NAME PLATE R/H DRIVE TILT	L118431
14	1	DE-000235	DECAL - LOADER - NAME PLATE L/H DRIVE LIFT	L118451
15	1	DE-000236	DECAL - LOADER - NAME PLATE AUXILLARY	L118460
16	1	DE-000237	DECAL - LOADER - NAME PLATE HYDRAULIC OIL	L118480
17	4	DE-000238	DECAL - LOADER - ARM SAFETY PIN	L118632
18	2	DE-000239	DECAL - LOADER - SWL 250 - 550	L118579
19	1	DE-000731	KANGA SERVICE AND SPARES NUMBER	
20	2	DE-000276	DECAL LOADER LPGAS LPB22	
21	1	DL-000993	COMMON LOADER PART - SAFETY INSTRUCTIONS DVD	L118580

SERVICE CHART

MAINTENANCE INTERVAL	NUMBER OF HOURS																			
	TYPE HOURS	MIN 20	INT 100	MIN 200	INT 300	MIN 300	INT 400	MAJ 500	MIN 600	INT 700	MIN 800	INT 800	MIN 900	MAJ 1000	MIN 1100	INT 1200	MIN 1300	INT 1400	MAJ 1500	
ENGINE OIL (PETROL)		R	R	R	R	R	R	R	R	R	R	R	R	R	R	R	R	R	R	R
ENGINE OIL (DIESEL)		R	R	R	R	R	R	R	R	R	R	R	R	R	R	R	R	R	R	R
ENGINE OIL FILTER (PETROL)	I	R	R	R	R	R	R	R	R	R	R	R	R	R	R	R	R	R	R	R
ENGINE OIL FILTER (DIESEL)	I	R	R	R	R	R	R	R	R	R	R	R	R	R	R	R	R	R	R	R
AIR FILTER ELEMENT *	I	R	R	R	R	R	R	R	R	R	R	R	R	R	R	R	R	R	R	R
FUEL FILTER *	I	R	R	R	R	R	R	R	R	R	R	R	R	R	R	R	R	R	R	R
SPARK PLUGS (PETROL)		R	R	R	R	R	R	R	R	R	R	R	R	R	R	R	R	R	R	R
IDLE SPEED (PETROL)	I		A		A		A		A		A		A		A		A		A	
IDLE SPEED (DIESEL)	I		A		A		A		A		A		A		A		A		A	
VALVE CLEARANCE (PETROL)		A		A		A		A		A		A		A		A		A		A
VALVE CLEARANCE (DIESEL)																				
FAN BELT (DIESEL)	I	I	I	I	I	I	I	R	I	I	I	I	I	R	I	I	I	I	I	R
HYDRAULIC HOSE/TUBE	I	I	I	I	I	I	I	I	I	I	I	I	I	I	I	I	I	I	I	I
HYDRAULIC FLUID (ISO68)	I	I	I	I	I	I	I	I	I	I	I	I	I	R	I	I	I	I	I	I
HYDRAULIC RETURN FILTER		R	R	R	R	R	R	R	R	R	R	R	R	R	R	R	R	R	R	R
HYDRAULIC PRESSURE FILTER	I	I	I	I	I	I	I	R	I	I	I	I	I	R	I	I	I	I	I	R
TYRE PRESSURES	I	I	I	I	I	I	I	I	I	I	I	I	I	I	I	I	I	I	I	I
ITEMS TO BE CHECKED ON A DAILY BASIS																				
DAILY																				
PRE-CLEANER FOAM *		C	C	C	C	C	C	C	C	C	C	C	C	C	C	C	C	C	C	C
VISUAL CHECK (CRACKS, WEAR)		I	I	I	I	I	I	I	I	I	I	I	I	I	I	I	I	I	I	I
RADIATOR WATER LEVEL (DIESEL)		I	I	I	I	I	I	I	I	I	I	I	I	I	I	I	I	I	I	I
GREASE NIPPLES/ PINS																				
L - [EVERY 8-10 HRS]																				

Replace

Clean as required

Lubricate as Necessary

A Adjust as Necessary

I Inspect, Fill Up, Tighten or Replace as Necessary

* Denotes - May need Serviced at more regular intervals if working in dusty conditions.

MAINTENANCE SCHEDULE MID RANGE LOADER

MODEL	MINOR SERVICE 20Hr	MINOR SERVICE 100Hr	INTERMEDIATE SERVICE 200Hr	MINOR SERVICE 300Hr	INTERMEDIATE SERVICE 400Hr
	DATE _____ SERVICE STAMP	DATE _____ SERVICE STAMP	DATE _____ SERVICE STAMP	DATE _____ SERVICE STAMP	DATE _____ SERVICE STAMP
	MAJOR SERVICE 500Hr	INTERMEDIATE SERVICE 600Hr	MINOR SERVICE 700Hr	INTERMEDIATE SERVICE 800Hr	MINOR SERVICE 900Hr
	DATE _____ SERVICE STAMP	DATE _____ SERVICE STAMP	DATE _____ SERVICE STAMP	DATE _____ SERVICE STAMP	DATE _____ SERVICE STAMP
Mid Range	MAJOR SERVICE ** 1000Hr				
	SERVICE STAMP				

MAINTENANCE SCHEDULE MID RANGE LOADER - Continued

MODEL	MINOR SERVICE 1100Hr	INTERMEDIATE SERVICE 1200Hr	MINOR SERVICE 1300Hr	INTERMEDIATE SERVICE 1400Hr	MAJOR SERVICE 1500Hr
Mid Range	DATE _____	DATE _____	DATE _____	DATE _____	DATE _____
	SERVICE STAMP	SERVICE STAMP	SERVICE STAMP	SERVICE STAMP	SERVICE STAMP
	INTERMEDIATE SERVICE 1600Hr	MINOR SERVICE 1700Hr	INTERMEDIATE SERVICE 1800Hr	MINOR SERVICE 1900Hr	MAJOR SERVICE ** 2000Hr
	DATE _____	DATE _____	DATE _____	DATE _____	DATE _____
	SERVICE STAMP	SERVICE STAMP	SERVICE STAMP	SERVICE STAMP	SERVICE STAMP

NOTE.

The warranty on the equipment is subject to the periodic maintenance being carried out at the intervals specified. If a service provider other than Kangra Loaders is used, maintenance records from the trade qualified provider may be required to support any claim.

Only genuine Kangra spare parts should be used during servicing.

** Denotes Hydraulic oil and Pressure filter require Changing for 1000Hr Services

SPECIFICATIONS - MID RANGE LOADER

PERFORMANCE	PW628		DW625	
Tipping load with 0kg bucket ¹	432 kg	951 lbs	477 kg	1049 lbs
Tipping load with 60kg GP bucket ¹	372 kg	819 lbs	417 kg	917 lbs
Tipping load with 130kg 4in1 bucket ¹	302 kg	665 lbs	347 kg	763 lbs
Tipping load for forks with 500mm fork arm ²	299 kg	657 lbs	336 kg	738 lbs
Tipping load for forks with 750mm fork arm ²	271 kg	596 lbs	304 kg	669 lbs
Rated operating capacity (ROC) with 0kg bucket ¹	216 kg	475 lbs	238 kg	525 lbs
Rated operating capacity (ROC) 60kg GP bucket ¹	186 kg	409 kg	208 kg	459 lbs
Rated operating capacity (ROC) 130kg 4in1 bucket ¹	151 kg	332 lbs	173 kg	382 lbs
Rated operating capacity (ROC) for forks with 500mm fork arm ²	149 kg	329 lbs	168 kg	369 lbs
Rated operating capacity (ROC) for forks with 750mm fork arm ²	135 kg	298 lbs	152 kg	334 lbs
Loader Mass ³	875 kg	1929 lbs	972 kg	2138 lbs
Travel Speed	7 km/h	4.3 mph	7.5 km/h	4.7 mph
Fuel Capacity	45 L	11.8 gal	45 L	11.8 gal
ENGINE				
Manufacturer	Honda GX690		Kubota D902	
Power Rating ⁴	16.5 KW	22.1 hp	17.5 KW	23.5 hp
DRIVE SYSTEM				
Drive Control	Soft Touch Hand Levers		Soft Touch Hand Levers	
Throttle Control	Hand Levers		Hand Lever	
Wheels	Direct Drive - Hydraulics Motors		Direct Drive - Hydraulic Motors	
HYDRAULICS				
Gear Pump Displacement	11.3 cc/rev	0.69 cu.in/rev	12.5 cc/rev	0.76 cu.in/rev
Pump Output	41 L/min	10.75 US gal/min	45 L/min	11.9 US gal/min
System Pressure	207 bar	3000psi	220 bar	3200 psi
Hyd. Reservoir Capacity	70 L	17.4 US gal	70 L	17.4 US gal
BUCKETS				
Standard Bucket Capacity (heaped / struck volume) ⁵	0.12 m ³ / 0.09 m ³	4.24 cu.ft / 3.21 cu.ft	0.12 m ³ / 0.09 m ³	4.24 cu.ft / 3.21 cu.ft
4 in 1 Bucket Capacity (heaped / struck volume) ⁵	0.118 m ³ / 0.092 m ³	4.17 cu.ft / 3.25 cu.ft	0.118 m ³ / 0.092 m ³	4.17 cu.ft / 3.25 cu.ft
DIMENSIONS				
A Max Operating Height	2510 mm	98.8"	2510 mm	98.8"
B Height to Hinge Pin	1865 mm	73.4"	1865 mm	73.4"
C Overall Height	1370 mm	53.9"	1370 mm	53.9"
D Overall Length With Bucket	2200 mm	86.6"	2200 mm	86.6"
E Overall Wheel Width	1030 mm	40.6"	1030 mm	40.6"
F Bucket Reach at 40°	410 mm	16.1"	410 mm	16.1"
Bucket Max Reach (Level)	1010 mm	39.8"	1010 mm	39.8"
G Dump Height Std. Bucket	1120 mm	44.1"	1120 mm	44.1"
Dump Height 4 in 1 Bucket	1855 mm	73"	1855 mm	73"
H Bucket Width	1070 mm	42.1"	1070 mm	42.1"
I Bucket Max Roll Back	30°		30°	
J Bucket Max Dump Angle	60°		60°	
K Ground Penetration	410 mm	16.1"	410 mm	16.1"
L Overall Length Less Bucket	1660 mm	65.4"	1660 mm	65.4"
M Ground Clearance	185 mm	7.3"	185 mm	7.3"
N Angle of Departure	30°		30°	
Approach Angle	50°		50°	

¹Tipping load and Rated Operating Capacity (ROC) have been determined to ISO 14397-1. Though the values shown here are for the material load and bucket mass combined, this is to represent the general loader capabilities and cannot be used for material load without adjusting for the specific attachment. Referring to the section of this manual "Practice Safety 44.11 Times", these adjustments have been made for a range of kenac buckets and fork types. Note that ROC is 50% of the Tipping load for wheel loaders and 45% for kenac "over the track" loaders.

² Loader Mass is calculated in accordance with ISO 6750-1:2019 (E) which is based on the most usual configuration as specified by the manufacturer. This is the mass of the loader and fluids only. Specifically, the operating mass without the operator or bucket mass.

³ Power Rating is the power in the production engine only as measured in accordance with SAE J1349 at 3000 RPM. Mass production engines vary from this value. Actual power output for the engine installed in the delivered machine may vary depending on numerous factors. These factors can include operation speed of the engine in the application, environmental conditions, and other variables.

⁴ Figures based on ISO 14397:2019

DIMENSIONS - MID RANGE LOADER

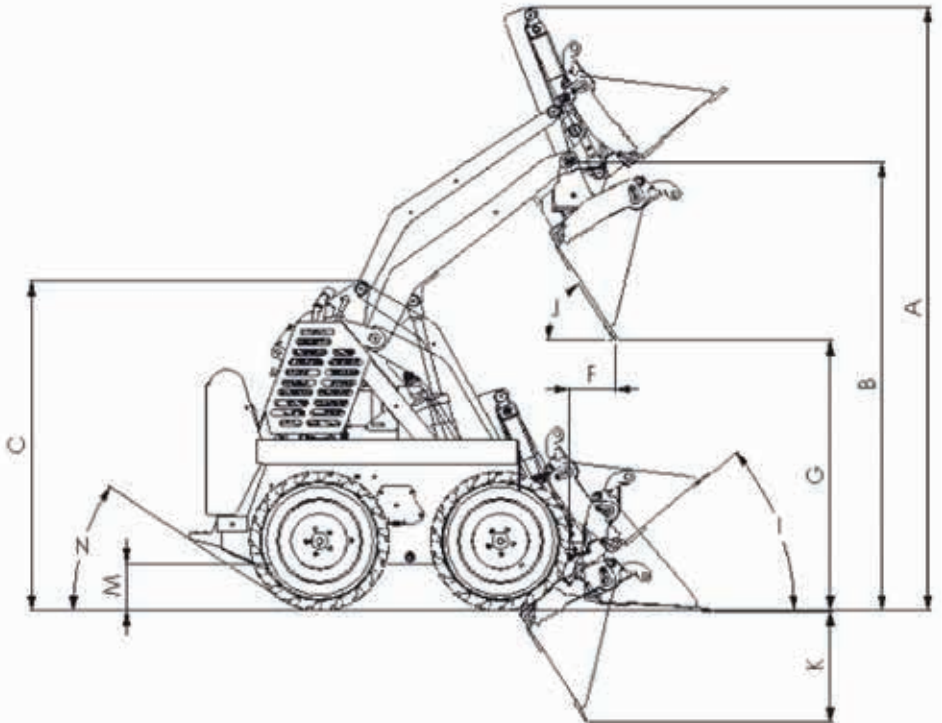
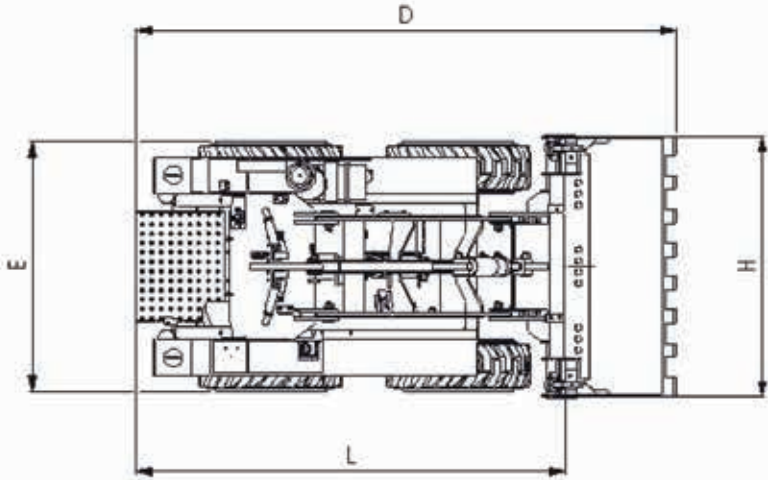

TROUBLESHOOTING

This section contains trouble-shooting information to be used for locating and correcting problems which may develop with your KANGA Loader. Troubleshooting and maintenance information relating to the engine are contained in the Engine Manual.

ARMS

TROUBLE	PROBABLE CAUSE	REMEDY
Arm will not rise.	Load capacity exceeded.	Reduce load. Load should not exceed the specified ROC displayed on the machine.
	Hydraulic system oil level low.	Check oil and replenish as necessary. Oil level should not change. Leaks may be present.
	Damaged or blocked hydraulic line.	Remove line and remove any obstructions or replace line as necessary.
	Malfunctioning hydraulic pump.	Replace Hydraulic Pump as necessary.
	Worn Control Valve spool.	Check pressure delivery from Control Valve. Contact Service Agent.
	Lift Control Valve relief set too low, allowing oil to return to reservoir.	Adjust relief valve to proper setting. Contact service Agent.
	Excessive oil leak past lift cylinder piston seal.	Repair or replace cylinder as necessary.
Arm will not lower.	Hydraulic oil system low.	Check oil and replenish as necessary. Oil level should not change. Leaks may be present.
	Damaged or blocked hydraulic line.	Remove line and remove any obstructions or replace line as necessary.
	Malfunctioning pump.	Replace Hydraulic Pump as necessary.
	Worn Control Valve spool.	Check pressure delivery from Control Valve. Contact Service Agent.
	Control rod or lever broken or disconnected.	Repair or replace control rod or lever.
Arm Lowers with control lever in neutral.	Worn Control Valve spool.	Repair or replace valve as required.
	Lift ram piston seal leaking.	Replace seals.
Arm will not rise, or rises slowly.	Lift Control Valve relief set too low allowing oil to return to reservoir.	Adjust relief valve to proper setting. Contact Service Agent.
	Worn Control Valve spool.	Check pressure delivery from Control Valve. Contact Service Agent.
	Excessive oil leak past lift cylinder piston seal.	Repair or replace cylinder as necessary.

	Control rod or lever broken or disconnected.	Repair or replace control rod or lever.
	Hydraulic lines incorrectly connected at Control Valve.	Correctly connect line at Control Valve.
Arm rises and lowers erratically.	Lift Control Valve relief set too low, allowing oil to return to reservoir.	Adjust relief valve to proper setting.
	Hydraulic system oil low.	Check oil and replenish as necessary. Oil level should not change. Leaks may be present.
	Damaged or blocked line.	Remove line and remove any obstructions or replace line as necessary.
	Malfunctioning pump.	Repair or replace hydraulic pump as necessary.
	Worn Control Valve spool.	Check pressure delivery from Control Valve. Repair or replace valve as required.
	Excessive oil leak past lift cylinder piston seal.	Repair or replace cylinder as necessary.
	Arm pivot pin seized or otherwise damaged.	Replace pivot pin and bushing as necessary. Grease thoroughly.

HYDRAULIC PUMP

TROUBLE	PROBABLE CAUSE	REMEDY
Flow from hydraulic pump erratic or non existent.	Hydraulic system oil low.	Check oil and replenish as necessary. Oil level should not change. Leaks may be present.
	Damaged or blocked line.	Remove line and remove any obstructions or replace line as necessary.
	Worn or chipped pump gears.	Replace pump gears as necessary.
	Worn or broken drive shaft or coupling.	Inspect drive shaft or coupling. Repair or replace as necessary.
Hydraulic pump noisy.	Air in hydraulic system.	Check suction side or hydraulic system for defects and repair as necessary. Ensure no leaks exist in the suction line.
	Hydraulic system oil low.	Check oil and replenish as necessary. Oil level should not change. Leaks may be present.
	Worn or broken drive shaft or coupling.	Inspect drive shaft or coupling. Repair or replace as necessary.
	Worn or chipped pump gears.	Replace pump gears as necessary.

DRIVE SYSTEM

TROUBLE	PROBABLE CAUSE	REMEDY
Machine will not drive forwards or backwards.	Hydraulic system oil low.	Check oil and replenish as necessary. Oil level should not change. Leaks may be present.
	Worn Control Valve spool.	Check pressure delivery from Control Valve. Repair or replace valve as required.
	Damaged or blocked line.	Remove line and remove any obstructions or replace line as necessary.
	Control rod or lever broken or disconnected.	Repair or replace control rod or lever.
	Hydraulic lines incorrectly connected at Control Valve.	Correctly connect line at Control Valve.
	Malfunctioning pump.	Repair or replace pump.
Machine drive speed is erratic.	Hydraulic system oil low.	Check oil and replenish as necessary. Oil level should not change. Leaks may be present.
	Damaged or blocked line.	Remove line and remove any obstructions or replace line as necessary.
	Binding drive motor(s).	Repair or replace motor(s) as necessary.
	Relief valve setting.	Adjust relief valve.

AUXILIARY HYDRAULIC

TROUBLE	PROBABLE CAUSE	REMEDY
Attachment is slow or will not function.	Hydraulic system oil low.	Check oil and replenish as necessary. Oil level should not change. Leaks may be present.
	Damaged or blocked line.	Remove line and remove any obstructions or replace line as necessary.
	Malfunctioning pump.	Replace Hydraulic Pump as necessary.
	Worn Control Valve spool.	Check pressure delivery from Control Valve. Repair or replace valve as required.
	Attachment plate pivot pin seized or otherwise damaged.	Replace pivot pin and bushing as necessary. Grease thoroughly.
	Excessive oil leak past cylinder piston seal or motor rotating group.	Repair or replace cylinder motor as necessary.
	Control rod or lever broken or disconnected.	Repair or replace control rod or lever.

ENGINE

TROUBLE	PROBABLE CAUSE	REMEDY
Engine will not crank over.	Low battery output.	Recharge or replace battery.
	Loose, disconnected or broken battery cables.	Inspect cable(s) and tighten all connections. Repair or replace cables as necessary.
	Faulty Starter.	Repair or replace starter.
	Faulty circuit wiring.	Check wiring continuity.
	Engine flooded (petrol).	Remove spark plug and crank.
Engine cranks but not fires.	No fuel in tank.	Refill fuel tank.
	Spark plug fouled (petrol engines).	Check spark plug gap and clean or replace spark plug.
	Dirty fuel filter.	Clean filter.
	Carburettor flood (petrol engines).	Clear carburettor.
	Fuel valve closed.	Open valve.
Engine runs but stalls.	Spark plug fouled (petrol engines).	Check spark plug gap & clean or replace.
	Fuel valve closed.	Open valve.
	Low battery output.	Recharge or replace battery.
	Power take-off engaged	Shift power take-off lever into neutral.

