





CONTENTS *SIDAS WINTER 2020/2021*

ANALYSIS	<i>p. 08-15</i>
WARMTH	<i>p. 16-17</i>
INSOLES	<i>p. 18-39</i>
EQUIPMENT	<i>p. 40-47</i>
INNERBOOTS	<i>p. 48-53</i>
SOCKS	<i>p. 54-61</i>
FITTING SERVICES	<i>p. 62-71</i>
FOOT PRODUCTS	<i>p. 72-75</i>
BOOT & SHOE ACCESSORIES	<i>p. 76-85</i>
MARKETING	<i>p. 86-87</i>

ENJOY
FULLY!

SIDAS WORLD

SIDAS: A PARTNER FOR EVERYONE WHO WANTS TO GIVE THEIR FEET THE COMFORT AND PROTECTION THEY NEED FOR EACH NEW SPORT AND EACH NEW DAY

The success of Sidas' various projects is achieved by combining our passion for sport with the expertise of athletes, orthopaedic centres and sports experts. Sidas offers a wide range of products: insoles, foot protections, shoes, ski liners, socks, thermal socks, insoles and accessories.





PODIATECH
SIDAS MEDICAL 

Podiatech offers a full range of equipment and consumables for podiatry and foot care, in order to meet the needs of foot care professionals and their patients.



FOOT ORTHOTICS



FOOT CARE



OPCT LAB

SIDAS
YOUR FOOT COMPANY™ 

Sidas designs 360° foot care products, including comfort solutions adapted for all types of sport and all types of wear.



SKI



OUTDOOR



RUNNING



DAILY LIFE

THERM-IC

Therm-ic develops thermal products to help users stay warm when participating in winter sports and activities, allowing them to get the most out of their pursuits.



SNOWSPORT



OUTDOOR ACTIVITIES



RUNNING



EVERYDAY OUTSIDE

corpus.e

Corpus-e creates tools for analysis and data harvesting in order to recommend the best-suited products for each consumer through its digital expertise. Sidas and Corpus-e have combined their skills, expertise and knowledge to develop products which are high-performance and adapt to the specific requirements of stores and customers.



DIGITAL PLATFORM



The Academy is born from the last 40 years of experience of Sidas world. Sidas and Podiatech have always trained their clients to be able to deliver the best custom products. The Academy wants to go further and share with you all our experience. Today the academy wants to be more... and share its experience, thanks to its network gathering the best world experts in their fields.



INFORM & EDUCATE

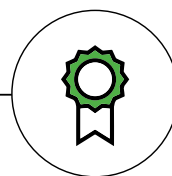

TRAIN & CERTIFY

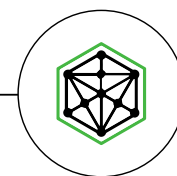

ANIMATE & CONNECT



THE FIT PROTOCOL IS A UNIQUE PROTOCOL MADE TO SERVE THE END-CONSUMERS; ANSWERING THE NEEDS OF RETAILERS AND INTEGRATING THE BRANDS IN THE PROCESS.

For 40 years, our know-how, our expertise for training and our retailers follow up; help us to create a protocol that guarantees the best experience for consumers, brands and retailers.

A win win win process between consumers, retailers and brands.

- consumers; feel good because they have great fitted shoes
- retailers: follow a specific protocol (for which they have been trained) to welcome a client and make the sale.
- brands: Are glad that retailers sell properly their products, responding to consumer needs.

To be part of the Fit Protocol program:

- Mandatory products
- Mandatory specific trainings
- Special marketing & communication tools
- Special business conditions



A new way to enjoy your sport fully



ANALYSIS

The fondation of a proper fit





ANALYSIS

MEASURING AND ANALYSIS TOOLS

FEETBOX 3D®

The Sidas & Corpus-e solution, a revolutionary new system: FEETBOX® 3D

Our AIM: to give your clients an in-store experience, in order to enhance your business and services. The plate is equipped with a 360° camera that scans your feet and legs up to the knees, in order to obtain a 3D model of them. You can see all the measurements of your feet (length, width, thickness), ankles and calves on the screen. The system makes it possible to simulate the fitting of a customised insole and shoe whilst taking into account the thickness of the sock. After connecting to the database of footwear sold in your shop and a chat with your customer; Feetbox® 3D makes it possible to simulate fitting shoes that are suitable for your customer's feet, in accordance with their constraints, needs and budget. By virtually fitting the shoe on the feet, it also makes it possible to see the different areas where the feet are deformed that need to be considered. An unrivalled experience for the client and it saves you time. Using Feetbox® 3D gives the consumer a unique experience.



FEETBOX®
3D MOVIE

UNIQUE PROCESS

- Put on a pair of special socks.
- Scans both feet simultaneously up to the knee, in only 20 seconds.
- Analysis and calculation of anatomic data regarding
 - FEET VOLUME
 - FEET PRESSURE
 - LEG ALIGNMENT
 - FUNCTION COMPARED TO THE AVERAGE
- Fitting Tab: visualisation of feet with insoles, socks and shoes.
- Access to a database of the shoes available in shops.
- Virtually try on the shoes recommended by the shop's expert, which are suitable for your feet, your needs and your constraints. See the adjustment as it's made.
- Actually try on the complete solutions proposed by the shop expert to check that the footwear chosen is suitable.

1. 3D Scanner
2. Pressure platform
3. Mover
4. Sock storage
5. Screen
6. Magical socks

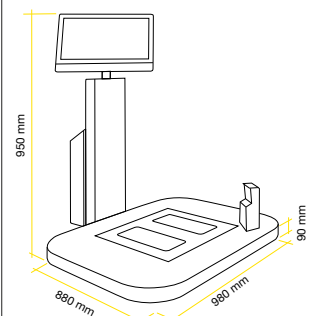

Ref. CMAFEETBOX3DPR

Ref. 313081101

3D Scanner Feetbox 3D, computer, kiosk, 25 pairs of socks

Ref. CMAFEETBOX3D

Ref. 312658101

3D Scanner Feetbox 3D, 25 pairs of socks

Ref. CMAFEETBOX3DCOMP

Ref. 313082101

All in one computer/touch screen



UNIQUE SOFTWARE

2 versions available: SHOOIQ Ski & SHOOIQ Ski BF.

SHOO IQ SKI

1



**REAL DATA BASE
 CENTRALIZATION**
 in a specific file
 for each consumer.

2

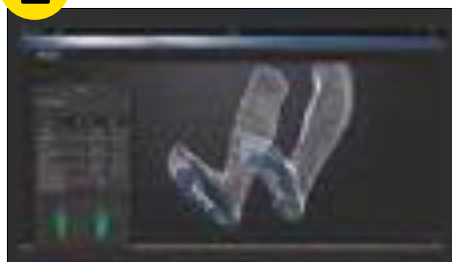

**ANALYSE: GIVES ANATOMICAL FOOT
 DATA COVERING**

- foot volumetry;
- foot pressure;
- leg alignment;
- compare to average function.

3



FITTING TAB
 Visualisation of the foot with insoles,
 socks, liners or shells.



SHOO IQ SKI BF

Includes the **SHOOIQ SKI** software (step 1, 2 & 3).

4



SKI BOOTS DATA BASE
 Access to CORPUS-E ski boots data
 base.

5

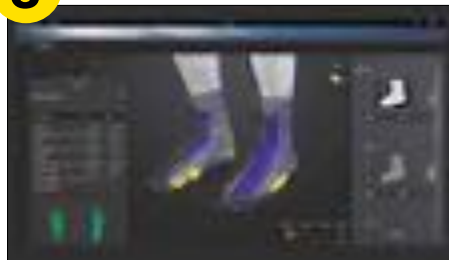

TRY ON
 Possibility to try on ski boots and
 visualization of the fitting.

6

STOCK
 Possibility to synchronise
 the stock of the shop
 with the software.



ANALYSIS

MEASURING AND ANALYSIS TOOLS

FEETBOX®

Ref. CMAFEETBOX3F-V2

Ref. 313359101

With this tool, your advice will be faster and clearer, and time spent using the Feetbox® creates an excellent opportunity to discuss individual foot problems and expectations with the customer. With just a single analysis, it will allow you to suggest a shoe and justify the suggestion of a suitable 3Feet® insole. Thanks to this exclusive Sidas technology, this analysis can be performed whilst the customer is wearing their socks!

- A sleek design suitable for any shop environment.
- Multi-unit length measurements.
- Efficient indication of foot volume: narrow / standard / wide.
- Quick and easy installation.
- No moving parts: system reliability.
- Wifi connection for online technical support.
- VGA connection for use with an external display.

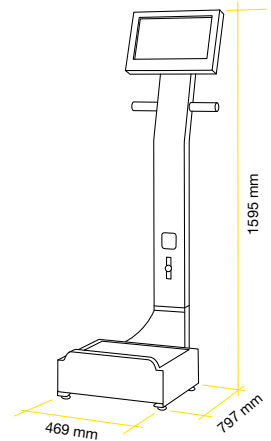

CONNECT®

Mandatory

The Connect® option is the solution which will enable you to collect your customers' data (measurements, footprints, types of feet) and enrich your contact database (access to all e-mail addresses and statistics on ShoolQbox's website).

- Screen with contact form at the end of the analysis
- Easy-to-use
- Enhanced, personalised experience for the client

OPTION SHOE SELECTOR

NEW

Thanks to the measurements taken by Feetbox 2D, complemented customer questionnaire, the Shoe Selector allows for an efficient and personally tailored ski boots based on the models pre-selected by the retailer.

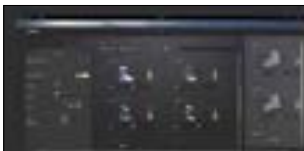

15" TOUCH SCREEN



SPOTLIGHT FOR IMAGE CAPTURE



3 HD WEBCAMS



SENSITIVE FOOTPRINT PAD

SMALL CARPET (included)



MARKETING TOOLS



FEETBOX® MAXI CARPET

Ref. CMKFEETBMAXCAR
 Ref. 311012101
 Dimensions : 135 x 160 cm

TRANSPORTATION CASE

Ref. CMAFEETBOXSID_CAIS
 Ref. 315563101



PROTECTION FRAME

Ref. CZFBPLEXIPROTECTION
 Ref. 314578101



FEETBOX® CUBE

Ref. CMKFEETBCUBE
 Ref. 311013101
 Dimensions : 48 x 48 x 48 cm

**FEETBOX®
 PROCESS**

1



Step onto the feet box.
 Touch the screen to begin.

2



Position feet on the marks.
 Touch the screen to begin the analysis.

3

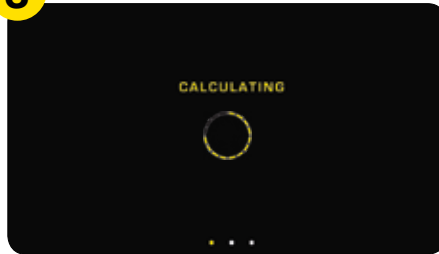

Wait 8 to 12 seconds for calculation.

4

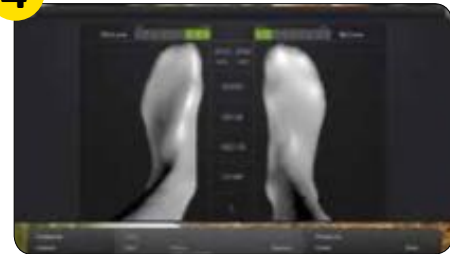

Foot measurement: Length, width, type
 of foot and shin alignment.

5



Optimal and dynamic analysis of the
 footprint. See the foot print on screen.



Discover the Feetbox® video.



ANALYSIS

MEASURING AND ANALYSIS TOOLS

PODOSCOPE V2

Ref. APODOSIDAS

Ref. 109305101

A podoscope that has a mirror system for viewing the foot print.
Sold with a remote control to facilitate use.



SKIER ANALYSE STATION

Ref. COUCHSKANSTA15

Ref. 38047201

This analysis station offers the technician all the equipment necessary to conduct a fast and effective analysis of the skier's foot in order to facilitate the choice of a shell and recommend a boot-fitting solution. It consists of a double measurer L / XL (choice of shell size and model), a mobile alignment laser (for verifying alignments and recommending the insole) and a boot-spreader for validating the shell volume. The Fit Sticks are not included.



SKI ANALYSE STATION PROCESS



FIT STICKS + LIGHT

Ref. CCHDCFITSTIC

Ref. 32958001

3 sticks of varying thickness (diameter: 10 mm - 15 mm - 20 mm) for measuring the space available in the boot and to confirm the choice of shell size.
Sold as a kit or alone.



ANALYSIS MEASURING AND ANALYSIS TOOLS



FEET REVELATOR™ PROCESS

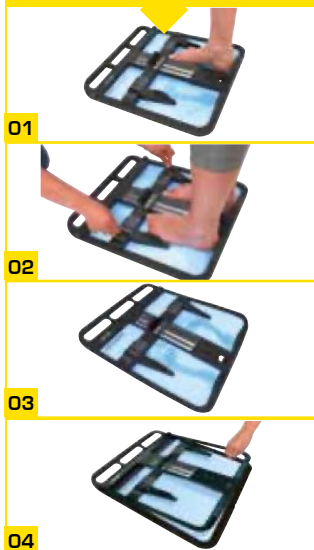

FEET MEASURER PROCESS

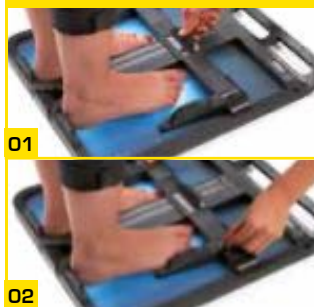

FOOT SIZER PROCESS



FEET REVELATOR™

Ref. ABFEETREVE12

Ref. 32953601

With the Feet Revelator™ you can determine your customer's foot type and characteristics in an instant. It not only measures the length and width of any foot but also reveals the footprints. Simple to use: just open and close to erase your customer's footprints.



FEET MEASURER

Ref. ABMES-SPORT-DBLE12

Ref. 36010101

Instrument that measures the length and width of both feet. 4 sizing systems (EUR/US/UK/MP). Simple to use and robust (plastic). Includes a handle for easy carrying.



FOOT SIZER

Ref. ABMESPORT12-1FOOT

Ref. 36010001

Instrument that measures the length and width of the right foot. 4 sizing systems (EUR/US/UK/MP). Simple to use and robust (metal).





WARMTH

How do you want your heat?



NO MORE COLD FEET DURING YOUR SKI DAYS WITH OUR HEATING PRODUCTS. DISCOVER OUR SOLUTIONS :



INSOLES

More informations page 38



TONGUE

More information page 52



SOCKS

More information page 61



INSOLES

Supporting the perfect fit





3D

With our extensive knowledge about both the foot and boot fitting, utilising our database of over 400,000 scanned feet, we can select the most suitable insole form to provide optimal foot support. Our pre-moulded 3D insoles ensure foot stability within the ski boot, and ultimately greater comfort.

ALUMINIUM FILM
INSULATION

TPU
SUPPORT
& STABILITY



MICROFIBER
COMFORT &
DURABILITY

HEEL PAD
CUSHIONNING



MARKETING TOOLS



SIDAS BOOTFITTING CUBE

Ref. CMKSIDASBFCUBE15
Ref. 38048401



SIDAS CUBE

Ref. CMKSIDASCUBE12
Ref. 35476601



SIDAS CUBE PLIABLE

Ref. CMKSIDASBFCUBE16
Ref. 919545101

RENTAL

SANISOLE 3D

Ref. (box of 10) CSESISAN3D13

Ref. (box of 10) 360042

An insole designed to provide good foot support when practicing winter sports. It has an antibacterial top layer.



- 1. Antibacterial MerryMesh top layer
- 2. EVA shore A 40: Comfort & lightness

SIZES: 18, 19, 20, 21, 22, 23, 24, 25, 26, 27, 28, 29, 30, 31, 32

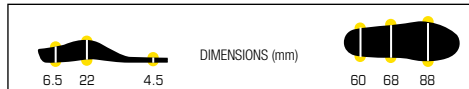

WINTER 3D RENTAL

Ref. (box of 10) CSESIREN16

Ref. (box of 10) 309501000

A 3D insole that provides enhanced comfort and hygiene (sanitized treatment). This insole is available in 15 sizes and can be integrated into all the rental boots, or bought by the customer in the shop.



- 1. Highly resistant merry mesh with an antibacterial coating for enhanced hygiene
- 2. 3mm EVA foam: Comfort
- 3. 3D EVA shell: Optimum protection and support on the slopes for enhanced comfort, enjoyment and reduced fatigue

SIZES: 18, 19, 20, 21, 22, 23, 24, 25, 26, 27, 28, 29, 30, 31, 32

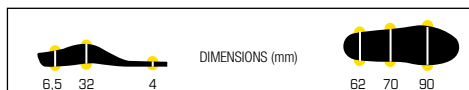

DEMO SEAT

Ref. CMKDEMOSEATFUL19
Ref. 317707101

- Includes 3 empty demo boxes for demo kits in 10 sizes
- Sizes: Height: 664mm / Width : 350 mm / Length 455 mm



DEMO BOX

Ref. CMKDEMOBOX19
Ref. 315705101



3D

WINTER 3D MERINO

Ref. CSE3DWINMERI20

Ref. 319652000

The Winter 3D Merino insole was designed to provide maximum comfort and warmth during winter activities. The insole's anatomical design helps distribute the load underfoot, limiting pressure points. The EVA foam heel absorbs any shocks related to your chosen activity. The merino covering and insulating foil provide warmth and insulation, even during low intensity activities.

1. EVA FOAM: Instant comfort for the entire foot

2. MERINO COVERING: Warmth and odour absorption

3. ALUMINUM FOIL: insulation

4. EVA shell: Foot support and stability

5. EVA heel pad: Cushioning

SIZES XS-S-M-L-XL-XXL

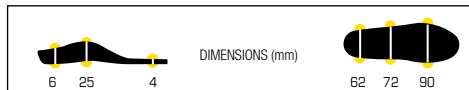

NEW

WINTER 3D PERFORMANCE

Ref. CSE3DWINPERF20

Ref. 319651000

Inspired by our developments for world cup skiers, the Winter 3D Performance insole has been designed to improve pressure transmission for the skier and heel stability within the boot. These factors allow the skier to be more precise when carving while also providing improved comfort. The insulating aluminium film and EVA foam provide comfort and warmth for the feet, which is an additional bonus for day-long skiing sessions.

1. TPU shell: Foot support and pressure distribution

2. EVA foam: Comfort

3. Microfibre covering: Comfort and anti-slip

4. Aluminum foil: insulation

5. Heel reinforcements: Forefoot stability

6. EVA heel pad: Shock absorption

SIZES XS-S-M-L-XL-XXL

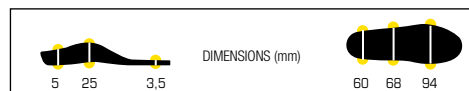

NEW

MARKETING TOOLS



DEMOKIT WINTER 3D MERINO

10 sizes

Ref. Left. CSE3DDKWIMERI20L

Ref. Left. 319778101

Ref. Right. CSE3DDKWIMERI20R

Ref. Right. 319779101

DEMOKIT NORDIC 3D

Ref. CSE3DDKXCNORD17

Ref. 312041101

DEMOKIT 3D PERFORMANCE

10 sizes

Ref. Left. CSE3DDKWIPERF20L

Ref. Left. 319776101

Ref. Right. CSE3DDKWIPERF20R

Ref. Right. 319777101



WINTER POP

POP WINTER 3D MERINO

Ref. CSE3DMKPOPWIME

Ref. 319781101

POP WINTER 3D PERFORMANCE

Ref. CSE3DMKPOPWIPF

Ref. 319780101

IN STORE 3D INSOLES MERCHANDISING

Ref FR. CSE3DMKPOPME20_05
Ref FR. 319844104
Ref EN. CSE3DMKPOPME20_02
Ref EN. 319844102
Ref DE. CSE3DMKPOPME20_01
Ref DE. 319844101

BOOST YOUR COMFORT



SKIBOOSTS INSOLES POS

Ref FR. CSE3DMKPOSSK20_05

Ref FR. 319843104

Ref EN. CSE3DMKPOSSK20_02

Ref EN. 319843102

Ref DE. CSE3DMKPOSSK20_01

Ref DE. 319843101

Take full advantage of your activity

#KEEPON SKIING

3D NORDIC
Stability & movement control,
power transfer, sensation
Stabilité et contrôle de mouvement,
transfert de puissance, sensation

SIDAS
TRAVEL READY

3D NORDIC POSTER

Available on the extranet



NORDIC 3D

Ref. CSE3DXCNORD17

Ref. 311900000

Preformed insoles specially designed for Nordic skiing (classic and skating). Get the most out of your sport during the different phases: propulsion, gliding and manoeuvring. These light and comfortable insoles provide you with precision and momentum. The 3D shell gives stability to the foot, and maximises stability while gliding and manoeuvring. The kick pad optimises and boosts the propulsion phase.

-
- 1. Top cover: Anti friction's resistance
-
- 2. comfort layer
-
- 3. 3D shell: Stability & movement control
-
- 4. Kick pad: Power transfert & sensation
-

SIZES XS-S-M-L-XL-XXL





3Feet®

Feet differ in three main ways; their shape, movement and pressure. Despite these differences, they can generally be grouped into three categories, each with their own distinct needs: High arch feet - Mid arch feet - Low arch feet. The biomechanical construction of the 3Feet® range is therefore adapted to three different types of arches.



**ALUMINIUM
FILM**
INSULATION

**EVA SHELL
ARCH SHAPE**
FOOT SUPPORT &
PRESSURE DISTRIBUTION

**VELVET
TOPCOVER**
COMFORT & DURABILITY

EVA PAD
CUSHIONING



**3FEET®
PROCESS**



01



02



03

MARKETING TOOLS

**3FEET
WINTER POP**

Ref. CMK3FWIP0P12_MU
Ref. 32955901



**3FEET
WINTER FACING**

Ref. CMK3FWIFAC12_MU
Ref. 32956301



DEMOKIT WINTER 3FEET®

10 sizes- 22 to 31

WINTER 3FEET® HIGH

Ref. Left. CSE3FDKWINTH19L
Ref. Left. 317694101
Ref. Right. CSE3FDKWINTH19R
Ref. Right. 317695101

WINTER 3FEET® MID

Ref. Left. CSE3FDKWINTM19L
Ref. Left. 317698101
Ref. Right. CSE3FDKWINTM19R
Ref. Right. 317699101

WINTER 3FEET® LOW

Ref. Left. CSE3FDKWINTL019L
Ref. Left. 317697101
Ref. Right. CSE3FDKWINTL019R
Ref. Right. 317696101

3Feet®

3FEET® WINTER HIGH

Ref. CSE3FWH12-HI

Ref. 329503

Specifically designed for high arch feet.
Need: support.
3Feet® answer: Optimised pressure distribution.
- Aluminium film for insulation.
- Anatomical construction adapted to high arch feet.
- Large foam pad for greater cushioning.

1. Velvet topcover: comfort & durability
2. Eva shell high arch shape: foot support & pressure distribution
3. Eva pad: cushioning
4. Aluminium film: insulation

SIZES XS-S-M-L-XL-XXL

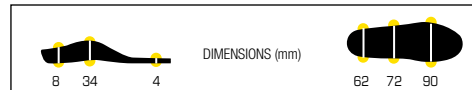

3FEET® WINTER MID

Ref. CSE3FWI12-MI

Ref. 329502

Specifically designed for medium arch feet.
Need: support.
3Feet® answer: Optimised pressure distribution.
- Aluminium film for insulation.
- Anatomical construction adapted to medium arch feet.
- Large foam pad for greater cushioning.

1. Velvet topcover: Comfort & durability
2. EVA shell mid arch shape: Foot support & pressure distribution
3. EVA pad: Cushioning
4. Aluminium film: Insulation

SIZES XS-S-M-L-XL-XXL



3FEET® WINTER LOW

Ref. CSE3FWL12-L0

Ref. 329501

Specifically designed for low arch feet.
Need: support.
3Feet® answer: Optimised pressure distribution.
- Aluminium film for insulation.
- Anatomical construction adapted to low feet.
- Large foam pad for greater cushioning.

1. Velvet topcover: Comfort & durability
2. EVA shell LOW arch shape: Foot support & pressure distribution
3. EVA pad: Cushioning
4. Aluminium film: Insulation

SIZES XS-S-M-L-XL-XXL





3Feet®

3FEET® MERINO HIGH

Ref. CSE3FME18_HI

Ref. 314178100

Anatomical insoles adapted high-arched foot. Ideal hybrid top cover : synthetics fibers (40%) will guarantee resistance and durability, the merino wool (60%) will reduce odor and assure an optimal thermoregulation.

1. Hybrid Merino top cover: Thermoregulation & Absorbs odours
2. Eva shell high arch shape: foot support & pressure distribution
3. Aluminium layer: Insulation
4. EVA PAD: Heel cushioning

SIZES XS-S-M-L-XL-XXL



3FEET® MERINO MID

Ref. CSE3FME18_MI

Ref. 314178200

Anatomical insoles adapted mid-arched foot. Ideal hybrid top cover : synthetics fibers (40%) will guarantee resistance and durability, the merino wool (60%) will reduce odor and assure an optimal thermoregulation.

1. Hybrid Merino top cover: Thermoregulation & Absorbs odours
2. Eva shell mid arch shape: foot support & pressure distribution
3. Aluminium layer: Insulation
4. EVA PAD: Heel cushioning

SIZES XS-S-M-L-XL-XXL

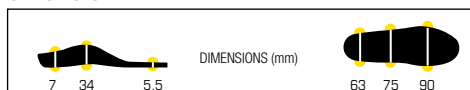

3FEET® MERINO LOW

Ref. CSE3FME18-LO

Ref. 314178300

Anatomical insoles adapted low-arched foot. Ideal hybrid top cover : synthetics fibers (40%) will guarantee resistance and durability, the merino wool (60%) will reduce odor and assure an optimal thermoregulation.

1. Hybrid Merino top cover: Thermoregulation & Absorbs odours
2. Eva shell low arch shape: foot support & pressure distribution
3. Aluminium layer: Insulation
4. EVA PAD: Heel cushioning

SIZES XS-S-M-L-XL-XXL



MARKETING TOOLS



DEMOKIT WINTER 3FEET®

10 sizes- 22 to 31

3FEET® MERINO HIGH

Ref. Left. CSE3FDKMERIHI19L

Ref. Left. 317702101

Ref. Right. CSE3FDKMERIHI19R

Ref. Right. 317703101

3FEET® MERINO MID

Ref. Left. CSE3FDKMERIMI19L

Ref. Left. 317701101

Ref. Right. CSE3FDKMERIMI19R

Ref. Right. 317700101

3FEET® MERINO LOW

Ref. Left. CSE3FDKMERILO19L

Ref. Left. 317705101

Ref. Right. CSE3FDKMERILO19R

Ref. Right. 317704101

3FEET® MERINO POP

Ref. CMK3FMERIPOP18

Ref. 314371101



3FEET® MERINO FACING

Ref. CMK3FMERIFAC18

Ref. 314379101



3FEET® MERINO POSTER

Available on the extranet



MERINO

INSOLES



Stay warm with merino wool...

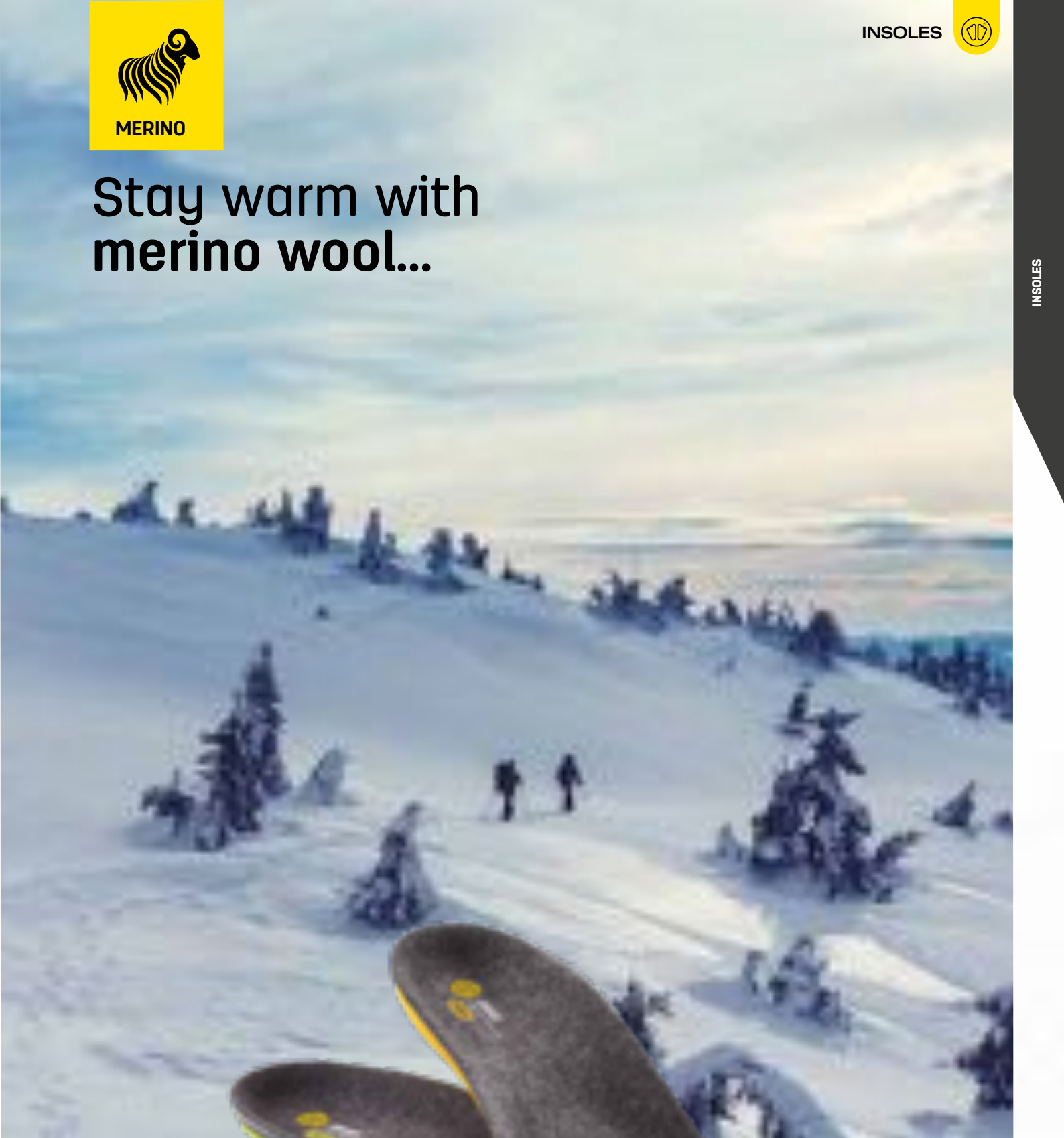

INSOLES



3FEET® MERINO



FLASHFIT™



The Flashfit™ technology allows 75% customization of your insoles in only a few minutes. The bootfitter heats a pre-shaped insole and fits it to your foot in less than 5 minutes. Only part of the insole can be fully customized to your foot, the other pre-shaped part remains unchanged when heated. With Flashfit™ insoles, you have more power, control and comfort.

ECO FOAM PAD
COMFORT & DURABILITY

**TRANSFLUX® C
REINFORCEMENT**
SUPPORT & STABILITY



**IONMESH®
TOPCOVER**
CUSHIONING &
ANTIBACTERIAL

PODIAFLEX® N
SUPPORT & STABILITY



FLASHFIT™



FLASHFIT™ PROCESS



01



02



03



04



05

MARKETING TOOLS



DEMOKIT WINTER +

Ref. CSESPDKWIN12
Ref. 32953901

DEMOKIT WINTER +SLIM

Ref. CSESPDKWSL12
Ref. 32954001

WINTER+

Ref. CSESPWINT12

Ref. 329504

Pre-shaped insoles designed for winter sports such as skiing and snowboarding, for optimum comfort. Foot support, stability and prevention of overheating and fatigue. Can also be customised to your feet in less than 10 minutes using Flashfit™ technology for additional comfort.

- 1. Ionmesh® topcover: Cushioning & antibacterial
- 2. Transflux® C reinforcement: Support & stability
- 3. Podiaflex® N: Support & stability
- 4. Eco foam pad: Comfort & durability

SIZES XS-S-M-L-XL-XXL

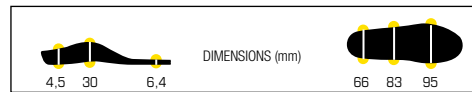

WINTER+ SLIM

Ref. CSESPWINSL12

Ref. 329505

Pre-shaped insoles for winter sports such as skiing and snowboarding, designed for slim-fitting footwear. Foot support, stability, prevention of overheating and fatigue. Can also be customised to your feet in less than 10 minutes using Flashfit™ technology for additional comfort.

- 1. Ionmesh® topcover: Cushioning & antibacterial
- 2. Transflux® C reinforcement: Support & stability
- 3. Podiaflex® N: Support & stability

SIZES XS-S-M-L-XL-XXL

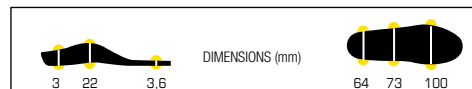

COMFORT + MERINO

Ref. CSESPCOMFME18

Ref. 314135000

Pre-shaped insoles designed for outdoor activities. Ideal hybrid top cover : synthetics (40%) fibers will guarantee resistance and durability, the merino (60%) wool will reduce odor and assure an optimal thermoregulation. Personalised to your feet using flashfit™ technology.

- 1. Hybrid merino top cover: Thermoregulation & Absorbs odours
- 2. Transflux®: Flexibility & comfort
- 3. Transflux® C Reinforcement: Foot support & stability
- 4. Transflux®: Arch support

SIZES XS-S-M-L-XL-XXL

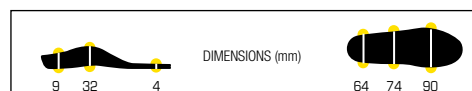



C Custom

The Custom technology offers complete customisation of your insoles. Starting with a flat insole, the bootfitter heats the insoles and then moulds them. When it is placed on your footprint, the Custom insoles hugs the shape of your feet for the highest levels of comfort and support.





C Custom

INSOLES



CUSTOM PROCESS



01



02



03



04



05



06

WINTER CUSTOM COMFORT

Ref. CSECUWICOMF14

Ref. 372478

The Custom Comfort insole is designed specifically for skier comfort, particularly forefoot comfort, through use of soft materials. This fully thermoformable insole perfectly matches the shape of the skier's foot, providing heel stability and underfoot load distribution, ensuring precise control of the skis. Its AMF microfibre covering guarantees day-long comfort for the skier.

1. AMF topcover: Soft touch & easy step in
2. Podialène foam 2.5 mm: Cushioning across the entire insole
3. Expertene padding: Optimal comfort
4. Podiafix® reinforcement: Foot stability & control
5. Transflux® reinforcement: Back foot stability
6. Podiaflex: Comfort & softness

SIZES XS-S-M-L-XL-XXL

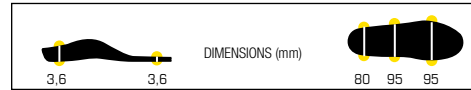

WINTER CUSTOM RACE MERINO

Ref. CSECUWIRACME18

Ref. 314133000

Ski Race Merino insole designed for winter sports, guarantee stability, precision and fatigue prevention. Ideal hybrid top cover : synthetics fibers (40%) will guarantee resistance and durability, the merino wool (60%) will reduce odor and assure an optimal thermoregulation.

1. Hybrid Merino top cover: Thermoregulation & Absorbs odours boots
2. Narrow shape: For narrow boots
3. Transflux® reinforcement: Foot support & rigidity
4. Podiafix®: Precision

SIZES XS-S-M-L-XL-XXL



WINTER CUSTOM PRO

Ref. CSECUWIPR12

Ref. 329508

The Custom Ski Pro is designed for skiers who are looking for incomparable comfort and performance. Constructed using new materials that mould more easily to the feet.

1. Ionfoam® topcover: Cushioning & antibacterial
2. Transflux® reinforcement: Support & stability
3. Transflux®: Support
4. Podiafix®: Precision

SIZES XS-S-M-L-XL-XXL

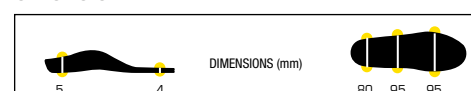



C | Custom

WINTER CUSTOM SKI

Ref. CSECUWISK12

Ref. 329506

The essential insole. Can be used alone but is most often stabilized with Heel stabs or Transflux® reinforcements.

- 1. Ionfoam® topcover: Cushioning & antibacterial
- 2. Podiaflex® reinforcement: Foot support & stability
- 3. Podiafix®: Precision

SIZES XS-S-M-L-XL-XXL

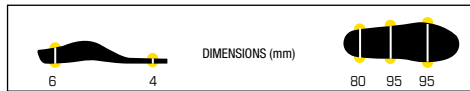

CUSTOM XC CLASSIC

Ref. CSECUXCLAS17

Ref. 311932000

The Custom XC Classic insole is designed to provide classic Nordic skiers an unparalleled experience in terms of comfort, control and power transfer. The AMF top layer makes it easy to put on; the new Jogtene®Light foam provides boost during all phases of movement and the EVA base can withstand all bending stresses generated when skiing.

- 1. AMF Top cover: Easy step in & Moisture management
- 2. Jogtene® Light foam: Propulsion & dynamism
- 3. PE high density base: Maximal resistance to bending
- 4. Transflux® carbon & Transflux®: Support, stability and support transfer

SIZES XS-S-M-L-XL-XXL

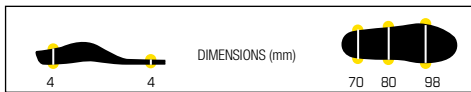

CUSTOM XC SKATING

Ref. CSECUXCSKAT17

Ref. 311933000

The Custom XC Skating insole is designed to provide skating Nordic skiers an unparalleled experience in terms of comfort, control and power transfer. The AMF top layer makes it easy to put on; the new Jogtene®Light foam provides a boost during all phases of movement and the Podiaflex® base controls twisting, providing an optimal power transfer.

- 1. AMF Top cover: Easy step in & Moisture management
- 2. Jogtene® Light foam: dynamic rebound
- 3. Podiaflex®: Twisting control & optimal power transfer
- 4. Transflux® carbon & Transflux®: Support, stability and support transfer

SIZES XS-S-M-L-XL-XXL

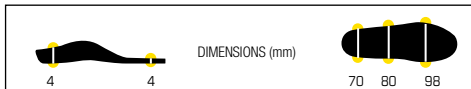

MARKETING TOOLS

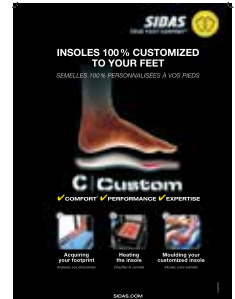

CUSTOM POSTER FOR FIT STATIONS

Poster Custom EN DE
Ref. CMKPOSCUSTOM_0

Poster Custom EN FR
Ref. CMKPOSCUSTOM_05

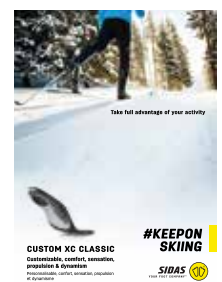

XC-NORDIC POSTER

Available on the extranet



C Custom

CUSTOM COMFORT MERINO

Ref. CSECUCOMFME18

Ref. 314134000

The Custom Comfort Merino insole is designed specifically for skier comfort, particularly forefoot comfort, using very soft materials. This fully thermoformable insole perfectly matches the shape of the skier's foot, providing heel stability and underfoot load distribution, ensuring precise control of the skis. Its ideal hybrid covering combines 40% synthetic fibres, guaranteeing strength and durability, with 60% merino wool, which naturally minimises odours and ensures optimal temperature regulation.

- 1. Hybrid merino top cover: Thermoregulation & Absorbs odours
- 2. Podialène foam 2.5 Mm: Cushioning across the entire insole
- 3. Expertene padding: Optimal comfort
- 4. Podiafix® reinforcement: Foot stability & control
- 5. Transflux® reinforcement: Back foot stability
- 6. Podiaflex: Comfort & softness

SIZES XS-S-M-L-XL-XXL

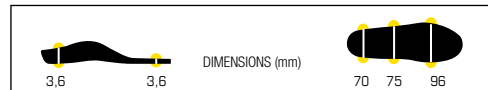

HEAT READY PROCESS



WINTER CUSTOM PRO HEAT READY

Ref. CSECUIWIPROHR19

Ref. 31658700

100% customizable insoles designed for sports of winter (ski, snowboard ...) for an optimal comfort. Stability, precision, performance and prevention of fatigue. Option of heating the sole thanks to Heat Ready technology!

- 1. AMF top cover: soft feeling and easy fitting
- 2. Transflux® reinforcements: foot support & stability
- 3. Podiafix®: Précision
- 4. Podialène foam: cushioned sole

SIZES XS-S-M-L-XL-XXL

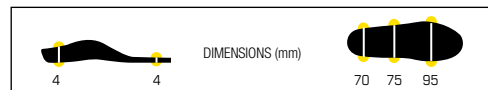

HEAT READY PACK 10

Ref. T44-0900-003

Pack of 10 pairs of heating elements (powered by Therm-ic) and 10 pairs of external coatings. Note: the Therm-ic warming elements are only compatible with Therm-ic C-Packs batteries.





INSOLES

MODULO RACING

This offer is exclusively reserved to boot-fitting experts. It has been developed by specialists and approved by athletes. This premium offer is used for the customised design of high-performance insoles adapted to skiers' needs and disciplines (both alpine and nordic). Sidas has allowed no compromise in ensuring that it only creates the best possible insoles for athletes and only uses the best materials approved by its R&D team.

Delivered in packs of 5 pairs.

INSOLES

TOP COVERS (XS - XXL)



TOP COVER RACING 0.8 MM
Ref. CSEMODRACRV01 - Ref. 380440
5 pairs pack



TOP COVER RACING 1.5 MM
Ref. CSEMODRACRV02 - Ref. 380441
5 pairs pack



TOP COVER RACING 2.5 MM
Ref. CSEMODRACRV03 - Ref. 380442
5 pairs pack

MID LAYER (XS - XXL)



MID LAYER RACING 2 MM
Ref. CSEMODRACINT01 - Ref. 380443
5 pairs pack

BASE (XS - XXL)



BASE RACING 0.8 MM
Ref. CSEMODRACBA02 - Ref. 380445
5 pairs pack



BASE RACING 1.6 MM
Ref. CSEMODRACBA01 - Ref. 380444
5 pairs pack

MEDIO (XS - XXL)



MID FOOT RACING 1.1 MM
Ref. CSEMODRACRF03 - Ref. 380448
5 pairs pack



MID FOOT RACING 1.5 MM
Ref. CSEMODRACRF02 - Ref. 380447
5 pairs pack



MID FOOT RACING 2 MM
Ref. CSEMODRACRF01 - Ref. 380446
5 pairs pack

REAR (XS - XXL)



HEEL RACING 1.1 MM
Ref. CSEMODRACSRF01 - Ref. 380449
5 pairs pack

PADS (T1-T3)



PAD RACING 2 MM
Ref. CSEMODRACPA01 - Ref. 380450
5 pairs pack

CUSTOMIZING

ORDER

Upon request

WE PRINT
YOUR LOGO HERE

Bootfitter logo
printed on the top
cover (10x3cm)



SMU ORDER

Upon request

WE PRINT
YOUR LOGO HERE

Bootfitter logo
printed on the top
cover (10x3cm)



Choose:
• the reinforcement
• the shape

A choice of top cover materials



FOOTBED TEMPLATES

Ref. CSEACGABHIVE
Ref. 866096
Templates for checking shoe or liner size.



SCISSORS

Ref. P99CISTANIUM
Ref. 605586101
Strong scissors for cutting footbeds.



NEOPRENE GLUE GEL 1L

Ref. P99COLLE1
Ref. 35251201



OK NET MOUSSE 150 ML

Ref. SIACOKNET19
Ref. 818625101
Cleaning spray for analysis and measurement tools, machine pads, scan...

HEEL BARS

Ref. CSEACSTHEELBARS

Ref. 36004301

Heel bars are the quick way to stabilise the rear foot. They are 10 mm wide and made of shore A70 EVA. They feature an adhesive-coated section which makes them easy to stick to the insole. Sold in packs of 10 pairs.



TRANSFLUX REINFORCEMENT INSOLES

Sizes: XS - S - M - L - XL - XXL / Sold in pack of 5 pairs

TX® WHITE (1.5 MM)

Ref. CSEACRETX03

Ref. 893885

TX® ORANGE (1.5 MM)

Ref. CSEACRETX01

Ref. 893882

TX® BLACK (1 MM)

Ref. CSEACRETX02

Ref. 893883

TX® BLUE (1 MM)

Ref. CSEACRETX04

Ref. 893884

TX® M3 ORANGE (1.5 MM)

Ref. CSEACRETXM3

Ref. 893990

TX® R3 ORANGE (1.5 MM)

Ref. CSEACRETXR3

Ref. 893991





INSOLES

CUSTOM ACCESSORIES

HEEL STAB 65

Ref. CSEACSTA65

Ref. 309535000

The Heel Stab 65 stabilizes the Custom insoles. Thanks to its anatomical design, the Heel Stab 65 is easy to position. The Stab requires less grinding.



SIZES XS - XXL



HEEL STAB PROCESS

HEEL STAB

Ref. CSEACSTA

Ref. KC2010

Pre-glued PE stabilizer. Easy to fit and grind, for light reinforcement and lateral stability.



SIZES 1 (XS-S) 2 (M-L) 3 (XL)

HEEL STAB STIFF

Ref. CSEACSTASTIF

Ref. 995941

The same concept as the heel stabilizer (Heel stab), but stiffer and available in 4 sizes.



SIZES 1 (XS) 2 (S-M) 3 (L-XL) 4 (XXL)

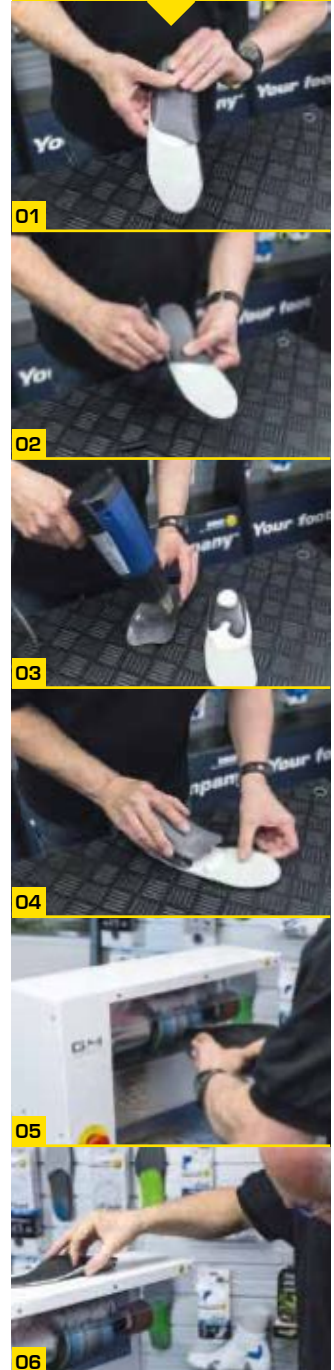



CUSTOM ACCESSORIES

INSOLES



CRIST' AIR PROCESS



01



02



03



04



05



06

CRIST' AIR STAB

Ref. CSEACSTCRISR

Ref. 893881

A revolutionary material with unrivalled properties: ultra light (density 100 kg/m³); easy to cut and grind. Extra control of both the rear-foot and mid-foot.



SIZES 1 (XS-S) 2 (M-L) 3 (XL)

HEEL STAB COVER

Ref. CSEACSTACOV

Ref. 353605

EVA coating giving a better finish on the heel stab. Easy to affix to the heel stab thanks to its adhesive. Features: EVA shoreA 70, 1mm black. Sold in packs of 5 pairs.



SIZES T1-T2 / T3-T4



TAPE AMF ROLL 35cm x 6m

Ref. P01XAMFMPL19_07_NR

Ref. 611539102

AMF material 35 cm wide, with double-sided adhesive tape. Ideal for perfectly putting on an insole, managing moisture and optimising comfort.



TAPE IONMESH ROLL 35cm x 6m

Ref. P01XIONMEL19_06_RG

Ref. 611540104

IONMESH material 35 cm wide, with double-sided adhesive tape. Ideal for wearing of insole optimally, with good abrasion resistance, and optimising comfort.



TAPE CARBON ROLL 35cm x 6m

Ref. P01XEXTCAL19_NR

Ref. 611542101

EXTENSOUPLE CARBONE material 35 cm wide, with double-sided adhesive tape. Ideal for repairing a shoe, covering an insole.





INSOLES

HEAT INSOLES

3D POWER HEAT

Ref. CSE3DPOWHEAT20

Ref. 319653000

The heated 3D insole houses highly effective heating elements, providing optimal thermal comfort for any outdoor activity. Its anatomical design distributes the load underfoot, minimising pressure points. Compatible with all the batteries in the Sidas & Therm-ic range.



NEW

SIZES XS-S-M-L-XL-XXL

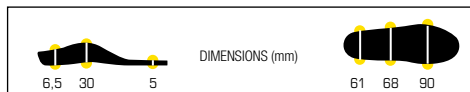

FLAT POWER HEAT

Ref. CSESIFLAPOWHEAT20

Ref. 319840101

The soft fabric top layer provides good cushioning and insulation from the cold. Multi-size insole with handy trimming lines on the reverse. Compatible with all the batteries in the Sidas & Therm-ic range.



NEW

Unique Size

POWER HEAT ELEMENTS & COVERS

Ref. Heat Elements & covers
CSECUHECOPOWHEAT20
319841101

Ref. Heat covers
CSECUHTOP10
30787701

Heating elements and covering kit for use with Sidas insoles. The heating elements provide gentle, constant and consistent warmth for optimal thermal comfort. They are ultra thin and fit easily under any type of insole. The external covering covers the heating element and ensures comfort.

In the shop, the expert bootfitter fully adjusts the insoles to the feet and the sport, with the added comfort of warmth. Compatible with all the batteries in the Sidas & Therm-ic range. The pack includes 2 top covers and 2 heating element.

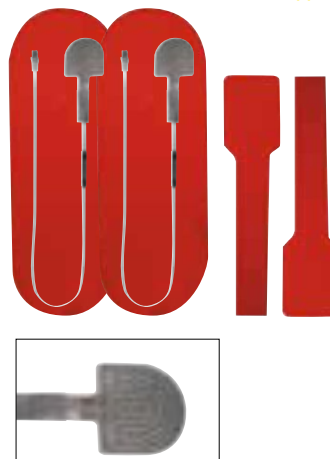

NEW



HEATING ELEMENTS PROCESS

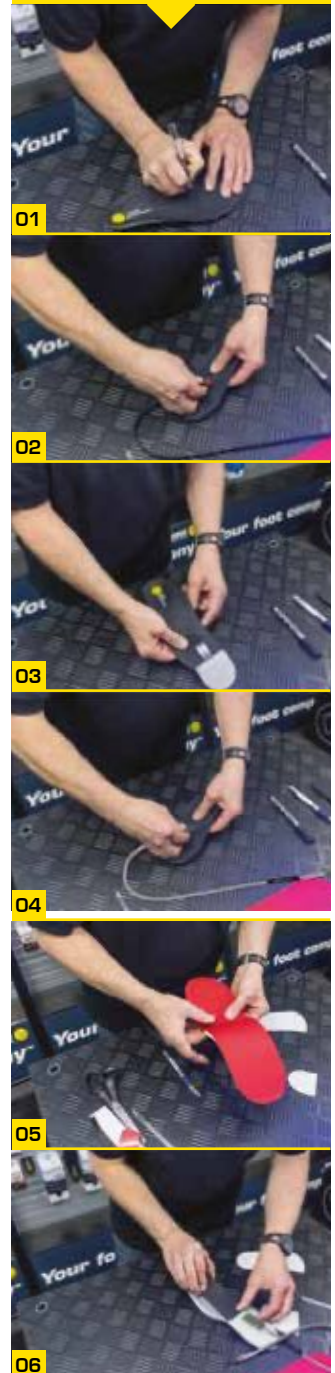



BATTERIES



LOW	11h to 13h
MEDIUM	5h to 7h
MAX	3h to 4h



EASY-CLIP



INTERNET WARRANTY



EXTRA POWERFUL

LOW	11h to 13h
MEDIUM	5h to 7h
MAX	3h to 4h



EASY-CLIP



INTERNET WARRANTY



EXTRA POWERFUL



CONTROL THE HEAT

EXTENSION CORD

EXTENSION CORD 120cm (1 pair)

THERM-IC Ref. T40-0900-005

THERM-IC Ref. 400900005

EXTENSION CORD 80cm (1 pair)

THERM-IC Ref. T40-0900-003

THERM-IC Ref. 400900003

EXTENSION CORD 20cm (1 pair)

THERM-IC Ref. T40-0900-004

THERM-IC Ref. 400900004

C-POWERPack batteries are suitable for use with Sidas heated insoles, providing up to 13 hours of heat.

- Comes with a single control button
- Pack comes with a USB charger
- Wall charger not supplied

C-POWER 1300

Ref. HEINCP0W1300

Ref. 519771101



The best value for money, this C-POWER 1300 battery pack comes with three heat settings to help keep your feet warm all day long.

- Warm feet for up to 13 hours
- Included: a protective cover for the batteries

3 warming modes for perfect warmth

11 to 13 hour battery life

Easy to clip on

Extra powerful Lithium-ion battery

Universal charger (connector for use in eu/usa/gb)

2-Year warranty (via internet registration)



C-POWER 1300B

Ref. HEINCP0W1300B

Ref. 519772101



The C-POWER 1300B batteries are the most effective in the range and thanks to the Bluetooth® function you will be able to control the intensity of your heat remotely. Warm feet for up to 13 hours. Included: a protective cover for the batteries.

The batteries' special Bluetooth® feature enables you to check and regulate the heating level of your insoles on your smartphone using the Therm-ic Heat Control mobile app.

3 Warming modes for adjustable warmth

11 to 13 hour battery life

Easy to clip on

Extra powerful Lithium-ion battery

Universal charger (connector for use in EU/USA)

2-Year warranty (via internet registration)





EQUIPMENT



FLASHFIT™



**FLASHFIT™
PROCESS**

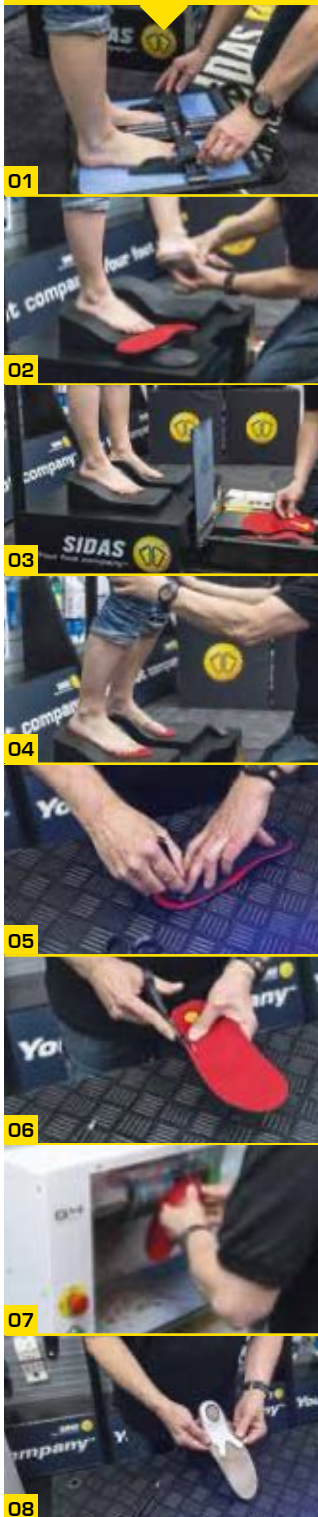

FLASHFIT™ PADS

Ref. CMAVAPAD-FF12	Ref. 35476201
Ref. CMAVAPAD-FF-NU	Ref. PADS ALONE = 35476301
Ref. CMAVAPAD-FF-CI	Ref. BOTTOM WEDGE = 35476401
Ref. CMAVAPAD-FF-CL	Ref. SIDE WEDGE = 35476501

The foam pads have two removable reinforcements, are softer and have a new anatomical shape, all of which make moulding easier.
Available in one size.



FLASHFIT™ BOX

Ref. 110V: CMAFLASHFIT1	Ref. 99659301
Ref. 220V: CMAFLASHFIT2	Ref. 99659201

The concept that heats Flashfit™ insoles in less than 10 seconds. Easy, fast, compact, unique design.

Dimensions : 12 x 30 x 38 cm - 7 kg





C | Custom

CUSTOM STATION

Ref. CMAJUSTAPREMPK15	Ref. 38045201	CUSTOM STATION PREMIUM PACK (FULL EQUIPPED)
Ref. CMAFITSTAPREM15	Ref. 38045501	FIT STATION PREMIUM (WITHOUT EQUIPMENT)

The premium fit station is the must-have Custom moulding station! Its ergonomic, elegant and simple design lets you promote your boot-fitting activity in-store, particularly the Custom technology.

The design ensures both comfort for the boot-fitter and simple moulding. The station is easy to access for both the customer and the technician. It consists of a comfortable adjustable seat and support bars to ensure stability for the customer during the moulding process. A luminous band emphasises the outline of the station and promotes your boot-fitting space.

In technical terms, the sophisticated station allows you to analyse feet using the fully-integrated podoscope, to heat using the Moduvac and to make imprints using the directly integrated silicone bags.

5-year guarantee on the equipment.
Lifetime guarantee on metal structure.

Dimensions : 1068 x 925 x 895 mm

- 1. Fit Station Premium
- 2. Integrated **PODOSCOPE**
- 3. Adjustable seat
- 4. **MODUVAC**

Ref. 110V: CMAMODU09-1	Ref. 10757601
Ref. 220V: CMAMODU09-2	Ref. 10757501
5. HDVAC bags	
Ref. CMAVAPAD09	Ref. 10757701

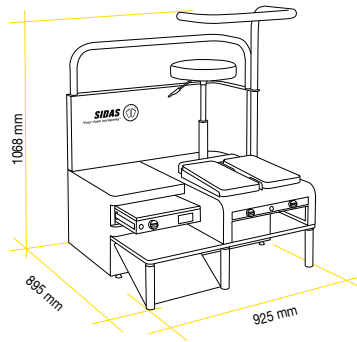

CUSTOM PROCESS



Developed and made in France



CUSTOM STATION COMPACT

Ref. CMAJUSTACOMPK15

Ref. 38045301

Ref. CMAFITSTACOMPAN15

Ref. 38045601

This fit station is a highly compact unit that combines all the essential elements for customising the design of insoles. It offers the very best function / size / quality ratio.

Its ergonomic metal structure is highly resistant, allowing optimum use of your boot-fitting space. It consists of a seat, an analysis section and a moulding section, all in ideal dimensions for your point of sale or sales visits.

Dimensions : 106 x 710 x 639 mm.

1. Fit Station Compact

2. MODUVAC

Ref. 110V: CMAMODU09-1

Ref. 10757601

Ref. 220V: CMAMODU09-2

Ref. 10757501

3. HDVAC

Ref. 110V: CMAVAHDBLK-1

Ref. 309537101

Ref. 220V: CMAVAHDBLK-2

Ref. 309536101

4. Podoscope

Ref. APODOSIDAS

Ref. 109305101

5. Integration of Feet Measurer possible

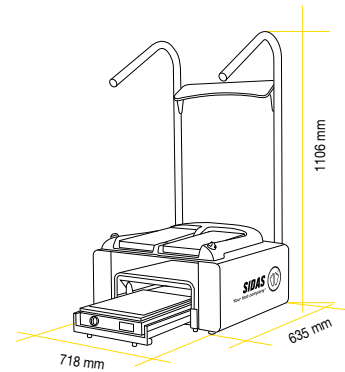

CUSTOM PROCESS



01



02



03



04



05



06



MADE IN FRANCE

Developed and made in France



C | Custom

CUSTOM STATION 2.1

Ref. CMAUSTA21PK15

Ref. 38045401

(FULL EQUIPPED)

For retailers who want to offer a totally professional service and the best customer experience. The Fit Station is a unit especially designed for boot-fitters. (The HD Vac 2 and the Moduvac are not included and should be bought separately).

Dimensions : 90 x 80 x 89 cm

1. FIT STATION

Ref. MBFTSTAT2-1

Ref. 10825701

2. HD VAC 2

Ref. 110V: CMAVAHDBLK-1

Ref. 309537101

Ref. 220V: CMAVAHDBLK-2

Ref. 309536101

3. MODUVAC

Ref. 110V: CMAMODU09-1

Ref. 10757601

Ref. 220V: CMAMODU09-2

Ref. 10757501

OPTIONAL:

4. LASER ALIGNMENT SYSTEM

Ref. CMAVALASER12

Ref. 36010201

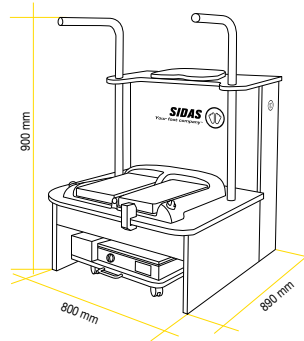

CUSTOM PROCESS

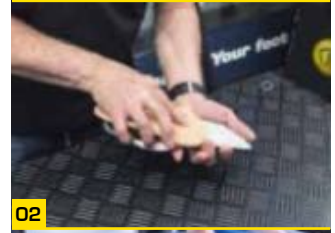



HD VAC 2

Ref. 110V: CMAVAHDBLK-1

Ref. 309537101

Ref. 220V: CMAVAHDBLK-2

Ref. 309536101

The best just got better. The HDVAC was already the best Custom system on the market, but the HDVAC2 is the most precise system ever made.

The silicon bags can be stretched up to 800% to adapt to any foot shape, the bags are separated for better hip adaptation, and all the controls are on the front making it easier for the boot-fitter to operate.

For retailers who want to offer a complete professional service, this tailor-made product will enhance your custom business line. If you want to bring the best service to your customer, the HDVAC2 is for you.

The HDVAC 2 is a system for moulding comfort insoles, but cannot replace plantar orthoses fitted by professional foot specialists.



MODUVAC

Ref. 110V: CMAMODU09-1

Ref. 10757601

Ref. 220V: CMAMODU09-2

Ref. 107 57501

The new Sidax system to accompany the HDVAC2 system for moulding Custom footbeds. Compact, fast and simple, the Moduvac heats and presses the footbeds using a vacuum system in order to fuse the materials together, and prepare the insoles for moulding. The Moduvac is compatible with all HDVAC systems.



LASER ALIGNMENT SYSTEM

Ref. CMAVALASER12

Ref. 36010201

Top-quality laser used to check leg alignment. Attaches easily to the Fit Station.



DUAL LASER ALIGNEMENT SYSTEM FOR STATION PREMIUM

Ref. CMAVALASPREMIUM

Ref. 312039101

The dual laser is designed to fit ergonomically on the Premium Fitstation. It enables the technician to check the shin alignment of the customers and speak to them effectively about the benefits of an insole. The dual laser can be adjusted horizontally. It consists of two independent lasers. Works with 2 batteries (supplied).





GRINDERS: BEST SELLERS

EQUIPMENT

GRAVITY 600

Ref. CMATRGRAV600TOT	Ref. 309568101	= GRAVITY 600 TOTEM (WITHOUT EQUIPMENT)
Ref. CMATRGRAV600	Ref. 309569101	= GRAVITY 600 (WITHOUT EQUIPMENT)

- 1 grinding station and 1 finishing station.
- Expanding wheel.
- Self-locking mandrel.
- Very quiet (< 65 dB).
- Torque: 1.8 Nm.
- Power consumption: 600 W.
- Rotation speed: 2850 rpm.
- LED light.
- Storage shelves.
- The grinding area is completely enclosed, preventing mess and pollution of the working environment.
- Easy to clean.

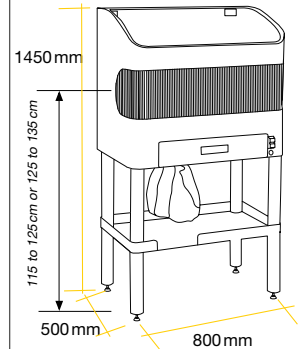

G1 EVO GRINDER

Ref. PPGTOURG1EVO	Ref. 617862101	G1 EVO-220V WITHOUT ACCESSORIES
Ref. PPGTOURG1EVO_110	Ref. 617967101	G1 EVO-110V WITHOUT ACCESSORIES

Ultra compact drum that fits all workspaces.

- Dual head
- Compact
- Expanding wheel

- Self-locking mandrel
- Torque: 3 Nm
- Motor power: 675 W
- Rotation speed: 2,800 rpm

NEW

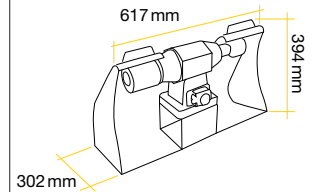
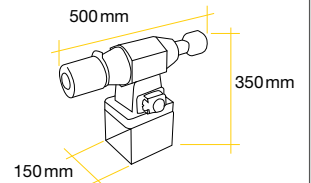

CARTER OPTION

Dust collection tray (does not require aspiration).
2 housings available: right and left.

Right Side Ref. PPGTOURG1EVO_AD	Right Side Ref. 619067101
Left Side Ref. PPGTOURG1EVO_AG	Right Side Ref. 619282101

RAISER OPTION

Raiser allowing the grinder to be raised to improve the working ergonomics.

Ref. PPGTOURG1EVO_REHAUS	Ref. 617968101
--------------------------	----------------

G2 GRINDER

Ref. PPGPONCECAR	Ref. 995 94701
------------------	----------------

- Double head.
- Expanding wheel.
- Shielding.
- Torque 1.8 Nm.
- Motor power: 600 W.
- Power consumption: 600 W.
- Speed of rotation: 2850 r.p.m.



Vacuum cleaner attachment point on back of grinder

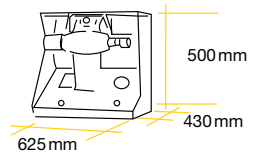

35 kg
230 V - 50 Hz

G3 GRINDER

Ref. PPGUNIPON	Ref. 995 94901
----------------	----------------

- Double head.
- Expanding wheel.
- Shielding.
- Turbine suction.
- Torque 1.9 Nm.
- Motor power: 600 W.
- Power consumption: 1000 W.
- Speed of rotation: 2850 r.p.m.

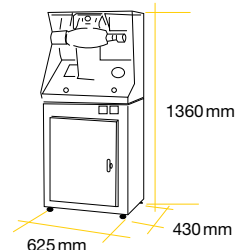

75 kg
230 V - 50 Hz



ACCESSORIES

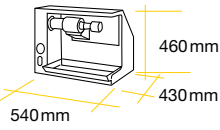

40kg
230V - 50Hz

G4 GRINDER

Ref. PPGTOURG4EVOLUTION

Ref. 37257501

- Expanding wheel.
- Shielding.
- Silent.
- Torque 2 Nm.
- Motor power: 550 W.
- Power consumption: 550 W.
- Speed of rotation: 3000 r.p.m.



	Grinding power (Nm)	Ergonomics		Maintenance	Insole finishing	Padding adjustment	Heel Stab adjustment	Liner /boot grinding	Comments
		Space	Dust management						
G1 evo grinder	3	Ultra-compact	Easy cleaning carter	Regular cleaning	●	●	●	●	The ideal tool for introducing boot fitting to your business when you have minimal space available in the workshop
		●●●●●	●●●●●	●●●●●	●●●●●				
G2 grinder	1.8	Compact	Open-case frame	Localized cleaning	●	●	●	●	This grinder deals effectively with dust, allowing you to work efficiently on insoles. Can be combined with an industrial vacuum cleaner
		●●●●●	●●●●●	●●●●●	●●●●●				
G3 grinder	1.8	Totem pole structure	Vacuum system	Localized cleaning	●	●	●	●	G2 vacuum system upgrade reduces cleaning times for increased efficiency
		●●●●●	●●●●●	●●●●●	●●●●●				
Gravity 600	1.8	Compact	Closed-case frame	Easy by design	●	●	●	●	A brand new Sidas product - a perfect combination of performance, appearance and dust management. Can be fitted with a structure to adjust grinder height
		●●●●●	●●●●●	●●●●●	●●●●●				
G4 grinder	2	Compact	Open-case frame	Localized cleaning	●	●	●	●	The grinder for you if your bootfitting creativity has no limits. Can be combined with an industrial vacuum cleaner
		●●●●●	●●●●●	●●●●●	●●●●●				

Accessories kit Grinder G1

Ref. PXACC_PONSEU

Ref. 606419101

- A pair of safety goggles.
- A block to clean the grinding belts.
- 1 grinding belt.
- 2 polishing belts

**Accessories kit:
Grinder G2, G3, G4, Gravity 600**

Ref. PXACC_TOURET

Ref. 606422101

- A pair of safety goggles.
- 2 blocks to clean the grinding belts.
- 2 grinding belts.
- 2 polishing wheels.
- 1 sanding wheel.



INNERBOOTS

Experience the ideal fit





INNERBOOTS

PU INNERBOOTS

PU CLASSIC COMFORT

Ref. CCHPUCLACOMF

Ref. 309527000

The PU Classic Comfort boot liner is a premium customization solution for a perfect fit and optimum comfort. The micro fur interior provides softness and warmth and ensures easy foot entry. The new upper cuff structure provides a better torsion-comfort ratio.

Skiers will find this boot liner comfortable and attractive, while boot fitters will find it both safe, and easy to inject.

SIZES C-L

- 1. Pullstraps: Easy foot entry
- 2. Pu carbon structure: Flexibility & design
- 3. Micro fur interior: Softness, warmth & easy foot entry
- 4. Pre-shaped injection pocket: Initial fit & ease of injection
- 5. Laces: Good foot support



Issued with Ready-to-fit tongue



PU CLASSIC RACE

Ref. CCHPUCLARACE

Ref. 311930000

The Classic Race PU innerboot is exclusively designed for narrow ski boots. Uncompromising, it is ideal for skiers looking for ultimate precision. With its fine pocket structure, the innerboot perfectly fits the foot and the shell after injection. Every detail is meticulously thought out to avoid hard spots. Fitted with an injectable tongue (by PU gun), the innerboot guarantees optimal and personalised shin comfort.

SIZES C - L

- 1. Pullstraps: Easy foot entry
- 2. Pu carbon structure: Flexibility & design
- 3. Textile interior: Precision & easy foot entry
- 4. Thin injection pocket: Precise injection
- 5. Strap holding
- 6. Injected tongue

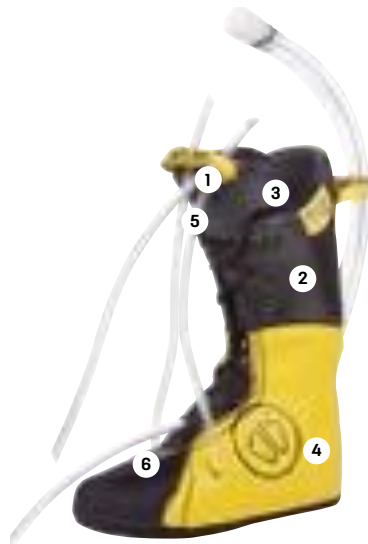

Issued with PU foam tongue



PU TRANSFOAM FLEX

Ref. CCHPUTRAFLEX

Ref. 307886

This 'Flex' material has the same properties as Transfoam but offers more flexibility, stretchability and comfort. For technical skiers looking for a simpler injection process and a tolerant liner that doesn't affect shell rigidity. Transfoam technology features sealed bags that reduce leakage.



PU CLASSIC FLEX W

Ref. CCHPUCLAFLW15

Ref. 380462

The Classic Flex Women boot liner, developed for the needs of female skiers, combines comfort and precision. The form and the materials used (e.g. micro-fur) ensure softness, flexibility, elasticity and overall comfort. The design of these boot liners is ideal for the Sidas shells created especially for female skiers.





THERMOFORMABLE INNERBOOTS

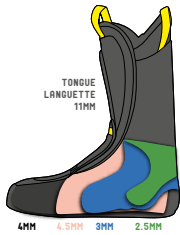

Issued with Ready-to-fit tongue slim

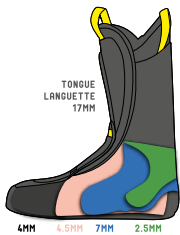

Issued with Ready-to-fit tongue

CENTRAL REMOVABLE TONGUE SLIM (CRT SLIM)

Ref. CCHCFTHERCRTSL19

Ref. 31643100

The finest thermoformable liner.

100% thermoformable, this liner is designed for alpine or touring ski boots with a low fitting volume. Designed with the same technology as the CRT, it is distinguished by its finesse and lightness.

The removable flap is thermoformable and can also be replaced by an injectable Sidas flap or a Heat Ready heated flap.

SIZES: D-K

1. Merry mesh lining: Comfort, lightness, low thickness
2. Collar joint: High flexibility, follows the rolling out of the foot as you walk
3. 3 lateral EVA thicknesses: Precision and comfort + heel support
4. Thin removable flap: For maximum precision



CENTRAL REMOVABLE TONGUE (CRT)

Ref. CCHCFTHERCRT18

Ref. 314194000

100% thermoformable, this liner is designed for alpine skiing and cross-country skiing.

The result of 2 years of development with the best bootfitters, its internal structure, with variable thicknesses, guarantees comfort and precision after moulding.

The removable flap is thermoformable and can also be replaced by an injectable Sidas flap or a Heat ready heated flap

SIZES D - K

1. Micro-fur upper lining: Maximum comfort
2. Merry mesh lower lining: For greater precision
3. Upper cuff opening: Flexibility
4. 3 EVA side width: Precision and comfort & heel support
5. Removable tongue: For optimal precision



CENTRAL HIGH V3

Ref. CCHCFCENTHIV3

Ref. 380460

Fully thermoformable. Provides maximum comfort and precision. Designed for alpine skiing and ski touring (high boots with 4 buckles).

With its internal design in black micro-fur the boot liner offers skiers softness and comfort.



CENTRAL WOMEN

Ref. CCHCFCENTW15

Ref. 380461

This fully thermoformable boot liner is designed for female skiers requiring comfort and warmth. This boot liner is also available in the warming version.



Pack of 10.



INNERBOOTS TONGUES

TONGUE HEAT READY powered by Therm-ic

Ref. CCHDCLARTFHR19

Ref. 316588000

Adjustable heated flap made using Therm-ic technology. Designed for skiers who suffer from cold feet who want to combine comfort and technology with a 100% customised heated liner. Invisible heating element integrated into the front of the liner ensuring optimal warmth for the foot. Works with C-pack Therm-ic batteries (sold separately)



READY-TO-FIT TONGUE SLIM

Ref. CCHDCLARTFSL19

Ref. 316589000

The fine and adjustable liner is designed for alpine or touring ski boots with a low fitting volume. Its design offers greater precision and adapts perfectly to the foot.



READY-TO-FIT TONGUE V2

Ref. CCHDCLARTFV2

Ref. 372492

A ready-to-fit tongue V2, with a highly curved shape to fit snugly against the foot and enable maximum transmission power, and a unique design to provide a perfect progressive flex.



PU FOAM TONGUE

Ref. CCHACFTONG17

Ref. 312025000

The adaptable tongue is very curved to fit perfectly to the foot and allow maximum power of transmission. Its unique design provides flexion perfect progressive.

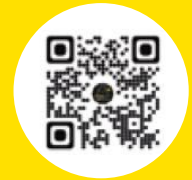

PU INNERBOOTS PROCESS





THERMO INNERBOOTS PROCESS

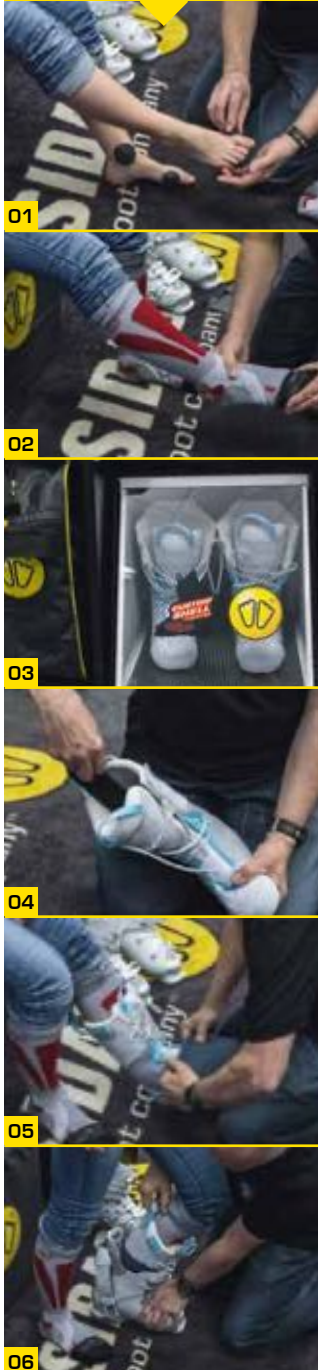

FOAM PODIUM

Ref. COUCHPOD
Ref. KC0111

The ultimate foaming station with adjustable handles, 2 drawers, and a rotation device to facilitate the foaming process.



MINI FOAM PODIUM

Ref. COUCHPOD2T
Ref. 866233

Podium to foam PU liners with drawers.



TONGUE PU KIT

Ref. CCHACDOSTON17
Ref. 312026101

Injection kit for PU tongue (technology with PU gun).



TONGUE PU GUN

Ref. CCHACPUGUN
Ref. 312028101

Gun for injecting PU tongues.



FOAM TONGUE STRAP

Ref. CCHACFTSTRAP
Ref. 99530901

The strap enables you to tighten the foam tongue against the shin, in order to control the foam flow.



3D TOE CAPS

Ref. (3 sizes) (T1 / TM / T2)
CCHACTOECAP3DX3
381879



PU DOWN-GRADING KIT

Ref. (box of 10) CCHACPUDDRKIT
Ref. (box of 10) 36007401

A dropper for obtaining a smaller dose of Isocyanate for a more flexible foam.



ADHESIVE PAD

Ref. CCHACCAL / KC1225
Ref. (Adhesive pads 5-15)
CCHACADH5-15 / 310969101
Ref. (Adhesive pads 2-50)
CCHACADH2-50 / 309564101
Packs ok 10



ADHESIVE ROLL

Ref. (Reinforced) CCHACS50
Ref. (Reinforced) KC1208
Ref. (Soft) CCHACS15
Ref. (Soft) KC2032



LYCRA SOCKS

Ref. CCHACCLY
Ref. KC1440



CONFOR'FIT OVEN

Ref. (220V) COUCHFOU2 / 10882001
Ref. (110V) COUCHFOU1 / 866018

The Confor'fit oven is designed for heating thermo-moldable liners.

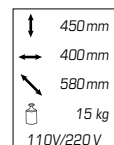



SOCKS

SOCKS

Your second skin





UNIQUE SOCK DESIGN BASED ON 300,000 FEET FOR A PERFECT FIT BETWEEN YOUR FEET AND YOUR SHOES!

Our SYNERGY FIT™ range:

- "PURE SOCKS" with no stitching or reinforcement around the foot for a perfect fit with your sole and shoe. For more sensitivity, more precision and more enjoyment!
- meets various needs dependent on your activity. For skiing, the main needs are: warmth, protection and compression.
- composed of several thicknesses to get the perfect fit in the shoe.



SYNERGYFIT



SKI



THICKNESSES



GUARANTEE FIT

THE SYNERGY FIT PURE SOCKS



MARKETING TOOLS



FACING SYNERGY FIT

Ref. EN-FR: CMKSOFACINSYFIT19
Ref. EN-FR: 316661101



POP SYNERGY FIT

Ref. EN-FR: CMKSOPPOPSYFIT19
Ref. EN-FR: 316662101

COMPOSITION LV

Natural fibres

- 20 % Merino

Synthetic fibres

- 59 % Polyamide
- 19 % Acrylic
- 2 % Elastane

COMPOSITION MV

Natural fibres

- 28 % Merino

Synthetic fibres

- 43 % Polyamide
- 27 % Acrylic
- 1 % Elastane

SIZES

XS 35/36
S 37/38
S/M 39/40
M/L 40/41
L 42/43
XL 44/45/46
XXL 47/48/49

SOCKS SKI **COMFORT**

Ref. Ski Comfort LV socks **CSOSKCOMF19_LV**

Ref. Ski Comfort LV socks **316422100**

Ref. Ski Comfort MV socks **CSOSKCOMF19_MV**

Ref. Ski Comfort MV socks **316422200**

Ski sock that combines warmth and sweat wicking for optimal comfort!

This ski sock is perfect for skiers looking for comfort and warmth. Specially designed to adapt to the anatomical shape of the foot to ensure maximum comfort for the skier so they can enjoy their day to the full. Natural wool combined with technical fibres ensures temperature regulation and effective sweat wicking. The sock is also compressive meaning that it is closer to the foot, ensuring optimal comfort.

2 THICKNESSES LV/MV: Available in low or medium volume to adapt to your foot & shoe fit

OPTIMAL COMFORT: Warmth and softness all day

KNEE LENGTH: Adapted to ski boots

HYBRID COMPOSITION: Regulates temperature & wicks away perspiration effectively

MODERATE FIT 10-15 mmHg: Fits the foot shape



COMFORT
Confort



WARMTH
Chaleur



THICKNESSES
Epaisseurs



MODERATE FIT
Tension moyenne



SOCKS SKI MERINO

Ref. Ski Merinos LV socks **CSOSKMERI19_LV**

Ref. Ski Merinos LV socks **316420100**

Ref. Ski Merinos MV socks **CSOSKMERI19_MV**

Ref. Ski Merinos MV socks **316420200**

Ref. Ski Merinos MV Brown **CSOSKMERBR20_MV**

Ref. Ski Merinos MV Brown **319842000**

The ski sock is made with a high percentage of merino, providing comfort and warmth during sporting activities, with a very good fit!

Comprising a high percentage of Merino wool, this warm sock is designed for skiers who suffer from cold feet. Natural wool combined with technical fibres ensures temperature regulation and effective sweat wicking for optimal comfort. This compressive sock also gives you greater sensation and precision when you practise your sport.

2 THICKNESSES LV/MV: Available in low or medium volume to adapt to your foot & shoe fit

MERINO WOOL: Warmth, odors & humidity absorption

KNEE LENGTH: Adapted to ski boots

HYBRID COMPOSITION: Regulates temperature & wicks away perspiration effectively

FIRM FIT 15-20 mmHg: Precision & sensation



MERINO WOOL
Laine Mérinos



WARMTH
Chaleur



THICKNESSES
Epaisseurs

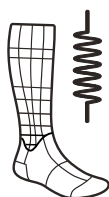

FIRM FIT
Forte tension



HIGH BLACK
FOOT 50 CM

Ref. **CMKKFPSFAIM20_50**
Ref. **319206101**



MID BLACK
FOOT 40 CM

Ref. **CMKKFPSFAIM20_40**
Ref. **319205101**



LOW BLACK
FOOT 30 CM

Ref. **CMKKFPSFAIM20_30**
Ref. **319204101**

COMPOSITION LV

Natural fibres

- 39 % Merino

Synthetic fibres

- 59 % Polyamide
- 2 % Elastane

COMPOSITION MV

Natural fibres

- 52 % Merino

Synthetic fibres

- 46 % Polyamide
- 2 % Elastane

SIZES

- XS 35/36
- S 37/38
- S/M 39/40
- M/L 40/41
- L 42/43
- XL 44/45/46
- XXL 47/48/49



SOCKS **SKI PROTECT**

Ref. Ski Protect LV socks **CSOSKPROT19_LV**

Ref. Ski Protect LV socks **316421100**

Ref. Ski Protect MV socks **CSOSKPROT19_MV**

Ref. Ski Protect MV socks **316421200**

The sock provides warmth and protection, enabling you to enjoy each day's skiing to the full!

This protective sock is designed for skiers who want to cushion shocks and eliminate shin pain. With tibial foam protection, it prevents pain and cushions shocks. Natural wool combined with technical fibres ensure temperature regulation and effective sweat wicking. The sock is also compressive meaning that it closer to the foot, ensuring optimal comfort.

2 THICKNESSES LV/MV: Available in low or medium volume to adapt to your foot & shoe fit

SHIN PROTECTION: Prevents shin pain & absorbs shocks

KNEE LENGTH: Adapted to ski boots

HYBRID COMPOSITION: Regulates temperature & wicks away perspiration effectively

MODERATE FIT 10-15 mmHg: Fits the feet shape



SHIN PROTECTION
Protection tibiale



WARMTH
Chaleur



THICKNESSES
Epaisseurs

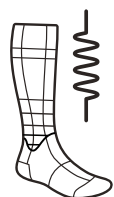

MODERATE FIT
Tension moyenne

COMPOSITION LV

Natural fibres

- 25 % Merino

Synthetic fibres

- 57 % Polyamide
- 16 % Polypropylene
- 2 % Elastane

COMPOSITION MV

Natural fibres

- 34 % Merino

Synthetic fibres

- 42 % Polyamide
- 22 % Polypropylene
- 2 % Elastane

SIZES

- XS 35/36
- S 37/38
- S/M 39/40
- M/L 40/41
- L 42/43
- XL 44/45/46
- XXL 47/48/49



SOCKS SKI ULTRAFIT

Ref. Ski Ultrafit ULV socks CSOSKULTH19_ULV
Ref. Ski Ultrafit LV socks CSOSKULTH19_LV

Ref. Ski Ultrafit ULV socks 316429100
Ref. Ski Ultrafit LV socks 316429200

Very thin and compressive sock, designed for skiers looking for greater performance and sensations.

Knitted with more than 200 needles, this ultra-fine sock ensures the direct transmission of information between the foot and the shoe. This second skin effect will make you feel as if you are skiing barefoot. The high compression offers greater precision and sensations, and aids recovery. Natural wool combined with technical fibres ensures temperature regulation and effective sweat wicking.

- SECOND SKIN EFFECT : Ultra-thin sock ideal for skiers looking for enhanced sensations
- 2 THICKNESSES ULV/LV: Available in ultra low or low volume to adapt to your foot & shoe fit
- KNEE LENGTH: Adapted to ski boots
- HYBRID COMPOSITION: Regulates temperature & wicks away perspiration effectively
- COMPRESSION FIT 20-30 mmHg: Performances & recovery.

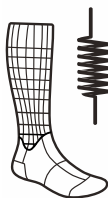

COMPRESSION
Compression



COMFORT
Confort



THICKNESSES
Epaisseurs



PRECISION
Précision



COMPOSITION ULV

- Natural fibres
- 22 % Merino
 - 10 % Silk
- Synthetic fibres
- 66 % Polyamide
 - 2 % Elastane

COMPOSITION LV

- Natural fibres
- 32 % Merino
 - 10 % Silk
- Synthetic fibres
- 48 % Polyamide
 - 10 % Elastane

SIZES

- XS 35/36
- S 37/38
- S/M 39/40
- M/L 40/41
- L 42/43
- XL 44/45/46
- XXL 47/48/49



BATTERY NEO S

Ref. HESONEOS17
Ref. 511939101



NEO-S

LOW 6h to 8h

MEDIUM 3h to 4h

MAX 2h to 3h

BATTERY PRO S

Ref. HESOPROS17
Ref. 511938101



PRO-S

LOW 12h to 16h

MEDIUM 6.5h to 7.5h

MAX 4h to 5.5h

COMPOSITION LV

Natural fibres

- 25 % Merino

Synthetic fibres

- 57 % Polyamide
- 16 % Polypropylene
- 2 % Elastane

COMPOSITION MV

Natural fibres

- 34 % Merino

Synthetic fibres

- 42 % Polyamide
- 22 % Polypropylene
- 2 % Elastane

SIZES

- XS 35/36
- S 37/38
- S/M 39/40
- M/L 40/41
- L 42/43
- XL 44/45/46
- XXL 47/48/49

SOCKS SKI HEAT

Ref. Ski Heat LV socks CSOSKHEAT19_LV

Ref. Ski Ultrafit ULV socks 316428100

Ref. Ski Heat MV socks CSOSKHEAT19_MV

Ref. Ski Heat MV socks 316428200

Powered heat socks, provide optimal comfort and warmth during your sporting activities, with a very good fit!

This heated sock is designed for skiers who suffer from cold feet. An invisible heating element on the outside of the sock gives off a soft and constant heat under the front of the foot for optimal comfort. Natural wool combined with technical fibres ensure temperature regulation and effective sweat wicking. This compressive sock also gives you greater sensation and precision when you practise your sport.

2 THICKNESSES LV/MV: Available in low or medium volume to adapt to your foot & shoe fit

HEATING ELEMENTS: Distributes gentle, constant and uniform warmth

KNEE LENGTH: Adapted to ski boots

HYBRID COMPOSITION: Regulates temperature & wicks away perspiration effectively

FIRM FIT 15-20 mmHg: Greater precision & sensation



HEATING
Chauffant



COMFORT
Confort



2 THICKNESSES
Epaisseurs

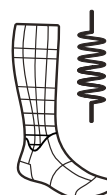

FIRM FIT
Forte tension



FITTING SERVICES

Making the liner, insoles & shell yours



**STRETCH THE SHELL TOOLS**

CROCO TWIN	Ref. COUCHCROTWIN20 Ref. 319783101	 NEW
YETI V2	Ref. COUCHYETI14 Ref. 37249401	

STRETCH THE SHELL TIPS

VARIABLE ARCH	Ref. COUCHARCH14 Ref. 37249501	
STRETCHING RING	Ref. COUCHRING14 Ref. 37249601	
MET BALL	Ref. COUCHMETBALL14 Ref. 37248701	
ANKLE BALL	Ref. COUCHANKLE14 Ref. 37249801	
MET OGIVE	Ref. COUCHMETOGIV14 Ref. 37249901	
MET OGIVE XL	Ref. COUCHMETOGXL20 Ref. 319784101	 NEW
WOOD MET 1	Ref. COUCHWOODMET1 Ref. 37250001	
WOOD MET 2	Ref. COUCHWOODMET1 Ref. 37250102	
JUMBO/JUMBO+	Ref. COUCHJ-J Ref. KC0104	
OVAL TIP 67	Ref. COUAOYOG Ref. 37257601	
ROUND TIP 50	Ref. COUAOYEG Ref. 37257701	
ROUND TIP 35	Ref. COUAOYEP Ref. 37257801	
WOOD TIP1	Ref. COUCHWOODTIP1 Ref. 37250201	
WOOD TIP2	Ref. COUCHWOODTIP2 Ref. 37250301	
WOOD HEEL	Ref. COUCHWOODHEEL Ref. 37250401	

ACCESSORIES

CROCO LIGHT FIX	Ref. COUCHFIXCROCLHT Ref. 37250501	
CROCO TWIN FIX	Ref. COUCHFIXCROTW20 Ref. 319785101	 NEW
SYMETRIC CONNECTOR	Ref. COUCHSYMCON Ref. 37250601	
EXTENSION 28 MM	Ref. COUAOYPR Ref. 37257901	
EXTENSION 40 MM	Ref. COUAOYMR Ref. 37258001	
EXTENSION 75 MM	Ref. COUAOYGR Ref. 37258101	
WASHER 3MM	Ref. COUAOYRO Ref. 37258201	
STABILITY BLOCK	Ref. COUCHPONT13 Ref. 37258301	

REJET - UNIREJET - TOOLS

CROCO	Ref. COUCHCROCO14 Ref. 37250701	
--------------	------------------------------------	---

OPEN THE SHELL

JACK	Ref. COUCHJACK Ref. KC0108	
BOOT HOLDER - 1	Ref. COUCHSABO Ref. KC0105	 1
TOOL CLAMP - 2	Ref. COUCHFIXE Ref. KC0106	 2
BOOT SPREADER 360	With fixation: Ref. COUCHSPREADFIX Ref. 37250801 Without fixation: Ref. COUCHSPREAD Ref. 37250901	

HEAT THE SHELL

NESTOR V3	Ref. CMALBBL30NES Ref. 36009901	
------------------	------------------------------------	---



KIT DEFORM TWIN

Ref. COUCHKIT75TWIN

Ref. 319792101



Experience shows that more than 75% of the reshaping done by bootfitters are due to localised foot pain.

This Kit Deform Twin is the basic kit for stores wishing to start a boot-fitting operation and to offer a quick and efficient service to their customers.



TOOLS	CHARACTERISTICS	ADVANTAGES	BENEFITS
1 CROCO TWIN	<ul style="list-style-type: none"> - 10mm steel structure - 45° curvature - Deformation measuring system - Removable tool support heads 	Shell reshaping tool that allows the bootfitter to access all parts of the shoes and also to measure the size of the reshaping carried out. Its symmetrical construction allows a single tool to be used for the best results for both right and left shoes.	<ul style="list-style-type: none"> - The precision of the alignment of the tool under Stress is guaranteed - Allows for precise reshaping of the forward parts of the foot (M1 and M5) - The reshaping work is carried out with precision - Makes it possible to work on the right and left areas with a single tool - Easy and effortless reshaping
2 VARIABLE ARCH	<ul style="list-style-type: none"> - Double shaft - Plates on ball joint - 190 mm serif 	<ul style="list-style-type: none"> - Possibility to have 2 push axis - Provides support on differently shaped surfaces - Big space between the push axis and the support surface 	<ul style="list-style-type: none"> - Allows very extensive forefoot deformations - Provides a stable and homogeneous support - Avoids damaging the shell during deformation
3 STRETCHING RING	<ul style="list-style-type: none"> - Diam: 137 mm 	<ul style="list-style-type: none"> - Large support far from push axis 	<ul style="list-style-type: none"> - Doesn't mark the shell
4 METAL CONNECTORS	<ul style="list-style-type: none"> - Aluminium structure - Mounted with screw 	<ul style="list-style-type: none"> - Maintains the heat - Easy to mount and dismount 	<ul style="list-style-type: none"> - Give an inside heating of the deformation zone, creating a more precise and quick deformation - Time gain when changing the tips, and keep the rotation of the tips

KIT DEFORM 75 +

Ref. COUCHKIT75P

Ref. 37251301

This kit is designed to complement the Deform 75 kit. It is used for localised shaping of wider boot shells. Used together with the Deform 75 kit, it provides an enhanced solution to customers' localised foot pain problems.

- 1** WOOD MET 1
- 2** WOOD MET 2
- 3** EXTENSION 28 + SYMETRIC CONNECTOR



KIT DEFORM YETI

Ref. COUCHKIT75P

Ref. 37251401

Used and approved by boot fitters for more than 10 years, the Yeti and Yeti+ kits have now been combined to create the Deform Yeti kit.

It is suitable for all generalised boot shaping requirements. Designed to complement the Deform 75 and Deform 75+ kits, it is suitable for all boot shell-shaping requirements.



**BOOTFITTING SERVICE**

Ref. CMALBBFSERV15

Ref. 38046701

The Bootfitting Service is a working and storage unit that allows you to promote the boot-fitting service in your store. It consists of a work table, a drawer, a storage space for the oven and a space to display messages about your store and boot-fitting service.

The Bootfitting Service is for use with Sidas tools such as the Kit Deform 75 or the Kit Deform Yeti.

Unit only - tools to be ordered separately.

Overall dimensions: 86 x 63 cm

Working surface dimensions: 75 x 54 cm

MADE IN
FRANCE**BOOT SPREADER 360**Ref. without accessories
COUCHSPRE360
319786101Ref. Kit
COUCHKITSPRE360
319790101**NEW**

Makes the analysis easier. It is the essential in-store tool to check that the shoe is suitable for the foot.

Its ability to open wide and rotate through 360° make working with it safer and simpler.

- Aluminium profile structure
- Enhanced steel handles
- Universal shell attachment system

Dimensions: 54 x 43 CM

**OPTION****OPTION
LED LIGHT**Ref. COUCHLEDLIGHT
Ref. 319788101

Magnetic lamp that can be fixed to the Bootspreader 360, allowing the inside of the shell to be lit for precise and safe work.

**OPTION BALL JOIN
HOLDER 360**Ref. COUCHBALLHOL360
Ref. 319787101

Fixable ball joint on the work bench allowing the shell to be oriented in any direction.

**OPTION WORKBENCH
ADAPTOR**Ref. COUCHWOBENADAP
Ref. 319789101

Fixing bracket for the worktop allowing the bootspreader to be offset on the worktable for better ergonomics for the bootfitter.



Working situation



ON SOLE & TONGUE SOLUTIONS

VOLUME REDUCER

Ref. 3MM
CSEDSRV3
995942

Ref. 5MM
CSEDSRV5
866007

This volume-reducer can be placed under a Sidas insole to reduce the fitting room and provide better foot support inside the boot, for superior precision and comfort.

Available in 3mm thickness (high-density) and 5mm thickness (medium-density). Can be trimmed to ensure a better fit inside the boot.

Sold in boxes of 20 pairs.



3 mm

5 mm



HEEL LIFT HARD

Ref. 4MM
CSEACHELLFT16_HD_04
309545201

Ref. 6MM
CSEACHELLFT16_HD_06
309545202

Heel insert that goes inside the boot to reduce the volume.
Sold in packs of 20 pairs.

Heel lift hard 4mm

Heel lift hard 6mm



HEEL LIFT SOFT

Ref. 6 MM CSEACHELLFT16_SF_06

Ref. 6 MM 309545102

Heel insert that goes inside the boot to reduce the volume.
Sold in packs of 20 pairs.

HEEL LIFT SOFT 6MM



TONGUE SPOILER COVER

Ref. CCHACIPSCOV16-SPO

Ref. 309769101

Pack of 20 units



TONGUE SPOILER

Ref. CCHACTONGSP016

Ref. 309567101

The tongue spoiler is used to regulate the volume between the shell interior and tongue.

The spoiler is:

- pre-shaped;
- adhesive-coated;
- grindable;
- thermoformable;
- thickness 5 to 10 mm;
- pack of 1 pair.

Available in 1 size





WORK ON EXISTING LINERS

ICP • INNERBOOT PADDING SYSTEM

Ref. 10 ROUNDS
CCHACICP-ROND
328535

Ref. 10 OVALS
CCHACICP-OV
328539

Ref. SCALPEL + 1 BLADE
P99SCALPEL
32834001

5 BLADES FOR SCALPEL
P99SCALPLAME
32834101

A way of modifying boot liners to solve skiers' foot problems!

This system involves cutting sections out of the boot liner in the places that are causing the skier pain and replacing these sections with Innerboot Comfort Padding, making the liner more comfortable and quickly relieving pain. Pre-cut elements in several shapes with a protective top layer included: a fast solution for the bootfitter.

Materials used: padding made from Expertène 220 (PU foam) and Ionmesh top layer: advanced materials for an effective, professional solution.

Grey top layer with Sidas logos.



ICP KIT

Ref. CCHACICPKIT

Ref. 32833901

- 1 Scalpel
- Oval pads: 4s – 6m – 2l
- Oval toplayers: 4s – 6m – 2l
- Round pads: 2s – 4m – 6l
- Round toplayers: 2s – 4m – 6l

MARKETING TOOLS



BOOTFITTING POSTER

Ref.
CMKPOSB00TF14
37256401

Information poster about Sidas' boot-fitting solutions for in-store display.



BOOTFITTING PRICE SERVICES POSTER

Ref.
CMKBOOTFITPR14
37256101

Boot-fitting prices poster for workshop services.



ICP PROCESS





WORK ON EXISTING LINERS

IPS • INNERBOOT PADDING SYSTEM



IPS PROCESS



(PACK OF 10 PCS - ONE SIZE)
 Ref. IPS C SHAPE
CCHACIPS16-C
 309557101



(PACK OF 20 PCS - ONE SIZE)
 Ref. IPS C COVER
CCHACIPSCOV16-C
 309740101



(PACK OF 10 PCS - ONE SIZE)
 Ref. IPS DONNUT SHAPE
CCHACIPS16-DON
 309562101



(PACK OF 20 PCS - ONE SIZE)
 Ref. IPS DONNUT COVER
CCHACIPSCOV16-DON
 309741101



(PACK OF 10 PCS - SIZES: M - L)
 Ref. IPS V SHAPE
CCHACIPS16-V
 309561000



(PACK OF 20 PCS - ONE SIZE)
 Ref. IPS V COVER SIZE
CCHACIPSCOV16-V
 309742101

IPS KIT

Ref. **CCHACIPSKIT** Ref. **99658701**

- 6 Double-taped soft foam sheets
- 4 Double-taped hard foam sheets
- 5 Double-taped resin sheets
- Scissors, pen and templates

IPS SHEET

Ref. IPS soft foam 25 CCHACIPSOFT 99658801	Ref. IPS hard foam CCHACIPSHARD 99658901
Ref. IPS soft foam 40 CCHACIPSOFT40 309554101	Ref. IPS Resin CCHACIPSRESI 99659001
Ref. IPS templates CCHACGAB KC2033	



**CONFOR'FIT OVEN**

Ref.220V
COUCHFOU2
10882001

Ref.110V
COUCHFOU1
866018

The Confor'fit oven is used to heat thermoformable boot liners (central high, central women, etc.).

It is also used to heat ski boots with a thermoplastic shell, including Salomon® models.

The Confor'fit oven can be heated to 105°C (variation of + or - 5°C).



	450 mm
	400 mm
	580 mm
	15 kg
110V/220 V	

HEAT GUN

Ref. COUSESAC

Ref. KC0112

High-quality hot-air gun tested and approved for bootfitting operations (localised heating of the inside and outside of the boot shell, reactivating glue and adhesives, etc.).



	Temperature (°C)	Heating process	Mobile	Can be left to run	Associated products						Comments
					Glue & Tape	Fitting elements	CustomFit liners	Fullthermo liners	Small areas of shell	All of shell	
HEAT GUN	90 - 600	local	•		•	•			•		The must-have for any boot fitting business
CONFOR'FIT OVEN	105	interior/exterior		•		•	•	•		•	The only tool that heats both liners and shell at the same time





FOOT PRODUCTS

Foot care solutions





SHIN PROTECTORS

Ref. ASKINSHINPROTXL16

Ref. 109555101

Larger shin protectors for maximum comfort.
 The shin protectors are supplied in pairs and are specially shaped to fit the shin.
 They effectively relieve pain caused by pressure on the shins from ski boots. Placed underneath the sock, these protectors stay firmly in place throughout any sporting activity.



x 2

Varying-thickness get: 2 mm at the edges and 4 mm in the middle, for improved protection.

Re-usable.

Hand-washable with household detergent for a better hold.

Supplied in 20s in a paperboard box that also serves as the in-store display unit.

ANKLE PROTECTORS

Ref. ASKINANKLEPROT16

Ref. 109556101

Silitene™ protectors specially designed to fit round the ankle.
 They effectively relieve pain caused by the boots pressing against and rubbing the inside and outside of the ankle.
 Placed underneath the sock, these protectors stay firmly in place throughout any sporting activity.



x 4

Varying-thickness get: 2 mm at the edges and 4 mm in the middle, for improved protection.

Re-usable.

Hand-washable with household detergent for a better hold.

Supplied in 20s in a paperboard box that also serves as the in-store display unit.

PROTECTOR SHEET 2MM

Ref. ASKINFOOTPROT14_02SH

Ref. 36829701

The Silitene™ protection sheet is your best ally when practicing a sporting activity. Apply the protection to on the friction areas to ease the pain for instant comfort.
 Their biomechanical construction allows for long-lasting protection. Washable. Multi day use.



x 1

Dimensions: 90 x 100 mm

MARKETING TOOLS



ON SKIN BOX

On Skin range box that can also be used as a display.
 All On Skin products are supplied in 20s in this box.



MARKETING TOOLS



FOOT PROTECTION WALL POS

FR/EN
 Ref. CFCMKFPWALLPOS_01
 Ref. 31106210
 EN/DE
 Ref. CFCMKFPWALLPOS_02
 Ref. 311062102

GEL TOE CAPS

Ref. ASKINGLTOECA17

Ref. 111050000



Gel toe caps allow you to enjoy your sport to the full. Used preventively, they avoid nails turning black due to impacts in the shoe. In case of existing pain, they absorb impacts for instant relief. Washable, reusable silicone protectors.

SIZES: S/M (36-40) / L/XL (41-47)

Pack par per

Ajustable lenght

Delivered in box of 20 or per unit



Sizes Tailles	Big Toe Gros orteil	Middle Toes Orteils moyens	Small Toes Petits orteils
36 - 39 (EU) 4 - 6 (US) 3 - 6 (UK)	S / M	XS	XS
40 - 46 (EU) 7.5 - 13 (US) 6.5 - 12 (UK)	L / XL	S / M	XS



GEL TOE WRAPS

Ref. ASKINGLTOEWR17

Ref. 111051000



Gel toe sleeves allow you to enjoy your sport to the full. They ease pain caused by friction between toes and prevent corns and calluses.

SIZES: S/M (36-40) / L/XL (41-47)

Pack par per

Ajustable lenght

Delivered in box of 20 or per unit



GEL PLANTAR PROTECTORS

Ref. ASKINGLPLAPR17

Ref. 111049000

Gel plantar protectors allow you to enjoy your sport to the full. Used preventively, they avoid inflammation, burns and blisters. In case of existing pain, they absorb impacts for instant relief.

SIZES: S/M (36-40) / L/XL (41-47)

Pack par per

Anatomical Constuction (right foot / left foot).

Delivered in box of 20 or per unit





BOOT ACCESSORIES

Enhance your bootwear





SIZE ADJUSTMENT



- Check the length of your ski boot in mm.
- Adjust the ski boot traction device to the corresponding size (round down). The tip of the arrow indicates the size selected.
- Screw in with a Phillips screwdriver.

FITTING THE DEVICE ON THE SHOE



- Strap on the ski boot traction, starting from the front of the boot, then pull back to adjust it on the heel.
- This product should be stored in a dry place, away from heat and UV sources. It is recommended to check the product every year.

SKI BOOTS TRACTION

Ski boot traction devices allow you to walk confidently and comfortably with your ski boots. Their tapered shape at the tip makes the movement of the foot easier and their asymmetric crampon design makes walking on snow safer.



MARKETING TOOLS



TRACTION DISPLAY

Ref.(EMPTY) **CTRMKCARTDISPL16**
 Ref.(EMPTY) **309542101**
 Ref. Full of product (20 walk demi /40 walk)
CTRPACKCTDISPL16
 Ref. Full of product (20 walk demi /40 walk)
309630101

Paperboard display unit supplied assembled.
 • Easy to move around the store.
 • Can accommodate 20 Traction ½ & 40 Traction, or 60 Traction.
 • Two options:
 Supplied without products.
 Supplied assembled with a set of products ready for sale.



COLUMN DISPLAY

Ref. **CMKPVTOURDIS15**
 Ref. **301216101**

The column display is a rotating display stand featuring:
 • 8 perforated sides
 • 5 castors, 2 of which have brakes
 • 1 platform for attaching a demonstration foot.
 Dimensions: 180 x 55 cm.

SKI TRACTIONS

Ref. **CTRSKIBOOT17**

Ref. **311573101**

Makes it easy to walk with your ski boots, and protects the outer sole of your shoe.

Available in 4 colours

- 1. Flexible and resistant rubber
- 2. Inner frame for better grip on your shoes
- 3. One size adjustable length
- 4. Small spikes for more grip

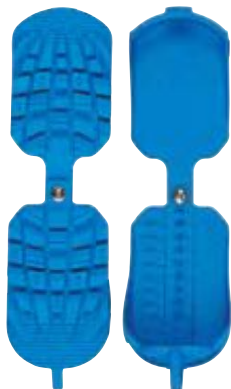

SKI BOOT TRACTION BLUE

Ref. **CTRSKIBOOTBLU19**

Ref. **3661267158995**



SKI BOOT TRACTION GREEN

Ref. **CTRSKIBOOTGRE19**

Ref. **3661267159008**



SKI BOOT TRACTION YELLOW

Ref. **CTRSKIBOOTYEL19**

Ref. **3661267155130**

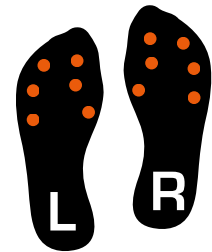

ASYMMETRIC CONSTRUCTION

WALK TRACTION

GRIP SNOW AND ICE

- Anatomically constructed to facilitate the forward flexing movement of each foot (right and left).
- End studs for superior grip.
- Wider stud base for long-lasting hold.
- Thick, hard-wearing rubber, as used in the motor industry, for a better hold on the foot.
- Shaped at the heel for a better fit.
- Stainless steel stud tips.
- Textured interior webbing for improved grip onto footwear.
- PPE (Personal Protection Equipment)-certified by the CTC.
- Each pair comes with two spare studs.





MARKETING TOOLS



TRACTION SMALL DISPLAY

Ref. CTRMKSMLDISPL16
Ref. 309541101

A slim display unit that you can place behind the checkout or for cross merchandising in the footwear department. It can accommodate 4 Traction products.

WALK TRACTION

Ref. CTRWALK16

Ref. 309532000

The Walk Traction system is the best way to stay safe when walking on snow and frozen ground.

Anatomically constructed to facilitate the forward flexing movement of each foot

Easy to put on

4 sizes for a perfect fit.

SIZES: S - M - L - XL



ACCESSORIES



SMALL BLACK POCKET BAG

Ref. ASACBLKPOCKBAG16
Ref. 109565101
Pack of 10.



SPARE SPIKES

Ref. CTRSPSPIKES16
Ref. 309533101
x 30.

WALK TRACTION 1/2

Ref. CTRWALKHALF16

Ref. 309531101

The Walk Traction 1/2 system is the best way to stay safe when walking on snow and frozen ground.

Small grip for city shoes.

Easy to put on.

1 Size.





VENTILATION



DRYFLOW UV

Ref. DRYFLOW UV EUR
HEDRFLOUVEU19
516579101

Ref. DRYFLOW UV UK
HEDRFLOUVUK19
516581101

Ref. DRYFLOW UV US
HEDRFLOUVUS19
516582101

The DRYFLOW UV dries and purifies wet boots. Quick and effective for all types of boots. Equipped with ultraviolet lamps, the DRYFLOW UV dries, heats, and cleans all shoe types. Easy & compact storage : Adjustable length



AIR FLOWING & DRYING SYSTEM



UV LIGHT



EASY STORAGE



DRYFLOW MINI

Ref. HEDRFLOMINUSB20

Ref. 519782101

NEW

The Dryflow Mini thoroughly dries out boots in just a few hours. Its ventilation system and UV lamps allow for fast, effective drying for all types of boots. The included timer automatically controls drying time. Compact and lightweight, it is easy to both transport and store. The USB power supply is compatible with all chargers with a USB port (not supplied).



AIR FLOWING



UV LIGHT



TIMER



EASY STORAGE

NATURAL



DRYER BAG CEDAR WOOD

Ref. CSHACDRYBAW00D19

Ref. 315502101

The Dryer Bag Cedar Wood naturally dries all types of damp shoes.

- Absorbs moisture from your shoes 4 times faster than air-drying
- Eliminates odours thanks to its anti-fungal process.
- Made using 100% natural cedar wood and a polyester fabric.
- Reusable and durable product.



NEW

DISPLAY DRYER

Ref Full. CSHPACKDRYDISFUL20
Ref. 319846101
Ref Empty. CSHMKDRYDISP20
Ref Empty 319845101

Max capacity: 87 packs
Cardboard display stand:
width: 540mm and height: 1400mm
without the header
Easy to move around in store
Two options available:
- delivered without products
- delivered assembled with a set of
retail ready products
Included: 50 Cedar Wood dryer bags,
25 Dryflow Mini and 12 Dryflow UV.





VORTEX

DRYWARMER PRO USB

Ref. DRYWARMER PRO USB
HEDRWPROUSB18
514334101

Combines drying with sanitising. With the Drywarmer PRO USB, your shoes dry faster. The Vortex effect optimises the circulation of warm air in your boots and reduces the drying time.

The Drywarmer PRO USB is also equipped with an ultraviolet light providing a sanitising, anti-bacterial action. It is also equipped with a timer to programme the drying time of your shoes. The ergonomic shape makes it possible to heat and dry all types of shoes and gloves. The USB socket allows for charging via power adapters equipped with a USB socket (not provided), via wall sockets equipped with USB ports, and via your car.



VORTEX



TIMER



UV LIGHT



EASY STORAGE



USB



DRYWARMER NEO USB

Ref. HEDRWNEOUSB18

Ref. 514333101

Shoe Drying System

With the Drywarmer NEO USB, your shoes dry faster. The Vortex effect optimises the circulation of warm air in your boots and reduces the drying time. The ergonomic shape makes it possible to heat and dry all types of shoes and gloves.

The USB socket allows for charging via power adapters equipped with a USB socket (not provided), via wall sockets equipped with USB ports, and via your car.



VORTEX



EASY STORAGE



USB



POWER STRAP

Ref. Powerstrap men*
CCHACBOOSIDM15
309520101

The Sidas Booster™ Strap is an essential accessory for improving ski boot performance.

When used correctly, it ensures excellent control of the skis, improves comfort and helps prevent shin pain. It eliminates empty space between the shin and the ski boot tongue.



*Not to be sold in North America (USA and Canada)



The Sidas Booster™ Straps are supplied with 4 screws and 4 grip inserts.



BAGS

BOOT BAG **BLUE- NYLON**

Ref. ASACSKIBAGBL17

Ref. 111792101

Ski boot bag made of soft nylon, allowing easy insertion of the boots.

Dimensions: 40 x 42.5 X 24 cm

Composition: 600 d coated polyester and nylon

Reinforcements: 4 plastic reinforcements on the underside + moisture-wicking



BOOT BAG **BLACK**

Ref. ASACSKIBOOTBK15

Ref. 38046901

The Boot Bag Black is an ultra-light, water and dirt-resistant boot bag, reinforced to protect the contents.

The bag opens at the top to allow easier access to gear. The side pocket offers practical storage. The shoulder strap has been reinforced for added comfort when carrying.

The bag is easy to carry thanks to its shoulder strap that can be adjusted to each different person.

Dimensions: 40 x 42.5 X 24 cm

Composition: 600 d coated polyester and nylon



BOOT BAG **MOUNTAIN**

Ref. ASACSKIBAGMOUNT17

Ref. 111899101

The Mountain Boot Bag is a lightweight and sturdy ski boot bag. Its coated fabric is water-resistant and dirt-resistant; its numerous reinforcements protect the contents of the bag and increase its durability. Its central opening allows easier access to the equipment.

Dimensions: 40 x 42.5 X 24 cm

Composition: 600 d coated polyester and nylon

Reinforcements: 4 plastic reinforcements on the underside + moisture-wicking





BOOT BAG WOMEN

Ref. ASACSKIBOOTW15 Ref. 38046801

The Boot Bag Women is an ultra-light, water and dirt-resistant boot bag, reinforced to protect the contents. The bag opens at the top to allow easier access to gear. The side pocket offers practical storage. The shoulder strap has been reinforced for added comfort when carrying. The bag is easy to carry thanks to its shoulder strap that can be adjusted to each different person.

.....
Dimensions: 40 x 42.5 x 24 cm
.....
Composition: 600 D coated polyester and nylon
.....



NYLON SHOE BAG BLACK

Ref. ASACOUTDSHOE17 Ref. 110900101

The Sidas Nylon Shoe Bag is a small ultra-light bag for one pair of cross-country skiing shoes. It is made of a water-resistant and dirt-resistant fabric to protect the bag's contents perfectly.

.....
Soft bag, 1 front pocket with zipper, 4 plastic stays under the bag
.....
Dimensions: 33 x 25 x 22 cm
.....
Composition: nylon
.....



LIGHT SHOE BAG

Ref. Blue ASACLGTSHOEBL17 111048101 Ref. Yellow ASACLGTSHOEYE17 11651101

The Sidas Small Sport Shoe Bag is lightweight, easy to carry and can hold a pair of shoes. This small promotional bag can make a lovely gift for your customers (sold in packs of 10).

.....
Format: 50 x 42 cm (yellow) / 40 x 38 cm (blue)
.....
Composition: nylon
.....



POCKET BAG

Ref. ASACBLKPOCKBAG16 Ref. 109565101

The Sidas Pocket Bag is a small, ultra lightweight bag. It is made from water- and dirt-resistant fabric.





MARKETING & COMMUNICATION

SIDAS TOOLS



SMALL STICKERS - PACK OF 10

CMKSTISMAL12 32953701

Dimensions : 7 cm x 2.5 cm

BIG STICKERS - PACK OF 10

CMKSTISBIG12 329538



SHOP WINDOW STICKER

CMKSTIWIND12 32697601

Sticker specially designed for shop windows.
Dimensions : 20 cm x 11 cm



CARPET

CMKPV TAPIS12 32698301

Dimensions : 80 cm x 60 cm



CARPET CORNER

CMKPV TAPISGF 11141101

Dimensions : 200 cm x 200 cm



SIDAS CUBE

CMKSIDAS CUBE12 35476601

Dimensions : 47 cm x 47 cm



SIDAS CUBE

CMKSIDAS BFCUBE16 35476601

Dimensions : 40 cm x 40 cm



SIDAS BOOTH

CMKSIDAS B00TH12 35476801

Dimensions : 2.25 m x 2.25 m

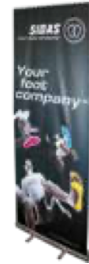

SIDAS BANNER

CMKSIDAS BANNER12 35476701

Dimensions : 80 cm x 2 m



SIDAS BOOTFITTING CUBE

CMKSIDAS BFCUBE15 380 48401

Dimensions : 40 cm x 40 cm



STICKER VITRINE "CERTIFIED BOOTFITTEUR"

CMKSTIWINDBF 32834201

«Certified Bootfitter» window sticker
Dimensions : 21 x 12 cm



SHOE STICKERS - PACK OF 20

CMKSTISHOE14 36833501

Dimensions : 1.5 cm x 1.5 cm



FLAME FLAMME SIDAS 18- PIED

315168101 CMKPV FLAMSID18_PIED

FLAMME SIDAS 18 - VOILE HOUSSE

315167101 CMKPV FLAMSID18_VOILE

Dimensions : 2,30 m x 60 cm



NEOPRENE GLUE 1

P99COLLE1 352 51201



OK NET

SIACOKNET19 818625101

Cleaning spray for analysis and measurement tools, machine pads, scan...



FOOTBED TEMPLATES

39072011 866 096

Templates for checking shoe or liner size.



SCISSORS

P99CISTITANIUM 605586101

Strong scissors for cutting footbeds.

CLOTHES



SIDAS GILET

SIMKGILSIDAS 379 180



SIDAS SWEAT SHIRT

SIMKSWEATZIP14 808723000



SIDAS THIN SWEATER

SIMKSWEAT17 812448000



DISPLAYS



FRAME ILLUMINATED DISPLAY
CMKPVILLDISPFRAM20 318361101

SHELVE ILLUMINATED DISPLAY
CMKPVILLDISPSHEL20 318363101

HOLDER ILLUMINATED DISPLAY
CMKPVILLDISPHOLD20 318364101

HOOK ILLUMINATED DISPLAY
CMKPVILLDISPHOOK20 318362101

FIT PROTOCOL ANALYSIS - LIGHT BOX
- EN - SIMKFITPROANALYSEN
- DE - SIMKFITPROANALYSE
- FR - SIMKFITPROANALYSFR

FIT PROTOCOL SUM UP - LIGHT BOX
- EN - SIMKFITPROSUMUPEN
- DE - SIMKFITPROSUMUPDE
- FR - SIMKFITPROSUMUPFR

CUSTOM INSOLES - LIGHT BOX
- EN - SIMKCUSTOMINSOLEEN
- FR - SIMKCUSTOMINSOLEFR



DISPLAY DRYER

Ref. CSHPACKDRYDISFUL20
Ref. 319846101
Ref Empty. CSHMKDRYDISP20
Ref Empty 319845101

Max capacity: 87 packs
Cardboard display stand:
width: 540mm and height: 1400mm
without the header
Easy to move around in store
Two options available:
- delivered without products
- delivered assembled with a set of
retail ready products
Included: 50 Cedar Wood dryer bags,
25 Dryflow Mini and 12 Dryflow UV.



TRACTION DISPLAY

Ref.(EMPTY) CTRMKCARTDISPL16
Ref.(EMPTY) 309542101
Ref. Full of product (20 walk demi /40 walk)
CTRPACKCTDISPL16
Ref. Full of product (20 walk demi /40 walk)
309630101

Paperboard display unit supplied
assembled.
Easy to move around the store.
Can accommodate 20 Traction ½ &
40 Traction, or 60 Traction.
Two options: Supplied without
products.
Supplied assembled with a set of
products ready for sale.



COLUMN DISPLAY

CMKPVTOURDIS15 301216101

Max. capacity: 120 packs.
The column display is a rotating
display stand featuring:
- 8 perforated sides
- 5 castors, 2 of which have brakes
- 1 platform for attaching
a demonstration foot.
Dimensions: 180 x 55 cm



MAXI DISPLAY

CMK3DDISPL12 32695201

Max. capacity: 120 packs,
60 on each side.
Order separately : 2 facing / 2 POP
Can include a Feet Revelator™.
Can also be used on one side only.
Dimensions: 75 x 160 x 60 cm



MID DISPLAY V2

CMKPVMIID12 32955801

Max. capacity: 120 packs,
60 on each side.
Order separately : 2 facing / 2 POP
Can include a Feet Revelator™.
Can also be used on one side only.
Dimensions: 75 x 160 x 60 cm

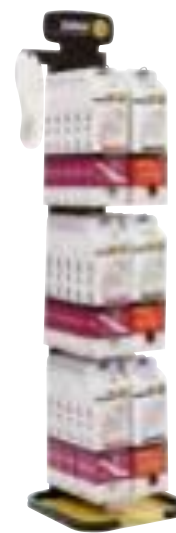

MINI DISPLAY

CMKPVMINI15 309027101

Max. capacity: 45 packs,
30 packs on the front and 15 on the
back.
Can also be used on one side only.
Dimensions: 36 x 128 x 36 cm



MAPPING

INSOLES

3D					
	SANISOL 3D	WINTER 3D RENTAL	WINTER 3D MERINO	WINTER 3D PERFORMANCE	NORDIC 3D
3Feet					
	WINTER 3FEET® HIGH	WINTER 3FEET® MID	WINTER 3FEET® LOW		
					
	3FEET® MERINO HIGH	3FEET® MERINO MID	3FEET® MERINO LOW		
FLASHFIT™					
	WINTER +	WINTER + SLIM	COMFORT + MERINO		
C Custom					
	WINTER CUSTOM COMFORT	WINTER CUSTOM RACE MERINO	WINTER CUSTOM SKI	WINTER CUSTOM PRO	
					
	CUSTOM XC CLASSIC	CUSTOM XC SKATING	CUSTOM COMFORT MERINO	WINTER CUSTOM PRO HEAT READY	
HEAT					
	3D POWER HEAT	FLAT POWER HEAT	POWER HEAT ELEMENTS & COVERS	HEAT READY PACK 10	
MODULO					
	MODULO				

SOCKS

				
SOCKS SKI COMFORT	SOCKS SKI MERINO	SOCKS SKI PROTECT	SOCKS SKI ULTRAFIT	SOCKS SKI HEAT

















FOOT PRODUCTS

					
SHIN PROTECTOR	ANKLE PROTECTOR	FOOT PROTECTOR SHEET 2 mm	GEL TOE WRAP	GEL TOE CAP	GEL PLANTAR PROTECTORS

BOOTWEAR

THERMO INNERBOOTS							
	CENTRAL REMOVABLE TONGUE (CRT SLIM)	CENTRAL REMOVABLE TONGUE (CRT)	CENTRAL HIGH V3	CENTRAL WOMAN			
	PU INNERBOOTS						
		PU CLASSIC RACE	PU CLASSIC COMFORT	PU TRANSFOAM FLEX	PU CLASSIC FLEX W		
PU LANGUETTE							
		TONGUE HEAT READY	READY-TO-FIT TONGUE SLIM	READY-TO-FIT TONGUE V2	PU FOAM TONGUE		

BOOT & SHOE ACCESSORIES

TRACCTIONS							
	WALK TRACTION	WALK TRACTION	SKIBOOTSTRACTION				
	BOOSTER						
		POWER STRAP MEN					
BOOT BAGS							
		BOOT BAG WOMEN	BOOT BAG BLACK	NYLON SHOE BAG	BOOT BAG BLUE	BOOT BAG MOUNTAIN	LIGHT SHOE BAG POCKET BAG
	DRYING & HEATING						
		DRYWARMER NEO USB	DRYWARMER PRO USB	DRYFLOW UV	DRYFLOW MINI		



MEASURING THE FOOT

SIZES

A size is a series of measurements, expressed in points, that characterise a foot, last or shoe.

There are different size systems, each with its own history and logic: The Paris Point (EUR), the American Point (US) and the English Point (UK).

The Mondopoint (MP) system, resulting from work carried out by more than 18 countries and governed by international standard ISO 9407, has been created to harmonise the scales.

STEP 1

Measurement of the length and width of the foot



1
Analysis of the foot length



2
Analysis of the foot width

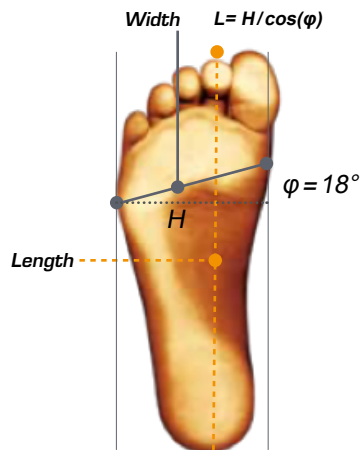

Foot Sizer

STEP 2

Pressure analysis

Analysis of the foot pressure



1



2



3



①

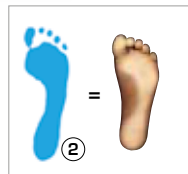

②



③

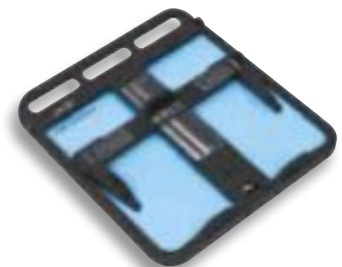

Feet Revelator™

1. Two pressure points
2. Anatomical pressure
3. Uniform pressure

STEP 3

Analysis of volume and shape

Analysis of the volume and shape of the foot

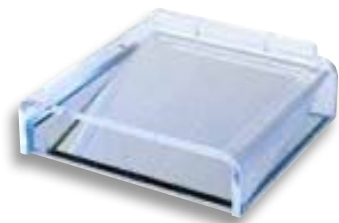

Podoscope



①



②























③

1. High-arched foot
2. Medium-arched foot
3. Low-arched foot



SIZE & FOAM CHART

Sizes	Insoles	Socks	Thermo Innerboots	PU Innerboots	Foam set colors (tongue)	
MP						
20						
20 1/2						
21						
21 1/2						
22	XS MP 22 - 23 EUR 35 - 36 UK 2 - 3 US 3 - 4	XS MP 22 - 23 EUR 35 - 36 UK 2 - 3 US 3 - 4		C 		
22 1/2				D 		
23						
23 1/2	S MP 23 1/2 - 24 1/2 EUR 37 - 38 UK 4 - 5 US 5 - 6	S MP 23 1/2 - 24 1/2 EUR 37 - 38 UK 4 - 5 US 5 - 6		E 		
24						
24 1/2						
25	M MP 25 - 26 1/2 EUR 39 - 41 UK 6 - 7 US 7 - 8	S / M MP 25 - 26 EUR 39 - 40 UK 6-6.5 US 7-7.5				
25 1/2						
26			M / L MP 26 - 26.5 EUR 40 - 41 UK 6.5-7 US 7.5-8	G		G 
26 1/2						
27	L MP 27 - 28 EUR 42 - 43 UK 8 - 9 US 9 - 10	L MP 27 - 28 EUR 42 - 43 UK 8 - 9 US 9 - 10	H	H 		
27 1/2						
28	XL MP 28 1/2 - 29 1/2 EUR 44 - 45 UK 10 - 11 US 11 - 12	XL MP 28.5-30 EUR 44-46 UK 10-12 US 11-13	I	I 		
28 1/2						
29						
29 1/2			J	J 		
30	XXL MP 29 1/2 - 31 EUR 46 - 48 UK 12 - 13 US 13 - 14	XXL MP 30.5 - 31.5 EUR 47 - 49 UK 12.5 - 13.5 US 13.5 - 14.5	K	K 		
30 1/2						
31					L 	
31 1/2						

DISTRIBUTORS



AUSTRALIA

Phoenix Leisure Group P/L
5 Aero Rd,
Ingleburn NSW 2565
Ph: 61 2 95526900
Fax: 61 2 95526922
info@plg.com.au

BENELUX

X-Function Benelux B.V
Jupiterstraat 2
NL-6468 EV Kerkrade
The Netherlands
Ph.: +31-45-2110888
sales@tck-sports.nl
www.tck-sports.nl

CANADA

LANCTÔT LTEE
5290 Boul. Thimens
Saint-Laurent, QC
H4R 2B2
Ph.: +1 514 7316841
Fax : +1 514 3424059
info@rlanctot.com
www.rlanctot.com

CHINA

P.R.China
X-Wing Distribution Ltd
Danny Jia
6-21, Commercial Logistics & Storage
Company Baizhuan, Chaoyang District
Beijing, 100124
Ph.: (+86)-15110033522
jia@xwing.cn

CZECH REPUBLIC / SLOVAKIA

SVORTO S.R.O.
Průběžná 30
100 00 PRAHA 10
Ph.: +42 0241740341
sidas@svorto.cz
www.sidas.cz

DENMARK

PIST TRADING
Blokken 67
3460 BIRKERØD
Ph.: +45 28448240
pn@sidas.dk
www.sidas.dk

FINLAND

SKÖNÄRI OY
Höyläämötie 12
00380 HELSINKI
Ph.: +358 400-70.68.27
snyffe@gmail.com

FRANCE / ANDORRE

SIDAS Sport France
18, rue Léon Béridot
BP 353 - ZAC Champfeuillet
38509 VOIRON CEDEX - France
Ph.: +33 (0)4 76 67 07 24/ 11/ 14
Fax: +33 (0)4 76 67 03 03
sidassportfrance@sidas.com

GERMANY/AUSTRIA

STC DISTRIBUTION GMBH
Triesterstrasse 179
8073 Feldkirchen bei Graz
AUSTRIA
Ph Germany : 0800 180 2373
Ph. Austria: +43 316 243 793 0
Fax: +43 316 243 793-10
sales@stc-sport.com

HONG KONG

Biomechanics Limited
BIOME
1305-6, 13/F Asia Standard Tower,
59-65 Queen Road Central,
Hong Kong
Tel: +852 3702 0853
contact@biomeasia.com
www.biomeasia.com

HUNGARY

FLEX 92 Kft.
Csata u. 8.
2040 Budaörs
Ph/Fax: +36 23 414 699
Mobile phone: +36309402253
flex92kft@t-online.hu

ITALIA

VICH ITALIA S.R.L
Via Borgo Palazzo 274
24125 BERGAMO
Ph.:+39 035 4596078
info@vichitalia.com
www.vichitalia.com

JAPAN

SIDAS JAPAN
Kannai Wise 7F
2-9-1 Furocho Naka-ku
Yokohama
231-0032 Japan
Ph.: +81 045 263 9559
Fax: +81 045 263 9558
info@sidas.co.jp
www.sidas.co.jp

NEW ZEALAND

BRANDEX LTD
204 Cumnor Terrace
WOOLSTON 8241,
CHRISTCHURCH
Ph.: +64 3 3812190
Fax: +64 3 3812191
hq@brandex.co.nz

UNITED STATES OF AMERICA

Sidas Technologies, NA Inc.
5628 Airport Way S. Suite 280
Seattle, WA 98108
PH: +1604732 9144
FAX: +1604270 1906
info-us@sidas.com

NORWAY

RAMO AS
Hvamsvingen 4
2013 Skjetten.
Norway
Ph:+47 67910200
Kundeservice@ramo.no

POLAND

WINDSPORT Sp. Jaw.
ul. Zakopianska 56a
30-418 Kraków
tel. +48 12 267 79 60
sidas@sidas.pl
www.sidas.pl

RUSSIA

SIDAS RUSSIA
105005 Moscow
Baumanskaya str, 7
PH.: +7 (495) 729 2406
info@sidas-russia.ru
www.sidas-russia.ru

SINGAPORE

Outdoor Venture Pte Ltd
17 Kaki Bukit Crescent
#04-02, Kaki Bukit Techpark 1
Singapore 416248
Ph: +65 6846 1227
info@outdoor-venture.com
www.outdoor-venture.com

SLOVENIA CROATIA / BIH

MATIAS 2 D.O.O.
Špelina ulica 1
2000 MARIBOR
Ph.: +386 (0)2 426 0126
FAX: +386 (0)2 461 2741
info@matias2.si
www.matias2.si

SOUTH KOREA

PJTUNE CO.LTD
135-815
9F Mediacerter 58-9
Nonhyeon 1-dong
Gangnamgu
SEOUL
Ph.: +82 22209 0250
Fax: +82 22209 0260
pjhjia@hotmail.com
www.pjtune.com

SPAIN / PORTUGAL

SIDAS SPAIN SL
Vallirana 30 bajos
08006 BARCELONA
PH.: +34 932 183 722
sidas@sidas.net
www.sidas.com

SWEDEN

SCANTRADE SCANDINAVIA AB
DALSTIGEN 6
SE-523 45 ULRICEHAMN
SWEDEN
Ph +46313350150
www.scantrade.se
info@scantrade.se

SWITZERLAND

SIDAS SUISSE SARL
C/o D4 Platz 3
6039 ROOT LÄNGENBOLD
Ph.: 0800 123 808
Fax: +43 316 243 793-10
suisse@sidas.com

TAIWAN

STARLIKE INTERNATIONAL LTD
8F, No.47, LANE 3 Jihu road,
Neihu District
11492 TAIPEI CITY
TAIWAN
Ph: +886 2 8751-5235

THAILAND

JOLI SNOB Co., Ltd.
15 Pattanavet 11, Sukhumvit 71,
Klongtun-nua,
Wattana, Bangkok,
Thailand 10110
Tel: (+66)2-711-7134 to 6
info@jolisnob.ne

UK

SIDAS UK LTD
Bridge House,
1 Bridge Street,
Kendal, LA9 7DD,
Tel + 44 15 39 72 58 17
FAX + 44 15 39 72 96 61
info@sidas.co.uk
www.sidas.co.uk

IRELAND

SIDAS UK LTD
Des McCarley
Tel + 44 77 40 95 87 07
Fax + 44 15 39 72 96 61
Des.McCarley@sidas.co.uk
www.sidas.co.uk

