

The background of the entire page is a high-contrast, black and white aerial photograph of a rugged coastline. The image shows dark, jagged rock formations meeting the sea, with white foam from breaking waves visible. The overall mood is dramatic and natural.

robern®

THE BEAUTY OF
THE UNEXPECTED

2020 U.S. PRICE BOOK GUIDE

Discontinued Product Summary

- Main Line Penn Valley® Mirrors
- Main Line Mirrors in White (79)
- Balletto® Vanities
- Balletto Side Storage Inserts
- Balletto Side Stop
- PL Series Arch Top Cabinets
- Main Line Penn Valley Cabinets
- Main Line Cabinets in White (79)
- Reflexion® Lighting
- Reflexion Ganging Kit

Customer Service – Quick Reference Guide

Call 800-877-2376 for:

- Design Specification Questions
- Installation Questions
- Placing an Order
- Order Status Check
- Warranty
- Replacement Parts
- Returns

You will be asked to choose a prompt based on where you live:

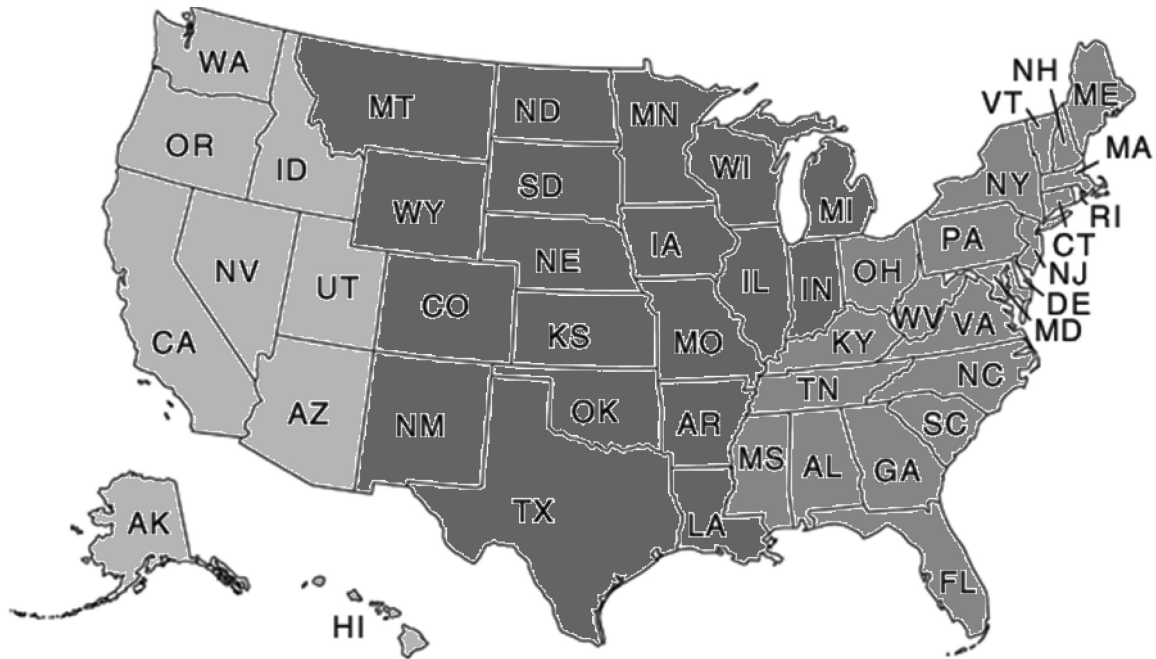

PRESS 3 includes Canada	PRESS 2	PRESS 1
-----------------------------------	----------------	----------------

If you are calling regarding a Commercial Specification project, PRESS 4.

If you prefer email, and are a HOMEOWNER OR CONTRACTOR contact us at: CustomerService@Robern.com.

If you prefer email, and are a SHOWROOM, DISTRIBUTOR OR DESIGNER/SPECIFIER contact us at:

RobernEast@Robern.com = East Region

RobernCentral@Robern.com = Central Region

RobernWest@Robern.com = West Region

RobernCanada@Robern.com = Canada Region

If you prefer email, and are interested in CUSTOM PROJECT SOLUTIONS (for commercial specification projects), contact us at: Custom@Robern.com.

Hours of Operation: Monday – Friday, 8am – 6pm EST

Robern® Quick Ship Program

- Robern Quick Ship Program is intended for use by Robern's dealers only.
- Robern Quick Ship orders must be placed on a separate P.O. Begin your Quick Ship P.O. with "QR" and/or clearly mark the order "Quick Ship".
- Maximum order value for Quick Ship order \$3000 net.
- Net order must exceed \$1500 to get freight pre-paid by Robern. If order does not exceed \$1500, shipping charges outlined on page 29 will apply.

- All Robern sales and shipping conditions stated on pages 29 – 30 of the 2020 price guide apply.
- Orders will ship within 72 hours of receipt of order.
- Quick Ship orders are non-cancelable.
- The models listed below are the only models available on the Quick Ship Program. These models are also marked throughout the book with a:



Model No.	Product	Page	Price
AiO₂ Cabinets/Mirrors			
AC2430D4P1L	24"W x 30"H Cabinet, LH, 4000K	51	\$ 2,049.
AC2430D4P1LW	24"W x 30"H Cabinet, LH, 2700K	51	\$ 2,049.
AC2430D4P1R	24"W x 30"H Cabinet, RH, 4000K	51	\$ 2,049.
AC2430D4P1RW	24"W x 30"H Cabinet, RH, 2700K	51	\$ 2,049.
AC2440D4P1L	24"W x 40"H Cabinet, LH, 4000K	51	\$ 2,579.
AC2440D4P1LW	24"W x 40"H Cabinet, LH, 2700K	51	\$ 2,579.
AC2440D4P1R	24"W x 40"H Cabinet, RH, 4000K	51	\$ 2,579.
AC2440D4P1RW	24"W x 40"H Cabinet, RH, 2700K	51	\$ 2,579.
AM2430RFP	24"W x 30"H Mirror, 4000K	166	\$ 1,479.
AM2430RFPW	24"W x 30"H Mirror, 2700K	166	\$ 1,479.
AM2440RFP	24"W x 40"H Mirror, 4000K	166	\$ 1,749.
AM2440RFPW	24"W x 40"H Mirror, 2700K	166	\$ 1,749.
M Series Cabinets/Components			
MC1230D4FPL	12"W x 30"H x 4"D, Polished, LH	82	\$ 849.
MC1230D4FPR	12"W x 30"H x 4"D, Polished, RH	82	\$ 849.
MC1230D4FPLE2	12"W x 30"H x 4"D, Pol, LH, Elec	82	\$ 1,279.
MC1230D4FPRE2	12"W x 30"H x 4"D, Pol, RH, Elec	82	\$ 1,279.
MC1240D4FPL	12"W x 40"H x 4"D, Polished, LH	90	\$ 1,179.
MC1240D4FPR	12"W x 40"H x 4"D, Polished, RH	90	\$ 1,179.
MC1240D4FPLE2	12"W x 40"H x 4"D, Pol, LH, Elec	90	\$ 1,629.
MC1240D4FPRE2	12"W x 40"H x 4"D, Pol, RH, Elec	90	\$ 1,629.
MC1630D4FPL	16"W x 30"H x 4"D, Polished, LH	84	\$ 949.
MC1630D4FPR	16"W x 30"H x 4"D, Polished, RH	84	\$ 949.
MC1630D4FPLE2	16"W x 30"H x 4"D, Pol, LH, Elec	84	\$ 1,429.
MC1630D4FPRE2	16"W x 30"H x 4"D, Pol, RH, Elec	84	\$ 1,429.
MC1630D4FPLE4	16"W x 30"H x 4"D, Pol, LH, Elec+	84	\$ 1,749.
MC1630D4FPRE4	16"W x 30"H x 4"D, Pol, RH, Elec+	84	\$ 1,749.
MC1640D4FPL	16"W x 40"H x 4"D, Polished, LH	92	\$ 1,279.
MC1640D4FPR	16"W x 40"H x 4"D, Polished, RH	92	\$ 1,279.
MC1640D4FPLE2	16"W x 40"H x 4"D, Pol, LH, Elec	92	\$ 1,749.
MC1640D4FPRE2	16"W x 40"H x 4"D, Pol, RH, Elec	92	\$ 1,749.
MC1640D4FPLE4	16"W x 40"H x 4"D, Pol, LH, Elec+	92	\$ 2,099.
MC1640D4FPRE4	16"W x 40"H x 4"D, Pol, RH, Elec+	92	\$ 2,099.
MC2030D4FPL	20"W x 30"H x 4"D, Polished, LH	86	\$ 1,129.
MC2030D4FPR	20"W x 30"H x 4"D, Polished, RH	86	\$ 1,129.
MC2030D4FPLE2	20"W x 30"H x 4"D, Pol, LH, Elec	86	\$ 1,579.
MC2030D4FPRE2	20"W x 30"H x 4"D, Pol, RH, Elec	86	\$ 1,579.
MC2030D4FPLE4	20"W x 30"H x 4"D, Pol, LH, Elec+	86	\$ 1,899.
MC2030D4FPRE4	20"W x 30"H x 4"D, Pol, RH, Elec+	86	\$ 1,899.
MC2040D4FPL	20"W x 40"H x 4"D, Polished, LH	94	\$ 1,429.
MC2040D4FPR	20"W x 40"H x 4"D, Polished, RH	94	\$ 1,429.
MC2040D4FPLE2	20"W x 40"H x 4"D, Pol, LH, Elec	94	\$ 1,849.
MC2040D4FPRE2	20"W x 40"H x 4"D, Pol, RH, Elec	94	\$ 1,849.
MC2040D4FPLE4	20"W x 40"H x 4"D, Pol, LH, Elec+	94	\$ 2,199.
MC2040D4FPRE4	20"W x 40"H x 4"D, Pol, RH, Elec+	94	\$ 2,199.

Model No.	Product	Page	Price
M Series Cabinets/Components (continued)			
MC2430D4FPL	24"W x 30"H x 4"D, Polished, LH	88	\$ 1,179.
MC2430D4FPR	24"W x 30"H x 4"D, Polished, RH	88	\$ 1,179.
MC2430D4FPLE2	24"W x 30"H x 4"D, Pol., LH, Elec	88	\$ 1,629.
MC2430D4FPRE2	24"W x 30"H x 4"D, Pol., RH, Elec	88	\$ 1,629.
MC2430D4FPLE4	24"W x 30"H x 4"D, Pol., LH, Elec+	88	\$ 1,979.
MC2430D4FPRE4	24"W x 30"H x 4"D, Pol., RH, Elec+	88	\$ 1,979.
MC2440D4FPL	24"W x 40"H x 4"D, Polished, LH	96	\$ 1,479.
MC2440D4FPR	24"W x 40"H x 4"D, Polished, RH	96	\$ 1,479.
MC2440D4FPLE2	24"W x 40"H x 4"D, Pol, LH, Elec	96	\$ 1,899.
MC2440D4FPRE2	24"W x 40"H x 4"D, Pol, RH, Elec	96	\$ 1,899.
MC2440D4FPLE4	24"W x 40"H x 4"D, Pol, LH, Elec+	96	\$ 2,279.
MC2440D4FPRE4	24"W x 40"H x 4"D, Pol, RH, Elec+	96	\$ 2,279.
M SMK30D4P	Surface-Mount Kit for 30"H x 4"D	280	\$ 149.
M SMK40D4P	Surface-Mount Kit for 40"H x 4"D	280	\$ 249.
MGKIT	30"/40" Cabinet Ganging Kit	279	\$ 49.
PL Series Cabinets/Components			
PLM1630G	16"W x 30"H, Polished, Gray	126	\$ 529.
PLM1630GLE	16"W x 30"H, Pol, LH, Elec, Gray	126	\$ 829.
PLM1630GRE	16"W x 30"H, Pol, RH, Elec, Gray	126	\$ 829.
PLM1630GB	16"W x 30"H, Bevel, Gray	126	\$ 529.
PLM1630GBLE	16"W x 30"H, Bev, LH, Elec, Gray	126	\$ 829.
PLM1630GBRE	16"W x 30"H, Bev, RH, Elec, Gray	126	\$ 829.
PLM1630W	16"W x 30"H, Polished, White	126	\$ 529.
PLM1630WLE	16"W x 30"H, Pol, LH, Elec, Wht	126	\$ 829.
PLM1630WRE	16"W x 30"H, Pol, RH, Elec, Wht	126	\$ 829.
PLM1630WB	16"W x 30"H, Bevel, White	126	\$ 529.
PLM1630WBLE	16"W x 30"H, Bev, LH, Elec, Wht	126	\$ 829.
PLM1630WBRE	16"W x 30"H, Bev, RH, Elec, Wht	126	\$ 829.
PLM1640G	16"W x 40"H, Polished, Gray	126	\$ 649.
PLM1640GLE	16"W x 40"H, Pol, LH, Elec, Gray	126	\$ 929.
PLM1640GRE	16"W x 40"H, Pol, RH, Elec, Gray	126	\$ 929.
PLM1640GB	16"W x 40"H, Bevel, Gray	126	\$ 649.
PLM1640GBLE	16"W x 40"H, Bev, LH, Elec, Gray	126	\$ 929.
PLM1640GBRE	16"W x 40"H, Bev, RH, Elec, Gray	126	\$ 929.
PLM1640W	16"W x 40"H, Polished, White	126	\$ 649.
PLM1640WLE	16"W x 40"H, Pol, LH, Elec, Wht	126	\$ 929.
PLM1640WRE	16"W x 40"H, Pol, RH, Elec, Wht	126	\$ 929.
PLM1640WB	16"W x 40"H, Bevel, White	126	\$ 649.
PLM1640WBLE	16"W x 40"H, Bev, LH, Elec, Wht	126	\$ 929.
PLM1640WBRE	16"W x 40"H, Bev, RH, Elec, Wht	126	\$ 929.
PLM2030G	20"W x 30"H, Polished, Gray	127	\$ 579.
PLM2030GLE	20"W x 30"H, Pol, LH, Elec, Gray	127	\$ 879.
PLM2030GRE	20"W x 30"H, Pol, RH, Elec, Gray	127	\$ 879.
PLM2030GB	20"W x 30"H, Bevel, Gray	127	\$ 579.
PLM2030GBLE	20"W x 30"H, Bev, LH, Elec, Gray	127	\$ 879.
PLM2030GBRE	20"W x 30"H, Bev, RH, Elec, Gray	127	\$ 879.

Refer to product page for complete description.

Continued on following page.

Terms and conditions of Quick Ship Program subject to change.

Robern® Quick Ship Program

- Robern Quick Ship Program is intended for use by Robern's dealers only.
- Robern Quick Ship orders must be placed on a separate P.O. Begin your Quick Ship P.O. with "QR" and/or clearly mark the order "Quick Ship".
- Maximum order value for Quick Ship order \$3000 net.
- Net order must exceed \$1500 to get freight pre-paid by Robern. If order does not exceed \$1500, shipping charges outlined on page 29 will apply.

- All Robern sales and shipping conditions stated on pages 29 – 30 of the 2020 price guide apply.
- Orders will ship within 72 hours of receipt of order.
- Quick Ship orders are non-cancelable.
- The models listed below are the only models available on the Quick Ship Program. These models are also marked throughout the book with a:



Model No.	Product	Page	Price
PL Series Cabinets/Components (continued)			
PLM2030W	20"W x 30"H, Polished, White	127	\$ 579.
PLM2030WLE	20"W x 30"H, Pol, LH, Elec, Wht	127	\$ 879.
PLM2030WRE	20"W x 30"H, Pol, RH, Elec, Wht	127	\$ 879.
PLM2030WB	20"W x 30"H, Bevel, White	127	\$ 579.
PLM2030WBLE	20"W x 30"H, Bev, LH, Elec, Wht	127	\$ 879.
PLM2030WBRE	20"W x 30"H, Bev, RH, Elec, Wht	127	\$ 879.
PLM2040G	20"W x 40"H, Polished, Gray	127	\$ 699.
PLM2040GLE	20"W x 40"H, Pol, LH, Elec, Gray	127	\$ 979.
PLM2040GRE	20"W x 40"H, Pol, RH, Elec, Gray	127	\$ 979.
PLM2040GB	20"W x 40"H, Bevel, Gray	127	\$ 699.
PLM2040GBLE	20"W x 40"H, Bev, LH, Elec, Gray	127	\$ 979.
PLM2040GBRE	20"W x 40"H, Bev, RH, Elec, Gray	127	\$ 979.
PLM2040W	20"W x 40"H, Polished, White	127	\$ 699.
PLM2040WLE	20"W x 40"H, Pol, LH, Elec, Wht	127	\$ 979.
PLM2040WRE	20"W x 40"H, Pol, RH, Elec, Wht	127	\$ 979.
PLM2040WB	20"W x 40"H, Bevel, White	127	\$ 699.
PLM2040WBLE	20"W x 40"H, Bev, LH, Elec, Wht	127	\$ 979.
PLM2040WBRE	20"W x 40"H, Bev, RH, Elec, Wht	127	\$ 979.
PLM2430G	24"W x 30"H, Polished, Gray	128	\$ 649.
PLM2430GLE	24"W x 30"H, Pol, LH, Elec, Gray	128	\$ 929.
PLM2430GRE	24"W x 30"H, Pol, RH, Elec, Gray	128	\$ 929.
PLM2430GB	24"W x 30"H, Bevel, Gray	128	\$ 649.
PLM2430GBLE	24"W x 30"H, Bev, LH, Elec, Gray	128	\$ 929.
PLM2430GBRE	24"W x 30"H, Bev, RH, Elec, Gray	128	\$ 929.
PLM2430W	24"W x 30"H, Polished, White	128	\$ 649.
PLM2430WLE	24"W x 30"H, Pol, LH, Elec, Wht	128	\$ 929.
PLM2430WRE	24"W x 30"H, Pol, RH, Elec, Wht	128	\$ 929.
PLM2430WB	24"W x 30"H, Bevel, White	128	\$ 649.
PLM2430WBLE	24"W x 30"H, Bev, LH, Elec, Wht	128	\$ 929.
PLM2430WBRE	24"W x 30"H, Bev, RH, Elec, Wht	128	\$ 929.
PLM2440G	24"W x 40"H, Polished, Gray	128	\$ 749.
PLM2440GLE	24"W x 40"H, Pol, LH, Elec, Gray	128	\$ 1,029.
PLM2440GRE	24"W x 40"H, Pol, RH, Elec, Gray	128	\$ 1,029.
PLM2440GB	24"W x 40"H, Bevel, Gray	128	\$ 749.
PLM2440GBLE	24"W x 40"H, Bev, LH, Elec, Gray	128	\$ 1,029.
PLM2440GBRE	24"W x 40"H, Bev, RH, Elec, Gray	128	\$ 1,029.
PLM2440W	24"W x 40"H, Polished, White	128	\$ 749.
PLM2440WLE	24"W x 40"H, Pol, LH, Elec, Wht	128	\$ 1,029.
PLM2440WRE	24"W x 40"H, Pol, RH, Elec, Wht	128	\$ 1,029.
PLM2440WB	24"W x 40"H, Bevel, White	128	\$ 749.
PLM2440WBLE	24"W x 40"H, Bev, LH, Elec, Wht	128	\$ 1,029.
PLM2440WBRE	24"W x 40"H, Bev, RH, Elec, Wht	128	\$ 1,029.
PLSMK30D4P	PL Surface-Mount Kit for 30"H x 4"D	281	\$ 149.
PLSMK40D4P	PL Surface-Mount Kit for 40"H x 4"D	281	\$ 249.
PLGKIT	PL Series Ganging Kit	279	\$ 49.

Model No.	Product	Page	Price
R³ Series Cabinets/Components			
RC1620D4FB1	16"W x 20"H, Bevel	132	\$ 279.
RC1620D4FP1	16"W x 20"H, Polished	132	\$ 279.
RC1626D4FB1	16"W x 26"H, Bevel	132	\$ 449.
RC1626D4FP1	16"W x 26"H, Polished	132	\$ 449.
RC1636D4FB1	16"W x 36"H, Bevel	132	\$ 549.
RC1636D4FP1	16"W x 36"H, Polished	132	\$ 549.
RC2026D4FB1	20"W x 26"H, Bevel	133	\$ 499.
RC2026D4FP1	20"W x 26"H, Polished	133	\$ 499.
RC2036D4FB1	20"W x 36"H, Bevel	133	\$ 679.
RC2036D4FP1	20"W x 36"H, Polished	133	\$ 679.
RC2426D4FB1	24"W x 26"H, Bevel	134	\$ 549.
RC2426D4FP1	24"W x 26"H, Polished	134	\$ 549.
RC2436D4FB1	24"W x 36"H, Bevel	134	\$ 779.
RC2436D4FP1	24"W x 36"H, Polished	134	\$ 779.
RSMK20D4P	R ³ Surface-Mount Kit for 20"H	281	\$ 149.
RSMK26D4P	R ³ Surface-Mount Kit for 26"H	281	\$ 149.
RSMK36D4P	R ³ Surface-Mounting for 36"H	281	\$ 149.
Lighting/Components			
DLFML76	Main Line Sconce, Chrome	156	\$ 729.
DLFML77	Main Line Sconce, Polished Nickel	156	\$ 729.
UFLPAL	Uplift [®] Pendant, Anodized Aluminum	155	\$ 729.
UFLPCL	Uplift Pendant, Polished Chrome	155	\$ 849.
UFLPBNL	Uplift Pendant, Brushed Nickel	155	\$ 849.
UFLPPNL	Uplift Pendant, Polished Nickel	155	\$ 849.
UFLWAL	Uplift Sconce, Anodized Aluminum	155	\$ 729.
UFLWCRL	Uplift Sconce, Polished Chrome	155	\$ 849.
UFLWBNL	Uplift Sconce, Brushed Nickel	155	\$ 849.
UFLWPNL	Uplift Sconce, Polished Nickel	155	\$ 849.
X219-1145	Uplift Bulb: 24W, 3000K, 2G11	155	\$ 99.
ML1.530VFSGCRDN	30"H ML1.5 Lights, Chrome	153	\$ 1,329.
ML1.530VFSGBNDN	30"H ML1.5 Lights, Brushed Nickel	153	\$ 1,329.
ML1.540VFSGCRDN	40"H ML1.5 Lights, Chrome	153	\$ 1,479.
ML1.540VFSGBNDN	40"H ML1.5 Lights, Brushed Nickel	153	\$ 1,479.
PL30GCH	30"H PL 1.5 Lights, Glass, Chrome	153	\$ 1,329.
PL30GWH	30"H PL 1.5 Lights, Glass, White	153	\$ 1,329.
PL30PCH	30"H PL 1.5 Lights, Acrylic, Chrome	153	\$ 1,049.
PL30PWH	30"H PL 1.5 Lights, Acrylic, White	153	\$ 1,049.
PL40GCH	40"H PL 1.5 Lights, Glass, Chrome	153	\$ 1,479.
PL40GWH	40"H PL 1.5 Lights, Glass, White	153	\$ 1,479.
PL40PCH	40"H PL 1.5 Lights, Acrylic, Chrome	153	\$ 1,179.
PL40PWH	40"H PL 1.5 Lights, Acrylic, White	153	\$ 1,179.
ML3.530ILSFMRD3	30"H 3.5 InLine Lights, 3000K	151	\$ 849.
ML3.530ILSFMRD4	30"H 3.5 InLine Lights, 4000K	151	\$ 849.
ML3.530ILSFMRDV	30"H 3.5 InLine Lights, Variable	151	\$ 999.
ML3.540ILSFMRD3	40"H 3.5 InLine Lights, 3000K	151	\$ 949.
ML3.540ILSFMRD4	40"H 3.5 InLine Lights, 4000K	151	\$ 949.
ML3.540ILSFMRDV	40"H 3.5 InLine Lights, Variable	151	\$ 1,149.
1.5GKIT	1.5 Series Light Ganging Kit	279	\$ 49.

Refer to product page for complete description.

Continued on following page.

Terms and conditions of Quick Ship Program subject to change.

Robern® Quick Ship Program

- Robern Quick Ship Program is intended for use by Robern's dealers only.
- Robern Quick Ship orders must be placed on a separate P.O. Begin your Quick Ship P.O. with "QR" and/or clearly mark the order "Quick Ship".
- Maximum order value for Quick Ship order \$3000 net.
- Net order must exceed \$1500 to get freight pre-paid by Robern. If order does not exceed \$1500, shipping charges outlined on page 29 will apply.

- All Robern sales and shipping conditions stated on pages 29 – 30 of the 2020 price guide apply.
- Orders will ship within 72 hours of receipt of order.
- Quick Ship orders are non-cancelable.
- The models listed below are the only models available on the Quick Ship Program. These models are also marked throughout the book with a:



Model No.	Product	Page	Price
Vitality® Lighted Mirrors			
YM0030CIFPD3	30" Diameter, Circle Inset, 2700K	176	\$ 899.
YM0030CIFPD4	30" Diameter, Circle Inset, 4000K	176	\$ 899.
YM0030CFPPD3	30" Diameter, Circle Perimeter, 2700K	176	\$ 849.
YM0040CIFPD3	40" Diameter, Circle Inset, 2700K	176	\$ 1,099.
YM0040CIFPD4	40" Diameter, Circle Inset, 4000K	176	\$ 1,099.
YM0040CFPPD3	40" Diameter, Circle Perimeter, 2700K	176	\$ 1,049.
YM2430RCFPD3	24"W x 30"H, Rect Column, 2700K	175	\$ 579.
YM2430RCFPD4	24"W x 30"H, Rect Column, 4000K	175	\$ 579.
YM2430RIFPD3	24"W x 30"H, Rect Inset, 2700K	176	\$ 799.
YM2430RIFPD4	24"W x 30"H, Rect Inset, 4000K	176	\$ 799.
YM2430RPFDP3	24"W x 30"H, Rect Perimeter, 2700K	175	\$ 749.
YM2430RPFDP3K	24"W x 30"H, Rect P, 2700K/Title 24	175	\$ 929.
YM2430RSFPD3	24"W x 30"H, Rect Edge Lit, 2700K	174	\$ 679.
YM2430RGFPD3	24"W x 30"H, Rect Glow, 2700K	174	\$ 679.
YM2440RCFPD3	24"W x 40"H, Rect Column, 2700K	175	\$ 629.
YM2440RCFPD4	24"W x 40"H, Rect Column, 4000K	175	\$ 629.
YM2440RIFPD3	24"W x 40"H, Rect Inset, 2700K	176	\$ 849.
YM2440RIFPD4	24"W x 40"H, Rect Inset, 4000K	176	\$ 849.
YM2440RPFDP3	24"W x 40"H, Rect Perimeter, 2700K	175	\$ 799.
YM2440RPFDP3K	24"W x 40"H, Rect P, 2700K/Title 24	175	\$ 979.
YM2440RSFPD3	24"W x 40"H, Rect Edge Lit, 2700K	174	\$ 729.
YM2440RGFPD3	24"W x 40"H, Rect Glow, 2700K	174	\$ 729.
YM3030RCFPD3	30"W x 30"H, Rect Column, 2700K	175	\$ 699.
YM3030RCFPD4	30"W x 30"H, Rect Column, 4000K	175	\$ 699.
YM3030RIFPD3	30"W x 30"H, Rect Inset, 2700K	176	\$ 899.
YM3030RIFPD4	30"W x 30"H, Rect Inset, 4000K	176	\$ 899.
YM3030RPFDP3	30"W x 30"H, Rect Perimeter, 2700K	175	\$ 849.
YM3040RCFPD3	30"W x 40"H, Rect Column, 2700K	175	\$ 749.
YM3040RCFPD4	30"W x 40"H, Rect Column, 4000K	175	\$ 749.
YM3040RIFPD3	30"W x 40"H, Rect Inset, 2700K	176	\$ 979.
YM3040RIFPD4	30"W x 40"H, Rect Inset, 4000K	176	\$ 979.
YM3040RPFDP3	30"W x 40"H, Rect Perimeter, 2700K	175	\$ 949.
YM3040RPFDP3K	30"W x 40"H, Rect P, 2700K/Title 24	175	\$ 1,099.
YM3040RSFPD3	30"W x 40"H, Rect Edge Lit, 2700K	174	\$ 849.
YM3040RGFPD3	30"W x 40"H, Rect Glow, 2700K	174	\$ 849.
YM3630RCFPD3	36"W x 30"H, Rect Column, 2700K	175	\$ 799.
YM3630RCFPD4	36"W x 30"H, Rect Column, 4000K	175	\$ 799.
YM3630RIFPD3	36"W x 30"H, Rect Inset, 2700K	176	\$ 1,049.
YM3630RIFPD4	36"W x 30"H, Rect Inset, 4000K	176	\$ 1,049.
YM3630RPFDP3	36"W x 30"H, Rect Perimeter, 2700K	175	\$ 979.
YM3640RCFPD3	36"W x 40"H, Rect Column, 2700K	175	\$ 849.
YM3640RCFPD4	36"W x 40"H, Rect Column, 4000K	175	\$ 849.
YM3640RIFPD3	36"W x 40"H, Rect Inset, 2700K	176	\$ 1,099.
YM3640RIFPD4	36"W x 40"H, Rect Inset, 4000K	176	\$ 1,099.
YM3640RPFDP3	36"W x 40"H, Rect Perimeter, 2700K	175	\$ 1,049.
YM3640RPFDP3K	36"W x 40"H, Rect P, 2700K/Title 24	175	\$ 1,199.
YM3640RSFPD3	36"W x 40"H, Rect Edge Lit, 2700K	174	\$ 979.
YM3640RGFPD3	36"W x 40"H, Rect Glow, 2700K	174	\$ 929.

Refer to product page for complete description.

Model No.	Product	Page	Price
Curated Cartesian® Vanities (5 – 7 Day Lead Time)			
24219100NB00001	24"W x 15"H x 21"D, White/Gray	194	\$ 3,149.
24219100TB00001	24"W x 15"H x 21"D, Wht/Gray, NL	194	\$ 3,499.
24219100NB00002	24"W x 30"H x 21"D, White/Gray	194	\$ 4,749.
24219100TB00002	24"W x 30"H x 21"D, Wht/Gray, NL	194	\$ 5,079.
30219100NB00001	30"W x 15"H x 21"D, Wht/Gray	196	\$ 3,829.
30219100TB00001	30"W x 15"H x 21"D, Wht/Gray, NL	196	\$ 4,229.
30219100NB00002	30"W x 30"H x 21"D, Wht/Gray	196	\$ 5,979.
30219100TB00002	30"W x 30"H x 21"D, Wht/Gray, NL	196	\$ 6,349.
36219100NB00001	36"W x 15"H x 21"D, Wht/Gray	198	\$ 4,499.
36219100TB00001	36"W x 15"H x 21"D, Wht/Gray, NL	198	\$ 4,979.
36219100NB00002	36"W x 30"H x 21"D, Wht/Gray	198	\$ 7,229.
36219100TB00002	36"W x 30"H x 21"D, Wht/Gray, NL	198	\$ 7,649.
Cabinet/Vanity Accessories			
CAMM	Compact Adj. Magnification Mirror	278	\$ 49.
ENTICE	Entice® Magnification Mirror	278	\$ 449.
ENTICEDOCK	Entice Magnification Mirror w/Dock	278	\$ 499.
POMM	Pull-Out Magnifying Mirror	278	\$ 249.
SOMM	Silver Swing-Out Magnifying Mirror	278	\$ 99.
SLB16D4	16"W Safety Lock Box	277	\$ 299.
SLB16D6	16"W Safety Lock Box	277	\$ 299.
SLB16D8	16"W Safety Lock Box	277	\$ 299.
SLB20D4	20"W Safety Lock Box	277	\$ 299.
SLB20D6	20"W Safety Lock Box	277	\$ 299.
SLB20D8	20"W Safety Lock Box	277	\$ 299.
SLB24D4	24"W Safety Lock Box	277	\$ 299.
SLB24D6	24"W Safety Lock Box	277	\$ 299.
SLB24D8	24"W Safety Lock Box	277	\$ 299.
GLASSBIN3.25	Glass Bin, Small	273	\$ 49.
GLASSBIN5.25	Glass Bin, Medium	273	\$ 49.
GLASSBIN8.5	Glass Bin, Large	273	\$ 49.
GLASSBIN6.38	Glass Bin, Divided Storage	273	\$ 49.
MA-TRAY2.5	Razor/Phone Holder Accessory Tray	278	\$ 29.
MA-TRAY3	3" Accessory Tray	278	\$ 29.
MA-TRAY5	5" Accessory Tray	278	\$ 29.
MHANDLEKIT	Chrome Handle	277	\$ 179.
MPUSHKIT	Push-to-Open Mechanism	277	\$ 99.
VAELECTRIC21	Vanity Electric Accessory, 21"D	273	\$ 479.
VAHAIRORG	Vanity Hair Styling Organizer	273	\$ 249.
VMGKITH1	Vanity Ganging Kit, 7-1/2"H	274	\$ 99.
VMGKITH2	Vanity Ganging Kit, 15"H	274	\$ 99.
VMGKITH3	Vanity Ganging Kit, 22-1/2"H	274	\$ 229.
VMGKITH4	Vanity Ganging Kit, 30"H	274	\$ 229.

Terms and conditions of Quick Ship Program subject to change.

Freight and Return Policy

Freight Policy

Quick Ship

- Expediting fee by zone:
Zone 1 - \$0 Zone 2 - \$35 Zone 3 - \$50

Distributors

- \$8000 net minimum order for freight paid by Robern
- Under \$8000 net minimum will incur a handling and freight charge as follows:
Zone 1 - \$600 Zone 2 - \$650 Zone 3 - \$700

Dealers

- \$1500 net minimum order for freight paid by Robern
- Under \$1500 net minimum will incur a freight charge as follows:
Zone 1 - \$95 Zone 2 - \$115 Zone 3 - \$135
- Under \$500 net minimum will incur a handling and freight charge as follows:
Zone 1 - \$60 Zone 2 - \$65 Zone 3 - \$70

Return Policy

Return Policy

- Prior written approval in the form of an RGA (**Return Goods Authorization**) must be obtained from the Robern Customer Delight Team
- Product must be available in the current price book and not be discontinued or available as limited quantities
- 90 days return window from invoice date
- Buyer will incur a 25% restocking fee
- All products must be returned freight paid by customer
- Product must be received within 14 days of RGA issue date
- Robern reserves the right to approve or deny all returns

Ineligible Product

- All Frames (Main Line mirrors and cabinets, Profiles[®] mirrors and cabinets and Sculpt[™] lighted mirrors)
- Vitality[®] Lighted Mirrors
- All Replacement Doors
- All Accessories
- Essentials Palette (Stock Colors), Classic Palette and Inspire Palette (Special Order Colors): Vanities, M Series Decorative Cabinets, Surface-Mount Kits and Side Kits
- Curated Cartesian[®]
- Engineered Stone Tops
- Previously installed or opened product
- All product marked for discontinuation**

Zones

- Zone 1: CT, DE, FL, GA, MA, MD, ME, NC, NH, NJ, NY, PA, RI, SC, VA, VT
- Zone 2: AL, AR, IA, IL, IN, KS, KY, LA, MI, MN, MS, MO, NE, OH, OK, SD, ND, TN, TX, WI, WV
- Zone 3: AZ, CA, CO, ID, MT, NM, NV, OR, UT, WA, WY

Overseas and Shipments Outside Contiguous United States

- All overseas shipments and shipments outside the contiguous United States will be rate quoted and the customer will pay actual freight costs.

How To Make A Return

Email a note requesting an RGA to your Customer Delight Team at Robern with the following:

- Model and serial number of the product
- Copy of the invoice to verify date and purchase price of the product

Email – reference page 25

Return product along with a copy of the RGA and RGA # written on the carton. Product must be received in original packaging. Once received at Robern, the product will be inspected and credit issued. The product must arrive at Robern in A-1 condition to receive credit.

Safe Arrival Policy

Robern takes every reasonable precaution against breakage or other damage in transit. It is the Buyer's responsibility to inspect products upon delivery for transit damage and/or shortage. If damage or shortage is detected, it should be duly noted on the bill of lading prior to signing for the merchandise. Buyer must then contact Robern to determine if the product can be repaired with replacement parts or returned to Robern in exchange for a new unit.

Please do not refuse delivery of damaged product.

Warranty/Terms and Conditions/Care and Cleaning

Limited Warranty, One-Year Term

Robern warrants to the original purchaser that it will, at its election, repair, replace, or make appropriate adjustment to products made by this company shown to have significant defects in material or workmanship which are reported to Robern in writing within one (1) year from the date of delivery. Robern is not responsible for installation costs.

The warranty time period for operating components including door hinges and opening devices to the original owner extends beyond the one-year term.

The warranty is void in the event the product is damaged in transit, or if damage or failure is caused by abuse, misuse, abnormal usage, faulty installation, damage in an accident, improper maintenance, or any repairs other than those authorized by Robern. At the expiration of the one-year warranty period, Robern shall be under no further obligation under any warranty, expressed or implied, including the implied warranty of merchantability.

Robern shall not be liable for any consequential damages arising out of or in connection with the use or performance of its products. Some states do not allow limitations on how long an implied warranty lasts or do not allow the exclusion or limitation of incidental or consequential damages, so the above limitation or exclusion may not apply to you.

Any liability against Robern under any implied warranty, including the warranty of merchantability, is expressly limited to the terms of this warranty.

Permission to return any merchandise under this warranty must be authorized by Robern and returned prepaid by the purchaser.

Claims under this warranty should be sent directly to your dealer.

Terms and Conditions

Conditions of Purchase

Robern products are built to order. Products shipped and received in accordance with customers accepted orders are non-refundable. Certain products are non-cancelable once orders are processed:

- Essentials Palette (Stock Colors), Classic Palette and Inspire Palette (Special Order Colors): Vanities, M Series Decorative Cabinets, Surface-Mount Kits and Side Kits
- Purchase orders cannot be adjusted after 48 hours

Payment Terms

- Payment Terms: Net 30 days.
- Free Freight Allowed on Dealer orders greater than \$1500 net.
- Free Freight Allowed on Distributor orders greater than \$8000 net.

Care and Cleaning

How to Clean:

Robern products are constructed of mirrored glass and aluminum. A 50/50 solution of water and isopropyl alcohol is recommended for cleaning the mirrors. Ammonia or vinegar-based cleaners can damage mirrors. A mild detergent may be used on the surfaces. Do not use abrasive cleansers on any part of the cabinet. Use only a soft damp cloth to clean. When cleaning, spray the cloth, not the cabinet, mirror or surrounding surfaces.

Warranty Request Form

Robern Customer Service

701 North Wilson Avenue
Bristol, PA 19007

Email: reference page 25
Phone: 800-877-2376

Registered Robern Dealers and Distributors may request service parts for damaged or defective product using this warranty request form.

- Forms received after 5PM (EST) will be processed on the following business day.
- Warranty parts generally ship within 7 days of order entry.
- Robern Customer Service will email an order confirmation when the order is entered.

We appreciate your business and apologize for any inconvenience this situation may have caused.

Dealer Information

Date: _____

Company Name: _____

Contact Name: _____

Phone Number: _____

Email: _____

Product Information

Please include as much information about the product as possible. Items with an asterisk (*) are required. If required information is missing, this form will be rejected and returned to the sender.

*Model Number: _____

*Robern's PO Number: _____

*Invoice Number: _____

*Description of missing or damaged part: _____

If item is shipping to an end consumer, serial number is required to process: _____

Ship-To Information

If the ship-to address for the warranty parts order is different than that of the original order, please provide the information below.

Complete Name: _____

Street Address: _____

City, State, Zip Code: _____

Contact Phone Number: _____

Contact Email Address: _____

Confirmation Information

Robern Customer Service will provide an order confirmation to the contact information listed below.

Email: _____

Cabinet Ganging Reference

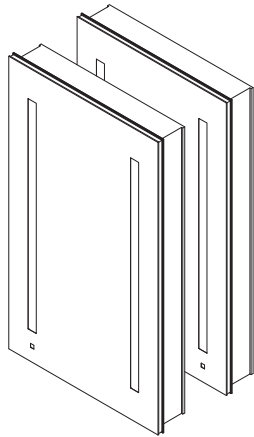

- (1) AC2440D4P1L
- (1) AC2440D4P1R

+

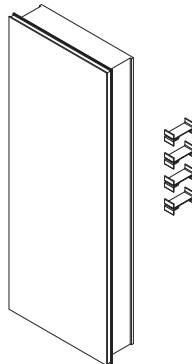

- (1) MC1640D4FPLE4
- (1) MGKIT

=

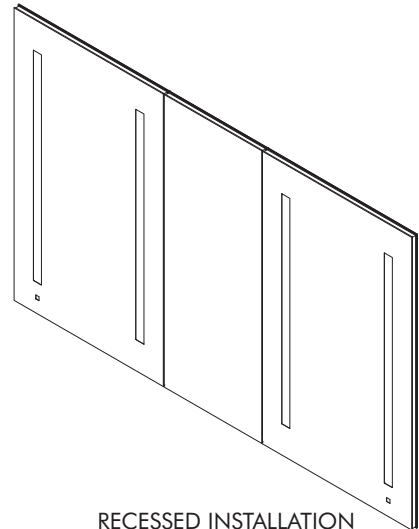

RECESSED INSTALLATION
61-3/4" x 39-3/8"

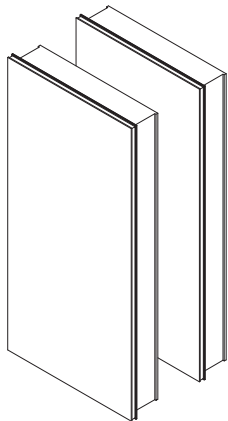

- (1) PLM2040GLE
- (1) PLM2040GRE

+

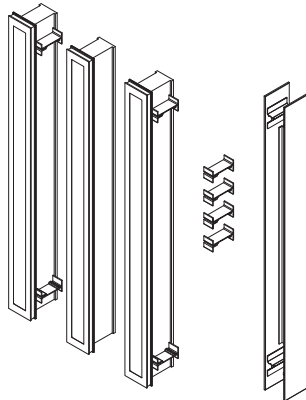

- (3) ML3.540ILSFRDV
- (1) MGKIT
- (1) PLSMK40D4P

=

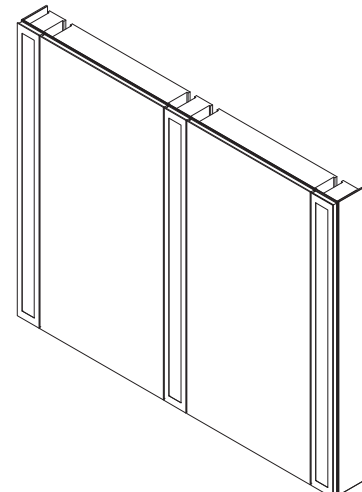

SURFACE-MOUNT INSTALLATION
49" x 39-3/8"

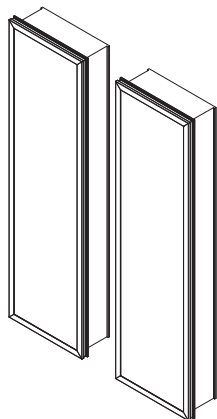

- (1) PC1240D4TLE76
- (1) PC1240D4TRE76

+

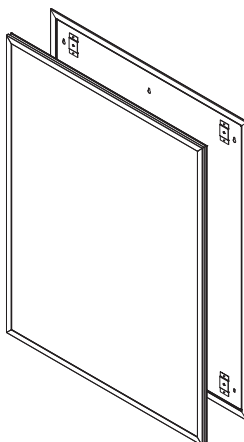

- (1) PM3040T76
- (1) PMGKIT3040

=

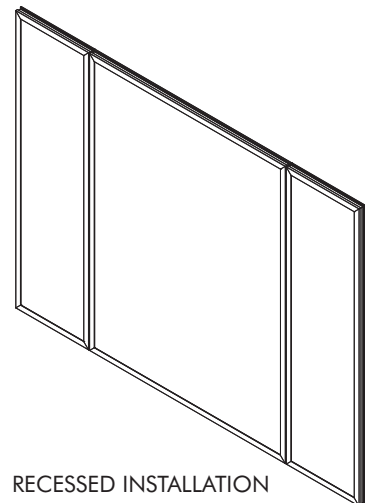

RECESSED INSTALLATION
52-1/2" x 39-3/8"

For more guidance on our modular solutions, visit robern.com/modularity.

Uplift® Tech Cabinets – Table of Contents, Tips & Features

Table of Contents

Uplift Tech Tips & Features	44 – 45
Uplift Tech Cabinets	46 – 47
Uplift Accessories and Options	48
Uplift Lighting	155

Tips & Features

Dimensions & Weight

- Width:
24" (610 mm)
30" (762 mm)
36" (914 mm)
48" (1219 mm)
- Height: 27" (686 mm)
- Depth: 6" (152 mm)
- Net Weight: 80 – 100 lbs

Features & Benefits

- Unique vertically opening, no-swing door allows for unobstructed installations
- Position-hold door-opening mechanism lets you open the door as low or as high as you need
- Aluminum handle for effortless two-finger lifting; upgrade to match or coordinate fixtures in your styling space with four popular metal frame finishes: Chrome, Polished Nickel, Matte Gold, Matte Black
- Lighted option provides warm, relaxing tones (2700K) that replicate indoor lighting
- Remarkably accurate color rendering with a CRI value of 90+ and R9 of 50+, so you can see your truest reflection
- Light direction and output eliminate dark shadows, provides bright, even task lighting and rich, saturated tone in your reflection
- Dimmable LED task lighting to 1% lets you select the ideal brightness for any task, using a standard dimmer that works with existing wiring
- The night light provides a soft light that illuminates to help locate items in the middle of the night. Programmable night light in 12-hour increments. Press the button to turn the night light on/off without affecting the programming

Features & Benefits (Continued)

- Defogging technology ensures a clear reflection. Turn on with a push of a button and built with a 45 minute timer. An LED indicator light lets you know that the defogger is turned on.
- Power when and where you need it most, the electric column features two USB charging ports and two 15A, 120VAC tamper resistant outlets (3 plugs), to provide power for items such as electric razors and curling irons
- Sensor controlled, low wattage interior LED light
- Consistent color throughout the cabinet with warm 2700K for task lighting, interior illumination and night light
- Cantilever Shelving: clean interior due to "hidden" shelf adjustments
- Dry space or wet space applications
- Able to do behind faucet installation due to vertical opening of cabinet
- Task lighting can be operated using standard Triac/Phase-cut residential dimmers and defogger and night light can be hardwired or operated using standard switches, available separately through electrical supply and home improvements centers
- Energy efficient LEDs with an estimated life of 53,000 hours
- Meets ADA requirements for door opening force for sliding doors
- Installed as a single unit or ganged together for a multiple cabinet installation
- Constructed to operate in high humidity or damp spaces. ETL/UL Certified for damp locations to UL 962, CSA Standard C22.2, No. 250.0



Tips & Features (Continued)

Configurable Options

- Styles: No Lighting, Perimeter Lighting
- Electrical Packages: Non-Electric, Electric or Electric, Night Light and Defogger
- Handle Options: Anodized Aluminum, Chrome, Polished Nickel, Matte Gold, Matte Black

Construction

- Durable rust-free anodized aluminum and glass construction – resists intense moisture, ensuring long-lasting beauty
- Satin anodized aluminum body
- Interior mirror
- 2249 cubic inches (36,847 cc) storage capacity for a 30" cabinet with split compartment for maximum flexibility
- 1/4" (6 mm) thick adjustable clear glass shelves; adjustable shelving at 1" (25 mm) increments: 6 shelves (24" W will include 3 shelves)
- Salt Spray Testing: ASTM Standard for 300 hours performed to test mirror quality against desilvering and degradation resulting from environmental exposure
- Cast Testing: copper test (simulate whole life of product) – accelerated age testing

Installation

- This installation may require more than one person
- Recessed, semi-recessed or surface-mount installation
- Cabinets include hardware for recessed installation. Surface-mount and semi-recess installations require the purchase of a kit which includes the side kit as well as mounting hardware.
- Recessed (frame and handle project 1-7/16" [37 mm]), semi-recessed 4" (102 mm) in wall (cabinet, frame and handle project 3-1/8" [79 mm]), or surface mount (cabinet, frame and handle project 7-1/8" [181 mm])
- Aluminum top and bottom kit for surface mount installations is required when top or bottom is visible
- Task Lighting/Dimmer recommendation: C•L® Dimmers or Caseta Wireless from LUTRON®.
- For on/off (no dimmer) operation, a standard wall switch may be substituted in place of the dimmer
- Need 22-1/4" ceiling clearance when installing; fully open cabinet is 31-3/4" high
- Improved serviceability: troubleshooting and repairs can be performed while the unit is installed

Accessories

- Handle Upgrades: (UHANDLE__)
- Side Kits:
Surface-Mount (USMK27D6P),
Semi-Recessed (USMK27D6SRP)
- Top and Bottom Kits:
Surface-Mount (UTK24D6A, UTK30D6A, UTK36D6A, UTK48D6A),
Semi-Recessed (UTK24D6ASR, UTK30D6ASR, UTK36D6ASR, UTK48D6ASR)
- Glass Bins
(GLASSBIN3.25, GLASSBIN5.25, GLASSBIN8.5)
- Ganging Kit (UGKIT)



Uplift® Tech Cabinets – 24" & 30" Wide



With its vertical design, Uplift revolutionized the way in which we experience medicine cabinets. Uplift Tech enhances the innovative features of the classic Uplift cabinet with the state-of-the-art technology, superior task lighting, and luxurious finishes to create a cutting-edge storage solution that is seamlessly functional and beautifully versatile.

- Includes a lighted option, which features a perimeter border of light projecting high-efficiency illumination
- Redesigned handle features slimmer proportions and curved edges for a sleek shape available in Chrome, Polished Nickel, Matte Gold and Matte Black
- State-of-the-art technological features and functions, including two USB ports, seamless interior illumination, fine-tuned defogging, several electrical outlets, and a programmable night light integrated into the handle's design
- Available in a non-electric 24-inch version to accommodate smaller, urban spaces



Two Week
Lead Time



Modular



Defogger



Electrical
Outlet



Dimmable
LED



Interior
Lighting





Night
Light

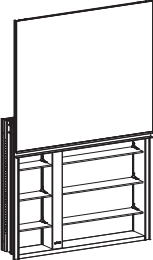
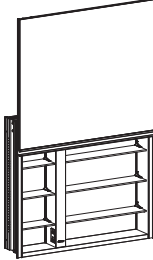

USB
Charging

Uplift Tech Cabinets

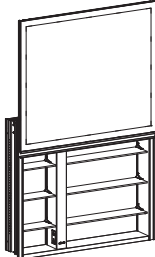
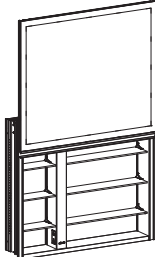
	Description	Model	Price
24" W x 27" H (RO: 23" W x 26-1/4" H x 6" D)			
	Flat, Polished Edge – No Lighting Non-Electric	UC24276FPNE0N	\$ 2,049.
30" W x 27" H (RO: 29" W x 26-1/4" H x 6" D)			
	Flat, Polished Edge – No Lighting Non-Electric	UC30276FPNE0N	\$ 2,379.
	Flat, Polished Edge – No Lighting With Electric	UC30276FPNE2N	\$ 2,679.
	Flat, Polished Edge – No Lighting With Electric, Night Light and Defogger	UC30276FPNE4N	\$ 3,199.
	Rectangle – Perimeter Lighting With Electric	UC30276RP3E2N	\$ 3,199.
	Rectangle – Perimeter Lighting With Electric, Night Light and Defogger	UC30276RP3E4N	\$ 3,699.

See Uplift Tech Accessories and Options on page 48.

Uplift® Tech Cabinets – 36" & 48" Wide



With its vertical design, Uplift revolutionized the way in which we experience medicine cabinets. Uplift Tech enhances the innovative features of the classic Uplift cabinet with the state-of-the-art technology, superior task lighting, and luxurious finishes to create a cutting-edge storage solution that is seamlessly functional and beautifully versatile.

- Includes a lighted option, which features a perimeter border of light projecting high-efficiency illumination
- Redesigned handle features slimmer proportions and curved edges for a sleek shape available in Chrome, Polished Nickel, Matte Gold and Matte Black
- State-of-the-art technological features and functions, including two USB ports, seamless interior illumination, fine-tuned defogging, several electrical outlets, and a programmable night light integrated into the handle's design
- Available in a non-electric 24-inch version to accommodate smaller, urban spaces



Uplift Tech Cabinets

	Description	Model	Price
36" W x 27" H (RO: 35" W x 26-1/4" H x 6" D)			
	Flat, Polished Edge – No Lighting With Electric	UC36276FPNE2N	\$ 3,199.
	Flat, Polished Edge – No Lighting With Electric, Night Light and Defogger	UC36276FPNE4N	\$ 3,699.
	Rectangle – Perimeter Lighting With Electric	UC36276RP3E2N	\$ 3,699.
	Rectangle – Perimeter Lighting With Electric, Night Light and Defogger	UC36276RP3E4N	\$ 4,229.
48" W x 27" H (RO: 47" W x 26-1/4" H x 6" D)			
	Flat, Polished Edge – No Lighting With Electric	UC48276FPNE2N	\$ 3,849.
	Flat, Polished Edge – No Lighting With Electric, Night Light and Defogger	UC48276FPNE4N	\$ 4,379.
	Rectangle – Perimeter Lighting With Electric	UC48276RP3E2N	\$ 4,379.
	Rectangle – Perimeter Lighting With Electric, Night Light and Defogger	UC48276RP3E4N	\$ 4,899.

See Uplift Tech Accessories and Options on page 48.

Uplift® Tech Cabinet Accessories & Options

Add-On Accessories & Options

Description	Model	Price
Uplift Tech – Handle Upgrades (Standard in Anodized Aluminum)		
For 24" W Cabinet – Chrome	UHANDLE2476	\$ 349.
For 24" W Cabinet – Polished Nickel	UHANDLE2477	\$ 349.
For 24" W Cabinet – Matte Gold	UHANDLE2482	\$ 379.
For 24" W Cabinet – Matte Black	UHANDLE2483	\$ 379.
For 30" W Cabinet – Chrome	UHANDLE3076	\$ 399.
For 30" W Cabinet – Polished Nickel	UHANDLE3077	\$ 399.
For 30" W Cabinet – Matte Gold	UHANDLE3082	\$ 429.
For 30" W Cabinet – Matte Black	UHANDLE3083	\$ 429.
For 36" W Cabinet – Chrome	UHANDLE3676	\$ 449.
For 36" W Cabinet – Polished Nickel	UHANDLE3677	\$ 449.
For 36" W Cabinet – Matte Gold	UHANDLE3682	\$ 479.
For 36" W Cabinet – Matte Black	UHANDLE3683	\$ 479.
For 48" W Cabinet – Chrome	UHANDLE4876	\$ 499.
For 48" W Cabinet – Polished Nickel	UHANDLE4877	\$ 499.
For 48" W Cabinet – Matte Gold	UHANDLE4882	\$ 529.
For 48" W Cabinet – Matte Black	UHANDLE4883	\$ 529.

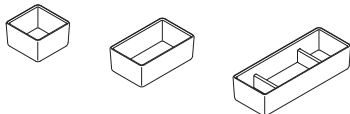
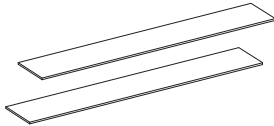
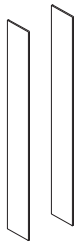

Side Kits for Uplift Tech Cabinets (Quantity 1 = Pair) Required for surface-mount or semi-recessed application		
Surface-Mount – Polished Edge Mirror	USMK27D6P	\$ 179.
Semi-Recessed – Polished Edge Mirror	USMK27D6SRP	\$ 179.

Top and Bottom Kits for Uplift Tech Cabinets Required when top or bottom is visible		
Surface-Mount, 24" W	UTK24D6A	\$ 249.
Semi-Recessed, 24" W	UTK24D6ASR	\$ 249.
Surface-Mount, 30" W	UTK30D6A	\$ 249.
Semi-Recessed, 30" W	UTK30D6ASR	\$ 249.
Surface-Mount, 36" W	UTK36D6A	\$ 249.
Semi-Recessed, 36" W	UTK36D6ASR	\$ 249.
Surface-Mount, 48" W	UTK48D6A	\$ 249.
Semi-Recessed, 48" W	UTK48D6ASR	\$ 249.

Accessory Glass Bins		
Small, 3-1/4" W x 3-1/4" L	GLASSBIN3.25	\$ 49.
Medium, 3-1/4" W x 5-1/4" L	GLASSBIN5.25	\$ 49.
Large, 3-1/4" W x 8-1/2" L	GLASSBIN8.5	\$ 49.

Uplift Tech Ganging Kit	UGKIT	\$ 179.
Required when pairing Uplift Tech cabinets		

See Uplift Lighting on pages 154 – 155.

SEE PAGES 44 – 45 FOR TIPS AND FEATURES.

Table of Contents

AiO Cabinets Tips & Features	49 – 50
30" High Cabinets	51
24" Wide Single Door	51
30" Wide Two Door	51
36" Wide Two Door	51
40" High Cabinets	51
24" Wide Single Door	51
30" Wide Two Door	51
36" Wide Two Door	51
AiO Lighted Mirrors	165 – 166
Cabinet Accessories	276 – 281
Cabinet Ganging Reference	43

Tips & Features

Dimensions & Weight

- Width:
23-1/4" (591 mm)
29-1/4" (743 mm)
35-1/4" (895 mm)
- Height:
30" (762 mm)
39-3/8" (1000 mm)
- Depth: 4-5/8" (117 mm)
- Net Weight: 41 – 70 lbs

Features & Benefits

- OM[®] Audio: built-in speakers with a range up to 30 feet with a 2 channel stereo at 20 watts/channel. Bluetooth connectivity supports most Android and iOS devices. Volume controlled by device.
- LUM[®] Lighting: Integrated dimmable LED lights and one-touch lighting control with capacitive-touch switch built into the mirror
- Choose between warm, relaxing tones (2700K) that replicate indoor lighting or cool, invigorating tones (4000K), which simulate bright daylight
- Remarkably accurate color rendering at 90+ CRI, so you can see your truest reflection
- Light direction and output eliminate dark shadows, provides bright even task lighting and rich, saturated tone in your reflection

Features & Benefits (Continued)

- Dimmable LED task lighting lets you select the ideal brightness for any task
- Can be paired with all M Series mirrored and decorative glass side kits
- Interior illumination with LED lighting built into the cabinet door
- Includes magnetic tool holder for small tools like tweezers and scissors
- Includes two USB charging ports and two 15A, 120VAC outlets (2 plugs) for single door and four 120VAC outlets (4 plugs) for two door
- Includes Compact Adjustable Magnifying Mirror (CAMM) with 5x magnification that sits on the magnetic strip in your cabinet or along the inside of the door so you can see yourself close up
- Constructed to operate in high humidity or damp spaces. ETL/UL Certified for damp locations to UL 962, CSA Standard C22.2 No. 68

Configurable Options

- Door Style: single door or two door
- Audio: OM audio or non-audio version
- Color Temperature: 2700K or 4000K
- Hinge Side: left or right



Tips & Features (Continued)

Construction

- Durable rust-free anodized aluminum and glass construction – resists intense moisture, ensuring long-lasting beauty
- Satin anodized aluminum body
- Quiet close Safeseal™ Gasket with sealed corners on cabinet body
- 3 mirror design – rear of cabinet and both sides of door
- Concealed finger pull-door edge
- Door opening angle 170 degrees (110 with provided stop): Blum self-closing hinges
- Adjustable shelving at 2" (51 mm) increments: 3 shelves for 30" H, 4 shelves for 40" H
- 1/4" (6 mm) thick adjustable clear glass shelves
- Magnetic area in the rail with cabinet to house magnetic tool holder

Installation

- This installation may require more than one person
- Install as a single unit or gang together for a multiple cabinet installation
- Recessed or surface-mount installation
- Cabinets include hardware for recessed installation. Surface-mount installations require the purchase of a surface-mount kit which includes the side kit as well as mounting hardware.
- Recessed cabinets project 7/8" from wall and must be recessed no less than 3-3/4" deep
- Single field wire into electrical shelf – front access serviceability
- MGKIT includes hardware to gang both sides of a cabinet. As a result, three cabinets can be ganged together from one MGKIT.

Accessories

- Safety Lock Box (SLB24D4), 24" W cabinet only
- Entice[®] Magnification Mirror (ENTICE, ENTICEDOCK)
- Compact Adjustable Magnification Mirror (CAMM)
- Swing-Out Magnifying Mirror (SOMM)
- Pull-Out Magnifying Mirror (POMM) – 24" W only
- Handle Kits (MHANDLEKIT, MPUSHKIT)
- Glass Bins (GLASSBIN3.25, GLASSBIN5.25, GLASSBIN8.5)
- Razor/Phone Holder (MA-TRAY2.5)
- 3" and 5" Accessory Tray (MA-TRAY3, MA-TRAY5)
- Surface-Mount Kits (MSMK30D__, MSMK40D__)
- Ganging Kit (MGKIT)

Lighting Specs

Kelvin	2700K 4000K
CRI	90+
Lumens ¹	750
Lux ^{1, 2}	410
R9 Value ¹	50+
Foot-candles ^{1, 2}	38

¹ Measured on a 24" W x 30" H model

² Measured at 18" from center of the mirror

Efficacy (LED Source)

Watts per Foot	8.8
Lumens per Foot	610
Lumens per Watt	69



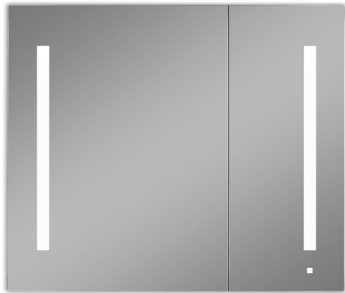

Meet the cabinet with everything. A combination of innovation and convenience, AiO cabinets provide a solution for all your styling needs. Use Bluetooth® connectivity to listen to your favorite music, control task lighting with a dimmer, charge your mobile devices with integrated USB ports and more.

- LUM® Lighting Technology includes an integrated LED light, engine and dimmer, and capacitive-touch dimming switch
- OM® Audio Technology transforms your mirror into an audio system, generating sound into the entire space with high fidelity Bluetooth connectivity
- Choose between warm (2700K) and cool (4000K) lighting tones



Two Week Lead Time



Modular



Dimmable LED



USB Charging



Electrical Outlet



Interior Lighting



Magnetic



Magnifying Mirror



Audio/Bluetooth®

AiO 30" H and 40" H Cabinets

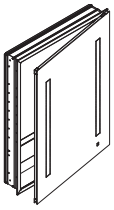
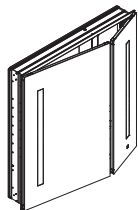
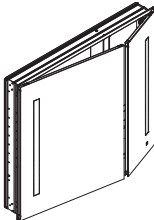
Description	2700K	4000K	Price	2700K With Audio	4000K With Audio	Price
Single Door, Polished Edge – 24" W: 23-1/4" W x 30" H x 4" D (RO: 22-1/2" W x 29-1/4" H x 4" D)						
 Left Hinge	AC2430D4P1LW	AC2430D4P1L	\$ 2,049.	AC2430D4P1LAW	AC2430D4P1LA	\$ 2,629.
Right Hinge	AC2430D4P1RW	AC2430D4P1R	\$ 2,049.	AC2430D4P1RAW	AC2430D4P1RA	\$ 2,629.
Single Door, Polished Edge – 24" W: 23-1/4" W x 39-3/8" H x 4" D (RO: 22-1/2" W x 38-5/8" H x 4" D)						
Left Hinge	AC2440D4P1LW	AC2440D4P1L	\$ 2,579.	AC2440D4P1LAW	AC2440D4P1LA	\$ 3,149.
Right Hinge	AC2440D4P1RW	AC2440D4P1R	\$ 2,579.	AC2440D4P1RAW	AC2440D4P1RA	\$ 3,149.
Two Door, Polished Edge – 30" W: 29-1/4" W x 30" H x 4" D (RO: 28-1/2" W x 29-1/4" H x 4" D)						
 Large Door at Left	AC3030D4P2LW	AC3030D4P2L	\$ 2,479.	AC3030D4P2LAW	AC3030D4P2LA	\$ 3,029.
Two Door, Polished Edge – 30" W: 29-1/4" W x 39-3/8" H x 4" D (RO: 28-1/2" W x 38-5/8" H x 4" D)						
Large Door at Left	AC3040D4P2LW	AC3040D4P2L	\$ 2,929.	AC3040D4P2LAW	AC3040D4P2LA	\$ 3,499.
Two Door, Polished Edge – 36" W: 35-1/4" W x 30" H x 4" D (RO: 34-1/2" W x 29-1/4" H x 4" D)						
 Large Door at Left	AC3630D4P2LW	AC3630D4P2L	\$ 2,799.	AC3630D4P2LAW	AC3630D4P2LA	\$ 3,349.
Two Door, Polished Edge – 36" W: 35-1/4" W x 39-3/8" H x 4" D (RO: 34-1/2" W x 38-5/8" H x 4" D)						
Large Door at Left	AC3640D4P2LW	AC3640D4P2L	\$ 3,249.	AC3640D4P2LAW	AC3640D4P2LA	\$ 3,829.

 **Note:** Models in **bold** indicate Quick Ship product.

See AiO Accessories and Options on the following page.

AiO® Cabinet Accessories & Options

Surface-Mount Kits (sold separately)



Description	Model	Mirror	Essentials Palette	Classic Palette	Inspire Palette
For 30" H Cabinets – Quantity 1 = Pair of Side Kits and Mounting Hardware					
D4 Surface-Mount, Polished Edge	MSMK30D4P	\$ 149.	N/A	N/A	N/A
D4 Surface-Mount, Decorative*	MSMK30D4 __	N/A	\$ 199.	\$ 249.	\$ 349.
For 40" H Cabinets – Quantity 1 = Pair of Side Kits and Mounting Hardware					
D4 Surface-Mount, Polished Edge	MSMK40D4P	\$ 249.	N/A	N/A	N/A
D4 Surface-Mount, Decorative*	MSMK40D4 __	N/A	\$ 349.	\$ 399.	\$ 449.

See Bottom Kits on page 281.

Color Options

* Fill in __ designator to Model listed above with desired color. Example: **MSMK40D420**.

Essentials Palette

11	Tinted Gray Mirror
20	Black
21	White

Classic Palette

22	Beach
26	Matte White
27	Matte Gray
28	Matte Black

Inspire Palette

12	Satin Bronze	24	Smoke Screen
19	Satin White	25	Silver Screen
23	Ocean		

Add-On Accessories & Options

Description	Model	Price
Magnifying Mirrors		
Entice® magnification mirror	ENTICE	\$ 449.
Entice magnification mirror with inductive charging dock	ENTICEDOCK	\$ 499.
Compact adjustable magnification mirror	CAMM	\$ 49.
Refer to page 278 for SOMM Magnifying Mirror.		
Safety Lock Box		
Full compartment keyed lock box in an anodized aluminum finish, for use with 24" W cabinet only	SLB24D4	\$ 299.
Handle Kits		
Chrome Handle	MHANDLEKIT	\$ 179.
or		
Push-to-Open Mechanism	MPUSHKIT	\$ 99.
Accessory Glass Bins		
Small, 3-1/4" W x 3-1/4" L	GLASSBIN3.25	\$ 49.
Medium, 3-1/4" W x 5-1/4" L	GLASSBIN5.25	\$ 49.
Large, 3-1/4" W x 8-1/2" L	GLASSBIN8.5	\$ 49.
Accessory Trays		
Razor/Phone Holder	MA-TRAY2.5	\$ 29.
3" Accessory Tray	MA-TRAY3	\$ 29.
5" Accessory Tray	MA-TRAY5	\$ 29.
Ganging Kit (30"/40" H)		
Hardware required for installing 2 or 3 cabinets side-by-side	MGKIT	\$ 49.

See AiO Wall Mirrors on pages 165 – 166.

Note: Models in **bold** indicate Quick Ship product.

SEE PAGES 49 – 50 FOR TIPS AND FEATURES.

Profiles® Framed Cabinets – Table of Contents

Profiles Ganging Reference	202
Profiles Framed Cabinet Tips & Features	58
Profiles Framed Cabinet Worksheet	59
30" High Cabinets	60 – 67
12" Wide	60 – 61
16" Wide	62 – 63
20" Wide	64 – 65
24" Wide	66 – 67
40" High Cabinets	68 – 75
12" Wide	68 – 69
16" Wide	70 – 71
20" Wide	72 – 73
24" Wide	74 – 75
48" High Cabinets – 16", 20" & 24" W	76 – 77
Profiles Lighting Options	146 – 149
Profiles Framed Mirrors	170 – 171
Cabinet Accessories	276 – 281



Profiles® Framed Cabinets – Tips & Features

Dimensions & Weight

- Width:
11-1/4" (286 mm) – not available for 48" H
15-1/4" (387 mm)
19-1/4" (489 mm)
23-1/4" (591 mm)
- Height:
30" (762 mm)
39-3/8" (1000 mm)
48" (1219 mm)
- Depth:
4" (102 mm)
6" (152 mm) – not available for 48" H;
4-11/16" (119 mm) surface-mount;
15/16" (24 mm) when recessed
- Net Weight: 17 – 50 lbs

Features & Benefits

- Match all fixtures in your styling space with Profiles metal frame finishes for a coordinated look: Chrome, Polished Nickel, Matte Gold, Matte Black
- Modular cabinets can be ganged with Profiles Lighting and Profiles Mirrors with optional ganging kit
- Electric option includes two USB charging ports and one 15A, 120VAC outlets (2 plugs)
- Includes magnetic tool holder (except 12" W electric options)
- Pair with Profiles Mirror when storage is not needed and Profiles Lighting to create task lighting in your styling space
- Create a coordinated ensemble by pairing with Profiles Lighting, Profiles Mirrors and Profiles Vanities
- Constructed to operate in high humidity or damp spaces. ETL/UL Certified for damp locations to UL 962, CSA Standard C22.2 No. 68

Configurable Options

- Metal Frame Finishes:
Chrome, Polished Nickel, Matte Gold, Matte Black
- Electrical Packages: none, electric
- Hinge Options: non-handed, left or right hinge

Construction

- Durable rust-free anodized aluminum and glass construction – resists intense moisture, ensuring long-lasting beauty
- Satin anodized aluminum body
- Quiet close Safeseal™ Gasket with sealed corners on cabinet body
- 3 mirror design – on back of door and inside of cabinet

Construction (Continued)

- Concealed finger pull-door edge
- Door opening angle 170 degrees (110 with provided stop): Blum self-closing hinges
- Adjustable shelving at 2" (51 mm) increments: 3 shelves for 30" H, 4 shelves for 40" H
- 1/4" (6 mm) thick adjustable clear glass shelves
- Magnetic area in the rail with cabinet to house magnetic tool holder

Installation

- This installation may require more than one person
- Install as a single unit or gang together for a multiple cabinet installation
- Recessed, semi-recessed or surface-mount installation (6" deep cabinets can be semi-recessed by 4")
- Cabinets include hardware for recessed installation. Surface-mount and semi-recess installations require the purchase of a kit which includes the side kit as well as mounting hardware.
- Recessed cabinets project 15/16" from wall and must be recessed no less than 3-3/4" deep
- For ganging with Profiles Lighting or Profiles Mirrors, a ganging kit is needed to ensure flush alignment.
- Optional MGKIT includes hardware to gang both sides of a cabinet. As a result, three cabinets or two cabinets and three lights can be ganged together from one MGKIT.

Accessories

- Safety Lock Box (SLB-*) – not for use with 12" W cabinets
- Pull-Out Magnifying Mirror (POMM)
- Swing-Out Magnifying Mirror (SOMM)
- Push-to-Open Kit (MPUSHKIT)
- Glass Bins (GLASSBIN3.25, GLASSBIN5.25, GLASSBIN8.5)
- Razor/Phone Holder (MA-TRAY2.5)
- 3" and 5" Accessory Tray (MA-TRAY3, MA-TRAY5)
- Surface-Mount Kits (MSMK30D_, MSMK40D_, MSMK48DP)
- Ganging Kit (MGKIT) – for ganging with lighting and other cabinets
- Ganging Kit (PMGKIT___) – for ganging with Profiles Mirrors
- Stacking Filler System (MSF-*)



Profiles® Framed Cabinet Worksheet

FEATURES

Select Width:

12"*

16"

20"

24"

Select Height:

30"

40"

48"*

Select Depth:

4"

6"*

Frame Width = 3/4"

Hinge Side:

Left

Right

Non-Handed (Left or Right Hinge)

Electric Option:

Electric

Non-Electric

Select Metal Frame Finish:

Chrome

Polished Nickel

Matte Gold

Matte Black

MODEL

PC

T

12

16

20

24

30

40

48

D4

D6

T

L

R

N

E

N

76

77

82

83

Notes:

Profiles Cabinets have a 2 week lead time.

* 12" W and 6" D cabinet available in 30" or 40" height, 48" H not available in D6.

CUSTOMER INFORMATION

Name

Address

City/State/Zip

Telephone

Date Ordered

Light Selection

Surface-Mount Side Kit Model (if applicable)

Frame Choice

Notes

Profiles® Framed Cabinets – 12" W x 30" H



The bold metal frame makes a stunning first impression, while the clever storage solutions within – like integrated outlets, USB charging ports and a magnetic tool holder – create a lasting impact. Profiles medicine cabinets are gangable and can be easily combined to create additional storage space. If the extra space isn't necessary, pair with Profiles mirrors or Profiles lighting to achieve the perfect look.

- Limitless design solutions with ability to coordinate styling space above and below the sink
- Non-Electric and Electric options
- Includes two USB charging outlets and two 120VAC outlets



Two Week
Lead Time



Modular



Electrical
Outlet





USB
Charging



Magnetic

12" W x 30" H Cabinets

Description	Model	FRAME FINISHES	
		76, 77 Price	82, 83 Price
4" Deep (D4): 11-1/4" W x 30" H (RO: 10-1/2" W x 29-1/4" H x 4" D)			
 Non-Handed	PC1230D4TNN __	\$ 1,149.	\$ 1,249.
Left – Electric	PC1230D4TLE __	\$ 1,549.	\$ 1,649.
Right – Electric	PC1230D4TRE __	\$ 1,549.	\$ 1,649.
6" Deep (D6): 11-1/4" W x 30" H (RO: 10-1/2" W x 29-1/4" H x 6" D)			
 Non-Handed	PC1230D6TNN __	\$ 1,429.	\$ 1,549.
Left – Electric	PC1230D6TLE __	\$ 1,829.	\$ 1,949.
Right – Electric	PC1230D6TRE __	\$ 1,829.	\$ 1,949.

Frame Finish Options

Fill in __ designator to Model listed above with desired finish. Example: PC1230D4TLE77.

- 76 Chrome
- 77 Polished Nickel
- 82 Matte Gold
- 83 Matte Black

See Surface-Mount Kits, Accessories & Options on the following page.

Profiles® Framed Cabinets – 12" W x 30" H

Surface-Mount Kits for 30" H Cabinets (sold separately)

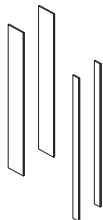

Description	Model	MIRRORED	DECORATIVE		
		Polished Edge	Essentials Palette	Classic Palette	Inspire Palette
		Price	11, 20, 21 Price	22, 26, 27, 28 Price	12, 19, 23 Price
Quantity 1 = Pair of Side Kits and Mounting Hardware					
D4 Surface-Mount, Polished Edge	MSMK30D4P	\$ 149.	N/A	N/A	N/A
D4 Surface-Mount, Decorative*	MSMK30D4 __	N/A	\$ 199.	\$ 249.	\$ 349.
D6 Surface-Mount, Polished Edge	MSMK30D6P	\$ 199.	N/A	N/A	N/A
D6 Surface-Mount, Decorative*	MSMK30D6 __	N/A	\$ 249.	\$ 349.	\$ 399.
D6 Semi-Recessed, Polished Edge	MSMK30D6SRP	\$ 149.	N/A	N/A	N/A
D6 Semi-Recessed, Decorative*	MSMK30D6SR __	N/A	\$ 199.	\$ 249.	\$ 349.

Surface-Mount Kit Color Options

*Fill in __ designator to Decorative Model listed above with desired color. Example: **MSMK30D620**.

Essentials Palette

- 11 Tinted Gray Mirror
- 20 Black
- 21 White

Classic Palette

- 22 Beach
- 26 Matte White
- 27 Matte Gray
- 28 Matte Black

Inspire Palette

- 12 Satin Bronze
- 19 Satin White
- 23 Ocean

Add-On Accessories & Options

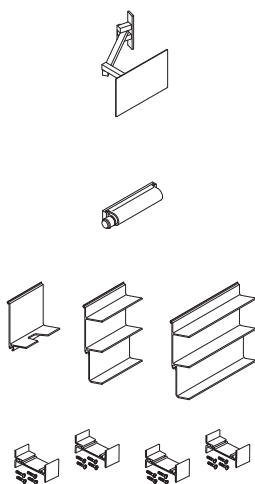

Description	Model	Price
POMM Magnifying Mirror Pull-Out Magnifying Mirror Magnifies at 3X and retracts neatly into cabinet	POMM	\$ 249.
Refer to page 278 for SOMM Magnifying Mirror.		
Handle Kit Push-to-Open Mechanism	MPUSHKIT	\$ 99.
Accessory Trays Razor/Phone Holder	MA-TRAY2.5	\$ 29.
3" Accessory Tray	MA-TRAY3	\$ 29.
5" Accessory Tray	MA-TRAY5	\$ 29.
Ganging Kit Hardware required for installing 2 or 3 cabinets side-by-side	MGKIT	\$ 49.
See Bottom Kits on page 281.		

Coordinating Options:

Profiles Vertical Lights
Refer to pages 146 – 149.

Profiles Wall Mirrors
See pages 170 – 171.

Profiles Vanities
See pages 200 – 217.

Other Options:

Glass Bins
See page 278.

SEE PAGE 58 FOR TIPS AND FEATURES.

Profiles® Framed Cabinets – 16" W x 30" H



The bold metal frame makes a stunning first impression, while the clever storage solutions within – like integrated outlets, USB charging ports and a magnetic tool holder – create a lasting impact. Profiles medicine cabinets are gangable and can be easily combined to create additional storage space. If the extra space isn't necessary, pair with Profiles mirrors or Profiles lighting to achieve the perfect look.

- Limitless design solutions with ability to coordinate styling space above and below the sink
- Non-Electric and Electric options
- Includes two USB charging outlets and two 120VAC outlets



Two Week
Lead Time



Modular



Electrical
Outlet



USB
Charging



Magnetic

16" W x 30" H Cabinets

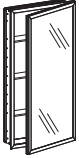
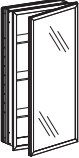
Description	Model	FRAME FINISHES		
		76, 77 Price	82, 83 Price	
4" Deep (D4): 15-1/4" W x 30" H (RO: 14-1/2" W x 29-1/4" H x 4" D)				
	Non-Handed	PC1630D4TNN __	\$ 1,249.	\$ 1,349.
	Left – Electric	PC1630D4TLE __	\$ 1,649.	\$ 1,749.
	Right – Electric	PC1630D4TRE __	\$ 1,649.	\$ 1,749.
6" Deep (D6): 15-1/4" W x 30" H (RO: 14-1/2" W x 29-1/4" H x 6" D)				
	Non-Handed	PC1630D6TNN __	\$ 1,549.	\$ 1,649.
	Left – Electric	PC1630D6TLE __	\$ 1,949.	\$ 2,049.
	Right – Electric	PC1630D6TRE __	\$ 1,949.	\$ 2,049.

Frame Finish Options

Fill in __ designator to Model listed above with desired finish. Example: PC1630D4TRE82.

- 76 Chrome
- 77 Polished Nickel
- 82 Matte Gold
- 83 Matte Black

See Surface-Mount Kits, Accessories & Options on the following page.

Profiles® Framed Cabinets – 16" W x 30" H

Surface-Mount Kits for 30" H Cabinets (sold separately)

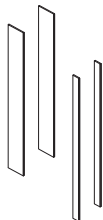

Description	Model	MIRRORED	DECORATIVE		
		Polished Edge	Essentials Palette	Classic Palette	Inspire Palette
		Price	Price	Price	Price
Quantity 1 = Pair of Side Kits and Mounting Hardware					
D4 Surface-Mount, Polished Edge	MSMK30D4P	\$ 149.	N/A	N/A	N/A
D4 Surface-Mount, Decorative*	MSMK30D4 __	N/A	\$ 199.	\$ 249.	\$ 349.
D6 Surface-Mount, Polished Edge	MSMK30D6P	\$ 199.	N/A	N/A	N/A
D6 Surface-Mount, Decorative*	MSMK30D6 __	N/A	\$ 249.	\$ 349.	\$ 399.
D6 Semi-Recessed, Polished Edge	MSMK30D6SRP	\$ 149.	N/A	N/A	N/A
D6 Semi-Recessed, Decorative*	MSMK30D6SR __	N/A	\$ 199.	\$ 249.	\$ 349.

Surface-Mount Kit Color Options

*Fill in __ designator to Decorative Model listed above with desired color. Example: **MSMK30D620**.

Essentials Palette

- 11 Tinted Gray Mirror
- 20 Black
- 21 White

Classic Palette

- 22 Beach
- 26 Matte White
- 27 Matte Gray
- 28 Matte Black

Inspire Palette

- 12 Satin Bronze
- 19 Satin White
- 23 Ocean

Add-On Accessories & Options

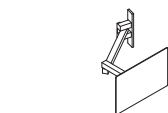

Description

POMM Magnifying Mirror

Pull-Out Magnifying Mirror POMM
Magnifies at 3X and retracts neatly into cabinet

Price

\$ 249.

Coordinating Options:

Profiles Vertical Lights
Refer to pages 146 – 149.

Profiles Wall Mirrors
See pages 170 – 171.

Profiles Vanities
See pages 200 – 217.

Other Options:

Glass Bins
See page 278.

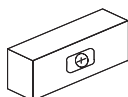

Safety Lock Box

Full compartment keyed lock box in an anodized aluminum finish

For 16" W, 4" D cabinet

SLB16D4

\$ 299.

For 16" W, 6" D cabinet

SLB16D6

\$ 299.



Handle Kit

Push-to-Open Mechanism

MPUSHKIT

\$ 99.

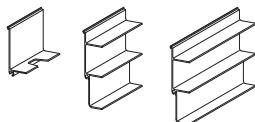

Accessory Trays

Razor/Phone Holder

MA-TRAY2.5

\$ 29.

3" Accessory Tray

MA-TRAY3

\$ 29.

5" Accessory Tray

MA-TRAY5

\$ 29.



Ganging Kit

MGKIT

\$ 49.

Hardware required for installing 2 or 3 cabinets side-by-side

See Bottom Kits on page 281.

SEE PAGE 58 FOR TIPS AND FEATURES.

Profiles® Framed Cabinets – 20" W x 30" H



The bold metal frame makes a stunning first impression, while the clever storage solutions within – like integrated outlets, USB charging ports and a magnetic tool holder – create a lasting impact. Profiles medicine cabinets are gangable and can be easily combined to create additional storage space. If the extra space isn't necessary, pair with Profiles mirrors or Profiles lighting to achieve the perfect look.

- Limitless design solutions with ability to coordinate styling space above and below the sink
- Non-Electric and Electric options
- Includes two USB charging outlets and two 120VAC outlets



Two Week
Lead Time



Modular



Electrical
Outlet



USB
Charging



Magnetic

20" W x 30" H Cabinets

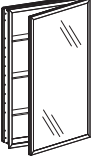
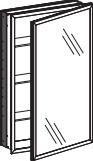
Description	Model	FRAME FINISHES	
		76, 77 Price	82, 83 Price
4" Deep (D4): 19-1/4" W x 30" H (RO: 18-1/2" W x 29-1/4" H x 4" D)			
 Non-Handed	PC2030D4TNN __	\$ 1,349.	\$ 1,499.
Left – Electric	PC2030D4TLE __	\$ 1,749.	\$ 1,899.
Right – Electric	PC2030D4TRE __	\$ 1,749.	\$ 1,899.
6" Deep (D6): 19-1/4" W x 30" H (RO: 18-1/2" W x 29-1/4" H x 6" D)			
 Non-Handed	PC2030D6TNN __	\$ 1,649.	\$ 1,749.
Left – Electric	PC2030D6TLE __	\$ 2,049.	\$ 2,179.
Right – Electric	PC2030D6TRE __	\$ 2,049.	\$ 2,179.

Frame Finish Options

Fill in __ designator to Model listed above with desired finish. Example: PC2030D6TNN76.

- 76 Chrome
- 77 Polished Nickel
- 82 Matte Gold
- 83 Matte Black

See Surface-Mount Kits, Accessories & Options on the following page.

Profiles® Framed Cabinets – 20" W x 30" H

Surface-Mount Kits for 30" H Cabinets (sold separately)

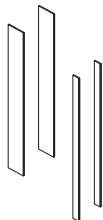

Description	Model	MIRRORED	DECORATIVE		
		Polished Edge	Essentials Palette	Classic Palette	Inspire Palette
		Price	11, 20, 21 Price	22, 26, 27, 28 Price	12, 19, 23 Price
Quantity 1 = Pair of Side Kits and Mounting Hardware					
D4 Surface-Mount, Polished Edge	MSMK30D4P	\$ 149.	N/A	N/A	N/A
D4 Surface-Mount, Decorative*	MSMK30D4 __	N/A	\$ 199.	\$ 249.	\$ 349.
D6 Surface-Mount, Polished Edge	MSMK30D6P	\$ 199.	N/A	N/A	N/A
D6 Surface-Mount, Decorative*	MSMK30D6 __	N/A	\$ 249.	\$ 349.	\$ 399.
D6 Semi-Recessed, Polished Edge	MSMK30D6SRP	\$ 149.	N/A	N/A	N/A
D6 Semi-Recessed, Decorative*	MSMK30D6SR __	N/A	\$ 199.	\$ 249.	\$ 349.

Surface-Mount Kit Color Options

*Fill in __ designator to Decorative Model listed above with desired color. Example: **MSMK30D620**.

Essentials Palette

- 11 Tinted Gray Mirror
- 20 Black
- 21 White

Classic Palette

- 22 Beach
- 26 Matte White
- 27 Matte Gray
- 28 Matte Black

Inspire Palette

- 12 Satin Bronze
- 19 Satin White
- 23 Ocean

Add-On Accessories & Options

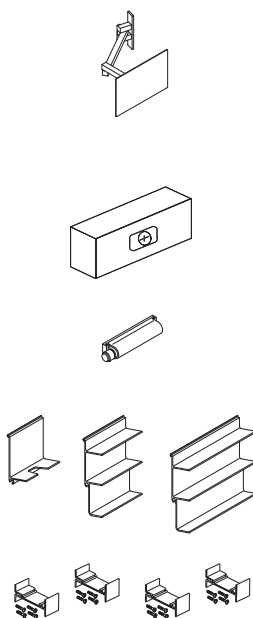

Description	Model	Price
POMM Magnifying Mirror Pull-Out Magnifying Mirror Magnifies at 3X and retracts neatly into cabinet	POMM	\$ 249.
Refer to page 278 for SOMM Magnifying Mirror.		
Safety Lock Box Full compartment keyed lock box in an anodized aluminum finish For 20" W, 4" D cabinet For 20" W, 6" D cabinet	SLB20D4 SLB20D6	\$ 299. \$ 299.
Handle Kit Push-to-Open Mechanism	MPUSHKIT	\$ 99.
Accessory Trays Razor/Phone Holder 3" Accessory Tray 5" Accessory Tray	MA-TRAY2.5 MA-TRAY3 MA-TRAY5	\$ 29. \$ 29. \$ 29.
Ganging Kit Hardware required for installing 2 or 3 cabinets side-by-side	MGKIT	\$ 49.

Coordinating Options:

- Profiles Vertical Lights
Refer to pages 146 – 149.
- Profiles Wall Mirrors
See pages 170 – 171.
- Profiles Vanities
See pages 200 – 217.

Other Options:

- Glass Bins
See page 278.

SEE PAGE 58 FOR TIPS AND FEATURES.

Profiles® Framed Cabinets – 24" W x 30" H



The bold metal frame makes a stunning first impression, while the clever storage solutions within – like integrated outlets, USB charging ports and a magnetic tool holder – create a lasting impact. Profiles medicine cabinets are gangable and can be easily combined to create additional storage space. If the extra space isn't necessary, pair with Profiles mirrors or Profiles lighting to achieve the perfect look.

- Limitless design solutions with ability to coordinate styling space above and below the sink
- Non-Electric and Electric options
- Includes two USB charging outlets and two 120VAC outlets



Two Week
Lead Time



Modular



Electrical
Outlet



USB
Charging



Magnetic

24" W x 30" H Cabinets

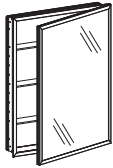
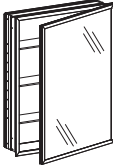
Description	Model	FRAME FINISHES	
		76, 77 Price	82, 83 Price
4" Deep (D4): 23-1/4" W x 30" H (RO: 22-1/2" W x 29-1/4" H x 4" D)			
 Non-Handed	PC2430D4TNN __	\$ 1,499.	\$ 1,599.
Left – Electric	PC2430D4TLE __	\$ 1,899.	\$ 1,999.
Right – Electric	PC2430D4TRE __	\$ 1,899.	\$ 1,999.
6" Deep (D6): 23-1/4" W x 30" H (RO: 22-1/2" W x 29-1/4" H x 6" D)			
 Non-Handed	PC2430D6TNN __	\$ 1,749.	\$ 1,899.
Left – Electric	PC2430D6TLE __	\$ 2,179.	\$ 2,279.
Right – Electric	PC2430D6TRE __	\$ 2,179.	\$ 2,279.

Frame Finish Options

Fill in __ designator to Model listed above with desired finish. Example: PC2430D6TLE83.

- 76 Chrome
- 77 Polished Nickel
- 82 Matte Gold
- 83 Matte Black

See Surface-Mount Kits, Accessories & Options on the following page.

Profiles® Framed Cabinets – 24" W x 30" H

Surface-Mount Kits for 30" H Cabinets (sold separately)

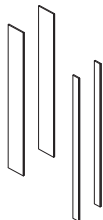

Description	Model	MIRRORED	DECORATIVE		
		Polished Edge	Essentials Palette	Classic Palette	Inspire Palette
		Price	11, 20, 21 Price	22, 26, 27, 28 Price	12, 19, 23 Price
Quantity 1 = Pair of Side Kits and Mounting Hardware					
D4 Surface-Mount, Polished Edge	MSMK30D4P	\$ 149.	N/A	N/A	N/A
D4 Surface-Mount, Decorative*	MSMK30D4 __	N/A	\$ 199.	\$ 249.	\$ 349.
D6 Surface-Mount, Polished Edge	MSMK30D6P	\$ 199.	N/A	N/A	N/A
D6 Surface-Mount, Decorative*	MSMK30D6 __	N/A	\$ 249.	\$ 349.	\$ 399.
D6 Semi-Recessed, Polished Edge	MSMK30D6SRP	\$ 149.	N/A	N/A	N/A
D6 Semi-Recessed, Decorative*	MSMK30D6SR __	N/A	\$ 199.	\$ 249.	\$ 349.

Surface-Mount Kit Color Options

*Fill in __ designator to Decorative Model listed above with desired color. Example: **MSMK30D620**.

Essentials Palette

- 11 Tinted Gray Mirror
- 20 Black
- 21 White

Classic Palette

- 22 Beach
- 26 Matte White
- 27 Matte Gray
- 28 Matte Black

Inspire Palette

- 12 Satin Bronze
- 19 Satin White
- 23 Ocean

Add-On Accessories & Options

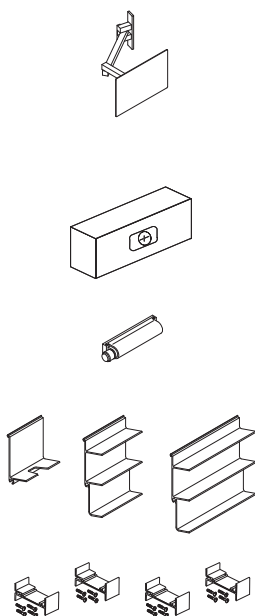

Description	Model	Price
POMM Magnifying Mirror Pull-Out Magnifying Mirror Magnifies at 3X and retracts neatly into cabinet	POMM	\$ 249.
Refer to page 278 for SOMM Magnifying Mirror.		
Safety Lock Box Full compartment keyed lock box in an anodized aluminum finish For 24" W, 4" D cabinet For 24" W, 6" D cabinet	SLB24D4 SLB24D6	\$ 299. \$ 299.
Handle Kit Push-to-Open Mechanism	MPUSHKIT	\$ 99.
Accessory Trays Razor/Phone Holder 3" Accessory Tray 5" Accessory Tray	MA-TRAY2.5 MA-TRAY3 MA-TRAY5	\$ 29. \$ 29. \$ 29.
Ganging Kit Hardware required for installing 2 or 3 cabinets side-by-side	MGKIT	\$ 49.

Coordinating Options:

- Profiles Vertical Lights
Refer to pages 146 – 149.
- Profiles Wall Mirrors
See pages 170 – 171.
- Profiles Vanities
See pages 200 – 217.

Other Options:

- Glass Bins
See page 278.

SEE PAGE 58 FOR TIPS AND FEATURES.

Profiles® Framed Cabinets – 12" W x 40" H



The bold metal frame makes a stunning first impression, while the clever storage solutions within – like integrated outlets, USB charging ports and a magnetic tool holder – create a lasting impact. Profiles medicine cabinets are gangable and can be easily combined to create additional storage space. If the extra space isn't necessary, pair with Profiles mirrors or Profiles lighting to achieve the perfect look.



- Limitless design solutions with ability to coordinate styling space above and below the sink
- Non-Electric and Electric options
- Includes two USB charging outlets and two 120VAC outlets



Two Week
Lead Time



12" W x 40" H Cabinets

Description	Model	FRAME FINISHES	
		76, 77 Price	82, 83 Price
4" Deep (D4): 11-1/4" W x 39-3/8" H (RO: 10-1/2" W x 38-5/8" H x 4" D)			
 Non-Handed	PC1240D4TNN __	\$ 1,349.	\$ 1,499.
Left – Electric	PC1240D4TLE __	\$ 1,749.	\$ 1,899.
Right – Electric	PC1240D4TRE __	\$ 1,749.	\$ 1,899.
6" Deep (D6): 11-1/4" W x 39-3/8" H (RO: 10-1/2" W x 38-5/8" H x 6" D)			
 Non-Handed	PC1240D6TNN __	\$ 1,649.	\$ 1,749.
Left – Electric	PC1240D6TLE __	\$ 2,049.	\$ 2,179.
Right – Electric	PC1240D6TRE __	\$ 2,049.	\$ 2,179.

Frame Finish Options

Fill in __ designator to Model listed above with desired finish. Example: PC1240D4TLE77.

- 76 Chrome
- 77 Polished Nickel
- 82 Matte Gold
- 83 Matte Black

See Surface-Mount Kits, Accessories & Options on the following page.

Profiles® Framed Cabinets – 12" W x 40" H

Surface-Mount Kits for 40" H Cabinets (sold separately)

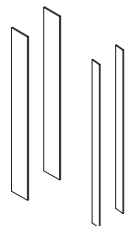

Description	Model	MIRRORED	DECORATIVE		
		Polished Edge	Essentials Palette	Classic Palette	Inspire Palette
		Price	11, 20, 21 Price	22, 26, 27, 28 Price	12, 19, 23 Price
Quantity 1 = Pair of Side Kits and Mounting Hardware					
D4 Surface-Mount, Polished Edge	MSMK40D4P	\$ 249.	N/A	N/A	N/A
D4 Surface-Mount, Decorative*	MSMK40D4 __	N/A	\$ 349.	\$ 399.	\$ 449.
D6 Surface-Mount, Polished Edge	MSMK40D6P	\$ 349.	N/A	N/A	N/A
D6 Surface-Mount, Decorative*	MSMK40D6 __	N/A	\$ 399.	\$ 449.	\$ 499.
D6 Semi-Recessed, Polished Edge	MSMK40D6SRP	\$ 249.	N/A	N/A	N/A
D6 Semi-Recessed, Decorative*	MSMK40D6SR __	N/A	\$ 349.	\$ 399.	\$ 449.

Surface-Mount Kit Color Options

*Fill in __ designator to Decorative Model listed above with desired color. Example: **MSMK40D620**.

Essentials Palette

- 11 Tinted Gray Mirror
- 20 Black
- 21 White

Classic Palette

- 22 Beach
- 26 Matte White
- 27 Matte Gray
- 28 Matte Black

Inspire Palette

- 12 Satin Bronze
- 19 Satin White
- 23 Ocean

Add-On Accessories & Options

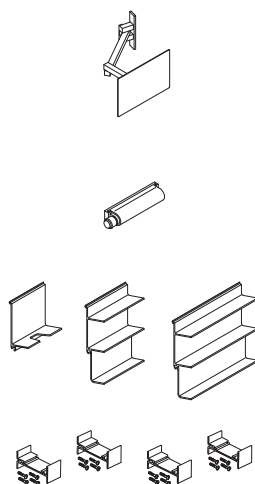

Description	Model	Price
POMM Magnifying Mirror Pull-Out Magnifying Mirror Magnifies at 3X and retracts neatly into cabinet	POMM	\$ 249.
Refer to page 278 for SOMM Magnifying Mirror.		
Handle Kit Push-to-Open Mechanism	MPUSHKIT	\$ 99.
Accessory Trays Razor/Phone Holder	MA-TRAY2.5	\$ 29.
3" Accessory Tray	MA-TRAY3	\$ 29.
5" Accessory Tray	MA-TRAY5	\$ 29.
Ganging Kit Hardware required for installing 2 or 3 cabinets side-by-side	MGKIT	\$ 49.
See Bottom Kits on page 281.		

Coordinating Options:

Profiles Vertical Lights
Refer to pages 146 – 149.

Profiles Wall Mirrors
See pages 170 – 171.

Profiles Vanities
See pages 200 – 217.

Other Options:

Glass Bins
See page 278.

SEE PAGE 58 FOR TIPS AND FEATURES.

Profiles® Framed Cabinets – 16" W x 40" H



The bold metal frame makes a stunning first impression, while the clever storage solutions within – like integrated outlets, USB charging ports and a magnetic tool holder – create a lasting impact. Profiles medicine cabinets are gangable and can be easily combined to create additional storage space. If the extra space isn't necessary, pair with Profiles mirrors or Profiles lighting to achieve the perfect look.

- Limitless design solutions with ability to coordinate styling space above and below the sink
- Non-Electric and Electric options
- Includes two USB charging outlets and two 120VAC outlets



Two Week
Lead Time



Modular



Electrical
Outlet



USB
Charging



Magnetic

16" W x 40" H Cabinets

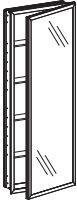
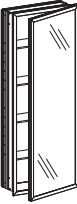
Description	Model	FRAME FINISHES	
		76, 77 Price	82, 83 Price
4" Deep (D4): 15-1/4" W x 39-3/8" H (RO: 14-1/2" W x 38-5/8" H x 4" D)			
 Non-Handed	PC1640D4TNN __	\$ 1,499.	\$ 1,599.
Left – Electric	PC1640D4TLE __	\$ 1,899.	\$ 1,999.
Right – Electric	PC1640D4TRE __	\$ 1,899.	\$ 1,999.
6" Deep (D6): 15-1/4" W x 39-3/8" H (RO: 14-1/2" W x 38-5/8" H x 6" D)			
 Non-Handed	PC1640D6TNN __	\$ 1,749.	\$ 1,899.
Left – Electric	PC1640D6TLE __	\$ 2,179.	\$ 2,279.
Right – Electric	PC1640D6TRE __	\$ 2,179.	\$ 2,279.

Frame Finish Options

Fill in __ designator to Model listed above with desired finish. Example: PC1640D4TRE82.

- 76 Chrome
- 77 Polished Nickel
- 82 Matte Gold
- 83 Matte Black

See Surface-Mount Kits, Accessories & Options on the following page.

Profiles® Framed Cabinets – 16" W x 40" H

Surface-Mount Kits for 40" H Cabinets (sold separately)

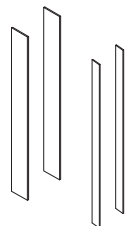

Description	Model	MIRRORED	DECORATIVE		
		Polished Edge	Essentials Palette	Classic Palette	Inspire Palette
		Price	11, 20, 21 Price	22, 26, 27, 28 Price	12, 19, 23 Price
Quantity 1 = Pair of Side Kits and Mounting Hardware					
D4 Surface-Mount, Polished Edge	MSMK40D4P	\$ 249.	N/A	N/A	N/A
D4 Surface-Mount, Decorative*	MSMK40D4 __	N/A	\$ 349.	\$ 399.	\$ 449.
D6 Surface-Mount, Polished Edge	MSMK40D6P	\$ 349.	N/A	N/A	N/A
D6 Surface-Mount, Decorative*	MSMK40D6 __	N/A	\$ 399.	\$ 449.	\$ 499.
D6 Semi-Recessed, Polished Edge	MSMK40D6SRP	\$ 249.	N/A	N/A	N/A
D6 Semi-Recessed, Decorative*	MSMK40D6SR __	N/A	\$ 349.	\$ 399.	\$ 449.

Surface-Mount Kit Color Options

*Fill in __ designator to Decorative Model listed above with desired color. Example: **MSMK40D620**.

Essentials Palette

- 11 Tinted Gray Mirror
- 20 Black
- 21 White

Classic Palette

- 22 Beach
- 26 Matte White
- 27 Matte Gray
- 28 Matte Black

Inspire Palette

- 12 Satin Bronze
- 19 Satin White
- 23 Ocean

Add-On Accessories & Options

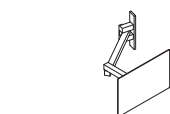

Description

POMM Magnifying Mirror

Pull-Out Magnifying Mirror POMM
Magnifies at 3X and retracts neatly into cabinet

Price

\$ 249.

Coordinating Options:

Profiles Vertical Lights
Refer to pages 146 – 149.

Profiles Wall Mirrors
See pages 170 – 171.

Profiles Vanities
See pages 200 – 217.

Other Options:

Glass Bins
See page 278.

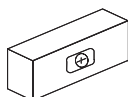

Safety Lock Box

Full compartment keyed lock box in an anodized aluminum finish

For 16" W, 4" D cabinet SLB16D4 \$ 299.

For 16" W, 6" D cabinet SLB16D6 \$ 299.



Handle Kit

Push-to-Open Mechanism MPUSHKIT \$ 99.

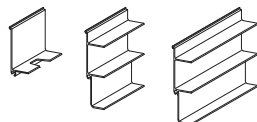

Accessory Trays

Razor/Phone Holder MA-TRAY2.5 \$ 29.

3" Accessory Tray MA-TRAY3 \$ 29.

5" Accessory Tray MA-TRAY5 \$ 29.



Ganging Kit

Hardware required for installing 2 or 3 cabinets side-by-side

\$ 49.

See Bottom Kits on page 281.

SEE PAGE 58 FOR TIPS AND FEATURES.

Profiles® Framed Cabinets – 20" W x 40" H



The bold metal frame makes a stunning first impression, while the clever storage solutions within – like integrated outlets, USB charging ports and a magnetic tool holder – create a lasting impact. Profiles medicine cabinets are gangable and can be easily combined to create additional storage space. If the extra space isn't necessary, pair with Profiles mirrors or Profiles lighting to achieve the perfect look.

- Limitless design solutions with ability to coordinate styling space above and below the sink
- Non-Electric and Electric options
- Includes two USB charging outlets and two 120VAC outlets



Two Week
Lead Time



Modular



Electrical
Outlet





USB
Charging

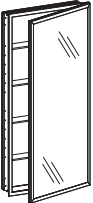

Magnetic

20" W x 40" H Cabinets

Description	Model	FRAME FINISHES	
		76, 77 Price	82, 83 Price
4" Deep (D4): 19-1/4" W x 39-3/8" H (RO: 18-1/2" W x 38-5/8" H x 4" D)			
 Non-Handed	PC2040D4TNN __	\$ 1,599.	\$ 1,699.
Left – Electric	PC2040D4TLE __	\$ 1,999.	\$ 2,129.
Right – Electric	PC2040D4TRE __	\$ 1,999.	\$ 2,129.
6" Deep (D6): 19-1/4" W x 39-3/8" H (RO: 18-1/2" W x 38-5/8" H x 6" D)			
 Non-Handed	PC2040D6TNN __	\$ 1,899.	\$ 1,999.
Left – Electric	PC2040D6TLE __	\$ 2,279.	\$ 2,399.
Right – Electric	PC2040D6TRE __	\$ 2,279.	\$ 2,399.

Frame Finish Options

Fill in __ designator to Model listed above with desired finish. Example: PC2040D6TNN76.

- 76 Chrome
- 77 Polished Nickel
- 82 Matte Gold
- 83 Matte Black

See Surface-Mount Kits, Accessories & Options on the following page.

Profiles® Framed Cabinets – 20" W x 40" H

Surface-Mount Kits for 40" H Cabinets (sold separately)

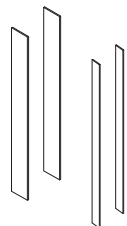

Description	Model	MIRRORED	DECORATIVE		
		Polished Edge	Essentials Palette	Classic Palette	Inspire Palette
		Price	11, 20, 21 Price	22, 26, 27, 28 Price	12, 19, 23 Price
Quantity 1 = Pair of Side Kits and Mounting Hardware					
D4 Surface-Mount, Polished Edge	MSMK40D4P	\$ 249.	N/A	N/A	N/A
D4 Surface-Mount, Decorative*	MSMK40D4 __	N/A	\$ 349.	\$ 399.	\$ 449.
D6 Surface-Mount, Polished Edge	MSMK40D6P	\$ 349.	N/A	N/A	N/A
D6 Surface-Mount, Decorative*	MSMK40D6 __	N/A	\$ 399.	\$ 449.	\$ 499.
D6 Semi-Recessed, Polished Edge	MSMK40D6SRP	\$ 249.	N/A	N/A	N/A
D6 Semi-Recessed, Decorative*	MSMK40D6SR __	N/A	\$ 349.	\$ 399.	\$ 449.

Surface-Mount Kit Color Options

*Fill in __ designator to Decorative Model listed above with desired color. Example: **MSMK40D620**.

Essentials Palette

- 11 Tinted Gray Mirror
- 20 Black
- 21 White

Classic Palette

- 22 Beach
- 26 Matte White
- 27 Matte Gray
- 28 Matte Black

Inspire Palette

- 12 Satin Bronze
- 19 Satin White
- 23 Ocean

Add-On Accessories & Options

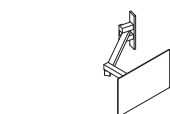

Description

POMM Magnifying Mirror

Pull-Out Magnifying Mirror POMM
Magnifies at 3X and retracts neatly into cabinet

Price

\$ 249.

Coordinating Options:

Profiles Vertical Lights
Refer to pages 146 – 149.

Profiles Wall Mirrors
See pages 170 – 171.

Profiles Vanities
See pages 200 – 217.

Other Options:

Glass Bins
See page 278.

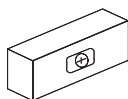

Safety Lock Box

Full compartment keyed lock box in an anodized aluminum finish

For 20" W, 4" D cabinet SLB20D4 \$ 299.

For 20" W, 6" D cabinet SLB20D6 \$ 299.



Handle Kit

Push-to-Open Mechanism MPUSHKIT \$ 99.

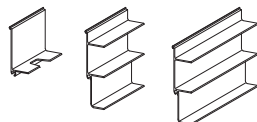

Accessory Trays

Razor/Phone Holder MA-TRAY2.5 \$ 29.

3" Accessory Tray MA-TRAY3 \$ 29.

5" Accessory Tray MA-TRAY5 \$ 29.



Ganging Kit

MGKIT \$ 49.
Hardware required for installing 2 or 3 cabinets side-by-side

See Bottom Kits on page 281.

SEE PAGE 58 FOR TIPS AND FEATURES.

Profiles® Framed Cabinets – 24" W x 40" H



The bold metal frame makes a stunning first impression, while the clever storage solutions within – like integrated outlets, USB charging ports and a magnetic tool holder – create a lasting impact. Profiles medicine cabinets are gangable and can be easily combined to create additional storage space. If the extra space isn't necessary, pair with Profiles mirrors or Profiles lighting to achieve the perfect look.

- Limitless design solutions with ability to coordinate styling space above and below the sink
- Non-Electric and Electric options
- Includes two USB charging outlets and two 120VAC outlets



Two Week
Lead Time



Modular



Electrical
Outlet



USB
Charging



Magnetic

24" W x 40" H Cabinets

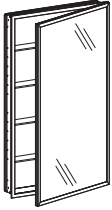
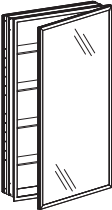
Description	Model	FRAME FINISHES	
		76, 77 Price	82, 83 Price
4" Deep (D4): 23-1/4" W x 39-3/8" H (RO: 22-1/2" W x 38-5/8" H x 4" D)			
 Non-Handed	PC2440D4TNN __	\$ 1,699.	\$ 1,829.
Left – Electric	PC2440D4TLE __	\$ 2,129.	\$ 2,229.
Right – Electric	PC2440D4TRE __	\$ 2,129.	\$ 2,229.
6" Deep (D6): 23-1/4" W x 39-3/8" H (RO: 22-1/2" W x 38-5/8" H x 6" D)			
 Non-Handed	PC2440D6TNN __	\$ 1,999.	\$ 2,129.
Left – Electric	PC2440D6TLE __	\$ 2,399.	\$ 2,529.
Right – Electric	PC2440D6TRE __	\$ 2,399.	\$ 2,529.

Frame Finish Options

Fill in __ designator to Model listed above with desired finish. Example: PC2440D6TLE83.

- 76 Chrome
- 77 Polished Nickel
- 82 Matte Gold
- 83 Matte Black

See Surface-Mount Kits, Accessories & Options on the following page.

Profiles® Framed Cabinets – 24" W x 40" H

Surface-Mount Kits for 40" H Cabinets (sold separately)

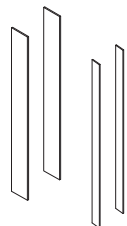

Description	Model	MIRRORED	DECORATIVE		
		Polished Edge	Essentials Palette	Classic Palette	Inspire Palette
		Price	11, 20, 21 Price	22, 26, 27, 28 Price	12, 19, 23 Price
Quantity 1 = Pair of Side Kits and Mounting Hardware					
D4 Surface-Mount, Polished Edge	MSMK40D4P	\$ 249.	N/A	N/A	N/A
D4 Surface-Mount, Decorative*	MSMK40D4 __	N/A	\$ 349.	\$ 399.	\$ 449.
D6 Surface-Mount, Polished Edge	MSMK40D6P	\$ 349.	N/A	N/A	N/A
D6 Surface-Mount, Decorative*	MSMK40D6 __	N/A	\$ 399.	\$ 449.	\$ 499.
D6 Semi-Recessed, Polished Edge	MSMK40D6SRP	\$ 249.	N/A	N/A	N/A
D6 Semi-Recessed, Decorative*	MSMK40D6SR __	N/A	\$ 349.	\$ 399.	\$ 449.

Surface-Mount Kit Color Options

*Fill in __ designator to Decorative Model listed above with desired color. Example: **MSMK40D620**.

Essentials Palette

- 11 Tinted Gray Mirror
- 20 Black
- 21 White

Classic Palette

- 22 Beach
- 26 Matte White
- 27 Matte Gray
- 28 Matte Black

Inspire Palette

- 12 Satin Bronze
- 19 Satin White
- 23 Ocean

Add-On Accessories & Options

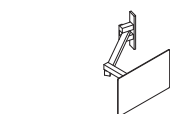

Description

POMM Magnifying Mirror

Pull-Out Magnifying Mirror POMM
Magnifies at 3X and retracts neatly into cabinet

Price

\$ 249.

Coordinating Options:

Profiles Vertical Lights
Refer to pages 146 – 149.

Profiles Wall Mirrors
See pages 170 – 171.

Profiles Vanities
See pages 200 – 217.

Other Options:

Glass Bins
See page 278.

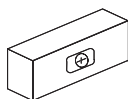

Safety Lock Box

Full compartment keyed lock box in an anodized aluminum finish

For 24" W, 4" D cabinet SLB24D4 \$ 299.

For 24" W, 6" D cabinet SLB24D6 \$ 299.



Handle Kit

Push-to-Open Mechanism MPUSHKIT \$ 99.

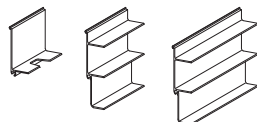

Accessory Trays

Razor/Phone Holder MA-TRAY2.5 \$ 29.

3" Accessory Tray MA-TRAY3 \$ 29.

5" Accessory Tray MA-TRAY5 \$ 29.



Ganging Kit

MGKIT \$ 49.
Hardware required for installing 2 or 3 cabinets side-by-side

See Bottom Kits on page 281.

SEE PAGE 58 FOR TIPS AND FEATURES.

Vertical Lighting – Ganging Reference

InLine

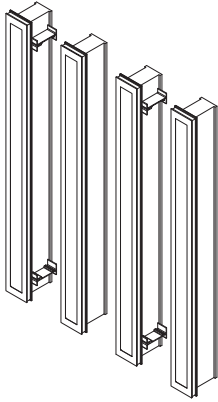

(4) ML3.540ILSFMRDV

+

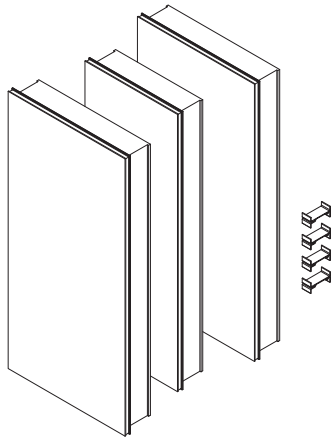

(1) MC2040D4FPRE4
 (1) MC1640D4FPRE4
 (1) MC2040D4FPLE4
 (1) MGKIT

=

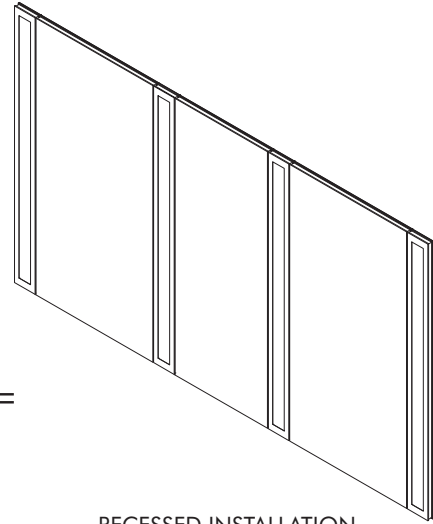

RECESSED INSTALLATION
 67-3/4" x 39-3/8"

Lighting

Profiles®

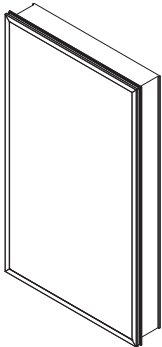

(1) PC2040D4TLE _ _ _
 (1) VP30H1D21T _ _ S _ _
 (1) VP30H1D21P _ _ S _ _
 (1) VP30H2D21F _ _ S _ _

+

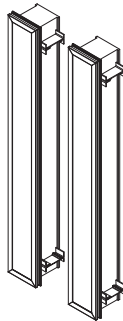

(2) PL5.040TLSC _ _ DV
 (1) VM2SKH4D21- _ _

=

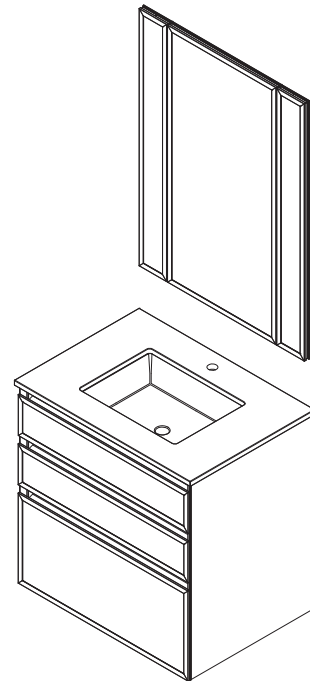
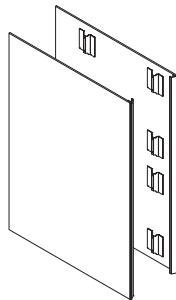
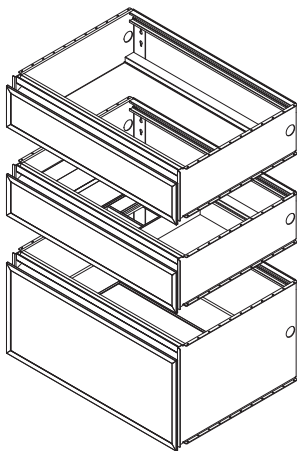

(1) TC31UCO _ _ -1

For more guidance on our modular solutions, visit robern.com/modularity.

Profiles® Vertical Lighting – Table of Contents, Tips & Features

Table of Contents

Vertical Lighting Ganging Reference 141 – 142

Profiles Vertical Lighting Tips & Features 146 – 147

Profiles Vertical Lighting 148 – 149

Profiles Framed Cabinets 57 – 77

Profiles Framed Mirrors 170 – 171

Tips & Features

Dimensions & Weight

- Width: 3-1/2" (89 mm), 5" (127 mm)
- Height: 30" (762 mm), 39-3/8" (1000 mm)
- Depth: 4-5/8" (117 mm) surface-mount, 7/8" (22 mm) when recessed
- Net Weight: 10 – 15 lbs

Features & Benefits

- Create a coordinated ensemble by pairing with Profiles Medicine Cabinets, Profiles Mirrors and Profiles Vanities
- Match all fixtures in your styling space with Profiles metal frame finishes for a coordinated look: Chrome, Polished Nickel, Matte Gold, Matte Black
- Modular vertical lighting can be ganged with Profiles Medicine Cabinets and Profiles Mirrors
- Choose between warm, relaxing tones (2700K) that replicate indoor lighting and cool, invigorating tones (4000K), which simulate bright daylight or choose variable lighting that lets you fine-tune your color temperature between warm (2700K) and cool light (5600K) with the use of dimmers
- Remarkably accurate color rendering with a CRI value of 90+ and R9 of 50+, so you can see your truest reflection
- Light direction and output eliminates dark shadows, provides bright even task lighting and rich, saturated tone in your reflection
- Dimmable LED task lighting to 1% lets you select the ideal brightness for any task, using a standard residential dimmer that works with your home's existing wiring

Features & Benefits(Continued)

- Energy efficient LEDs with an estimated life of 53,000 hours
- Constructed to operate in high humidity or damp spaces. ETL/UL Certified for damp locations to UL 1598 CSA Standard C22.2 No. 250.0

Configurable Options

- Metal Frame Finishes: Chrome, Polished Nickel, Matte Gold, Matte Black
- Color Temperature: 2700K, 4000K, Variable (2700K – 5600K)

Construction

- Durable rust-free anodized aluminum and glass construction – resists intense moisture, ensures long-lasting beauty
- Satin anodized aluminum body

Installation

- This installation may require more than one person
- Sold as a single unit (not as pairs)
- Fixture adds 3-1/2" or 5" per light to the overall rough-in width
- Can be recessed or surface-mounted with 4" depth (D4) cabinets (D4 surface-mount kit required) and fully recessed with 6" depth (D6) cabinets
- Ganging kit required if used to mount with multiple cabinets – light comes with ganging hardware on one side



Profiles® Vertical Lighting – Tips & Features

Tips & Features (Continued)

Installation(Continued)

- Wired internally – front access serviceability
- Operates on 120VAC and 0.5A (2700K/4000K) or 1.0A (variable) per fixture
- Glass lens plane sits flush when paired with a Profiles Medicine Cabinet and Mirror (the mirror when used with ganging kit)
- Optional MGKIT includes hardware to gang to both sides of a cabinet. As a result, three lights and two cabinets can be ganged together from one MGKIT.
- Recommended dimmer for Profile fixture: Lutron® Diva ELV Dimmer (Model DVELV300P) or Caseta Wireless ELV Dimmer (Model PD5NE). These dimmers have full range control, low light adjustment, stop flickering and last setting memory.

Accessories

- Surface-Mount Kit (MSMK__D_P)
- Ganging Kit (MGKIT) – for ganging with cabinets
- Ganging Kit (PMGKIT____) – for ganging with Profiles Mirrors

Lighting Specs: Standard Profiles

Kelvin	2700K 4000K 2700K – 5600K
CRI	90+
Lumens ¹	746 – 2610
Lumens per Watt	39 – 56
R9 Value ¹	58 – 80+

¹ Based on a measurement of a subset of sizes and lighting styles



Profiles® Vertical Lighting

Wherever you start your day, high-quality task lighting can make all the difference. Profiles Lighting offers remarkably accurate color rendering; adjustable color temperature and bright, consistent output that eliminates harsh shadows on the face – so you see your truest reflection, every time.

- Modular lighting can be ganged with Profiles medicine cabinets and Profiles mirrors
- Choose between warm, relaxing tones (2700K) that replicate indoor lighting and cool, invigorating tones (4000K), which simulate bright daylight or choose variable lighting that lets you fine-tune your color temperature between warm (2700K) and cool light (5600K) with the use of dimmers



Two Week Lead Time



Dimmable LED



Tunable



Modular

Profiles Lighting (Quantity 1 = Single)

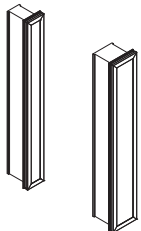
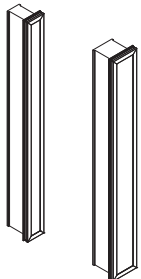
Description	Model	FRAME FINISHES		
		76, 77 Price	82, 83 Price	
Profiles 30" H Lights (RO: 2-3/4" W x 29-1/4" H)				
	3-1/2" W – 2700K, Dimmable	PL3.530TLSC __ D3	\$ 1,049.	\$ 1,179.
	3-1/2" W – 4000K, Dimmable	PL3.530TLSC __ D4	\$ 1,049.	\$ 1,179.
	3-1/2" W – Variable, Dimmable	PL3.530TLSC __ DV	\$ 1,229.	\$ 1,329.
	5" W – 2700K, Dimmable	PL5.030TLSC __ D3	\$ 1,399.	\$ 1,529.
	5" W – 4000K, Dimmable	PL5.030TLSC __ D4	\$ 1,399.	\$ 1,529.
	5" W – Variable, Dimmable	PL5.030TLSC __ DV	\$ 1,579.	\$ 1,679.
Profiles 40" H Lights (RO: 2-3/4" W x 38-5/8" H)				
	3-1/2" W – 2700K, Dimmable	PL3.540TLSC __ D3	\$ 1,279.	\$ 1,399.
	3-1/2" W – 4000K, Dimmable	PL3.540TLSC __ D4	\$ 1,279.	\$ 1,399.
	3-1/2" W – Variable, Dimmable	PL3.540TLSC __ DV	\$ 1,479.	\$ 1,579.
	5" W – 2700K, Dimmable	PL5.040TLSC __ D3	\$ 1,629.	\$ 1,729.
	5" W – 4000K, Dimmable	PL5.040TLSC __ D4	\$ 1,629.	\$ 1,729.
	5" W – Variable, Dimmable	PL5.040TLSC __ DV	\$ 1,799.	\$ 1,899.
Ganging kit required if Profile lights are used with multiple cabinets:	MGKIT			\$ 49.

PMGKIT__ ganging kit required if Profile lights are used with Profiles mirrors – refer to the following page.

Operates on 120 volts AC and 0.5A (2700K/4000K) or 1.0A (variable) per fixture. LEDs are CRI 90+ and dimmable.

Frame Finish Options

Fill in __ designator to Model listed above with desired finish. Example: **PL5.040TLSC76DV**.

- 76 Chrome
- 77 Polished Nickel
- 82 Matte Gold
- 83 Matte Black

See Surface-Mount Kits, Accessories & Options on the following page.

Profiles® Vertical Lighting

Surface-Mount Kits (sold separately)

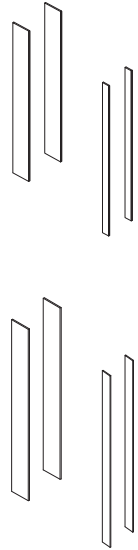

Description	Model	MIRRORED	DECORATIVE		
		Polished Edge	Essentials Palette	Classic Palette	Inspire Palette
		Price	11, 20, 21 Price	22, 26, 27, 28 Price	12, 19, 23, 24, 25 Price
30" H – Quantity 1 = Pair of Side Kits and Mounting Hardware					
D4 Surface-Mount, Polished Edge	MSMK30D4P	\$ 149.	N/A	N/A	N/A
D4 Surface-Mount, Decorative*	MSMK30D4 __	N/A	\$ 199.	\$ 249.	\$ 349.
D6 Surface-Mount, Polished Edge	MSMK30D6P	\$ 199.	N/A	N/A	N/A
D6 Surface-Mount, Decorative*	MSMK30D6 __	N/A	\$ 249.	\$ 349.	\$ 399.
40" H – Quantity 1 = Pair of Side Kits and Mounting Hardware					
D4 Surface-Mount, Polished Edge	MSMK40D4P	\$ 249.	N/A	N/A	N/A
D4 Surface-Mount, Decorative*	MSMK40D4 __	N/A	\$ 349.	\$ 399.	\$ 449.
D6 Surface-Mount, Polished Edge	MSMK40D6P	\$ 349.	N/A	N/A	N/A
D6 Surface-Mount, Decorative*	MSMK40D6 __	N/A	\$ 399.	\$ 449.	\$ 499.

Surface-Mount Kit Color Options

*Fill in __ designator to Decorative Model listed above with desired color. Example: **MSMK30D620**.

Essentials Palette

- 11 Tinted Gray Mirror
- 20 Black
- 21 White

Classic Palette

- 22 Beach
- 26 Matte White
- 27 Matte Gray
- 28 Matte Black

Inspire Palette

- 12 Satin Bronze
- 19 Satin White
- 23 Ocean
- 24 Smoke Screen
- 25 Silver Screen

Add-On Accessories & Options

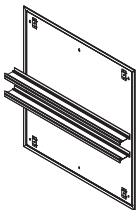

Description	Model	Price
Profiles Mirror/Lighting Ganging Kit		
Hardware required for ganging Profiles Mirrors with Profiles Lighting and Cabinets		
24x30	PMGKIT2430	\$ 399.
30x30	PMGKIT3030	\$ 449.
36x30	PMGKIT3630	\$ 499.
24x40	PMGKIT2440	\$ 399.
30x40	PMGKIT3040	\$ 449.
36x40	PMGKIT3640	\$ 499.

SEE PAGE 146 FOR TIPS AND FEATURES.

InLine Vertical Lighting – Table of Contents, Tips & Features

Table of Contents

Vertical Lighting Ganging Reference 141 – 142

InLine Vertical Lighting 151

Tips & Features

Dimensions & Weight

- Width: 3-1/2" (89 mm)
- Height: 30" (762 mm), 39-3/8" (1000 mm)
- Depth: 4-5/8" (117 mm) surface-mount, 7/8" (22 mm) when recessed
- Net Weight: 10 – 15 lbs

Features & Benefits

- Seamless and flush aesthetic that can be ganged with medicine cabinets
- Choose between warm, relaxing tones (3000K) that replicate indoor lighting and cool, invigorating tones (4000K), which simulate bright daylight or choose variable lighting that lets you fine-tune your color temperature between warm (3000K) and cool (4000K) tones with the use of dimmers
- Light direction and output eliminate dark shadows, provides bright even task lighting and rich, saturated tone in your reflection
- Remarkably accurate color rendering with a CRI value of 90+ and R9 of 50+, so you can see your truest reflection
- Dimmable LED task lighting to 1% lets you select the ideal brightness for any task, using a standard residential dimmer that works with your home's existing wiring
- Modular vertical lighting can be ganged with M Series and PL Series cabinets
- Energy efficient LEDs with an estimated life of 53,000 hours
- Constructed to operate in high humidity or damp spaces. ETL/UL Certified for damp locations to UL 1598 CSA Standard C22.2 No. 250.0

Configurable Options

- Color Temperature: 3000K, 4000K, Variable (3000K – 4000K)

Construction

- Durable rust-free anodized aluminum and glass construction – resists intense moisture, ensures long-lasting beauty
- Satin anodized aluminum body

Installation

- This installation may require more than one person
- Sold as a single unit (not as pairs)
- Fixture adds 3-1/2" per light to the overall rough-in width
- Can be recessed or surface-mounted with 4" depth (D4) cabinets (D4 surface-mount kit required) and fully recessed with 6" depth (D6) and 8" depth (D8) cabinets
- Ganging kit required if used to mount with multiple cabinets – light comes with ganging hardware on one side
- Operates on 120 volts AC and 0.5A (3000K/4000K) or 1.0A (variable) per fixture
- Glass lens plane sits flush when paired with an M Series or PL Series cabinet
- Wired internally – front access serviceability
- MGKIT includes hardware to gang to both sides of a cabinet. As a result, three lights and two cabinets can be ganged together from one MGKIT.
- Recommended dimmer for InLine fixture: Lutron® C•L Dimmers. This dimmer has full range control, low light adjustment, stops flickering and last setting memory.

Accessories

- Ganging Kit (MGKIT)
- Surface-Mount Kit (MSMK__D_P)
- Semi-Recess Mount Kit (MSMK__D8SRP)

Lighting Specs: Standard InLine

Kelvin	3000K 4000K 3000K – 4000K
CRI	90+
Lumens ¹	369 – 1092
Lumens per Watt	29 – 34
R9 Value ¹	56 – 60

¹ Based on a measurement of a subset of sizes and lighting styles



InLine Vertical Lighting

A tunable LED task lighting solution, InLine lighting provides a seamless and flush aesthetic that can be ganged with medicine cabinets.

- Choose between warm, relaxing tones (3000K) that replicate indoor lighting, cool, invigorating tones (4000K), which simulate bright daylight or variable lighting that allows you to adjust between warm and cool light with the use of dimmers
- Modular lighting can be ganged with M Series and PL Series Cabinets
- Dimmable LED task lighting to 1% lets you select the ideal brightness for any task, using a standard residential dimmer that works with your home's existing wiring



Two Week Lead Time



Dimmable LED



Tunable



Modular

ML3.5 InLine Modular LED Light (Quantity 1 = Single) – M Series & PL Series



Description	For Use With M Series & PL Series	Model	Price
3000K, Dimmable	30" H Cabinets (RO: 2-3/4" W x 29-1/4" H)	ML3.530ILSFMRD3	\$ 849.
4000K, Dimmable	30" H Cabinets (RO: 2-3/4" W x 29-1/4" H)	ML3.530ILSFMRD4	\$ 849.
Variable, Dimmable	30" H Cabinets (RO: 2-3/4" W x 29-1/4" H)	ML3.530ILSFMRDV	\$ 999.
3000K, Dimmable	40" H Cabinets (RO: 2-3/4" W x 38-5/8" H)	ML3.540ILSFMRD3	\$ 949.
4000K, Dimmable	40" H Cabinets (RO: 2-3/4" W x 38-5/8" H)	ML3.540ILSFMRD4	\$ 949.
Variable, Dimmable	40" H Cabinets (RO: 2-3/4" W x 38-5/8" H)	ML3.540ILSFMRDV	\$ 1,149.

Ganging kit required if InLine lights are used with multiple cabinets:

MGKIT \$ 49.

Operates on 120 VAC and 0.5A (3000K/4000K) or 1.0A (variable) per fixture. LEDs are CRI 90 and dimmable.

Surface-Mount Kits (sold separately)

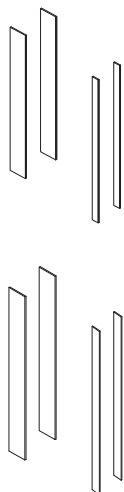

Description	Model	Mirror	Essentials Palette	Classic Palette	Inspire Palette
30" H – Quantity 1 = Pair of Side Kits and Mounting Hardware					
D4 Surface-Mount, Polished Edge	MSMK30D4P	\$ 149.	N/A	N/A	N/A
D4 Surface-Mount, Decorative*	MSMK30D4 __	N/A	\$ 199.	\$ 249.	\$ 349.
D6 Surface-Mount, Polished Edge	MSMK30D6P	\$ 199.	N/A	N/A	N/A
D6 Surface-Mount, Decorative*	MSMK30D6 __	N/A	\$ 249.	\$ 349.	\$ 399.
D8 Semi-Recessed, Polished Edge	MSMK30D8SRP	\$ 149.	N/A	N/A	N/A
D8 Semi-Recessed, Decorative*	MSMK30D8SR __	N/A	\$ 199.	\$ 249.	\$ 349.
40" H – Quantity 1 = Pair of Side Kits and Mounting Hardware					
D4 Surface-Mount, Polished Edge	MSMK40D4P	\$ 249.	N/A	N/A	N/A
D4 Surface-Mount, Decorative*	MSMK40D4 __	N/A	\$ 349.	\$ 399.	\$ 449.
D6 Surface-Mount, Polished Edge	MSMK40D6P	\$ 349.	N/A	N/A	N/A
D6 Surface-Mount, Decorative*	MSMK40D6 __	N/A	\$ 399.	\$ 449.	\$ 499.
D8 Semi-Recessed, Polished Edge	MSMK40D8SRP	\$ 249.	N/A	N/A	N/A
D8 Semi-Recessed, Decorative*	MSMK40D8SR __	N/A	\$ 349.	\$ 399.	\$ 449.

Surface-Mount Kit Color Options

*Fill in __ designator to Model listed above with desired color. Example: **MSMK40D620**.

Essentials Palette

- 11 Tinted Gray Mirror
- 20 Black
- 21 White

Classic Palette

- 22 Beach
- 26 Matte White
- 27 Matte Gray
- 28 Matte Black

Inspire Palette

- 12 Satin Bronze
- 19 Satin White
- 23 Ocean
- 24 Smoke Screen
- 25 Silver Screen

Note: Models in **bold** indicate Quick Ship product.

SEE PAGE 150 FOR TIPS AND FEATURES.

1.5 Series Vertical Lighting – Table of Contents, Tips & Features

Table of Contents

Vertical Lighting Ganging Reference 141 – 142

M Series & PL Series 1.5 Series Vertical Lighting 153

Tips & Features

Dimensions & Weight

- Width: 1-1/2" (38 mm)
- Height:
30" (762 mm)
39-3/8" (1000 mm)
- Depth: 2-1/8" (54 mm)
- Net Weight: 11 lbs

Features & Benefits

- A choice between glass or acrylic lens
- End caps:
Chrome or Brushed Nickel for M Series
White, Chrome or Black for PL Series
- Dimmable ballast and non-dimmable ballast options
- Includes 3000K T8, color-corrected bulbs for optimal task lighting
- Works with surface-mount or recessed applications
- Title 24 compliant when used with a Title 24 certified bulb (certified bulb not included)
- UL listed for damp locations
- Will operate in high humidity or damp spaces.
ETL certified to UL 1598
CSA Standard C22.2 No. 250.0

Installation

- This installation may require more than one person
- Two lights per kit includes: 3,000K T-8 color corrected bulb, dimmable electronic ballast and choice of glass or acrylic shade and end cap finishes
- Dimmable bulbs carry a lifetime bulb replacement warranty
- Not available as a half kit. Two fixtures required for installation.
- Single light is 1-1/2" W. Light kit adds 3" to overall width of installation. Include this in rough opening calculation.
- Recommended dimmer: Lightolier – Sunrise Series, Model # ZP600-EB or the Lutron[®], Model# DVFTU-5A3P (4 sets of lights can go on one dimmer). Light uses the advanced Mark X ballast.
- 40" H = 25 watts each bulb (Model BULBFL3602);
30" H = 17 watt each bulb (Model BULBFL2402).
Bulbs are included. Two bulbs per pack.
- Ganging kit required if used to mount with multiple cabinets and comes with 1 pair to gang two sides of a cabinet
- The Master-to-Remote Cable is included with the fixture, but is sold separately for rough-in (6-foot limit for distance)

Accessories

- Ganging Kit (1.5GKIT)
- Master-to-Remote Cable (MFL1.5CABL)



1.5 Series Vertical Lighting – M Series & PL Series

With a sleek style and a modular design, 1.5 Series lighting simplifies the styling experience.

- A choice between glass or acrylic lens
- End caps are available in Chrome, Brushed Nickel, White or Black
- Dimmable or non-dimmable ballast options



Two Week
Lead Time



Dimming



Modular



ML1.5 Modular Vertical Fluorescent Light Kits – M Series

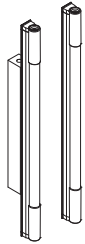

Description	For Use With M Series	Chrome End Caps	Brushed Nickel End Caps	Price
Glass Shade – Dimmable	30" H Cabinets	ML1.530VFSGCRDN	ML1.530VFSGBNDN	\$ 1,329.
Acrylic Shade – Dimmable	30" H Cabinets	ML1.530VFSACRDN	ML1.530VFSABNDN	\$ 1,049.
Glass Shade – Dimmable	40" H Cabinets	ML1.540VFSGCRDN	ML1.540VFSGBNDN	\$ 1,479.
Acrylic Shade – Dimmable	40" H Cabinets	ML1.540VFSACRDN	ML1.540VFSABNDN	\$ 1,179.

Ganging kit required if vertical fluorescent lights are used with multiple cabinets:

1.5GKIT

\$ 49.

Master-to-Remote Cable*

MFL1.5CABL

\$ 99.

*The cable is included with the fixture but is sold separately for rough-in.

Title 24 compliant when used with a Title 24 certified bulb (certified bulb not included).

PL30_/PL40_ 1.5 Vertical Fluorescent Light Kits – PL Series

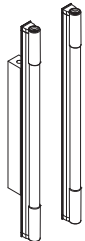

Description	For Use With PL Series	White End Caps	Chrome End Caps	Black End Caps	Price
Glass Shade – Dimmable	30" H Cabinets	PL30GWH	PL30GCH	PL30GBL	\$ 1,329.
Acrylic Shade – Dimmable	30" H Cabinets	PL30PWH	PL30PCH	PL30PBL	\$ 1,049.
Acrylic Shade – Non-Dimmable	30" H Cabinets	PL30PWHN	PL30PCHN	PL30PBLN	\$ 849.
Glass Shade – Dimmable	40" H Cabinets	PL40GWH	PL40GCH	PL40GBL	\$ 1,479.
Acrylic Shade – Dimmable	40" H Cabinets	PL40PWH	PL40PCH	PL40PBL	\$ 1,179.

Ganging kit required if vertical fluorescent lights are used with multiple cabinets:

1.5GKIT

\$ 49.

Title 24 compliant when used with a Title 24 certified bulb (certified bulb not included).



Note: Models in **bold** indicate Quick Ship product.

SEE PAGE 152 FOR TIPS AND FEATURES.

Uplift® Lighting – Table of Contents, Tips & Features

Table of Contents

Uplift® Lighting 155

Tips & Features

Uplift Pendant: Dimensions & Weight

- Width: 6-1/2" (165 mm)
- Height: 16-3/4" (426 mm)
- Net Weight: 4 lbs

Uplift Pendant: Features & Benefits

- Sleek and minimalist in style, warm and inviting in use
- Night Light provides a soft, warm glow that allows you to use the space safely at night
- Title 24 California energy code compliant
- Constructed to operate in high humidity or damp spaces. ETL/UL Certified for damp locations

Uplift Pendant: Configurable Options

- Metal Finishes:
Anodized Aluminum, Polished Chrome, Brushed Nickel, Polished Nickel

Uplift Pendant: Installation

- Ceiling mounted
- Sold as a single unit – bulbs not included
- Recommended Bulbs – Robern's 24W, 3000K, 2G11 base (X219-1145) or Philips PL-L24W/830/4D or Sylvania FT24DL/830/ECO

Uplift Sconce: Dimensions & Weight

- Width: 3" (76 mm)
- Height: 22" (559 mm)
- Depth: 4" (102 mm)
- Net Weight: 4 lbs

Uplift Sconce: Features & Benefits

- Sleek and minimalist in style, warm and inviting in use
- Night Light provides a soft, warm glow that allows you to use the space safely at night
- Title 24 California energy code compliant
- Constructed to operate in high humidity or damp spaces. ETL/UL Certified for damp locations

Uplift Sconce: Configurable Options

- Metal Finishes:
Anodized Aluminum, Polished Chrome, Brushed Nickel, Polished Nickel

Uplift Sconce: Installation

- Sold as a single unit – bulbs not included
- Recommended Bulbs – Robern's 24W, 3000K, 2G11 base (X219-1145) or Philips PL-L24W/830/4D or Sylvania FT24DL/830/ECO



Uplift® Lighting



A sleek and minimalist lighting solution, Uplift pendant and sconce provides both task and night light; available in four metal finishes.

- Available in Anodized Aluminum, Chrome, Brushed Nickel and Polished Nickel
- Night light provides a soft, warm glow that allows you to use the space safely at night
- Sold as a single unit; bulb not included



Two Week Lead Time



Night Light

Uplift Pendant with Night Light – 6-1/2" x 16-3/4" H

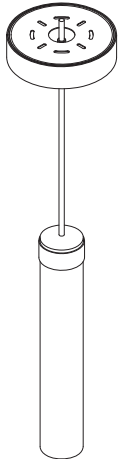

Description	For Use With	Model	Price
Anodized Aluminum Finish	All Cabinets	UFLPAL	\$ 729.
Polished Chrome Finish	All Cabinets	UFLPCRL	\$ 849.
Brushed Nickel Finish	All Cabinets	UFLPBNL	\$ 849.
Polished Nickel Finish	All Cabinets	UFLPPNL	\$ 849.
Bulb: 24W, 3000K, 2G11 base	Uplift Lighting	X219-1145	\$ 99.

Recommended Bulbs – available online and in most lighting supply stores:
Philips PL-L24W/830/4D or Sylvania FT24DL/830/ECO

Title 24 compliant when used with a Title 24 certified bulb (certified bulb not included).

Uplift Sconce with Night Light – 3" W x 22" H x 4" D

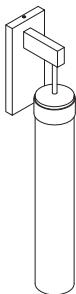

Description	For Use With	Model	Price
Anodized Aluminum Finish	All Cabinets	UFLWAL	\$ 729.
Polished Chrome Finish	All Cabinets	UFLWCRL	\$ 849.
Brushed Nickel Finish	All Cabinets	UFLWBNL	\$ 849.
Polished Nickel Finish	All Cabinets	UFLWPNL	\$ 849.
Bulb: 24W, 3000K, 2G11 base	Uplift Lighting	X219-1145	\$ 99.

Recommended Bulbs – available online and in most lighting supply stores:
Philips PL-L24W/830/4D or Sylvania FT24DL/830/ECO

Title 24 compliant when used with a Title 24 certified bulb (certified bulb not included).

Note: Models in **bold** indicate Quick Ship product.

SEE PAGE 154 FOR TIPS AND FEATURES.

Main Line Sconce

Tips & Features

Dimensions & Weight

- Width: 3-1/8" (79 mm)
- Height: 10-1/4" (260 mm)
- Depth: 3-3/4" (95 mm)
- Net Weight: 4 lbs

Features & Benefits

- Add style, sophistication and light to your space
- Base fixture available in Chrome and Polished Nickel
- Title 24 California energy code compliant
- Constructed to operate in high humidity or damp spaces. ETL/UL Certified for damp locations

Configurable Options

- Metal Finishes:
Chrome, Polished Nickel

Installation

- Sold as a single unit – bulbs not included
- Recommended for grooming tasks: a 2700K, 26W or 18W 4-pin compact fluorescent bulb



Designed to be the perfect coordinating lighting solution, Main Line sconces allow you to choose from two metal finish options to deliver a dramatic impact to any part of your home.

- Add style, sophistication and light to your space
- Base fixture available in Chrome and Polished Nickel to coordinate with fixtures in your space
- Sold as a single unit; bulb not included

Main Line Sconce – 3-1/8" W x 10-1/4" H x 3-3/4" D

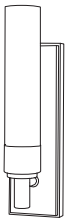

Description	For Use With	Model	Price
Frosted Shade, Chrome Finish	All Cabinets	DLFML76	\$ 729.
Frosted Shade, Polished Nickel Finish	All Cabinets	DLFML77	\$ 729.

Recommended for grooming tasks: a 2700 K, 26W or 18W 4-pin compact fluorescent bulb.
Title 24 compliant when used with a Title 24 certified bulb (certified bulb not included).

Note: Models in **bold** indicate Quick Ship product.

AiO® Lighted Mirrors – Table of Contents, Tips & Features

Table of Contents

AiO Lighted Mirrors 166

Tips & Features

Dimensions & Weight

- Width:
23-1/8" (587 mm)
29-1/8" (740 mm)
35-1/8" (892 mm)
- Height:
29-7/8" (759 mm)
39-1/4" (997 mm)
69-7/8" (1775 mm)
- Depth: 1-1/2" (38 mm)
- Net Weight: 45 – 75 lbs

Features & Benefits

- OM[®] Audio: built-in speakers with a range up to 30 feet with a 2 channel stereo at 20 watts/channel. Bluetooth connectivity supports most Android and iOS devices. Volume controlled by device
- LUM[®] Lighting: Integrated dimmable LED lights and one-touch lighting control with capacitive-touch switch built into the mirror
- Choose between warm, relaxing tones (2700K) that replicate indoor lighting or cool, invigorating tones (4000K), which simulate bright daylight
- Light direction and output eliminates dark shadows, provides bright even task lighting and rich, saturated tone in your reflection
- Remarkably accurate color rendering with a CRI value of 90+ and R9 of 50+, so you can see your truest reflection
- Dimmable lighting lets you select the ideal brightness for any task, using a standard dimmer that works with existing wiring
- Energy efficient LEDs with an estimated life of 53,000 hours
- Includes two USB charging ports
- Constructed to operate in high humidity or damp spaces. ETL certified to UL 1598, CSA Standard C22.2, No. 250.0

Configurable Options

- Audio: OM audio or non-audio version
- Color Temperature: 2700K or 4000K

Construction

- Durable rust-free anodized aluminum and glass construction – resists intense moisture, ensures long-lasting beauty
- Powder coated steel back frame
- Quality polished edge mirror
- Constructed for surface mounting
- Salt Spray Testing: ASTM Standard for 300 hours performed to test mirror quality against desilvering and degradation resulting from environmental exposure
- Secure placement: Independent lab testing of mirror and frame mounting to ensure that it meets the standard for safety

Installation

- Installation may require more than one person
- Single field wire installation; hardwire to a wall or a switch (120 VAC 60 Hz 1.2A)
- 1/2" conduit (7/8" actual) electrical knockout
- Includes installation hardware with easy installation via Pinch Cleat Mounting System and back pan design for easy wiring
- Hang in portrait orientation only

Lighting Specs

Kelvin	2700K 4000K
CRI	90+
Lumens ¹	1250
Lux ^{1, 2}	710
R9 Value ¹	50+
Foot-candles ^{1, 2}	66

¹ Measured on a 24" W x 30" H model

² Measured at 18" from center of the mirror

Efficacy (LED Source)

Watts per Foot	8.8
Lumens per Foot	610
Lumens per Watt	69



AiO® Lighted Mirrors



For a mirror with a minimalist aesthetic that provides the perfect task lighting and is easy to use, our AiO Lighted Mirror combines warm or cool task lighting, integrated USB ports and fine-tuned audio capability for a connected experience in your styling space.

- **OM® Audio:** built-in speakers with Bluetooth connectivity supports most Android and iOS devices. Volume controlled by device
- **LUM® Lighting:** integrated dimmable LED lights and one-touch lighting control with capacitive-touch switch built into the mirror
- Choose between warm, relaxing tones (2700K) that replicate indoor lighting or cool, invigorating tones (4000K), which simulate bright daylight



Two Week Lead Time



Audio/Bluetooth®



USB Charging



Dimmable LED

AiO Lighted Mirrors

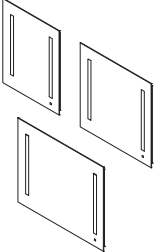
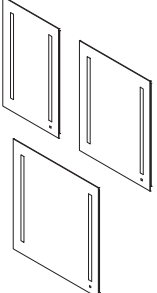
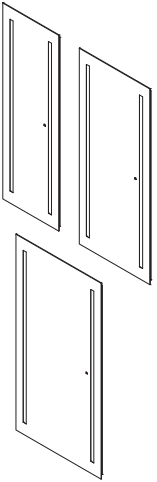
Description	2700K	4000K	Price	2700K With Audio	4000K With Audio	Price
AiO 30" H Mirrors						
 23-1/8" W x 29-7/8" H x 1-1/2" D	AM2430RFPW	AM2430RFP	\$ 1,479.	AM2430RFPW	AM2430RFP	\$ 1,899.
29-1/8" W x 29-7/8" H x 1-1/2" D	AM3030RFPW	AM3030RFP	\$ 1,649.	AM3030RFPW	AM3030RFP	\$ 2,099.
35-1/8" W x 29-7/8" H x 1-1/2" D	AM3630RFPW	AM3630RFP	\$ 1,829.	AM3630RFPW	AM3630RFP	\$ 2,299.
AiO 40" H Mirrors						
 23-1/8" W x 39-1/4" H x 1-1/2" D	AM2440RFPW	AM2440RFP	\$ 1,749.	AM2440RFPW	AM2440RFP	\$ 2,199.
29-1/8" W x 39-1/4" H x 1-1/2" D	AM3040RFPW	AM3040RFP	\$ 1,899.	AM3040RFPW	AM3040RFP	\$ 2,379.
35-1/8" W x 39-1/4" H x 1-1/2" D	AM3640RFPW	AM3640RFP	\$ 2,099.	AM3640RFPW	AM3640RFP	\$ 2,579.
AiO Full Length Mirrors						
 23-1/8" W x 69-7/8" H x 1-1/2" D	N/A	AM2470RFP	\$ 3,199.	N/A	N/A	N/A
29-1/8" W x 69-7/8" H x 1-1/2" D	N/A	AM3070RFP	\$ 3,429.	N/A	N/A	N/A
35-1/8" W x 69-7/8" H x 1-1/2" D	N/A	AM3670RFP	\$ 3,649.	N/A	N/A	N/A

 **Note:** Models in **bold** indicate Quick Ship product.

SEE PAGE 165 FOR TIPS AND FEATURES.

Sculpt™ Lighted Mirrors – Table of Contents, Tips & Features

Table of Contents

Sculpt Lighted Mirrors 169

Tips & Features

Dimensions & Weight

- Slim Museum (W x H):
25-1/4" x 31-1/4" (641 mm x 794 mm)
25-1/4" x 41-1/4" (641 mm x 1048 mm)
31-1/4" x 41-1/4" (794 mm x 1048 mm)
- Chamfer Museum (W x H):
27" x 33" (686 mm x 838 mm)
27" x 43" (686 mm x 1092 mm)
33" x 43" (838 mm x 1092 mm)
- Frame Depth:
Slim Museum = 2-1/4" (57 mm)
Chamfer Museum = 2-5/16" (59 mm)
- Net Weight: 28 – 40 lbs

Features & Benefits

- An assortment of styles and sizes to accentuate and meet the needs of a variety of styling spaces
- Museum frames showcase a 3/8" gap between the edge of the mirror and the overall frame. The lighting and gap work together to create an even, uniformed illumination across the frame and finishes while providing ambiance and task lighting
- Museum frames include two frame styles:
Slim and Chamfer
Slim Museum Frame: for a shadow box effect and to complement a modern aesthetic, the sleek profile creates a minimalist look
Chamfer Museum Frame: the angled design adds dimension for a unique look that pairs well with transitional and traditional environments
- Match or coordinate fixtures in your styling space with four popular metal frame finishes:
Chrome, Polished Nickel, Matte Gold, Matte Black
- Create a coordinated ensemble by pairing with Profiles Vanities
- Warm, relaxing tones (2700K) that replicate indoor lighting
- Light direction and output eliminates dark shadows, provides bright, even task lighting and rich, saturated tone in your reflection

Features & Benefits (Continued)

- Remarkably accurate color rendering with a CRI value of 90+ and R9 of 50+, so you can see your truest reflection
- Dimmable LED task lighting lets you select the ideal brightness for any task, using a standard dimmer that works with existing wiring. The mirror's LED task lighting provides continuously dimmable brightness to 1%
- Defogging technology ensures a clear reflection using a standard wall switch
- Energy efficient LEDs with an estimated life of 53,000 hours
- Compatible with most Triac/Phase-cut dimmers
- Constructed to operate in high humidity or damp spaces. UL Certified for damp locations to UL 962, CSA Standard C22.2

Title 24 Compliant Models

- LED mirror models (K) tested and certified to California Title 24 standards and meet JA8 2016 requirements
- The Title 24 certified LED mirror has up to 60% more lumen output than the standard model. This increases the overall brightness of warm white light that illuminates your space and reflection
- The mirror's LED task lighting exceeds Title 24 requirements (< 10% minimum dimming level) with continuously dimmable brightness to 1%
- Vacancy and dimmer recommendation:
Maestro C•L Dimmer and Motion Sensor

Configurable Options

- Mirror Style:
Perimeter Rectangle, Title 24 Perimeter Rectangle
- Frame Styles: Slim Museum, Chamfer Museum
- Metal Frame Finishes:
Chrome, Polished Nickel, Matte Gold, Matte Black



Sculpt™ Lighted Mirrors – Tips & Features

Tips & Features (Continued)

Construction

- Frame Construction:
Plated Chrome and Polished Nickel finishes provide easy upkeep, exceptional durability, and a timeless look that complements any design
Anodized Matte Gold and Matte Black finish options are easy to maintain and won't chip, peel, or fade – so you can enjoy their beauty for years to come
- Durable rust-free anodized aluminum and glass construction – resists intense moisture, ensuring long-lasting beauty
- Quality polished edge mirror
- Constructed for surface mounting
- Salt Spray Testing: ASTM Standard for 300 hours performed to test mirror quality against desilvering and degradation resulting from environmental exposure
- Secure placement: Independent lab testing of mirror and frame mounting to ensure that it meets the standard for safety

Installation

- This installation may require more than one person
- Includes installation hardware with easy installation via Plug and Hang System:
Install mirror by plugging into an outlet behind the mirror, eliminating the need to bring back an electrician to install or remove – making it a cinch for both new construction and renovations.
Works in all North American outlets
Hang the mirror using a pinch cleat mounting system, which provides strength and simplicity to the installation process
- Requires 120 VAC 20 amp GFCI circuit protected wall outlet (configured as detailed in installation instructions)
- Mirror functions (lighting, defogger) operated using standard residential dimmers and switches, available separately through electrical supply and home improvements centers
- Dimmer recommendation:
C•L® Dimmers or Caseta Wireless from LUTRON®
- For on/off (no dimmer) operation, a standard wall switch may be substituted in place of the dimmer
- Hang in portrait orientation only

Lighting Specs: Standard Sculpt

Kelvin	2700K
CRI	90+
Lumens ¹	746 – 1488
Lux ^{1, 2}	275 – 690
R9 Value ¹	50+
Foot-candles ^{1, 2}	26 – 64

¹ Based on a measurement of a subset of sizes, shapes and lighting styles

² Measured at 18" from center of the mirror

Efficacy (LED Source)

Watts per Foot	3 – 6
Lumens per Foot	170 – 400
Lumens per Watt	68

Lighting Specs: Title 24 Sculpt

Kelvin	2700K
CRI	90+
Lumens	3071
Lux ²	345
R9 Value	50+
Foot-candles ²	32

¹ Measured on a 36" W x 40" H model

² Measured at 18" from center of the mirror



Sculpt™ Lighted Mirrors



The sophisticated interplay of premium task lighting and museum frames makes the Sculpt Lighted Mirror an undeniably exquisite focal point in a variety of styling spaces.

- An assortment of styles and sizes to accentuate and meet the needs of a variety of styling spaces
- Museum frames showcase the lighted mirror by featuring a gap between the edge of the mirror and the overall frame. This kind of precision design allows for even task lighting, high CRI and lumen output so you still see your truest reflection
- Smooth and continuous dimming from standard LED dimmers and defogging via standard wall switch



Two Week Lead Time



Defogger



Dimmable LED



Title 24 Compliant

Sculpt Lighted Mirrors

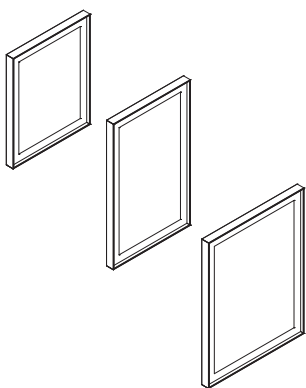
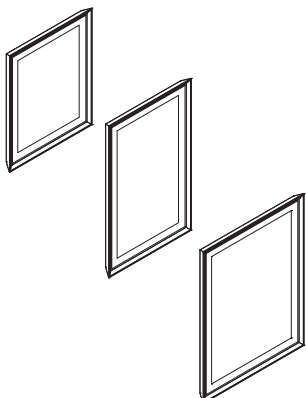
Description	Model	FRAME FINISHES	
		76, 77 Price	82, 83 Price
Slim Museum Frame: Rectangle – Perimeter			
 25-1/4" W x 31-1/4" H x 2-1/4" D	YM2531RPSMD3 __	\$ 1,129.	\$ 1,229.
Title 24 – 25-1/4" W x 31-1/4" H x 2-1/4" D	YM2531RPSMD3K __	\$ 1,229.	\$ 1,329.
25-1/4" W x 41-1/4" H x 2-1/4" D	YM2541RPSMD3 __	\$ 1,329.	\$ 1,599.
Title 24 – 25-1/4" W x 41-1/4" H x 2-1/4" D	YM2541RPSMD3K __	\$ 1,449.	\$ 1,699.
31-1/4" W x 41-1/4" H x 2-1/4" D	YM3141RPSMD3 __	\$ 1,479.	\$ 1,729.
Title 24 – 31-1/4" W x 41-1/4" H x 2-1/4" D	YM3141RPSMD3K __	\$ 1,549.	\$ 1,799.
Chamfer Museum Frame: Rectangle – Perimeter			
 27" W x 33" H x 2-5/16" D	YM2733RPCMD3 __	\$ 1,499.	\$ 1,749.
Title 24 – 27" W x 33" H x 2-5/16" D	YM2733RPCMD3K __	\$ 1,599.	\$ 1,849.
27" W x 43" H x 2-5/16" D	YM2743RPCMD3 __	\$ 1,699.	\$ 1,949.
Title 24 – 27" W x 43" H x 2-5/16" D	YM2743RPCMD3K __	\$ 1,799.	\$ 2,049.
33" W x 43" H x 2-5/16" D	YM3343RPCMD3 __	\$ 1,829.	\$ 2,099.
Title 24 – 33" W x 43" H x 2-5/16" D	YM3343RPCMD3K __	\$ 1,899.	\$ 2,149.

Frame Finish Options

Fill in __ designator to Model listed above with desired finish. Example: YM3040RPSMD3K76.

- 76 Chrome
- 77 Polished Nickel
- 82 Matte Gold
- 83 Matte Black

MIRRORS

SEE PAGES 167 – 168 FOR TIPS AND FEATURES.

Profiles® Framed Mirrors – Table of Contents, Tips & Features

Table of Contents

Profiles Framed Mirrors	171
Profiles Framed Cabinets	57 – 77
Profiles Lighting Options	146 – 149

Tips & Features

Dimensions & Weight

- Width:
23-1/8" (587 mm)
29-7/8" (759 mm)
35-7/8" (911 mm)
- Height:
29-7/8" (759 mm)
39-1/4" (997 mm)
- Depth: 3/4" (19 mm);
15/16" (24 mm) when ganged with
vertical lighting or medicine cabinets
- Net Weight: 12 – 21 lbs

Features & Benefits

- Match all fixtures in your styling space with Profiles metal frame finishes for a coordinated look: Chrome, Polished Nickel, Matte Gold, Matte Black
- Modular mirrors can be ganged with Profiles Lighting and Profiles Medicine Cabinets with optional ganging kit
- Pair with Profiles Medicine Cabinets when storage is needed and Profiles Lighting to create task lighting in your styling space
- Create a coordinated ensemble by pairing with Profiles Medicine Cabinets, Profiles Lighting and Profiles Vanities

Configurable Options

- Metal Frame Finishes:
Chrome, Polished Nickel, Matte Gold, Matte Black

Construction

- Durable rust-free anodized aluminum and glass construction – resists intense moisture, ensures long-lasting beauty
- Constructed for surface mounting

Installation

- This installation may require more than one person
- Includes installation hardware with easy installation via Pinch Cleat Mounting System
- For ganging with Profiles Medicine Cabinets or Profiles Lighting, a mirror ganging kit is needed to ensure flush alignment
- If ganging with Profiles Lighting, the existing ganging feature found on one side will need to be removed and the mirror ganging kit (PMGKIT – sold separately) will need to be installed
- Hang in portrait orientation only

Accessories

- Ganging Kit (PMGKIT___)



Profiles® Framed Mirrors



Put the finishing touches on your ensemble with a Profiles Mirror in coordinating metal finishes, and add Profiles lighting to create a stylish and functional getting-ready space. Profiles mirrors are available in portrait orientation but can easily be ganged together, or connected to a Profiles medicine cabinet, to extend their visual impact.

- Match all fixtures in your styling space with Profiles metal frame finishes for a coordinated look: Chrome, Polished Nickel, Matte Gold, Matte Black
- Modular mirrors can be ganged with Profiles lighting and Profiles medicine cabinets with optional ganging kit
- Pair with Profiles medicine cabinets when storage is needed and Profiles lighting to create task lighting in your styling space



Two Week
Lead Time



Modular

Profiles Wall Mirrors

	Description	Model	FRAME FINISHES	
			76, 77 Price	82, 83 Price
Profiles 30" H Mirrors				
	23-1/8" W x 29-7/8" H x 3/4" D	PM2430T __	\$ 1,079.	\$ 1,179.
	29-7/8" W x 29-7/8" H x 3/4" D	PM3030T __	\$ 1,099.	\$ 1,229.
	36" W x 29-7/8" H x 3/4" D	PM3630T __	\$ 1,229.	\$ 1,329.
Profiles 40" H Mirrors				
	23-1/8" W x 39-1/4" H x 3/4" D	PM2440T __	\$ 1,179.	\$ 1,329.
	29-7/8" W x 39-1/4" H x 3/4" D	PM3040T __	\$ 1,279.	\$ 1,399.
	36" W x 39-1/4" H x 3/4" D	PM3640T __	\$ 1,399.	\$ 1,529.

MIRRORS

Frame Finish Options

Fill in __ designator to Model listed above with desired finish. Example: PM2430T77.

76 Chrome

77 Polished Nickel

82 Matte Gold

83 Matte Black

Add-On Accessories & Options

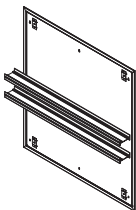

Description	Model	Price
Profiles Mirror/Lighting Ganging Kit		
Hardware required for ganging Profiles Mirrors with Profiles Lighting and Cabinets		
24x30	PMGKIT2430	\$ 399.
30x30	PMGKIT3030	\$ 449.
36x30	PMGKIT3630	\$ 499.
24x40	PMGKIT2440	\$ 399.
30x40	PMGKIT3040	\$ 449.
36x40	PMGKIT3640	\$ 499.

SEE PAGE 170 FOR TIPS AND FEATURES.

Vitality® Lighted Mirrors – Table of Contents, Tips & Features

Table of Contents

Vitality Lighted Mirrors **174 – 176**
 Rectangle 174 – 176
 Circle 176
Vitality Cabinets **53 – 56**

Tips & Features

Dimensions & Weight

- Width:
 24" (610 mm)
 30" (762 mm)
 36" (914 mm)
 48" (1219 mm)
- Height/Diameter:
 30" (762 mm)
 36" (914 mm)
 40" (1016 mm)
- Title 24 Dimensions (W x H):
 24" x 30" (610 mm x 762 mm)
 24" x 40" (610 mm x 1016 mm)
 30" x 40" (762 mm x 1016 mm)
 36" x 40" (914 mm x 1016 mm)
- Depth: 1-3/4" (44 mm)
- Net Weight: 23 – 39 lbs

Features & Benefits

NEW!

- Two new light patterns: Glow and Edge Lit
 With Glow no light comes through the glass (mirrored front) creating a glowing effect on the edges of the mirror and illuminating the wall. This effect creates a silhouette, emphasizes the mirror making it the focal point and contributes ambient lighting to the space.
 Edge Lit provides both task lighting and ambiance. Light emits from the front edges to properly illuminate your face and glows out the edge of the mirror for a soft wall effect. This light pattern is often chosen for ADA applications because no light bar obstructs the reflection of a seated viewer.
- Choose between warm, relaxing tones (2700K) that replicate indoor lighting or cool, invigorating tones (4000K), which simulate bright daylight

Features & Benefits (Continued)

- Light direction and output eliminates dark shadows, provides bright, even task lighting and rich, saturated tone in your reflection
- Dimmable LED task lighting lets you select the ideal brightness for any task, using a standard dimmer that works with existing wiring. The mirror's LED task lighting provides continuously dimmable brightness to 1%
- Defogging technology ensures a clear reflection using a standard wall switch
- Energy efficient LEDs with an estimated life of 53,000 hours
- Flip Installation: the 48" x 36" mirror can be flipped to 36" x 48" to give two size options for a home. By purchasing this mirror option, you not only get the choice to pick the size that meets your needs, it gives you the freedom to change orientation later.
- Compatible with most Triac/Phase-cut dimmers; 0-10V for custom projects
- Constructed to operate in high humidity or damp spaces. ETL/UL Certified for damp locations to UL 962, CSA Standard C22.2, No. 12-82

Title 24 Compliant Models

- LED mirror models (K) tested and certified to California Title 24 standards and meet JA8 2016 requirements
- The Title 24 certified LED mirror has up to 60% more lumen output than the standard model. This increases the overall brightness of warm white light that illuminates your space and reflection
- The mirror's LED task lighting exceeds Title 24 requirements (< 10% minimum dimming level) with continuously dimmable brightness to 1%
- Vacancy and dimmer recommendation: Maestro C•L Dimmer and Motion Sensor

For a Framed solution, see pages 167 – 169.



Vitality® Lighted Mirrors – Tips & Features

Tips & Features (Continued)

Configurable Options

- Mirror Styles: Inset Rectangle, Column Rectangle, Perimeter Rectangle, Glow Rectangle, Edge Lit Rectangle, Inset Circle, Perimeter Circle, Title 24 Compliant Perimeter Rectangle
- Color Temperature: 2700K (Perimeter, Glow and Edge Lit, Inset, Column) or 4000K (Inset, Column)

Construction

- Durable rust-free anodized aluminum and glass construction – resists intense moisture, ensures long-lasting beauty
- Anodized aluminum back frame
- Quality polished edge mirror
- Diffuser built into the product eliminating the need for plastic diffusers to be purchased separately
- Fully encased lighting construction eliminating exposed LEDs and electrical components
- Constructed for surface mounting
- Salt Spray Testing: ASTM Standard for 300 hours performed to test mirror quality against desilvering and degradation resulting from environmental exposure
- Secure placement: Independent lab testing of mirror and frame mounting to ensure that it meets the standard for safety

Installation

- Installation may require more than one person
- Includes installation hardware with easy installation via Plug and Hang System:
 - Install mirror by plugging into an outlet behind the mirror, eliminating the need to bring back an electrician to install or remove – making it a cinch for both new construction and renovations. Works in all North American outlets
 - Hang the mirror using a pinch cleat mounting system, which provides strength and simplicity to the installation process
- Requires 120 VAC 20 amp GFCI circuit protected wall outlet (configured as detailed in installation instructions)
- Mirror functions (lighting, defogger) operated using standard residential dimmers and switches, available separately through electrical supply and home improvements centers

Installation (Continued)

- Dimmer recommendation: C•L® Dimmers or Caseta Wireless from LUTRON®
- For on/off (no dimmer) operation, a standard wall switch may be substituted in place of the dimmer

Lighting Specs: Standard Vitality

Kelvin	2700K 4000K
CRI	90+
Lumens ¹	746 – 1488
Lux ^{1, 2}	275 – 690
R9 Value ¹	50+
Foot-candles ^{1, 2}	26 – 64

¹ Based on a measurement of a subset of sizes, shapes and lighting styles

² Measured at 18" from center of the mirror

Efficacy (LED Source)

Watts per Foot	3 – 6
Lumens per Foot	170 – 400
Lumens per Watt	68

Lighting Specs: Title 24 Vitality

Kelvin	2700K
CRI	90+
Lumens	3071
Lux ²	345
R9 Value	50+
Foot-candles ²	32

² Measured at 18" from center of the mirror

³ Based on 36" x 40" Perimeter Vitality Mirror that supports Title 24 Compliance

For a Framed solution, see pages 167 – 169.



Vitality® Lighted Mirrors

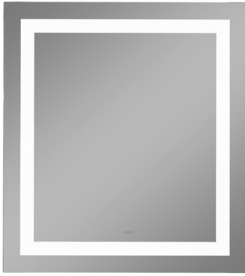

Perfect light is now within reach. The Vitality Lighted Mirror Collection enhances your everyday routine with the highest quality of lighting in its class.

- Choose between two Kelvin ratings to create warm mood lighting or cool, energizing task lighting
- Dimmable lighting lets you select the ideal brightness for any task
- Defogging technology ensures a clear reflection
- Select models tested and certified to California Title 24 standards and meets JA8 2016 requirements



Two Week Lead Time



Defogger



Dimmable LED



Title 24 Compliant

Vitality Lighted Mirrors – Rectangle

	Description	2700K	4000K	Price
Rectangle – Edge Lit NEW! 	24" W x 30" H x 1-3/4" D	YM2430RSFPD3	N/A	\$ 679.
	24" W x 40" H x 1-3/4" D	YM2440RSFPD3	N/A	\$ 729.
	30" W x 40" H x 1-3/4" D	YM3040RSFPD3	N/A	\$ 849.
	36" W x 40" H x 1-3/4" D	YM3640RSFPD3	N/A	\$ 979.
	36" W x 48" H x 1-3/4" D or 48" W x 36" H x 1-3/4" D	FLIP YM4836RSFPD3P	N/A	\$ 1,249.
	Rectangle – Glow Light NEW! 	24" W x 30" H x 1-3/4" D	YM2430RGFPD3	N/A
24" W x 40" H x 1-3/4" D	YM2440RGFPD3	N/A	\$ 729.	
30" W x 40" H x 1-3/4" D	YM3040RGFPD3	N/A	\$ 849.	
36" W x 40" H x 1-3/4" D	YM3640RGFPD3	N/A	\$ 929.	
36" W x 48" H x 1-3/4" D or 48" W x 36" H x 1-3/4" D	FLIP YM4836RGFPD3P	N/A	\$ 1,249.	



Note: Models in **bold** indicate Quick Ship product.

SEE PAGES 172 – 173 FOR TIPS AND FEATURES.

Vitality® Lighted Mirrors

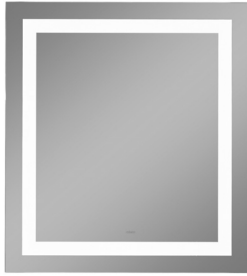

Perfect light is now within reach. The Vitality Lighted Mirror Collection enhances your everyday routine with the highest quality of lighting in its class.

- Choose between two Kelvin ratings to create warm mood lighting or cool, energizing task lighting
- Dimmable lighting lets you select the ideal brightness for any task
- Defogging technology ensures a clear reflection
- Select models tested and certified to California Title 24 standards and meets JA8 2016 requirements



Two Week Lead Time



Defogger



Dimmable LED



Title 24 Compliant

Vitality Lighted Mirrors – Rectangle (Continued)

Description		2700K	4000K	Price	
Rectangle – Column					
	24" W x 30" H x 1-3/4" D	YM2430RCFPD3	YM2430RCFPD4	\$ 579.	
	30" W x 30" H x 1-3/4" D	YM3030RCFPD3	YM3030RCFPD4	\$ 699.	
	36" W x 30" H x 1-3/4" D	YM3630RCFPD3	YM3630RCFPD4	\$ 799.	
	24" W x 40" H x 1-3/4" D	YM2440RCFPD3	YM2440RCFPD4	\$ 629.	
	30" W x 40" H x 1-3/4" D	YM3040RCFPD3	YM3040RCFPD4	\$ 749.	
	36" W x 40" H x 1-3/4" D	YM3640RCFPD3	YM3640RCFPD4	\$ 849.	
	36" W x 48" H x 1-3/4" D or 48" W x 36" H x 1-3/4" D	FLIP YM4836RCFPD3P NEW!	YM4836RCFPD4P NEW!	\$ 1,149.	
	Rectangle – Perimeter				
		24" W x 30" H x 1-3/4" D	YM2430RPFPD3	N/A	\$ 749.
Title 24 – 24" W x 30" H x 1-3/4" D		YM2430RPFPD3K	N/A	\$ 929.	
30" W x 30" H x 1-3/4" D		YM3030RPFPD3	N/A	\$ 849.	
36" W x 30" H x 1-3/4" D		YM3630RPFPD3	N/A	\$ 979.	
24" W x 40" H x 1-3/4" D		YM2440RPFPD3	N/A	\$ 799.	
Title 24 – 24" W x 40" H x 1-3/4" D		YM2440RPFPD3K	N/A	\$ 979.	
30" W x 40" H x 1-3/4" D		YM3040RPFPD3	N/A	\$ 949.	
Title 24 – 30" W x 40" H x 1-3/4" D		YM3040RPFPD3K	N/A	\$ 1,099.	
36" W x 40" H x 1-3/4" D		YM3640RPFPD3	N/A	\$ 1,049.	
Title 24 – 36" W x 40" H x 1-3/4" D	YM3640RPFPD3K	N/A	\$ 1,199.		
36" W x 48" H x 1-3/4" D or 48" W x 36" H x 1-3/4" D	FLIP YM4836RPFPD3P NEW!	N/A	\$ 1,399.		

MIRRORS



Note: Models in **bold** indicate Quick Ship product.

SEE PAGES 172 – 173 FOR TIPS AND FEATURES.

Vitality® Lighted Mirrors

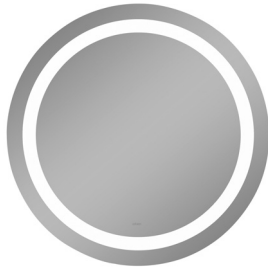

Perfect light is now within reach. The Vitality Lighted Mirror Collection enhances your everyday routine with the highest quality of lighting in its class.

- Choose between two Kelvin ratings to create warm mood lighting or cool, energizing task lighting
- Dimmable lighting lets you select the ideal brightness for any task
- Defogging technology ensures a clear reflection
- Select models tested and certified to California Title 24 standards and meets JA8 2016 requirements



Two Week Lead Time



Defogger



Dimmable LED



Title 24 Compliant

Vitality Lighted Mirrors – Rectangle (Continued)

Description	2700K	4000K	Price
Rectangle – Inset			
	24" W x 30" H x 1-3/4" D	YM2430RIFPD3	YM2430RIFPD4 \$ 799.
	30" W x 30" H x 1-3/4" D	YM3030RIFPD3	YM3030RIFPD4 \$ 899.
	36" W x 30" H x 1-3/4" D	YM3630RIFPD3	YM3630RIFPD4 \$ 1,049.
	24" W x 40" H x 1-3/4" D	YM2440RIFPD3	YM2440RIFPD4 \$ 849.
	30" W x 40" H x 1-3/4" D	YM3040RIFPD3	YM3040RIFPD4 \$ 979.
	36" W x 40" H x 1-3/4" D	YM3640RIFPD3	YM3640RIFPD4 \$ 1,099.
 36" W x 48" H x 1-3/4" D or 48" W x 36" H x 1-3/4" D	FLIP YM4836RIFPD3P NEW!	YM4836RIFPD4P NEW!	\$ 1,449.

Vitality Lighted Mirrors – Circle

Description	2700K	4000K	Price
Circle – Perimeter			
	30" Diameter x 1-3/4" D	YM0030CPFPD3	N/A \$ 849.
	40" Diameter x 1-3/4" D	YM0040CPFPD3	N/A \$ 1,049.
Circle – Inset			
	30" Diameter x 1-3/4" D	YM0030CIFPD3	YM0030CIFPD4 \$ 899.
	40" Diameter x 1-3/4" D	YM0040CIFPD3	YM0040CIFPD4 \$ 1,099.



Note: Models in **bold** indicate Quick Ship product.

SEE PAGES 172 – 173 FOR TIPS AND FEATURES.

Main Line Framed Mirrors – Table of Contents, Tips & Features

Table of Contents

Main Line Framed Mirrors 178

Tips & Features

Dimensions & Weight

- Width:
15-3/8" (391 mm)
19-3/8" (492 mm)
23-3/8" (594 mm)
- Height:
30-1/16" (764 mm)
39-1/2" (1003 mm)
- Depth: 1-5/8" (44 mm)
- Net Weight: 19 – 37 lbs

Features & Benefits

- Available in three uniquely designed frame options: Bryn Mawr®, Merion®, Rosemont®
- Frame options available in six metal finish options
- Pair with Main Line Sconces for a coordinated look

Configurable Options

- Frame Styles:
Bryn Mawr, Merion, Rosemont
- Metal Frame Finishes:
Chrome, Polished Nickel, Satin Nickel,
Brushed Nickel, Brushed Bronze, Brushed Black

Construction

- Durable rust-free anodized aluminum and glass construction – resists intense moisture, ensures long-lasting beauty
- Satin anodized aluminum back frame
- Frame width:
1-3/4" for Bryn Mawr, 2-9/16" for Merion and 13/16" for Rosemont
- Constructed for surface mounting
- Salt Spray Testing: ASTM Standard for 300 hours performed to test mirror quality against desilvering and degradation resulting from environmental exposure
- Secure placement: Independent lab testing of mirror and frame mounting to ensure that it meets the standard for safety

Installation

- This installation may require more than one person
- Supplied with concealed mounting hardware
- Hang in portrait orientation

Frame Details & Dimensions

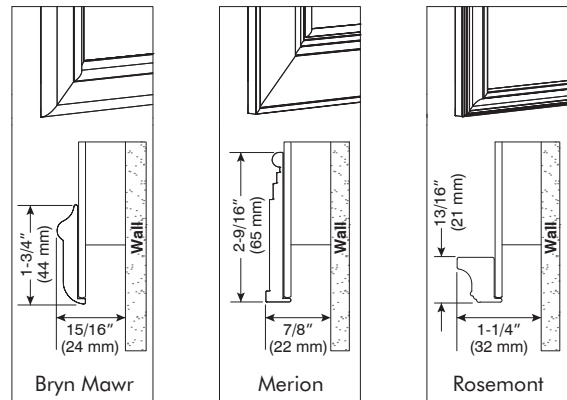

Main Line Framed Mirrors



Available in three distinct frame styles and six metal finishes, Main Line framed mirrors ensure that you're looking your best from all angles.

- Available in three uniquely designed frame options: Bryn Mawr®, Merion®, Rosemont®
- Pair with Main Line Sconces for a coordinated look
- Wall mirrors can only be hung in portrait orientation



Two Week
Lead Time

Main Line Framed Wall Mirrors

Description	Model	FINISHES			
		70, 71 Price	74, 75 Price	76, 77 Price	
Bryn Mawr Framed Wall Mirrors					
	15-1/8" W x 29-7/8" H	DM1630BM __	\$ 579.	\$ 699.	\$ 899.
	19-1/8" W x 29-7/8" H	DM2030BM __	\$ 699.	\$ 799.	\$ 1,029.
	23-1/8" W x 29-7/8" H	DM2430BM __	\$ 799.	\$ 899.	\$ 1,129.
	15-1/8" W x 39-7/8" H	DM1640BM __	\$ 799.	\$ 899.	\$ 1,129.
	19-1/8" W x 39-7/8" H	DM2040BM __	\$ 899.	\$ 1,029.	\$ 1,279.
	23-1/8" W x 39-7/8" H	DM2440BM __	\$ 1,029.	\$ 1,129.	\$ 1,379.
Merion Framed Wall Mirrors					
	15-1/8" W x 29-7/8" H	DM1630ME __	\$ 579.	\$ 699.	\$ 899.
	19-1/8" W x 29-7/8" H	DM2030ME __	\$ 699.	\$ 799.	\$ 1,029.
	23-1/8" W x 29-7/8" H	DM2430ME __	\$ 799.	\$ 899.	\$ 1,129.
	15-1/8" W x 39-7/8" H	DM1640ME __	\$ 799.	\$ 899.	\$ 1,129.
	19-1/8" W x 39-7/8" H	DM2040ME __	\$ 899.	\$ 1,029.	\$ 1,279.
	23-1/8" W x 39-7/8" H	DM2440ME __	\$ 1,029.	\$ 1,129.	\$ 1,379.
Rosemont Framed Wall Mirrors					
	15-1/8" W x 29-7/8" H	DM1630RM __	\$ 579.	\$ 699.	\$ 899.
	19-1/8" W x 29-7/8" H	DM2030RM __	\$ 699.	\$ 799.	\$ 1,029.
	23-1/8" W x 29-7/8" H	DM2430RM __	\$ 799.	\$ 899.	\$ 1,129.
	15-1/8" W x 39-7/8" H	DM1640RM __	\$ 799.	\$ 899.	\$ 1,129.
	19-1/8" W x 39-7/8" H	DM2040RM __	\$ 899.	\$ 1,029.	\$ 1,279.
	23-1/8" W x 39-7/8" H	DM2440RM __	\$ 1,029.	\$ 1,129.	\$ 1,379.

Frame Finish Options

Fill in __ designator to Model listed above with desired finish. Example: DC1640BM74.

- 70 Satin Nickel
- 71 Brushed Nickel
- 74 Brushed Black
- 75 Brushed Bronze
- 76 Chrome
- 77 Polished Nickel

SEE PAGE 177 FOR TIPS AND FEATURES.

Table of Contents

Profiles Vanity with Antique Mirror Glass Tips & Features	185 – 186
Profiles Vanities with Antique Mirror Glass	188 – 189
Vanity Tops	258 – 265
Profiles Vanity Undermount Bowl Space Availability	266
Vanity Accessories	271 – 275

Tips & Features

Dimensions & Weight

- Dimensions (W x H):
30" x 22-1/2" (762 mm x 572 mm)
60" x 22-1/2" (1524 mm x 572 mm)
- Depth: 21-3/4" (552 mm)
- Net Weight: 72 – 127 lbs

Features & Benefits

- Exclusive offering available:
Antique Mirror options in Arcobaleno with a Matte Gold frame finish and Luna with a Matte Black frame finish
- Arcobaleno and Luna patterns are unique and unrepeatable which means no two pieces are alike due to the handcrafted quality of this product
- Match fixtures in your styling space with Matte Gold and Matte Black metal frame finishes for a coordinated look
- Create a coordinated ensemble by pairing with Profiles Medicine Cabinets, Profiles Lighting and Profiles Mirrors
- Tip out drawer for H1 (7-1/2" H) gives storage back by providing a drawer for smaller items and slow-close plumbing drawer for H2 (15" H) allows for maximum storage
- Uniquely designed handleless ergonomic drawer, allows for a comfortable feel and effortless operation
- Organization kit for H2 (15" H): two fully adjustable glass drawer dividers provide storage right where you need it and prevent items from moving and sliding in the drawer
- Night light – integrated LED night light with light bar built into top frame of each drawer, provides soft light to illuminate drawer interior and for wayfinding light in selectable 2700 Kelvin/4000 Kelvin. Night light is ETL certified to UL 2108, CSA Standard C22.2 No. 12
- Electric accessory option: three plugs and a switch that turns off power to the unit to keep appliances safely plugged in

Configurable Options

- Vanity Styles:
Powder Room (30" W)
Master Bath (60" W)
- Decorative Options:
Arcobaleno with a Matte Gold frame finish
Luna with a Matte Black frame finish

Construction

- Durable rust-free anodized aluminum and glass construction – resists intense moisture, ensuring long-lasting beauty
- Slow-close full-extension slides combined with the durability of aluminum construction ensure smooth operation of the vanity drawers that will last a lifetime
- Constructed for wall hanging loads with stone tops
- Glass fronts and side kits are replaceable
- Industrial grade installation hardware
- White shatter-protected glass drawer bottoms will not degrade or show wear. Glass dissipates heat to ensure confidence that hot items will not leave heat marks on the bottom of the drawers



Profiles® Vanities with Antique Mirror Glass – Tips & Features

Tips & Features (Continued)

Installation

- This installation may require more than one person
- Includes installation hardware and structural bolts
- Special site preparation is required. Wall bracing and Robern supplied hardware are recommended
- The plumbing must be roughed into the plumbing cutout area of the vanity. Refer to the sink rough-in and the vanity rough-in for proper placement. The water supply and drain lines must be installed before installing the vanity.
- Components needed for stacking are included with each vanity; ganging kit sold separately for the 60" configuration
- Side kits are sold separately to allow for customization and are available as pairs
- Each design offers the necessary 15" plumbing clearance needed to clear the pipes
- Night light (S) – 12VDC plug-in transformer. Option of two color temperatures for one night light: 2700 or 4000 Kelvin. The vanity is preconfigured at 2700K. Night light can be reconfigured to 4000K at time of installation, see installation instructions for more information
- Electric Accessory option: 120VAC 20A tamper resistant outlet. Installed within 15" H (H2) vanity drawer; not recommended to be used in combination with Slim Drawer Insert; recommended in combination with Hair Styling Organizer
- Slim plumbing drawer insert must be used with a sink installation – includes four glass bins and only available for 15" H (H2) vanities
- Hair Styling Organizer fits 15" H (H2) plumbing vanity drawers; cannot be used in combination with slim plumbing drawer insert; recommended in combination with Electric Accessory

Accessories

- In-drawer Electric Accessory (VAELECTRIC21): ETL certified to UL 1363, CSA Standard C22.2 No. 21; to be used in 15" H (H2) vanity drawers only
- Hair Styling Organizer (VAHAIRORG): fits most hair dryers and curling irons – to be used in 15" H (H2) vanity drawers only
- Slim Plumbing Drawer insert with four glass bins (VADRAWER30P) – to be used in 15" H (H2) vanity drawers only
- Glass Bins: divided storage (GLASSBIN6.38), small (GLASSBIN3.25), medium (GLASSBIN5.25), large (GLASSBIN8.5)
- Glass (30" W only) and engineered stone tops with porcelain sink
- Glass side kits sold separately as a pair. Available in 22-1/2" (H3) height and 21" depth
- Ganging kits are required for the 60" W configuration. One 22-1/2" (H3) ganging kit is needed to gang the vanity drawers together
- Alcove finishing kits are required for corner or alcove installations and is available in 22-1/2" (H3) height



Profiles® Vanity with Antique Mirror Glass



The stunning and versatile Profiles Collection features two dramatic Italian glass options: antique mirror in Arcobaleno and Luna.

- Antique Mirror options in Arcobaleno with a Matte Gold frame finish and Luna with a Matte Black frame finish
- Arcobaleno and Luna patterns are unique and unrepeatable which means no two pieces are alike due to the handcrafted quality of this product



Two Week Lead Time



Modular



Electrical Outlet



Night Light

Powder Room – 30" W x 22-1/2" H x 22-3/4" D

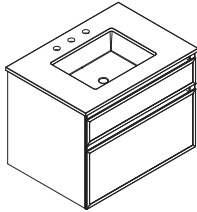

Description	Model	Price Each
Arcobaleno Antique Mirror – Consists of:		
Profiles Framed Vanity, 30" W x 7-1/2" H x 21" D, Matte Gold Frame, Tip Out Drawer, Selectable Night Light: 2700K/4000K Temperature (VP30H1D21T58S82, Quantity = 1)	30588200SA00004	\$ 8,447.
Profiles Framed Vanity, 30" W x 15" H x 21" D, Matte Gold Frame, Plumbing Drawer, Selectable Night Light: 2700K/4000K Temperature (VP30H2D21P58S82, Quantity = 1)		
Profiles Pair of Side Kits, 7/8" W x 22-1/2" H x 21" D (VM2SKH3D21-58, Quantity = 1)		
Luna Antique Mirror – Consists of:		
Profiles Framed Vanity, 30" W x 7-1/2" H x 21" D, Matte Black Frame, Tip Out Drawer, Selectable Night Light: 2700K/4000K Temperature (VP30H1D21T59S83, Quantity = 1)	30598300SA00004	\$ 8,447.
Profiles Framed Vanity, 30" W x 15" H x 21" D, Matte Black Frame, Plumbing Drawer, Selectable Night Light: 2700K/4000K Temperature (VP30H2D21P59S83, Quantity = 1)		
Profiles Pair of Side Kits, 7/8" W x 22-1/2" H x 21" D (VM2SKH3D21-59, Quantity = 1)		

Vanity top and sink sold separately.

Master Bath – 60" W x 22-1/2" H x 22-3/4" D

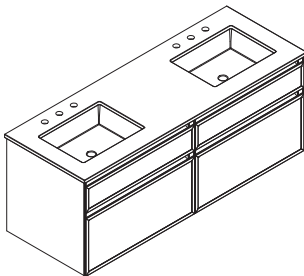

Description	Model	Price Each
Arcobaleno Antique Mirror – Consists of:		
Profiles Framed Vanity, 30" W x 7-1/2" H x 21" D, Matte Gold Frame, Tip Out Drawer, Selectable Night Light: 2700K/4000K Temperature (VP30H1D21T58S82, Quantity = 2)	60588200SA00005	\$ 15,874.
Profiles Framed Vanity, 30" W x 15" H x 21" D, Matte Gold Frame, Plumbing Drawer, Selectable Night Light: 2700K/4000K Temperature (VP30H2D21P58S82, Quantity = 2)		
Profiles Pair of Side Kits, 7/8" W x 22-1/2" H x 21" D (VM2SKH3D21-58, Quantity = 1)		
Profiles 22-1/2" H Ganging Kit (VMGKITH3, Quantity = 1)		
Luna Antique Mirror – Consists of:		
Profiles Framed Vanity, 30" W x 7-1/2" H x 21" D, Matte Black Frame, Tip Out Drawer, Selectable Night Light: 2700K/4000K Temperature (VP30H1D21T59S83, Quantity = 2)	60598300SA00005	\$ 15,874.
Profiles Framed Vanity, 30" W x 15" H x 21" D, Matte Black Frame, Plumbing Drawer, Selectable Night Light: 2700K/4000K Temperature (VP30H2D21P59S83, Quantity = 2)		
Profiles Pair of Side Kits, 7/8" W x 22-1/2" H x 21" D (VM2SKH3D21-59, Quantity = 1)		
Profiles 22-1/2" H Ganging Kit (VMGKITH3, Quantity = 1)		

Vanity top and sink sold separately.

See Vanity Tops, Accessories & Options on the following page.

Profiles® Vanity with Antique Mirror Glass

31" W x 22" D Vanity Tops – For 21" D Vanities

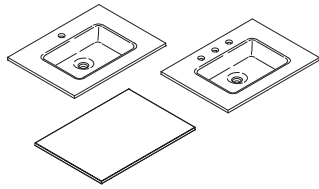

Description	For Use With Vanity	See Page
TS31UCN __ Glass Vanity Top	Plumbing & Tip Out Drawer	259
TF31UCO __ Engineered Stone Vanity Top	Plumbing & Tip Out Drawer	259
TF31G __ Engineered Stone Vanity Top (No Sink)	30" W Vanities	259
TF61G __ Engineered Stone Vanity Top (No Sink)	60" W Vanities	263

Undercounter Sink available for Custom Countertop – see page 265.

Add-On Accessories & Options

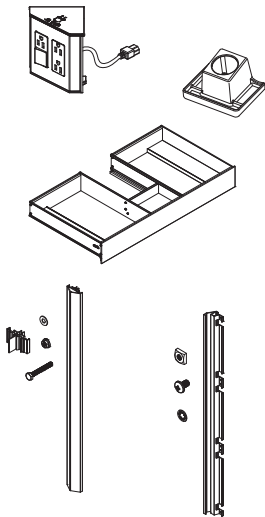

Description	Model	Price
Electric Accessory For use in 15" H plumbing drawer (H2)	VAELECTRIC21	\$ 479.
Hair Styling Organizer For use in 15" H plumbing drawer (H2)	VAHAIRORG	\$ 249.
Slim Drawer Insert For use in 15" H vanity plumbing drawer (H2)	VADRAWER30P	\$ 749.
Vanity Ganging Kit – Hardware required when combining two or more vanities (each connection point) 22-1/2" H	VMGKITH3	\$ 229.
Vanity Alcove Finishing Kit – Hardware required for corner or alcove installations 22-1/2" H	VMAKITH3	\$ 229.

See additional Accessories on pages 273 – 273.

SEE PAGES 185 – 186 FOR TIPS AND FEATURES.

Curated Cartesian® Vanities – Table of Contents, Tips & Features

Curated Cartesian Vanity Tips & Features 190 – 191

Curated Cartesian Vanity Model Number Worksheet 192

Curated Cartesian Vanities 194 – 199

 24" Wide Curated Cartesian Vanity 194 – 195

 30" Wide Curated Cartesian Vanity 196 – 197

 36" Wide Curated Cartesian Vanity 198 – 199

Vanity Accessories 271 – 275

Tips & Features

Dimensions & Weight

- Width (with side kits installed):
24" (610 mm)
30" (762 mm)
36" (914 mm)
- Height:
15-3/4" (400 mm)
30-3/4" (781 mm)
- Depth: 22" (559 mm)
- Net Weight: 100 – 205 lbs

Features & Benefits

- Fully pre-configured vanity
- Glass finishes and engineered stone create a visually stunning product that's durable enough to stand the test of time
- Includes Robern ceramic lavatory and proprietary Robern mounting brackets
- Vanity top with 8" widespread faucet holes
- Plumbing slow-close drawer allows clearance for drain; tip out drawer for H1 (7-1/2" H) gives storage back by providing a drawer for smaller items and full slow-close drawer allows for maximum storage when plumbing does not interfere
- Uniquely designed handleless ergonomic drawer, allows for a comfortable feel and effortless operation
- H1 (7-1/2" H) vanities include five glass bins for plumbing drawers and four glass bins for full drawers; H2 (15" H) vanities include one glass bin with plumbing drawers

Features & Benefits (Continued)

- Organization kit for H2 (15" H): two fully adjustable glass drawer dividers provide storage right where you need it and prevent items from moving and sliding in the drawer
- Night Light Option – integrated LED night light with light bar built into top frame (top drawer only), provides soft light to illuminate drawer interior and for wayfinding light in either selectable 2700 Kelvin/4000 Kelvin or 5000 Kelvin. Night light is ETL certified to UL 2108, CSA Standard C22.2 No. 12
- Electric accessory option: three plugs and a switch that turns off power to the unit to keep appliances safely plugged in

Configurable Options

- Vanity Styles:
Single Drawer (Plumbing Drawer),
Two Drawer (Plumbing Drawer, Full Drawer),
Three Drawer (Tip Out Drawer, Plumbing Drawer, Full Drawer)
- Decorative Options:
1) White Glass, Stone Gray Top,
2) Tinted Gray Mirror Glass, Lyra Top,
3) Matte Gray Glass, Quartz White Top
- Night Light:
No Night Light or Integrated LED Night Light in selectable 2700 Kelvin/4000 Kelvin or 5000 Kelvin



Curated Cartesian® Vanities – Tips & Features

Tips & Features (Continued)

Construction

- Durable rust-free anodized aluminum and glass construction – resists intense moisture, ensuring long-lasting beauty
- Slow-close full-extension slides combined with the durability of aluminum construction ensure smooth operation of the vanity drawers that will last a lifetime
- Constructed for wall hanging loads with stone tops
- Glass fronts and side kits are replaceable
- Industrial grade installation hardware
- White shatter-protected glass drawer bottoms will not degrade or show wear. Glass dissipates heat to ensure confidence that hot items will not leave heat marks on the bottom of the drawers

Installation

- This installation may require more than one person
- Includes installation hardware, structural bolts and silicone
- Special site preparation is required. Wall bracing and Robern supplied hardware are recommended.
- The plumbing must be roughed into the plumbing cutout area of the vanity. Refer to the sink rough-in and the vanity rough-in for proper placement. The water supply and drain lines must be installed before installing the vanity.
- Components needed for stacking are included with each vanity
- Each design offers the necessary 15" plumbing clearance needed to clear the pipes
- Night Light Option (S) – 12VDC plug-in transformer. Option of two color temperatures for one night light: 2700 or 4000 Kelvin. The vanity is preconfigured at 2700K. Night light can be reconfigured to 4000K at time of installation. See installation instructions for more information.
- Night Light Option (T) – 12VDC plug-in transformer in 5000 Kelvin color temperature. Locate wall outlet as per installation instructions.

Installation (Continued)

- Electric Accessory option: 120VAC 20A tamper resistant outlet. Installed within 15" H (H2) vanity drawer; not recommended to be used in combination with Slim Drawer Insert; recommended in combination with Hair Styling Organizer
- Slim full drawer insert can be used in a full drawer – includes four glass bins and only available for 15" H (H2) vanities
- Hair Styling Organizer fits all 15" H (H2) full vanity drawers; cannot be used in combination with slim plumbing drawer insert; recommended in combination with Electric Accessory

Accessories

- In-drawer Electric Accessory (VAELECTRIC21): ETL certified to UL 1363, CSA Standard C22.2 No. 21 – to be used in 15" H (H2) vanity drawers only
- Accessory Night Light in selectable 2700 Kelvin/ 4000 Kelvin (SLEDS24, SLEDS30, SLEDS36) and 5000 Kelvin (CLEDS24, CLEDS30, CLEDS36): Night light is ETL certified to UL 2108, CSA Standard C22.2 No. 12
- Slim Full Drawer Insert with four glass bins (VADRAWER24X, VADRAWER30X, VADRAWER36X) – 15" H only
- Glass Bins: divided storage (GLASSBIN6.38), small (GLASSBIN3.25), medium (GLASSBIN5.25), large (GLASSBIN8.5)
- Hair Styling Organizer (VAHAIRORG): fits most hair dryers and curling irons – to be used in 15" H (H2) vanity drawers only



Curated Cartesian® Vanity Model Number Worksheet

FEATURES

Select Width:

24"

30"

36"

Select Color:

White Glass Vanity, Stone Gray Top

Tinted Gray Mirror Glass Vanity, Lyra Top

Matte Gray Glass Vanity, Quartz White Top

Select Option:

Base Unit (No Night Light)

Selectable Night Light, 2700K/4000K

Night Light, 5000K

Select Drawer Style:

Single

Two

Three

MODEL

24

30

36

2191

1194

2792

N

S

T

00001

00002

00003

00

B

CUSTOMER INFORMATION

Name

Address

City/State/Zip

Telephone

Date Ordered

Curated Cartesian® Vanity – 24" W x 21" D



Take the guesswork out of vanity design. The Curated Cartesian vanity collection streamlines the decision-making process with a handpicked selection of vanities to ensure a flawless fit that complements any design.

- Glass finishes and engineered stone create a visually stunning product that's durable enough to stand the test of time
- Spacious drawers and tip out storage options eliminate clutter and make the daily routine effortless
- Finishing touches such as in-drawer electric, hot storage, and an LED night light elevate the contemporary design



Four Week
Lead Time



Electrical
Outlet



Night
Light

24" W x 21" D Vanity (25" W x 22" D with Vanity Top)

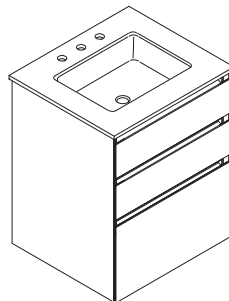
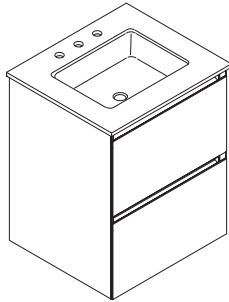
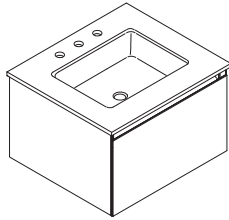

Description

Model

Price

15" H (15-3/4" H with Vanity Top) – Single Drawer, Base Unit

White Glass Vanity, Stone Gray Top	24219100NB00001	\$ 3,149.
Tinted Gray Mirror Glass Vanity, Lyra Top	24119400NB00001	\$ 3,599.
Matte Gray Glass Vanity, Quartz White Top	24279200NB00001	\$ 3,829.

15" H (15-3/4" H with Vanity Top) – Single Drawer, 2700K/4000K Night Light

White Glass Vanity, Stone Gray Top	24219100SB00001	\$ 3,499.
Tinted Gray Mirror Glass Vanity, Lyra Top	24119400SB00001	\$ 3,929.
Matte Gray Glass Vanity, Quartz White Top	24279200SB00001	\$ 4,179.

15" H (15-3/4" H with Vanity Top) – Single Drawer, 5000K Night Light

White Glass Vanity, Stone Gray Top	24219100TB00001	\$ 3,499.
Tinted Gray Mirror Glass Vanity, Lyra Top	24119400TB00001	\$ 3,929.
Matte Gray Glass Vanity, Quartz White Top	24279200TB00001	\$ 4,179.

30" H (30-3/4" H with Vanity Top) – Two Drawer, Base Unit

White Glass Vanity, Stone Gray Top	24219100NB00002	\$ 4,749.
Tinted Gray Mirror Glass Vanity, Lyra Top	24119400NB00002	\$ 5,179.
Matte Gray Glass Vanity, Quartz White Top	24279200NB00002	\$ 5,849.

30" H (30-3/4" H with Vanity Top) – Two Drawer, 2700K/4000K Night Light

White Glass Vanity, Stone Gray Top	24219100SB00002	\$ 5,079.
Tinted Gray Mirror Glass Vanity, Lyra Top	24119400SB00002	\$ 5,529.
Matte Gray Glass Vanity, Quartz White Top	24279200SB00002	\$ 6,199.

30" H (30-3/4" H with Vanity Top) – Two Drawer, 5000K Night Light

White Glass Vanity, Stone Gray Top	24219100TB00002	\$ 5,079.
Tinted Gray Mirror Glass Vanity, Lyra Top	24119400TB00002	\$ 5,529.
Matte Gray Glass Vanity, Quartz White Top	24279200TB00002	\$ 6,199.

30" H (30-3/4" H with Vanity Top) – Three Drawer, Base Unit

White Glass Vanity, Stone Gray Top	24219100NB00003	\$ 5,579.
Tinted Gray Mirror Glass Vanity, Lyra Top	24119400NB00003	\$ 6,029.
Matte Gray Glass Vanity, Quartz White Top	24279200NB00003	\$ 7,179.

30" H (30-3/4" H with Vanity Top) – Three Drawer, 2700K/4000K Night Light

White Glass Vanity, Stone Gray Top	24219100SB00003	\$ 5,929.
Tinted Gray Mirror Glass Vanity, Lyra Top	24119400SB00003	\$ 6,349.
Matte Gray Glass Vanity, Quartz White Top	24279200SB00003	\$ 7,499.

30" H (30-3/4" H with Vanity Top) – Three Drawer, 5000K Night Light

White Glass Vanity, Stone Gray Top	24219100TB00003	\$ 5,929.
Tinted Gray Mirror Glass Vanity, Lyra Top	24119400TB00003	\$ 6,349.
Matte Gray Glass Vanity, Quartz White Top	24279200TB00003	\$ 7,499.





Note: Models in **bold** indicate Quick Ship product.

See Accessories and Options on the following page.

Curated Cartesian® Vanity – 24" W x 21" D

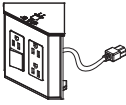
Add-On Accessories & Options

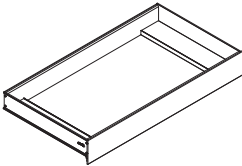
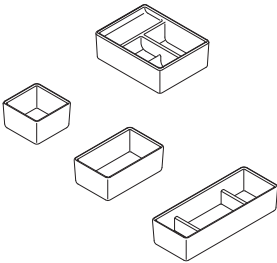
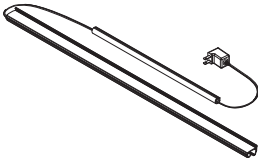
	Description	Model	Price
	Electric Accessory For use in 15" H plumbing or full drawer	VAELECTRIC21	\$ 479.
	Hair Styling Organizer For use in 15" H full drawer	VAHAIRORG	\$ 249.
	Slim Drawer Insert For use in 15" H full drawer (two drawer or three drawer vanity)	VADRAWER24X	\$ 649.
	Accessory Glass Bins Divided Storage, 4-7/8" W x 6-3/8" L x 2-1/8" D	GLASSBIN6.38	\$ 49.
	Small, 3-1/4" W x 3-1/4" L	GLASSBIN3.25	\$ 49.
	Medium, 3-1/4" W x 5-1/4" L	GLASSBIN5.25	\$ 49.
	Large, 3-1/4" W x 8-1/2" L	GLASSBIN8.5	\$ 49.
	Accessory Night Lights 24" W, 5000K	CLEDS24	\$ 349.
	24" W, 2700K/4000K	SLEDS24	\$ 349.

 **Note:** Models in **bold** indicate Quick Ship product.

SEE PAGES 190 – 191 FOR TIPS AND FEATURES.

Vanities & Tops

Curated Cartesian® Vanity – 30" W x 21" D



Take the guesswork out of vanity design. The Curated Cartesian vanity collection streamlines the decision-making process with a handpicked selection of vanities to ensure a flawless fit that complements any design.

- Glass finishes and engineered stone create a visually stunning product that's durable enough to stand the test of time
- Spacious drawers and tip out storage options eliminate clutter and make the daily routine effortless
- Finishing touches such as in-drawer electric, hot storage, and an LED night light elevate the contemporary design



Four Week
Lead Time



Electrical
Outlet



Night
Light

30" W x 21" D Vanity (31" W x 22" D with Vanity Top)

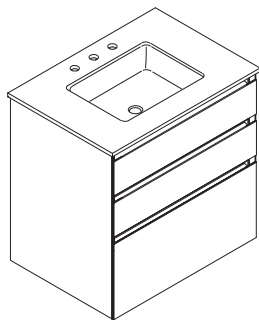
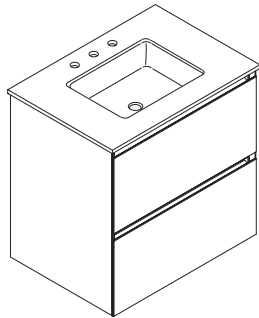
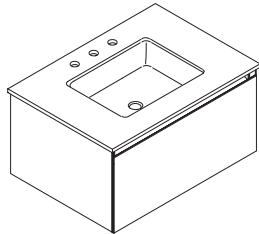

Description	Model	Price
15" H (15-3/4" H with Vanity Top) – Single Drawer, Base Unit		
White Glass Vanity, Stone Gray Top	30219100NB00001	\$ 3,829.
Tinted Gray Mirror Glass Vanity, Lyra Top	30119400NB00001	\$ 4,299.
Matte Gray Glass Vanity, Quartz White Top	30279200NB00001	\$ 4,499.
15" H (15-3/4" H with Vanity Top) – Single Drawer, 2700K/4000K Night Light		
White Glass Vanity, Stone Gray Top	30219100SB00001	\$ 4,229.
Tinted Gray Mirror Glass Vanity, Lyra Top	30119400SB00001	\$ 4,679.
Matte Gray Glass Vanity, Quartz White Top	30279200SB00001	\$ 4,899.
15" H (15-3/4" H with Vanity Top) – Single Drawer, 5000K Night Light		
White Glass Vanity, Stone Gray Top	30219100TB00001	\$ 4,229.
Tinted Gray Mirror Glass Vanity, Lyra Top	30119400TB00001	\$ 4,679.
Matte Gray Glass Vanity, Quartz White Top	30279200TB00001	\$ 4,899.
30" H (30-3/4" H with Vanity Top) – Two Drawer, Base Unit		
White Glass Vanity, Stone Gray Top	30219100NB00002	\$ 5,979.
Tinted Gray Mirror Glass Vanity, Lyra Top	30119400NB00002	\$ 6,429.
Matte Gray Glass Vanity, Quartz White Top	30279200NB00002	\$ 7,099.
30" H (30-3/4" H with Vanity Top) – Two Drawer, 2700K/4000K Night Light		
White Glass Vanity, Stone Gray Top	30219100SB00002	\$ 6,349.
Tinted Gray Mirror Glass Vanity, Lyra Top	30119400SB00002	\$ 6,829.
Matte Gray Glass Vanity, Quartz White Top	30279200SB00002	\$ 7,499.
30" H (30-3/4" H with Vanity Top) – Two Drawer, 5000K Night Light		
White Glass Vanity, Stone Gray Top	30219100TB00002	\$ 6,349.
Tinted Gray Mirror Glass Vanity, Lyra Top	30119400TB00002	\$ 6,829.
Matte Gray Glass Vanity, Quartz White Top	30279200TB00002	\$ 7,499.
30" H (30-3/4" H with Vanity Top) – Three Drawer, Base Unit		
White Glass Vanity, Stone Gray Top	30219100NB00003	\$ 7,379.
Tinted Gray Mirror Glass Vanity, Lyra Top	30119400NB00003	\$ 7,849.
Matte Gray Glass Vanity, Quartz White Top	30279200NB00003	\$ 8,949.
30" H (30-3/4" H with Vanity Top) – Three Drawer, 2700K/4000K Night Light		
White Glass Vanity, Stone Gray Top	30219100SB00003	\$ 7,799.
Tinted Gray Mirror Glass Vanity, Lyra Top	30119400SB00003	\$ 8,229.
Matte Gray Glass Vanity, Quartz White Top	30279200SB00003	\$ 9,379.
30" H (30-3/4" H with Vanity Top) – Three Drawer, 5000K Night Light		
White Glass Vanity, Stone Gray Top	30219100TB00003	\$ 7,799.
Tinted Gray Mirror Glass Vanity, Lyra Top	30119400TB00003	\$ 8,229.
Matte Gray Glass Vanity, Quartz White Top	30279200TB00003	\$ 9,379.





Note: Models in **bold** indicate Quick Ship product.

See Accessories and Options on the following page.

Curated Cartesian® Vanity – 30" W x 21" D

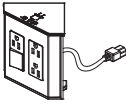
Add-On Accessories & Options

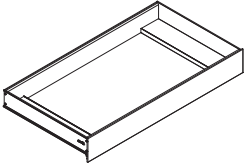
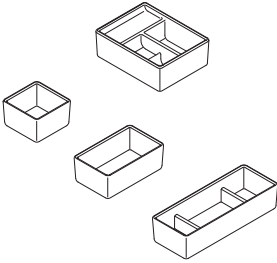
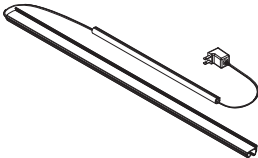
	Description	Model	Price
	Electric Accessory For use in 15" H plumbing or full drawer	VAELECTRIC21	\$ 479.
	Hair Styling Organizer For use in 15" H full drawer	VAHAIRORG	\$ 249.
	Slim Drawer Insert For use in 15" H full drawer (two drawer or three drawer vanity)	VADRAWER30X	\$ 749.
	Accessory Glass Bins Divided Storage, 4-7/8" W x 6-3/8" L x 2-1/8" D	GLASSBIN6.38	\$ 49.
	Small, 3-1/4" W x 3-1/4" L	GLASSBIN3.25	\$ 49.
	Medium, 3-1/4" W x 5-1/4" L	GLASSBIN5.25	\$ 49.
	Large, 3-1/4" W x 8-1/2" L	GLASSBIN8.5	\$ 49.
	Accessory Night Lights 30" W, 5000K	CLEDS30	\$ 399.
	30" W, 2700K/4000K	SLEDS30	\$ 399.

 **Note:** Models in **bold** indicate Quick Ship product.

SEE PAGES 190 – 191 FOR TIPS AND FEATURES.

Vanities & Tops

Curated Cartesian® Vanity – 36" W x 21" D



Take the guesswork out of vanity design. The Curated Cartesian vanity collection streamlines the decision-making process with a handpicked selection of vanities to ensure a flawless fit that complements any design.

- Glass finishes and engineered stone create a visually stunning product that's durable enough to stand the test of time
- Spacious drawers and tip out storage options eliminate clutter and make the daily routine effortless
- Finishing touches such as in-drawer electric, hot storage, and an LED night light elevate the contemporary design



Four Week
Lead Time



Electrical
Outlet



Night
Light

36" W x 21" D Vanity (37" W x 22" D with Vanity Top)

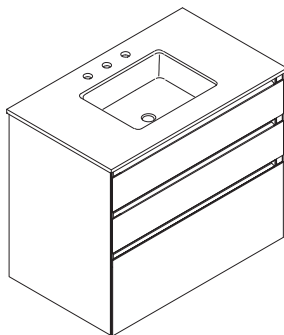
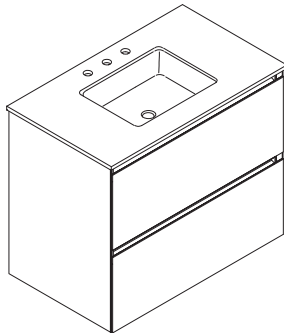
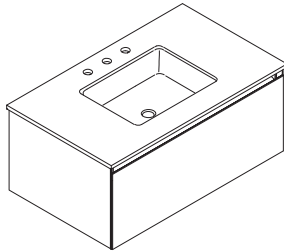

Description

Model

Price

15" H (15-3/4" H with Vanity Top) – Single Drawer, Base Unit

White Glass Vanity, Stone Gray Top	36219100NB00001	\$ 4,499.
Tinted Gray Mirror Glass Vanity, Lyra Top	36119400NB00001	\$ 4,979.
Matte Gray Glass Vanity, Quartz White Top	36279200NB00001	\$ 5,179.

15" H (15-3/4" H with Vanity Top) – Single Drawer, 2700K/4000K Night Light

White Glass Vanity, Stone Gray Top	36219100SB00001	\$ 4,979.
Tinted Gray Mirror Glass Vanity, Lyra Top	36119400SB00001	\$ 5,399.
Matte Gray Glass Vanity, Quartz White Top	36279200SB00001	\$ 5,649.

15" H (15-3/4" H with Vanity Top) – Single Drawer, 5000K Night Light

White Glass Vanity, Stone Gray Top	36219100TB00001	\$ 4,979.
Tinted Gray Mirror Glass Vanity, Lyra Top	36119400TB00001	\$ 5,399.
Matte Gray Glass Vanity, Quartz White Top	36279200TB00001	\$ 5,649.

30" H (30-3/4" H with Vanity Top) – Two Drawer, Base Unit

White Glass Vanity, Stone Gray Top	36219100NB00002	\$ 7,229.
Tinted Gray Mirror Glass Vanity, Lyra Top	36119400NB00002	\$ 7,649.
Matte Gray Glass Vanity, Quartz White Top	36279200NB00002	\$ 8,329.

30" H (30-3/4" H with Vanity Top) – Two Drawer, 2700K/4000K Night Light

White Glass Vanity, Stone Gray Top	36219100SB00002	\$ 7,649.
Tinted Gray Mirror Glass Vanity, Lyra Top	36119400SB00002	\$ 8,129.
Matte Gray Glass Vanity, Quartz White Top	36279200SB00002	\$ 8,799.

30" H (30-3/4" H with Vanity Top) – Two Drawer, 5000K Night Light

White Glass Vanity, Stone Gray Top	36219100TB00002	\$ 7,649.
Tinted Gray Mirror Glass Vanity, Lyra Top	36119400TB00002	\$ 8,129.
Matte Gray Glass Vanity, Quartz White Top	36279200TB00002	\$ 8,799.

30" H (30-3/4" H with Vanity Top) – Three Drawer, Base Unit

White Glass Vanity, Stone Gray Top	36219100NB00003	\$ 9,199.
Tinted Gray Mirror Glass Vanity, Lyra Top	36119400NB00003	\$ 9,629.
Matte Gray Glass Vanity, Quartz White Top	36279200NB00003	\$ 10,749.

30" H (30-3/4" H with Vanity Top) – Three Drawer, 2700K/4000K Night Light

White Glass Vanity, Stone Gray Top	36219100SB00003	\$ 9,629.
Tinted Gray Mirror Glass Vanity, Lyra Top	36119400SB00003	\$ 10,099.
Matte Gray Glass Vanity, Quartz White Top	36279200SB00003	\$ 11,229.

30" H (30-3/4" H with Vanity Top) – Three Drawer, 5000K Night Light

White Glass Vanity, Stone Gray Top	36219100TB00003	\$ 9,629.
Tinted Gray Mirror Glass Vanity, Lyra Top	36119400TB00003	\$ 10,099.
Matte Gray Glass Vanity, Quartz White Top	36279200TB00003	\$ 11,229.





Note: Models in **bold** indicate Quick Ship product.

See Accessories and Options on the following page.

Curated Cartesian® Vanity – 36" W x 21" D

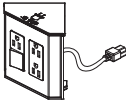
Add-On Accessories & Options

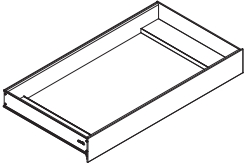
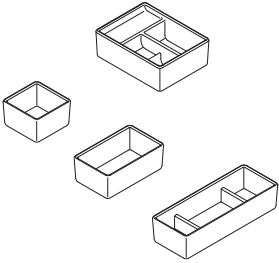
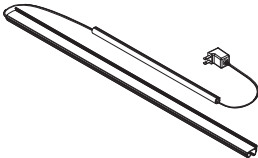
	Description	Model	Price
	Electric Accessory For use in 15" H plumbing or full drawer	VAELECTRIC21	\$ 479.
	Hair Styling Organizer For use in 15" H full drawer	VAHAIRORG	\$ 249.
	Slim Drawer Insert For use in 15" H full drawer (two drawer or three drawer vanity)	VADRAWER36X	\$ 829.
	Accessory Glass Bins Divided Storage, 4-7/8" W x 6-3/8" L x 2-1/8" D	GLASSBIN6.38	\$ 49.
	Small, 3-1/4" W x 3-1/4" L	GLASSBIN3.25	\$ 49.
	Medium, 3-1/4" W x 5-1/4" L	GLASSBIN5.25	\$ 49.
	Large, 3-1/4" W x 8-1/2" L	GLASSBIN8.5	\$ 49.
	Accessory Night Lights 36" W, 5000K	CLEDS36	\$ 479.
	36" W, 2700K/4000K	SLEDS36	\$ 479.

 **Note:** Models in **bold** indicate Quick Ship product.

SEE PAGES 190 – 191 FOR TIPS AND FEATURES.

Vanities & Tops

Profiles® Vanities – Table of Contents, Tips & Features

Table of Contents

Profiles Vanity Tips & Features	200 – 201
Profiles Ganging Reference	202
Profiles Vanity Model Number Worksheet	203
Profiles Vanities	204 – 217
12" Wide Profiles Vanity	204 – 205
24" Wide Profiles Vanity	206 – 209
30" Wide Profiles Vanity	210 – 213
36" Wide Profiles Vanity	214 – 217
Vanity Tops	258 – 265
Profiles Vanity Undermount Bowl Space Availability	266
Vanity Accessories	271 – 275

Tips & Features

Dimensions & Weight

- Width (with side kits installed):
12-1/8" (308 mm)
24-1/8" (613 mm)
30-1/8" (765 mm)
36-1/8" (918 mm)
- Height:
7-1/2" (191 mm)
15" (381 mm)
- Depth:
18-3/4" (476 mm)
21-3/4" (552 mm)
- Net Weight: 17 – 55 lbs

Features & Benefits

- Match or coordinate fixtures in your styling space with four popular metal frame finishes: Chrome, Polished Nickel, Matte Gold, Matte Black
- Glass finish options:
Mirror, 10 decorative gloss and matte finishes
- Modular vanities can be ganged or stacked to fit a variety of desired heights and widths (ganging kit required)
- Create a coordinated ensemble by pairing with Profiles Medicine Cabinets, Profiles Lighting and Profiles Mirrors
- Plumbing slow-close drawer allows clearance for drain; tip out drawer for H1 (7-1/2" H) gives storage back by providing a drawer for smaller items and full slow-close drawer allows for maximum storage when plumbing does not interfere
- Uniquely designed handleless ergonomic drawer, allows for a comfortable feel and effortless operation

Features & Benefits (Continued)

- H1 (7-1/2" H) vanities include five glass bins for plumbing drawers and four glass bins for full drawers; H2 (15" H) vanities include one glass bin with plumbing drawers; not available for 12" W vanities
- Organization kit for H2 (15" H): two fully adjustable glass drawer dividers provide storage right where you need it and prevent items from moving and sliding in the drawer
- Night Light Option – integrated LED night light with light bar built into top frame of each drawer, provides soft light to illuminate drawer interior and for wayfinding light in selectable 2700 Kelvin/4000 Kelvin. Night light is ETL certified to UL 2108, CSA Standard C22.2 No. 12
- Electric accessory option: three plugs and a switch that turns off power to the unit to keep appliances safely plugged in

Configurable Options

- Metal Frame Finishes:
Chrome, Polished Nickel, Matte Gold, Matte Black
- Glass Finish Options:
Mirror, 10 Decorative Gloss and Matte Colors
- Night Light:
No Night Light or Integrated LED Night Light in selectable 2700 Kelvin/4000 Kelvin
- Drawer Application:
Choice of split plumbing (not available for 12" W drawer), full drawer or tip out drawer (7-1/2" H only, not available for 12" W drawer)



Profiles® Vanities – Tips & Features

Tips & Features (Continued)

Construction

- Durable rust-free anodized aluminum and glass construction – resists intense moisture, ensuring long-lasting beauty
- Slow-close full-extension slides combined with the durability of aluminum construction ensure smooth operation of the vanity drawers that will last a lifetime
- Constructed for wall hanging loads with stone tops
- Glass fronts and side kits are replaceable
- Industrial grade installation hardware
- White shatter-protected glass drawer bottoms will not degrade or show wear. Glass dissipates heat to ensure confidence that hot items will not leave heat marks on the bottom of the drawers

Installation

- This installation may require more than one person
- Includes installation hardware and structural bolts
- Special site preparation is required. Wall bracing and Robern supplied hardware are recommended
- The plumbing must be roughed into the plumbing cutout area of the vanity. Refer to the sink rough-in and the vanity rough-in for proper placement. The water supply and drain lines must be installed before installing the vanity.
- Components needed for stacking are included with each vanity
- Within a column, all vanities must stay the same width. Ganging kit required for each column connection point and is selected based on the connection height of the cabinets. Each ganging kit is by 7-1/2" H increments (H1 = 7-1/2", H2 = 15", H3 = 22-1/2", H4 = 30").
- Side kits are sold separately to allow for customization and are available individually or as pairs. You must choose one side kit or alcove kit for every exposed side.
- With a 7-1/2" H vanity, a tip out drawer must be used with an undercounter sink
- If stacking with a 7-1/2" H tip out drawer, the second vanity must be a 7-1/2" H plumbing drawer, a 15" H plumbing drawer or a 15" full drawer as the first 15" H needs plumbing clearance. If using 7-1/2" H tip out for undercounter sink installation, slim plumbing drawer insert can be used with a 15" H plumbing drawer and still clear pipes.
- Full drawer units are intended for ganging and stacking and are not designed to accept a sink or plumbing.
- Night light option (S) – 12VDC plug-in transformer. Option of two color temperatures for one night light: 2700 or 4000 Kelvin. The vanity is preconfigured at 2700K. Night light can be reconfigured to 4000K at time of installation. See installation instructions for more information.

Installation (Continued)

- Electric Accessory option: 120VAC 20A tamper resistant outlet. Installed within 15" H (H2) vanity drawer; not recommended to be used in combination with Slim Drawer Insert; recommended in combination with Hair Styling Organizer
- Slim plumbing drawer insert must be used with an above-counter sink installation; full drawer version can be used in a full drawer) – includes four glass bins and only available for 15" H (H2) vanities (not available for 12" W vanities)
- Hair Styling Organizer fits all 15" H (H2) vanity drawers except 24" plumbing drawer; cannot be used in combination with slim drawer insert; recommended in combination with Electric Accessory

Accessories

- In-drawer Electric Accessory (VAELECTRIC18, VAELECTRIC21): ETL certified to UL 1363, CSA Standard C22.2 No. 21 – 15" H only
- Accessory Night Light in selectable 2700 Kelvin/4000 Kelvin (SLEDS12, SLEDS24, SLEDS30, SLEDS36): Night light is ETL certified to UL 2108, CSA Standard C22.2 No. 12
- Slim Plumbing Drawer Insert with four glass bins (VADRAWER24P, VADRAWER30P, VADRAWER36P) – 15" H only
- Slim Full Drawer Insert with four glass bins (VADRAWER12X, VADRAWER24X, VADRAWER30X, VADRAWER36X) – 15" H only
- Glass Bins: divided storage (GLASSBIN6.38), small (GLASSBIN3.25), medium (GLASSBIN5.25), large (GLASSBIN8.5)
- Hair Styling Organizer (VAHAIRORG): fits most hair dryers and curling irons – to be used in 15" H (H2) vanity drawers only
- Glass and engineered stone tops with porcelain sink
- Glass side kits sold separately as single units or as a pair. Available in 4 heights and 2 depths, and based on the final configuration of the vanity (7-1/2", 15", 22-1/2", 30")
- Ganging kits are required when combining two or more vanities and are available in 4 heights and based on the final configuration of the vanity (7-1/2", 15", 22-1/2", 30")
- Alcove finishing kits are required for corner or alcove installations and are available in 4 heights and based on the final configuration of the vanity (7-1/2", 15", 22-1/2", 30")



Profiles® Ganging Reference

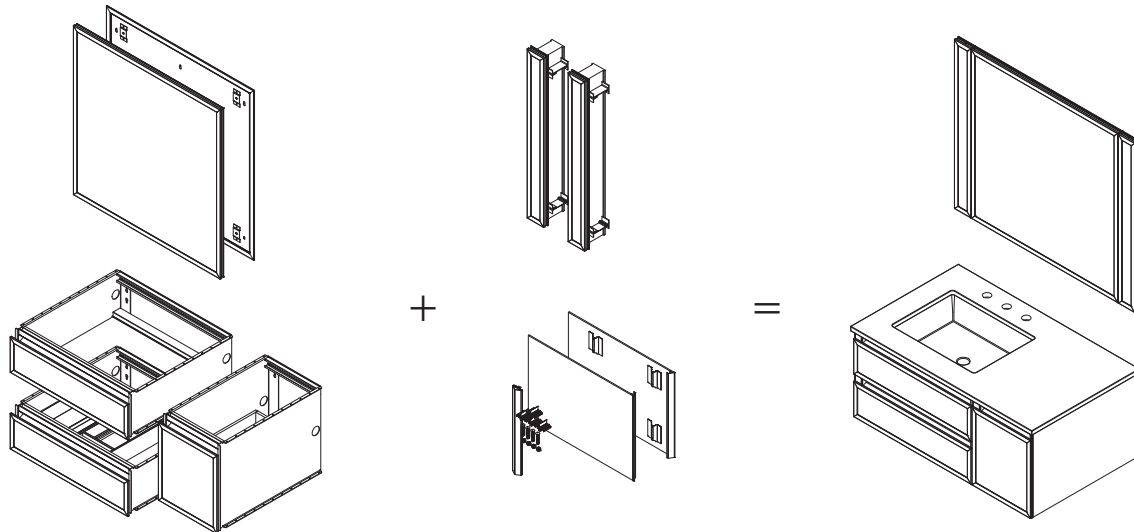

- (1) PM3030T _ _ _
- (1) PMGKIT3030
- (1) VP24H1D21T _ _ S _ _
- (1) VP24H1D21P _ _ S _ _
- (1) VP12H2D21F _ _ S _ _

- (2) PL3.530TLSC _ _ DV
- (1) VM2SKH2D21- _ _ _
- (1) VMGKITH2

- (1) TF37ULO _ _ -8

Configuration 1

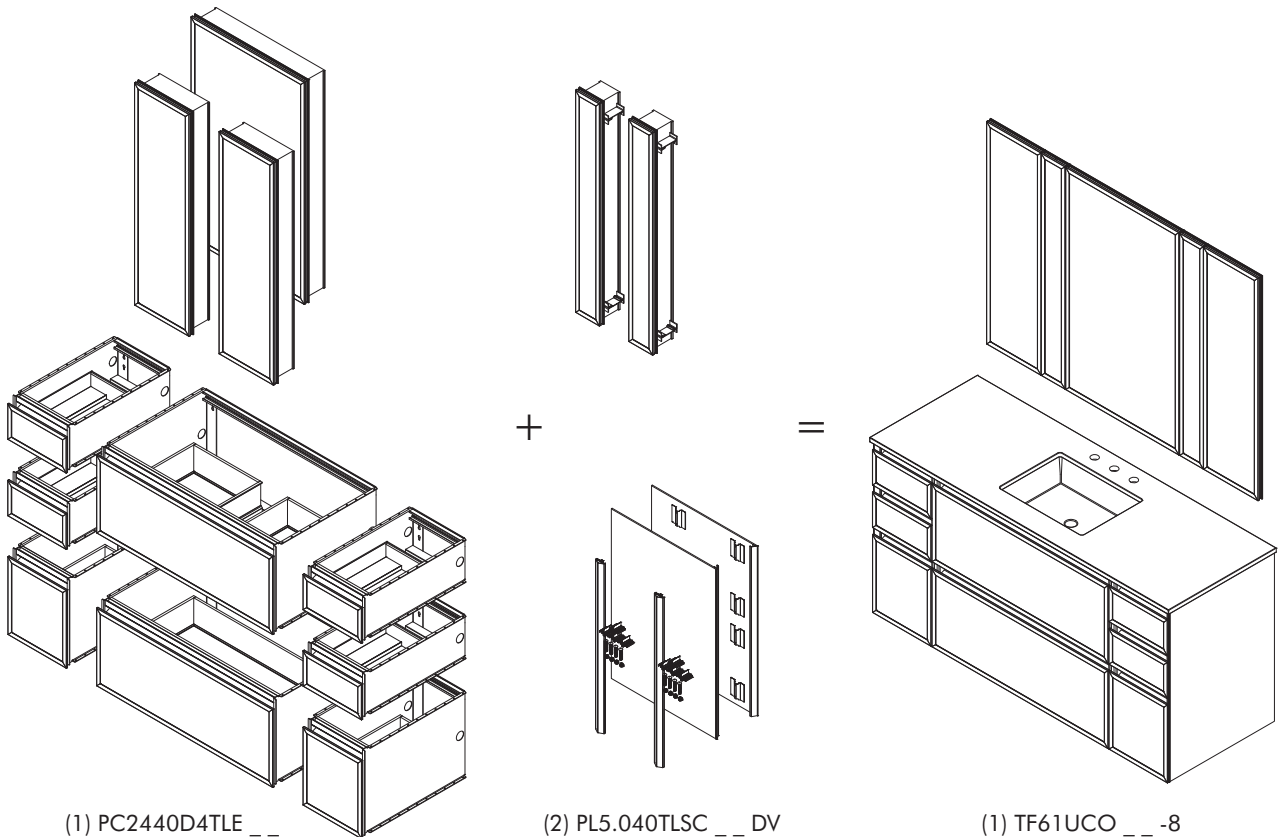

- (1) PC2440D4TLE _ _ _
- (2) PC1240D4TNN _ _ _
- (1) VP36H2D21P _ _ S _ _
- (1) VP36H2D21F _ _ S _ _
- (4) VP12H1D21F _ _ S _ _
- (2) VP12H2D21F _ _ S _ _

- (2) PL5.040TLSC _ _ DV
- (1) VM2SKH4D21- _ _ _
- (2) VMGKITH4
- (1) MGKIT

- (1) TF61UCO _ _ -8

Configuration 2

For more guidance on our modular solutions, visit robern.com/modularity.

Profiles® Vanity Model Number Worksheet

FEATURES

Select Width:

- 12"
- 24"
- 30"
- 36"

Select Height:

- 7-1/2"
- 15"

Select Depth:

- 18"
- 21"

Select Drawer Style:

- Plumbing
- Full
- Tip Out*

Select Glass Finish Color:

Essentials Palette

- Mirror
- Tinted Gray Mirror
- Black
- White

Classic Palette

- Beach
- Matte White
- Matte Gray
- Matte Black

Inspire Palette

- Satin Bronze
- Satin White
- Ocean

Select Option:

- Base Unit (No Night Light)
- Selectable Night Light, 2700K/4000K

Select Metal Frame Finish:

- Chrome
- Polished Nickel
- Matte Gold
- Matte Black

MODEL

VP

- 12
- 24
- 30
- 36

- H1
- H2

- D18
- D21

- P
- F
- T

- 10
- 11
- 20
- 21

- 22
- 26
- 27
- 28

- 12
- 19
- 23

- N
- S

- 76
- 77
- 82
- 83

Notes:

Profiles Vanities have a 4 week lead time.

* Tip Out Drawer only available for 7-1/2" height.

CUSTOMER INFORMATION

Name

Address

City/State/Zip

Telephone

Date Ordered

Profiles® Vanity – VP12 – 12" W x 21" or 18" D



For those who want a high-functioning styling space, that pays homage to an age gone by, the Profiles Collection offers mirrored cabinets, mirrors, vanities, and task lighting in a wide assortment of sizes and finishes to meet the unique needs of any space.

- Glass vanity fronts and side kits available in 11 colors
- Limitless design solutions with ability to mix and match
- Spacious drawers and tip out storage options eliminate clutter and make the daily routine effortless

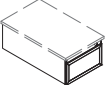
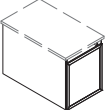

12-1/8" W x 21-3/4" D Vanity		Frame Finish 76, 77, 82, 83	Models		Essentials Palette	Classic Palette	Inspire Palette
Description	Price				Price	Price	
7-1/2" H x 21-3/4" D Vanity – Full Drawer, No Sink							
	Base Unit	76, 77	VP12H1D21F __ N76	VP12H1D21F __ N77	\$ 729.	\$ 1,179.	\$ 1,629.
	With 2700K/ 4000K Night Light		VP12H1D21F __ S76	VP12H1D21F __ S77	\$ 999.	\$ 1,479.	\$ 1,899.
	Base Unit	82, 83	VP12H1D21F __ N82	VP12H1D21F __ N83	\$ 849.	\$ 1,279.	\$ 1,729.
	With 2700K/ 4000K Night Light		VP12H1D21F __ S82	VP12H1D21F __ S83	\$ 1,129.	\$ 1,579.	\$ 1,999.
15" H x 21-3/4" D Vanity – Full Drawer, No Sink							
	Base Unit	76, 77	VP12H2D21F __ N76	VP12H2D21F __ N77	\$ 949.	\$ 1,399.	\$ 1,849.
	With 2700K/ 4000K Night Light		VP12H2D21F __ S76	VP12H2D21F __ S77	\$ 1,229.	\$ 1,679.	\$ 2,149.
	Base Unit	82, 83	VP12H2D21F __ N82	VP12H2D21F __ N83	\$ 1,049.	\$ 1,529.	\$ 1,949.
	With 2700K/ 4000K Night Light		VP12H2D21F __ S82	VP12H2D21F __ S83	\$ 1,329.	\$ 1,799.	\$ 2,249.

Vanity top and side kits sold separately.

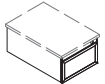
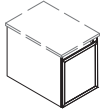
12-1/8" W x 18-3/4" D Vanity		Frame Finish 76, 77, 82, 83	Models		Essentials Palette	Classic Palette	Inspire Palette
Description	Price				Price	Price	
7-1/2" H x 18-3/4" D Vanity – Full Drawer, No Sink							
	Base Unit	76, 77	VP12H1D18F __ N76	VP12H1D18F __ N77	\$ 729.	\$ 1,179.	\$ 1,629.
	With 2700K/ 4000K Night Light		VP12H1D18F __ S76	VP12H1D18F __ S77	\$ 999.	\$ 1,479.	\$ 1,899.
	Base Unit	82, 83	VP12H1D18F __ N82	VP12H1D18F __ N83	\$ 849.	\$ 1,279.	\$ 1,729.
	With 2700K/ 4000K Night Light		VP12H1D18F __ S82	VP12H1D18F __ S83	\$ 1,129.	\$ 1,579.	\$ 1,999.
15" H x 18-3/4" D Vanity – Full Drawer, No Sink							
	Base Unit	76, 77	VP12H2D18F __ N76	VP12H2D18F __ N77	\$ 949.	\$ 1,399.	\$ 1,849.
	With 2700K/ 4000K Night Light		VP12H2D18F __ S76	VP12H2D18F __ S77	\$ 1,229.	\$ 1,679.	\$ 2,149.
	Base Unit	82, 83	VP12H2D18F __ N82	VP12H2D18F __ N83	\$ 1,049.	\$ 1,529.	\$ 1,949.
	With 2700K/ 4000K Night Light		VP12H2D18F __ S82	VP12H2D18F __ S83	\$ 1,329.	\$ 1,799.	\$ 2,249.

Vanity top and side kits sold separately.

Fill in __ designator to Model listed above with desired color listed on the following page.
Example: VP12H2D18F26S76.

See Vanity Color/Finish Options, Vanity Tops, Accessories & Options on the following page.

Profiles® Vanity – VP12 – 12" W x 21" or 18" D

Vanity Glass Colors and Frame Finishes

Fill in __ designator to Model listed at left with desired color. Example: VP12H2D18F26S76.

Essentials Palette

- 10 Mirror
- 11 Tinted Gray Mirror
- 20 Black
- 21 White

Classic Palette

- 22 Beach
- 26 Matte White
- 27 Matte Gray
- 28 Matte Black

Inspire Palette

- 12 Satin Bronze
- 19 Satin White
- 23 Ocean

Frame Finishes

- 76 Chrome
- 77 Polished Nickel
- 82 Matte Gold
- 83 Matte Black

13" W x 19" D & 13" W x 22" D Vanity Tops

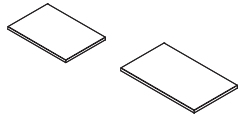

Description

- TF13G __ Engineered Stone Vanity Top (No Sink)
- TE13G __ Engineered Stone Vanity Top (No Sink)

For Use With Vanity

- 21" D, 12" W Vanities
- 18" D, 12" W Vanities

See Page

- 258
- 258

See Profiles Ganging Reference on page 202.

Add-On Accessories & Options

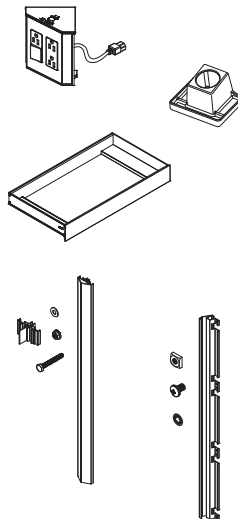

Description

Electric Accessory

- For use in 21" D drawer, with 15" H vanity (H2)
- For use in 18" D drawer, with 15" H vanity (H2)

Model

- VAELECTRIC21
- VAELECTRIC18

Price

- \$ 479.
- \$ 479.

Hair Styling Organizer

- For use in 15" H drawer (H2)

- VAHAIRORG

- \$ 249.

Slim Drawer Insert

- For use in 15" H drawer (H2)

- VADRAWER12X

- \$ 529.

Vanity Ganging Kit – Hardware required when combining two or more vanities (each connection point)

- 7-1/2" H
- 15" H
- 22-1/2" H
- 30" H

- VMGKITH1
- VMGKITH2
- VMGKITH3
- VMGKITH4

- \$ 99.
- \$ 99.
- \$ 229.
- \$ 229.

Vanity Alcove Finishing Kit – Hardware required for corner or alcove installations

- 7-1/2" H
- 15" H
- 22-1/2" H
- 30" H

- VMAKITH1
- VMAKITH2
- VMAKITH3
- VMAKITH4

- \$ 99.
- \$ 99.
- \$ 229.
- \$ 229.

See additional Accessories on pages 273 – 273.

Vanity Side Kits (sold separately)

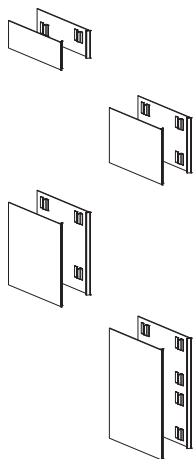

Description

Model

Essentials Palette

Classic Palette

Inspire Palette

Vanity Side Kits – Includes glass panel(s) & hardware (see Color Options above)

Single, 7-1/2" H, 21" D	VM1SKH1D21-__	\$ 229.	\$ 299.	\$ 349.
Pair, 7-1/2" H, 21" D	VM2SKH1D21-__	\$ 349.	\$ 479.	\$ 579.
Single, 7-1/2" H, 18" D	VM1SKH1D18-__	\$ 229.	\$ 299.	\$ 349.
Pair, 7-1/2" H, 18" D	VM2SKH1D18-__	\$ 349.	\$ 479.	\$ 579.
Single, 15" H, 21" D	VM1SKH2D21-__	\$ 299.	\$ 349.	\$ 429.
Pair, 15" H, 21" D	VM2SKH2D21-__	\$ 429.	\$ 529.	\$ 649.
Single, 15" H, 18" D	VM1SKH2D18-__	\$ 299.	\$ 349.	\$ 429.
Pair, 15" H, 18" D	VM2SKH2D18-__	\$ 429.	\$ 529.	\$ 649.
Single, 22-1/2" H, 21" D	VM1SKH3D21-__	\$ 349.	\$ 429.	\$ 479.
Pair, 22-1/2" H, 21" D	VM2SKH3D21-__	\$ 579.	\$ 699.	\$ 829.
Single, 22-1/2" H, 18" D	VM1SKH3D18-__	\$ 349.	\$ 429.	\$ 479.
Pair, 22-1/2" H, 18" D	VM2SKH3D18-__	\$ 579.	\$ 699.	\$ 829.
Single, 30" H, 21" D	VM1SKH4D21-__	\$ 429.	\$ 479.	\$ 529.
Pair, 30" H, 21" D	VM2SKH4D21-__	\$ 699.	\$ 829.	\$ 929.
Single, 30" H, 18" D	VM1SKH4D18-__	\$ 429.	\$ 479.	\$ 529.
Pair, 30" H, 18" D	VM2SKH4D18-__	\$ 699.	\$ 829.	\$ 929.

Note: You must choose one side kit or alcove kit for every exposed side.

SEE PAGES 200 – 201 FOR TIPS AND FEATURES.

Profiles® Vanity – VP24 – 24" W x 21" D



For those who want a high-functioning styling space, that pays homage to an age gone by, the Profiles Collection offers mirrored cabinets, mirrors, vanities, and task lighting in a wide assortment of sizes and finishes to meet the unique needs of any space.

- Glass vanity fronts and side kits available in 11 colors
- Limitless design solutions with ability to mix and match
- Spacious drawers and tip out storage options eliminate clutter and make the daily routine effortless



Four Week Lead Time



Modular



Electrical Outlet

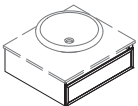
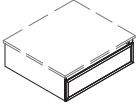
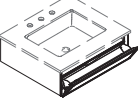
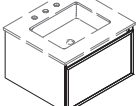
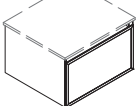

Night Light

24-1/8" W x 21-3/4" D Vanity		Frame Finish	Models		Essentials Palette	Classic Palette	Inspire Palette
Description		76, 77, 82, 83			10, 11, 20, 21 Price	22, 26, 27, 28 Price	12, 19, 23 Price
7-1/2" H Vanity – Plumbing Drawer, No Undercounter Sink							
	Base Unit	76, 77	VP24H1D21P __ N76	VP24H1D21P __ N77	\$ 1,279.	\$ 1,729.	\$ 2,199.
	With 2700K/4000K Night Light		VP24H1D21P __ S76	VP24H1D21P __ S77	\$ 1,629.	\$ 2,099.	\$ 2,529.
	Base Unit	82, 83	VP24H1D21P __ N82	VP24H1D21P __ N83	\$ 1,399.	\$ 1,849.	\$ 2,299.
	With 2700K/4000K Night Light		VP24H1D21P __ S82	VP24H1D21P __ S83	\$ 1,729.	\$ 2,199.	\$ 2,629.
7-1/2" H Vanity – Full Drawer, No Sink							
	Base Unit	76, 77	VP24H1D21F __ N76	VP24H1D21F __ N77	\$ 1,279.	\$ 1,729.	\$ 2,199.
	With 2700K/4000K Night Light		VP24H1D21F __ S76	VP24H1D21F __ S77	\$ 1,629.	\$ 2,099.	\$ 2,529.
	Base Unit	82, 83	VP24H1D21F __ N82	VP24H1D21F __ N83	\$ 1,399.	\$ 1,849.	\$ 2,299.
	With 2700K/4000K Night Light		VP24H1D21F __ S82	VP24H1D21F __ S83	\$ 1,729.	\$ 2,199.	\$ 2,629.
7-1/2" H Vanity – Tip Out Drawer							
	Base Unit	76, 77	VP24H1D21T __ N76	VP24H1D21T __ N77	\$ 1,279.	\$ 1,729.	\$ 2,199.
	With 2700K/4000K Night Light		VP24H1D21T __ S76	VP24H1D21T __ S77	\$ 1,629.	\$ 2,099.	\$ 2,529.
	Base Unit	82, 83	VP24H1D21T __ N82	VP24H1D21T __ N83	\$ 1,399.	\$ 1,849.	\$ 2,299.
	With 2700K/4000K Night Light		VP24H1D21T __ S82	VP24H1D21T __ S83	\$ 1,729.	\$ 2,199.	\$ 2,629.
15" H Vanity – Plumbing Drawer							
	Base Unit	76, 77	VP24H2D21P __ N76	VP24H2D21P __ N77	\$ 1,529.	\$ 1,949.	\$ 2,429.
	With 2700K/4000K Night Light		VP24H2D21P __ S76	VP24H2D21P __ S77	\$ 1,849.	\$ 2,299.	\$ 2,749.
	Base Unit	82, 83	VP24H2D21P __ N82	VP24H2D21P __ N83	\$ 1,629.	\$ 2,099.	\$ 2,529.
	With 2700K/4000K Night Light		VP24H2D21P __ S82	VP24H2D21P __ S83	\$ 1,949.	\$ 2,429.	\$ 2,849.
15" H Vanity – Full Drawer, No Sink							
	Base Unit	76, 77	VP24H2D21F __ N76	VP24H2D21F __ N77	\$ 1,529.	\$ 1,949.	\$ 2,429.
	With 2700K/4000K Night Light		VP24H2D21F __ S76	VP24H2D21F __ S77	\$ 1,849.	\$ 2,299.	\$ 2,749.
	Base Unit	82, 83	VP24H2D21F __ N82	VP24H2D21F __ N83	\$ 1,629.	\$ 2,099.	\$ 2,529.
	With 2700K/4000K Night Light		VP24H2D21F __ S82	VP24H2D21F __ S83	\$ 1,949.	\$ 2,429.	\$ 2,849.

Vanity top, sink and side kits sold separately.

Fill in __ designator to Model listed above with desired color listed on the following page.
Example: VP24H2D21F26S76.

See Vanity Color/Finish Options, Vanity Tops, Accessories & Options on the following page.

Profiles® Vanity – VP24 – 24" W x 21" D

Vanity Glass Colors and Frame Finishes

Fill in __ designator to Model listed at left with desired color. Example: VP24H2D21F26S76.

Essentials Palette

- 10 Mirror
- 11 Tinted Gray Mirror
- 20 Black
- 21 White

Classic Palette

- 22 Beach
- 26 Matte White
- 27 Matte Gray
- 28 Matte Black

Inspire Palette

- 12 Satin Bronze
- 19 Satin White
- 23 Ocean

Frame Finishes

- 76 Chrome
- 77 Polished Nickel
- 82 Matte Gold
- 83 Matte Black

25" W x 22" D Vanity Tops – For 21" D Vanities

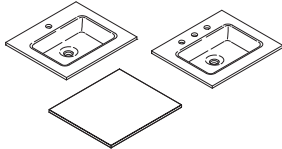

Description

- TS25UCN __ Glass Vanity Top
- TF25UCO __ Engineered Stone Vanity Top
- TF25G __ Engineered Stone Vanity Top (No Sink)

For Use With Vanity

- Plumbing & Tip Out Drawer
- Plumbing & Tip Out Drawer
- 24" W Vanities

See Page

- 258
- 258
- 258

**Undercounter Sink available for Custom Countertop – see page 265.
See Profiles Ganging Reference on page 202.**

Add-On Accessories & Options

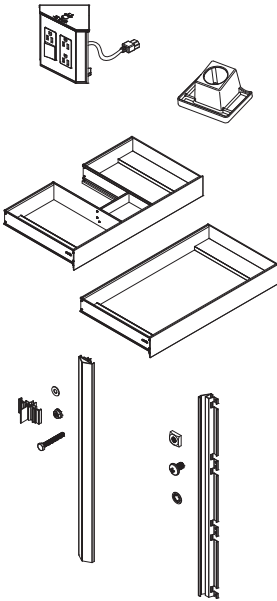

Description

Electric Accessory

For use in 15" H plumbing or full drawer (H2)

Model

VAELECTRIC21

Price

\$ 479.

Hair Styling Organizer

For use in 15" H full drawer (H2)

VAHAIRORG

\$ 249.

Slim Drawer Insert

For use in 15" H plumbing drawer (H2)

VADRAWER24P

\$ 649.

For use in 15" H full drawer (H2)

VADRAWER24X

\$ 649.

Note: Not for use with plumbing drawer undercounter sink installations or with Robern's stone vanity tops.
Can be used in above-counter vessel installations.

Vanity Ganging Kit – Hardware required when combining two or more vanities (each connection point)

7-1/2" H

VMGKITH1

\$ 99.

15" H

VMGKITH2

\$ 99.

22-1/2" H

VMGKITH3

\$ 229.

30" H

VMGKITH4

\$ 229.

Vanity Alcove Finishing Kit – Hardware required for corner or alcove installations

7-1/2" H

VMAKITH1

\$ 99.

15" H

VMAKITH2

\$ 99.

22-1/2" H

VMAKITH3

\$ 229.

30" H

VMAKITH4

\$ 229.

See additional Accessories on pages 273 – 273.

Vanity Side Kits (sold separately)

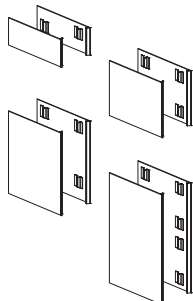

Description

Model

Essentials Palette

Classic Palette

Inspire Palette

Vanity Side Kits – Includes glass panel(s) & hardware (see Color Options above)

Single, 7-1/2" H, 21" D

VM1SKH1D21- __

\$ 229.

\$ 299.

\$ 349.

Pair, 7-1/2" H, 21" D

VM2SKH1D21- __

\$ 349.

\$ 479.

\$ 579.

Single, 15" H, 21" D

VM1SKH2D21- __

\$ 299.

\$ 349.

\$ 429.

Pair, 15" H, 21" D

VM2SKH2D21- __

\$ 429.

\$ 529.

\$ 649.

Single, 22-1/2" H, 21" D

VM1SKH3D21- __

\$ 349.

\$ 429.

\$ 479.

Pair, 22-1/2" H, 21" D

VM2SKH3D21- __

\$ 579.

\$ 699.

\$ 829.

Single, 30" H, 21" D

VM1SKH4D21- __

\$ 429.

\$ 479.

\$ 529.

Pair, 30" H, 21" D

VM2SKH4D21- __

\$ 699.

\$ 829.

\$ 929.

Note: You must choose one side kit or alcove kit for every exposed side.

SEE PAGES 200 – 201 FOR TIPS AND FEATURES.

Profiles® Vanity – VP24 – 24" W x 18" D



For those who want a high-functioning styling space, that pays homage to an age gone by, the Profiles Collection offers mirrored cabinets, mirrors, vanities, and task lighting in a wide assortment of sizes and finishes to meet the unique needs of any space.

- Glass vanity fronts and side kits available in 11 colors
- Limitless design solutions with ability to mix and match
- Spacious drawers and tip out storage options eliminate clutter and make the daily routine effortless



Four Week Lead Time



Modular



Electrical Outlet



Night Light

24-1/8" W x 18-3/4" D Vanity		Frame Finish	Models		Essentials Palette	Classic Palette	Inspire Palette
Description		76, 77, 82, 83			10, 11, 20, 21 Price	22, 26, 27, 28 Price	12, 19, 23 Price
7-1/2" H Vanity – Plumbing Drawer, No Undercounter Sink							
	Base Unit	76, 77	VP24H1D18P __ N76	VP24H1D18P __ N77	\$ 1,279.	\$ 1,729.	\$ 2,199.
	With 2700K/4000K Night Light		VP24H1D18P __ S76	VP24H1D18P __ S77	\$ 1,629.	\$ 2,099.	\$ 2,529.
	Base Unit	82, 83	VP24H1D18P __ N82	VP24H1D18P __ N83	\$ 1,399.	\$ 1,849.	\$ 2,299.
	With 2700K/4000K Night Light		VP24H1D18P __ S82	VP24H1D18P __ S83	\$ 1,729.	\$ 2,199.	\$ 2,629.
7-1/2" H Vanity – Full Drawer, No Sink							
	Base Unit	76, 77	VP24H1D18F __ N76	VP24H1D18F __ N77	\$ 1,279.	\$ 1,729.	\$ 2,199.
	With 2700K/4000K Night Light		VP24H1D18F __ S76	VP24H1D18F __ S77	\$ 1,629.	\$ 2,099.	\$ 2,529.
	Base Unit	82, 83	VP24H1D18F __ N82	VP24H1D18F __ N83	\$ 1,399.	\$ 1,849.	\$ 2,299.
	With 2700K/4000K Night Light		VP24H1D18F __ S82	VP24H1D18F __ S83	\$ 1,729.	\$ 2,199.	\$ 2,629.
7-1/2" H Vanity – Tip Out Drawer							
	Base Unit	76, 77	VP24H1D18T __ N76	VP24H1D18T __ N77	\$ 1,279.	\$ 1,729.	\$ 2,199.
	With 2700K/4000K Night Light		VP24H1D18T __ S76	VP24H1D18T __ S77	\$ 1,629.	\$ 2,099.	\$ 2,529.
	Base Unit	82, 83	VP24H1D18T __ N82	VP24H1D18T __ N83	\$ 1,399.	\$ 1,849.	\$ 2,299.
	With 2700K/4000K Night Light		VP24H1D18T __ S82	VP24H1D18T __ S83	\$ 1,729.	\$ 2,199.	\$ 2,629.
15" H Vanity – Plumbing Drawer							
	Base Unit	76, 77	VP24H2D18P __ N76	VP24H2D18P __ N77	\$ 1,529.	\$ 1,949.	\$ 2,429.
	With 2700K/4000K Night Light		VP24H2D18P __ S76	VP24H2D18P __ S77	\$ 1,849.	\$ 2,299.	\$ 2,749.
	Base Unit	82, 83	VP24H2D18P __ N82	VP24H2D18P __ N83	\$ 1,629.	\$ 2,099.	\$ 2,529.
	With 2700K/4000K Night Light		VP24H2D18P __ S82	VP24H2D18P __ S83	\$ 1,949.	\$ 2,429.	\$ 2,849.
15" H Vanity – Full Drawer, No Sink							
	Base Unit	76, 77	VP24H2D18F __ N76	VP24H2D18F __ N77	\$ 1,529.	\$ 1,949.	\$ 2,429.
	With 2700K/4000K Night Light		VP24H2D18F __ S76	VP24H2D18F __ S77	\$ 1,849.	\$ 2,299.	\$ 2,749.
	Base Unit	82, 83	VP24H2D18F __ N82	VP24H2D18F __ N83	\$ 1,629.	\$ 2,099.	\$ 2,529.
	With 2700K/4000K Night Light		VP24H2D18F __ S82	VP24H2D18F __ S83	\$ 1,949.	\$ 2,429.	\$ 2,849.

Vanity top, sink and side kits sold separately.

Fill in __ designator to Model listed above with desired color listed on the following page.
Example: VP24H2D18F26S76.

See Vanity Color/Finish Options, Vanity Tops, Accessories & Options on the following page.

Profiles® Vanity – VP24 – 24" W x 18" D

Vanity Glass Colors and Frame Finishes

Fill in __ designator to Model listed at left with desired color. Example: VP24H2D18F26S76.

Essentials Palette

- 10 Mirror
- 11 Tinted Gray Mirror
- 20 Black
- 21 White

Classic Palette

- 22 Beach
- 26 Matte White
- 27 Matte Gray
- 28 Matte Black

Inspire Palette

- 12 Satin Bronze
- 19 Satin White
- 23 Ocean

Frame Finishes

- 76 Chrome
- 77 Polished Nickel
- 82 Matte Gold
- 83 Matte Black

25" W x 19" D Vanity Tops – For 18" D Vanities

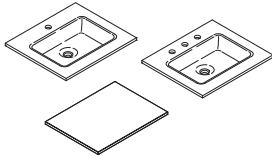

Description	For Use With Vanity	See Page
TC25UCN __ Glass Vanity Top	Plumbing & Tip Out Drawer	258
TE25G __ Engineered Stone Vanity Top (No Sink)	24" W Vanities	258

**Undercounter Sink available for Custom Countertop – see page 265.
See Profiles Ganging Reference on page 202.**

Add-On Accessories & Options

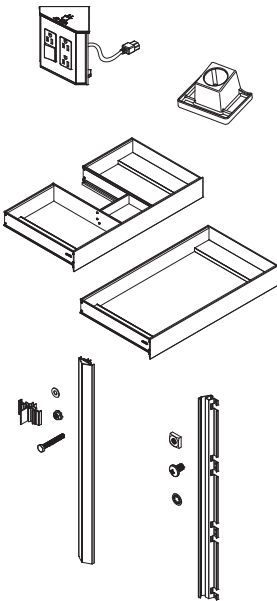

Description	Model	Price
Electric Accessory For use in 15" H plumbing or full drawer (H2)	VAELECTRIC18	\$ 479.
Hair Styling Organizer For use in 15" H full drawer (H2)	VAHAIRORG	\$ 249.
Slim Drawer Insert For use in 15" H plumbing drawer (H2)	VADRAWER24P	\$ 649.
For use in 15" H full drawer (H2)	VADRAWER24X	\$ 649.
Note: Not for use with plumbing drawer undercounter sink installations or with Robern's stone vanity tops. Can be used in above-counter vessel installations.		
Vanity Ganging Kit – Hardware required when combining two or more vanities (each connection point)		
7-1/2" H	VMGKITH1	\$ 99.
15" H	VMGKITH2	\$ 99.
22-1/2" H	VMGKITH3	\$ 229.
30" H	VMGKITH4	\$ 229.
Vanity Alcove Finishing Kit – Hardware required for corner or alcove installations		
7-1/2" H	VMAKITH1	\$ 99.
15" H	VMAKITH2	\$ 99.
22-1/2" H	VMAKITH3	\$ 229.
30" H	VMAKITH4	\$ 229.

See additional Accessories on pages 273 – 273.

Vanity Side Kits (sold separately)

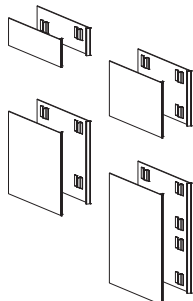

Description	Model	Essentials Palette	Classic Palette	Inspire Palette
Vanity Side Kits – Includes glass panel(s) & hardware (see Color Options above)				
Single, 7-1/2" H, 18" D	VM1SKH1D18-__	\$ 229.	\$ 299.	\$ 349.
Pair, 7-1/2" H, 18" D	VM2SKH1D18-__	\$ 349.	\$ 479.	\$ 579.
Single, 15" H, 18" D	VM1SKH2D18-__	\$ 299.	\$ 349.	\$ 429.
Pair, 15" H, 18" D	VM2SKH2D18-__	\$ 429.	\$ 529.	\$ 649.
Single, 22-1/2" H, 18" D	VM1SKH3D18-__	\$ 349.	\$ 429.	\$ 479.
Pair, 22-1/2" H, 18" D	VM2SKH3D18-__	\$ 579.	\$ 699.	\$ 829.
Single, 30" H, 18" D	VM1SKH4D18-__	\$ 429.	\$ 479.	\$ 529.
Pair, 30" H, 18" D	VM2SKH4D18-__	\$ 699.	\$ 829.	\$ 929.

Note: You must choose one side kit or alcove kit for every exposed side.

SEE PAGES 200 – 201 FOR TIPS AND FEATURES.

Profiles® Vanity – VP30 – 30" W x 21" D



For those who want a high-functioning styling space, that pays homage to an age gone by, the Profiles Collection offers mirrored cabinets, mirrors, vanities, and task lighting in a wide assortment of sizes and finishes to meet the unique needs of any space.

- Glass vanity fronts and side kits available in 11 colors
- Limitless design solutions with ability to mix and match
- Spacious drawers and tip out storage options eliminate clutter and make the daily routine effortless



Four Week
Lead Time



Modular



Electrical
Outlet



Night
Light

30-1/8" W x 21-3/4" D Vanity		Frame Finish	Models		Essentials Palette	Classic Palette	Inspire Palette
Description		76, 77, 82, 83			10, 11, 20, 21 Price	22, 26, 27, 28 Price	12, 19, 23 Price
7-1/2" H Vanity – Plumbing Drawer, No Undercounter Sink							
	Base Unit	76, 77	VP30H1D21P __ N76	VP30H1D21P __ N77	\$ 1,849.	\$ 2,299.	\$ 2,749.
	With 2700K/4000K Night Light		VP30H1D21P __ S76	VP30H1D21P __ S77	\$ 2,249.	\$ 2,699.	\$ 3,149.
	Base Unit	82, 83	VP30H1D21P __ N82	VP30H1D21P __ N83	\$ 1,949.	\$ 2,429.	\$ 2,849.
	With 2700K/4000K Night Light		VP30H1D21P __ S82	VP30H1D21P __ S83	\$ 2,349.	\$ 2,799.	\$ 3,249.
7-1/2" H Vanity – Full Drawer, No Sink							
	Base Unit	76, 77	VP30H1D21F __ N76	VP30H1D21F __ N77	\$ 1,849.	\$ 2,299.	\$ 2,749.
	With 2700K/4000K Night Light		VP30H1D21F __ S76	VP30H1D21F __ S77	\$ 2,249.	\$ 2,699.	\$ 3,149.
	Base Unit	82, 83	VP30H1D21F __ N82	VP30H1D21F __ N83	\$ 1,949.	\$ 2,429.	\$ 2,849.
	With 2700K/4000K Night Light		VP30H1D21F __ S82	VP30H1D21F __ S83	\$ 2,349.	\$ 2,799.	\$ 3,249.
7-1/2" H Vanity – Tip Out Drawer							
	Base Unit	76, 77	VP30H1D21T __ N76	VP30H1D21T __ N77	\$ 1,849.	\$ 2,299.	\$ 2,749.
	With 2700K/4000K Night Light		VP30H1D21T __ S76	VP30H1D21T __ S77	\$ 2,249.	\$ 2,699.	\$ 3,149.
	Base Unit	82, 83	VP30H1D21T __ N82	VP30H1D21T __ N83	\$ 1,949.	\$ 2,429.	\$ 2,849.
	With 2700K/4000K Night Light		VP30H1D21T __ S82	VP30H1D21T __ S83	\$ 2,349.	\$ 2,799.	\$ 3,249.
15" H Vanity – Plumbing Drawer							
	Base Unit	76, 77	VP30H2D21P __ N76	VP30H2D21P __ N77	\$ 2,099.	\$ 2,529.	\$ 2,979.
	With 2700K/4000K Night Light		VP30H2D21P __ S76	VP30H2D21P __ S77	\$ 2,479.	\$ 2,899.	\$ 3,379.
	Base Unit	82, 83	VP30H2D21P __ N82	VP30H2D21P __ N83	\$ 2,199.	\$ 2,629.	\$ 3,099.
	With 2700K/4000K Night Light		VP30H2D21P __ S82	VP30H2D21P __ S83	\$ 2,579.	\$ 3,029.	\$ 3,479.
15" H Vanity – Full Drawer, No Sink							
	Base Unit	76, 77	VP30H2D21F __ N76	VP30H2D21F __ N77	\$ 2,099.	\$ 2,529.	\$ 2,979.
	With 2700K/4000K Night Light		VP30H2D21F __ S76	VP30H2D21F __ S77	\$ 2,479.	\$ 2,899.	\$ 3,379.
	Base Unit	82, 83	VP30H2D21F __ N82	VP30H2D21F __ N83	\$ 2,199.	\$ 2,629.	\$ 3,099.
	With 2700K/4000K Night Light		VP30H2D21F __ S82	VP30H2D21F __ S83	\$ 2,579.	\$ 3,029.	\$ 3,479.

Vanity top, sink and side kits sold separately.

Fill in __ designator to Model listed above with desired color listed on the following page.
Example: VP30H2D21F26S76.

See Vanity Color/Finish Options, Vanity Tops, Accessories & Options on the following page.

Profiles® Vanity – VP30 – 30" W x 21" D

Vanity Glass Colors and Frame Finishes

Fill in __ designator to Model listed at left with desired color. Example: VP30H2D21F26S76.

Essentials Palette

- 10 Mirror
- 11 Tinted Gray Mirror
- 20 Black
- 21 White

Classic Palette

- 22 Beach
- 26 Matte White
- 27 Matte Gray
- 28 Matte Black

Inspire Palette

- 12 Satin Bronze
- 19 Satin White
- 23 Ocean

Frame Finishes

- 76 Chrome
- 77 Polished Nickel
- 82 Matte Gold
- 83 Matte Black

31" W x 22" D Vanity Tops – For 21" D Vanities

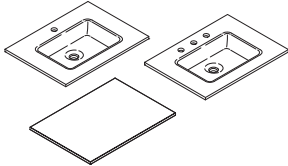

Description

- TS31UCN __ Glass Vanity Top
- TF31UCO __ Engineered Stone Vanity Top
- TF31G __ Engineered Stone Vanity Top (No Sink)

For Use With Vanity

- Plumbing & Tip Out Drawer
- Plumbing & Tip Out Drawer
- 30" W Vanities

See Page

- 259
- 259
- 259

**Undercounter Sink available for Custom Countertop – see page 265.
See Profiles Ganging Reference on page 202.**

Add-On Accessories & Options

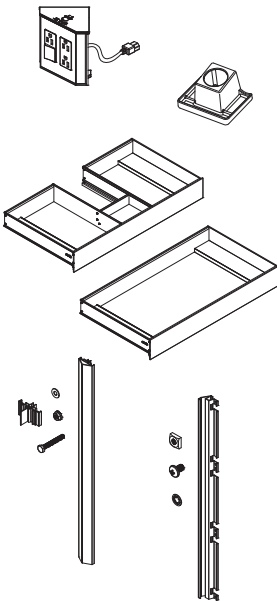

Description

Electric Accessory

For use in 15" H plumbing or full drawer (H2)

Model

VAELECTRIC21

Price

\$ 479.

Hair Styling Organizer

For use in 15" H plumbing (vessel only) or full drawer (H2)

VAHAIRORG

\$ 249.

Slim Drawer Insert

For use in 15" H plumbing drawer (H2)

VADRAWER30P

\$ 749.

For use in 15" H full drawer (H2)

VADRAWER30X

\$ 749.

Note: Not for use with plumbing drawer undercounter sink installations or with Robern's stone vanity tops.
Can be used in above-counter vessel installations.

Vanity Ganging Kit – Hardware required when combining two or more vanities (each connection point)

7-1/2" H

VMGKITH1

\$ 99.

15" H

VMGKITH2

\$ 99.

22-1/2" H

VMGKITH3

\$ 229.

30" H

VMGKITH4

\$ 229.

Vanity Alcove Finishing Kit – Hardware required for corner or alcove installations

7-1/2" H

VMAKITH1

\$ 99.

15" H

VMAKITH2

\$ 99.

22-1/2" H

VMAKITH3

\$ 229.

30" H

VMAKITH4

\$ 229.

See additional Accessories on pages 273 – 273.

Vanity Side Kits (sold separately)

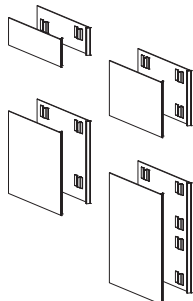

Description

Model

Essentials Palette

Classic Palette

Inspire Palette

Vanity Side Kits – Includes glass panel(s) & hardware (see Color Options above)

Single, 7-1/2" H, 21" D

VM1SKH1D21- __

\$ 229.

\$ 299.

\$ 349.

Pair, 7-1/2" H, 21" D

VM2SKH1D21- __

\$ 349.

\$ 479.

\$ 579.

Single, 15" H, 21" D

VM1SKH2D21- __

\$ 299.

\$ 349.

\$ 429.

Pair, 15" H, 21" D

VM2SKH2D21- __

\$ 429.

\$ 529.

\$ 649.

Single, 22-1/2" H, 21" D

VM1SKH3D21- __

\$ 349.

\$ 429.

\$ 479.

Pair, 22-1/2" H, 21" D

VM2SKH3D21- __

\$ 579.

\$ 699.

\$ 829.

Single, 30" H, 21" D

VM1SKH4D21- __

\$ 429.

\$ 479.

\$ 529.

Pair, 30" H, 21" D

VM2SKH4D21- __

\$ 699.

\$ 829.

\$ 929.

Note: You must choose one side kit or alcove kit for every exposed side.

SEE PAGES 200 – 201 FOR TIPS AND FEATURES.

Profiles® Vanity – VP30 – 30" W x 18" D



For those who want a high-functioning styling space, that pays homage to an age gone by, the Profiles Collection offers mirrored cabinets, mirrors, vanities, and task lighting in a wide assortment of sizes and finishes to meet the unique needs of any space.

- Glass vanity fronts and side kits available in 11 colors
- Limitless design solutions with ability to mix and match
- Spacious drawers and tip out storage options eliminate clutter and make the daily routine effortless



Four Week
Lead Time



Modular



Electrical
Outlet

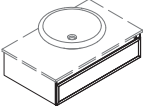
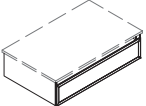
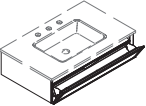
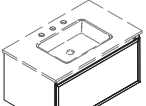
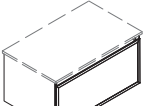

Night
Light

30-1/8" W x 18-3/4" D Vanity		Frame Finish	Models		Essentials Palette	Classic Palette	Inspire Palette
Description		76, 77, 82, 83			10, 11, 20, 21 Price	22, 26, 27, 28 Price	12, 19, 23 Price
7-1/2" H Vanity – Plumbing Drawer, No Undercounter Sink							
	Base Unit	76, 77	VP30H1D18P __ N76	VP30H1D18P __ N77	\$ 1,849.	\$ 2,299.	\$ 2,749.
	With 2700K/4000K Night Light		VP30H1D18P __ S76	VP30H1D18P __ S77	\$ 2,249.	\$ 2,699.	\$ 3,149.
	Base Unit	82, 83	VP30H1D18P __ N82	VP30H1D18P __ N83	\$ 1,949.	\$ 2,429.	\$ 2,849.
	With 2700K/4000K Night Light		VP30H1D18P __ S82	VP30H1D18P __ S83	\$ 2,349.	\$ 2,799.	\$ 3,249.
7-1/2" H Vanity – Full Drawer, No Sink							
	Base Unit	76, 77	VP30H1D18F __ N76	VP30H1D18F __ N77	\$ 1,849.	\$ 2,299.	\$ 2,749.
	With 2700K/4000K Night Light		VP30H1D18F __ S76	VP30H1D18F __ S77	\$ 2,249.	\$ 2,699.	\$ 3,149.
	Base Unit	82, 83	VP30H1D18F __ N82	VP30H1D18F __ N83	\$ 1,949.	\$ 2,429.	\$ 2,849.
	With 2700K/4000K Night Light		VP30H1D18F __ S82	VP30H1D18F __ S83	\$ 2,349.	\$ 2,799.	\$ 3,249.
7-1/2" H Vanity – Tip Out Drawer							
	Base Unit	76, 77	VP30H1D18T __ N76	VP30H1D18T __ N77	\$ 1,849.	\$ 2,299.	\$ 2,749.
	With 2700K/4000K Night Light		VP30H1D18T __ S76	VP30H1D18T __ S77	\$ 2,249.	\$ 2,699.	\$ 3,149.
	Base Unit	82, 83	VP30H1D18T __ N82	VP30H1D18T __ N83	\$ 1,949.	\$ 2,429.	\$ 2,849.
	With 2700K/4000K Night Light		VP30H1D18T __ S82	VP30H1D18T __ S83	\$ 2,349.	\$ 2,799.	\$ 3,249.
15" H Vanity – Plumbing Drawer							
	Base Unit	76, 77	VP30H2D18P __ N76	VP30H2D18P __ N77	\$ 2,099.	\$ 2,529.	\$ 2,979.
	With 2700K/4000K Night Light		VP30H2D18P __ S76	VP30H2D18P __ S77	\$ 2,479.	\$ 2,899.	\$ 3,379.
	Base Unit	82, 83	VP30H2D18P __ N82	VP30H2D18P __ N83	\$ 2,199.	\$ 2,629.	\$ 3,099.
	With 2700K/4000K Night Light		VP30H2D18P __ S82	VP30H2D18P __ S83	\$ 2,579.	\$ 3,029.	\$ 3,479.
15" H Vanity – Full Drawer, No Sink							
	Base Unit	76, 77	VP30H2D18F __ N76	VP30H2D18F __ N77	\$ 2,099.	\$ 2,529.	\$ 2,979.
	With 2700K/4000K Night Light		VP30H2D18F __ S76	VP30H2D18F __ S77	\$ 2,479.	\$ 2,899.	\$ 3,379.
	Base Unit	82, 83	VP30H2D18F __ N82	VP30H2D18F __ N83	\$ 2,199.	\$ 2,629.	\$ 3,099.
	With 2700K/4000K Night Light		VP30H2D18F __ S82	VP30H2D18F __ S83	\$ 2,579.	\$ 3,029.	\$ 3,479.

Vanity top, sink and side kits sold separately.

Fill in __ designator to Model listed above with desired color listed on the following page.
Example: VP30H2D18F26S76.

See Vanity Color/Finish Options, Vanity Tops, Accessories & Options on the following page.

Profiles® Vanity – VP30 – 30" W x 18" D

Vanity Glass Colors and Frame Finishes

Fill in __ designator to Model listed at left with desired color. Example: VP30H2D18F26S76.

Essentials Palette

- 10 Mirror
- 11 Tinted Gray Mirror
- 20 Black
- 21 White

Classic Palette

- 22 Beach
- 26 Matte White
- 27 Matte Gray
- 28 Matte Black

Inspire Palette

- 12 Satin Bronze
- 19 Satin White
- 23 Ocean

Frame Finishes

- 76 Chrome
- 77 Polished Nickel
- 82 Matte Gold
- 83 Matte Black

31" W x 19" D Vanity Tops – For 18" D Vanities

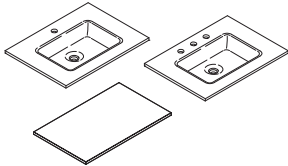

Description

TC31UCN __ Glass Vanity Top

For Use With Vanity

Plumbing & Tip Out Drawer

See Page

259

TE31G __ Engineered Stone Vanity Top
(No Sink)

30" W Vanities

259

**Undercounter Sink available for Custom Countertop – see page 265.
See Profiles Ganging Reference on page 202.**

Add-On Accessories & Options

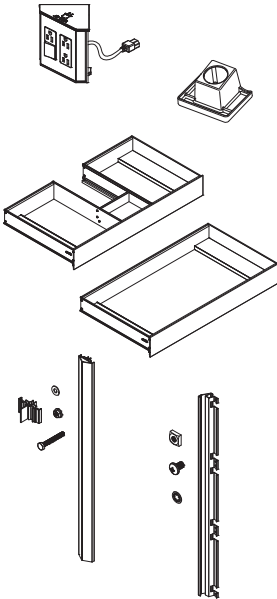

Description

Electric Accessory

For use in 15" H plumbing or full drawer (H2)

Model

VAELECTRIC18

Price

\$ 479.

Hair Styling Organizer

For use in 15" H plumbing (vessel only) or full drawer (H2)

VAHAIRORG

\$ 249.

Slim Drawer Insert

For use in 15" H plumbing drawer (H2)

VADRAWER30P

\$ 749.

For use in 15" H full drawer (H2)

VADRAWER30X

\$ 749.

Note: Not for use with plumbing drawer undercounter sink installations or with Robern's stone vanity tops.
Can be used in above-counter vessel installations.

Vanity Ganging Kit – Hardware required when combining two or more vanities (each connection point)

7-1/2" H

VMGKITH1

\$ 99.

15" H

VMGKITH2

\$ 99.

22-1/2" H

VMGKITH3

\$ 229.

30" H

VMGKITH4

\$ 229.

Vanity Alcove Finishing Kit – Hardware required for corner or alcove installations

7-1/2" H

VMAKITH1

\$ 99.

15" H

VMAKITH2

\$ 99.

22-1/2" H

VMAKITH3

\$ 229.

30" H

VMAKITH4

\$ 229.

See additional Accessories on pages 273 – 273.

Vanity Side Kits (sold separately)

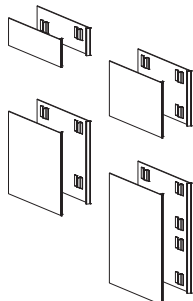

Description

Model

Essentials Palette

Classic Palette

Inspire Palette

Vanity Side Kits – Includes glass panel(s) & hardware (see Color Options above)

Single, 7-1/2" H, 18" D

VM1SKH1D18- __

\$ 229.

\$ 299.

\$ 349.

Pair, 7-1/2" H, 18" D

VM2SKH1D18- __

\$ 349.

\$ 479.

\$ 579.

Single, 15" H, 18" D

VM1SKH2D18- __

\$ 299.

\$ 349.

\$ 429.

Pair, 15" H, 18" D

VM2SKH2D18- __

\$ 429.

\$ 529.

\$ 649.

Single, 22-1/2" H, 18" D

VM1SKH3D18- __

\$ 349.

\$ 429.

\$ 479.

Pair, 22-1/2" H, 18" D

VM2SKH3D18- __

\$ 579.

\$ 699.

\$ 829.

Single, 30" H, 18" D

VM1SKH4D18- __

\$ 429.

\$ 479.

\$ 529.

Pair, 30" H, 18" D

VM2SKH4D18- __

\$ 699.

\$ 829.

\$ 929.

Note: You must choose one side kit or alcove kit for every exposed side.

SEE PAGES 200 – 201 FOR TIPS AND FEATURES.

Profiles® Vanity – VP36 – 36" W x 21" D



For those who want a high-functioning styling space, that pays homage to an age gone by, the Profiles Collection offers mirrored cabinets, mirrors, vanities, and task lighting in a wide assortment of sizes and finishes to meet the unique needs of any space.

- Glass vanity fronts and side kits available in 11 colors
- Limitless design solutions with ability to mix and match
- Spacious drawers and tip out storage options eliminate clutter and make the daily routine effortless



Four Week Lead Time



Modular



Electrical Outlet



Night Light

36-1/8" W x 21-3/4" D Vanity		Frame Finish	Models		Essentials Palette	Classic Palette	Inspire Palette
Description		76, 77, 82, 83			10, 11, 20, 21 Price	22, 26, 27, 28 Price	12, 19, 23 Price
7-1/2" H Vanity – Plumbing Drawer, No Undercounter Sink							
	Base Unit	76, 77	VP36H1D21P __ N76	VP36H1D21P __ N77	\$ 2,429.	\$ 2,849.	\$ 3,299.
	With 2700K/4000K Night Light		VP36H1D21P __ S76	VP36H1D21P __ S77	\$ 2,849.	\$ 3,299.	\$ 3,749.
	Base Unit	82, 83	VP36H1D21P __ N82	VP36H1D21P __ N83	\$ 2,529.	\$ 2,979.	\$ 3,429.
	With 2700K/4000K Night Light		VP36H1D21P __ S82	VP36H1D21P __ S83	\$ 2,979.	\$ 3,429.	\$ 3,849.
7-1/2" H Vanity – Full Drawer, No Sink							
	Base Unit	76, 77	VP36H1D21F __ N76	VP36H1D21F __ N77	\$ 2,429.	\$ 2,849.	\$ 3,299.
	With 2700K/4000K Night Light		VP36H1D21F __ S76	VP36H1D21F __ S77	\$ 2,849.	\$ 3,299.	\$ 3,749.
	Base Unit	82, 83	VP36H1D21F __ N82	VP36H1D21F __ N83	\$ 2,529.	\$ 2,979.	\$ 3,429.
	With 2700K/4000K Night Light		VP36H1D21F __ S82	VP36H1D21F __ S83	\$ 2,979.	\$ 3,429.	\$ 3,849.
7-1/2" H Vanity – Tip Out Drawer							
	Base Unit	76, 77	VP36H1D21T __ N76	VP36H1D21T __ N77	\$ 2,429.	\$ 2,849.	\$ 3,299.
	With 2700K/4000K Night Light		VP36H1D21T __ S76	VP36H1D21T __ S77	\$ 2,849.	\$ 3,299.	\$ 3,749.
	Base Unit	82, 83	VP36H1D21T __ N82	VP36H1D21T __ N83	\$ 2,529.	\$ 2,979.	\$ 3,429.
	With 2700K/4000K Night Light		VP36H1D21T __ S82	VP36H1D21T __ S83	\$ 2,979.	\$ 3,429.	\$ 3,849.
15" H Vanity – Plumbing Drawer							
	Base Unit	76, 77	VP36H2D21P __ N76	VP36H2D21P __ N77	\$ 2,629.	\$ 3,099.	\$ 3,529.
	With 2700K/4000K Night Light		VP36H2D21P __ S76	VP36H2D21P __ S77	\$ 3,099.	\$ 3,529.	\$ 3,999.
	Base Unit	82, 83	VP36H2D21P __ N82	VP36H2D21P __ N83	\$ 2,749.	\$ 3,199.	\$ 3,649.
	With 2700K/4000K Night Light		VP36H2D21P __ S82	VP36H2D21P __ S83	\$ 3,199.	\$ 3,649.	\$ 4,099.
15" H Vanity – Full Drawer, No Sink							
	Base Unit	76, 77	VP36H2D21F __ N76	VP36H2D21F __ N77	\$ 2,629.	\$ 3,099.	\$ 3,529.
	With 2700K/4000K Night Light		VP36H2D21F __ S76	VP36H2D21F __ S77	\$ 3,099.	\$ 3,529.	\$ 3,999.
	Base Unit	82, 83	VP36H2D21F __ N82	VP36H2D21F __ N83	\$ 2,749.	\$ 3,199.	\$ 3,649.
	With 2700K/4000K Night Light		VP36H2D21F __ S82	VP36H2D21F __ S83	\$ 3,199.	\$ 3,649.	\$ 4,099.

Vanity top, sink and side kits sold separately.

Fill in __ designator to Model listed above with desired color listed on the following page.
Example: VP36H2D21F26S76.

See Vanity Color/Finish Options, Vanity Tops, Accessories & Options on the following page.

Profiles® Vanity – VP36 – 36" W x 21" D

Vanity Glass Colors and Frame Finishes

Fill in __ designator to Model listed at left with desired color. Example: VP36H2D21F26S76.

Essentials Palette

- 10 Mirror
- 11 Tinted Gray Mirror
- 20 Black
- 21 White

Classic Palette

- 22 Beach
- 26 Matte White
- 27 Matte Gray
- 28 Matte Black

Inspire Palette

- 12 Satin Bronze
- 19 Satin White
- 23 Ocean

Frame Finishes

- 76 Chrome
- 77 Polished Nickel
- 82 Matte Gold
- 83 Matte Black

37" W x 22" D Vanity Tops – For 21" D Vanities

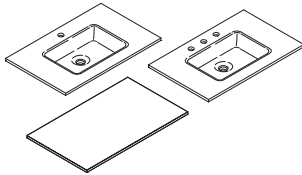

Description	For Use With Vanity	See Page
TF37UCO __ Engineered Stone Vanity Top	Plumbing & Tip Out Drawer	260
TF37G __ Engineered Stone Vanity Top (No Sink)	36" W Vanities	260

Undercounter Sink available for Custom Countertop – see page 265.
See Profiles Ganging Reference on page 202.

Add-On Accessories & Options

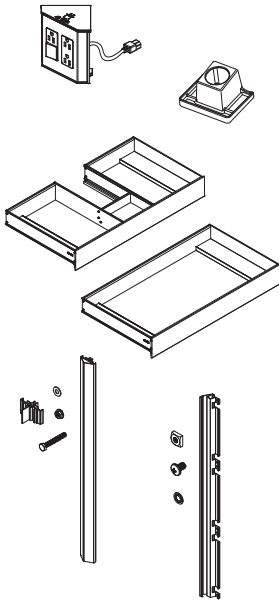

Description	Model	Price
Electric Accessory For use in 15" H plumbing or full drawer (H2)	VAELECTRIC21	\$ 479.
Hair Styling Organizer For use in 15" H plumbing (vessel only) or full drawer (H2)	VAHAIRORG	\$ 249.
Slim Drawer Insert For use in 15" H plumbing drawer (H2)	VADRAWER36P	\$ 829.
For use in 15" H full drawer (H2)	VADRAWER36X	\$ 829.
Note: Not for use with plumbing drawer undercounter sink installations or with Robern's stone vanity tops. Can be used in above-counter vessel installations.		
Vanity Ganging Kit – Hardware required when combining two or more vanities (each connection point)		
7-1/2" H	VMGKITH1	\$ 99.
15" H	VMGKITH2	\$ 99.
22-1/2" H	VMGKITH3	\$ 229.
30" H	VMGKITH4	\$ 229.
Vanity Alcove Finishing Kit – Hardware required for corner or alcove installations		
7-1/2" H	VMAKITH1	\$ 99.
15" H	VMAKITH2	\$ 99.
22-1/2" H	VMAKITH3	\$ 229.
30" H	VMAKITH4	\$ 229.

See additional Accessories on pages 273 – 273.

Vanity Side Kits (sold separately)

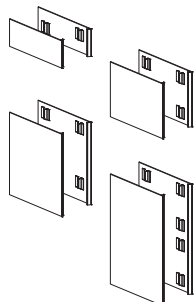

Description	Model	Essentials Palette	Classic Palette	Inspire Palette
Vanity Side Kits – Includes glass panel(s) & hardware (see Color Options above)				
Single, 7-1/2" H, 21" D	VM1SKH1D21- __	\$ 229.	\$ 299.	\$ 349.
Pair, 7-1/2" H, 21" D	VM2SKH1D21- __	\$ 349.	\$ 479.	\$ 579.
Single, 15" H, 21" D	VM1SKH2D21- __	\$ 299.	\$ 349.	\$ 429.
Pair, 15" H, 21" D	VM2SKH2D21- __	\$ 429.	\$ 529.	\$ 649.
Single, 22-1/2" H, 21" D	VM1SKH3D21- __	\$ 349.	\$ 429.	\$ 479.
Pair, 22-1/2" H, 21" D	VM2SKH3D21- __	\$ 579.	\$ 699.	\$ 829.
Single, 30" H, 21" D	VM1SKH4D21- __	\$ 429.	\$ 479.	\$ 529.
Pair, 30" H, 21" D	VM2SKH4D21- __	\$ 699.	\$ 829.	\$ 929.

Note: You must choose one side kit or alcove kit for every exposed side.

SEE PAGES 200 – 201 FOR TIPS AND FEATURES.

Profiles® Vanity – VP36 – 36" W x 18" D



For those who want a high-functioning styling space, that pays homage to an age gone by, the Profiles Collection offers mirrored cabinets, mirrors, vanities, and task lighting in a wide assortment of sizes and finishes to meet the unique needs of any space.

- Glass vanity fronts and side kits available in 11 colors
- Limitless design solutions with ability to mix and match
- Spacious drawers and tip out storage options eliminate clutter and make the daily routine effortless



Four Week Lead Time



Modular



Electrical Outlet



Night Light

36-1/8" W x 18-3/4" D Vanity		Frame Finish	Models		Essentials Palette	Classic Palette	Inspire Palette
Description		76, 77, 82, 83			10, 11, 20, 21 Price	22, 26, 27, 28 Price	12, 19, 23 Price
7-1/2" H Vanity – Plumbing Drawer, No Undercounter Sink							
	Base Unit	76, 77	VP36H1D18P __ N76	VP36H1D18P __ N77	\$ 2,429.	\$ 2,849.	\$ 3,299.
	With 2700K/4000K Night Light		VP36H1D18P __ S76	VP36H1D18P __ S77	\$ 2,849.	\$ 3,299.	\$ 3,749.
	Base Unit	82, 83	VP36H1D18P __ N82	VP36H1D18P __ N83	\$ 2,529.	\$ 2,979.	\$ 3,429.
	With 2700K/4000K Night Light		VP36H1D18P __ S82	VP36H1D18P __ S83	\$ 2,979.	\$ 3,429.	\$ 3,849.
7-1/2" H Vanity – Full Drawer, No Sink							
	Base Unit	76, 77	VP36H1D18F __ N76	VP36H1D18F __ N77	\$ 2,429.	\$ 2,849.	\$ 3,299.
	With 2700K/4000K Night Light		VP36H1D18F __ S76	VP36H1D18F __ S77	\$ 2,849.	\$ 3,299.	\$ 3,749.
	Base Unit	82, 83	VP36H1D18F __ N82	VP36H1D18F __ N83	\$ 2,529.	\$ 2,979.	\$ 3,429.
	With 2700K/4000K Night Light		VP36H1D18F __ S82	VP36H1D18F __ S83	\$ 2,979.	\$ 3,429.	\$ 3,849.
7-1/2" H Vanity – Tip Out Drawer							
	Base Unit	76, 77	VP36H1D18T __ N76	VP36H1D18T __ N77	\$ 2,429.	\$ 2,849.	\$ 3,299.
	With 2700K/4000K Night Light		VP36H1D18T __ S76	VP36H1D18T __ S77	\$ 2,849.	\$ 3,299.	\$ 3,749.
	Base Unit	82, 83	VP36H1D18T __ N82	VP36H1D18T __ N83	\$ 2,529.	\$ 2,979.	\$ 3,429.
	With 2700K/4000K Night Light		VP36H1D18T __ S82	VP36H1D18T __ S83	\$ 2,979.	\$ 3,429.	\$ 3,849.
15" H Vanity – Plumbing Drawer							
	Base Unit	76, 77	VP36H2D18P __ N76	VP36H2D18P __ N77	\$ 2,629.	\$ 3,099.	\$ 3,529.
	With 2700K/4000K Night Light		VP36H2D18P __ S76	VP36H2D18P __ S77	\$ 3,099.	\$ 3,529.	\$ 3,999.
	Base Unit	82, 83	VP36H2D18P __ N82	VP36H2D18P __ N83	\$ 2,749.	\$ 3,199.	\$ 3,649.
	With 2700K/4000K Night Light		VP36H2D18P __ S82	VP36H2D18P __ S83	\$ 3,199.	\$ 3,649.	\$ 4,099.
15" H Vanity – Full Drawer, No Sink							
	Base Unit	76, 77	VP36H2D18F __ N76	VP36H2D18F __ N77	\$ 2,629.	\$ 3,099.	\$ 3,529.
	With 2700K/4000K Night Light		VP36H2D18F __ S76	VP36H2D18F __ S77	\$ 3,099.	\$ 3,529.	\$ 3,999.
	Base Unit	82, 83	VP36H2D18F __ N82	VP36H2D18F __ N83	\$ 2,749.	\$ 3,199.	\$ 3,649.
	With 2700K/4000K Night Light		VP36H2D18F __ S82	VP36H2D18F __ S83	\$ 3,199.	\$ 3,649.	\$ 4,099.

Vanity top, sink and side kits sold separately.

Fill in __ designator to Model listed above with desired color listed on the following page.
Example: VP36H2D18F26S76.

See Vanity Color/Finish Options, Vanity Tops, Accessories & Options on the following page.

Profiles® Vanity – VP36 – 36" W x 18" D

Vanity Glass Colors and Frame Finishes

Fill in __ designator to Model listed at left with desired color. Example: VP36H2D18F26S76.

Essentials Palette

- 10 Mirror
- 11 Tinted Gray Mirror
- 20 Black
- 21 White

Classic Palette

- 22 Beach
- 26 Matte White
- 27 Matte Gray
- 28 Matte Black

Inspire Palette

- 12 Satin Bronze
- 19 Satin White
- 23 Ocean

Frame Finishes

- 76 Chrome
- 77 Polished Nickel
- 82 Matte Gold
- 83 Matte Black

37" W x 19" D Vanity Tops – For 18" D Vanities

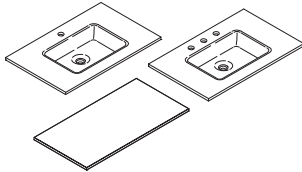

Description	For Use With Vanity	See Page
TC37UCN __ Glass Vanity Top	Plumbing & Tip Out Drawer	260
TE37G __ Engineered Stone Vanity Top (No Sink)	36" W Vanities	260

**Undercounter Sink available for Custom Countertop – see page 265.
See Profiles Ganging Reference on page 202.**

Add-On Accessories & Options

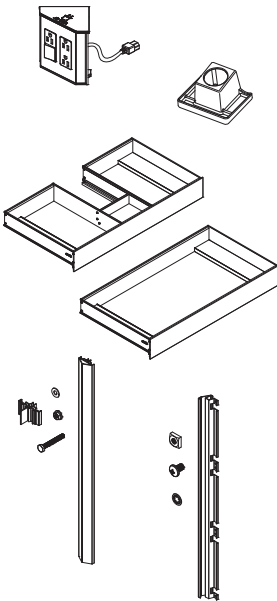

Description	Model	Price
Electric Accessory		
For use in 15" H plumbing or full drawer (H2)	VAELECTRIC18	\$ 479.
Hair Styling Organizer		
For use in 15" H plumbing (vessel only) or full drawer (H2)	VAHAIRORG	\$ 249.
Slim Drawer Insert		
For use in 15" H plumbing drawer (H2)	VADRAWER36P	\$ 829.
For use in 15" H full drawer (H2)	VADRAWER36X	\$ 829.
Note: Not for use with plumbing drawer undercounter sink installations or with Robern's stone vanity tops. Can be used in above-counter vessel installations.		
Vanity Ganging Kit – Hardware required when combining two or more vanities (each connection point)		
7-1/2" H	VMGKITH1	\$ 99.
15" H	VMGKITH2	\$ 99.
22-1/2" H	VMGKITH3	\$ 229.
30" H	VMGKITH4	\$ 229.
Vanity Alcove Finishing Kit – Hardware required for corner or alcove installations		
7-1/2" H	VMAKITH1	\$ 99.
15" H	VMAKITH2	\$ 99.
22-1/2" H	VMAKITH3	\$ 229.
30" H	VMAKITH4	\$ 229.

See additional Accessories on pages 273 – 273.

Vanity Side Kits (sold separately)

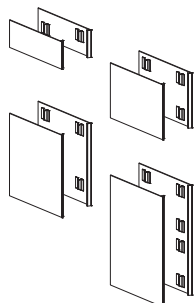

Description	Model	Essentials Palette	Classic Palette	Inspire Palette
Vanity Side Kits – Includes glass panel(s) & hardware (see Color Options above)				
Single, 7-1/2" H, 18" D	VM1SKH1D18-__	\$ 229.	\$ 299.	\$ 349.
Pair, 7-1/2" H, 18" D	VM2SKH1D18-__	\$ 349.	\$ 479.	\$ 579.
Single, 15" H, 18" D	VM1SKH2D18-__	\$ 299.	\$ 349.	\$ 429.
Pair, 15" H, 18" D	VM2SKH2D18-__	\$ 429.	\$ 529.	\$ 649.
Single, 22-1/2" H, 18" D	VM1SKH3D18-__	\$ 349.	\$ 429.	\$ 479.
Pair, 22-1/2" H, 18" D	VM2SKH3D18-__	\$ 579.	\$ 699.	\$ 829.
Single, 30" H, 18" D	VM1SKH4D18-__	\$ 429.	\$ 479.	\$ 529.
Pair, 30" H, 18" D	VM2SKH4D18-__	\$ 699.	\$ 829.	\$ 929.

Note: You must choose one side kit or alcove kit for every exposed side.

SEE PAGES 200 – 201 FOR TIPS AND FEATURES.

V14® Vanities – Table of Contents, Tips & Features

Table of Contents

V14 Vanity Tips & Features	218 – 219
V14 Vanity Model Number Worksheet	220
V14 Vanities	222 – 223
12" Wide V14 Vanity – Side Drawer	222 – 223
24" Wide V14 Vanity	224 – 225
30" Wide V14 Vanity	226 – 227
36" Wide V14 Vanity	228 – 229
48" Wide V14 Vanity	230 – 231
60" Wide V14 Vanity	232 – 233
V14 Vanity Ganging Reference	234 – 235
Vanity Tops	258 – 265
Vanity Accessories	271 – 275

Tips & Features

Dimensions & Weight

- Width: 12-1/4" (311 mm), 24-1/4" (616 mm), 30-1/4" (769 mm), 36-1/4" (921 mm), 48-1/4" (1226 mm), 60-1/4" (1530 mm)
- Height: 14" (356 mm)
- Depth: 21" (533 mm)
- Net Weight: 30 – 157 lbs

Features & Benefits

- Choose between a contemporary look with hand-free operation drawers that open with a gentle push (push-to-open) or a more traditional design featuring a stylish ergonomically designed handle in brushed aluminum trim and slow-close drawers
- Plumbing drawer allows clearance for drain and full drawer allows for maximum storage when plumbing does not exist
- Vanities are modular and can be ganged with other V14 vanities to fit a variety of desired widths
- Vanities include five glass bins for plumbing drawers and four glass bins for full drawers

Features & Benefits (Continued)

- Organization kit: two fully adjustable glass drawer dividers provide storage right where you need it and prevent items from moving and sliding in the drawer
- Night Light Option – integrated LED night light with light bar built into top frame of each drawer, provides soft light to illuminate drawer interior and for wayfinding light in 5000 Kelvin. Night light is ETL certified to UL 2108, CSA Standard C22.2 No. 12
- Electric accessory option: three plugs and a switch that turns off power to the unit to keep appliances safely plugged in

Configurable Options

- Decorative Glass Options: Mirror, 12 decorative gloss and matte finishes
- Drawer Application: full drawer or plumbing drawer
- Drawer Type: push-to-open or slow-close
- Night Light: No Night Light or Integrated LED Night Light in 5000 Kelvin



V14® Vanities – Tips & Features

Tips & Features (Continued)

Construction

- Durable rust-free anodized aluminum and glass construction – resists intense moisture, ensuring long-lasting beauty
- 14" high vanity designed for convenient, customized bathroom storage
- Slow-close drawer features an ergonomically designed, integrated handle in brushed aluminum to coordinate with brushed aluminum trim; handle adds 1" depth to the depth of the vanity
- Uniquely designed push-to-open drawer mechanism provides hand-free operation
- Constructed for wall hanging loads with stone tops
- Glass fronts and side kits are replaceable
- White shatter-protected glass drawer bottoms will not degrade or show wear. Glass dissipates heat to ensure confidence that hot items will not leave heat marks on the bottom of the drawers

Installation

- This installation may require more than one person
- Includes installation hardware and structural bolts
- Special site preparation is required. Wall bracing and Robern supplied hardware are recommended
- The plumbing must be roughed into the plumbing cutout area of the vanity. Refer to the sink rough-in and the vanity rough-in for proper placement. The water supply and drain lines must be installed before installing the vanity.
- Modular units require a ganging kit to ensure proper space and drawer functionality; hardware required when stacking two or more wall hung vanities
- Full drawer units are intended for ganging and stacking and are not designed to accept a sink
- Included side kit adds 1/8" to each side, 1/4" to overall width of vanity (does not apply to 12" W vanities)
- 12" W Unit: single-drawer, no sink (12" W drawers are intended for ganging with other V14 units and do not ship with a side kit)
- 24" W, 30" W and 36" W Units: single plumbing clearance drawer, center sink installation and single full storage drawer, no sink
- 36" W Unit: 24" W unit with left or right plumbing clearance drawer for left or right mount sink installation, and 12" W unit (no sink)

Installation (Continued)

- 48" W Unit: three drawer unit consists of 24" W unit with center plumbing clearance drawer for center mount sink, flanked by two 12" W units (no sink) to left and right
- 60" W Unit: three drawer unit consists 36" W unit with center plumbing clearance drawer for center mount sink, flanked by two 12" W units (no sink) to left and right
- Night light option (L) – 12VDC plug-in transformer in 5000 Kelvin color temperature. Locate wall outlet as per installation instructions.
- Electric Accessory option: 120VAC 20A tamper resistant outlet. Installed within vanity drawer; not recommended to be used in combination with Slim Drawer Insert; recommended in combination with Hair Styling Organizer
- Hair Styling Organizer fits all vanity drawers except 24" plumbing drawer; cannot be used in combination with slim drawer insert; recommended in combination with Electric Accessory
- Slim plumbing drawer insert must be used with an above-counter sink installation; full drawer version can be used in a full drawer - includes four glass bins
- Toilet paper holder is installed directly to the vanity and can be installed on either side of the vanity

Accessories

- In-drawer Electric Accessory (VFELECTRIC): ETL certified to UL 1363, CSA Standard C22.2 No. 21
- Accessory Night Light in 5000 Kelvin (CLEDS12, CLEDS24, CLEDS30, CLEDS36): Night light is ETL certified to UL 2108, CSA Standard C22.2 No. 12
- Slim Plumbing Drawer Insert with four glass bins (VFDRAWER24P, VFDRAWER30P, VFDRAWER36P)
- Slim Full Drawer Insert with four glass bins (VFDRAWER24X, VFDRAWER30X, VFDRAWER36X)
- Glass Bins: divided storage (GLASSBIN6.38), small (GLASSBIN3.25), medium (GLASSBIN5.25), large (GLASSBIN8.5)
- Vanity Accessory Toilet Paper Holder (VATP)
- Hair Styling Organizer (VAHAIRORG): fits most hair dryers and curling irons
- Ganging kits are required when combining two or more V14 vanities (VFGKIT)
- Vanity Stacking Kit required for stacking vanities (VFSTACK)
- Leg kits are optional for stacking vanities (VFSTACKA, VFSTACKL)
- Glass and engineered stone tops with porcelain sink



V14® Vanity Model Number Worksheet

FEATURES

Select Width:

- 24"
- 30"
- 36"
- 48"
- 60"

Drawer Application:

- Plumbing Drawer
- Full Drawer

Sink Installation:

- No Sink (FD models only)
- Center Mount Sink
- Right Mount Sink
- Left Mount Sink

Select Option:

- Base Unit (No Night Light)
- Night Light, 5000K

Select Drawer:

- Push-to-Open
- Slow-Close with Handle

Select Color:

Essentials Palette*

- Mirror 10
- Tinted Gray Mirror 11
- Black 20
- White 21

Classic Palette*

- Beach 22
- Matte White 26
- Matte Gray 27
- Matte Black 28

Inspire Palette*

- Satin Bronze 12
- Satin White 19
- Ocean 23
- Smoke Screen 24
- Silver Screen 25

12" W Drawer Installation:

- Universal Installation —
- Left Drawer L
- Right Drawer R

MODEL

VF

WM

24							
30							
36							
48							
60							
PD							
FD							
X							
C							
R							
L							
N							
L							
P							
S							
10							
11							
20							
21							
22							
26							
27							
28							
12							
19							
23							
24							
25							
—							
L							
R							

Vanities & Tops

Notes:

* Colors available in a 2-week to 4-week lead time.

CUSTOMER INFORMATION

Name _____

Address _____

City/State/Zip _____

Telephone _____

Date Ordered _____

V14® Vanity – VF12 – 12" W – Side Drawer



Designed to mount horizontally or stack vertically, the V14 vanity lets you create a unique layout with smartly designed storage space.

- Choice between slow-close and push-to-open drawers, both providing long-lasting effortless operation
- Provides task and way-finding light by using the night light option



&



Available in a 2-week to 4-week lead time



12-1/4" W x 14" H x 21" D Vanity

		Essentials Palette 10, 11, 20, 21 Price	Classic Palette 22, 26, 27, 28 Price	Inspire Palette 12, 19, 23, 24, 25 Price	
Description	Model				
Side Drawer, No Sink – Universal Installation					
	Base Unit, Slow-Close Drawer	VF12FDXNSWM __	\$ 1,249.	\$ 1,829.	\$ 2,399.
	With 5000K Night Light, Slow-Close Drawer	VF12FDXLSWM __	\$ 1,549.	\$ 2,129.	\$ 2,679.
	Base Unit, Push-to-Open Drawer	VF12FDXNPWM __	\$ 1,249.	\$ 1,829.	\$ 2,399.
	With 5000K Night Light, Push-to-Open Drawer	VF12FDXLPWM __	\$ 1,549.	\$ 2,129.	\$ 2,679.
Side Drawer, No Sink – Left Installation					
	Base Unit, Slow-Close Drawer	VF12FDXNSWM __ L	N/A	N/A	N/A
	With 5000K Night Light, Slow-Close Drawer	VF12FDXLSWM __ L	N/A	N/A	N/A
	Base Unit, Push-to-Open Drawer	VF12FDXNPWM __ L	N/A	N/A	N/A
	With 5000K Night Light, Push-to-Open Drawer	VF12FDXLPWM __ L	N/A	N/A	N/A
Side Drawer, No Sink – Right Installation					
	Base Unit, Slow-Close Drawer	VF12FDXNSWM __ R	N/A	N/A	N/A
	With 5000K Night Light, Slow-Close Drawer	VF12FDXLSWM __ R	N/A	N/A	N/A
	Base Unit, Push-to-Open Drawer	VF12FDXNPWM __ R	N/A	N/A	N/A
	With 5000K Night Light, Push-to-Open Drawer	VF12FDXLPWM __ R	N/A	N/A	N/A

Vanity top sold separately.

Vanity Color Options

Fill in __ designator to Model listed above with desired color. Example: VF12FDXLSWM21R.

Essentials Palette

- 10 Mirror
- 11 Tinted Gray Mirror
- 20 Black
- 21 White

Classic Palette

- 22 Beach
- 26 Matte White
- 27 Matte Gray
- 28 Matte Black

Inspire Palette

- 12 Satin Bronze
- 19 Satin White
- 23 Ocean
- 24 Smoke Screen
- 25 Silver Screen

See Vanity Tops, Accessories & Options on the following page.

V14® Vanity – VF12 – 12" W – Side Drawer

13" W x 22" D Vanity Tops – For 21" D Vanities

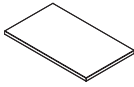

Description	For Use With Vanity	See Page
TF13G __ Engineered Stone Vanity Top (No Sink)	12" W Vanities	258

See V14 Ganging Reference on pages 234 – 235.

Add-On Accessories & Options



Description

Electric Accessory
For use in drawer

Model

VFELECTRIC

Price

\$ 479.



Hair Styling Organizer
For use in drawer

VAHAIRORG

\$ 249.

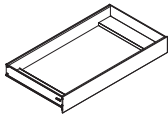

Slim Drawer Insert
For use in drawer

VFDRAWER12X

\$ 529.

See additional Accessories on pages 273 – 273.

Vanity Side Kits (sold separately)

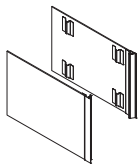

Description	Model	Essentials Palette	Classic Palette	Inspire Palette
		Price	Price	Price
Includes 2 glass assemblies and hardware	VFSK- __	10, 11, 20, 21 \$ 579.	22, 26, 27, 28 \$ 699.	12, 19, 23, 24, 25 \$ 849.

Note: Side Kits are only required as an additional item when the 12" V14 units are being used independently (i.e. not being ganged with other V14 vanities).

Vanity Side Kit Color Options

Fill in __ designator to Model listed above with desired color. Example: VFSK-11.

Essentials Palette

- 10 Mirror
- 11 Tinted Gray Mirror
- 20 Black
- 21 White

Classic Palette

- 22 Beach
- 26 Matte White
- 27 Matte Gray
- 28 Matte Black

Inspire Palette

- 12 Satin Bronze
- 19 Satin White
- 23 Ocean
- 24 Smoke Screen
- 25 Silver Screen

SEE PAGES 218 – 219 FOR TIPS AND FEATURES.

V14® Vanity – VF24 – 24" W



Designed to mount horizontally or stack vertically, the V14 vanity lets you create a unique layout with smartly designed storage space.

- Choice between slow-close and push-to-open drawers, both providing long-lasting effortless operation
- Provides task and way-finding light by using the night light option



Available in a 2-week to 4-week lead time



Modular



Electrical Outlet



Night Light

24-1/4" W x 14" H x 21" D Vanity

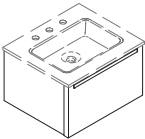
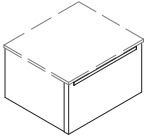
		Essentials Palette 10, 11, 20, 21 Price	Classic Palette 22, 26, 27, 28 Price	Inspire Palette 12, 19, 23, 24, 25 Price	
Description	Model				
Single-Drawer – 24" W Plumbing Drawer, Center Mount Sink					
	Base Unit, Slow-Close Drawer	VF24PDCNSWM __	\$ 1,829.	\$ 2,399.	\$ 2,979.
	With 5000K Night Light, Slow-Close Drawer	VF24PDCLSWM __	\$ 2,179.	\$ 2,749.	\$ 3,299.
	Base Unit, Push-to-Open Drawer	VF24PDCNPWM __	\$ 1,829.	\$ 2,399.	\$ 2,979.
	With 5000K Night Light, Push-to-Open Drawer	VF24PDCLPWM __	\$ 2,179.	\$ 2,749.	\$ 3,299.
Single-Drawer – 24" W Full Storage Drawer, No Sink					
	Base Unit, Slow-Close Drawer	VF24FDXNSWM __	\$ 1,829.	\$ 2,399.	\$ 2,979.
	With 5000K Night Light, Slow-Close Drawer	VF24FDXLSWM __	\$ 2,179.	\$ 2,749.	\$ 3,299.
	Base Unit, Push-to-Open Drawer	VF24FDXNPWM __	\$ 1,829.	\$ 2,399.	\$ 2,979.
	With 5000K Night Light, Push-to-Open Drawer	VF24FDXLPWM __	\$ 2,179.	\$ 2,749.	\$ 3,299.

Vanity top and sink sold separately.

Vanity Color Options

Fill in __ designator to Model listed above with desired color. Example: VF24FDXLPWM20.

Essentials Palette

- 10 Mirror
- 11 Tinted Gray Mirror
- 20 Black
- 21 White

Classic Palette

- 22 Beach
- 26 Matte White
- 27 Matte Gray
- 28 Matte Black

Inspire Palette

- 12 Satin Bronze
- 19 Satin White
- 23 Ocean
- 24 Smoke Screen
- 25 Silver Screen

See Vanity Tops, Accessories & Options on the following page.

V14® Vanity – VF24 – 24" W

25" W x 22" D Vanity Tops – For 21" D Vanities

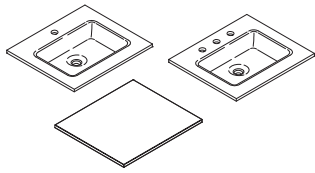

Description	For Use With Vanity	See Page
TS25UCN __ Glass Vanity Top	Plumbing Drawer	258
TF25UCO __ Engineered Stone Vanity Top	Plumbing Drawer	258
TF25G __ Engineered Stone Vanity Top (No Sink)	24" W Vanities	258

**Undercounter Sink available for Custom Countertop – see page 265.
See V14 Ganging Reference on pages 234 – 235.**

Add-On Accessories & Options

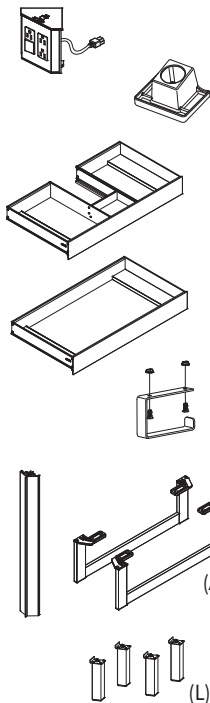

Description	Model	Price
Electric Accessory For use in plumbing or full storage drawer	VFELECTRIC	\$ 479.
Hair Styling Organizer For use in full storage drawer	VAHAIRORG	\$ 249.
Slim Drawer Insert For use in plumbing drawer	VFDRAWER24P	\$ 649.
For use in full storage drawer	VFDRAWER24X	\$ 649.
Note: Not for use with plumbing drawer undercounter sink installations or with Robern's stone vanity tops. Can be used in above-counter vessel installations.		
Vanity Accessory Toilet Paper Holder Can be installed on either side of vanity	VATP	\$ 99.
Vanity Ganging Kit Hardware required when combining two or more V14 vanities (each connection point)	VFGKIT	\$ 99.
Vanity Stacking Kits Hardware required for stacking two or more wall-hung vanities	VFSTACK	\$ 99.
Legs (2) & hardware for stacking two or more wall-hung vanities	VFSTACKA	\$ 299.
Legs (4) & hardware for stacking two or more wall-hung vanities	VFSTACKL	\$ 179.

See additional Accessories on pages 273 – 273.

SEE PAGES 218 – 219 FOR TIPS AND FEATURES.

V14® Vanity – VF30 – 30" W



Designed to mount horizontally or stack vertically, the V14 vanity lets you create a unique layout with smartly designed storage space.

- Choice between slow-close and push-to-open drawers, both providing long-lasting effortless operation
- Provides task and way-finding light by using the night light option



Available in a 2-week to 4-week lead time



30-1/4" W x 14" H x 21" D Vanity

		Essentials Palette 10, 11, 20, 21 Price	Classic Palette 22, 26, 27, 28 Price	Inspire Palette 12, 19, 23, 24, 25 Price	
Description	Model				
Single-Drawer – 30" W Plumbing Drawer, Center Mount Sink					
	Base Unit, Slow-Close Drawer	VF30PDCNSWM __	\$ 2,399.	\$ 2,979.	\$ 3,549.
	With 5000K Night Light, Slow-Close Drawer	VF30PDCLSWM __	\$ 2,799.	\$ 3,349.	\$ 3,929.
	Base Unit, Push-to-Open Drawer	VF30PDCNPWM __	\$ 2,399.	\$ 2,979.	\$ 3,549.
	With 5000K Night Light, Push-to-Open Drawer	VF30PDCLPWM __	\$ 2,799.	\$ 3,349.	\$ 3,929.
Single-Drawer – 30" W Full Storage Drawer, No Sink					
	Base Unit, Slow-Close Drawer	VF30FDXNSWM __	\$ 2,399.	\$ 2,979.	\$ 3,549.
	With 5000K Night Light, Slow-Close Drawer	VF30FDXLSWM __	\$ 2,799.	\$ 3,349.	\$ 3,929.
	Base Unit, Push-to-Open Drawer	VF30FDXNPWM __	\$ 2,399.	\$ 2,979.	\$ 3,549.
	With 5000K Night Light, Push-to-Open Drawer	VF30FDXLPWM __	\$ 2,799.	\$ 3,349.	\$ 3,929.

Vanity top and sink sold separately.

Vanities & Tops

Vanity Color Options

Fill in __ designator to Model listed above with desired color. Example: VF30PDCNSWM27.

Essentials Palette

- 10 Mirror
- 11 Tinted Gray Mirror
- 20 Black
- 21 White

Classic Palette

- 22 Beach
- 26 Matte White
- 27 Matte Gray
- 28 Matte Black

Inspire Palette

- 12 Satin Bronze
- 19 Satin White
- 23 Ocean
- 24 Smoke Screen
- 25 Silver Screen

See Vanity Tops, Accessories & Options on the following page.

V14[®] Vanity – VF30 – 30" W



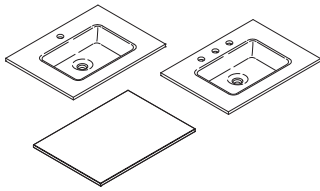

31" W x 22" D Vanity Tops – For 21" D Vanities



Description	For Use With Vanity	See Page
TS31UCN __ Glass Vanity Top	Plumbing Drawer	259
TF31UCO __ Engineered Stone Vanity Top	Plumbing Drawer	259
TF31G __ Engineered Stone Vanity Top (No Sink)	30" W Vanities	259

**Undercounter Sink available for Custom Countertop – see page 265.
See V14 Ganging Reference on pages 234 – 235.**

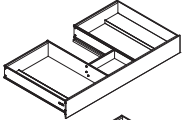
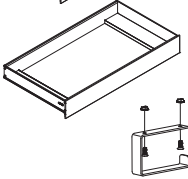
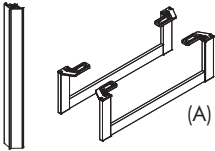
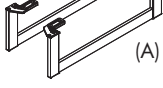
Add-On Accessories & Options

	Description	Model	Price
	Electric Accessory For use in plumbing or full storage drawer	VFELECTRIC	\$ 479.
	Hair Styling Organizer For use in plumbing (vessel only) or full storage drawer	VAHAIRORG	\$ 249.
	Slim Drawer Insert For use in plumbing drawer For use in full storage drawer	VFDRAWER30P VFDRAWER30X	\$ 779. \$ 779.
	Vanity Accessory Toilet Paper Holder Can be installed on either side of vanity	VATP	\$ 99.
	Vanity Ganging Kit Hardware required when combining two or more V14 vanities (each connection point)	VFGKIT	\$ 99.
	Vanity Stacking Kits Hardware required for stacking two or more wall-hung vanities	VFSTACK	\$ 99.
	Legs (2) & hardware for stacking two or more wall-hung vanities	VFSTACKA	\$ 299.
	Legs (4) & hardware for stacking two or more wall-hung vanities	VFSTACKL	\$ 179.

See additional Accessories on pages 273 – 273.

SEE PAGES 218 – 219 FOR TIPS AND FEATURES.

V14[®] Vanity – VF36 – 36" W



Designed to mount horizontally or stack vertically, the V14 vanity lets you create a unique layout with smartly designed storage space.

- Choice between slow-close and push-to-open drawers, both providing long-lasting effortless operation
- Provides task and way-finding light by using the night light option



Available in a 2-week to 4-week lead time



36-1/4" W x 14" H x 21" D Vanity

Description		Model	Essentials Palette 10, 11, 20, 21 Price	Classic Palette 22, 26, 27, 28 Price	Inspire Palette 12, 19, 23, 24, 25 Price
Single-Drawer – 36" W Plumbing Drawer, Center Mount Sink					
	Base Unit, Slow-Close Drawer	VF36PDCNSWM __	\$ 2,979.	\$ 3,549.	\$ 4,129.
	With 5000K Night Light, Slow-Close Drawer	VF36PDCLSWM __	\$ 3,449.	\$ 3,999.	\$ 4,579.
	Base Unit, Push-to-Open Drawer	VF36PDCNPWM __	\$ 2,979.	\$ 3,549.	\$ 4,129.
	With 5000K Night Light, Push-to-Open Drawer	VF36PDCLPWM __	\$ 3,449.	\$ 3,999.	\$ 4,579.
Single-Drawer – 36" W Full Storage Drawer, No Sink					
	Base Unit, Slow-Close Drawer	VF36FDXNSWM __	\$ 2,979.	\$ 3,549.	\$ 4,129.
	With 5000K Night Light, Slow-Close Drawer	VF36FDXLSWM __	\$ 3,449.	\$ 3,999.	\$ 4,579.
	Base Unit, Push-to-Open Drawer	VF36FDXNPWM __	\$ 2,979.	\$ 3,549.	\$ 4,129.
	With 5000K Night Light, Push-to-Open Drawer	VF36FDXLPWM __	\$ 3,449.	\$ 3,999.	\$ 4,579.
Two-Drawer – 24" W Left Plumbing Drawer for Left Mount Sink & 12" W Side Drawer					
	Base Unit, Slow-Close Drawer	VF36PDLNSWM __	\$ 3,099.	\$ 4,229.	\$ 5,379.
	With 5000K Night Light, Slow-Close Drawer	VF36PDLLSWM __	\$ 3,549.	\$ 4,699.	\$ 5,829.
	Base Unit, Push-to-Open Drawer	VF36PDLNPWM __	\$ 3,099.	\$ 4,229.	\$ 5,379.
	With 5000K Night Light, Push-to-Open Drawer	VF36PDLLPWM __	\$ 3,549.	\$ 4,699.	\$ 5,829.
Two-Drawer – 24" W Right Plumbing Drawer for Right Mount Sink & 12" W Side Drawer					
	Base Unit, Slow-Close Drawer	VF36PDRNSWM __	\$ 3,099.	\$ 4,229.	\$ 5,379.
	With 5000K Night Light, Slow-Close Drawer	VF36PDRLSWM __	\$ 3,549.	\$ 4,699.	\$ 5,829.
	Base Unit, Push-to-Open Drawer	VF36PDRNPWM __	\$ 3,099.	\$ 4,229.	\$ 5,379.
	With 5000K Night Light, Push-to-Open Drawer	VF36PDRLPWM __	\$ 3,549.	\$ 4,699.	\$ 5,829.

Vanity top and sink sold separately.

**Fill in __ designator to Model listed above with desired color listed on the following page.
Example: VF36PDCLSWM24.**

See Vanity Color Options, Vanity Tops, Accessories & Options on the following page.

V14® Vanity – VF36 – 36" W

Vanity Color Options

Fill in __ designator to Model listed at left with desired color. Example: VF36PDCLSWM24.

Essentials Palette

- 10 Mirror
- 11 Tinted Gray Mirror
- 20 Black
- 21 White

Classic Palette

- 22 Beach
- 26 Matte White
- 27 Matte Gray
- 28 Matte Black

Inspire Palette

- 12 Satin Bronze
- 19 Satin White
- 23 Ocean
- 24 Smoke Screen
- 25 Silver Screen

37" W x 22" D Vanity Tops – For 21" D Vanities

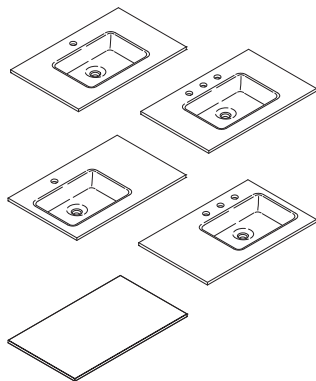

Description	For Use With Vanity	See Page
TF37UCO __ Engineered Stone Vanity Top	Plumbing Drawer, Center Sink	260
TF37ULO __ Engineered Stone Vanity Top	Plumbing Drawer, Left Sink	260
TF37URO __ Engineered Stone Vanity Top	Plumbing Drawer, Right Sink	260
TF37G __ Engineered Stone Vanity Top (No Sink)	36" W Vanities	260

Undercounter Sink available for Custom Countertop – see page 265.
See V14 Ganging Reference on pages 234 – 235.

Add-On Accessories & Options

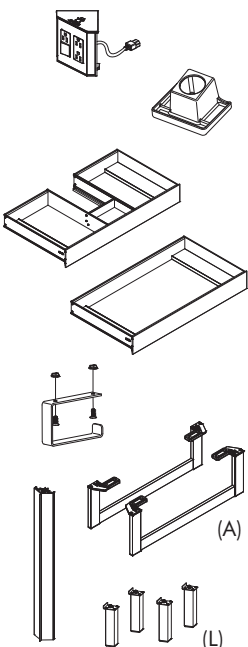

Description	Model	Price
Electric Accessory For use in plumbing or full storage drawer	VFELECTRIC	\$ 479.
Hair Styling Organizer For use in plumbing (vessel only) or full storage drawer	VAHAIRORG	\$ 249.
Slim Drawer Insert For use in 36" W plumbing drawer	VFDRAWER36P	\$ 849.
For use in 36" W full storage drawer	VFDRAWER36X	\$ 849.
For use in 24" W plumbing drawer	VFDRAWER24P	\$ 649.
Note: Not for use with plumbing drawer undercounter sink installations or with Robern's stone vanity tops. Can be used in above-counter vessel installations.		
For use in 12" W accessory side drawer	VFDRAWER12X	\$ 529.
Vanity Accessory Toilet Paper Holder Can be installed on either side of vanity	VATP	\$ 99.
Vanity Ganging Kit Hardware required when combining two or more V14 vanities (each connection point)	VFGKIT	\$ 99.
Vanity Stacking Kits Hardware required for stacking two or more wall-hung vanities	VFSTACK	\$ 99.
Legs (2) & hardware for stacking two or more wall-hung vanities	VFSTACKA	\$ 299.
Legs (4) & hardware for stacking two or more wall-hung vanities	VFSTACKL	\$ 179.

See additional Accessories on pages 273 – 273.

SEE PAGES 218 – 219 FOR TIPS AND FEATURES.

V14[®] Vanity – VF48 – 48" W



Designed to mount horizontally or stack vertically, the V14 vanity lets you create a unique layout with smartly designed storage space.

- Choice between slow-close and push-to-open drawers, both providing long-lasting effortless operation
- Provides task and way-finding light by using the night light option



Available in a 2-week to 4-week lead time



48-1/4" W x 14" H x 21" D Vanity

		Essentials Palette	Classic Palette	Inspire Palette	
		10, 11, 20, 21	22, 26, 27, 28	12, 19, 23, 24, 25	
Description	Model	Price	Price	Price	
Three-Drawer – 24" W Plumbing Drawer for Center Mount Sink & two 12" W Side Drawers					
	Base Unit, Slow-Close Drawer	VF48PDCNSWM __	\$ 4,349.	\$ 6,079.	\$ 7,779.
	With 5000K Night Light, Slow-Close Drawer	VF48PDCLSWM __	\$ 4,979.	\$ 6,699.	\$ 8,399.
	Base Unit, Push-to-Open Drawer	VF48PDCNPWM __	\$ 4,349.	\$ 6,079.	\$ 7,779.
	With 5000K Night Light, Push-to-Open Drawer	VF48PDCLPWM __	\$ 4,979.	\$ 6,699.	\$ 8,399.

Vanity top and sink sold separately.

Vanity Color Options

Fill in __ designator to Model listed above with desired color. Example: VF48PDCLSWM24.

Essentials Palette

- 10 Mirror
- 11 Tinted Gray Mirror
- 20 Black
- 21 White

Classic Palette

- 22 Beach
- 26 Matte White
- 27 Matte Gray
- 28 Matte Black

Inspire Palette

- 12 Satin Bronze
- 19 Satin White
- 23 Ocean
- 24 Smoke Screen
- 25 Silver Screen

See Vanity Tops, Accessories & Options on the following page.

V14[®] Vanity – VF48 – 48" W

49" W x 22" D Vanity Tops – For 21" D Vanities

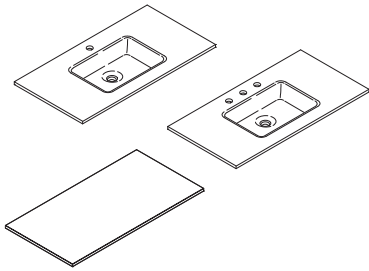

Description	For Use With Vanity	See Page
TF49UCO __ Engineered Stone Vanity Top	Plumbing Drawer	262
TF49G __ Engineered Stone Vanity Top (No Sink)	48" W Vanities	262

**Undercounter Sink available for Custom Countertop – see page 265.
See V14 Ganging Reference on pages 234 – 235.**

Add-On Accessories & Options

	Description	Model	Price
	Electric Accessory For use in any drawer	VFELECTRIC	\$ 479.
	Hair Styling Organizer For use in plumbing (vessel only) or full storage drawer	VAHAIRORG	\$ 249.
	Slim Drawer Insert For use in 24" W plumbing drawer Note: Not for use with plumbing drawer undercounter sink installations or with Robern's stone vanity tops. Can be used in above-counter vessel installations.	VFDRAWER24P	\$ 649.
	For use in 12" W accessory side drawer	VFDRAWER12X	\$ 529.
	Vanity Accessory Toilet Paper Holder Can be installed on either side of vanity	VATP	\$ 99.
	Vanity Ganging Kit Hardware required when combining two or more V14 vanities (each connection point)	VFGKIT	\$ 99.
	Vanity Stacking Kits Hardware required for stacking two or more wall-hung vanities	VFSTACK	\$ 99.
	Legs (2) & hardware for stacking two or more wall-hung vanities	VFSTACKA	\$ 299.
	Legs (4) & hardware for stacking two or more wall-hung vanities	VFSTACKL	\$ 179.

See additional Accessories on pages 273 – 273.

SEE PAGES 218 – 219 FOR TIPS AND FEATURES.

V14® Vanity – VF60 – 60" W



Designed to mount horizontally or stack vertically, the V14 vanity lets you create a unique layout with smartly designed storage space.

- Choice between slow-close and push-to-open drawers, both providing long-lasting effortless operation
- Provides task and way-finding light by using the night light option



Available in a 2-week to 4-week lead time



60-1/4" W x 14" H x 21" D Vanity

		Essentials Palette	Classic Palette	Inspire Palette	
		10, 11, 20, 21	22, 26, 27, 28	12, 19, 23, 24, 25	
		Price	Price	Price	
Description	Model				
Three-Drawer – 36" W Plumbing Drawer for Center Mount Sink & two 12" W Side Drawers					
	Base Unit, Slow-Close Drawer	VF60PDCNSWM __	\$ 5,499.	\$ 7,229.	\$ 8,929.
	With 5000K Night Light, Slow-Close Drawer	VF60PDCLSWM __	\$ 6,129.	\$ 7,849.	\$ 9,549.
	Base Unit, Push-to-Open Drawer	VF60PDCNPWM __	\$ 5,499.	\$ 7,229.	\$ 8,929.
	With 5000K Night Light, Push-to-Open Drawer	VF60PDCLPWM __	\$ 6,129.	\$ 7,849.	\$ 9,549.

Vanity top and sink sold separately.

Vanity Color Options

Fill in __ designator to Model listed above with desired color. Example: VF60PDCNPWM20.

Essentials Palette

- 10 Mirror
- 11 Tinted Gray Mirror
- 20 Black
- 21 White

Classic Palette

- 22 Beach
- 26 Matte White
- 27 Matte Gray
- 28 Matte Black

Inspire Palette

- 12 Satin Bronze
- 19 Satin White
- 23 Ocean
- 24 Smoke Screen
- 25 Silver Screen

See Vanity Tops, Accessories & Options on the following page.

V14® Vanity – VF60 – 60" W

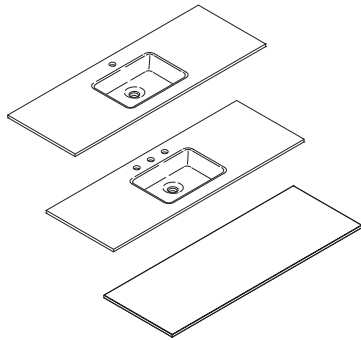

61" W x 22" D Vanity Tops – For 21" D Vanities



Description	For Use With Vanity	See Page
TF61UCO __ Engineered Stone Vanity Top	Plumbing Drawer	263
TF61G __ Engineered Stone Vanity Top (No Sink)	60" W Vanities	263

**Undercounter Sink available for Custom Countertop – see page 265.
See V14 Ganging Reference on pages 234 – 235.**

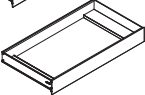
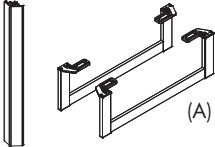
Add-On Accessories & Options

	Description	Model	Price
	Electric Accessory For use in any drawer	VFELECTRIC	\$ 479.
	Hair Styling Organizer For use in plumbing (vessel only) or full storage drawer	VAHAIRORG	\$ 249.
	Slim Drawer Insert For use in 36" W plumbing drawer Note: Not for use with plumbing drawer undercounter sink installations or with Robern's stone vanity tops. Can be used in above-counter vessel installations.	VFDRAWER36P	\$ 849.
	For use in 12" W accessory side drawer	VFDRAWER12X	\$ 529.
	Vanity Accessory Toilet Paper Holder Can be installed on either side of vanity	VATP	\$ 99.
	Vanity Ganging Kit Hardware required when combining two or more V14 vanities (each connection point)	VFGKIT	\$ 99.
	Vanity Stacking Kits Hardware required for stacking two or more wall-hung vanities	VFSTACK	\$ 99.
	Legs (2) & hardware for stacking two or more wall-hung vanities	VFSTACKA	\$ 299.
	Legs (4) & hardware for stacking two or more wall-hung vanities	VFSTACKL	\$ 179.

See additional Accessories on pages 273 – 273.

SEE PAGES 218 – 219 FOR TIPS AND FEATURES.

V14® Ganging Reference

Refer to the following for V14 ganging/stacking examples:

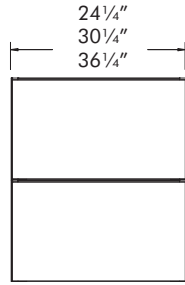

Stacking Wall-Hung
Required Hardware:
VFSTACK

Recommended installation height is 34½"; however, wall-hung vanities can be installed at varying heights. Please refer to instruction sheets for specific requirements.

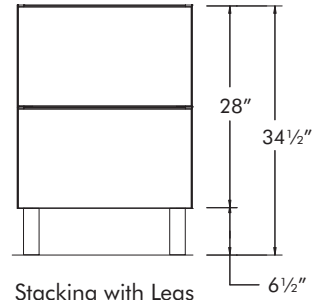

Stacking with Legs
Required Hardware:
VFSTACKA or VFSTACKL

The V14 Stacking Kits with Legs (VSTACKA/L) includes brushed aluminum legs which are 6½" H. The V14 Vanities are 14" H. The installed vanity height will be 34½" H. The specified counter and sink will impact the total height of the installation.

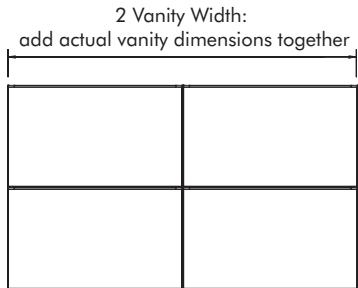

Stacking & Ganged
Wall-Hung
Required Hardware:
2 VFGKIT
2 VFSTACK

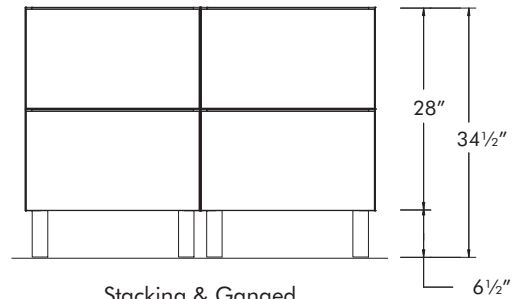

Stacking & Ganged
with Legs
Required Hardware:
2 VFGKIT
2 VFSTACKA or 2 VFSTACKL

It is recommended to use a Full Storage Drawer for the bottom of a 2-drawer stacked unit. The Full Drawers come with glass dividers to partition the drawer in a variety of ways and does not include plumbing clearance cutouts.

Total Width of vanity area should be a minimum of 48" W.

Example 1: Two 12" Wall-Hung Vanities

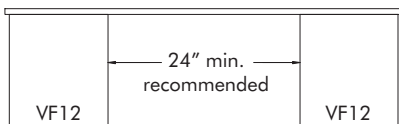

Example 1: Two 12" wide V14 vanities for a 48" wide Vanity Space:

- 12" wide V14 + 24" wide open space + 12" wide V14 vanity = 48" wide Vanity

Example 2: Two 24" Wall-Hung Vanities

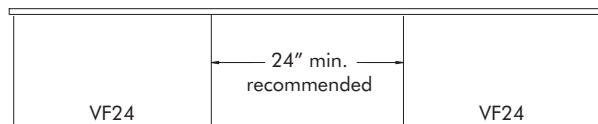

Example 2: Two 24" wide V14 vanities for a 72" wide Vanity Space:

- 24" wide V14 + 24" wide open space + 24" wide V14 vanity = 72" wide Vanity

Note: For 12" wide Vanities, side kits will need to be purchased for this installation. See page 223 for side kit information.

V14® Ganging Reference

V14 can be ganged together to form endless combinations and installations to meet a variety of needs:

To acquire the total width of the vanity, add actual vanity dimensions together.

Example 3: Dual Sink Installation
with Two Wall-Hung Vanities

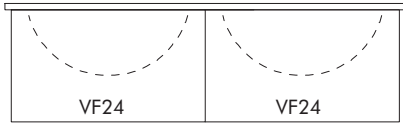

Example 4: Dual Sink Installation
with Three Wall-Hung Vanities



Example 3: To create a 48" Dual Sink installation:

- Two 24" wide V14: $24\frac{1}{4}" + 24\frac{1}{4}" = 48\frac{1}{2}"$

Example 4: To create a 60" wide Dual Sink Installation, three Vanities recommended:

- 24" wide V14 (left) + 12" wide V14 (center) + 24" wide V14 (right) = $24\frac{1}{4}" + 12\frac{1}{4}" + 24\frac{1}{4}" = 60\frac{3}{4}"$

It is recommended to use a Full Storage Drawer for the center drawer of a 3-drawer ganged vanity installation.

The Full Drawers come with glass dividers to partition the drawer in a variety of ways and does not include plumbing clearance cutouts.

Please refer to page 223 for 12" W accessory drawer options.

For more guidance on our modular solutions, visit robern.com/modularity.

Cartesian® Vanities – Table of Contents, Tips & Features

Table of Contents

Cartesian Vanity Tips & Features	236 – 237
Cartesian Vanity Ganging Reference	238 – 240
Cartesian Vanity Model Number Worksheet	241
Cartesian Vanities	242 – 255
12" Wide Cartesian Vanity	242 – 243
24" Wide Cartesian Vanity	244 – 247
30" Wide Cartesian Vanity	248 – 251
36" Wide Cartesian Vanity	252 – 255
Vanity Tops	258 – 265
Cartesian Vanity Undermount Bowl Space Availability	266
Vanity Accessories	271 – 275

Tips & Features

Dimensions & Weight

- Width (with side kits installed):
12-1/8" (308 mm), 24-1/8" (613 mm),
30-1/8" (765 mm), 36-1/8" (918 mm)
- Height:
7-1/2" (191 mm), 15" (381 mm)
- Depth:
18-3/4" (476 mm), 21-3/4" (552 mm)
- Net Weight: 25 – 97 lbs

Features & Benefits

- Offered in limitless designs, these vanities are built to fit your preference and storage needs
- Modular vanities can be ganged or stacked to fit a variety of desired heights and widths (ganging kit required)
- Plumbing slow-close drawer allows clearance for drain; tip out drawer for H1 (7-1/2" H) gives storage back by providing a drawer for smaller items and full slow-close drawer allows optimal storage solutions
- Uniquely designed handleless ergonomic drawer, allows for a comfortable feel and effortless operation
- H1 (7-1/2") vanities include five glass bins for plumbing drawers and four glass bins for full drawers; H2 (15") vanities include one glass bin with plumbing drawers; not available for 12" W vanities

Features & Benefits (Continued)

- Organization kit for H2 (15" H): two fully adjustable glass drawer dividers provide storage right where you need it and prevent items from moving and sliding in the drawer
- Night Light Option – integrated LED night light with light bar built into top frame of each drawer, provides soft light to illuminate drawer interior and for wayfinding light in either selectable 2700 Kelvin/4000 Kelvin or 5000 Kelvin. Night light is ETL certified to UL 2108, CSA Standard C22.2 No. 12
- Electric accessory option: three plugs and a switch that turns off power to the unit to keep appliances safely plugged in

Configurable Options

- Decorative Glass Options:
mirror, 14 decorative gloss, matte and textured colors
- Night Light:
No Night Light or Integrated LED Night Light in selectable 2700 Kelvin/4000 Kelvin or 5000 Kelvin
- Drawer Application:
Choice of split plumbing (not available for 12" W drawer), full drawer or tip out drawer (7-1/2" H only, not available for 12" W drawer)



Tips & Features (Continued)

Construction

- Durable rust-free anodized aluminum and glass construction – resists intense moisture, ensuring long-lasting beauty
- Slow-close full-extension slides combined with the durability of aluminum construction ensure smooth operation of the vanity drawers that will last a lifetime
- Constructed for wall hanging loads with stone tops
- Glass fronts and side kits are replaceable
- White shatter-protected glass drawer bottoms will not degrade or show wear. Glass dissipates heat to ensure confidence that hot items will not leave heat marks on the bottom of the drawers

Installation

- This installation may require more than one person
- Includes installation hardware and structural bolts
- Special site preparation is required. Wall bracing and Robern supplied hardware are recommended
- The plumbing must be roughed into the plumbing cutout area of the vanity. Refer to the sink rough-in and the vanity rough-in for proper placement. The water supply and drain lines must be installed before installing the vanity
- Components needed for stacking are included with each vanity
- Within a column, all vanities must stay the same width. Ganging kit required for each column connection point and is selected based on the connection height of the vanities. Each ganging kit is by 7-1/2" increments (H1 = 7-1/2", H2 = 15", H3 = 22-1/2", H4 = 30").
- Side kits are sold separately to allow for customization and are available individually or as pairs. You must choose one side kit or alcove kit for every exposed side.
- With a 7-1/2" H vanity, a tip out drawer must be used with an undercounter sink
- If stacking with a 7-1/2" tip out drawer, the second vanity must be a 7-1/2" plumbing drawer, a 15" plumbing drawer or a 15" full drawer as the first 15" needs plumbing clearance. If using 7-1/2" tip out for undercounter sink installation, slim plumbing drawer insert can be used with a 15" H plumbing drawer and still clear pipes.
- Full drawer units are intended for ganging and stacking and are not designed to accept a sink or plumbing.
- Night light option (S) – 12VDC plug-in transformer. Option of two color temperatures for one night light: 2700 or 4000 Kelvin. The vanity is preconfigured at 2700K. Night light can be reconfigured to 4000K at time of installation. See installation instructions for more information.

Installation (Continued)

- Night light option (L) – 12VDC plug-in transformer in 5000 Kelvin color temperature. Locate wall outlet as per installation instructions.
- Electric Accessory option: 120VAC 20A tamper resistant outlet. Installed within 15" H (H2) vanity drawer; not recommended to be used in combination with Slim Drawer Insert; recommended in combination with Hair Styling Organizer
- Slim plumbing drawer insert must be used with an above-counter sink installation; full drawer version can be used in a full drawer - includes four glass bins and only available for 15" H (H2) vanities
- Hair Styling Organizer fits all 15" H (H2) vanity drawers except 24" plumbing drawer; cannot be used in combination with slim drawer insert; recommended in combination with Electric Accessory

Accessories

- In-drawer Electric Accessory (VAELECTRIC18, VAELECTRIC21): ETL certified to UL 1363, CSA Standard C22.2 No. 21 – 15" H only
- Accessory Night Light in selectable 2700 Kelvin/4000 Kelvin (SLEDS12, SLEDS24, SLEDS30, SLEDS36) and 5000 Kelvin (CLEDS12, CLEDS24, CLEDS30, CLEDS36): Night light is ETL certified to UL 2108, CSA Standard C22.2 No. 12
- Slim Plumbing Drawer Insert with five glass bins (VADRAWER24P, VADRAWER30P, VADRAWER36P) – 15" H only
- Slim Full Drawer Insert with four glass bins (VADRAWER12X, VADRAWER24X, VADRAWER30X, VADRAWER36X) – 15" H only
- Glass Bins: divided storage (GLASSBIN6.38), small (GLASSBIN3.25), medium (GLASSBIN5.25), large (GLASSBIN8.5)
- Hair Styling Organizer (VAHAIRORG): fits most hair dryers and curling irons – to be used in 15" H (H2) vanity drawers only
- Glass and engineered stone tops with porcelain sink
- Glass side kits sold separately as single units or as a pair. Available in 4 heights and 2 depths, and based on the final configuration of the vanity (7-1/2", 15", 22-1/2", 30").
- Ganging kits are required when combining two or more vanities and are available in 4 heights and based on the final configuration of the vanity (7-1/2", 15", 22-1/2", 30")
- Alcove finishing kits are required for corner or alcove installations and are available in 4 heights and based on the final configuration of the vanity (7-1/2", 15", 22-1/2", 30")



Cartesian® Ganging Reference

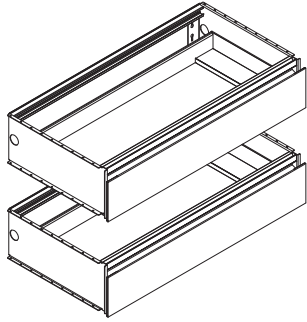

(2) VM36H1D18P ---

+

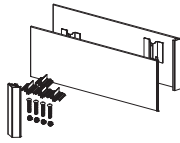

(1) VMGKITH1
(1) VM2SKH1D18- ---

=

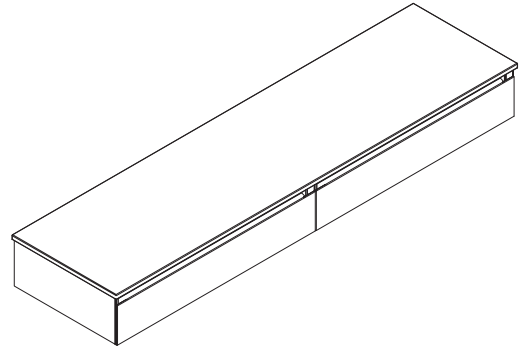

(1) TE73G --

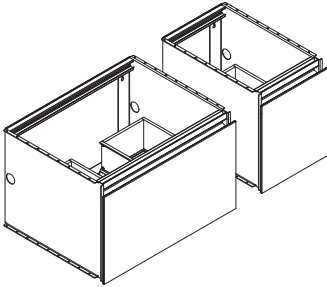

(1) VM24H2D18P ---
(1) VM12H2D18F ---

+

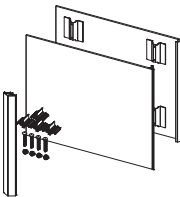

(1) VMGKITH2
(1) VM2SKH2D18- ---

=

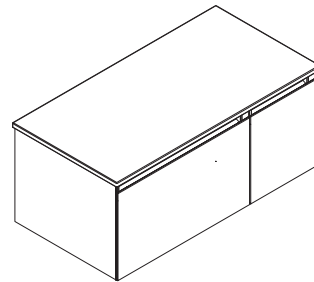

(1) TE37G --

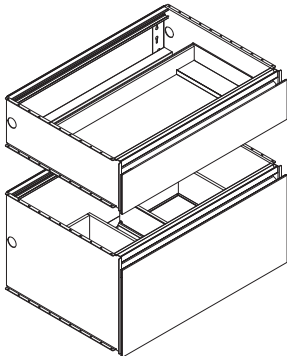

(1) VM30H1D21F ---
(1) VM30H2D21F ---

+

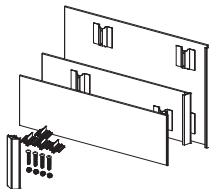

(1) VMGKITH1
(1) VM2SKH1D21- ---
(1) VM1SKH2D21- ---

=

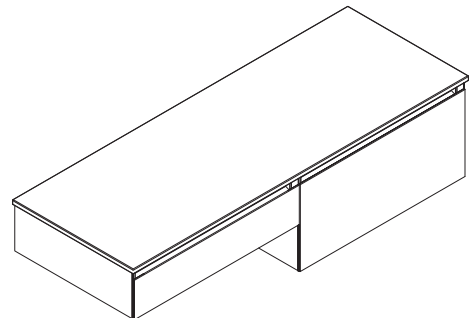

(1) TF61G --

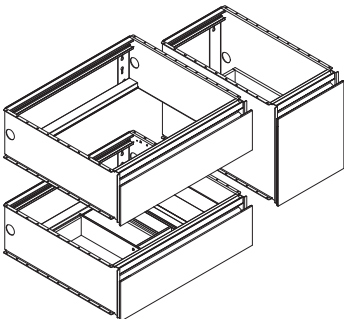

(1) VM24H1D21T ---
(1) VM24H1D21P ---
(1) VM12H2D21F ---

+

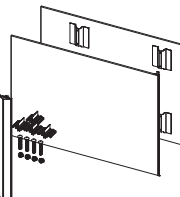

(1) VMGKITH2
(1) VM2SKH2D21- ---

=

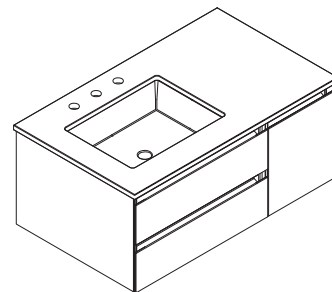

(1) TF37ULO -- -8

Cartesian® Ganging Reference

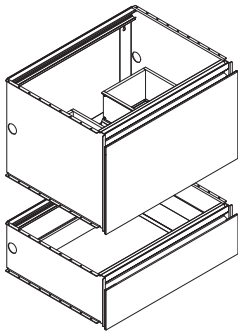

(1) VM24H2D21P ---
 (1) VM24H1D21F ---

+

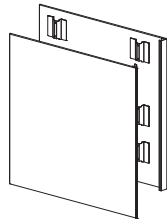

(1) VM2SKH3D21- ---

=

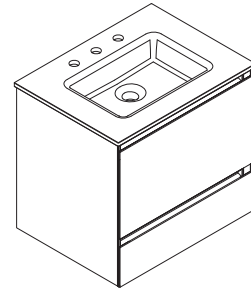

(1) TS25UCN21-8

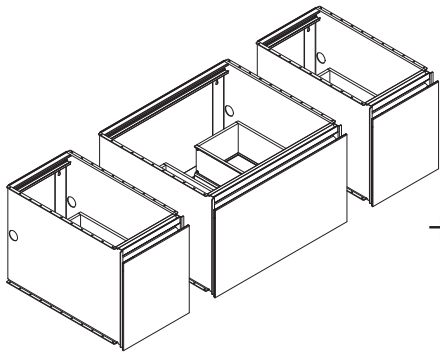

(1) VM24H2D21P ---
 (2) VM12H2D21F ---

+

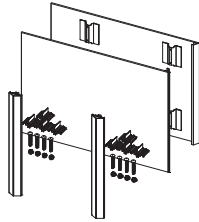

(1) VM2SKH2D21- ---
 (2) VMGKITH2

=

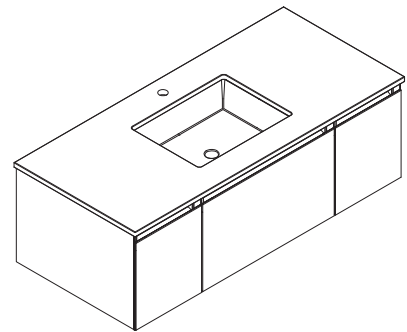

(1) TS49UCO ___ -1

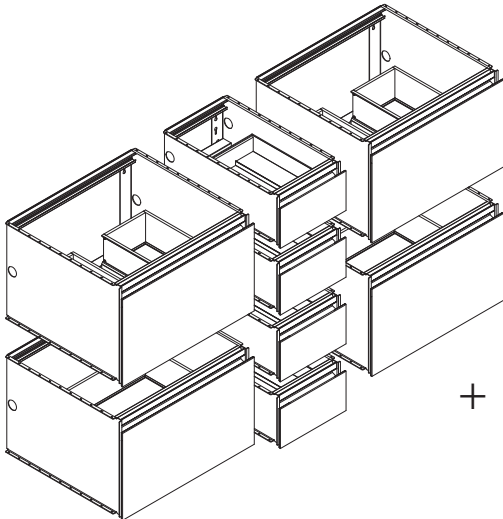

(2) VM24H2D21P ---
 (2) VM24H2D21F ---
 (4) VM12H1D21F ---

+

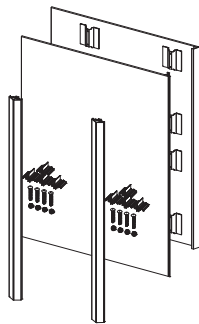

(1) VM2SKH4D21- ---
 (2) VMGKITH4

=

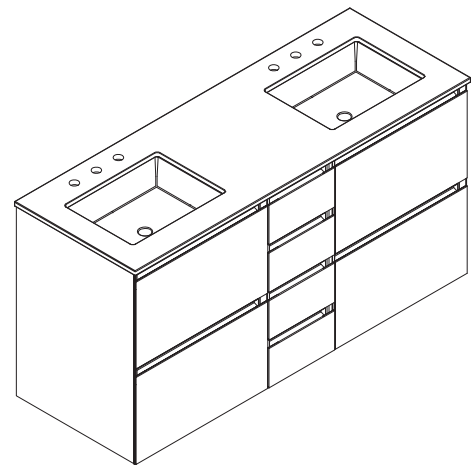

(1) TF61UDO ___ - 8D4

Vanities & Tops

Example 1: Two 12" Wall-Hung Vanities

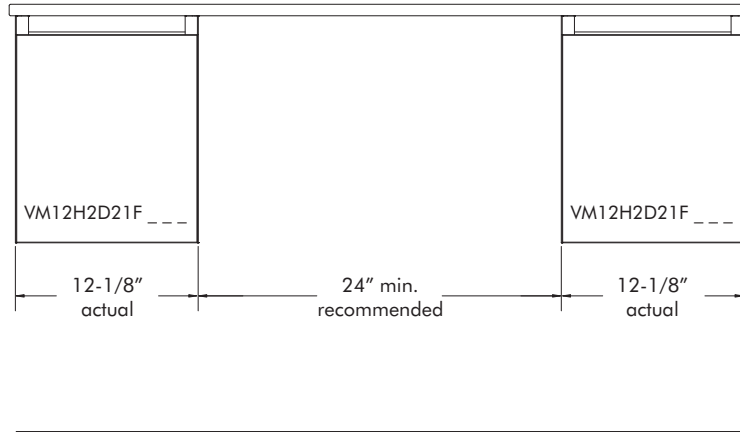

Example 1: Two 12" wide Cartesian vanities for a 48" wide vanity space:

- 12" wide VM + 24" wide space + 12" wide VM = 48" wide vanity space (48-1/4" actual width)

Example 2: Three 24" Wall-Hung Vanities

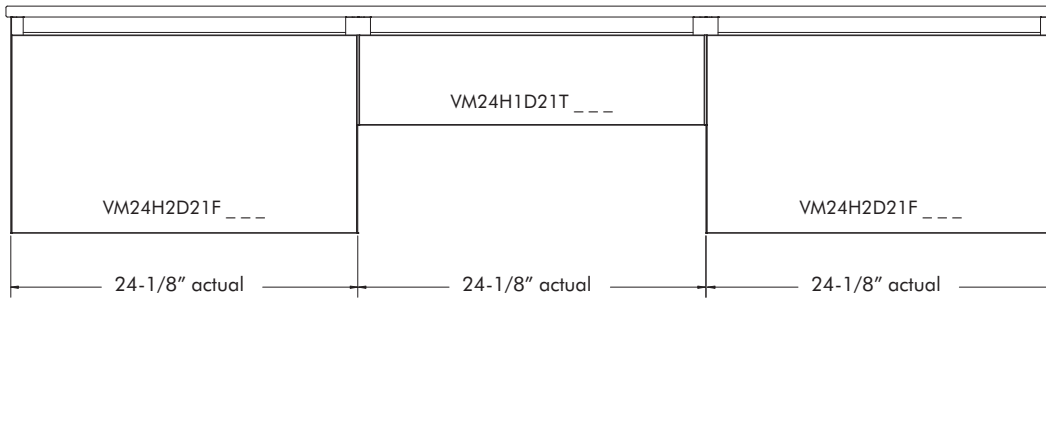

Example 2: Three 24" wide Cartesian vanities for a 72" wide vanity space:

- 24" wide VM + 24" wide VM + 24" wide VM = 72" wide vanity space (72-3/8" actual width)

For more guidance on our modular solutions, visit robern.com/modularity.

Cartesian® Vanity Model Number Worksheet

FEATURES

Select Width:

- 12"
- 24"
- 30"
- 36"

Select Height:

- 7-1/2"
- 15"

Select Depth:

- 18"
- 21"

Select Drawer Style:

- Plumbing
- Full
- Tip Out*

Select Color:

Essentials Palette**

- Mirror 10
- Tinted Gray Mirror 11
- Black 20
- White 21

Classic Palette**

- Beach 22
- Matte White 26
- Matte Gray 27
- Matte Black 28
- Reeded White 60
- Reeded Brass 61

Inspire Palette**

- Satin Bronze 12
- Satin White 19
- Ocean 23
- Smoke Screen 24
- Silver Screen 25

Select Option:

- Base Unit (No Night Light) N
- Selectable Night Light, 2700K/4000K S
- Night Light, 5000K L

MODEL

VM

- 12
- 24
- 30
- 36

- H1
- H2

- D18
- D21

- P
- F
- T

- 10
- 11
- 20
- 21

- 22
- 26
- 27
- 28
- 60
- 61

- 12
- 19
- 23
- 24
- 25

- N
- S
- L

Notes:

- * Tip Out Drawer only available for 7-1/2" height.
- ** Colors available in a 2-week to 4-week lead time.

CUSTOMER INFORMATION

Name _____

Address _____

City/State/Zip _____

Telephone _____

Date Ordered _____

Cartesian® Vanity – VM12 – 12" W x 21" or 18" D



Meet the world's most accommodating vanity. Like the mathematical system that inspired its name, the Cartesian wall-mount vanity offers infinite possibilities for every dimension in your design. Customizable configurations ensure storage that perfectly suits your needs.

- Customize around your own needs. Modular design allows you to add or upgrade your existing vanity or nightstand and add new features to infinitely expand the functionality
- Provides task and way-finding light by using the night light option



Available in a 2-week to 4-week lead time



12-1/8" W x 21-3/4" D Vanity

			Essentials Palette	Classic Palette	Inspire Palette
			10, 11, 20, 21	22, 26, 27, 28, 60, 61	12, 19, 23, 24, 25
Description	Model		Price	Price	Price
7-1/2" H x 21-3/4" D Vanity – Full Drawer, No Sink					
	Base Unit	VM12H1D21F__N	\$ 499.	\$ 949.	\$ 1,399.
	With 2700K/4000K Night Light	VM12H1D21F__S	\$ 779.	\$ 1,229.	\$ 1,679.
	With 5000K Night Light	VM12H1D21F__L	\$ 779.	\$ 1,229.	\$ 1,679.
15" H x 21-3/4" D Vanity – Full Drawer, No Sink					
	Base Unit	VM12H2D21F__N	\$ 729.	\$ 1,179.	\$ 1,629.
	With 2700K/4000K Night Light	VM12H2D21F__S	\$ 999.	\$ 1,479.	\$ 1,899.
	With 5000K Night Light	VM12H2D21F__L	\$ 999.	\$ 1,479.	\$ 1,899.

Vanity top and side kits sold separately.

12-1/8" W x 18-3/4" D Vanity

			Essentials Palette	Classic Palette	Inspire Palette
			10, 11, 20, 21	22, 26, 27, 28, 60, 61	12, 19, 23, 24, 25
Description	Model		Price	Price	Price
7-1/2" H x 18-3/4" D Vanity – Full Drawer, No Sink					
	Base Unit	VM12H1D18F__N	\$ 499.	\$ 949.	\$ 1,399.
	With 2700K/4000K Night Light	VM12H1D18F__S	\$ 779.	\$ 1,229.	\$ 1,679.
	With 5000K Night Light	VM12H1D18F__L	\$ 779.	\$ 1,229.	\$ 1,679.
15" H x 18-3/4" D Vanity – Full Drawer, No Sink					
	Base Unit	VM12H2D18F__N	\$ 729.	\$ 1,179.	\$ 1,629.
	With 2700K/4000K Night Light	VM12H2D18F__S	\$ 999.	\$ 1,479.	\$ 1,899.
	With 5000K Night Light	VM12H2D18F__L	\$ 999.	\$ 1,479.	\$ 1,899.

Vanity top and side kits sold separately.

Vanity Color Options

Fill in __ designator to Model listed above with desired color. Example: VM12H1D21F19N.

Essentials Palette

- 10 Mirror
- 11 Tinted Gray Mirror
- 20 Black
- 21 White

Classic Palette

- 22 Beach
- 26 Matte White
- 27 Matte Gray
- 28 Matte Black
- 60 Reeded White
- 61 Reeded Brass

NEW!

NEW!

Inspire Palette

- 12 Satin Bronze
- 19 Satin White
- 23 Ocean
- 24 Smoke Screen
- 25 Silver Screen

See Vanity Tops, Accessories & Options on the following page.

Cartesian® Vanity – VM12 – 12" W x 21" or 18" D

13" W x 19" D & 13" W x 22" D Vanity Tops

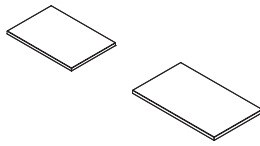

Description	For Use With Vanity	See Page
TE13G _ _ Engineered Stone Vanity Top (No Sink)	18" D, 12" W Vanities	258
TF13G _ _ Engineered Stone Vanity Top (No Sink)	21" D, 12" W Vanities	258

See Cartesian Ganging Reference on pages 238 – 240.

Add-On Accessories & Options

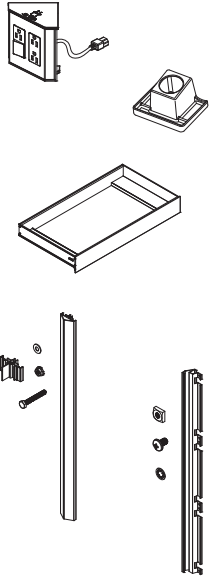

Description	Model	Price
Electric Accessory		
For use in 21" D drawer, with 15" H vanity (H2)	VAELECTRIC21	\$ 479.
For use in 18" D drawer, with 15" H vanity (H2)	VAELECTRIC18	\$ 479.
Hair Styling Organizer		
For use in 15" H drawer (H2)	VAHAIRORG	\$ 249.
Slim Drawer Insert		
For use in 15" H drawer (H2)	VADRAWER12X	\$ 529.
Vanity Ganging Kit – Hardware required when combining two or more vanities (each connection point)		
7-1/2" H	VMGKITH1	\$ 99.
15" H	VMGKITH2	\$ 99.
22-1/2" H	VMGKITH3	\$ 229.
30" H	VMGKITH4	\$ 229.
Vanity Alcove Finishing Kit – Hardware required for corner or alcove installations		
7-1/2" H	VMAKITH1	\$ 99.
15" H	VMAKITH2	\$ 99.
22-1/2" H	VMAKITH3	\$ 229.
30" H	VMAKITH4	\$ 229.

See additional Accessories on pages 273 – 273.

Vanity Side Kits (sold separately)

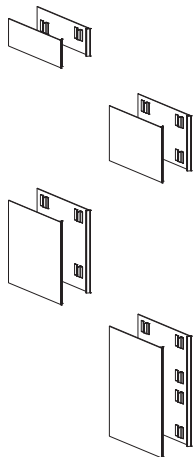

Description	Model	Essentials Palette	Classic Palette	Inspire Palette
Vanity Side Kits – Includes glass panel(s) & hardware (see Color Options above)				
Single, 7-1/2" H, 21" D	VM1SKH1D21- _ _	\$ 229.	\$ 299.	\$ 349.
Pair, 7-1/2" H, 21" D	VM2SKH1D21- _ _	\$ 349.	\$ 479.	\$ 579.
Single, 7-1/2" H, 18" D	VM1SKH1D18- _ _	\$ 229.	\$ 299.	\$ 349.
Pair, 7-1/2" H, 18" D	VM2SKH1D18- _ _	\$ 349.	\$ 479.	\$ 579.
Single, 15" H, 21" D	VM1SKH2D21- _ _	\$ 299.	\$ 349.	\$ 429.
Pair, 15" H, 21" D	VM2SKH2D21- _ _	\$ 429.	\$ 529.	\$ 649.
Single, 15" H, 18" D	VM1SKH2D18- _ _	\$ 299.	\$ 349.	\$ 429.
Pair, 15" H, 18" D	VM2SKH2D18- _ _	\$ 429.	\$ 529.	\$ 649.
Single, 22-1/2" H, 21" D	VM1SKH3D21- _ _	\$ 349.	\$ 429.	\$ 479.
Pair, 22-1/2" H, 21" D	VM2SKH3D21- _ _	\$ 579.	\$ 699.	\$ 829.
Single, 22-1/2" H, 18" D	VM1SKH3D18- _ _	\$ 349.	\$ 429.	\$ 479.
Pair, 22-1/2" H, 18" D	VM2SKH3D18- _ _	\$ 579.	\$ 699.	\$ 829.
Single, 30" H, 21" D	VM1SKH4D21- _ _	\$ 429.	\$ 479.	\$ 529.
Pair, 30" H, 21" D	VM2SKH4D21- _ _	\$ 699.	\$ 829.	\$ 929.
Single, 30" H, 18" D	VM1SKH4D18- _ _	\$ 429.	\$ 479.	\$ 529.
Pair, 30" H, 18" D	VM2SKH4D18- _ _	\$ 699.	\$ 829.	\$ 929.

Note: You must choose one side kit or alcove kit for every exposed side.

SEE PAGES 236 – 237 FOR TIPS AND FEATURES.

Cartesian® Vanity – VM24 – 24" W x 21" D



Meet the world's most accommodating vanity. Like the mathematical system that inspired its name, the Cartesian wall-mount vanity offers infinite possibilities for every dimension in your design. Customizable configurations ensure storage that perfectly suits your needs.

- Customize around your own needs. Modular design allows you to add or upgrade your existing vanity or nightstand and add new features to infinitely expand the functionality
- Provides task and way-finding light by using the night light option



Available in a 2-week to 4-week lead time



Modular



Electrical Outlet



Night Light

24-1/8" W x 21-3/4" D Vanity

Description		Model	Essentials Palette 10, 11, 20, 21 Price	Classic Palette 22, 26, 27, 28, 60, 61 Price	Inspire Palette 12, 19, 23, 24, 25 Price
7-1/2" H Vanity – Plumbing Drawer, No Undercounter Sink					
	Base Unit	VM24H1D21P__N	\$ 1,049.	\$ 1,529.	\$ 1,949.
	With 2700K/4000K Night Light	VM24H1D21P__S	\$ 1,399.	\$ 1,849.	\$ 2,299.
	With 5000K Night Light	VM24H1D21P__L	\$ 1,399.	\$ 1,849.	\$ 2,299.
7-1/2" H Vanity – Full Drawer, No Sink					
	Base Unit	VM24H1D21F__N	\$ 1,049.	\$ 1,529.	\$ 1,949.
	With 2700K/4000K Night Light	VM24H1D21F__S	\$ 1,399.	\$ 1,849.	\$ 2,299.
	With 5000K Night Light	VM24H1D21F__L	\$ 1,399.	\$ 1,849.	\$ 2,299.
7-1/2" H Vanity – Tip Out Drawer					
	Base Unit	VM24H1D21T__N	\$ 1,049.	\$ 1,529.	\$ 1,949.
	With 2700K/4000K Night Light	VM24H1D21T__S	\$ 1,399.	\$ 1,849.	\$ 2,299.
	With 5000K Night Light	VM24H1D21T__L	\$ 1,399.	\$ 1,849.	\$ 2,299.
15" H Vanity – Plumbing Drawer					
	Base Unit	VM24H2D21P__N	\$ 1,279.	\$ 1,729.	\$ 2,199.
	With 2700K/4000K Night Light	VM24H2D21P__S	\$ 1,629.	\$ 2,099.	\$ 2,529.
	With 5000K Night Light	VM24H2D21P__L	\$ 1,629.	\$ 2,099.	\$ 2,529.
15" H Vanity – Full Drawer, No Sink					
	Base Unit	VM24H2D21F__N	\$ 1,279.	\$ 1,729.	\$ 2,199.
	With 2700K/4000K Night Light	VM24H2D21F__S	\$ 1,629.	\$ 2,099.	\$ 2,529.
	With 5000K Night Light	VM24H2D21F__L	\$ 1,629.	\$ 2,099.	\$ 2,529.

Vanity top, sink and side kits sold separately.

Vanity Color Options

Fill in __ designator to Model listed above with desired color. Example: VM24H2D21P28N.

Essentials Palette

- 10 Mirror
- 11 Tinted Gray Mirror
- 20 Black
- 21 White

Classic Palette

- 22 Beach
- 26 Matte White
- 27 Matte Gray
- 28 Matte Black
- 60 Reeded White
- 61 Reeded Brass

NEW!

NEW!

Inspire Palette

- 12 Satin Bronze
- 19 Satin White
- 23 Ocean
- 24 Smoke Screen
- 25 Silver Screen

See Vanity Tops, Accessories & Options on the following page.

Cartesian® Vanity – VM24 – 24" W x 21" D

25" W x 22" D Vanity Tops – For 21" D Vanities

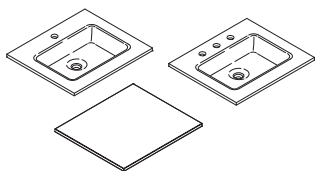

Description	For Use With Vanity	See Page
TS25UCN __ Glass Vanity Top	Plumbing & Tip Out Drawer	258
TF25UCO __ Engineered Stone Vanity Top	Plumbing & Tip Out Drawer	258
TF25G __ Engineered Stone Vanity Top (No Sink)	24" W Vanities	258

**Undercounter Sink available for Custom Countertop – see page 265.
See Cartesian Ganging Reference on pages 238 – 240.**

Add-On Accessories & Options

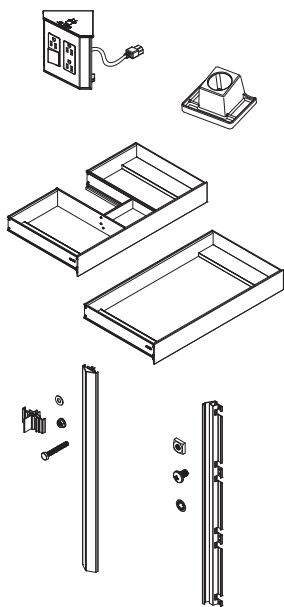

Description	Model	Price
Electric Accessory		
For use in 15" H plumbing or full drawer (H2)	VAELECTRIC21	\$ 479.
Hair Styling Organizer		
For use in 15" H full drawer (H2)	VAHAIRORG	\$ 249.
Slim Drawer Insert		
For use in 15" H plumbing drawer (H2)	VADRAWER24P	\$ 649.
For use in 15" H full drawer (H2)	VADRAWER24X	\$ 649.
Note: Not for use with plumbing drawer undercounter sink installations or with Robern's stone vanity tops. Can be used in above-counter vessel installations.		
Vanity Ganging Kit – Hardware required when combining two or more vanities (each connection point)		
7-1/2" H	VMGKITH1	\$ 99.
15" H	VMGKITH2	\$ 99.
22-1/2" H	VMGKITH3	\$ 229.
30" H	VMGKITH4	\$ 229.
Vanity Alcove Finishing Kit – Hardware required for corner or alcove installations		
7-1/2" H	VMAKITH1	\$ 99.
15" H	VMAKITH2	\$ 99.
22-1/2" H	VMAKITH3	\$ 229.
30" H	VMAKITH4	\$ 229.

See additional Accessories on pages 273 – 273.

Vanity Side Kits (sold separately)

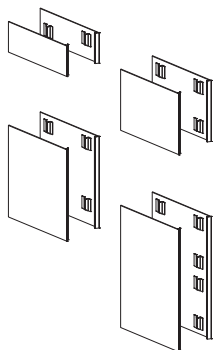

Description	Model	Essentials Palette	Classic Palette	Inspire Palette
Vanity Side Kits – Includes glass panel(s) & hardware (see Color Options on previous page)				
Single, 7-1/2" H, 21" D	VM1SKH1D21- __	\$ 229.	\$ 299.	\$ 349.
Pair, 7-1/2" H, 21" D	VM2SKH1D21- __	\$ 349.	\$ 479.	\$ 579.
Single, 15" H, 21" D	VM1SKH2D21- __	\$ 299.	\$ 349.	\$ 429.
Pair, 15" H, 21" D	VM2SKH2D21- __	\$ 429.	\$ 529.	\$ 649.
Single, 22-1/2" H, 21" D	VM1SKH3D21- __	\$ 349.	\$ 429.	\$ 479.
Pair, 22-1/2" H, 21" D	VM2SKH3D21- __	\$ 579.	\$ 699.	\$ 829.
Single, 30" H, 21" D	VM1SKH4D21- __	\$ 429.	\$ 479.	\$ 529.
Pair, 30" H, 21" D	VM2SKH4D21- __	\$ 699.	\$ 829.	\$ 929.

Note: You must choose one side kit or alcove kit for every exposed side.

SEE PAGES 236 – 237 FOR TIPS AND FEATURES.

Cartesian® Vanity – VM24 – 24" W x 18" D



Meet the world's most accommodating vanity. Like the mathematical system that inspired its name, the Cartesian wall-mount vanity offers infinite possibilities for every dimension in your design. Customizable configurations ensure storage that perfectly suits your needs.

- Customize around your own needs. Modular design allows you to add or upgrade your existing vanity or nightstand and add new features to infinitely expand the functionality
- Provides task and way-finding light by using the night light option



Available in a 2-week to 4-week lead time



Modular



Electrical Outlet



Night Light

24-1/8" W x 18-3/4" D Vanity

Description		Model	Essentials Palette 10, 11, 20, 21 Price	Classic Palette 22, 26, 27, 28, 60, 61 Price	Inspire Palette 12, 19, 23, 24, 25 Price
7-1/2" H Vanity – Plumbing Drawer, No Undercounter Sink					
	Base Unit	VM24H1D18P__N	\$ 1,049.	\$ 1,529.	\$ 1,949.
	With 2700K/4000K Night Light	VM24H1D18P__S	\$ 1,399.	\$ 1,849.	\$ 2,299.
	With 5000K Night Light	VM24H1D18P__L	\$ 1,399.	\$ 1,849.	\$ 2,299.
7-1/2" H Vanity – Full Drawer, No Sink					
	Base Unit	VM24H1D18F__N	\$ 1,049.	\$ 1,529.	\$ 1,949.
	With 2700K/4000K Night Light	VM24H1D18F__S	\$ 1,399.	\$ 1,849.	\$ 2,299.
	With 5000K Night Light	VM24H1D18F__L	\$ 1,399.	\$ 1,849.	\$ 2,299.
7-1/2" H Vanity – Tip Out Drawer					
	Base Unit	VM24H1D18T__N	\$ 1,049.	\$ 1,529.	\$ 1,949.
	With 2700K/4000K Night Light	VM24H1D18T__S	\$ 1,399.	\$ 1,849.	\$ 2,299.
	With 5000K Night Light	VM24H1D18T__L	\$ 1,399.	\$ 1,849.	\$ 2,299.
15" H Vanity – Plumbing Drawer					
	Base Unit	VM24H2D18P__N	\$ 1,279.	\$ 1,729.	\$ 2,199.
	With 2700K/4000K Night Light	VM24H2D18P__S	\$ 1,629.	\$ 2,099.	\$ 2,529.
	With 5000K Night Light	VM24H2D18P__L	\$ 1,629.	\$ 2,099.	\$ 2,529.
15" H Vanity – Full Drawer, No Sink					
	Base Unit	VM24H2D18F__N	\$ 1,279.	\$ 1,729.	\$ 2,199.
	With 2700K/4000K Night Light	VM24H2D18F__S	\$ 1,629.	\$ 2,099.	\$ 2,529.
	With 5000K Night Light	VM24H2D18F__L	\$ 1,629.	\$ 2,099.	\$ 2,529.

Vanity top, sink and side kits sold separately.

Vanity Color Options

Fill in __ designator to Model listed above with desired color. Example: VM24H2D18P28N.

Essentials Palette

- 10 Mirror
- 11 Tinted Gray Mirror
- 20 Black
- 21 White

Classic Palette

- 22 Beach
- 26 Matte White
- 27 Matte Gray
- 28 Matte Black
- 60 Reeded White **NEW!**
- 61 Reeded Brass **NEW!**

Inspire Palette

- 12 Satin Bronze
- 19 Satin White
- 23 Ocean
- 24 Smoke Screen
- 25 Silver Screen

See Vanity Tops, Accessories & Options on the following page.

Cartesian® Vanity – VM24 – 24" W x 18" D

25" W x 19" D Vanity Tops – For 18" D Vanities

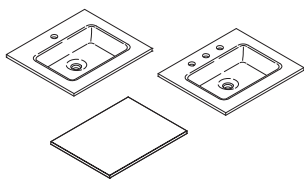

Description	For Use With Vanity	See Page
TC25UCN __ Glass Vanity Top	Plumbing & Tip Out Drawer	258
TE25G __ Engineered Stone Vanity Top (No Sink)	24" W Vanities	258

**Undercounter Sink available for Custom Countertop – see page 265.
See Cartesian Ganging Reference on pages 238 – 240.**

Add-On Accessories & Options

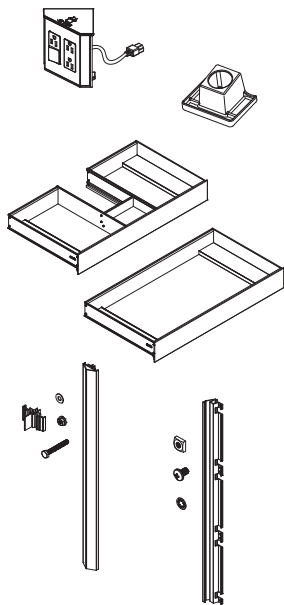

Description	Model	Price
Electric Accessory For use in 15" H plumbing or full drawer (H2)	VAELECTRIC18	\$ 479.
Hair Styling Organizer For use in 15" H full drawer (H2)	VAHAIRORG	\$ 249.
Slim Drawer Insert For use in 15" H plumbing drawer (H2)	VADRAWER24P	\$ 649.
For use in 15" H full drawer (H2)	VADRAWER24X	\$ 649.
Note: Not for use with plumbing drawer undercounter sink installations or with Robern's stone vanity tops. Can be used in above-counter vessel installations.		
Vanity Ganging Kit – Hardware required when combining two or more vanities (each connection point)		
7-1/2" H	VMGKITH1	\$ 99.
15" H	VMGKITH2	\$ 99.
22-1/2" H	VMGKITH3	\$ 229.
30" H	VMGKITH4	\$ 229.
Vanity Alcove Finishing Kit – Hardware required for corner or alcove installations		
7-1/2" H	VMAKITH1	\$ 99.
15" H	VMAKITH2	\$ 99.
22-1/2" H	VMAKITH3	\$ 229.
30" H	VMAKITH4	\$ 229.

See additional Accessories on pages 273 – 273.

Vanity Side Kits (sold separately)

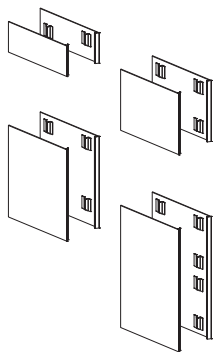

Description	Model	Essentials Palette	Classic Palette	Inspire Palette
Vanity Side Kits – Includes glass panel(s) & hardware (see Color Options on previous page)				
Single, 7-1/2" H, 18" D	VM1SKH1D18-__	\$ 229.	\$ 299.	\$ 349.
Pair, 7-1/2" H, 18" D	VM2SKH1D18-__	\$ 349.	\$ 479.	\$ 579.
Single, 15" H, 18" D	VM1SKH2D18-__	\$ 299.	\$ 349.	\$ 429.
Pair, 15" H, 18" D	VM2SKH2D18-__	\$ 429.	\$ 529.	\$ 649.
Single, 22-1/2" H, 18" D	VM1SKH3D18-__	\$ 349.	\$ 429.	\$ 479.
Pair, 22-1/2" H, 18" D	VM2SKH3D18-__	\$ 579.	\$ 699.	\$ 829.
Single, 30" H, 18" D	VM1SKH4D18-__	\$ 429.	\$ 479.	\$ 529.
Pair, 30" H, 18" D	VM2SKH4D18-__	\$ 699.	\$ 829.	\$ 929.

Note: You must choose one side kit or alcove kit for every exposed side.

SEE PAGES 236 – 237 FOR TIPS AND FEATURES.

Cartesian® Vanity – VM30 – 30" W x 21" D



Meet the world's most accommodating vanity. Like the mathematical system that inspired its name, the Cartesian wall-mount vanity offers infinite possibilities for every dimension in your design. Customizable configurations ensure storage that perfectly suits your needs.

- Customize around your own needs. Modular design allows you to add or upgrade your existing vanity or nightstand and add new features to infinitely expand the functionality
- Provides task and way-finding light by using the night light option



Available in a 2-week to 4-week lead time



30-1/8" W x 21-3/4" D Vanity

Description		Model	Essentials Palette 10, 11, 20, 21 Price	Classic Palette 22, 26, 27, 28, 60, 61 Price	Inspire Palette 12, 19, 23, 24, 25 Price
7-1/2" H Vanity – Plumbing Drawer, No Undercounter Sink					
	Base Unit	VM30H1D21P__N	\$ 1,629.	\$ 2,099.	\$ 2,529.
	With 2700K/4000K Night Light	VM30H1D21P__S	\$ 1,999.	\$ 2,479.	\$ 2,899.
	With 5000K Night Light	VM30H1D21P__L	\$ 1,999.	\$ 2,479.	\$ 2,899.
7-1/2" H Vanity – Full Drawer, No Sink					
	Base Unit	VM30H1D21F__N	\$ 1,629.	\$ 2,099.	\$ 2,529.
	With 2700K/4000K Night Light	VM30H1D21F__S	\$ 1,999.	\$ 2,479.	\$ 2,899.
	With 5000K Night Light	VM30H1D21F__L	\$ 1,999.	\$ 2,479.	\$ 2,899.
7-1/2" H Vanity – Tip Out Drawer					
	Base Unit	VM30H1D21T__N	\$ 1,629.	\$ 2,099.	\$ 2,529.
	With 2700K/4000K Night Light	VM30H1D21T__S	\$ 1,999.	\$ 2,479.	\$ 2,899.
	With 5000K Night Light	VM30H1D21T__L	\$ 1,999.	\$ 2,479.	\$ 2,899.
15" H Vanity – Plumbing Drawer					
	Base Unit	VM30H2D21P__N	\$ 1,849.	\$ 2,299.	\$ 2,749.
	With 2700K/4000K Night Light	VM30H2D21P__S	\$ 2,249.	\$ 2,699.	\$ 3,149.
	With 5000K Night Light	VM30H2D21P__L	\$ 2,249.	\$ 2,699.	\$ 3,149.
15" H Vanity – Full Drawer, No Sink					
	Base Unit	VM30H2D21F__N	\$ 1,849.	\$ 2,299.	\$ 2,749.
	With 2700K/4000K Night Light	VM30H2D21F__S	\$ 2,249.	\$ 2,699.	\$ 3,149.
	With 5000K Night Light	VM30H2D21F__L	\$ 2,249.	\$ 2,699.	\$ 3,149.

Vanity top, sink and side kits sold separately.

Vanity Color Options

Fill in __ designator to Model listed above with desired color. Example: VM30H1D21T20L.

Essentials Palette

- 10 Mirror
- 11 Tinted Gray Mirror
- 20 Black
- 21 White

Classic Palette

- 22 Beach
- 26 Matte White
- 27 Matte Gray
- 28 Matte Black
- 60 Reeded White
- 61 Reeded Brass

NEW!

NEW!

Inspire Palette

- 12 Satin Bronze
- 19 Satin White
- 23 Ocean
- 24 Smoke Screen
- 25 Silver Screen

See Vanity Tops, Accessories & Options on the following page.

Cartesian® Vanity – VM30 – 30" W x 21" D

31" W x 22" D Vanity Tops – For 21" D Vanities

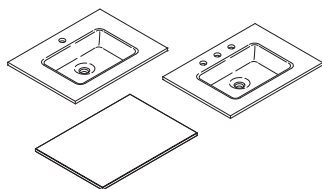

Description	For Use With Vanity	See Page
TS31UCN __ Glass Vanity Top	Plumbing & Tip Out Drawer	259
TF31UCO __ Engineered Stone Vanity Top	Plumbing & Tip Out Drawer	259
TF31G __ Engineered Stone Vanity Top (No Sink)	30" W Vanities	259

**Undercounter Sink available for Custom Countertop – see page 265.
See Cartesian Ganging Reference on pages 238 – 240.**

Add-On Accessories & Options

Description	Model	Price
Electric Accessory		
For use in 15" H plumbing or full drawer (H2)	VAELECTRIC21	\$ 479.
Hair Styling Organizer		
For use in 15" H plumbing (vessel only) or full drawer (H2)	VAHAIRORG	\$ 249.
Slim Drawer Insert		
For use in 15" H plumbing drawer (H2)	VADRAWER30P	\$ 749.
For use in 15" H full drawer (H2)	VADRAWER30X	\$ 749.
Note: Not for use with plumbing drawer undercounter sink installations or with Robern's stone vanity tops. Can be used in above-counter vessel installations.		
Vanity Ganging Kit – Hardware required when combining two or more vanities (each connection point)		
7-1/2" H	VMGKITH1	\$ 99.
15" H	VMGKITH2	\$ 99.
22-1/2" H	VMGKITH3	\$ 229.
30" H	VMGKITH4	\$ 229.
Vanity Alcove Finishing Kit – Hardware required for corner or alcove installations		
7-1/2" H	VMAKITH1	\$ 99.
15" H	VMAKITH2	\$ 99.
22-1/2" H	VMAKITH3	\$ 229.
30" H	VMAKITH4	\$ 229.

See additional Accessories on pages 273 – 273.

Vanity Side Kits (sold separately)

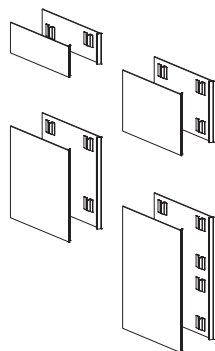

Description	Model	Essentials Palette	Classic Palette	Inspire Palette
Vanity Side Kits – Includes glass panel(s) & hardware (see Color Options on previous page)				
Single, 7-1/2" H, 21" D	VM1SKH1D21- __	\$ 229.	\$ 299.	\$ 349.
Pair, 7-1/2" H, 21" D	VM2SKH1D21- __	\$ 349.	\$ 479.	\$ 579.
Single, 15" H, 21" D	VM1SKH2D21- __	\$ 299.	\$ 349.	\$ 429.
Pair, 15" H, 21" D	VM2SKH2D21- __	\$ 429.	\$ 529.	\$ 649.
Single, 22-1/2" H, 21" D	VM1SKH3D21- __	\$ 349.	\$ 429.	\$ 479.
Pair, 22-1/2" H, 21" D	VM2SKH3D21- __	\$ 579.	\$ 699.	\$ 829.
Single, 30" H, 21" D	VM1SKH4D21- __	\$ 429.	\$ 479.	\$ 529.
Pair, 30" H, 21" D	VM2SKH4D21- __	\$ 699.	\$ 829.	\$ 929.

Note: You must choose one side kit or alcove kit for every exposed side.

SEE PAGES 236 – 237 FOR TIPS AND FEATURES.

Cartesian® Vanity – VM30 – 30" W x 18" D



Meet the world's most accommodating vanity. Like the mathematical system that inspired its name, the Cartesian wall-mount vanity offers infinite possibilities for every dimension in your design. Customizable configurations ensure storage that perfectly suits your needs.

- Customize around your own needs. Modular design allows you to add or upgrade your existing vanity or nightstand and add new features to infinitely expand the functionality
- Provides task and way-finding light by using the night light option



Available in a 2-week to 4-week lead time



30-1/8" W x 18-3/4" D Vanity

Description		Model	Essentials Palette 10, 11, 20, 21 Price	Classic Palette 22, 26, 27, 28, 60, 61 Price	Inspire Palette 12, 19, 23, 24, 25 Price
7-1/2" H Vanity – Plumbing Drawer, No Undercounter Sink					
	Base Unit	VM30H1D18P__N	\$ 1,629.	\$ 2,099.	\$ 2,529.
	With 2700K/4000K Night Light	VM30H1D18P__S	\$ 1,999.	\$ 2,479.	\$ 2,899.
	With 5000K Night Light	VM30H1D18P__L	\$ 1,999.	\$ 2,479.	\$ 2,899.
7-1/2" H Vanity – Full Drawer, No Sink					
	Base Unit	VM30H1D18F__N	\$ 1,629.	\$ 2,099.	\$ 2,529.
	With 2700K/4000K Night Light	VM30H1D18F__S	\$ 1,999.	\$ 2,479.	\$ 2,899.
	With 5000K Night Light	VM30H1D18F__L	\$ 1,999.	\$ 2,479.	\$ 2,899.
7-1/2" H Vanity – Tip Out Drawer					
	Base Unit	VM30H1D18T__N	\$ 1,629.	\$ 2,099.	\$ 2,529.
	With 2700K/4000K Night Light	VM30H1D18T__S	\$ 1,999.	\$ 2,479.	\$ 2,899.
	With 5000K Night Light	VM30H1D18T__L	\$ 1,999.	\$ 2,479.	\$ 2,899.
15" H Vanity – Plumbing Drawer					
	Base Unit	VM30H2D18P__N	\$ 1,849.	\$ 2,299.	\$ 2,749.
	With 2700K/4000K Night Light	VM30H2D18P__S	\$ 2,249.	\$ 2,699.	\$ 3,149.
	With 5000K Night Light	VM30H2D18P__L	\$ 2,249.	\$ 2,699.	\$ 3,149.
15" H Vanity – Full Drawer, No Sink					
	Base Unit	VM30H2D18F__N	\$ 1,849.	\$ 2,299.	\$ 2,749.
	With 2700K/4000K Night Light	VM30H2D18F__S	\$ 2,249.	\$ 2,699.	\$ 3,149.
	With 5000K Night Light	VM30H2D18F__L	\$ 2,249.	\$ 2,699.	\$ 3,149.

Vanity top, sink and side kits sold separately.

Vanity Color Options

Fill in __ designator to Model listed above with desired color. Example: VM30H1D18T20L.

Essentials Palette

- 10 Mirror
- 11 Tinted Gray Mirror
- 20 Black
- 21 White

Classic Palette

- 22 Beach
- 26 Matte White
- 27 Matte Gray
- 28 Matte Black
- 60 Reeded White
- 61 Reeded Brass

NEW!

NEW!

Inspire Palette

- 12 Satin Bronze
- 19 Satin White
- 23 Ocean
- 24 Smoke Screen
- 25 Silver Screen

See Vanity Tops, Accessories & Options on the following page.

Cartesian® Vanity – VM30 – 30" W x 18" D

31" W x 19" D Vanity Tops – For 18" D Vanities

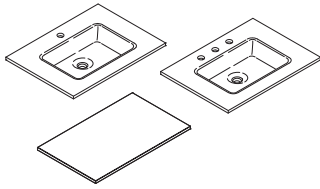

Description	For Use With Vanity	See Page
TC31UCN __ Glass Vanity Top	Plumbing & Tip Out Drawer	259
TE31G __ Engineered Stone Vanity Top (No Sink)	30" W Vanities	259

**Undercounter Sink available for Custom Countertop – see page 265.
See Cartesian Ganging Reference on pages 238 – 240.**

Add-On Accessories & Options

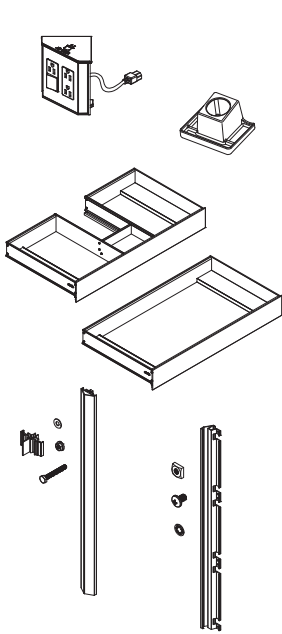

Description	Model	Price
Electric Accessory For use in 15" H plumbing or full drawer (H2)	VAELECTRIC18	\$ 479.
Hair Styling Organizer For use in 15" H plumbing (vessel only) or full drawer (H2)	VAHAIRORG	\$ 249.
Slim Drawer Insert For use in 15" H plumbing drawer (H2)	VADRAWER30P	\$ 749.
For use in 15" H full drawer (H2)	VADRAWER30X	\$ 749.
Note: Not for use with plumbing drawer undercounter sink installations or with Robern's stone vanity tops. Can be used in above-counter vessel installations.		
Vanity Ganging Kit – Hardware required when combining two or more vanities (each connection point)		
7-1/2" H	VMGKITH1	\$ 99.
15" H	VMGKITH2	\$ 99.
22-1/2" H	VMGKITH3	\$ 229.
30" H	VMGKITH4	\$ 229.
Vanity Alcove Finishing Kit – Hardware required for corner or alcove installations		
7-1/2" H	VMAKITH1	\$ 99.
15" H	VMAKITH2	\$ 99.
22-1/2" H	VMAKITH3	\$ 229.
30" H	VMAKITH4	\$ 229.

See additional Accessories on pages 273 – 273.

Vanity Side Kits (sold separately)

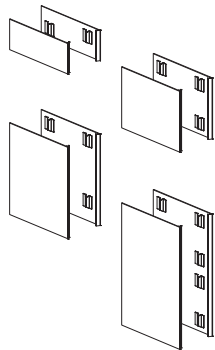

Description	Model	Essentials Palette	Classic Palette	Inspire Palette
Vanity Side Kits – Includes glass panel(s) & hardware (see Color Options on previous page)				
Single, 7-1/2" H, 18" D	VM1SKH1D18-__	\$ 229.	\$ 299.	\$ 349.
Pair, 7-1/2" H, 18" D	VM2SKH1D18-__	\$ 349.	\$ 479.	\$ 579.
Single, 15" H, 18" D	VM1SKH2D18-__	\$ 299.	\$ 349.	\$ 429.
Pair, 15" H, 18" D	VM2SKH2D18-__	\$ 429.	\$ 529.	\$ 649.
Single, 22-1/2" H, 18" D	VM1SKH3D18-__	\$ 349.	\$ 429.	\$ 479.
Pair, 22-1/2" H, 18" D	VM2SKH3D18-__	\$ 579.	\$ 699.	\$ 829.
Single, 30" H, 18" D	VM1SKH4D18-__	\$ 429.	\$ 479.	\$ 529.
Pair, 30" H, 18" D	VM2SKH4D18-__	\$ 699.	\$ 829.	\$ 929.

Note: You must choose one side kit or alcove kit for every exposed side.

SEE PAGES 236 – 237 FOR TIPS AND FEATURES.

Cartesian® Vanity – VM36 – 36" W x 21" D



Meet the world's most accommodating vanity. Like the mathematical system that inspired its name, the Cartesian wall-mount vanity offers infinite possibilities for every dimension in your design. Customizable configurations ensure storage that perfectly suits your needs.

- Customize around your own needs. Modular design allows you to add or upgrade your existing vanity or nightstand and add new features to infinitely expand the functionality
- Provides task and way-finding light by using the night light option



Available in a 2-week to 4-week lead time



Modular



Electrical Outlet



Night Light

36-1/8" W x 21-3/4" D Vanity

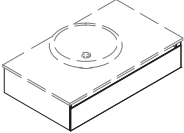
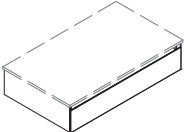
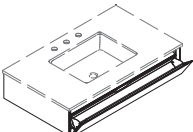
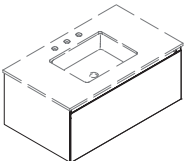
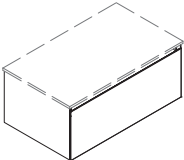
Description		Model	Essentials Palette 10, 11, 20, 21 Price	Classic Palette 22, 26, 27, 28, 60, 61 Price	Inspire Palette 12, 19, 23, 24, 25 Price
7-1/2" H Vanity – Plumbing Drawer, No Undercounter Sink					
	Base Unit	VM36H1D21P__N	\$ 2,199.	\$ 2,629.	\$ 3,099.
	With 2700K/4000K Night Light	VM36H1D21P__S	\$ 2,629.	\$ 3,099.	\$ 3,529.
	With 5000K Night Light	VM36H1D21P__L	\$ 2,629.	\$ 3,099.	\$ 3,529.
7-1/2" H Vanity – Full Drawer, No Sink					
	Base Unit	VM36H1D21F__N	\$ 2,199.	\$ 2,629.	\$ 3,099.
	With 2700K/4000K Night Light	VM36H1D21F__S	\$ 2,629.	\$ 3,099.	\$ 3,529.
	With 5000K Night Light	VM36H1D21F__L	\$ 2,629.	\$ 3,099.	\$ 3,529.
7-1/2" H Vanity – Tip Out Drawer					
	Base Unit	VM36H1D21T__N	\$ 2,199.	\$ 2,629.	\$ 3,099.
	With 2700K/4000K Night Light	VM36H1D21T__S	\$ 2,629.	\$ 3,099.	\$ 3,529.
	With 5000K Night Light	VM36H1D21T__L	\$ 2,629.	\$ 3,099.	\$ 3,529.
15" H Vanity – Plumbing Drawer					
	Base Unit	VM36H2D21P__N	\$ 2,429.	\$ 2,849.	\$ 3,299.
	With 2700K/4000K Night Light	VM36H2D21P__S	\$ 2,849.	\$ 3,299.	\$ 3,749.
	With 5000K Night Light	VM36H2D21P__L	\$ 2,849.	\$ 3,299.	\$ 3,749.
15" H Vanity – Full Drawer, No Sink					
	Base Unit	VM36H2D21F__N	\$ 2,429.	\$ 2,849.	\$ 3,299.
	With 2700K/4000K Night Light	VM36H2D21F__S	\$ 2,849.	\$ 3,299.	\$ 3,749.
	With 5000K Night Light	VM36H2D21F__L	\$ 2,849.	\$ 3,299.	\$ 3,749.

Vanity top, sink and side kits sold separately.

Vanity Color Options

Fill in __ designator to Model listed above with desired color. Example: VM36H2D21F26N.

Essentials Palette

- 10 Mirror
- 11 Tinted Gray Mirror
- 20 Black
- 21 White

Classic Palette

- 22 Beach
- 26 Matte White
- 27 Matte Gray
- 28 Matte Black
- 60 Reeded White
- 61 Reeded Brass

NEW!

NEW!

Inspire Palette

- 12 Satin Bronze
- 19 Satin White
- 23 Ocean
- 24 Smoke Screen
- 25 Silver Screen

See Vanity Tops, Accessories & Options on the following page.

Cartesian® Vanity – VM36 – 36" W x 21" D

37" W x 22" D Vanity Tops – For 21" D Vanities

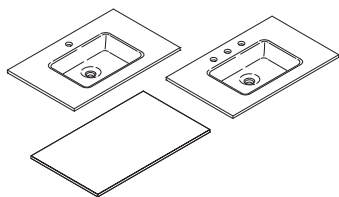

Description	For Use With Vanity	See Page
TF37UCO __ Engineered Stone Vanity Top	Plumbing & Tip Out Drawer	260
TF37G __ Engineered Stone Vanity Top (No Sink)	36" W Vanities	260

**Undercounter Sink available for Custom Countertop – see page 265.
See Cartesian Ganging Reference on pages 238 – 240.**

Add-On Accessories & Options

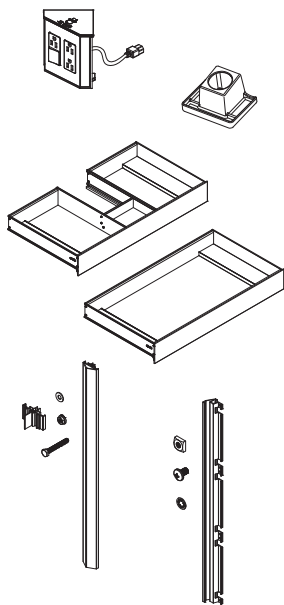

Description	Model	Price
Electric Accessory For use in 15" H plumbing or full drawer (H2)	VAELECTRIC21	\$ 479.
Hair Styling Organizer For use in 15" H plumbing (vessel only) or full drawer (H2)	VAHAIRORG	\$ 249.
Slim Drawer Insert For use in 15" H plumbing drawer (H2)	VADRAWER36P	\$ 829.
For use in 15" H full drawer (H2)	VADRAWER36X	\$ 829.
Note: Not for use with plumbing drawer undercounter sink installations or with Robern's stone vanity tops. Can be used in above-counter vessel installations.		
Vanity Ganging Kit – Hardware required when combining two or more vanities (each connection point)		
7-1/2" H	VMGKITH1	\$ 99.
15" H	VMGKITH2	\$ 99.
22-1/2" H	VMGKITH3	\$ 229.
30" H	VMGKITH4	\$ 229.
Vanity Alcove Finishing Kit – Hardware required for corner or alcove installations		
7-1/2" H	VMAKITH1	\$ 99.
15" H	VMAKITH2	\$ 99.
22-1/2" H	VMAKITH3	\$ 229.
30" H	VMAKITH4	\$ 229.

See additional Accessories on pages 273 – 273.

Vanity Side Kits (sold separately)

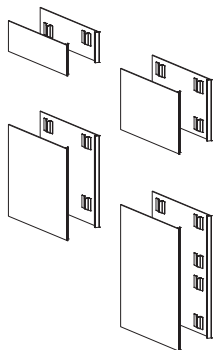

Description	Model	Essentials Palette	Classic Palette	Inspire Palette
Vanity Side Kits – Includes glass panel(s) & hardware (see Color Options on previous page)				
Single, 7-1/2" H, 21" D	VM1SKH1D21- __	\$ 229.	\$ 299.	\$ 349.
Pair, 7-1/2" H, 21" D	VM2SKH1D21- __	\$ 349.	\$ 479.	\$ 579.
Single, 15" H, 21" D	VM1SKH2D21- __	\$ 299.	\$ 349.	\$ 429.
Pair, 15" H, 21" D	VM2SKH2D21- __	\$ 429.	\$ 529.	\$ 649.
Single, 22-1/2" H, 21" D	VM1SKH3D21- __	\$ 349.	\$ 429.	\$ 479.
Pair, 22-1/2" H, 21" D	VM2SKH3D21- __	\$ 579.	\$ 699.	\$ 829.
Single, 30" H, 21" D	VM1SKH4D21- __	\$ 429.	\$ 479.	\$ 529.
Pair, 30" H, 21" D	VM2SKH4D21- __	\$ 699.	\$ 829.	\$ 929.

Note: You must choose one side kit or alcove kit for every exposed side.

SEE PAGES 236 – 237 FOR TIPS AND FEATURES.

Cartesian® Vanity – VM36 – 36" W x 18" D



Meet the world's most accommodating vanity. Like the mathematical system that inspired its name, the Cartesian wall-mount vanity offers infinite possibilities for every dimension in your design. Customizable configurations ensure storage that perfectly suits your needs.

- Customize around your own needs. Modular design allows you to add or upgrade your existing vanity or nightstand and add new features to infinitely expand the functionality
- Provides task and way-finding light by using the night light option



Available in a 2-week to 4-week lead time



Modular



Electrical Outlet



Night Light

36-1/8" W x 18-3/4" D Vanity

Description		Model	Essentials Palette 10, 11, 20, 21 Price	Classic Palette 22, 26, 27, 28, 60, 61 Price	Inspire Palette 12, 19, 23, 24, 25 Price
7-1/2" H Vanity – Plumbing Drawer, No Undercounter Sink					
	Base Unit	VM36H1D18P__N	\$ 2,199.	\$ 2,629.	\$ 3,099.
	With 2700K/4000K Night Light	VM36H1D18P__S	\$ 2,629.	\$ 3,099.	\$ 3,529.
	With 5000K Night Light	VM36H1D18P__L	\$ 2,629.	\$ 3,099.	\$ 3,529.
7-1/2" H Vanity – Full Drawer, No Sink					
	Base Unit	VM36H1D18F__N	\$ 2,199.	\$ 2,629.	\$ 3,099.
	With 2700K/4000K Night Light	VM36H1D18F__S	\$ 2,629.	\$ 3,099.	\$ 3,529.
	With 5000K Night Light	VM36H1D18F__L	\$ 2,629.	\$ 3,099.	\$ 3,529.
7-1/2" H Vanity – Tip Out Drawer					
	Base Unit	VM36H1D18T__N	\$ 2,199.	\$ 2,629.	\$ 3,099.
	With 2700K/4000K Night Light	VM36H1D18T__S	\$ 2,629.	\$ 3,099.	\$ 3,529.
	With 5000K Night Light	VM36H1D18T__L	\$ 2,629.	\$ 3,099.	\$ 3,529.
15" H Vanity – Plumbing Drawer					
	Base Unit	VM36H2D18P__N	\$ 2,429.	\$ 2,849.	\$ 3,299.
	With 2700K/4000K Night Light	VM36H2D18P__S	\$ 2,849.	\$ 3,299.	\$ 3,749.
	With 5000K Night Light	VM36H2D18P__L	\$ 2,849.	\$ 3,299.	\$ 3,749.
15" H Vanity – Full Drawer, No Sink					
	Base Unit	VM36H2D18F__N	\$ 2,429.	\$ 2,849.	\$ 3,299.
	With 2700K/4000K Night Light	VM36H2D18F__S	\$ 2,849.	\$ 3,299.	\$ 3,749.
	With 5000K Night Light	VM36H2D18F__L	\$ 2,849.	\$ 3,299.	\$ 3,749.

Vanity top, sink and side kits sold separately.

Vanity Color Options

Fill in __ designator to Model listed above with desired color. Example: VM36H2D18F26N.

Essentials Palette

- 10 Mirror
- 11 Tinted Gray Mirror
- 20 Black
- 21 White

Classic Palette

- 22 Beach
- 26 Matte White
- 27 Matte Gray
- 28 Matte Black
- 60 Reeded White
- 61 Reeded Brass

NEW!

NEW!

Inspire Palette

- 12 Satin Bronze
- 19 Satin White
- 23 Ocean
- 24 Smoke Screen
- 25 Silver Screen

See Vanity Tops, Accessories & Options on the following page.

Cartesian® Vanity – VM36 – 36" W x 18" D

37" W x 19" D Vanity Tops – For 18" D Vanities

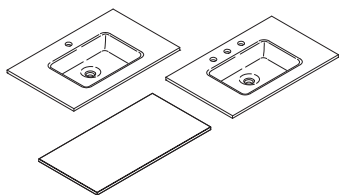

Description	For Use With Vanity	See Page
TC37UCN __ Glass Vanity Top	Plumbing & Tip Out Drawer	260
TE37G __ Engineered Stone Vanity Top (No Sink)	36" W Vanities	260

**Undercounter Sink available for Custom Countertop – see page 265.
See Cartesian Ganging Reference on pages 238 – 240.**

Add-On Accessories & Options

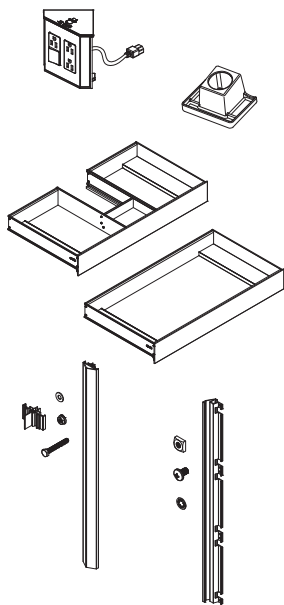

Description	Model	Price
Electric Accessory For use in 15" H plumbing or full drawer (H2)	VAELECTRIC18	\$ 479.
Hair Styling Organizer For use in 15" H plumbing (vessel only) or full drawer (H2)	VAHAIRORG	\$ 249.
Slim Drawer Insert For use in 15" H plumbing drawer (H2)	VADRAWER36P	\$ 829.
For use in 15" H full drawer (H2)	VADRAWER36X	\$ 829.
Note: Not for use with plumbing drawer undercounter sink installations or with Robern's stone vanity tops. Can be used in above-counter vessel installations.		
Vanity Ganging Kit – Hardware required when combining two or more vanities (each connection point)		
7-1/2" H	VMGKITH1	\$ 99.
15" H	VMGKITH2	\$ 99.
22-1/2" H	VMGKITH3	\$ 229.
30" H	VMGKITH4	\$ 229.
Vanity Alcove Finishing Kit – Hardware required for corner or alcove installations		
7-1/2" H	VMAKITH1	\$ 99.
15" H	VMAKITH2	\$ 99.
22-1/2" H	VMAKITH3	\$ 229.
30" H	VMAKITH4	\$ 229.

See additional Accessories on pages 273 – 273.

Vanity Side Kits (sold separately)

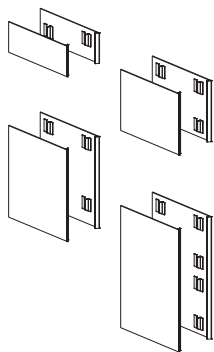

Description	Model	Essentials Palette	Classic Palette	Inspire Palette
Vanity Side Kits – Includes glass panel(s) & hardware (see Color Options on previous page)				
Single, 7-1/2" H, 18" D	VM1SKH1D18- __	\$ 229.	\$ 299.	\$ 349.
Pair, 7-1/2" H, 18" D	VM2SKH1D18- __	\$ 349.	\$ 479.	\$ 579.
Single, 15" H, 18" D	VM1SKH2D18- __	\$ 299.	\$ 349.	\$ 429.
Pair, 15" H, 18" D	VM2SKH2D18- __	\$ 429.	\$ 529.	\$ 649.
Single, 22-1/2" H, 18" D	VM1SKH3D18- __	\$ 349.	\$ 429.	\$ 479.
Pair, 22-1/2" H, 18" D	VM2SKH3D18- __	\$ 579.	\$ 699.	\$ 829.
Single, 30" H, 18" D	VM1SKH4D18- __	\$ 429.	\$ 479.	\$ 529.
Pair, 30" H, 18" D	VM2SKH4D18- __	\$ 699.	\$ 829.	\$ 929.

Note: You must choose one side kit or alcove kit for every exposed side.

SEE PAGES 236 – 237 FOR TIPS AND FEATURES.

Vanity Tops – Table of Contents, Tips & Features

Table of Contents

13" Wide Vanity Tops	258
25" Wide Vanity Tops	258
31" Wide Vanity Tops	259
37" Wide Vanity Tops	260
49" Wide Vanity Tops	262
61" Wide Vanity Tops	263
73" Wide Vanity Tops	264 – 265
Undercounter Sink	265
Cartesian® & Profiles® Vanities Undermount Bowl Space Availability	266

Tips & Features



Eliminate the guesswork when it comes to pairing your vanity and top. Robern's expanded vanity top program offers a full range of pre-cut sizes, materials, and colors (280, from 13" to 73" wide) to meet the needs of any space with a pre-curated solution.

Dimensions & Weight

- Width:
 - 13" (330 mm)
 - 25" (635 mm)
 - 31" (787 mm)
 - 37" (940 mm)
 - 43" (1092 mm)
 - 49" (1245 mm)
 - 61" (1549 mm)
 - 73" (1854 mm)
- Depth:
 - 19" (483 mm)
 - 22" (559 mm)
- Thickness:
 - 19/32" (15 mm) – glass
 - 3/4" (19 mm) – engineered stone



QUARTZ SURFACES

Engineered Stone Tops are exclusively provided by Silestone.

Features & Benefits

- Offers 280 options, 16 cut patterns, 6 colors and 2 materials, for a one-stop shop experience that streamlines your selection process
- Stunning glass top features rectangular integrated sink, without overflow, available in White
- Striking engineered stone tops feature a white rectangular sink, with overflow, available in White Zeus Extreme, Quartz White (White Storm), Lyra, Stone Gray (Expo Grey) and Lava Black (Tebas Black)

Configurable Options

- Vanity Styles: dry top, center sink, left offset sink, right offset sink, double sink, triple sink
- Color Options: quartz white, white zeus extreme, lyra, stone gray, lava black, white glass
- Faucet Drillings: single or three hole 8" widespread

Installation

- Includes installation hardware, silicone and a sink



Glass Tops



Engineered Stone Tops

Vanity Tops

13" W Vanity Tops

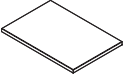
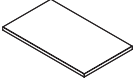
	Color	Model	For Use With Vanities	Price
Engineered Stone Vanity Top – 13" W x 19" D x 3/4" thick – No Sink				
	Lava Black (Tebas Black)	TE13G90	12" W Cartesian® & Profiles® (18" D)	\$ 899.
	Stone Gray (Expo Grey)	TE13G91		\$ 899.
	Quartz White (White Storm)	TE13G92		\$ 1,029.
	White Zeus Extreme	TE13G93		\$ 1,349.
	Lyra	TE13G94		\$ 1,349.
Engineered Stone Vanity Top – 13" W x 22" D x 3/4" thick – No Sink				
	Lava Black (Tebas Black)	TF13G90	12" W Cartesian & Profiles (21" D) & V14®	\$ 899.
	Stone Gray (Expo Grey)	TF13G91		\$ 899.
	Quartz White (White Storm)	TF13G92		\$ 1,029.
	White Zeus Extreme	TF13G93		\$ 1,349.
	Lyra	TF13G94		\$ 1,349.

25" W Vanity Tops

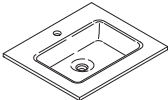
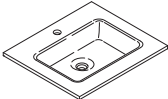
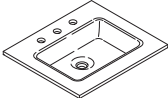
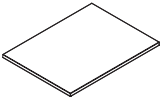
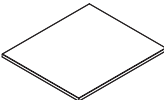
	Color	Model*	For Use With Vanities	Price	
Glass Vanity Top – 25" W x 19" D x 19/32" thick – Center Sink (Sink Dimensions = 15-1/2" W x 10" L x 5" D)					
	White	TC25UCN21-1	24" W Cartesian & Profiles (18" D)	\$ 1,049.	
		TC25UCN21-8		\$ 1,049.	
Glass Vanity Top – 25" W x 22" D x 19/32" thick – Center Sink (Sink Dimensions = 17-1/2" W x 12-1/2" L x 5" D)					
	White	TS25UCN21-1	24" W Cartesian & Profiles (21" D) & V14	\$ 1,049.	
		TS25UCN21-8		\$ 1,049.	
Engineered Stone Vanity Top – 25" W x 22" D x 3/4" thick – Center Sink (Sink Dimensions = 17-1/4" W x 13" L x 5" D)					
	Lava Black (Tebas Black)	TF25UCO90-1	24" W Cartesian & Profiles (21" D) & V14	\$ 1,479.	
		TF25UCO90-8		\$ 1,479.	
		Stone Gray (Expo Grey)		TF25UCO91-1	\$ 1,479.
		TF25UCO91-8		\$ 1,479.	
		Quartz White (White Storm)		TF25UCO92-1	\$ 1,599.
		TF25UCO92-8		\$ 1,599.	
		White Zeus Extreme		TF25UCO93-1	\$ 1,929.
		TF25UCO93-8		\$ 1,929.	
Lyra	TF25UCO94-1	\$ 1,929.			
	TF25UCO94-8	\$ 1,929.			
Engineered Stone Vanity Top – 25" W x 19" D x 3/4" thick – No Sink					
	Lava Black (Tebas Black)	TE25G90	24" W Cartesian & Profiles (18" D)	\$ 1,149.	
	Stone Gray (Expo Grey)	TE25G91		\$ 1,149.	
	Quartz White (White Storm)	TE25G92		\$ 1,249.	
	White Zeus Extreme	TE25G93		\$ 1,599.	
	Lyra	TE25G94		\$ 1,599.	
Engineered Stone Vanity Top – 25" W x 22" D x 3/4" thick – No Sink					
	Lava Black (Tebas Black)	TF25G90	24" W Cartesian & Profiles (21" D) & V14	\$ 1,149.	
	Stone Gray (Expo Grey)	TF25G91		\$ 1,149.	
	Quartz White (White Storm)	TF25G92		\$ 1,249.	
	White Zeus Extreme	TF25G93		\$ 1,599.	
	Lyra	TF25G94		\$ 1,599.	

* -1 = Single-Hole Drilling
 -8 = 8" Widespread (3-Hole Centered on Sink Location)

Vanity Tops

31" W Vanity Tops

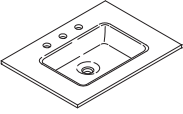
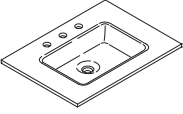
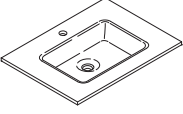
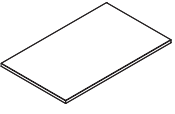
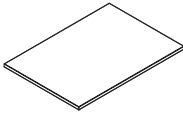
	Color	Model*	For Use With Vanities	Price
Glass Vanity Top – 31" W x 19" D x 19/32" thick – Center Sink (Sink Dimensions = 15-1/2" W x 10" L x 5" D)				
	White	TC31UCN21-1	30" W Cartesian® & Profiles® (18" D)	\$ 1,149.
		TC31UCN21-8		\$ 1,149.
Glass Vanity Top – 31" W x 22" D x 19/32" thick – Center Sink (Sink Dimensions = 17-1/2" W x 12-1/2" L x 5" D)				
	White	TS31UCN21-1	30" W Cartesian & Profiles (21" D) & V14®	\$ 1,149.
		TS31UCN21-8		\$ 1,149.
Engineered Stone Vanity Top – 31" W x 22" D x 3/4" thick – Center Sink (Sink Dimensions = 17-1/4" W x 13" L x 5" D)				
	Lava Black (Tebas Black)	TF31UCO90-1	30" W Cartesian & Profiles (21" D) & V14	\$ 1,599.
		TF31UCO90-8		\$ 1,599.
	Stone Gray (Expo Grey)	TF31UCO91-1		\$ 1,599.
		TF31UCO91-8		\$ 1,599.
	Quartz White (White Storm)	TF31UCO92-1		\$ 1,699.
		TF31UCO92-8		\$ 1,699.
	White Zeus Extreme	TF31UCO93-1		\$ 2,029.
		TF31UCO93-8		\$ 2,029.
Lyra	TF31UCO94-1		\$ 2,029.	
	TF31UCO94-8		\$ 2,029.	
Engineered Stone Vanity Top – 31" W x 19" D x 3/4" thick – No Sink				
	Lava Black (Tebas Black)	TE31G90	30" W Cartesian & Profiles (18" D)	\$ 1,249.
	Stone Gray (Expo Grey)	TE31G91		\$ 1,249.
	Quartz White (White Storm)	TE31G92		\$ 1,349.
	White Zeus Extreme	TE31G93		\$ 1,699.
	Lyra	TE31G94		\$ 1,699.
Engineered Stone Vanity Top – 31" W x 22" D x 3/4" thick – No Sink				
	Lava Black (Tebas Black)	TF31G90	30" W Cartesian & Profiles (21" D) & V14	\$ 1,249.
	Stone Gray (Expo Grey)	TF31G91		\$ 1,249.
	Quartz White (White Storm)	TF31G92		\$ 1,349.
	White Zeus Extreme	TF31G93		\$ 1,699.
	Lyra	TF31G94		\$ 1,699.

* -1 = Single-Hole Drilling
 -8 = 8" Widespread (3-Hole Centered on Sink Location)

Vanity Tops

37" W Vanity Tops

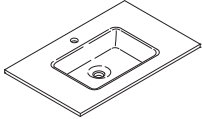
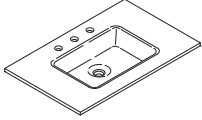
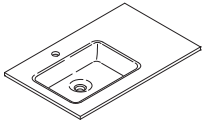
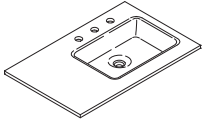
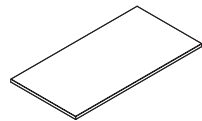
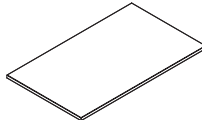
	Color	Model*	For Use With Vanities	Price
Glass Vanity Top – 37" W x 19" D x 19/32" thick – Center Sink (Sink Dimensions = 15-1/2" W x 10" L x 5" D)				
	White	TC37UCN21-1	36" W Cartesian® & Profiles® (18" D)	\$ 1,399.
		TC37UCN21-8		\$ 1,399.
Engineered Stone Vanity Top – 37" W x 22" D x 3/4" thick – Center Sink (Sink Dimensions = 17-1/4" W x 13" L x 5" D)				
	Lava Black (Tebas Black)	TF37UCO90-1	36" W Cartesian & Profiles (21" D) & V14® (single-drawer)	\$ 1,699.
		TF37UCO90-8		\$ 1,699.
	Stone Gray (Expo Grey)	TF37UCO91-1		\$ 1,699.
		TF37UCO91-8		\$ 1,699.
	Quartz White (White Storm)	TF37UCO92-1		\$ 1,829.
		TF37UCO92-8		\$ 1,829.
	White Zeus Extreme	TF37UCO93-1		\$ 2,149.
		TF37UCO93-8		\$ 2,149.
Lyra	TF37UCO94-1		\$ 2,149.	
	TF37UCO94-8		\$ 2,149.	
Engineered Stone Vanity Top – 37" W x 22" D x 3/4" thick – Left Sink (Sink Dimensions = 17-1/4" W x 13" L x 5" D)				
	Lava Black (Tebas Black)	TF37ULO90-1	36" W V14 (two-drawer) or 21" D Cartesian & Profiles vanity arrangement (24-12)	\$ 1,699.
		TF37ULO90-8		\$ 1,699.
	Stone Gray (Expo Grey)	TF37ULO91-1		\$ 1,699.
		TF37ULO91-8		\$ 1,699.
	Quartz White (White Storm)	TF37ULO92-1		\$ 1,829.
		TF37ULO92-8		\$ 1,829.
	White Zeus Extreme	TF37ULO93-1		\$ 2,149.
		TF37ULO93-8		\$ 2,149.
Lyra	TF37ULO94-1		\$ 2,149.	
	TF37ULO94-8		\$ 2,149.	
Engineered Stone Vanity Top – 37" W x 22" D x 3/4" thick – Right Sink (Sink Dimensions = 17-1/4" W x 13" L x 5" D)				
	Lava Black (Tebas Black)	TF37URO90-1	36" W V14 (two-drawer) or 21" D Cartesian & Profiles vanity arrangement (12-24)	\$ 1,699.
		TF37URO90-8		\$ 1,699.
	Stone Gray (Expo Grey)	TF37URO91-1		\$ 1,699.
		TF37URO91-8		\$ 1,699.
	Quartz White (White Storm)	TF37URO92-1		\$ 1,829.
		TF37URO92-8		\$ 1,829.
	White Zeus Extreme	TF37URO93-1		\$ 2,149.
		TF37URO93-8		\$ 2,149.
Lyra	TF37URO94-1		\$ 2,149.	
	TF37URO94-8		\$ 2,149.	
Engineered Stone Vanity Top – 37" W x 19" D x 3/4" thick – No Sink				
	Lava Black (Tebas Black)	TE37G90	36" W Cartesian & Profiles (18" D)	\$ 1,349.
	Stone Gray (Expo Grey)	TE37G91		\$ 1,349.
	Quartz White (White Storm)	TE37G92		\$ 1,479.
	White Zeus Extreme	TE37G93		\$ 1,829.
	Lyra	TE37G94		\$ 1,829.
Engineered Stone Vanity Top – 37" W x 22" D x 3/4" thick – No Sink				
	Lava Black (Tebas Black)	TF37G90	36" W Cartesian & Profiles (21" D) & V14	\$ 1,349.
	Stone Gray (Expo Grey)	TF37G91		\$ 1,349.
	Quartz White (White Storm)	TF37G92		\$ 1,479.
	White Zeus Extreme	TF37G93		\$ 1,829.
	Lyra	TF37G94		\$ 1,829.

* -1 = Single-Hole Drilling
 -8 = 8" Widespread (3-Hole Centered on Sink Location)

Vanity Tops

43" W Vanity Tops

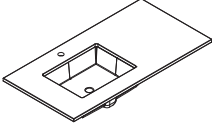
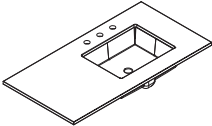
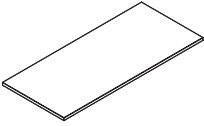
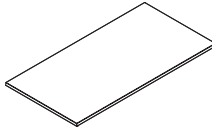
	Color	Model*	For Use With Vanities	Price
Engineered Stone Vanity Top – 43" W x 22" D x 3/4" thick – Left Sink (Sink Dimensions = 17-1/4" W x 13" L x 5" D)				
	Lava Black (Tebas Black)	TF43ULO90-1	21" D Cartesian® & Profiles® vanity arrangement (30-12)	\$ 1,929.
		TF43ULO90-8		\$ 1,929.
	Stone Gray (Expo Grey)	TF43ULO91-1		\$ 1,929.
		TF43ULO91-8		\$ 1,929.
	Quartz White (White Storm)	TF43ULO92-1		\$ 2,029.
		TF43ULO92-8		\$ 2,029.
	White Zeus Extreme	TF43ULO93-1		\$ 2,379.
		TF43ULO93-8		\$ 2,379.
	Lyra	TF43ULO94-1		\$ 2,379.
		TF43ULO94-8		\$ 2,379.
Engineered Stone Vanity Top – 43" W x 22" D x 3/4" thick – Right Sink (Sink Dimensions = 17-1/4" W x 13" L x 5" D)				
	Lava Black (Tebas Black)	TF43URO90-1	21" D Cartesian & Profiles vanity arrangement (12-30)	\$ 1,929.
		TF43URO90-8		\$ 1,929.
	Stone Gray (Expo Grey)	TF43URO91-1		\$ 1,929.
		TF43URO91-8		\$ 1,929.
	Quartz White (White Storm)	TF43URO92-1		\$ 2,029.
		TF43URO92-8		\$ 2,029.
	White Zeus Extreme	TF43URO93-1		\$ 2,379.
		TF43URO93-8		\$ 2,379.
	Lyra	TF43URO94-1		\$ 2,379.
		TF43URO94-8		\$ 2,379.
Engineered Stone Vanity Top – 43" W x 19" D x 3/4" thick – No Sink				
	Lava Black (Tebas Black)	TE43G90	18" D Cartesian & Profiles vanity arrangement (30-12) or (12-30)	\$ 1,599.
	Stone Gray (Expo Grey)	TE43G91		\$ 1,599.
	Quartz White (White Storm)	TE43G92		\$ 1,699.
	White Zeus Extreme	TE43G93		\$ 2,029.
	Lyra	TE43G94		\$ 2,029.
Engineered Stone Vanity Top – 43" W x 22" D x 3/4" thick – No Sink				
	Lava Black (Tebas Black)	TF43G90	21" D Cartesian & Profiles vanity arrangement (30-12) or (12-30)	\$ 1,599.
	Stone Gray (Expo Grey)	TF43G91		\$ 1,599.
	Quartz White (White Storm)	TF43G92		\$ 1,699.
	White Zeus Extreme	TF43G93		\$ 2,029.
	Lyra	TF43G94		\$ 2,029.

* -1 = Single-Hole Drilling

-8 = 8" Widespread (3-Hole Centered on Sink Location)

Vanity Tops

49" W Vanity Tops

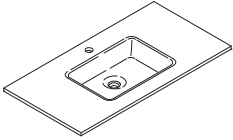
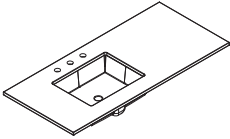
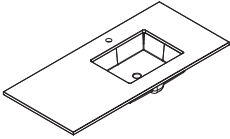
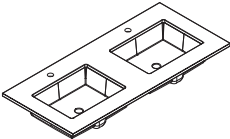
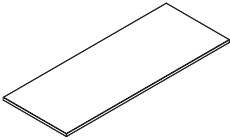
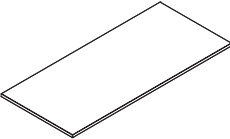
	Color	Model*	For Use With Vanities	Price
Engineered Stone Vanity Top – 49" W x 22" D x 3/4" thick – Center Sink (Sink Dimensions = 17-1/4" W x 13" L x 5" D)				
	Lava Black (Tebas Black)	TF49UCO90-1	48" W V14 [®] (three-drawer) or 21" D Cartesian [®] & Profiles [®] vanity arrangement (12-24-12)	\$ 2,029.
	Stone Gray (Expo Grey)	TF49UCO90-8		\$ 2,029.
		TF49UCO91-1		\$ 2,029.
		TF49UCO91-8		\$ 2,029.
	Quartz White (White Storm)	TF49UCO92-1		\$ 2,149.
		TF49UCO92-8		\$ 2,149.
	White Zeus Extreme	TF49UCO93-1		\$ 2,599.
	TF49UCO93-8	\$ 2,599.		
Lyra	TF49UCO94-1	\$ 2,599.		
	TF49UCO94-8	\$ 2,599.		
Engineered Stone Vanity Top – 49" W x 22" D x 3/4" thick – Left Sink (Sink Dimensions = 17-1/4" W x 13" L x 5" D)				
	Lava Black (Tebas Black)	TF49ULO90-1	21" D Cartesian & Profiles vanity arrangement (36-12)	\$ 2,029.
		TF49ULO90-8		\$ 2,029.
	Stone Gray (Expo Grey)	TF49ULO91-1		\$ 2,029.
		TF49ULO91-8		\$ 2,029.
	Quartz White (White Storm)	TF49ULO92-1		\$ 2,149.
		TF49ULO92-8		\$ 2,149.
	White Zeus Extreme	TF49ULO93-1		\$ 2,599.
	TF49ULO93-8	\$ 2,599.		
Lyra	TF49ULO94-1	\$ 2,599.		
	TF49ULO94-8	\$ 2,599.		
Engineered Stone Vanity Top – 49" W x 22" D x 3/4" thick – Right Sink (Sink Dimensions = 17-1/4" W x 13" L x 5" D)				
	Lava Black (Tebas Black)	TF49URO90-1	21" D Cartesian & Profiles vanity arrangement (12-36)	\$ 2,029.
		TF49URO90-8		\$ 2,029.
	Stone Gray (Expo Grey)	TF49URO91-1		\$ 2,029.
		TF49URO91-8		\$ 2,029.
	Quartz White (White Storm)	TF49URO92-1		\$ 2,149.
		TF49URO92-8		\$ 2,149.
	White Zeus Extreme	TF49URO93-1		\$ 2,599.
	TF49URO93-8	\$ 2,599.		
Lyra	TF49URO94-1	\$ 2,599.		
	TF49URO94-8	\$ 2,599.		
Engineered Stone Vanity Top – 49" W x 22" D x 3/4" thick – Double Sink (Sink Dimensions = 17-1/4" W x 13" L x 5" D)				
	Lava Black (Tebas Black)	TF49UDO90-1D1	21" D Cartesian & Profiles vanity arrangement (24-24)	\$ 2,599.
		TF49UDO90-8D1		\$ 2,599.
	Stone Gray (Expo Grey)	TF49UDO91-1D1		\$ 2,599.
		TF49UDO91-8D1		\$ 2,599.
	Quartz White (White Storm)	TF49UDO92-1D1		\$ 2,729.
		TF49UDO92-8D1		\$ 2,729.
	White Zeus Extreme	TF49UDO93-1D1		\$ 3,179.
	TF49UDO93-8D1	\$ 3,179.		
Lyra	TF49UDO94-1D1	\$ 3,179.		
	TF49UDO94-8D1	\$ 3,179.		
Engineered Stone Vanity Top – 49" W x 19" D x 3/4" thick – No Sink				
	Lava Black (Tebas Black)	TE49G90	18" D Cartesian & Profiles vanity arrangement (24-24) or (12-36) or (36-12) or (12-24-12)	\$ 1,699.
	Stone Gray (Expo Grey)	TE49G91		\$ 1,699.
	Quartz White (White Storm)	TE49G92		\$ 1,829.
	White Zeus Extreme	TE49G93		\$ 2,279.
	Lyra	TE49G94		\$ 2,279.
Engineered Stone Vanity Top – 49" W x 22" D x 3/4" thick – No Sink				
	Lava Black (Tebas Black)	TF49G90	48" W V14 or 21" D Cartesian & Profiles vanity arrangement (24-24) or (12-36) or (36-12) or (12-24-12)	\$ 1,699.
	Stone Gray (Expo Grey)	TF49G91		\$ 1,699.
	Quartz White (White Storm)	TF49G92		\$ 1,829.
	White Zeus Extreme	TF49G93		\$ 2,279.
	Lyra	TF49G94		\$ 2,279.

* -1 & -1D1 = Single-Hole Drilling
 -8 & -8D1 = 8" Widespread (3-Hole Centered on Sink Location)

Vanity Tops

61" W Vanity Tops

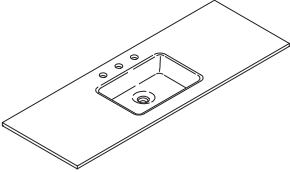
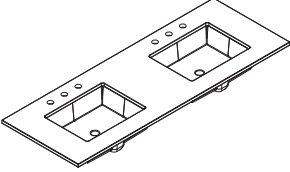
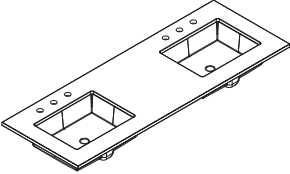
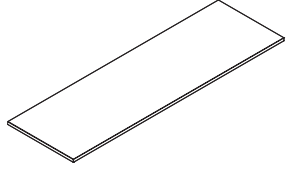
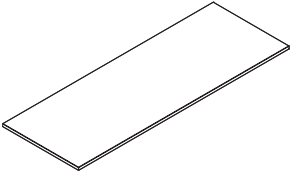
	Color	Model*	For Use With Vanities	Price
Engineered Stone Vanity Top – 61" W x 22" D x 3/4" thick – Center Sink (Sink Dimensions = 17-1/4" W x 13" L x 5" D)				
	Lava Black (Tebas Black)	TF61UCO90-1	60" W V14® (three-drawer) or 21" D Cartesian® & Profiles® vanity arrangement (12-36-12)	\$ 2,279.
		TF61UCO90-8		\$ 2,279.
	Stone Gray (Expo Grey)	TF61UCO91-1		\$ 2,279.
		TF61UCO91-8		\$ 2,279.
	Quartz White (White Storm)	TF61UCO92-1		\$ 2,379.
		TF61UCO92-8		\$ 2,379.
	White Zeus Extreme	TF61UCO93-1		\$ 2,829.
	TF61UCO93-8	\$ 2,829.		
	Lyra	TF61UCO94-1	\$ 2,829.	
		TF61UCO94-8	\$ 2,829.	
Engineered Stone Vanity Top – 61" W x 22" D x 3/4" thick – Double Sink (Sink Dimensions = 17-1/4" W x 13" L x 5" D)				
	Lava Black (Tebas Black)	TF61UDO90-1D2	21" D Cartesian & Profiles vanity arrangement (30-30)	\$ 2,829.
		TF61UDO90-8D2		\$ 2,829.
	Stone Gray (Expo Grey)	TF61UDO91-1D2		\$ 2,829.
		TF61UDO91-8D2		\$ 2,829.
	Quartz White (White Storm)	TF61UDO92-1D2		\$ 2,949.
		TF61UDO92-8D2		\$ 2,949.
	White Zeus Extreme	TF61UDO93-1D2		\$ 3,399.
	TF61UDO93-8D2	\$ 3,399.		
	Lyra	TF61UDO94-1D2	\$ 3,399.	
		TF61UDO94-8D2	\$ 3,399.	
Engineered Stone Vanity Top – 61" W x 22" D x 3/4" thick – Double Sink (Sink Dimensions = 17-1/4" W x 13" L x 5" D)				
	Lava Black (Tebas Black)	TF61UDO90-1D4	21" D Cartesian & Profiles vanity arrangement (24-12-24)	\$ 2,829.
		TF61UDO90-8D4		\$ 2,829.
	Stone Gray (Expo Grey)	TF61UDO91-1D4		\$ 2,829.
		TF61UDO91-8D4		\$ 2,829.
	Quartz White (White Storm)	TF61UDO92-1D4		\$ 2,949.
		TF61UDO92-8D4		\$ 2,949.
	White Zeus Extreme	TF61UDO93-1D4		\$ 3,399.
	TF61UDO93-8D4	\$ 3,399.		
	Lyra	TF61UDO94-1D4	\$ 3,399.	
		TF61UDO94-8D4	\$ 3,399.	
Engineered Stone Vanity Top – 61" W x 19" D x 3/4" thick – No Sink				
	Lava Black (Tebas Black)	TE61G90	18" D Cartesian & Profiles vanity arrangement (30-30) or (12-36-12) or (24-12-24)	\$ 1,929.
	Stone Gray (Expo Grey)	TE61G91		\$ 1,929.
	Quartz White (White Storm)	TE61G92		\$ 2,029.
	White Zeus Extreme	TE61G93		\$ 2,499.
	Lyra	TE61G94		\$ 2,499.
Engineered Stone Vanity Top – 61" W x 22" D x 3/4" thick – No Sink				
	Lava Black (Tebas Black)	TF61G90	60" W V14 or 21" D Cartesian & Profiles vanity arrangement (30-30) or (12-36-12) or (24-12-24)	\$ 1,929.
	Stone Gray (Expo Grey)	TF61G91		\$ 1,929.
	Quartz White (White Storm)	TF61G92		\$ 2,029.
	White Zeus Extreme	TF61G93		\$ 2,499.
	Lyra	TF61G94		\$ 2,499.

* -1, -1D2 & -1D4 = Single-Hole Drilling
 -8, -8D2 & -8D4 = 8" Widespread (3-Hole Centered on Sink Location)

Vanity Tops

73" W Vanity Tops

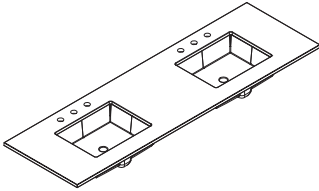
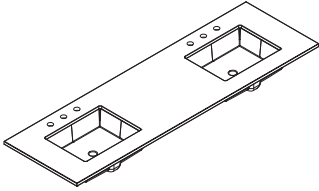
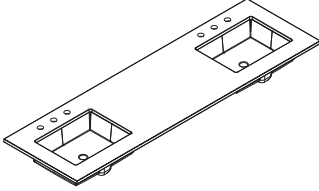
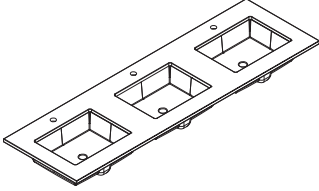
	Color	Model*	For Use With Vanities	Price
Engineered Stone Vanity Top – 73" W x 22" D x 3/4" thick – Double Sink (Sink Dimensions = 17-1/4" W x 13" L x 5" D)				
	Lava Black (Tebas Black)	TF73UDO90-1D3	21" D Cartesian® & Profiles® vanity arrangement (36-36)	\$ 3,179.
		TF73UDO90-8D3		\$ 3,179.
	Stone Gray (Expo Grey)	TF73UDO91-1D3		\$ 3,179.
		TF73UDO91-8D3		\$ 3,179.
	Quartz White (White Storm)	TF73UDO92-1D3		\$ 3,279.
		TF73UDO92-8D3		\$ 3,279.
	White Zeus Extreme	TF73UDO93-1D3		\$ 3,749.
		TF73UDO93-8D3		\$ 3,749.
	Lyra	TF73UDO94-1D3		\$ 3,749.
		TF73UDO94-8D3		\$ 3,749.
Engineered Stone Vanity Top – 73" W x 22" D x 3/4" thick – Double Sink (Sink Dimensions = 17-1/4" W x 13" L x 5" D)				
	Lava Black (Tebas Black)	TF73UDO90-1D5	21" D Cartesian & Profiles vanity arrangement (30-12-30)	\$ 3,179.
		TF73UDO90-8D5		\$ 3,179.
	Stone Gray (Expo Grey)	TF73UDO91-1D5		\$ 3,179.
		TF73UDO91-8D5		\$ 3,179.
	Quartz White (White Storm)	TF73UDO92-1D5		\$ 3,279.
		TF73UDO92-8D5		\$ 3,279.
	White Zeus Extreme	TF73UDO93-1D5		\$ 3,749.
		TF73UDO93-8D5		\$ 3,749.
	Lyra	TF73UDO94-1D5		\$ 3,749.
		TF73UDO94-8D5		\$ 3,749.
Engineered Stone Vanity Top – 73" W x 22" D x 3/4" thick – Double Sink (Sink Dimensions = 17-1/4" W x 13" L x 5" D)				
	Lava Black (Tebas Black)	TF73UDO90-1D6	21" D Cartesian & Profiles vanity arrangement (24-24-24)	\$ 3,179.
		TF73UDO90-8D6		\$ 3,179.
	Stone Gray (Expo Grey)	TF73UDO91-1D6		\$ 3,179.
		TF73UDO91-8D6		\$ 3,179.
	Quartz White (White Storm)	TF73UDO92-1D6		\$ 3,279.
		TF73UDO92-8D6		\$ 3,279.
	White Zeus Extreme	TF73UDO93-1D6		\$ 3,749.
		TF73UDO93-8D6		\$ 3,749.
	Lyra	TF73UDO94-1D6		\$ 3,749.
		TF73UDO94-8D6		\$ 3,749.
Engineered Stone Vanity Top – 73" W x 22" D x 3/4" thick – Triple Sink (Sink Dimensions = 17-1/4" W x 13" L x 5" D)				
	Lava Black (Tebas Black)	TF73UTO90-1T1	21" D Cartesian & Profiles vanity arrangement (24-24-24)	\$ 3,749.
		TF73UTO90-8T1		\$ 3,749.
	Stone Gray (Expo Grey)	TF73UTO91-1T1		\$ 3,749.
		TF73UTO91-8T1		\$ 3,749.
	Quartz White (White Storm)	TF73UTO92-1T1		\$ 3,849.
		TF73UTO92-8T1		\$ 3,849.
	White Zeus Extreme	TF73UTO93-1T1		\$ 4,329.
		TF73UTO93-8T1		\$ 4,329.
	Lyra	TF73UTO94-1T1		\$ 4,329.
		TF73UTO94-8T1		\$ 4,329.

* -1D3, -1D5, -1D6 & -1T1 = Single-Hole Drilling
 -8D3, -8D5, -8D6 & -8T1 = 8" Widespread (3-Hole Centered on Sink Location)

73" W Vanity Tops continued on next page.

Vanity Tops

73" W Vanity Tops (Continued)

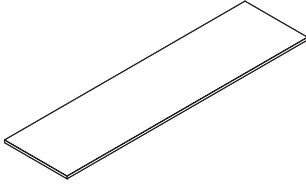
	Color	Model	For Use With Vanities	Price
Engineered Stone Vanity Top – 73" W x 19" D x 3/4" thick – No Sink				
	Lava Black (Tebas Black)	TE73G90	18" D Cartesian® & Profiles® vanity arrangement (36-36) or (24-24-24) or (30-12-30)	\$ 2,279.
	Stone Gray (Expo Grey)	TE73G91		\$ 2,279.
	Quartz White (White Storm)	TE73G92		\$ 2,379.
	White Zeus Extreme	TE73G93		\$ 2,829.
	Lyra	TE73G94		\$ 2,829.

Engineered Stone Vanity Top – 73" W x 22" D x 3/4" thick – No Sink

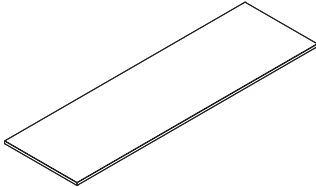
	Lava Black (Tebas Black)	TF73G90	21" D Cartesian & Profiles vanity arrangement (36-36) or (24-24-24) or (30-12-30)	\$ 2,279.
	Stone Gray (Expo Grey)	TF73G91		\$ 2,279.
	Quartz White (White Storm)	TF73G92		\$ 2,379.
	White Zeus Extreme	TF73G93		\$ 2,829.
	Lyra	TF73G94		\$ 2,829.

Undercounter Sink

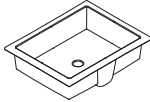
	Color	Model	For Use With Vanities	Price
17-1/4" W x 13" L x 5" D Undercounter Sink (Only)				
	White	LAV1UM-101	For custom countertop	\$ 449.

Note: Sink included with vanity top order (not applicable for tops with no sink). Sink sold separately for those who want a custom top with a sink that will fit.

Cartesian® & Profiles® Vanities Undermount Bowl Space Availability

7-1/2" (H1) TIP OUT - MAXIMUM DIMENSIONS			
	Width (W)	Depth (D)	Height (H)
VM or VP24H1D18T	22-1/2"	13-1/2"	7-1/2"
VM or VP30H1D18T	28-1/2"	13-1/2"	7-1/2"
VM or VP36H1D18T	34-1/2"	13-1/2"	7-1/2"
VM or VP24H1D21T	22-1/2"	16-1/2"	7-1/2"
VM or VP30H1D21T	28-1/2"	16-1/2"	7-1/2"
VM or VP36H1D21T	34-1/2"	16-1/2"	7-1/2"

15" (H2) PLUMBING - MAXIMUM DIMENSIONS			
	Width (W)	Depth (D)	Height (H)
VM or VP24H2D18P	22-1/2"	15-1/2"	7-1/2"
VM or VP30H2D18P	28-1/2"	15-1/2"	7-1/2"
VM or VP36H2D18P	34-1/2"	15-1/2"	7-1/2"
VM or VP24H2D21P	22-1/2"	18-1/2"	7-1/2"
VM or VP30H2D21P	28-1/2"	18-1/2"	7-1/2"
VM or VP36H2D21P	34-1/2"	18-1/2"	7-1/2"

Top Down View of Vanity Top

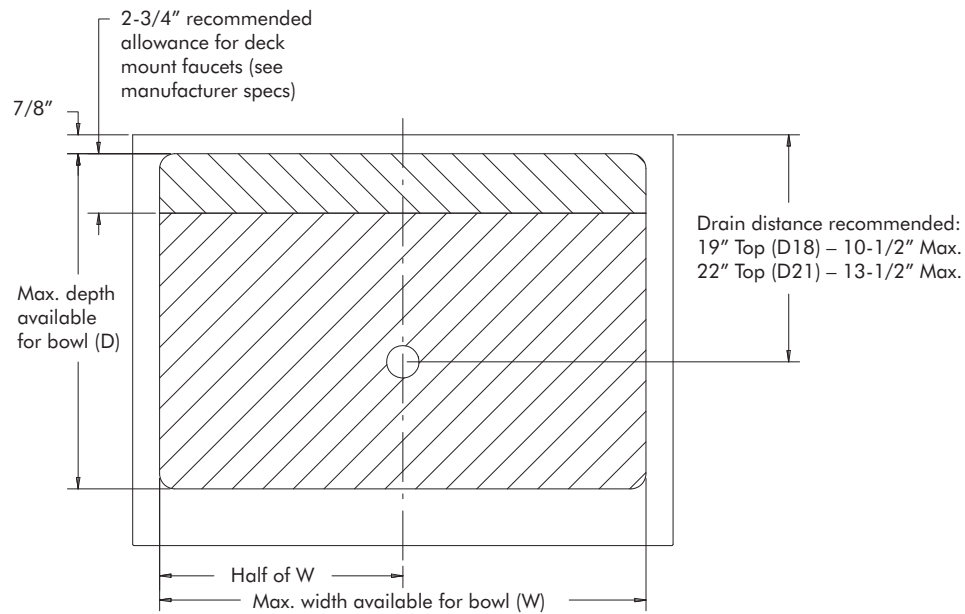

Front View of 15" (H2) Plumbing Vanity

Front View of 7-1/2" (H1) Tip Out Vanity

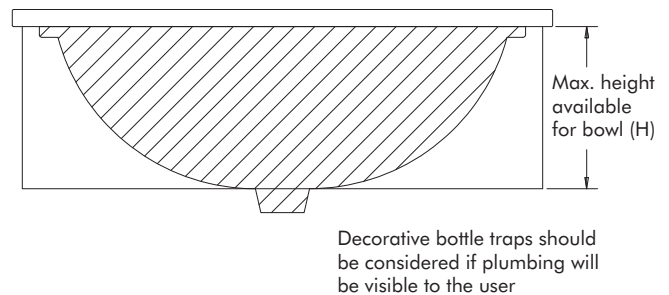
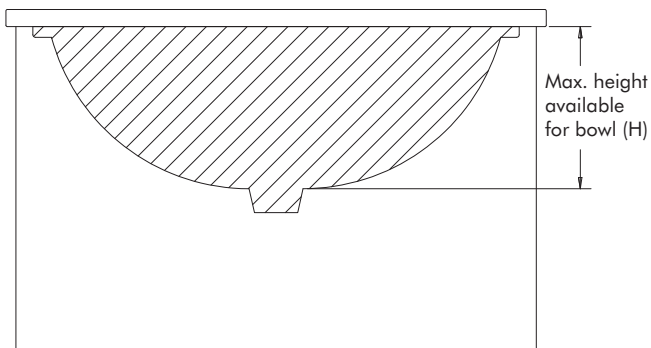

For more guidance on our modular solutions, visit robern.com/modularity.



Vanity Accessories – Table of Contents

Slim Drawer Inserts	272
Plumbing Drawer Inserts	272
Full Storage Drawer Inserts	272
Electric Accessory	273
Undercounter Sink	273
Accessory Night Lights	273
Hair Styling Organizer	273
Toilet Paper Holder	273
Accessory Glass Bins	273
Vanity Ganging Kits	274
Vanity Alcove Finishing Kits	274
Vanity Stacking Kits	274
Vanity Side Kits	275

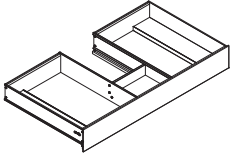
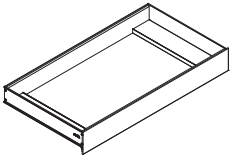
Vanity Accessories

	Model	Drawer Size	For Use With Vanities	Price
Slim Drawer Inserts				
	Plumbing Drawer Inserts			
	VADRAWER24P	22-3/16" x 3-3/4" x 15-3/8"	Profiles _® 24" W x 15" H Curated Cartesian _® 24" W x 15" H Cartesian 24" W x 15" H	\$ 649.
	VADRAWER30P	28-3/16" x 3-3/4" x 15-3/8"	Profiles 30" W x 15" H Curated Cartesian 30" W x 15" H Cartesian 30" W x 15" H	\$ 749.
	VADRAWER36P	34-3/16" x 3-3/4" x 15-3/8"	Profiles 36" W x 15" H Curated Cartesian 36" W x 15" H Cartesian 36" W x 15" H	\$ 829.
	VFDRAWER24P	22-3/16" x 3-3/4" x 15-3/8"	V14 _® 24" W V14 36" W (24" plumbing drawer) V14 48" W (24" plumbing drawer)	\$ 649.
	VFDRAWER30P	28-3/16" x 3-3/4" x 15-3/8"	V14 30" W	\$ 779.
VFDRAWER36P	34-3/16" x 3-3/4" x 15-3/8"	V14 36" W V14 60" W (36" plumbing drawer)	\$ 849.	
<p>Notes: Not for use with plumbing drawer undercounter sink installations or with Robern's stone vanity tops. Can be used in above-counter vessel installations. Profiles, Curated Cartesian & Cartesian Plumbing Drawer Inserts include five glass bins.</p>				
	Full Storage Drawer Inserts			
	VADRAWER12X	10-3/16" x 3-3/4" x 15-3/8"	Profiles 12" W x 15" H Cartesian 12" W x 15" H	\$ 529.
	VADRAWER24X	22-3/16" x 3-3/4" x 15-3/8"	Profiles 24" W x 15" H Curated Cartesian 24" W x 15" H Cartesian 24" W x 15" H	\$ 649.
	VADRAWER30X	28-3/16" x 3-3/4" x 15-3/8"	Profiles 30" W x 15" H Curated Cartesian 30" W x 15" H Cartesian 30" W x 15" H	\$ 749.
	VADRAWER36X	34-3/16" x 3-3/4" x 15-3/8"	Profiles 36" W x 15" H Curated Cartesian 36" W x 15" H Cartesian 36" W x 15" H	\$ 829.
	VFDRAWER12X	10-3/16" x 3-3/4" x 15-3/8"	V14 12" W V14 36" W (12" side drawer) V14 48" W (12" side drawer) V14 60" W (12" side drawer)	\$ 529.
	VFDRAWER24X	22-3/16" x 3-3/4" x 15-3/8"	V14 24" W	\$ 649.
	VFDRAWER30X	28-3/16" x 3-3/4" x 15-3/8"	V14 30" W	\$ 779.
	VFDRAWER36X	34-3/16" x 3-3/4" x 15-3/8"	V14 36" W	\$ 849.
	<p>Notes: Not for use with plumbing drawer undercounter sink installations or with Robern's stone vanity tops. Can be used with dry top installations. Profiles, Curated Cartesian & Cartesian Full Drawer Inserts include four glass bins.</p>			

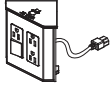
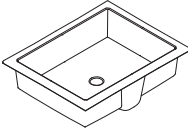
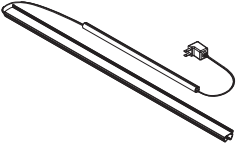
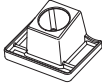
Vanity Accessories

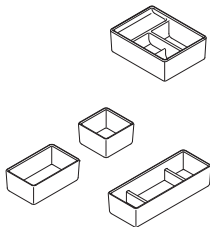
	Model	Dimensions/Description	For Use With Vanities	Price
Electric Accessory				
	VAELECTRIC18	5-1/2" x 5" x 3-1/2"	Profiles® 15" H x 18" D Cartesian® 15" H x 18" D	\$ 479.
	VAELECTRIC21	5-1/2" x 5" x 3-1/2"	Profiles 15" H x 21" D Curated Cartesian 15" H x 21" D Cartesian 15" H x 21" D	\$ 479.
	In-drawer accessory, three plugs and a switch. 120V, 1500W rated. ETL listed.			
	VFELECTRIC	5-1/2" x 5" x 3-1/2"	V14®	\$ 479.
In-drawer accessory, three plugs and a switch. 120V, 1500W rated. ETL listed.				
White Undercounter Sink				
	LAV1UM-101	17-1/4" W x 13" L x 5" D Undercounter Sink Includes mounting brackets and silicone.	For custom countertop	\$ 449.
Accessory Night Lights				
	CLEDS12	12" W Vanities in 5000K	Curated Cartesian Cartesian V14	\$ 299.
	CLEDS24	24" W Vanities in 5000K		\$ 349.
	CLEDS30	30" W Vanities in 5000K		\$ 399.
	CLEDS36	36" W Vanities in 5000K		\$ 479.
	SLEDS12	12" W Vanities in 2700K/4000K	Profiles Curated Cartesian Cartesian	\$ 299.
	SLEDS24	24" W Vanities in 2700K/4000K		\$ 349.
	SLEDS30	30" W Vanities: in 2700K/4000K		\$ 399.
	SLEDS36	36" W Vanities: in 2700K/4000K		\$ 479.
Hair Styling Organizer				
	VAHAIRORG	8-1/4" x 4-1/2" x 6-7/8"	Profiles 15" H (except 24" plumbing drawer) Curated Cartesian 15" H (except 24" plumbing drawer) Cartesian 15" H (except 24" plumbing drawer) V14 (except 24" plumbing drawer)	\$ 249.
Recommend combining Hair Styling Organizer with Electric Accessory. Hair Styling Organizer cannot be used in combination with Slim Drawer Inserts.				
Toilet Paper Holder				
	VATP	5-1/8" x 3-1/4" x 1"	V14 (except 12" W)	\$ 99.
Can be installed on either side of vanity.				
Accessory Glass Bins				
	GLASSBIN6.38	4-7/8" W x 6-3/8" L x 2-1/8" D Divided Storage	All Vanities	\$ 49.
	GLASSBIN3.25	3-1/4" W x 3-1/4" L x 2-1/8" D Small	All Vanities	\$ 49.
	GLASSBIN5.25	3-1/4" W x 5-1/4" L x 2-1/8" D Medium	All Vanities	\$ 49.
	GLASSBIN8.5	3-1/4" W x 8-1/2" L x 2-1/8" D Large	All Vanities	\$ 49.

 **Note:** Models in **bold** indicate Quick Ship product.

Vanity Accessories

Description	Model	Price
Profiles®/Cartesian® Vanity Ganging Kits		
Hardware required when combining two or more vanities		
	Ganging Kit, 7-1/2" H	VMGKITH1 \$ 99.
	Ganging Kit, 15" H	VMGKITH2 \$ 99.
	Ganging Kit, 22-1/2" H	VMGKITH3 \$ 229.
	Ganging Kit, 30" H	VMGKITH4 \$ 229.
<p>Profiles ganging information can be found on pages 202. Cartesian ganging information can be found on pages 238 – 240. Components needed for stacking are included with each Profiles and Cartesian vanity.</p>		

V14® Vanity Ganging Kits		
Hardware required when combining two or more vanities		
	Ganging Kit	VFGKIT \$ 99.
	V14 ganging information can be found on pages 234 and 235.	

Profiles/Cartesian Vanity Alcove Finishing Kits		
Hardware required for corner or alcove installations		
	Alcove Finishing Kit, 7-1/2" H	VMAKITH1 \$ 99.
	Alcove Finishing Kit, 15" H	VMAKITH2 \$ 99.
	Alcove Finishing Kit, 22-1/2" H	VMAKITH3 \$ 229.
	Alcove Finishing Kit, 30" H	VMAKITH4 \$ 229.
Note: One kit required per side of vanity.		

V14 Vanity Stacking Kits		
Hardware required for stacking two or more wall-hung vanities		
	Stacking Kit	VFSTACK \$ 99.
	Legs and hardware for stacking two or more wall-hung vanities	
	Legs (2) and hardware	VFSTACKA \$ 299.
	Legs (4) and hardware	VFSTACKL \$ 179.

Note: Models in **bold** indicate Quick Ship product.

Accessories

Vanity Accessories

Profiles®/Cartesian® Vanity Side Kits

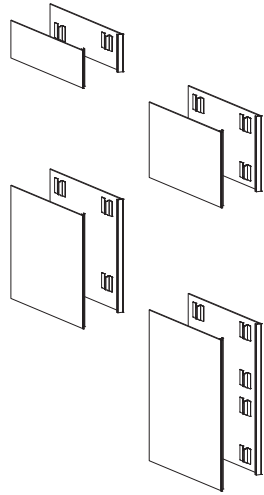

Description	Model	Essentials Palette	Classic Palette	Inspire Palette
Includes glass panel(s) & hardware				
Single, 7/8" x 7-1/2" H, 18" D	VM1SKH1D18-__	\$ 229.	\$ 299.	\$ 349.
Single, 7/8" x 7-1/2" H, 21" D	VM1SKH1D21-__	\$ 229.	\$ 299.	\$ 349.
Pair, 7/8" x 7-1/2" H, 18" D	VM2SKH1D18-__	\$ 349.	\$ 479.	\$ 579.
Pair, 7/8" x 7-1/2" H, 21" D	VM2SKH1D21-__	\$ 349.	\$ 479.	\$ 579.
Single, 7/8" x 15" H, 18" D	VM1SKH2D18-__	\$ 299.	\$ 349.	\$ 429.
Single, 7/8" x 15" H, 21" D	VM1SKH2D21-__	\$ 299.	\$ 349.	\$ 429.
Pair, 7/8" x 15" H, 18" D	VM2SKH2D18-__	\$ 429.	\$ 529.	\$ 649.
Pair, 7/8" x 15" H, 21" D	VM2SKH2D21-__	\$ 429.	\$ 529.	\$ 649.
Single, 7/8" x 22-1/2" H, 18" D	VM1SKH3D18-__	\$ 349.	\$ 429.	\$ 479.
Single, 7/8" x 22-1/2" H, 21" D	VM1SKH3D21-__	\$ 349.	\$ 429.	\$ 479.
Pair, 7/8" x 22-1/2" H, 18" D	VM2SKH3D18-__	\$ 579.	\$ 699.	\$ 829.
Pair, 7/8" x 22-1/2" H, 21" D	VM2SKH3D21-__	\$ 579.	\$ 699.	\$ 829.
Single, 7/8" x 30" H, 18" D	VM1SKH4D18-__	\$ 429.	\$ 479.	\$ 529.
Single, 7/8" x 30" H, 21" D	VM1SKH4D21-__	\$ 429.	\$ 479.	\$ 529.
Pair, 7/8" x 30" H, 18" D	VM2SKH4D18-__	\$ 699.	\$ 829.	\$ 929.
Pair, 7/8" x 30" H, 21" D	VM2SKH4D21-__	\$ 699.	\$ 829.	\$ 929.

Note: You must choose one side kit for every exposed side. Side kits sold separately to allow for customization.

Profiles/Cartesian Side Kit Color Options

Fill in __ designator to Model listed above with desired color. Example: VM2SKH4D21-19.

Essentials Palette

- 10 Mirror
- 11 Tinted Gray Mirror
- 20 Black
- 21 White

Classic Palette

- 22 Beach
- 26 Matte White
- 27 Matte Gray
- 28 Matte Black
- 60 Reeded White (Cartesian only)
- 61 Reeded Brass (Cartesian only)

Inspire Palette

- 12 Satin Bronze
- 19 Satin White
- 23 Ocean
- 24 Smoke Screen
- 25 Silver Screen

V14® 12" W Vanity Side Kits

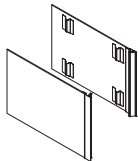

Description	Model	Essentials Palette	Classic Palette	Inspire Palette
Includes 2 glass assemblies and hardware, 7/8" x 19-1/2" x 14"	VFSK-__	\$ 579.	\$ 699.	\$ 849.

Note: Side Kits are only required as an additional item when the 12" V14 units are being used independently (i.e. not being ganged with other V14 vanities).

V14 Side Kit Color/Pattern Options

Fill in __ designator to Model listed above with desired color. Example: VFSK-11.

Essentials Palette

- 10 Mirror
- 11 Tinted Gray Mirror
- 20 Black
- 21 White

Classic Palette

- 22 Beach
- 26 Matte White
- 27 Matte Gray
- 28 Matte Black

Inspire Palette

- 12 Satin Bronze
- 19 Satin White
- 23 Ocean
- 24 Smoke Screen
- 25 Silver Screen

Cabinet Accessories – Table of Contents

Safety Lock Box	277
Cabinet Opening Kits	277
Magnifying Mirrors	278
Entice®	278
POMM	278
SOMM	278
CAMM	278
Accessory Glass Bins	278
Accessory Trays	278
Cabinet Ganging Kits	279
Cabinet Stacking Filler System	279
Cabinet Surface-Mount Kits	280 – 281
Cabinet Top & Bottom Kits	281
Profiles® Mirror Ganging Kit	281

Cabinet Accessories

Safety Lock Box

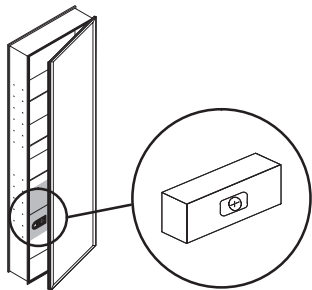

Safety Lock Box

Full compartment keyed lock box in an anodized aluminum finish

Description	Model	For Use With Cabinets	Price
16" W x 5-3/4" H x 4" D	SLB16D4	Profiles® (except 12" W), M Series (except 12" W), Main Line, PL Series	\$ 299.
16" W x 5-3/4" H x 6" D	SLB16D6		\$ 299.
16" W x 5-3/4" H x 8" D	SLB16D8		\$ 299.
20" W x 5-3/4" H x 4" D	SLB20D4	Profiles (except 12" W), M Series (except 12" W), Main Line, PL Series	\$ 299.
20" W x 5-3/4" H x 6" D	SLB20D6		\$ 299.
20" W x 5-3/4" H x 8" D	SLB20D8		\$ 299.
24" W x 5-3/4" H x 4" D	SLB24D4	Profiles (except 12" W), AiO®, Vitality®, M Series (except 12" W), Main Line, PL Series	\$ 299.
24" W x 5-3/4" H x 6" D	SLB24D6		\$ 299.
24" W x 5-3/4" H x 8" D	SLB24D8		\$ 299.

Cabinet Opening Kits

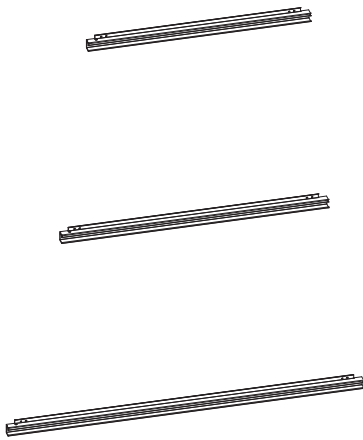

Uplift® Tech – Handle Upgrades (Anodized Aluminum included with cabinet)

24" x 1" x 1-3/4" – Chrome	UHANDLE2476	Uplift Tech, 24" W	\$ 349.
24" x 1" x 1-3/4" – Polished Nickel	UHANDLE2477	Uplift Tech, 24" W	\$ 349.
24" x 1" x 1-3/4" – Matte Gold	UHANDLE2482	Uplift Tech, 24" W	\$ 379.
24" x 1" x 1-3/4" – Matte Black	UHANDLE2483	Uplift Tech, 24" W	\$ 379.
30" x 1" x 1-3/4" – Chrome	UHANDLE3076	Uplift Tech, 30" W	\$ 399.
30" x 1" x 1-3/4" – Polished Nickel	UHANDLE3077	Uplift Tech, 30" W	\$ 399.
30" x 1" x 1-3/4" – Matte Gold	UHANDLE3082	Uplift Tech, 30" W	\$ 429.
30" x 1" x 1-3/4" – Matte Black	UHANDLE3083	Uplift Tech, 30" W	\$ 429.
36" x 1" x 1-3/4" – Chrome	UHANDLE3676	Uplift Tech, 36" W	\$ 449.
36" x 1" x 1-3/4" – Polished Nickel	UHANDLE3677	Uplift Tech, 36" W	\$ 449.
36" x 1" x 1-3/4" – Matte Gold	UHANDLE3682	Uplift Tech, 36" W	\$ 479.
36" x 1" x 1-3/4" – Matte Black	UHANDLE3683	Uplift Tech, 36" W	\$ 479.
48" x 1" x 1-3/4" – Chrome	UHANDLE4876	Uplift Tech, 48" W	\$ 499.
48" x 1" x 1-3/4" – Polished Nickel	UHANDLE4877	Uplift Tech, 48" W	\$ 499.
48" x 1" x 1-3/4" – Matte Gold	UHANDLE4882	Uplift Tech, 48" W	\$ 529.
48" x 1" x 1-3/4" – Matte Black	UHANDLE4883	Uplift Tech, 48" W	\$ 529.

Handle Options

Chrome Handle, 3/4" x 2-9/16" x 2"	MHANDLEKIT	AiO, M Series, PL Series	\$ 179.
Push-to-Open Mechanism, 3/4" x 5/8" x 3-3/8"	MPUSHKIT	Profiles, AiO, M Series, Main Line, PL Series	\$ 99.

Handle options are required when ganging 70" full length cabinets; optional for single cabinets.

Note: Models in **bold** indicate Quick Ship product.

Accessories

Cabinet Accessories

	Description	Model	For Use With Cabinets	Price	
Magnifying Mirrors					
	Entice® Magnification Mirror Entice magnification mirror. 7-3/16" x 5-3/16" x 1-3/4"	ENTICE	AiO [®] and M Series	\$ 449.	
	Entice magnification mirror with inductive charging dock. 7-3/16" x 5-3/16" x 1-3/4"	ENTICEDOCK	AiO and M Series	\$ 499.	
	Note: Entice does not mount to an M Series Decorative cabinet.				
	Pull-Out Magnifying Mirror Magnifies at 3X and retracts neatly into cabinet. 8" x 5-1/8" x 2-1/2"	POMM	All cabinets except Uplift [®] Tech, AiO 30" & 36" W or R ³ _® Series	\$ 249.	
	Silver Swing-Out Magnifying Mirror 6.88" diameter x 2X magnification. 7" x 7" x 1/4"	SOMM	All cabinets except Uplift Tech, AiO 30" & 36" W or R ³ Series	\$ 99.	
SOMM Magnifying Mirror should be installed on the door, in between shelves.					
Compact Adjustable Magnification Mirror 5X magnification. 3-1/2" x 3-1/2" x 3/4"	CAMM	AiO and M Series	\$ 49.		
Accessory Glass Bins					
	Accessory Glass Bins Small, 3-1/4" W x 3-1/4" L x 2-1/8" D	GLASSBIN3.25	All cabinets	\$ 49.	
	Medium, 3-1/4" W x 5-1/4" L x 2-1/8" D	GLASSBIN5.25	All cabinets	\$ 49.	
	Large, 3-1/4" W x 8-1/2" L x 2-1/8" D	GLASSBIN8.5	All cabinets	\$ 49.	
Accessory Trays					
	Accessory Trays Razor/Phone Holder, 2-1/2" x 3" x 1-1/2"	MA-TRAY2.5	Profiles [®] , AiO, M Series	\$ 29.	
	3" Accessory Tray, 3" x 4-11/16" x 1-1/2"	MA-TRAY3	Profiles, AiO, M Series	\$ 29.	
	5" Accessory Tray, 5" x 4-11/16" x 1-1/2"	MA-TRAY5	Profiles, AiO, M Series	\$ 29.	

Note: Models in **bold** indicate Quick Ship product.

Cabinet Accessories

Cabinet Ganging Kits

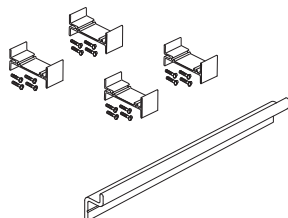

Description	Model	For Use With Cabinets	Price
Quantity 1 = Pair of Side Kits and Mounting Hardware			
Ganging Kit	MGKIT	Profiles®, AiO® and M Series 30"/40" H Cabinets, InLine Light	\$ 49.
Ganging Kit	MGKIT70	M Series 70" H Full Length Cabinets	\$ 99.
PL Ganging Kit	PLGKIT	PL Series Cabinets	\$ 49.
Hardware required for installing 2 or 3 cabinets side-by-side			
1.5 Series Lights Ganging Kit	1.5GKIT	M Series & PL Series Cabinets	\$ 49.
Hardware required if lights are used with multiple cabinets			
Uplift® Tech Ganging Kit	UGKIT	Uplift Tech Cabinets	\$ 179.
Required when pairing Uplift Tech cabinets			

Cabinet Stacking Filler System



Example 1

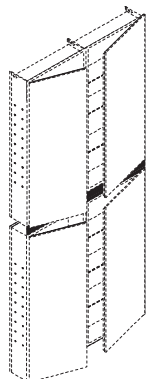

Example 2

MSF Systems are made to order.
MSF – model designation.
Dimension – total width of all components in inches.
Mounting Configuration:

Surface	MSF – *	Profiles, AiO, M Series, PL Series	\$ 99.
Recessed	MSF – R	Profiles, AiO, M Series, PL Series	\$ 99.
Semi-Recessed	MSF – D2	Profiles, AiO, M Series, PL Series	\$ 99.

* Follow MSF with width in inches of overall cabinet array.

Example 1 – MSF22.25S – MC2040 cabinet with ML1.540_ lights
Example 2 – MSF30.5R – (2) MC1630 cabinets

Notes: Stack filler is required only when vertically stacking cabinets.
MSF adds 5/8" to combined height of cabinets.
Rough opening height is 1-3/8" plus the combined R.O. heights of cabinets.
For special layouts, send sketch to Robern Customer Service.
Bold/Solid line drawing represents actual model number,
Faded/Dotted line drawings are for design reference only.

70" H Stack Filler	MSFMF **	Profiles, M Series, PL Series	\$ 99.
--------------------	----------	-------------------------------	--------

** The MSFMF is only required when ganging 30" H & 40" H surface-mounted cabinets.
When ganging 30" H & 40" H cabinets, single surface-mount side kit models are available,
please contact customer service for model numbers to complete your order.

Note: Not recommended to stack two AiO Cabinets.

Note: Models in **bold** indicate Quick Ship product.

Cabinet Accessories

Surface-Mount Kits for Profiles[®], AiO[®], M Series & Main Line Cabinets

Description	Model	Mirror	Essentials Palette	Classic Palette	Inspire Palette
For 30" H Cabinets – Quantity 1 = Pair of Side Kits and Mounting Hardware					
30" H x 4" D Surface-Mount, Polished Edge	MSMK30D4P	\$ 149.	N/A	N/A	N/A
30" H x 4" D Surface-Mount, Decorative *	MSMK30D4 __	N/A	\$ 199.	\$ 249.	\$ 349.
30" H x 6" D Surface-Mount, Polished Edge	MSMK30D6P	\$ 199.	N/A	N/A	N/A
30" H x 6" D Surface-Mount, Decorative *	MSMK30D6 __	N/A	\$ 249.	\$ 349.	\$ 399.
30" H x 6" D Semi-Recessed, Polished Edge	MSMK30D6SRP	\$ 149.	N/A	N/A	N/A
30" H x 6" D Semi-Recessed, Decorative *	MSMK30D6SR __	N/A	\$ 199.	\$ 249.	\$ 349.
30" H x 8" D Surface-Mount, Polished Edge	MSMK30D8P	\$ 249.	N/A	N/A	N/A
30" H x 8" D Surface-Mount, Decorative *	MSMK30D8 __	N/A	\$ 349.	\$ 399.	\$ 449.
30" H x 8" D Semi-Recessed, Polished Edge	MSMK30D8SRP	\$ 149.	N/A	N/A	N/A
30" H x 8" D Semi-Recessed, Decorative *	MSMK30D8SR __	N/A	\$ 199.	\$ 249.	\$ 349.
For 40" H Cabinets – Quantity 1 = Pair of Side Kits and Mounting Hardware					
40" H x 4" D Surface-Mount, Polished Edge	MSMK40D4P	\$ 249.	N/A	N/A	N/A
40" H x 4" D Surface-Mount, Decorative *	MSMK40D4 __	N/A	\$ 349.	\$ 399.	\$ 449.
40" H x 6" D Surface-Mount, Polished Edge	MSMK40D6P	\$ 349.	N/A	N/A	N/A
40" H x 6" D Surface-Mount, Decorative *	MSMK40D6 __	N/A	\$ 399.	\$ 449.	\$ 499.
40" H x 6" D Semi-Recessed, Polished Edge	MSMK40D6SRP	\$ 249.	N/A	N/A	N/A
40" H x 6" D Semi-Recessed, Decorative *	MSMK40D6SR __	N/A	\$ 349.	\$ 399.	\$ 449.
40" H x 8" D Surface-Mount, Polished Edge	MSMK40D8P	\$ 399.	N/A	N/A	N/A
40" H x 8" D Surface-Mount, Decorative *	MSMK40D8 __	N/A	\$ 449.	\$ 499.	\$ 579.
40" H x 8" D Semi-Recessed, Polished Edge	MSMK40D8SRP	\$ 249.	N/A	N/A	N/A
40" H x 8" D Semi-Recessed, Decorative *	MSMK40D8SR __	N/A	\$ 349.	\$ 399.	\$ 449.
For 48" H Cabinets – Quantity 1 = Pair of Side Kits and Mounting Hardware					
48" H x 4" D Surface-Mount, Polished Edge	MSMK48D4P	\$ 329.	N/A	N/A	N/A
For 70" H Cabinets – Quantity 1 = Pair of Side Kits and Mounting Hardware					
70" H x 4" D Surface-Mount, Polished Edge	MSMK70D4P	\$ 449.	N/A	N/A	N/A
70" H x 4" D Surface-Mount, Decorative *	MSMK70D4 __	N/A	\$ 499.	\$ 629.	\$ 729.
70" H x 6" D Surface-Mount, Polished Edge	MSMK70D6P	\$ 579.	N/A	N/A	N/A
70" H x 6" D Surface-Mount, Decorative *	MSMK70D6 __	N/A	\$ 629.	\$ 729.	\$ 849.
70" H x 6" D Semi-Recessed, Polished Edge	MSMK70D6SRP	\$ 449.	N/A	N/A	N/A
70" H x 6" D Semi-Recessed, Decorative *	MSMK70D6SR __	N/A	\$ 499.	\$ 629.	\$ 729.
70" H x 8" D Surface-Mount, Polished Edge	MSMK70D8P	\$ 679.	N/A	N/A	N/A
70" H x 8" D Surface-Mount, Decorative *	MSMK70D8 __	N/A	\$ 729.	\$ 849.	\$ 979.
70" H x 8" D Semi-Recessed, Polished Edge	MSMK70D8SRP	\$ 449.	N/A	N/A	N/A
70" H x 8" D Semi-Recessed, Decorative *	MSMK70D8SR __	N/A	\$ 499.	\$ 629.	\$ 729.

Note: Profiles is not available with 8" depth (D8) cabinets.

Surface-Mount Kit Color Options

* Fill in __ designator to Model listed above with desired color. Example: **MSMK40D620**.

Essentials Palette

- 11 Tinted Gray Mirror
- 20 Black
- 21 White

Classic Palette

- 22 Beach
- 26 Matte White
- 27 Matte Gray
- 28 Matte Black

Inspire Palette

- 12 Satin Bronze
- 19 Satin White
- 23 Ocean
- 24 Smoke Screen
- 25 Silver Screen

 **Note:** Models in **bold** indicate Quick Ship product.

Cabinet Accessories

Description	Model	For Use With Cabinets	Price
Surface-Mount Kits for Uplift® Tech, PL Series & R³® Series Cabinets			

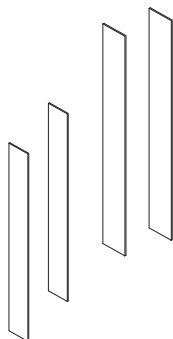

Quantity 1 = Pair of Side Kits and Mounting Hardware

27" H x 6" D Surface-Mount, Polished Edge Mirror	USMK27D6P	Uplift Tech	\$ 179.
27" H x 6" D Semi-Recessed, Polished Edge Mirror	USMK27D6SRP	Uplift Tech	\$ 179.
30" H x 4" D Surface-Mount, White	M SMK30D4W	PL Series	\$ 199.
30" H x 4" D Surface-Mount, Polished Edge Mirror	PLSMK30D4P	PL Series	\$ 149.
40" H x 4" D Surface-Mount, Polished Edge Mirror	PLSMK40D4P	PL Series	\$ 249.
20" H x 4" D Surface-Mount, Polished Edge Mirror	RSMK20D4P	R ³ Series	\$ 149.
26" H x 4" D Surface-Mount, Polished Edge Mirror	RSMK26D4P	R ³ Series	\$ 149.
36" H x 4" D Surface-Mount, Polished Edge Mirror	RSMK36D4P	R ³ Series	\$ 149.

Description	Model	For Use With Cabinets	Price
Aluminum Top & Bottom Kits for Uplift Tech Cabinets			



Required when top or bottom is visible			
Surface-Mount, 24" W x 2/25" H x 6" D	UTK24D6A	Uplift Tech	\$ 249.
Semi-Recessed, 24" W x 2/25" H x 6" D	UTK24D6ASR	Uplift Tech	\$ 249.
Surface-Mount, 30" W x 2/25" H x 6" D	UTK30D6A	Uplift Tech	\$ 249.
Semi-Recessed, 30" W x 2/25" H x 6" D	UTK30D6ASR	Uplift Tech	\$ 249.
Surface-Mount, 36" W x 2/25" H x 6" D	UTK36D6A	Uplift Tech	\$ 249.
Semi-Recessed, 36" W x 2/25" H x 6" D	UTK36D6ASR	Uplift Tech	\$ 249.
Surface-Mount, 48" W x 2/25" H x 6" D	UTK48D6A	Uplift Tech	\$ 249.
Semi-Recessed, 48" W x 2/25" H x 6" D	UTK48D6ASR	Uplift Tech	\$ 249.

Description	16" W	20" W	24" W	For Use w/Cabinets	Price
Aluminum Bottom Kits for all Cabinets except Uplift Tech or R3 Series					



Can be added to any surface-mount or semi-recessed installation to cover bottom of cabinet.					
Surface-Mount, 4" D	MBK16D4A	MBK20D4A	MBK24D4A	Profiles sm , AiO, M Series, PL Series	\$ 99.
Surface-Mount, 6" D	MBK16D6A	MBK20D6A	MBK24D6A	Profiles, M Series, Main Line	\$ 99.
Surface-Mount, 8" D	MBK16D8A	MBK20D8A	MBK24D8A	M Series	\$ 99.
Semi-Recessed, 6" D	MBK16D6ASR	MBK20D6ASR	MBK24D6ASR	Profiles, M Series, Main Line	\$ 99.
Semi-Recessed, 8" D	MBK16D8ASR	MBK20D8ASR	MBK24D8ASR	M Series	\$ 99.

Description	Model	Price
Profiles Mirror Ganging Kit		

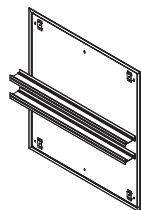

Hardware required for ganging Profiles Mirrors with Profiles Lighting and Cabinets		
24" x 30"	PMGKIT2430	\$ 399.
30" x 30"	PMGKIT3030	\$ 449.
36" x 30"	PMGKIT3630	\$ 499.
24" x 40"	PMGKIT2440	\$ 399.
30" x 40"	PMGKIT3040	\$ 449.
36" x 40"	PMGKIT3640	\$ 499.

Note: Models in **bold** indicate Quick Ship product.

Replacement Parts

Cabinets	283 – 284
Shelves	283 – 284
Miscellaneous	284
Lighting	285
Bulbs	285
Miscellaneous	285

Replacement Parts – Cabinets

Cabinet Shelves

Each shelf part contains one shelf and four shelf pins. 4-Packs contain four shelves and 16 shelf pins.

Part No.	For Use With	Price	Part No.	For Use With	Price
AiO® Cabinets			Profiles® Series Cabinets		
SHLF24D4	24" Single Shelf	\$ 99.	SHLF16D4	PC16D4	\$ 99.
SHLF24D4S3	24" 3-Pack of Shelves	\$ 149.	SHLF20D4	PC20D4	\$ 99.
SHLF8D4	30" Single Shelf for Smaller Side of Two Door Cabinet	\$ 59.	SHLF24D4	PC24D4	\$ 99.
SHLF8D4S3	30" 3-Pack of Shelves for Smaller Side of Two Door Cabinet	\$ 79.	SHLF16D6	PC16D6	\$ 99.
SHLF20D4	30" Single Shelf for Larger Side of Two Door Cabinet	\$ 99.	SHLF20D6	PC20D6	\$ 99.
SHLF20D4S3	30" 3-Pack of Shelves for Larger Side of Two Door Cabinet	\$ 149.	SHLF24D6	PC24D6	\$ 99.
SHLF10D4	36" Single Shelf for Smaller Side of Two Door Cabinet	\$ 59.	PL Series Cabinets		
SHLF10D4S3	36" 3-Pack of Shelves for Smaller Side of Two Door Cabinet	\$ 79.	SHLF16D4	PLM16	\$ 99.
SHLF24D4	36" Single Shelf for Larger Side of Two Door Cabinet	\$ 99.	SHLF20D4	PLM20	\$ 99.
SHLF24D4S3	36" 3-Pack of Shelves for Larger Side of Two Door Cabinet	\$ 149.	SHLF24D4	PLM24	\$ 99.
Uplift® Tech Cabinets			SHLFPLM30	PLM30	\$ 99.
X202-1567	7-7/16" W shelf used with 30" W cabinet (left side)	\$ 62.	SHLFPLM36	PLM36	\$ 99.
X202-1568	13-7/16" W shelf used with 36" W cabinet (left side)	\$ 114.	R³® Series Cabinets		
X202-1569	17-13/16" W shelf used with 30", 36" and 48" W cabinets (right side)	\$ 75.	X202-1136	RC16	\$ 99.
X202-1570	21-9/16" W shelf used with 24" W cabinet	\$ 80.	X202-1137	RC20	\$ 99.
X202-1573	25-7/16" W shelf used with 48" W cabinet (left side)	\$ 85.	X202-1138	RC24	\$ 99.
M Series Cabinets					
SHLF12D4	12D4	\$ 99.			
SHLF16D4	16D4	\$ 99.			
SHLF16D4S4	16D4 4-Pack	\$ 199.			
SHLF20D4	20D4	\$ 99.			
SHLF20D4S4	20D4 4-Pack	\$ 199.			
SHLF24D4	24D4	\$ 99.			
SHLF24D4S4	24D4 4-Pack	\$ 199.			
SHLF12D6	12D6	\$ 99.			
SHLF16D6	16D6	\$ 99.			
SHLF20D6	20D6	\$ 99.			
SHLF24D6	24D6	\$ 99.			
SHLF16D8	16D8	\$ 99.			
SHLF20D8	20D8	\$ 99.			
SHLF24D8	24D8	\$ 99.			

Replacement Parts – Cabinets

Miscellaneous – Cabinets

Part No.	Description	For Use With	Price
X205-1783	Magnification Mirror	AiO.	\$ 49.
XSS131-12	Shelf Clips	For all cabinets except R ³ . Series and Uplift [®] Tech	\$ 9.
X216-1058	40" Cabinet Hinge Bag (3 Hinge)	M Series, PL Series	\$ 49.
X216-1059	30" Cabinet Hinge Bag (2 Hinge)	M Series, PL Series	\$ 29.
X216-1112	Hardware Bag	M Series, PL Series	\$ 9.
XSS134-36	Gray Hole Plugs	For all cabinets except R ³ Series and Uplift Tech	\$ 9.
XSS712-2	Top Clips for Surface-Mount and Semi-Recessed Installations	For all cabinets except R ³ Series and Uplift Tech	\$ 9.
X205-2666-S	24" W Handle (Non-Electric, Electric) in Anodized Aluminum	Uplift Tech	\$ 116.
X205-2667-S	30" W Handle (Non-Electric, Electric) in Anodized Aluminum	Uplift Tech	\$ 156.
X205-2668-S	36" W Handle (Electric) in Anodized Aluminum	Uplift Tech	\$ 169.
X205-2669-S	48" W Handle (Non-Electric, Electric) in Anodized Aluminum	Uplift Tech	\$ 205.
X205-2670-S	30" W Handle (Electric, Night Light, Defogger) in Anodized Aluminum	Uplift Tech	\$ 190.
X205-2671-S	36" W Handle (Electric, Night Light, Defogger) in Anodized Aluminum	Uplift Tech	\$ 209.
X205-2672-S	48" W Handle (Electric, Night Light, Defogger) in Anodized Aluminum	Uplift Tech	\$ 260.
X216-1188	24" W Hardware Bag	Uplift Tech	\$ 48.
X216-1189	30", 36", 48" W Hardware Bag	Uplift Tech	\$ 55.
X216-1055	26" W Single Door Hardware Bag	R ³ Series	\$ 9.
X216-1056	26" W Two Door Hardware Bag	R ³ Series	\$ 12.
X216-1057	36" W Hardware Bag	R ³ Series	\$ 12.
X216-1054	20" W Hardware Bag	R ³ Series	\$ 9.
X216-1166	Hardware Bag	Vitality [®]	\$ 19.

Replacement Parts – Lighting

Bulbs

Shipping charges are added to shipment of bulbs and not combined with cabinet orders.

Fixture Model	Description	Package Qty.	Order Code	Price per Pack
Uplift® Sconce and Pendant	24 Watt, 3000K, 2G11 Base, Fluorescent	Single	X219-1145	\$ 99.
ML3.540 Reflexion® (40" H)	T5 21 Watt, 3000K Fluorescent	2 per Pack	BULBT5212	\$ 199.
ML3.530 Reflexion (30" H)	T5 14 Watt, 3000K Fluorescent	2 per Pack	BULBT5142	\$ 199.
1.5 Series (40" H)	T-8 3000K, 36" Med. Bipin, 25W Fluorescent	2 per Pack	BULBFL3602	\$ 199.
1.5 Series (30" H)	T-8 3000K, 24" Med. Bipin, 17W Fluorescent	2 per Pack	BULBFL2402	\$ 199.
16" W Eyezon®	24 Watt, 3500K, 2G11 Base, Fluorescent	Single	X219-1151	\$ 99.
20" W & 24" W Eyezon	36 Watt, 3500K, 2G11 Base, Fluorescent	Single	X219-1152	\$ 99.



Note: Models in **bold** indicate Quick Ship product.

Miscellaneous – Lighting

Fixture Model	Description	For Use With	Price
X202-1116	Shade for Sconce and Pendant	Uplift®	\$ 99.
X202-1081	Glass Shade	Main Line Sconce, Decorative Glass Sconce	\$ 19.
X219-1091	Sconce Ballast	Main Line Sconce, Decorative Glass Sconce, Uplift	\$ 99.
X219-1096	Pendant Ballast	Uplift	\$ 99.

