

# BIGMAX<sup>®</sup>

BY DRIVE PRODUCTS

## Outrigger Stabilizers



DRIVING FORWARD  
INDUSTRY FORWARD

## Outrigger Stabilizer Types

We offer a full range of multi-purpose hydraulic outrigger stabilizers.

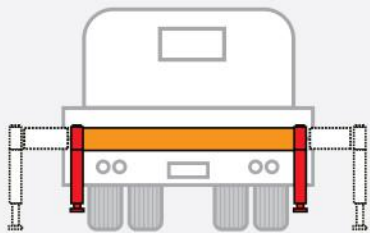
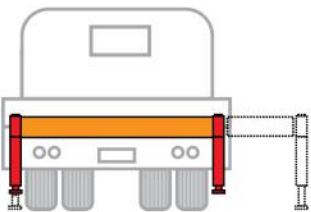
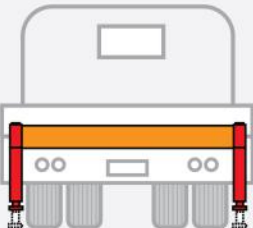
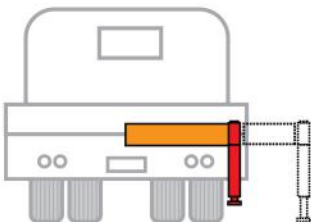
TYPE	DESCRIPTION	AVAILABLE WITH:	CRANE SIZE**	TYPICAL USES
E	 <p>Cross beam with two side extensions and two hydraulic legs.</p>	<p>Manual or hydraulic extensions.</p> <p>Adjustable, manual tilt up or fixed height legs.</p>	<p>2 -120 t/m</p> <p>14,430 to 865,920 ft/lbs</p>	Main or auxiliary stabilizers for truck mounted cranes and equipment.
B	 <p>Cross beam with one side extension.</p>	<p>Manual or hydraulic extension.</p> <p>Adjustable, manual tilt up or fixed height legs.</p>	<p>4 -31 t/m</p> <p>29,000 to 224,000 ft/lbs</p>	With side or corner mounted cranes, such as on mechanics service body trucks.
F	 <p>Cross beam with two fixed legs.</p>	<p>Adjustable, manual tilt up or fixed height legs.</p>	<p>2-31 t/m</p> <p>14,430 to 224,000 ft/lbs</p>	For centre mounted cranes or other equipment that is stable without lateral extensions.
H	 <p>Half stabilizer; short beam with one side extension and one hydraulic leg.</p>	<p>Adjustable, manual tilt up or fixed height legs.</p>	<p>2-4 t/m</p> <p>14,430 to 29,000 ft/lbs</p>	With small cranes or other equipment that is side mounted.

## Outrigger Stabilizer Types

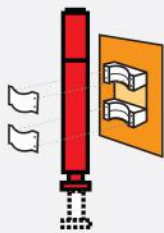
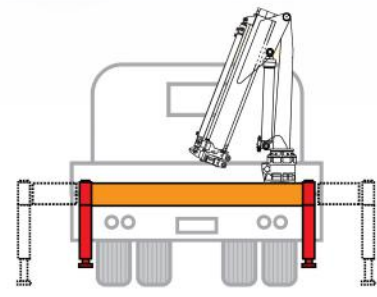
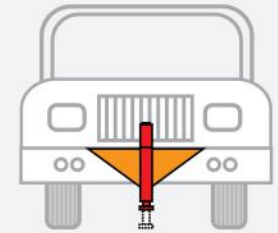
TYPE	DESCRIPTION	AVAILABLE WITH:	CRANE SIZE**	TYPICAL USES
C	 Leg only (no cross beam) with mounting plate and lock valve.	Adjustable, manual tilt up or fixed height legs.	2-120 t/m 14,430 to 865,920 ft/lbs	General purpose use such as for post drivers, trailers, ditchers and for use as a landing leg.
T	 Stabilizer assembly with integrated mounting base for BigMax TC Series cranes.	Adjustable, manual tilt up or fixed height legs.	1-4 t/m 7,200 to 29,000 ft/lbs	Enables mounting of small crane directly to truck chassis (in lieu of a deck mounted crane).
X	 Front bumper-mounted stabilizer. Leg only with mounting plate and lock valve.	Adjustable, manual tilt up or fixed height legs.	2-120 t/m 14,430 to 865,920 ft/lbs	Boom trucks or cabover trucks.

### Type E: Styles and Sizes

TYPE E OUTRIGGER STABILIZER STYLES	CRANE SIZE	APPLICATION
In-Line Beam	2 - 31 t/m	for single axle trucks
Parallel Beam	10 - 50 t/m	for intermediate sized tandem axle trucks
Parallel Beam Plus	40 - 70 t/m	with internal tubing suitable for rugged environments
Parallel Beam Under Chassis Mount	30 - 80 t/m	for special applications demanding a lower centre of gravity and compact mounting
Parallel Beam Extra Wide	Up to 120 t/m	for heavy duty tandem triple-axle trucks



# BIGMAX<sup>®</sup>

BY DRIVE PRODUCTS

We offer an array of multi-purpose hydraulic outrigger stabilizers suitable for all types of mobile equipment, including cranes up to 120 ton metres. And, we provide retail customers, fleets, dealers and OEMs with excellent prices and personal service.

## Choice

- Seven styles of outriggers suitable for light and heavy duty applications
- More than 50 models extending up to 20 feet
- Varying outrigger heights with fixed, tilt up or adjustable legs
- Manual or pilot-operated lock valves

## Economy

- Excellent pricing
- Comprehensive two year parts and labour warranty
- Lighter, high tensile steel equals more payload

## Service

- Fast delivery of outriggers from stock
- Selection and ordering assistance
- Technical support when you need it

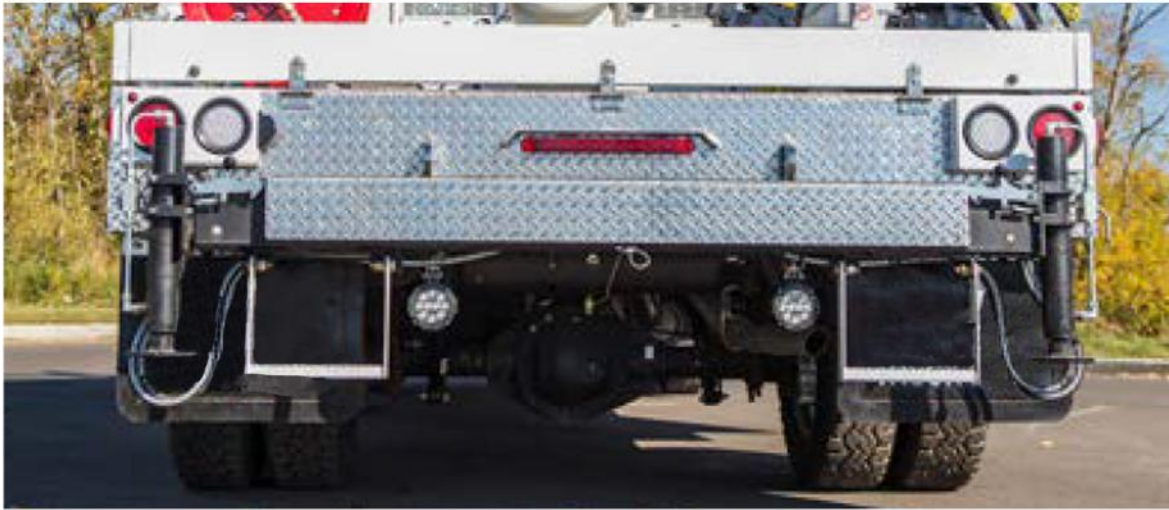

## Leg Options

Adjustable Leg

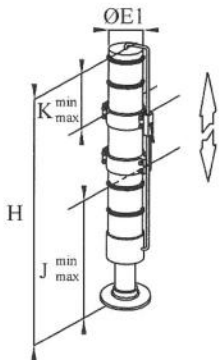

Tilt-up Leg

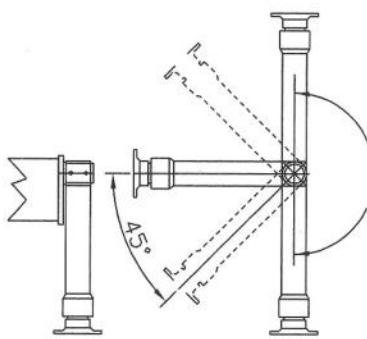

Non-adjustable Leg



SALES • SERVICE • INSTALLATION • FINANCING OPTIONS AVAILABLE

### TORONTO (HEAD OFFICE)

1665 Shawson Dr.  
Mississauga, ON, L4W 1T7  
Tel: 905.564.5800  
Toll Free: 1.800.668.6012

### EDMONTON

111 - 26230 Twp 531 A  
Acheson, AB, T7X 5A4  
Tel: 780.960.6826  
Toll Free: 1.800.661.7335

### TORONTO (EAST)

55 Nashdene Rd.  
Scarborough, ON, M1V 0C1  
Tel: 416.321.0660  
Toll Free: 1.800.269.6590

### CALGARY

4311-122nd Ave. S.E.  
Calgary, AB, T2Z 4V3  
Tel: 403.720.8033  
Toll Free: 1.800.267.0559

### HALIFAX

141A Joseph Zatzman Dr.  
Dartmouth, NS, B3B 1M7  
Tel: 902.468.8288  
Toll Free: 1.866.661.7742

### REGINA

2304 Emmet Hall Road  
Regina, SK, S4N 3M3  
Tel: 306.566.9880  
Toll Free: 1.855.345.1064

### MONTREAL

900 Montee de Liesse  
St. Laurent, PQ, H4T 1N8  
Tel: 514.856.0407  
Toll Free: 1.800.361.9291

### VANCOUVER

19150-96<sup>th</sup> Ave. - Unit 1  
Surrey, BC, V4N 3R3  
Tel: 604.888.4464  
Toll Free: 1.800.473.1717



www.driveproducts.com