

ROBIEL®

EUI Units
Unidades EUI

EUI N3 EURO 5 UNIT
UNIDAD EUI N3 EURO 5

Case NH
Iveco

UNIT CODE
0 414 703 004
0 414 703 008
0 414 703 009
0 414 703 010
0 414 703 013

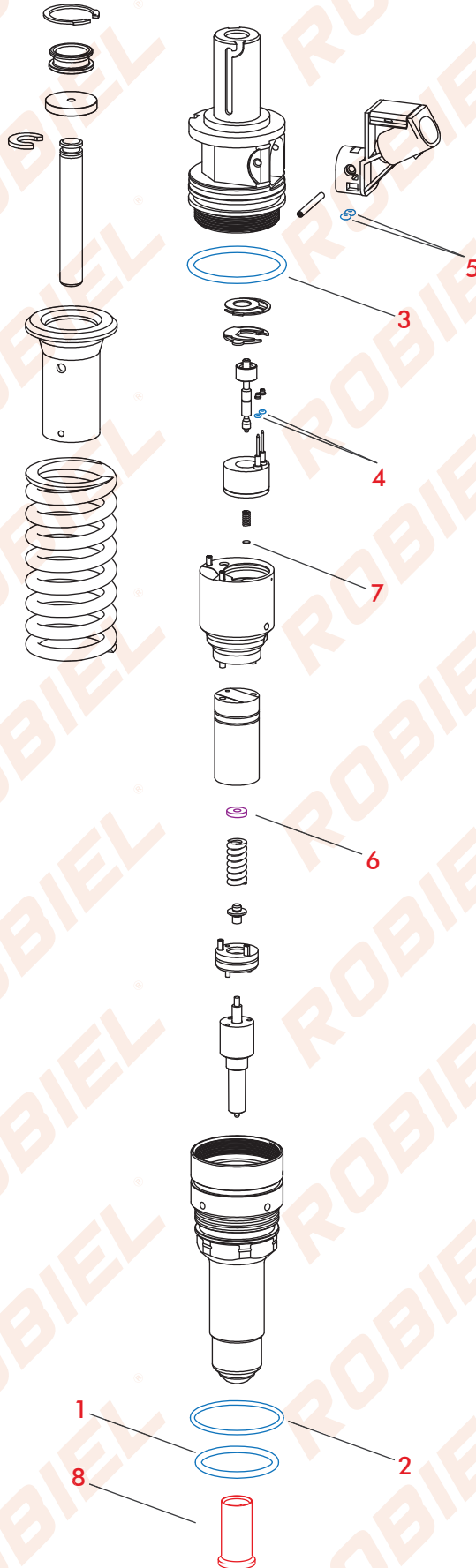

420.22.007		REPAIR RINGS SET - EXTERNAL - BOSCH IVECO/ EURO V UNIT		
REFERENCE		F 00H 4S0 001		
Nº	ROBIEL CODE	REFERENCE	DESCRIPTION	PACK
1	421.03.026	F 00H N36 044	O-ring - Anillo	01un.
2	421.03.516	F 00H 410 535	O-ring - Anillo	01un.
3	421.03.726	F 00H N37 810	O-ring - Anillo	01un.





420.22.009		REPAIR RINGS SET - IVECO/ EURO V UNIT CONNECTOR		
REFERENCE				
Nº	ROBIEL CODE	REFERENCE	DESCRIPTION	PACK
4	421.00.071	-	Lower connector ring - Anillo Conector Inferior	12un.
5	421.00.072	F 00H 410 535	Top connector ring - Anillo Conector Superior	12un.



SPARE PARTS				
Repuestos				
Nº	ROBIEL CODE	REFERENCE	DESCRIPTION	PACK
8	220.03.08	-	Protective Cap - Injectors / Units Nozzle - 7.00mm <i>Tapa Protectora p/ Tobera Inyectores / Unidades - 7.00mm</i>	01kit.



6	SHIM - EUI EURO 5 UNIT NOZZLE CALZO TOBERA UNIDAD EUI EURO 5		
	∅ Int.: 3.00 ∅ Ext.: 8.00		
ROBIEL CODE	REFERENCE	THICKNESS(mm)	
803.09.080	2 430 102 280	0.80	
803.09.085	-	0.85	
803.09.090	2 430 102 290	0.90	
803.09.095	-	0.95	
803.09.10	2 430 102 300	1.00	
803.09.105	-	1.05	
803.09.11	2 430 102 310	1.10	
803.09.115	-	1.15	
803.09.12	2 430 102 320	1.20	
803.09.125	-	1.25	
803.09.13	2 430 102 330	1.30	
803.09.135	-	1.35	
803.09.14	2 430 102 340	1.40	
803.09.145	-	1.45	
803.09.15	2 430 102 350	1.50	
803.09.155	-	1.55	
803.09.16	2 430 102 360	1.60	
803.09.165	-	1.65	
803.09.17	2 430 102 370	1.70	
803.09.175	-	1.75	
803.09.18	2 430 102 380	1.80	
803.09.185	-	1.85	
803.09.19	2 430 102 390	1.90	
12 UNITS			

7	SHIM - EUI N3 EURO 5 UNIT ARMATURE CALZO ATRAQUE EUI N3 EURO 5 UNIDAD		
	∅ Ext.: 2.80		
ROBIEL CODE	REFERENCE	THICKNESS(mm)	
800.28.030	-	0.30	
800.28.035	-	0.35	
800.28.040	-	0.40	
800.28.045	-	0.45	
800.28.050	-	0.50	
800.28.060	-	0.60	
12 UNITS			



323.01.221

Nozzle tester Adapter
Euro 5 Units
*Adaptador Prueba Tobera
Unidades Euro 5*





323.01.64

Device for Removal the
Iveco Drive
Dispositivo para Retirar el Comando Iveco



323.01.3241

Rotating Vise W /
Indexer Pin
Morsa Giratoria con Pin index



324.15.01

Injectors and Units Repair
Bracket
*Soporte para reparacion
de Inyectores y Unidades*



324.15.05

Clamp Set for Units
Clip de las Unidades







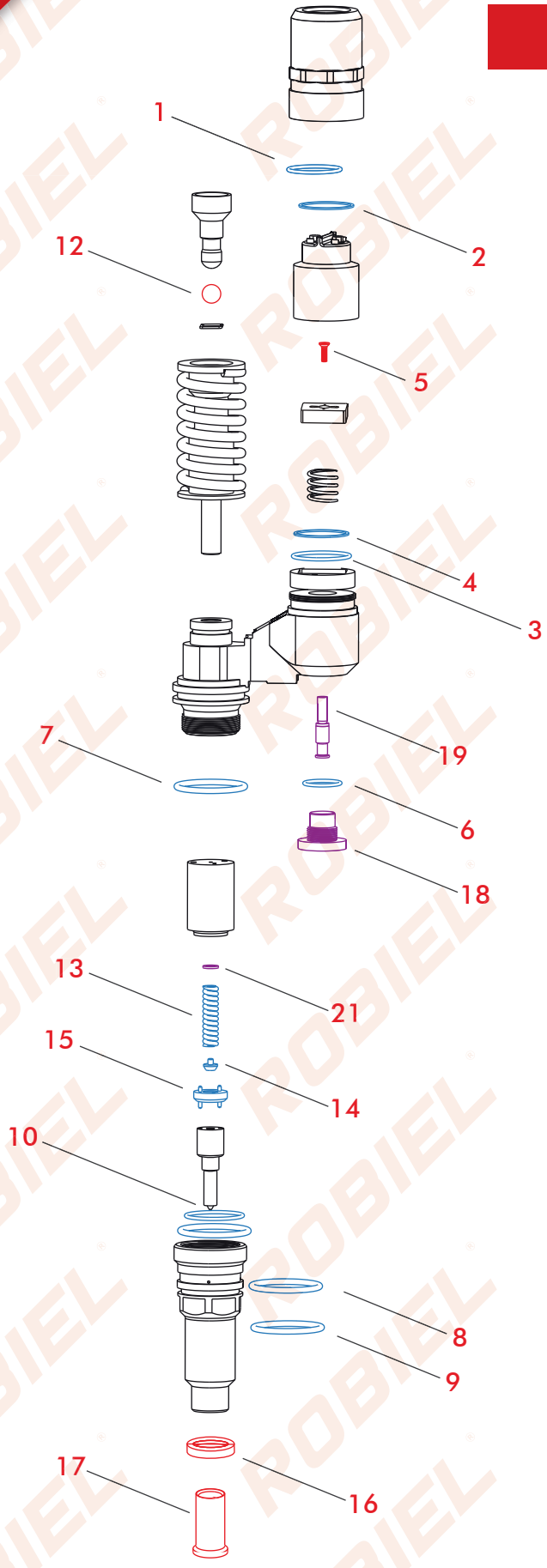

EUI | PDE UNIT
UNIDAD EUI | PDE

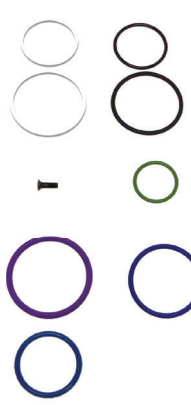

Scania
Iveco

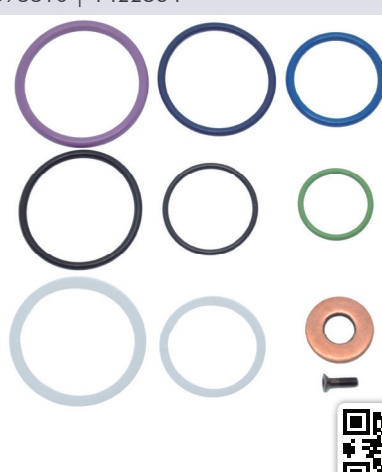

SCANIA UNITS	VOLVO UNITS	IVECO STRALIS CURSOR 13 UNITS	IVECO CAVALLINO CURSOR 8 UNITS
0 414 701 005	0 414 701 004	0 414 701 006	0 414 700 002
0 414 701 007	0 414 702 002	0 414 701 013	0 414 700 003
0 414 701 008	0 414 702 003	0 414 701 021	0 414 700 004
0 414 701 016	0 414 702 005	0 414 701 022	0 414 700 005
0 414 701 017	0 414 702 006	-	0 414 700 006
0 414 701 018	0 414 702 007	-	0 414 700 007
0 414 701 019	0 414 702 009	-	0 414 700 008
0 414 701 020	0 414 702 010	-	0 414 700 010
0 414 701 030	0 414 702 012	-	-
0 414 701 032	0 414 702 013	-	-
0 414 701 035	0 414 702 014	-	-
0 414 701 036	0 414 702 015	-	-
0 414 701 043	0 414 702 016	-	-
0 414 701 044	-	-	-
0 414 701 045	-	-	-
0 414 701 046	-	-	-

420.22.000		REPAIR PARTS - SCANIA 124 UNIT COMPLETE				
		REPARACION UNIDAD SCANIA 124 COMPLETA				
REFERENCE						
Nº	ROBIEL CODE	REFERENCE	DESCRIPTION	PACK		
1	424.02.628	F 00H N37 928 F 00H 410 850	Teflon Ring - Anillo Teflon	01un.		
2	421.02.615		O-ring - Anillo	01un.		
3	424.03.437		Teflon Ring - Anillo Teflon	01un.		
4	421.03.220		O-ring - Anillo	01un.		
5	250.21.70		Bolt - Tornillo	01un.		
6	421.01.918		O-ring - Anillo	01un.		
7	421.03.530	F 00V X99 999 142.2564	O-ring - Anillo	01un.		
8	421.03.224		O-ring - Anillo	01un.		
9	421.02.524		O-ring - Anillo	01un.		

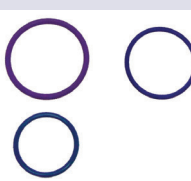
420.22.011		REPAIR PARTS - SCANIA 124 W/ INJECTION NOZZLE WASHER				
		REPARACION UNIDAD SCANIA 124 CON ARANDELA DE LA TOBERA				
REFERENCE		F 00H 410 850 F 00H N37 928 F 00V X99 999 SCANIA 1398810 1422564				
Nº	ROBIEL CODE	REFERENCE	DESCRIPTION	PACK		
1	424.02.628	-	Teflon Ring - Anillo Teflon	01un.		
2	421.02.615	-	O-ring - Anillo	01un.		
3	424.03.437	F 00H N37 326	Teflon Ring - Anillo Teflon	01un.		
4	421.03.220	F 00H N37 327	O-ring - Anillo	01un.		
5	250.21.70	F 00H N35 725	Bolt - Tornillo	01un.		
6	421.01.918	F 00H N36 540	O-ring - Anillo	01un.		
7	421.03.530	F 00H N35 728	O-ring - Anillo	01un.		
8	421.03.224	F 00H N37 149	O-ring - Anillo	01un.		
9	421.02.524	F 00H N37 150	O-ring - Anillo	01un.		
10	609.20.20B	1421424	Washer - Arandela	01un.		

420.22.564		REPAIR RINGS SET - EXTERNAL - SCANIA 124 UNIT				
		REPARACION ANILLOS EXTERNO UNIDAD SCANIA 124				
REFERENCE		F 00V X99 999 142.2564				
Nº	ROBIEL CODE	REFERENCE	DESCRIPTION	PACK		
7	421.03.530	F 00H N35 728	O-ring - Anillo	01un.		
8	421.03.224	F 00H N37 149	O-ring - Anillo	01un.		
9	421.02.524	F 00H N37 150	O-ring - Anillo	01un.		



420.22.565		REPAIR PARTS - SCANIA 124 UNIT EXTERNAL RINGS W/ INJECTION NOZZLE WASHER				
		REPARACION ANILLOS EXTERNO UNIDAD SCANIA 124 C/ ARANDELA DE LA TOBERA				
REFERENCE		F 00V X99 999 SCANIA 1422564				
Nº	ROBIEL CODE	REFERENCE	DESCRIPTION	PACK		
7	421.03.530	F 00H N35 728	O-ring - Anillo	01un.		
8	421.03.224	F 00H N37 149	O-ring - Anillo	01un.		
9	421.02.524	F 00H N37 150	O-ring - Anillo	01un.		
10	609.20.20B	1421424	Washer - Arandela	01un.		

420.37.927		REPAIR RINGS SET - INTERNAL - SCANIA UNIT NUT		
		REPARACION ANILLOS INTERNO TUERCA UNIDAD SCANIA		
REFERENCE		F 00H N37 927		
Nº	ROBIEL CODE	REFERENCE	DESCRIPTION	PACK
10	424.03.234	F 00H N37 343	Teflon Ring - Anillo Teflon	01 un.
11	421.03.117	F 00H N37 195	O-ring - Anillo	01 un.



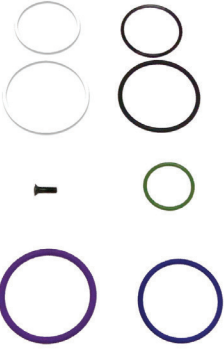

0 414 701 005 | 007 | 008 | 016 UNITS

420.22.002		REPAIR PARTS - VOLVO/BOSCH UNIT COMPLETE		
		REPARACION UNIDAD VOLVO BOSCH COMPLETA		
REFERENCE				
Nº	ROBIEL CODE	REFERENCE	DESCRIPTION	PACK
1	424.02.628	F 00H N37 928	Teflon Ring - Anillo Teflon	01 un.
2	421.02.615		O-ring - Anillo	01 un.
3	424.03.437		Teflon Ring - Anillo Teflon	01 un.
4	421.03.220		O-ring - Anillo	01 un.
5	250.21.70		Bolt - Tornillo	01 un.
6	421.01.918		O-ring - Anillo	01 un.
7	421.03.530	F 00V X99 992	O-ring - Anillo	01 un.
8	421.03.224L		O-ring - Anillo	01 un.

420.22.0041		REPAIR PARTS - IVECO STRALIS UNIT		
		REPARACION UNIDAD IVECO STRALIS		
REFERENCE				
Nº	ROBIEL CODE	REFERENCE	DESCRIPTION	PACK
1	424.02.628	F 00H N37 928	Teflon Ring - Anillo Teflon	01 un.
2	421.02.615		O-ring - Anillo	01 un.
3	424.03.437		Teflon Ring - Anillo Teflon	01 un.
4	421.03.220		O-ring - Anillo	01 un.
5	250.21.70		Bolt - Tornillo	01 un.
6	421.01.918		O-ring - Anillo	01 un.
7	421.03.530	F 00V X99 995	O-ring - Anillo	01 un.
8	421.03.426		O-ring - Anillo	01 un.
9	421.03.026		O-ring - Anillo	01 un.

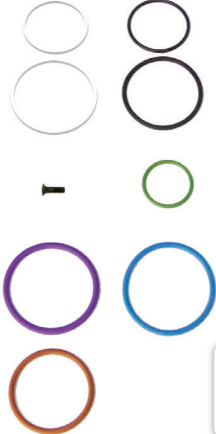

420.X9.9995		REPAIR RINGS SET - EXTERNAL - IVECO/STRALIS UNIT		
		REPARACION ANILLOS EXTERNO UNIDAD IVECO STRALIS		
REFERENCE		F 00V X99 995		
Nº	ROBIEL CODE	REFERENCE	DESCRIPTION	PACK
7	421.03.530	F 00V X99 995	O-ring - Anillo	01 un.
8	421.03.426		O-ring - Anillo	01 un.
9	421.03.026		O-ring - Anillo	01 un.





420.X99.996 REPAIR RINGS SET - EXTERNAL - IVECO/CAVALLINO UNIT <i>REPARACION ANILLOS EXTERNO UNIDAD IVECO CAVALLINO</i>				
REFERENCE		F 00V X9 996		
Nº	ROBIEL CODE	REFERENCE	DESCRIPTION	PACK
7	421.03.026	F 00H N37 036	O-ring - Anillo	01un.
8	421.02.825	F 00H N37 331	O-ring - Anillo	01un.
9	421.02.726	F 00H N36 044	O-ring - Anillo	01un.

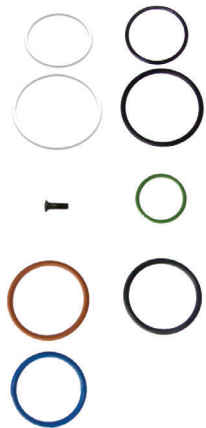



420.22.008 REPAIR PARTS - IVECO 320/ CAVALLINO UNIT COMPLETE <i>REPARACION UNIDAD IVECO 320 CAVALLINO COMPLETA</i>				
REFERENCE				
Nº	ROBIEL CODE	REFERENCE	DESCRIPTION	PACK
1	424.02.628	F 00H N37 928	Teflon Ring - Anillo Teflon	01un.
2	421.02.615		O-ring - Anillo	01un.
3	424.03.437		Teflon Ring - Anillo Teflon	01un.
4	421.03.220		O-ring - Anillo	01un.
5	250.21.70		Bolt - Tornillo	01un.
6	421.01.918		O-ring - Anillo	01un.
7	421.03.026	F 00V X99 996	O-ring - Anillo	01un.
8	421.02.825		O-ring - Anillo	01un.
9	421.02.726		O-ring - Anillo	01un.

420.37.9282 REPAIR PARTS - SCANIA/IVECO SOLENOID <i>REPARACION SOLENOIDE SCANIA / IVECO</i>				
REFERENCE		F 00H N37 928		
Nº	ROBIEL CODE	REFERENCE	DESCRIPTION	PACK
1	424.02.628	-	Teflon Ring - Anillo Teflon	01un.
2	421.02.615	-	O-ring - Anillo	01un.
3	424.03.437	F 00H N37 326	Teflon Ring - Anillo Teflon	01un.
4	421.03.220	F 00H N37 327	O-ring - Anillo	01un.
5	250.21.70	F 00H N35 725	Bolt - Tornillo	01un.
6	421.01.918	F 00H N36 540	O-ring - Anillo	01un.

409.00.001 REPAIR PARTS - SCANIA / IVECO INJECTOR NOZZLE HOLDER <i>REPARACION PORTA INYECTOR SCANIA / IVECO</i>				
REFERENCE		F 000 431 702		
Nº	ROBIEL CODE	REFERENCE	DESCRIPTION	PACK
13	225.01.42	2 434 614 040	Spring - Resorte	01un.
14	305.02.12	F 00H B20 001 2 433 124 393	Pressure Pin - Top de presion	01un.
15	D00.36.221	2 430 136 221	Intermediate Disc - Disco Intermedio	01un.



SPARE PARTS
Repuestos

Nº	ROBIEL CODE	REFERENCE	DESCRIPTION	PACK
5	250.21.70	F 00H N35 725	Bolt - Allen - Unit Amature <i>Tornillo Placa Atraque Unidades</i>	06un.
12	190.50.10	-	Ball - Ø 10.00mm <i>Bolilla Valvula Ø10.00mm</i>	06un.
13	225.01.42	2 434 614 040	Spring - MBB / Scania / Iveco Injector Nozzle <i>Resorte de la Tobera del Inyector MBB / Scania / Iveco</i>	06un.
14	305.02.12	F 00Z B20 001 2 433 124 393	Pin - Pressure - EUI / EUP Unit Nozzle <i>Top de Presion de la Tobera Unidad EUI / EUP</i>	06un.
15	D00.36.221	2 430 136 221	Intermediate Disc - MBB / Scania Eletronic <i>Disco Intermedio MBB / Scania Eletronico</i>	01un.
16	609.20.20B	1421424	Washer - Scania 420 Unit Nozzle <i>Arandela Tobera Unidad Scania 420</i>	06un.
17	220.03.08	-	Protective Cap - Injectors / Units Nozzle - 7.00mm <i>Tapa Protectora p/ Tobera Inyectores / Unidades - 7.00mm</i>	01kit.
R1	340.03.163	1379215 2 417 413 092 2 417 413 108	Return Valve - Scania 124 6.0 bar - 380 420 <i>Valvula de Retorno Scania 124 6.0 bar</i>	01un.
R2	340.03.165	-	Return Valve - Scania 124 3.5 bar - 380 420 <i>Valvula de Retorno Scania 124 3.5 bar</i>	01un.
R3	340.03.31	1368497 - 2 417 413 085	Return Valve - Iveco/Stralis 4.5 bar <i>Valvula de Retorno Iveco/Stralis 4.5 bar</i>	01un.



20 SHIM - EUI | PDE - EUP | PLD UNIT NOZZLE CALZO TOBERA UNIDAD EUI | PDE - EUP | PLD
Ø Int.: 3.00 Ø Ext.: 8.00

ROBIEL CODE	REFERENCE	THICKNESS(mm)	ROBIEL CODE	REFERENCE	THICKNESS(mm)
803.09.080	2 430 102 280	0.80	803.09.14	2 430 102 340	1.40
803.09.085	-	0.85	803.09.145	-	1.45
803.09.090	2 430 102 290	0.90	803.09.15	2 430 102 350	1.50
803.09.095	-	0.95	803.09.155	-	1.55
803.09.10	2 430 102 300	1.00	803.09.16	2 430 102 360	1.60
803.09.105	-	1.05	803.09.165	-	1.65
803.09.11	2 430 102 310	1.10	803.09.17	2 430 102 370	1.70
803.09.115	-	1.15	803.09.175	-	1.75
803.09.12	2 430 102 320	1.20	803.09.18	2 430 102 380	1.80
803.09.125	-	1.25	803.09.185	-	1.85
803.09.13	2 430 102 330	1.30	803.09.19	2 430 102 390	1.90
803.09.135	-	1.35	-	-	-

12 UNITS

18

PLUG - EUI | PDE UNIT
TAPON DE LA UNIDAD EUI | PDE



ROBIEL CODE	REFERENCE	THICKNESS(mm)
165.12.72	-	14.72
165.12.73	-	14.73
165.12.74	-	14.74
165.12.75	-	14.75
165.12.76	-	14.76
165.12.77	-	14.77
165.12.78	-	14.78
165.12.79	-	14.79
165.12.80	-	14.80

02 UNITS

19

ELEMENT - EUI | EUP UNIT VALVE
ELEMENTO VALVULA UNIDADES EUI | EUP



ROBIEL CODE	REFERENCE	THICKNESS(mm)
340.05.01	-	7.000
340.05.02	-	7.005
340.05.03	-	7.010
340.05.04	-	7.015
340.05.05	-	7.020
340.05.06	-	7.025
340.05.07	-	7.030
340.05.08	-	7.040
340.05.09	-	7.050
340.05.10	-	7.060
340.05.11	-	7.070

02 UNITS

415.00.08

BOSCH EUI / PDE PLUG KIT
KIT DE TAPONES PARA UNIDADES BOSCH EUI / PDE



06 UNITS BY MEASURE

54 UNITS

415.00.06

BOSCH EUI / PDE - EUP / PLD VALVES KIT
KIT DE VALVULAS PARA UNIDADES BOSCH EUI / PDE - EUP / PLD



06 UNITS BY MEASURE

66 UNITS



323.01.151

Nozzle tester Adapter - Scania
EUI - Volvo Penta Unit
Adaptador Prueba Tobera Unidad
Scania EUI - Volvo Pent
Rosca M31x1.00mm



323.01.22

Nozzle tester Adapter - Iveco
Cavallino Unit
Adaptador Prueba Tobera Unidad
Iveco Cavallino
Rosca M28x1.00mm

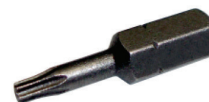

323.01.11

Tip for Torque Wrench
Unit Screw
Puntera Torx del Tornillo Unidad



324.08.38

Octagonal Wrench
Llave Octagonal
Ø38.00mm



323.02.13

Cutting Oil
Aceite corte



323.02.12

Cleaning Brush
Cepillo de Limpieza
Ø 10.00mm





323.02.08

Diamond Plate for Grinding
Placa de Diamante para Rectificar



323.02.16

Small Torque Wrench
Mini Torquimetro
1 à 8NM



323.01.98

Housing Tool - EUI/EUP Valve
Herramienta Alojamiento Valvula EUI/EUP
7.000 to 7.030



323.01.99

Polishing Tool - EUI/EUP Seat
Herramienta Acabamiento Asiento EUI/EUP
7.000 to 7.030



323.01.100

Grinding Tool - EUI/EUP Seat
Herramienta Rectificar Asiento EUI/EUP
7.000 to 7.030



323.02.18

Housing Tool - EUI/EUP Valve
Herramienta Alojamiento Valvula EUI/EUP
7.040 to 7.070



323.02.19

Polishing Tool - EUI/EUP Seat
Herramienta Acabamiento Asiento EUI/EUP
7.040 to 7.070



323.02.20

Grinding Tool - EUI/EUP Seat
Herramienta Rectificar Asiento EUI/EUP
7.040 to 7.070



323.50.041

Bosch EUI | EUP Valve
Changeover kit
Kit de Herramientas Unidades
Bosch EUI | EUP - Troca de la Valvula



323.50.111

Bosch EUI | EUP Units Tool Kit
Kit de Herramientas Unidades
Bosch EUI | EUP



323.01.64

Device for Removal the
Iveco Drive
Dispositivo para Retirar el Comando Iveco



323.01.3241

Rotating Vise W /
Indexer Pin
Morsa Giratoria con Pin index



324.15.01

Injectors and Units Repair
Bracket
Soporte para reparacion
de Inyectores y Unidades



324.15.05

Clamp Set for Units
Clip de las Unidades



CATERPILLAR C10 | C12 UNIT
UNIDAD CATERPILLAR C10 | C12

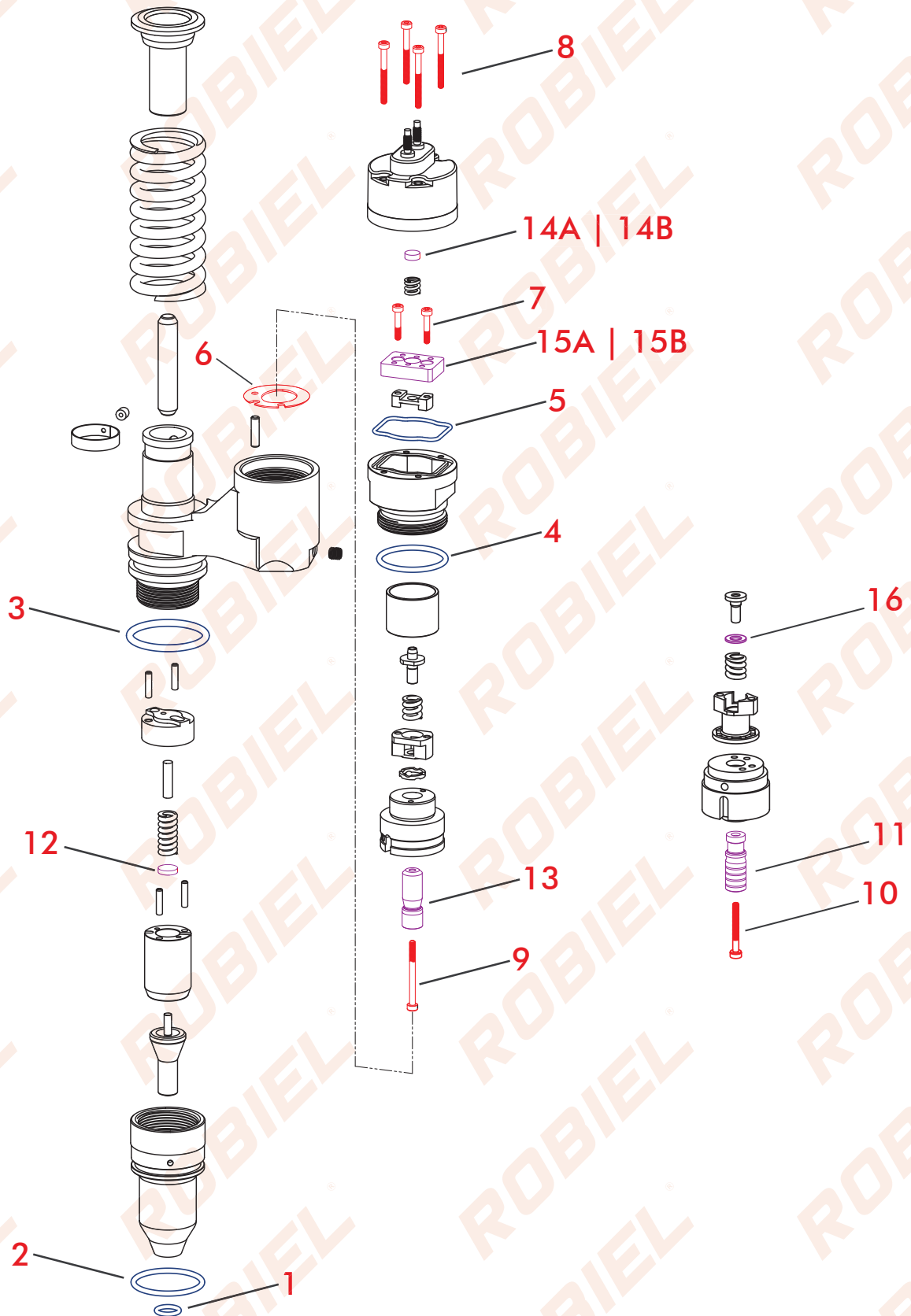



410.61.3198 REPAIR PARTS - EUI CATERPILLAR C10/C12 UNIT				
REPARACION UNIDAD EUI CATERPILLAR C10/C12				
REFERENCE		1198784.000 2153198.000 9X7317.000		
Nº	ROBIEL CODE	REFERENCE	DESCRIPTION	PACK
1	421.01.021	9X-7317	O-ring - Anillo	01un.
2	421.03.326	230-3728	O-ring - Anillo	01un.
3	421.03.535	215-3198	O-ring - Anillo	01un.
4	421.03.226	-	O-ring - Anillo	01un.
5	421.03.516	-	O-ring - Anillo	01un.





SPARE PARTS				
Repuestos				
Nº	ROBIEL CODE	REFERENCE	DESCRIPTION	PACK
6	800.00.02	-	Deflector Shim - Volvo / Caterpillar Unit Solenoid <i>Deflector Solenoide Unidad Volvo / Caterpillar</i>	06un.
7	250.22.0316	-	Bolt - Allen - Caterpillar Unit Armature <i>Tornillo Allen Atraque Unid Caterpillar</i>	08un.
8	250.21.06	-	Bolt - Allen Solenoid Volvo / Caterpillar Unit <i>Tornillo Allen Solenoide Unidad Volvo / Caterpillar</i>	04un.
9	250.22.0335	-	Bolt - Caterpillar Unit Valve <i>Tornillo de la Valvula Unidad Caterpillar</i>	12un.
10	250.21.08	-	Bolt - Allen Volvo / Caterpillar Unit Valve <i>Tornillo Allen del Barril Unidad Volvo / Caterpillar</i>	04un.





11	ELEMENT - CATERPILLAR VOLVO D12 A/C UNIT VALVE		
ELEMENTO VALVULA UNIDAD CATERPILLAR / VOLVO D12 A/C			
ROBIEL CODE	REFERENCE	THICKNESS(mm)	
340.06.0000	-	10.000	
340.06.005	-	10.005	
340.06.010	DP-V1000	10.010	
340.06.015	-	10.015	
01 UNIT			







12	SHIM - CATERPILLAR UNIT NOZZLE		
CALCO DO BICO UNIDAD CATERPILLAR			
ROBIEL CODE	REFERENCE	THICKNESS(mm)	
800.10.205	-	2.05	
800.10.210	-	2.10	
800.10.215	-	2.15	
800.10.220	-	2.20	
800.10.225	-	2.25	
800.10.230	-	2.30	
800.10.235	-	2.35	
800.10.240	-	2.40	
800.10.245	-	2.45	
800.10.250	-	2.50	
800.10.255	-	2.55	
800.10.260	-	2.60	
12 UNITS			







13	ELEMENT - CATERPILLAR DELPHI UNIT VALVE		
ELEMENTO VALVULA UNIDAD CATERPILLAR / DELPHI			
ROBIEL CODE	REFERENCE	THICKNESS(mm)	
340.07.200	-	10.200	
340.07.205	-	10.205	
340.07.210	-	10.210	
340.07.215	-	10.215	
01 UNIT			

14 A	SHIM - CATERPILLAR UNIT SOLENOID CALZO SOLENOIDE UNIDAD CATERPILLAR 		
	Ø 7.70 - INOX		
	ROBIEL CODE	REFERENCE	THICKNESS(mm)
	800.08.250	-	2.50
	800.08.255	-	2.55
	800.08.260	-	2.60
	800.08.265	-	2.65
	800.08.270	-	2.70
	800.08.275	-	2.75
	800.08.280	-	2.80
	800.08.285	-	2.85
	800.08.290	-	2.90
	800.08.295	-	2.95
	800.08.300	-	3.00
	800.08.310	-	3.10
	800.08.320	-	3.20
12 UNITS			

14 B	SHIM - CATERPILLAR UNIT SOLENOID CALZO SOLENOIDE UNIDAD CATERPILLAR 		
	Ø 7.70 - BRASS		
	ROBIEL CODE	REFERENCE	THICKNESS(mm)
	303.01.08	-	2.30
	303.01.09	-	2.35
	303.01.10	-	2.40
	303.01.11	-	2.45
	303.01.12	-	2.50
	303.01.13	-	2.55
	303.01.01	-	2.60
	303.01.02	-	2.65
	303.01.03	-	2.70
	303.01.04	-	2.75
	303.01.05	-	2.80
	303.01.06	-	2.85
	303.01.07	-	2.90
12 UNITS			

15 A	ARMATURE PLATE PLACA DE ATRAQUE 		
			
	ROBIEL CODE	REFERENCE	THICKNESS(mm)
	801.06.76	-	6.76
	801.06.78	-	6.78
	801.06.80	-	6.80
	801.06.82	-	6.82
	801.06.84	-	6.84
	801.06.86	-	6.86
06 UNITS			

15 B	ARMATURE PLATE PLACA DE ATRAQUE 		
			
	ROBIEL CODE	REFERENCE	THICKNESS(mm)
	801.08.15	-	8.15
	801.08.17	-	8.17
	801.08.19	-	8.19
	801.08.21	-	8.21
	801.08.23	-	8.23
	801.08.25	-	8.25
06 UNITS			

16

SHIM - SPRING PRESSURE
CALZO DE PRESION DEL RESORTE

Ø INT.: 5.40 Ø EXT.: 10.20



ROBIEL CODE	REFERENCE	THICKNESS(mm)
805.10.05	-	0.05
805.10.050	-	0.50
805.10.060	-	0.60
805.10.070	-	0.70
805.10.080	-	0.80
805.10.090	-	0.90
805.10.095	-	0.95
805.10.100	-	1.00
805.10.105	-	1.05
805.10.110	-	1.10
805.10.115	-	1.15
805.10.120	-	1.20
805.10.125	-	1.25
805.10.130	-	1.30

12 UNITS



324.17.342

Grinding Tool to
Deflector Seat

Herramienta Rectificar Asiento Deflector



324.18.342

Polishing Tool to
Deflector Seat
Herramienta Acabamiento
Asiento Deflector



323.02.13

Cutting Oil
Aceite corte



323.50.22

Delphi EUI / Caterpillar EUI
C10/C12/C15/C18/C32
3500 Series Tool Kit
Kit de Herramientas Unidades Delphi EUI
Caterpillar EUI C10/C12/C15/C18/C32
3500 Series



323.50.23

Delphi EUI Serie A1/A3 Volvo
D12A/D12C - Caterpillar EUI
C10/C12/C15/C18/C32
3500 Series Tool Kit
Kit de Herramientas Unidades Delphi EUI
Serie A1/A3 Volvo D12A/D12C
Caterpillar EUI C10/C12/C15/C18/C32
3500 Series



CATERPILLAR C15 | C32 UNIT
UNIDAD CATERPILLAR C15 | C32

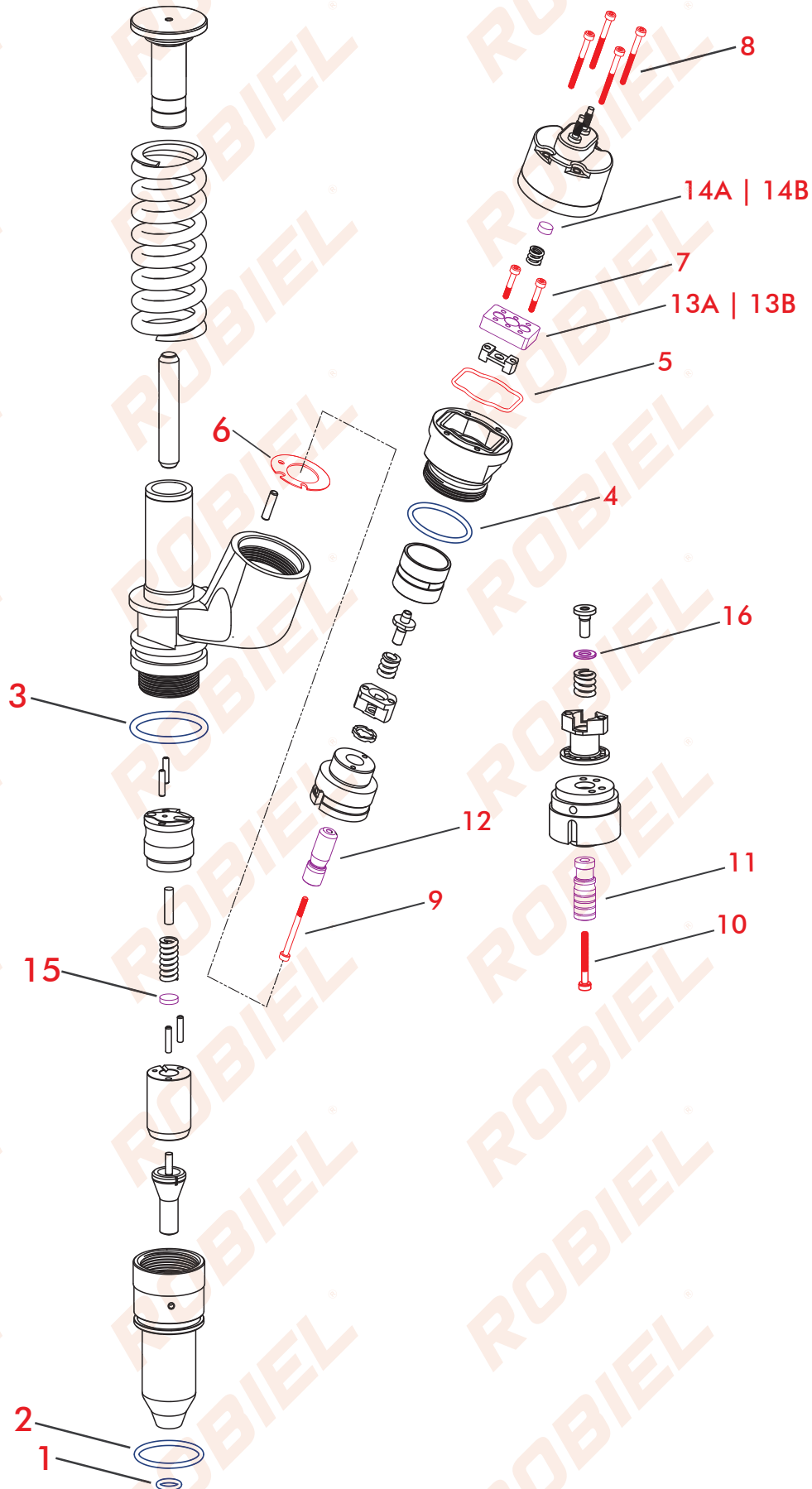





410.61.394 REPAIR PARTS - EUI CATERPILLAR C15/C32 UNIT				
REPARACION UNIDAD EUI CATERPILLAR C10/C12				
REFERENCE		248-1394		
Nº	ROBIEL CODE	REFERENCE	DESCRIPTION	PACK
1	421.01.021	9X-7317	O-ring - Anillo	01un.
2	421.03.326	230-3728	O-ring - Anillo	01un.
3	421.03.635	230-3775	O-ring - Anillo	01un.
4	421.03.226	-	O-ring - Anillo	01un.
5	421.03.516	-	O-ring - Anillo	01un.







SPARE PARTS				
Repuestos				
Nº	ROBIEL CODE	REFERENCE	DESCRIPTION	PACK
6	800.00.02	-	Deflector Shim - Volvo / Caterpillar Unit Solenoid <i>Deflector Solenoide Unidad Volvo / Caterpillar</i>	06un.
7	250.22.0316	-	Bolt - Allen - Caterpillar Unit Armature <i>Tornillo Allen Atraque Unid Caterpillar</i>	08un.
8	250.21.06	-	Bolt - Allen Solenoid Volvo / Caterpillar Unit <i>Tornillo Allen Solenoide Unidad Volvo / Caterpillar</i>	04un.
9	250.22.0335	-	Bolt - Caterpillar Unit Valve <i>Tornillo de la Válvula Unidad Caterpillar</i>	12un.
10	250.21.08	-	Bolt - Allen Volvo / Caterpillar Unit Valve <i>Tornillo Allen del Barril Unidad Volvo / Caterpillar</i>	04un.





11	ELEMENT - CATERPILLAR VOLVO D12 A/C UNIT VALVE		
ELEMENTO VALVULA UNIDAD CATERPILLAR / VOLVO D12 A/C			
	ROBIEL CODE	REFERENCE	THICKNESS(mm)
	340.06.0000	-	10.000
	340.06.005	-	10.005
	340.06.010	DP-V1000	10.010
	340.06.015	-	10.015
01 UNIT			

12	ELEMENT - CATERPILLAR DELPHI UNIT VALVE		
ELEMENTO VALVULA UNIDAD CATERPILLAR / DELPHI			
	ROBIEL CODE	REFERENCE	THICKNESS(mm)
	340.07.200	-	10.200
	340.07.205	-	10.205
	340.07.210	-	10.210
	340.07.215	-	10.215
01 UNIT			

13 A	ARMATURE PLATE PLACA DE ATRAQUE		
	ROBIEL CODE	REFERENCE	THICKNESS(mm)
	801.06.76	-	6.76
	801.06.78	-	6.78
	801.06.80	-	6.80
	801.06.82	-	6.82
	801.06.84	-	6.84
	801.06.86	-	6.86
06 UNITS			

13 B	ARMATURE PLATE PLACA DE ATRAQUE		
	ROBIEL CODE	REFERENCE	THICKNESS(mm)
	801.08.15	-	8.15
	801.08.17	-	8.17
	801.08.19	-	8.19
	801.08.21	-	8.21
	801.08.23	-	8.23
	801.08.25	-	8.25
06 UNITS			

14 A	SHIM - CATERPILLAR UNIT SOLENOID CALZO SOLENOIDE UNIDAD CATERPILLAR 		
	Ø 7.70 - INOX		
	ROBIEL CODE	REFERENCE	THICKNESS(mm)
	800.08.250	-	2.50
	800.08.255	-	2.55
	800.08.260	-	2.60
	800.08.265	-	2.65
	800.08.270	-	2.70
	800.08.275	-	2.75
	800.08.280	-	2.80
	800.08.285	-	2.85
	800.08.290	-	2.90
	800.08.295	-	2.95
	800.08.300	-	3.00
	800.08.310	-	3.10
	800.08.320	-	3.20
12 UNITS			

14 B	SHIM - CATERPILLAR UNIT SOLENOID CALZO SOLENOIDE UNIDAD CATERPILLAR 		
	Ø 7.70 - BRASS		
	ROBIEL CODE	REFERENCE	THICKNESS(mm)
	303.01.08	-	2.30
	303.01.09	-	2.35
	303.01.10	-	2.40
	303.01.11	-	2.45
	303.01.12	-	2.50
	303.01.13	-	2.55
	303.01.01	-	2.60
	303.01.02	-	2.65
	303.01.03	-	2.70
	303.01.04	-	2.75
	303.01.05	-	2.80
	303.01.06	-	2.85
	303.01.07	-	2.90
12 UNITS			

15	SHIM - CATERPILLAR UNIT NOZZLE CALCO DO BICO UNIDAD CATERPILLAR 		
	ROBIEL CODE	REFERENCE	THICKNESS(mm)
	800.10.205	-	2.05
	800.10.210	-	2.10
	800.10.215	-	2.15
	800.10.220	-	2.20
	800.10.225	-	2.25
	800.10.230	-	2.30
	800.10.235	-	2.35
	800.10.240	-	2.40
	800.10.245	-	2.45
	800.10.250	-	2.50
	800.10.255	-	2.55
	800.10.260	-	2.60
12 UNITS			

16

SHIM - SPRING PRESSURE
CALZO DE PRESION DEL RESORTE

Ø INT.: 5.40 Ø EXT.: 10.20



ROBIEL CODE	REFERENCE	THICKNESS(mm)
805.10.05	-	0.05
805.10.050	-	0.50
805.10.060	-	0.60
805.10.070	-	0.70
805.10.080	-	0.80
805.10.090	-	0.90
805.10.095	-	0.95
805.10.100	-	1.00
805.10.105	-	1.05
805.10.110	-	1.10
805.10.115	-	1.15
805.10.120	-	1.20
805.10.125	-	1.25
805.10.130	-	1.30

12 UNITS



323.50.22

Delphi EUI / Caterpillar EUI
 C10/C12/C15/C18/C32
 3500 Series Tool Kit
 Kit de Herramientas Unidades Delphi EUI
 Caterpillar EUI C10/C12/C15/C18/C32
 3500 Series



323.50.23

Delphi EUI Serie A1/A3 Volvo
 D12A/D12C - Caterpillar EUI
 C10/C12/C15/C18/C32
 3500 Series Tool Kit
 Kit de Herramientas Unidades Delphi EUI
 Serie A1/A3 Volvo D12A/D12C
 Caterpillar EUI C10/C12/C15/C18/C32
 3500 Series



324.17.004

Grinding Tool dor Caterpillar
 C15 Unit Nozzle Seat
 Herramienta Rectificar Asiento Tobera
 Unidad Caterpillar C15



323.01.3241

Rotating Vise W /
 Indexer Pin
 Morsa Giratoria con Pin index



324.15.01

Injectors and Units Repair
 Bracket
 Soporte para reparacion
 de Inyectores y Unidades



324.13.271

Device to Remove the Delphi
 Caterpillar Unit Puller Spring
 Dispositivo para Extraccion Resorte Externo
 Unidad Delphi / Caterpillar



EUI CATERPILLAR 3500 UNIT
 UNIDAD EUI CATERPILLAR 3500

UNIT CODE

253 0615

212 3464

10R 0725

211 3023

CH1 2071

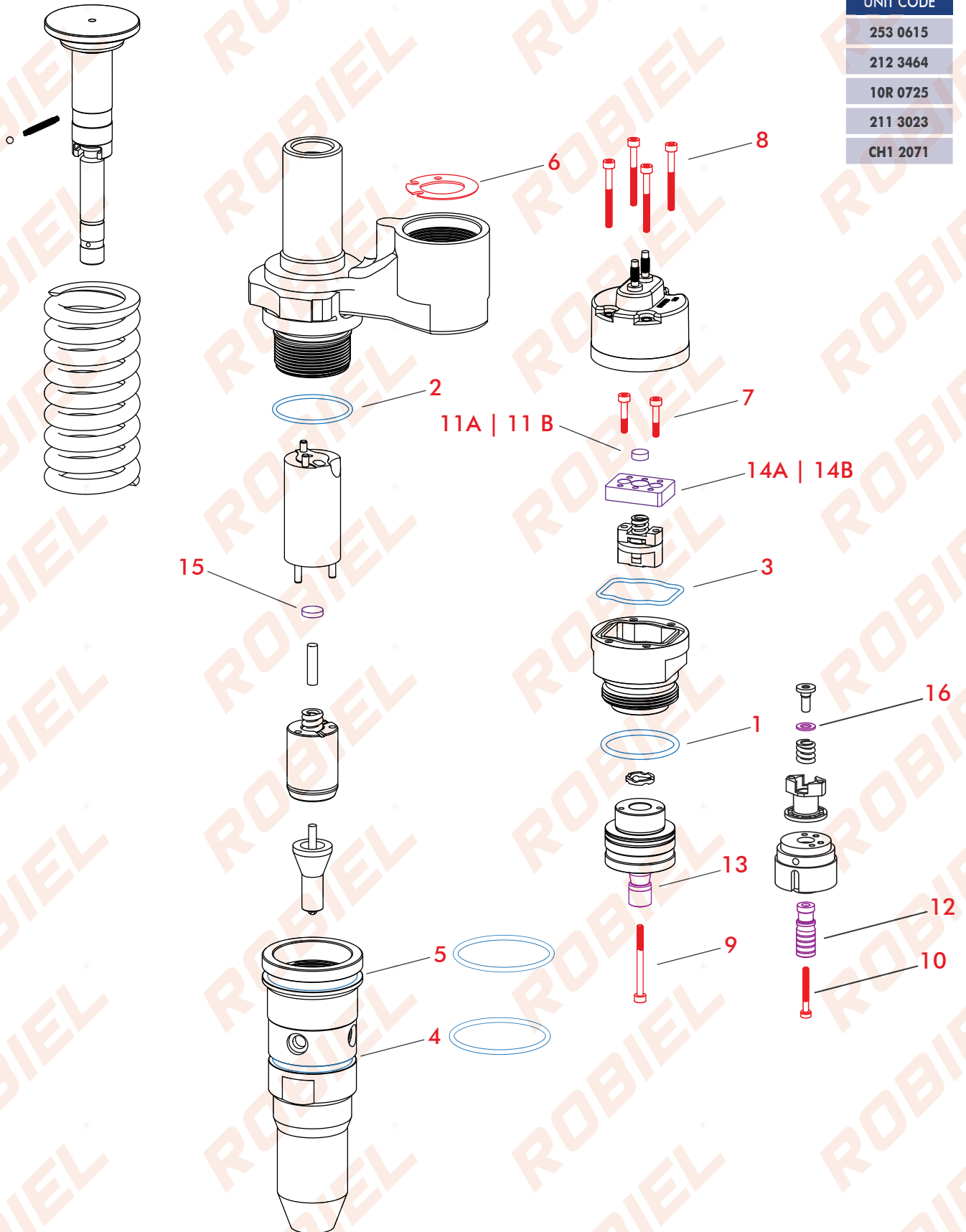

410.61.3500 REPAIR PARTS - CATERPILLAR 3500 UNIT
 REPARACION UNID CATERPILLAR 3500

REFERENCE		DP-K1008		
Nº	ROBIEL CODE	REFERENCE	DESCRIPTION	PACK
1	421.03.226	-	O-ring - Anillo	01un.
2	421.03.318	-	O-ring - Anillo	01un.
3	421.03.516	-	O-ring - Anillo	01un.
4	421.03.626	-	O-ring - Anillo	01un.
5	421.04.135	-	O-ring - Anillo	01un.

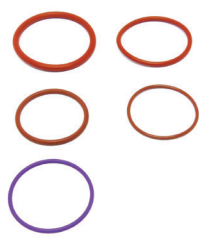

SPARE PARTS
Repuestos

Nº	ROBIEL CODE	REFERENCE	DESCRIPTION	PACK
6	800.00.02	-	Deflector Shim - Volvo / Caterpillar Unit Solenoid <i>Deflector Solenoide Unidad Volvo / Caterpillar</i>	06un.
7	250.22.0316	-	Bolt - Allen - Caterpillar Unit Armature <i>Tornillo Allen Atraque Unid Caterpillar</i>	08un.
8	250.21.06	-	Bolt - Allen Solenoid Volvo / Caterpillar Unit <i>Tornillo Allen Solenoide Unidad Volvo / Caterpillar</i>	04un.
9	250.22.0335	-	Bolt - Caterpillar Unit Valve <i>Tornillo de la Valvula Unidad Caterpillar</i>	12un.
10	250.21.08	-	Bolt - Allen Volvo / Caterpillar Unit Valve <i>Tornillo Allen del Barril Unidad Volvo / Caterpillar</i>	04un.



*For deflector application. use tools: 324.17.342 and 324.18.342.
 * Para la aplicación del deflector. utilizar las herramientas 324.17.342 y 324.18.342.



11 A	SHIM - CATERPILLAR UNIT SOLENOID CALZO SOLENOIDE UNIDAD CATERPILLAR		
	ROBIEL CODE	REFERENCE	THICKNESS(mm)
	Ø 7.70 - INOX		
	800.08.250	-	2.50
	800.08.255	-	2.55
	800.08.260	-	2.60
	800.08.265	-	2.65
	800.08.270	-	2.70
	800.08.275	-	2.75
	800.08.280	-	2.80
	800.08.285	-	2.85
	800.08.290	-	2.90
	800.08.295	-	2.95
	800.08.300	-	3.00
	800.08.310	-	3.10
	800.08.320	-	3.20
12 UNITS			



11 B	SHIM - CATERPILLAR UNIT SOLENOID CALZO SOLENOIDE UNIDAD CATERPILLAR		
	ROBIEL CODE	REFERENCE	THICKNESS(mm)
	Ø 7.70 - BRASS		
	303.01.08	-	2.30
	303.01.09	-	2.35
	303.01.10	-	2.40
	303.01.11	-	2.45
	303.01.12	-	2.50
	303.01.13	-	2.55
	303.01.01	-	2.60
	303.01.02	-	2.65
	303.01.03	-	2.70
	303.01.04	-	2.75
	303.01.05	-	2.80
	303.01.06	-	2.85
	303.01.07	-	2.90
12 UNITS			

12 **ELEMENT - CATERPILLAR**
VOLVO D12 A/C UNIT VALVE
ELEMENTO VALVULA UNIDAD CATERPILLAR / VOLVO D12 A/C



ROBIEL CODE	REFERENCE	THICKNESS(mm)
340.06.0000	-	10.000
340.06.005	-	10.005
340.06.010	DP-V1000	10.010
340.06.015	-	10.015
01 UNIT		

13 **ELEMENT - CATERPILLAR**
DELPHI UNIT VALVE
ELEMENTO VALVULA UNIDAD CATERPILLAR / DELPHI



ROBIEL CODE	REFERENCE	THICKNESS(mm)
340.07.200	-	10.200
340.07.205	-	10.205
340.07.210	-	10.210
340.07.215	-	10.215
01 UNIT		

14 A **ARMATURE PLATE**
PLACA DE ATRAQUE



ROBIEL CODE	REFERENCE	THICKNESS(mm)
801.06.76	-	6.76
801.06.78	-	6.78
801.06.80	-	6.80
801.06.82	-	6.82
801.06.84	-	6.84
801.06.86	-	6.86
06 UNITS		

14 B **ARMATURE PLATE**
PLACA DE ATRAQUE



ROBIEL CODE	REFERENCE	THICKNESS(mm)
801.08.15	-	8.15
801.08.17	-	8.17
801.08.19	-	8.19
801.08.21	-	8.21
801.08.23	-	8.23
801.08.25	-	8.25
06 UNITS		

15 **SHIM - CATERPILLAR UNIT NOZZLE**
CALCO DO BICO UNIDAD CATERPILLAR

ROBIEL CODE	REFERENCE	THICKNESS(mm)
800.10.205	-	2.05
800.10.210	-	2.10
800.10.215	-	2.15
800.10.220	-	2.20
800.10.225	-	2.25
800.10.230	-	2.30
800.10.235	-	2.35
800.10.240	-	2.40
800.10.245	-	2.45
800.10.250	-	2.50
800.10.255	-	2.55
800.10.260	-	2.60
12 UNITS		

16 **SHIM - SPRING PRESSURE**
CALZO DE PRESION DEL RESORTE
Ø Int.: 5.40 Ø Ext.: 10.20

ROBIEL CODE	REFERENCE	THICKNESS(mm)
805.10.05	-	0.05
805.10.050	-	0.50
805.10.060	-	0.60
805.10.070	-	0.70
805.10.080	-	0.80
805.10.090	-	0.90
805.10.095	-	0.95
805.10.100	-	1.00
805.10.105	-	1.05
805.10.110	-	1.10
805.10.115	-	1.15
805.10.120	-	1.20
805.10.125	-	1.25
805.10.130	-	1.30
12 UNITS		



323.50.22

Delphi EUI / Caterpillar EUI
C10/C12/C15/C18/C32
3500 Series Tool Kit
Kit de Herramientas Unidades Delphi EUI
Caterpillar EUI C10/C12/C15/C18/C32
3500 Series



323.50.23

Delphi EUI Serie A1/A3 Volvo
D12A/D12C - Caterpillar EUI
C10/C12/C15/C18/C32
3500 Series Tool Kit
Kit de Herramientas Unidades Delphi EUI
Serie A1/A3 Volvo D12A/D12C
Caterpillar EUI C10/C12/C15/C18/C32
3500 Series



323.01.3241

Rotating Vise W /
Indexer Pin
Morsa Giratoria con Pin index



324.15.01

Injectors and Units Repair
Bracket
Soporte para reparación
de Inyectores y Unidades



324.13.271

Device to Remove the Delphi
Caterpillar Unit Puller Spring
Dispositivo para Extracción Resorte Externo
Unidad Delphi / Caterpillar



324.17.342

Grinding Tool to
Deflector Seat
Herramienta Rectificar Asiento Deflector



324.18.342

Polishing Tool to
Deflector Seat
Herramienta Acabamiento
Asiento Deflector



323.02.13

Cutting Oil
Aceite corte



CUMMINS N14 UNIT
UNIDAD CUMMINS N14

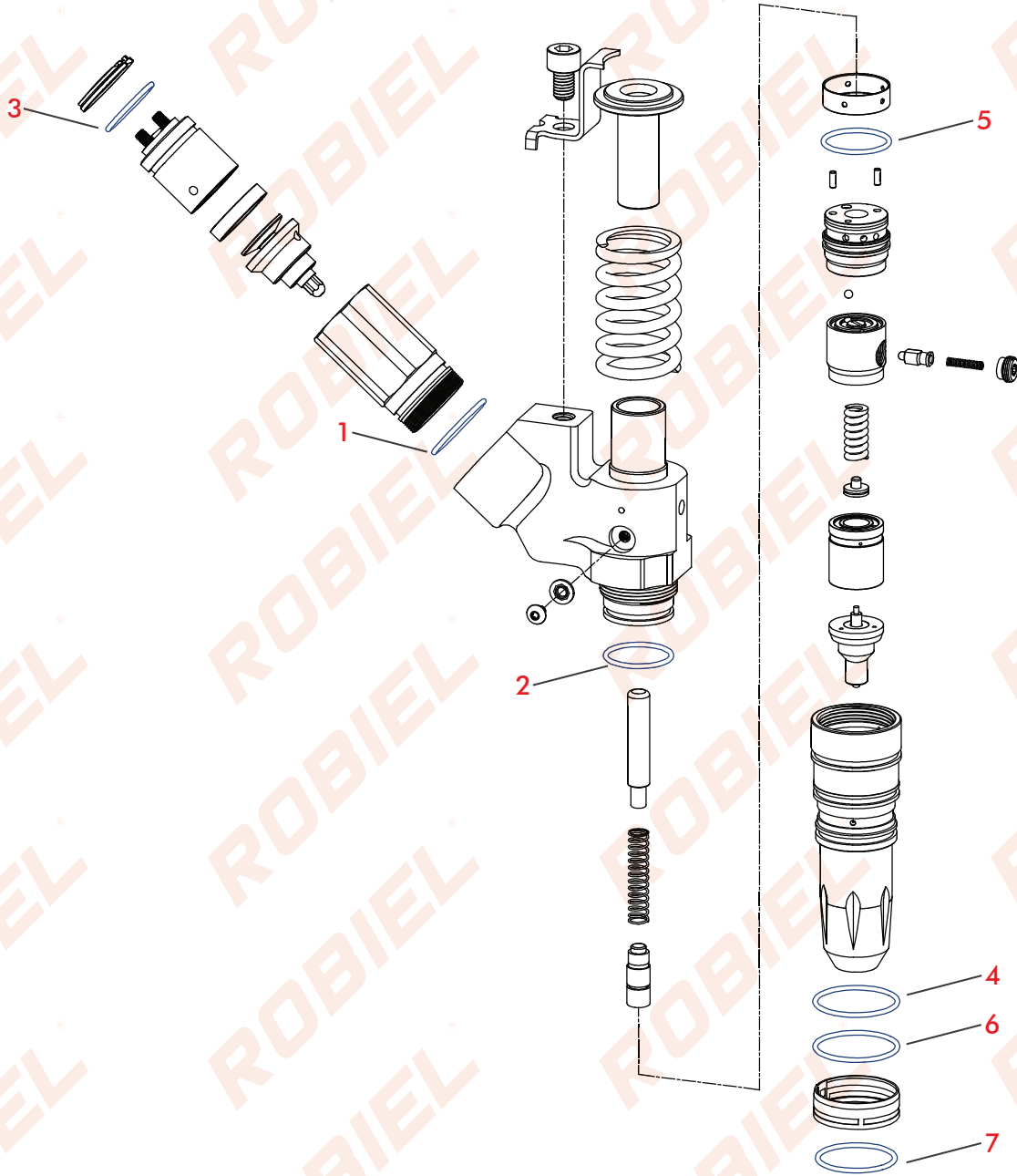

410.06.0001 REPAIR PARTS - CUMMINS N14 UNIT
REPARACION UNIDAD CUMMINS N14

REFERENCE		MCB3060001		
Nº	ROBIEL CODE	REFERENCE	DESCRIPTION	PACK
1	421.02.518	-	O-ring - Anillo	01un.
2	421.02.418	-	O-ring - Anillo	01un.
3	421.02.218	-	O-ring - Anillo	01un.
4	421.03.218	3070136	O-ring - Anillo	01un.
5	421.02.217	-	O-ring - Anillo	01un.
6	421.03.017	3070137	O-ring - Anillo	01un.
7	421.02.817	3070138	O-ring - Anillo	01un.

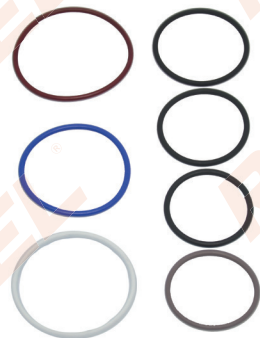

DELPHI EUI A1 | A3 UNIT
UNIDAD DELPHI EUI A1 | A3

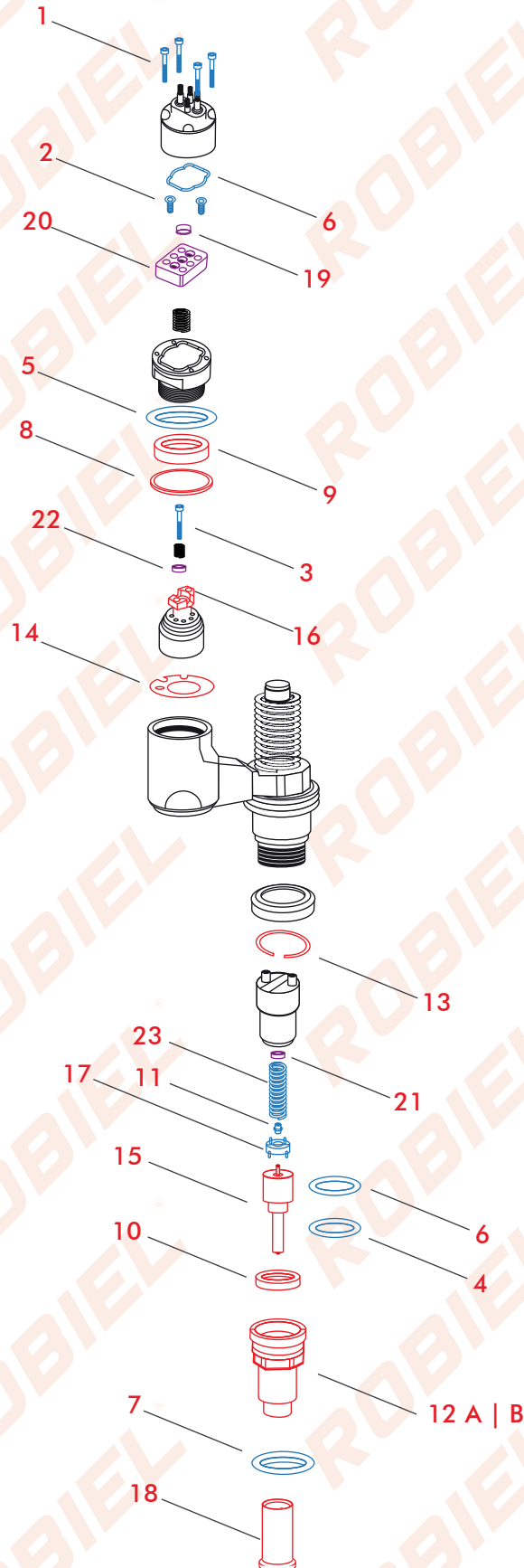

410.69.48		REPAIR PARTS - DELPHI/VOLVO UNIT SOLENOID SCREWS		
REFERENCE		REPARACION TORNILLOS SOLEN UNID DELPHI VOLVO		
Nº	ROBIEL CODE	REFERENCE	DESCRIPTION	PACK
1	250.21.06	-	Bolt - Tornillo	04un.
2	250.21.07	-	Bolt - Tornillo	02un.
3	250.21.08	-	Bolt - Tornillo	01un.



420.27.6948		REPAIR RINGS SET - VOLVO D12A/C UNIT		
REFERENCE		276948		
Nº	ROBIEL CODE	REFERENCE	DESCRIPTION	PACK
4	421.03.224L	7200-0016	O-ring - Anillo	01un.
5	421.03.226	-	O-ring - Anillo	01un.
6	421.03.516	7200-0015	O-ring - Anillo	02un.
7	421.03.530	-	O-ring - Anillo	01un.



410.35.488		REPAIR PARTS - VOLVO D12A/C UNIT		
REFERENCE		-		
Nº	ROBIEL CODE	REFERENCE	DESCRIPTION	PACK
4	421.03.224L	7200-0016	O-ring - Anillo	01un.
5	421.03.226	-	O-ring - Anillo	01un.
6	421.03.516	7200-0015	O-ring - Anillo	02un.
7	421.03.530	-	O-ring - Anillo	01un.
14	800.00.02	-	Deflector - Deflector	01un.



409.35.487		REPAIR PARTS - VOLVO D12D UNIT		
REFERENCE		7135-487		
Nº	ROBIEL CODE	REFERENCE	DESCRIPTION	PACK
17	D00.35.487	7135-487	Intermediate Disc - Disco Intermedio	01un.
11	305.02.30	-	Pressure Pin - Top de presion	01un.
23	225.01.31	-	Spring - Resorte	01un.



SPARE PARTS Repuestos				
Nº	ROBIEL CODE	REFERENCE	DESCRIPTION	PACK
1	250.21.06	-	Bolt - Allen Solenoid Volvo / Caterpillar Unit <i>Tornillo Allen Solenoide Unidad Volvo / Caterpillar</i>	04un.
2	250.21.07	-	Bolt - Allen - Volvo Unit Amature <i>Tornillo Allen Atraque Unidad Volvo</i>	04un.
3	250.21.08	-	Bolt - Allen Volvo / Caterpillar Unit Valve <i>Tornillo Allen del Barril Unidad Volvo / Caterpillar</i>	04un.
8	110.03.01	-	Ring - Distancing - Solenoid - 3.20mm <i>Anillo Distante Solenoide - 3.20mm</i>	02un.
9	110.03.02	-	Solenoid Thrust Ring - 9.00mm <i>Anillo de Respaldo Solenoide - 9.00mm</i>	02un.
10	112.01.02	7204-0091	Ring - Sttel <i>Anillo de Acero</i>	03un.
11	305.02.30	-	Pressure Pin - D12D Volvo Nozzle <i>Top de Presion de la Tobera Volvo D12D</i>	06un.
12	315.06.24	7204-0089	Nut - Nozzle-Retaining FH12 D12A Electronical Unit <i>Tapa de la Tobera Unidad Electronica FH12 D12A</i>	01un.
13	335.03.03	-	Lock - FH12 Unit Nut <i>Bloqueo de la Yuerca de la Unidad FH12</i>	06un.
14	800.00.02	-	Deflector Shim - Volvo / Caterpillar Unit Solenoid <i>Deflector Solenoide Unidad Volvo / Caterpillar</i>	06un.
15	B00.17.PBB	L 017 PBB	Injector Nozzle - Volvo D12C Delphi - NH380CV <i>Tobera Inyector Volvo D12C Delphi NH380CV</i>	01un.
16	340.06.005	-	Element - Volvo D12A/C Caterpillar Unit Valve Ø10.005mm <i>Elemento Valvula Unidad Volvo D12A/C Caterpillar</i>	01un.
16	340.06.010	-	Element - Volvo D12A/C Caterpillar Unit Valve Ø10.010mm <i>Elemento Valvula Unidad Volvo D12A/C Caterpillar</i>	01un.
16	340.06.015	-	Element - Volvo D12A/C Caterpillar Unit Valve Ø10.015mm <i>Elemento Valvula Unidad Volvo D12A/C Caterpillar</i>	01un.
17	D00.35.487	7135-487	Intermediate Disc - Volvo D12A D12C D12D <i>Disco Intermedio Volvo D12A D12C D12D</i>	01un.
18	220.03.08	-	Protective Cap - Injectors / Units Nozzle - 7.00mm <i>Tapa Protectora p/ Tobera Inyectores / Unidades - 7.00mm</i>	01kit.
R1	140.06.03	-	Bushing - FH12 Gear Pump Valve Seat <i>Casquillo Del Asiento - Valvula de la BBA Alimentacion FH12</i>	01un.
R2	250.08.05	3 184 837	Bolt - 8.00mm - FH12 Gear Pump - 1/2 Wrench <i>Tornillo 8.00mm BBA Alimentacion FH12 Llave 1/2</i>	01un.
R3	340.03.18	3095479	Valve - Overflow - Volvo - 3.5kg <i>Valvula de socorro Volvo</i>	01un.
R4	340.03.24	-	Valve - Overflow - Volvo - 6.0kg <i>Valvula de socorro Volvo</i>	01un.
R5	420.05.23	976013	Gasket - FH12 Volvo Gear Pump <i>Empaquetadura BBA Alimentación Volvo FH12</i>	01un.
R6	421.00.915	976013	O-Ring Green - Volvo D12C / Delphi <i>Anillo Oring verde - BBA Volvo D12C / Delphi</i>	05un.
R7	421.01.01	20526428 1677370	Repair Rings Set - Volvo Electronic Veb Valve <i>Reparacion Anillos Valvula Veb Volvo Eletronica</i>	01kit.
R8	430.01.224	8148471	Retainer - Volvo FH12 Gear Pump <i>Reten de la BBA Alimentación Volvo FH12</i>	02un.
R9	815.47.____	-	Shim - Adjustment - Volvo Exhaust Valve <i>Calzo Ajuste Valvula Escape Volvo</i>	01un.



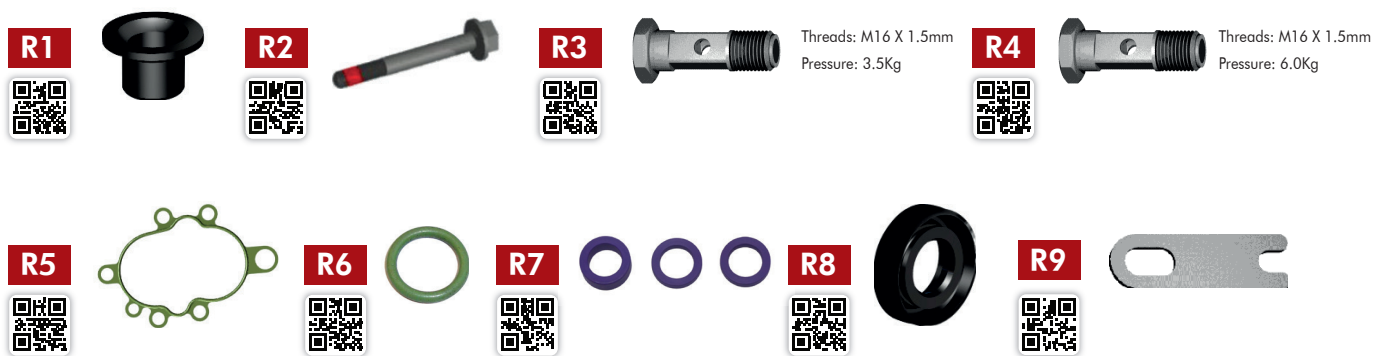

Threads: M16 X 1.5mm
Pressure: 3.5Kg

Threads: M16 X 1.5mm
Pressure: 6.0Kg

19 SHIM - DELPHI/ CATERPILLAR UNIT SOLENOID
CALZO SOLENOIDE UNIDAD DELPHI / CATERPILLAR

ROBIEL CODE	REFERENCE	THICKNESS(mm)
303.01.08	-	2.30
303.01.09	-	2.35
303.01.10	-	2.40
303.01.11	-	2.45
303.01.12	-	2.50
303.01.13	-	2.55
303.01.01	-	2.60
303.01.02	-	2.65
303.01.03	-	2.70
303.01.04	-	2.75
303.01.05	-	2.80
303.01.06	-	2.85
303.01.07	-	2.90

12 UNITS

20 ARMATURE PLATE
PLACA DE ATRAQUE



ROBIEL CODE	REFERENCE	THICKNESS(mm)
801.08.15	-	8.15
801.08.17	-	8.17
801.08.19	-	8.19
801.08.21	-	8.21
801.08.23	-	8.23
801.08.25	-	8.25

12 UNITS

21 SHIM - VOLVO ELETRONIC UNIT
CALZO TOBERA UNIDAD ELETRONICA VOLVO

∅ Int.: 3.30 ∅ Ext.: 7.70

ROBIEL CODE	REFERENCE	THICKNESS(mm)
804.07.010	-	0.10
804.07.015	-	0.15
804.07.025	-	0.25
804.07.030	-	0.30
804.07.050	-	0.50
804.07.060	-	0.60
804.07.070	-	0.70

12 UNITS

22 SHIM - SPRING PRESSURE
CALZO DE PRESION DEL RESORTE

∅ Int.: 5.40 ∅ Ext.: 10.20

ROBIEL CODE	REFERENCE	THICKNESS(mm)
805.10.05	-	0.05
805.10.050	-	0.50
805.10.060	-	0.60
805.10.070	-	0.70
805.10.080	-	0.80
805.10.090	-	0.90
805.10.095	-	0.95
805.10.100	-	1.00
805.10.105	-	1.05
805.10.110	-	1.10
805.10.115	-	1.15
805.10.120	-	1.20
805.10.125	-	1.25
805.10.130	-	1.30

12 UNITS

R9

ADJUSTMENT SHIM - VOLVO EXHAUST VALVE (VEB)
CALZO AJUSTE VALVULA ESCAPE VOLVO



ROBIEL CODE	REFERENCE	THICKNESS(mm)	ROBIEL CODE	REFERENCE	THICKNESS(mm)
815.47.959	-	1.80	815.47.984	-	2.85
815.47.961	-	1.85	815.47.985	-	2.90
815.47.963	-	1.90	815.47.9851	-	2.95
815.47.965	-	1.95	815.47.986	-	3.10
815.47.967	-	2.00	815.47.987	-	3.15
815.47.968	-	2.05	815.47.988	-	3.20
815.47.969	-	2.10	815.47.989	-	3.25
815.47.970	-	2.15	815.47.990	-	3.30
815.47.971	-	2.20	815.47.991	-	3.35
815.47.972	-	2.25	815.47.992	-	3.40
815.47.973	-	2.30	815.47.993	-	3.45
815.47.974	-	2.35	815.47.994	-	3.50
815.47.975	-	2.40	815.47.995	-	3.55
815.47.976	-	2.45	815.47.996	-	3.60
815.47.977	-	2.50	815.47.997	-	3.65
815.47.978	-	2.55	815.47.998	-	3.70
815.47.979	-	2.60	815.47.999	-	3.75
815.47.980	-	2.65	815.47.1000	-	3.80
815.47.981	-	2.70	815.47.1001	-	3.85
815.47.982	-	2.75	815.47.1002	-	3.90
815.47.983	-	2.80	815.47.1003	-	3.95

02 UNITS

415.00.10 PARTS SET - EUI A1/A3 UNIT REPAIRING
JUEGO PIEZAS REPARACION UNIDAD EUI A1/A3



06 UNITS BY MEASURE

132 UNITS



323.01.09

Solenoid Wrench
Delphi Unit
Llave del Solenoide Unidad Delphi



323.01.25

Nozzle tester Adapter
Volvo EUI Unit
Adaptador Prueba Tobera Unidad
Volvo EUI



324.33.002

Nut Wrench - Delphi Unit
Llave de la Tuerca Unidad Delphi



323.01.49

Device for Removal
the Volvo Drive
Dispositivo para Extraccion Mando Volvo



323.02.12

Cleaning Brush
Cepillo de Limpieza
Ø 10.00mm



323.02.13

Cutting Oil
Aceite corte



323.01.3241

Rotating Vise W /
Indexer Pin
Morsa Giratoria con Pin index



324.15.01

Injectors and Units Repair
Bracket
Soporte para reparacion
de Inyectores y Unidades



324.15.05

Clamp Set for Units
Clip de las Unidades



324.17.342

Grinding Tool to
Deflector Seat
Herramienta Rectificar Asiento Deflector



324.18.342

Polishing Tool to
Deflector Seat
Herramienta Acabamiento
Asiento Deflector



324.13.271

Device to Remove the Delphi
Caterpillar Unit Puller Spring
Dispositivo para Extraccion Resorte Externo
Unidad Delphi / Caterpillar

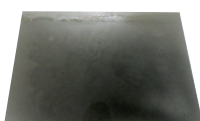

323.02.08

Diamond Plate for Grinding
Placa de Diamante para Rectificar



323.50.12

Delphi EUI Serie A1 | A3 |
E1 | E3 Tool kit
Kit de Herramientas Unidades Delphi A1
| A3 | E1 | E3



323.50.19

Delphi EUI Serie A1 | A3 |
Volvo D12A/C Tool Kit
Kit de Herramientas Unidades
Delphi A1 | A3 - Volvo D12A/C



DELPHI E1 UNIT
UNIDAD DELPHI E1

Volvo D12D

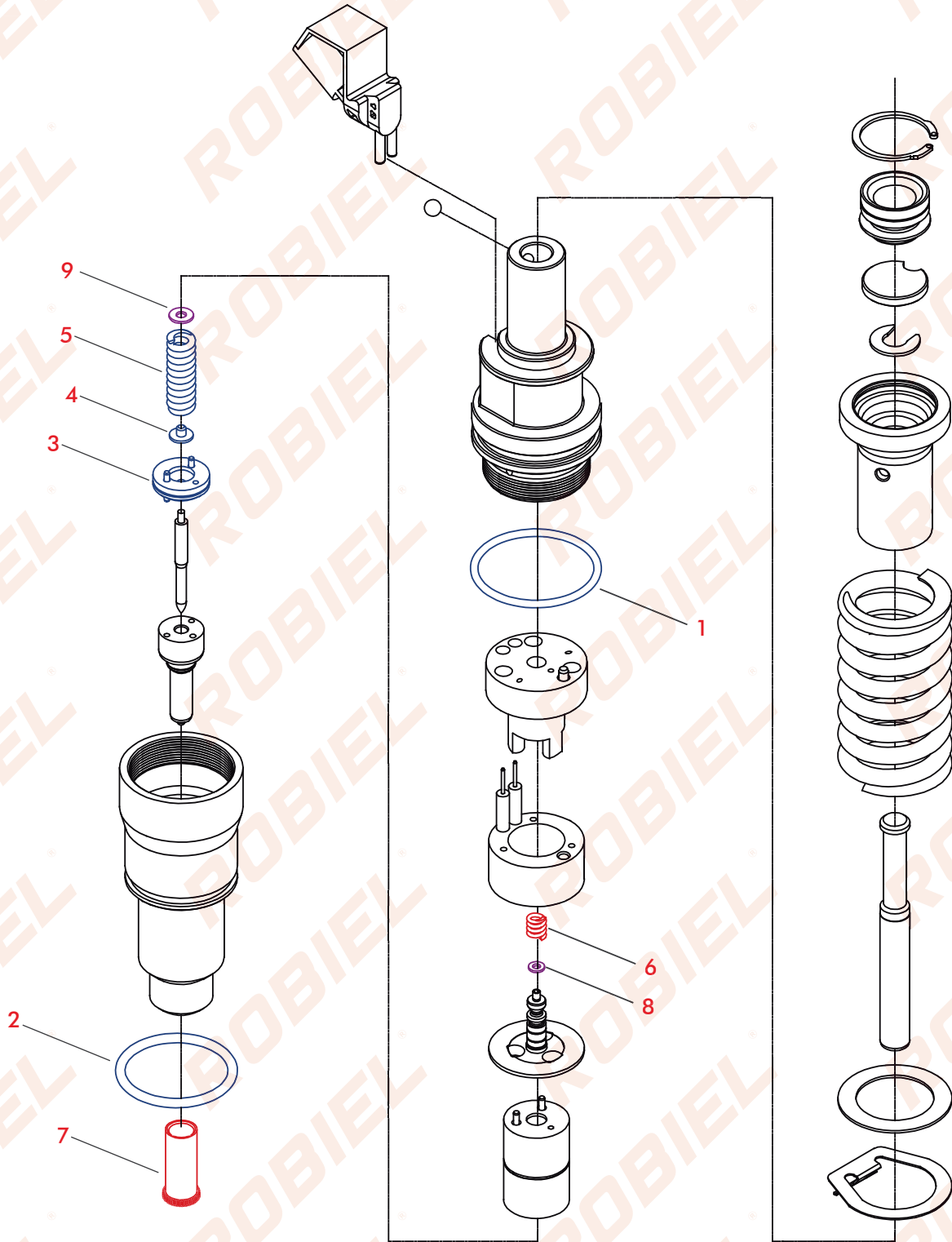

420.27.6950 REPAIR RINGS SET - VOLVO D12D UNIT
 REPARACION ANILLOS UNIDAD VOLVO D12D

REFERENCE		D12D		
Nº	ROBIEL CODE	REFERENCE	DESCRIPTION	PACK
1	421.03.224	7200-0054	O-ring - Anillo	01un.
2	421.03.530	7200-0053	O-ring - Anillo	01un.



409.35.487 REPAIR PARTS - VOLVO D12D UNIT
 REPARACION UNIDAD VOLVO D12D

REFERENCE		7135-487		
Nº	ROBIEL CODE	REFERENCE	DESCRIPTION	PACK
3	D00.35.487	7135-487	Intermediate Disc - Disco Intermedio	01un.
4	305.02.30	-	Pressure Pin - Top de presion	01un.
5	225.01.31	-	Spring - Resorte	01un.



SPARE PARTS
 Repuestos

Nº	ROBIEL CODE	REFERENCE	DESCRIPTION	PACK
6	225.01.32	-	Spring - Volvo D12D Unit Resorte de la Unidad Volvo D12D	06un.
7	220.03.08	-	Protective Cap - Injectors / Units Nozzle - 7.00mm Tapa Protectora p/ Tobera Inyectores / Unidades - 7.00mm	01kit.
R1	340.03.18	3095479	Valve - Overflow - Volvo - 3.5kg Valvula de socorro Volvo	01un.
R2	340.03.24	-	Valve - Overflow - Volvo - 6.0kg Valvula de socorro Volvo	01un.
R3	421.01.01	20526428 1677370	Repair Rings Set - Volvo Electronic Veb Valve Reparacion Anillos Valvula Veb Volvo Electronica	01kit.
R4	815.47.____	-	Shim - Adjustment - Volvo Exhaust Valve Calzo Ajuste Valvula Escape Volvo	02un.

6



7



R1



Threads: M16 X 1.5mm
Pressure: 3.5Kg



R2



Threads: M16 X 1.5mm
Pressure: 6.0Kg



R3



R4



8 SHIM - ADJUSTMENT - VOLVO 380|420|460 UNIT
 CALZO DE AJUSTE UNIDAD OLVO 380|420|460

Ø Int.: 2.40 Ø Ext.: 5.10



ROBIEL CODE	REFERENCE	THICKNESS(mm)
802.05.01	-	0.10
802.05.02	-	0.15
802.05.03	-	0.25
802.05.04	-	0.50
802.05.05	-	0.30
802.05.06	-	0.60
802.05.07	-	0.70
802.05.08	-	0.80
802.05.09	-	0.90
802.05.10	-	1.00

06 UNITS

9 SHIM - VOLVO ELETRONIC UNIT
 CALZO TOBERA UNIDAD ELETRONICA VOLVO

Ø Int.: 3.30 Ø Ext.: 7.70



ROBIEL CODE	REFERENCE	THICKNESS(mm)
804.07.010	-	0.10
804.07.015	-	0.15
804.07.025	-	0.25
804.07.030	-	0.30
804.07.050	-	0.50
804.07.060	-	0.60
804.07.070	-	0.70

06 UNITS

R4
ADJUSTMENT SHIM - VOLVO EXHAUST VALVE (VEB)
 CALZO AJUSTE VALVULA ESCAPE VOLVO

ROBIEL CODE	REFERENCE	THICKNESS(mm)	ROBIEL CODE	REFERENCE	THICKNESS(mm)
815.47.959	-	1.80	815.47.984	-	2.85
815.47.961	-	1.85	815.47.985	-	2.90
815.47.963	-	1.90	815.47.9851	-	2.95
815.47.965	-	1.95	815.47.986	-	3.10
815.47.967	-	2.00	815.47.987	-	3.15
815.47.968	-	2.05	815.47.988	-	3.20
815.47.969	-	2.10	815.47.989	-	3.25
815.47.970	-	2.15	815.47.990	-	3.30
815.47.971	-	2.20	815.47.991	-	3.35
815.47.972	-	2.25	815.47.992	-	3.40
815.47.973	-	2.30	815.47.993	-	3.45
815.47.974	-	2.35	815.47.994	-	3.50
815.47.975	-	2.40	815.47.995	-	3.55
815.47.976	-	2.45	815.47.996	-	3.60
815.47.977	-	2.50	815.47.997	-	3.65
815.47.978	-	2.55	815.47.998	-	3.70
815.47.979	-	2.60	815.47.999	-	3.75
815.47.980	-	2.65	815.47.1000	-	3.80
815.47.981	-	2.70	815.47.1001	-	3.85
815.47.982	-	2.75	815.47.1002	-	3.90
815.47.983	-	2.80	815.47.1003	-	3.95

02 UNITS



323.01.48

Nozzle Tester Adapter
D12D | D12C Volvo Unit
Adaptador prueba Tobera Unidad
Volvo D12D | D12C



323.01.49

Device for Removal
the Volvo Drive
Dispositivo para Extracion Mando Volvo



323.02.12

Cleaning Brush
Cepillo de Limpieza
Ø 10.00mm



323.02.13

Cutting Oil
Aceite corte



323.01.3241

Rotating Vise W /
Indexer Pin
Morsa Giratoria con Pin index



324.13.271

Device to Remove the Delphi
Caterpillar Unit Puller Spring
Dispositivo para Extraccion Resorte Externo
Unidad Delphi / Caterpillar



324.15.01

Injectors and Units Repair
Bracket
Soporte para reparacion
de Inyectores y Unidades



324.15.05

Clamp Set for Units
Clip de las Unidades



323.01.671

Nut Wrench - Volvo
D12D | D13 Nozzle
Llave de la tuerca de Tobera
Volvo D12D | D13



323.50.12

Delphi EUI Serie A1 | A3 | E1 | E3
Tool kit
Kit de Herramientas Unidades Delphi A1 | A3 | E1 | E3



DELPHI E1 UNIT
UNIDAD DELPHI E1

Volvo D12D

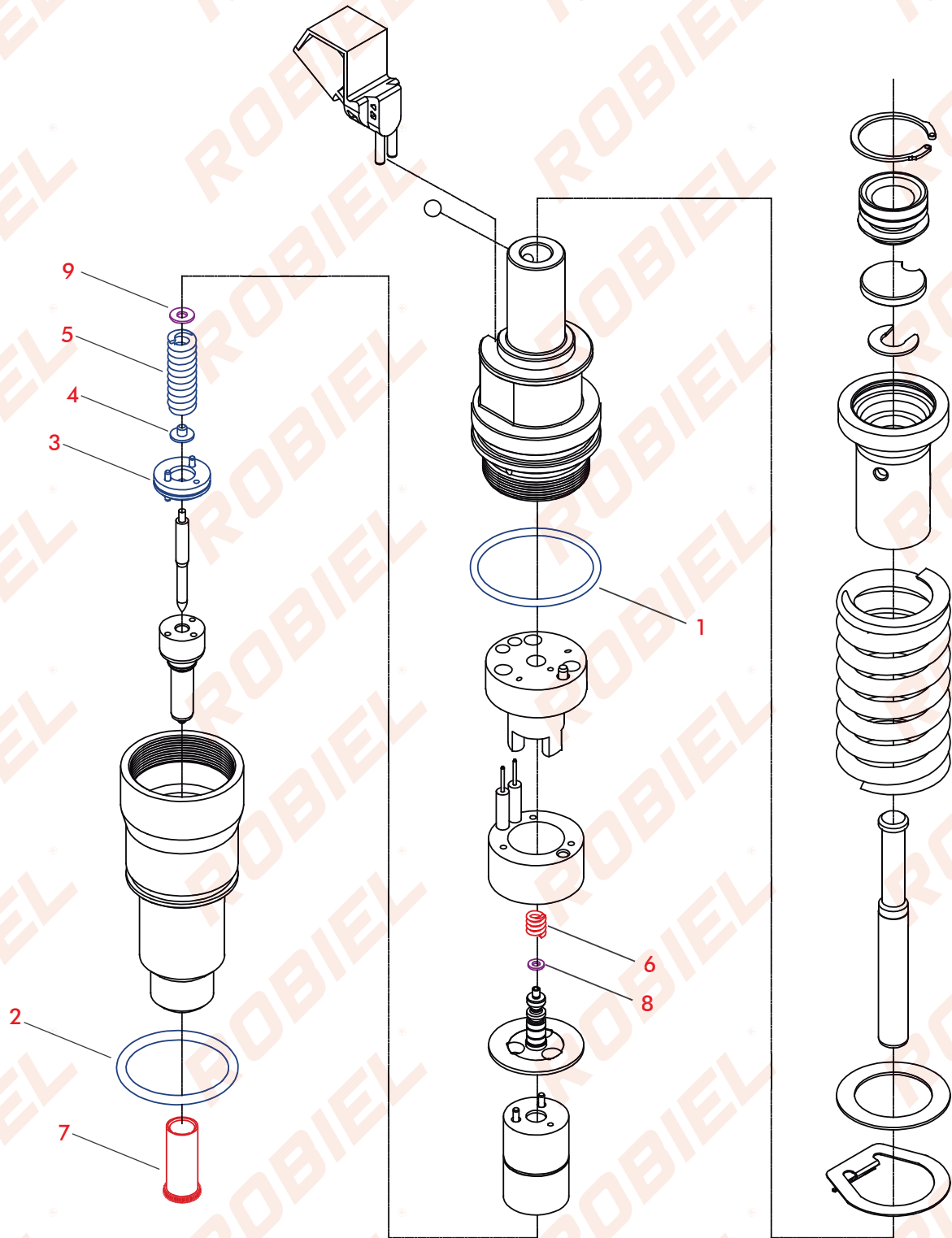

420.27.6950		REPAIR RINGS SET - VOLVO D12D UNIT		
		REPARACION ANILLOS UNIDAD VOLVO D12D		
REFERENCE		D12D		
Nº	ROBIEL CODE	REFERENCE	DESCRIPTION	PACK
1	421.03.224	7200-0054	O-ring - Anillo	01un.
2	421.03.530	7200-0053	O-ring - Anillo	01un.



409.35.487		REPAIR PARTS - VOLVO D12D UNIT		
		REPARACION UNIDAD VOLVO D12D		
REFERENCE		7135-487		
Nº	ROBIEL CODE	REFERENCE	DESCRIPTION	PACK
3	D00.35.487	7135-487	Intermediate Disc - Disco Intermedio	01un.
4	305.02.30	-	Pressure Pin - Top de presion	01un.
5	225.01.31	-	Spring - Resorte	01un.





SPARE PARTS				
Repuestos				
Nº	ROBIEL CODE	REFERENCE	DESCRIPTION	PACK
6	225.01.32	-	Spring - Volvo D12D Unit <i>Resorte de la Unidad Volvo D12D</i>	06un.
7	220.03.08	-	Protective Cap - Injectors / Units Nozzle - 7.00mm <i>Tapa Protectora p/ Tobera Inyectores / Unidades - 7.00mm</i>	01kit.
R1	340.03.18	3095479	Valve - Overflow - Volvo - 3.5kg <i>Valvula de socorro Volvo</i>	01un.
R2	340.03.24	-	Valve - Overflow - Volvo - 6.0kg <i>Valvula de socorro Volvo</i>	01un.
R3	421.01.01	20526428 1677370	Repair Rings Set - Volvo Electronic Veb Valve <i>Reparacion Anillos Valvula Veb Volvo Electronica</i>	01kit.
R4	815.47.____	-	Shim - Adjustment - Volvo Exhaust Valve <i>Calzo Ajuste Valvula Escape Volvo</i>	02un.



6





7





R1

Threads: M16 X 1.5mm
Pressure: 3.5Kg





R2

Threads: M16 X 1.5mm
Pressure: 6.0Kg





R3





R4



8	SHIM - ADJUSTMENT - VOLVO 380 420 460 UNIT		
CALZO DE AJUSTE UNIDAD OLVO 380 420 460			
Ø Int.: 2.40 Ø Ext.: 5.10			
ROBIEL CODE	REFERENCE	THICKNESS(mm)	
802.05.01	-	0.10	
802.05.02	-	0.15	
802.05.03	-	0.25	
802.05.04	-	0.50	
802.05.05	-	0.30	
802.05.06	-	0.60	
802.05.07	-	0.70	
802.05.08	-	0.80	
802.05.09	-	0.90	
802.05.10	-	1.00	

06 UNITS

9	SHIM - VOLVO ELETRONIC UNIT		
CALZO TOBERA UNIDAD ELETRONICA VOLVO			
Ø Int.: 3.30 Ø Ext.: 7.70			
ROBIEL CODE	REFERENCE	THICKNESS(mm)	
804.07.010	-	0.10	
804.07.015	-	0.15	
804.07.025	-	0.25	
804.07.030	-	0.30	
804.07.050	-	0.50	
804.07.060	-	0.60	
804.07.070	-	0.70	

06 UNITS

R4

ADJUSTMENT SHIM - VOLVO EXHAUST VALVE (VEB)
 CALZO AJUSTE VALVULA ESCAPE VOLVO



ROBIEL CODE	REFERENCE	THICKNESS(mm)	ROBIEL CODE	REFERENCE	THICKNESS(mm)
815.47.959	-	1.80	815.47.984	-	2.85
815.47.961	-	1.85	815.47.985	-	2.90
815.47.963	-	1.90	815.47.9851	-	2.95
815.47.965	-	1.95	815.47.986	-	3.10
815.47.967	-	2.00	815.47.987	-	3.15
815.47.968	-	2.05	815.47.988	-	3.20
815.47.969	-	2.10	815.47.989	-	3.25
815.47.970	-	2.15	815.47.990	-	3.30
815.47.971	-	2.20	815.47.991	-	3.35
815.47.972	-	2.25	815.47.992	-	3.40
815.47.973	-	2.30	815.47.993	-	3.45
815.47.974	-	2.35	815.47.994	-	3.50
815.47.975	-	2.40	815.47.995	-	3.55
815.47.976	-	2.45	815.47.996	-	3.60
815.47.977	-	2.50	815.47.997	-	3.65
815.47.978	-	2.55	815.47.998	-	3.70
815.47.979	-	2.60	815.47.999	-	3.75
815.47.980	-	2.65	815.47.1000	-	3.80
815.47.981	-	2.70	815.47.1001	-	3.85
815.47.982	-	2.75	815.47.1002	-	3.90
815.47.983	-	2.80	815.47.1003	-	3.95

02 UNITS



323.01.48

Nozzle Tester Adapter
D12D | D12C Volvo Unit
Adaptador prueba Tobera Unidad
Volvo D12D | D12C



323.01.49

Device for Removal
the Volvo Drive
Dispositivo para Extraccion Mando Volvo



323.02.12

Cleaning Brush
Cepillo de Limpieza
Ø 10.00mm



323.02.13

Cutting Oil
Aceite corte



323.01.3241

Rotating Vise W /
Indexer Pin
Morsa Giratoria con Pin index



324.13.271

Device to Remove the Delphi
Caterpillar Unit Puller Spring
Dispositivo para Extraccion Resorte Externo
Unidad Delphi / Caterpillar



324.15.01

Injectors and Units Repair
Bracket
Soporte para reparacion
de Inyectores y Unidades



324.15.05

Clamp Set for Units
Clip de las Unidades



323.01.671

Nut Wrench - Volvo
D12D | D13 Nozzle
Llave de la tuerca de Tobera
Volvo D12D | D13



323.50.12

Delphi EUI Serie A1 | A3 | E1 | E3
Tool kit
Kit de Herramientas Unidades Delphi A1 | A3 | E1 | E3



DELPHI EUI E3 UNIT

UNIDAD DELPHI EUI E3

FREIGHTLINER | CASCADIA
DETROIT SERIE 60 N3 14.0 L DDEC VI

UNIT CODE

41420202

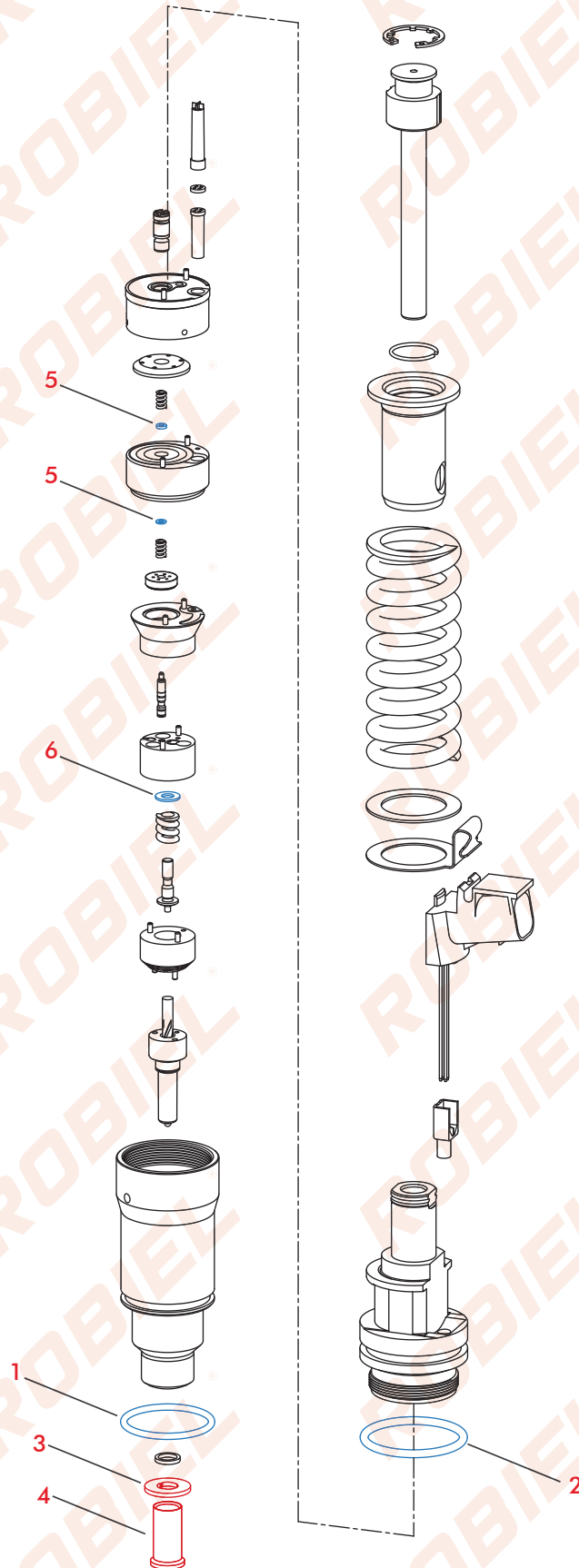

420.20.202		REPAIR RINGS SET - DELPHI E3/DETROIT S60 UNIT		
		REPARACION ANILLOS UNIDAD DELPHI E3/DETROIT S60		
APPLICATION		Volvo D12D D13D		
Nº	ROBIEL CODE	REFERENCE	DESCRIPTION	PACK
1	421.03.224	F 00H N37 149	O-ring - Anillo	01un.
2	421.03.530	-	O-ring - Anillo	01un.



SPARE PARTS
Repuestos

Nº	ROBIEL CODE	REFERENCE	DESCRIPTION	PACK
3	807.17.16	21.261.987	Washer - Volvo D13 Unit - Nozzle Arandela Tobera Unidad Volvo D13	24un.
4	220.03.08	-	Protective Cap - Injectors / Units Nozzle - 7.00mm Tapa Protectora p/ Tobera Inyectores / Unidades - 7.00mm	01kit.

3



∅ Ext: 17.40mm
Thickness: 1.60mm



4



5	SHIM - COIL - VOLVO FH13 INJECTOR		
	CALZO BOBINA INYECTOR VOLVO FH13		
	∅ Int.: 1.90 ∅ Ext.: 4.40		
	ROBIEL CODE	REFERENCE	THICKNESS(mm)
	801.05.015	-	0.15
	801.05.030	-	0.30
	801.05.050	-	0.50
	801.05.060	-	0.60
	801.05.070	-	0.70
	801.05.080	-	0.80
	801.05.090	-	0.90
	801.05.100	-	1.00
12 UNITS			

6	SHIM - VOLVO FH13 INJECTOR NOZZLE		
	CALZO DE LA TOBERA INYECTOR VOLVO FH13		
	∅ Int.: 4.60 ∅ Ext.: 9.30		
	ROBIEL CODE	REFERENCE	THICKNESS(mm)
	804.09.015	-	0.15
	804.09.025	-	0.25
	804.09.030	-	0.30
	804.09.050	-	0.50
	804.09.060	-	0.60
	804.09.070	-	0.70
12 UNITS			

DETROIT SERIE 60 N2 UNIT
UNIDAD DETROIT SERIE 60 N2

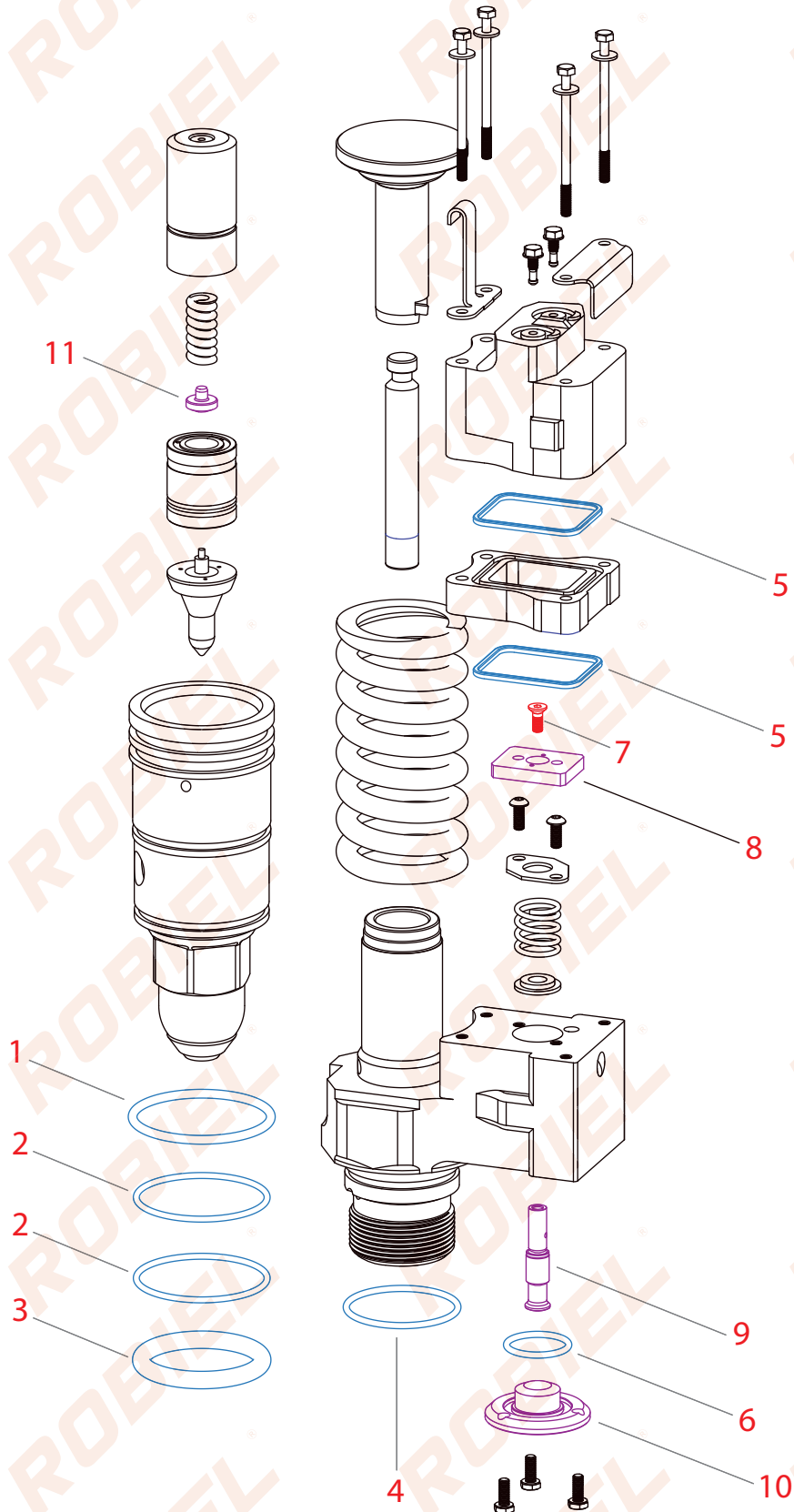

410.00.60 REPAIR PARTS - DETROIT SERIE 60 UNIT
 REPARACION UNIDAD DETROIT SERIE 60

REFERENCE		DP-52300010		
Nº	ROBIEL CODE	REFERENCE	DESCRIPTION	PACK
1	421.03.926	-	O-ring - Anillo	01un.
2	421.03.817	-	O-ring - Anillo	02un.
3	421.03.153	-	O-ring - Anillo	01un.
4	421.03.217	-	O-ring - Anillo	01un.
5	421.23.31	-	Profile Ring - Anillo Perfil	02un.
6	421.01.718	-	O-ring - Anillo	01un.





SPARE PARTS
 Repuestos

Nº	ROBIEL CODE	REFERENCE	DESCRIPTION	PACK	Qr Code
7	250.21.70	-	Bolt - MBB / Detroit Serie 60 Unit Armature Tornillo Placa Atraque Unidad MBB / Detroit Serie 60	06un.	

8 ARMATURE PLATE - DETROIT UNIT
 PLACA ATRAQUE UNIDAD DETROIT 

ROBIEL CODE	REFERENCE	THICKNESS(mm)
801.09.385	-	3.85
801.09.387	-	3.87
801.09.389	-	3.89
801.09.391	-	3.91
801.09.393	-	3.93
801.09.395	-	3.95

02 UNITS



9 ELEMENT - DETROIT UNIT VALVE
 ELEMENTO VALVULA UNIDAD DETROIT 

ROBIEL CODE	REFERENCE	THICKNESS(mm)
340.10.00	DP-5239015	7.000
340.10.05	-	7.005
340.10.10	-	7.010
340.10.15	-	7.015

01 UNIT



10 PLUG - DETROIT UNIT
 TAPON DE LA UNIDAD DETROIT 

ROBIEL CODE	REFERENCE	THICKNESS(mm)
165.05.668	-	6.68
165.05.671	-	6.71
165.05.674	-	6.74

01 UNIT



11 PIN - DETROIT UNIT NOZZLE
 TOP DE LA TOBERA UNIDAD DETROIT 

ROBIEL CODE	REFERENCE	THICKNESS(mm)
305.01.310	-	3.10 mm
305.01.315	-	3.15 mm
305.01.320	-	3.20 mm
305.01.325	-	3.25 mm

01 UNIT



323.01.3241
 Rotating Vise W /
 Indexer Pin
 Morsa Giratoria con Pin index 



324.15.01
 Injectors and Units
 Repair Bracket
 Soporte para reparacion
 de Inyectores y Unidades 



323.50.043
 Detroit EUI 60 Series N2DD2 IV
 - Bosch EUI/EUP Valve
 Changeover Kit
 Kit de Herramientas Unidades Detroit
 EUI 60 Series N2DD2 IV - Bosch
 EUI/EUP - Troca de la Valvula 



323.50.29
 Detroit EUI 60 Series N2DD2 IV
 Tool Kit
 Kit de Herramientas Unidades Detroit
 EUI Serie 60 N2DDE IV 



BOSCH EUI E1 UNIT
UNIDAD BOSCH EUI E1

FREIGHTLINER | COLUMBIA
DETROIT SERIE 60 N3 14.0 L DDEC V

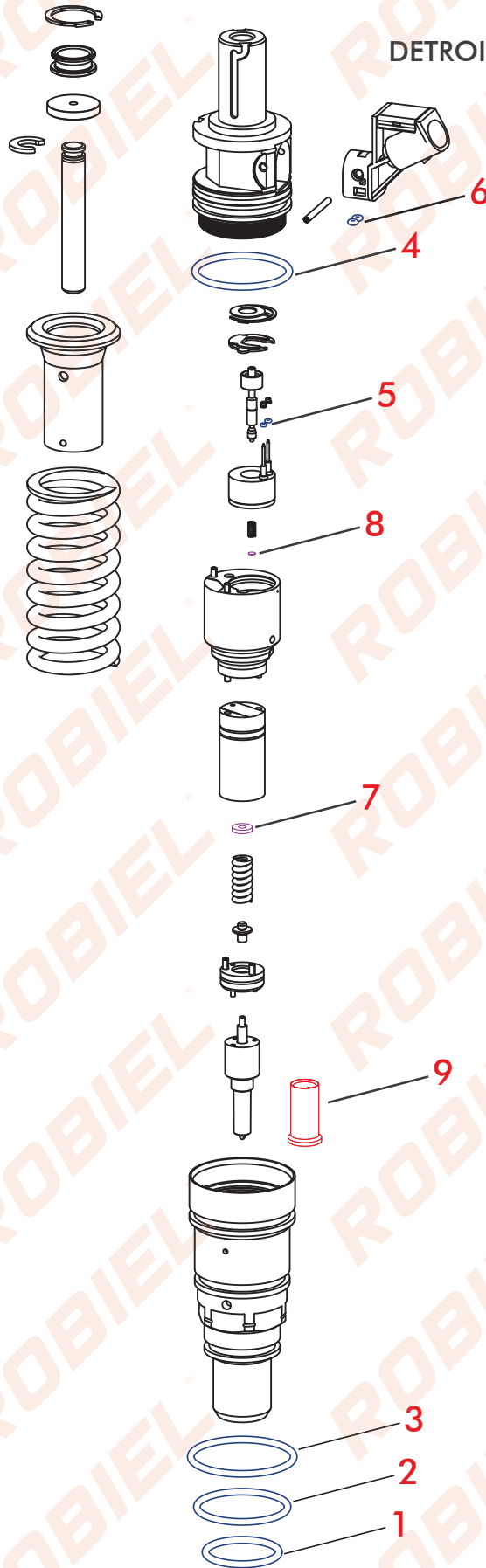

UNIT CODE
0 414 703 003



420.37.111		REPAIR RINGS SET - E1/DETROIT S60 UNIT NUT		
REFERENCE		A-23537111		
Nº	ROBIEL CODE	REFERENCE	DESCRIPTION	PACK
1	421.02.726	-	O-ring - Anillo	01un.
2	421.03.426	-	O-ring - Anillo	01un.
3	421.03.926	-	O-ring - Anillo	01un.

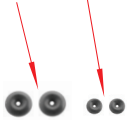

420.37.112		REPAIR RINGS SET - BOSCH E1/DETROIT S60 UNIT		
REFERENCE		A-23537111		
Nº	ROBIEL CODE	REFERENCE	DESCRIPTION	PACK
1	421.02.726	-	O-ring - Anillo	01un.
2	421.03.426	-	O-ring - Anillo	01un.
3	421.03.926	-	O-ring - Anillo	01un.
4	421.03.726	-	O-ring - Anillo	01un.
5	421.00.071	-	Lower connector ring - Anillo Conector Inferior	02un.
6	421.00.072	-	Top connector ring - Anillo Conector Superior	02un.

420.22.009		REPAIR RINGS SET - IVECO/ EURO V UNIT CONNECTOR		
REFERENCE		A-23537111		
Nº	ROBIEL CODE	REFERENCE	DESCRIPTION	PACK
5	421.00.071	-	Lower connector ring - Anillo Conector Inferior	12un.
6	421.00.072	-	Top connector ring - Anillo Conector Superior	12un.



SPARE PARTS
Repuestos

Nº	ROBIEL CODE	REFERENCE	DESCRIPTION	PACK
9	220.03.08	-	Protective Cap - Injectors / Units Nozzle - 7.00mm <i>Tapa Protectora p/ Tobera Inyectores / Unidades - 7.00mm</i>	01kit.

