

DSCS SERIES

RE-VERBER-RAY
by Detroit Radiant Products Company

Designer Series

GAS-FIRED, HIGH INTENSITY INFRARED PATIO HEATER

Ideal solution to stylishly extend the outdoor season for many commercial and residential applications.

Specifically designed for comfort, reliability and ease of installation, the DSCS Series high-intensity patio heater is designed to provide outdoor comfort heating.



PRODUCT FEATURES

- Decorative stainless egg crate grille
- Wind- and rain-protected design
- Reliable direct-spark ignition
- Available in two BTU inputs
- Potted (water resistant) 24V circuitry

BENEFITS OF HEATING WITH INFRARED









- Superior Comfort
- Reduced Energy Consumption
- Flexibility
- Durability
- Radiant Efficiency
- Even level of heat distribution
- Versatile mounting options
- Black-coated aluminized or brushed stainless steel housing
- ETL Design Certified to ANSI Z83.26 Standard

DSCS SERIES

GAS-FIRED, HIGH INTENSITY INFRARED PATIO HEATER



PRODUCT SPECIFICATIONS

	Input Range: 31,000 to 34,000 BTU/h		Housing: Black Powder-Coated Aluminized or 430 Series Brushed Stainless Steel
	Length: 48.4"		Certification: ETL Design Certified for Outdoor use
	Gas Type: Natural (6.0" W.C.) or Propane (10.0" W.C.)		Limited Warranty: 1 year (Components) - 5 years (Ceramic Burner)
	Mounting Options: Chains, Threaded Rod, Hangers, or Optional Mounting Bracket		Electrical: 24VAC; 60 Hz with field supplied NEC Class 2 transformer. 24V Control. Amps: 0.65 Starting, 0.48 Running

AVAILABLE DSCS MODELS & CLEARANCES

MODEL #	HOUSING ¹	GAS ²	BTU/h INPUT	APPROX. AREA HEATED	WEIGHT	MOUNTING HEIGHTS	CLEARANCES TO COMBUSTIBLES (INCHES)	MOUNTING ANGLE	SIDE	TOP	BELOW
DSCS-31	STND	Nat or Prop	31,000	8' x 8'	59 lbs	8' to 12'		0°	18	13	48
DSCS-34	STND	Nat	34,000	9' x 9'	59 lbs	8.5' to 13'		0°	18	13	48
DSCS-31-SS	430 SS	Nat or Prop	31,000	8' x 8'	59 lbs	8' to 12'		0°	18	13	48
DSCS-34-SS	430 SS	Nat	34,000	9' x 9'	59 lbs	8.5' to 13'		0°	18	13	48

¹ STND= Black powder-coated aluminized steel; 430 SS= 430 Series brushed stainless steel.

² Specify natural (Nat) or propane (Prop) gas.

³ Refer to DSCS Manual for additional information about clearances for 30° Mounting Angle.

Important! If the heater is mounted beneath a non-combustible surface an 8 in. minimum top clearance must be maintained from the top of the heater to prevent overheating the controls.

Clearance to combustible distances represent a surface temperature of 90°F (32°C) above ambient temperature. Ensure that building materials with a low heat tolerance (i.e. awnings, fabrics, plastics, sprinklers, insulation) are protected against degradation. This may require the heater to be mounted at a distance in excess of the published clearances to combustibles. Contact the factory or the building material manufacturer for additional information.

Always maintain the published clearances to combustibles. Not for indoor residential use. Clearances published in DSCS Series manual and on warning label supersede data shown on this brochure.

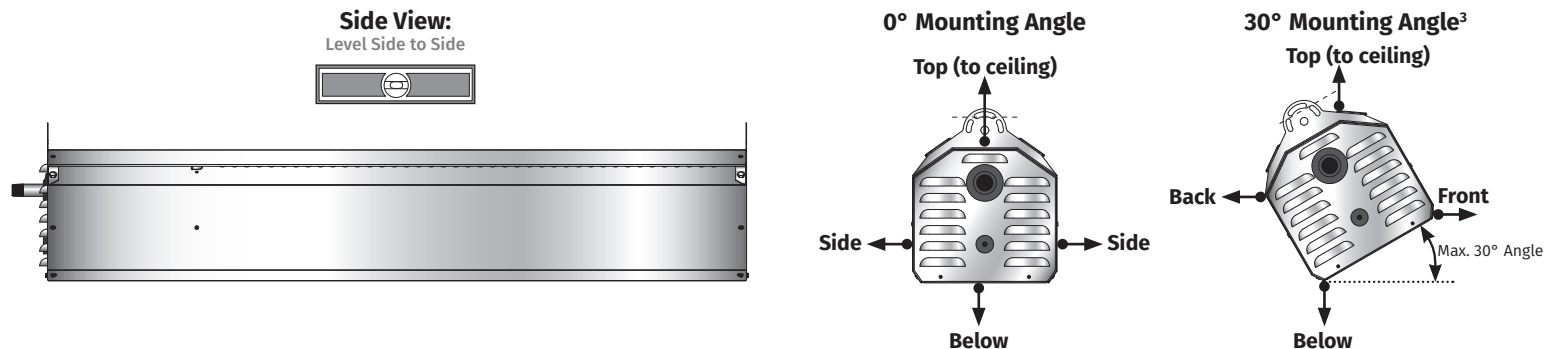

21400 Hoover Road, Warren, Michigan 48089 USA
+1.586.756.0950 | sales@drp-co.com

www.REVERBERRY.com



Form No. LBDSCS-1M-0418 (PM)

