

# CATALOG 2022/23

USB-USA CATALOG 2022/23

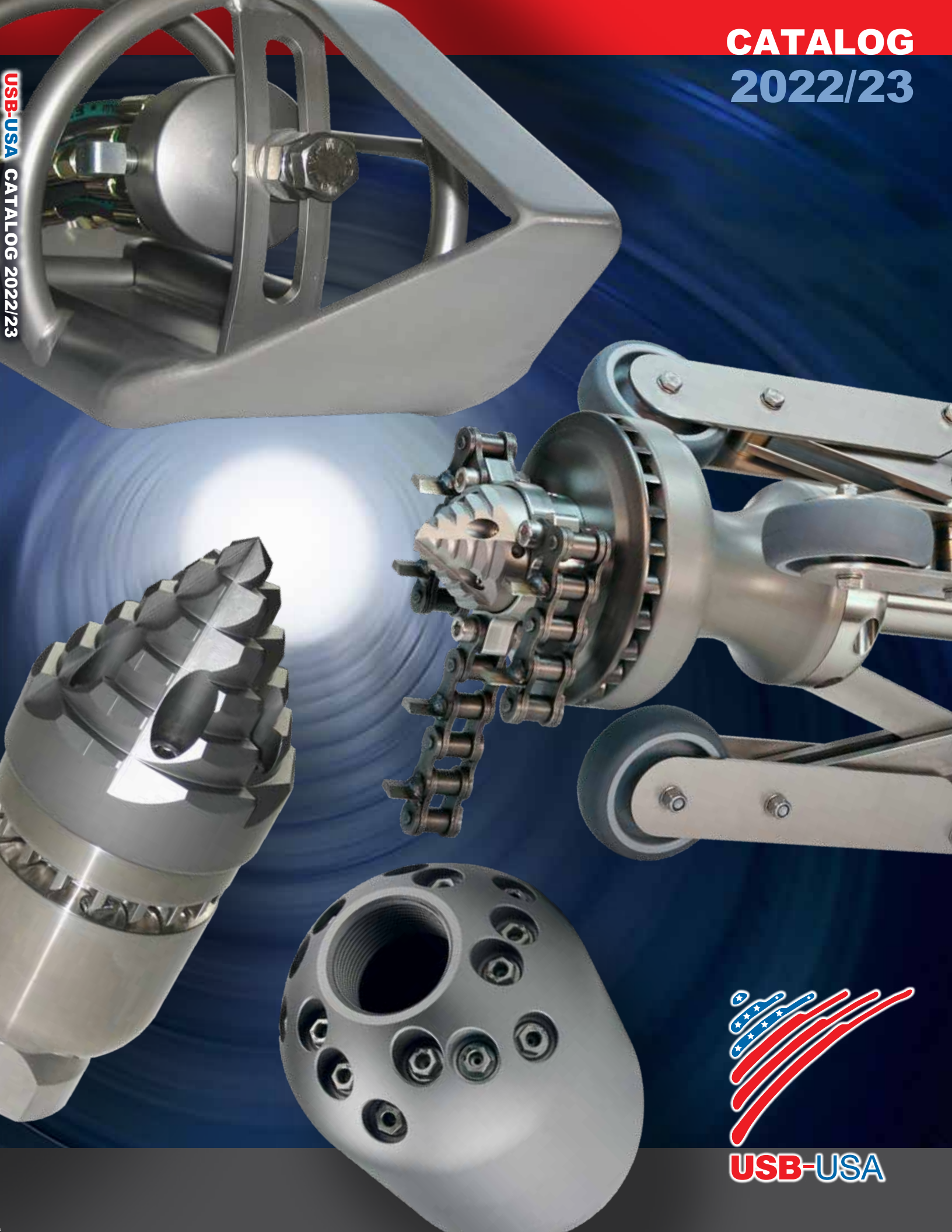

**USB-USA**

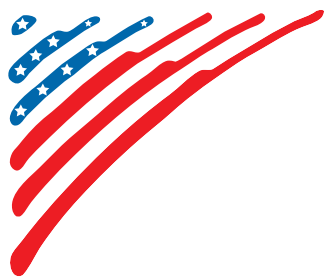

**USB-USA**

1-844-285-5770 | [info@usb-usa.com](mailto:info@usb-usa.com)

## Generations of Craftsmanship

USB Duesen GmbH a family owned, and operated German manufacturing business partnered with Patrick Savio in the United States to form USB-USA LLC. Strategically located in metro Atlanta, GA., USB-USA services municipalities, contractors and distributors across North, South and Central America. USB-USA specializes in providing high-quality stainless-steel sewer and pipe cleaning nozzles with 3D fluid mechanics, Turbo Chain Cutters and accessories.

USB Duesen is ISO 9001:2015 certified and has been manufacturing high-grade stainless-steel sewer cleaning equipment for over 25 years. These valuable years of experience combined with endless field tests, scientific evidence and patented protected ideas produce innovative, long lasting, durable equipment. State-of-the art 5 axis CNC machines are maintained at the highest quality standard to ensure the output is consistent and precise. USB Duesen strives to continually improve and develop their products for success in the field across the globe!



# ALL PRODUCTS

## Bottom Cleaner



Storm Surge 3D  
Page 08



Bagger Max 3D  
Page 09



3D Flounder Nozzle  
Page 10



Speed Power 3D  
Page 11



Venturi Nozzle  
Page 12

## Cleaning Nozzles



Cycle Nozzle 3D  
Page 13



Super Cycle 3D  
Page 14



Combinator 3D  
Page 15



Rocket Large 3D  
Page 16



3D Radial Clean Nozzle  
Page 17



Tri-Jet 3D  
Page 18



3D Cleaning Nozzle  
Page 19



Rocket Nozzle 3D  
Page 20



Radi 70 3D  
Page 21



Egg Nozzle 3D  
Page 22



FS Nozzle 3D  
Page 23



Super 12  
Page 24



Standard Nozzle  
Page 25



Chisel Nozzle  
Page 26



Radial Chisel Nozzle  
Page 27



3D Extreme  
Page 28



FD2 Nozzle 3D  
Page 29



Digger Nozzle  
Page 30

## Rotating/Vibrating Nozzles



Primus Nozzle I  
Page 31



Primus Nozzle II  
Page 31



Primus Nozzle III  
Page 31



Primus Antiblaster II 3D  
Page 32



Primus Antiblaster III 3D  
Page 32



Rotor Nozzle  
Page 33



Front Push Rotor  
Page 34



T-Hammer  
Page 35



V-Hammer  
Page 36



Mini-Gator // Gator  
Page 37

## Root Cutters



Mini-Cutters  
Page 38



Turbo 0  
Page 39



Turbo 1  
Page 40



Turbo II Rigid  
Page 43



Turbo II  
Page 45



Turbo S400  
Page 47



Turbo III  
Page 49



Turbo S-200  
Page 51



Turbo S-600  
Page 53



Turbo IV  
Page 55



Turbilkit 3D  
Page 57



Pipe Wolf Nozzle 3D  
Page 58



Diamond Face Cutter  
Page 59



Rotor Wolf  
Page 60



Beaver  
Page 61

## XL Profile and Inspection Equipment



Radial Flex Skid  
Page 62



Handy Cart  
Page 63



Elbow Flex Skid  
Page 64



NOZZCAM™ Inspection Equipment  
Page 65

## Speciality and Oversized Nozzles



Spin-Jet  
Page 66



Steering Nozzle  
Page 67



Antiblaster  
Page 68



Oversized Nozzles  
Page 69

## Accessories



High Pressure Swivel  
Page 70



Crown Nozzle  
Page 71



Uni-Flex Skid  
Page 72



Reducers / Collars  
Page 73



Tools / Accessories  
Page 74

## Nozzle Inserts



Nozzle Inserts  
Page 75

# APPLICATIONS

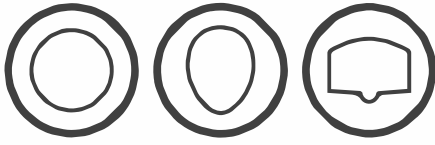

Large and Special Profile



Handy Cart Page 63  
 Radial Flex Skid Page 62  
 Eibow Flex Skid Page 64



Oversized Nozzles Page 69



Large Debris, Rocks, Mud, Sand, Silt



Storm Surge 3D Page 08  
 Bagger Max 3D Page 09  
 3D Flounder Nozzle Page 10  
 Speed Power 3D Page 11  
 Venturi Nozzle Page 12



Rocket Nozzle 3D Page 20  
 Rocket Large 3D Page 16  
 Cycle Nozzle 3D Page 13  
 Super Cycle 3D Page 14



Roots



Mini-Gator // Gator Page 37



Primus HD Page 31  
 Turbos Page 39-56  
 Turbikit Page 57  
 Pipe Wolf Nozzle 3D Page 58  
 Rotor Wolf Page 60  
 Beaver Page 61



Grease, Fats



Primus I Page 31  
 Primus II Page 31  
 Primus III Page 31  
 Primus Antiblaster Page 32  
 Mini-Gator // Gator Page 37



3D Radial Clean Nozzle Page 17  
 Radi 70 3D Page 21  
 Radial Chisel Nozzle Page 27



Beaver Page 61



Preventative Maintenance



Primus I Page 31  
 Primus II Page 31  
 Primus III Page 31  
 Primus Antiblaster Page 32  
 Rotor Nozzle Page 33  
 Mini-Gator // Gator Page 37  
 NOZZCAM™ Page 65



Combinator 3D Page 15  
 Radial Clean 3D Page 17  
 Tri-Jet 3D Page 18  
 3D Cleaning Nozzle Page 19  
 Egg Nozzle 3D Page 22  
 Cycle Nozzle 3D Page 13  
 Super Cycle 3D Page 14

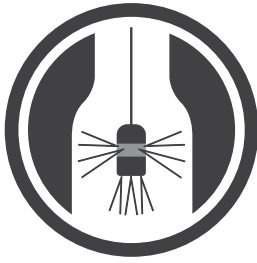

Manholes



Spin-Jet

Page 66



Half or completely open Drain Pipes



FD2 Nozzle 3D

Page 29



Mineral Deposits, Calcium, Scale



Diamond Face Cutter Page 59

Turbikit Page 57

Turbos Page 39-56



T-Hammer Page 35

V-Hammer Page 36



Protruding Laterals or Pipes



Turbo Flexible Page 45-56  
w/ barrel cutter



Toilet safe



Antiblaster

Page 68

# STORM SURGE 3D



3006



3008













3010



3012



3014

 P/N	 Hose Con.	 Minimum/GPM	 Pipe Diameter	 Dimensions	 Weight	 Rear Jets	 Front Jets	 Radial Jets	 Tier
3006	¾" - 1"	30	12" - 15"	20.80" x 8.10"	39	6	—	—	3
3008	1" - 1¼"	40	15" - 30"	20.80" x 9.00"	49	8	—	—	3
3010	1" - 1¼"	60	18" - 40"	20.80" x 11.3"	59	10	—	—	3
3012	1" - 1¼"	80	20" - 80"	20.80" x 11.8"	64	12	—	—	3
3014	1" - 1¼"	80	20" - 96"	20.80" x 11.8"	68	14	—	—	3









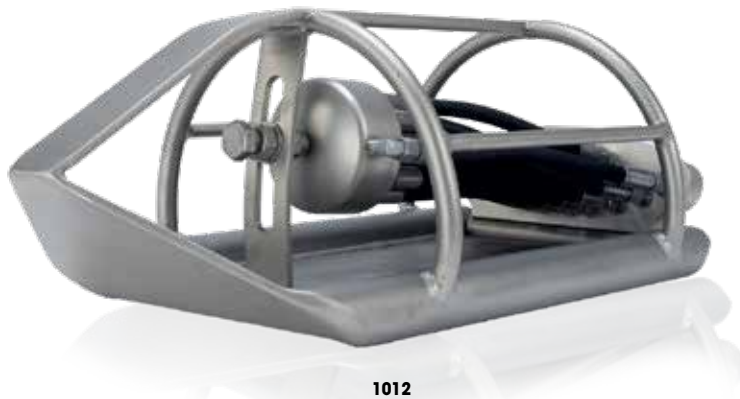

## Outstanding excavation, traction and transportation

A highly efficient floor cleaner made of hardened stainless steel, the **Storm Surge 3D** nozzle has a built-in power manifold with fixed jets and 3D fluid mechanics that produce an intense and forceful jet pattern resulting in outstanding excavation, traction and transportation of material—even under water! Roll-over bars enable this nozzle to return to its correct position every time. One-piece ceramic inserts and a high-pressure swivel come standard on this nozzle.



# BAGGER MAX 3D



 P/N	 Hose Con.	 Minimum/GPM	 Pipe Diameter	 L x W Dimensions	 lbs. Weight	 Rear Jets	 Front Jets	 Radial Jets	 # Tier
1010	1½"	120	40" - 196"	32.28" x 17.32"	167	14	—	—	3
1012	1", 1¼"	80	32" - 120"	30.00" x 12.00"	115	12	—	—	3
1013	1", 1¼"	80	24" - 72"	22.80" x 10.00"	79	10	—	—	3
1015	1"	40	15" - 48"	19.68" x 8.66"	53	8	—	—	3
1017	1"	40	10" - 30"	15.74" x 7.87"	46	6	—	—	3
1018	¾"	35	10" - 30"	15.74" x 7.87"	33	6	—	—	3











## Forceful jet pattern and adjustable nozzle block

A high efficiency floor cleaner made of hardened stainless steel, the **Bagger Max 3D** nozzle includes an adjustable nozzle block that can be positioned vertically between 0° - 30° depending on your application. The power manifold has built in 3D fluid mechanics that produce an intense and forceful jet pattern resulting in outstanding excavation, traction and transportation of material—even under water! Roll over bars enable this nozzle to return to its correct position every time. One-piece ceramic inserts and a high-pressure swivel come standard on this nozzle.

# FLOUNDER 3D



1378

 P/N	 Hose Con.	 Minimum/GPM	 Pipe Diameter	 L x W Dimensions	 lbs. Weight	 Rear Jets	 Front Jets	 Radial Jets	 # Tier
1377	1", 1 1/4"	80	15" - 60"	10.62" x 7.08"	37,47	10	---	---	3
1378	1"	50	12" - 40"	8.66" x 5.90"	20,94	8	---	---	3
1380	3/4"	30	10" - 24"	7.08" x 3.93"	9,5	6	---	---	3
1381	1/2"	12	4" - 12"	5.90" x 3.54"	6,61	4	---	---	3
1382	3/8"	6	2" - 4"	3.93" x 2.75"	2,2	4	---	---	3

## Ideal for cleaning sand, mud and gravel

Flat, compact, heavy and wedge-shaped, the **Flounder 3D** nozzle is ideal for cleaning sand, dirt, mud, gravel and other material at the bottom of the pipe. The overall design, in combination with the 3D fluid mechanics, makes the cleaning process fast and effective.











# SPEED POWER 3D



1030

1035

1038

 P/N	 Hose Con.	 Minimum/GPM	 Pipe Diameter	 Dimensions	 Weight	 Rear Jets	 Front Jets	 Radial Jets	 Tier
1030	1", 1 1/4"	80	15" - 60"	19.68" x 7.87"	106	8	---	---	3
1035	1", 1 1/4"	80	12" - 40"	16.53" x 6.29"	66	8	---	---	3
1038	1"	60	10" - 32"	13.77" x 5.51"	49	6	---	---	3

## Perfect for oval and egg-shaped pipes

The **Speed Power 3D** is a heavy spherical and ellipsoid-shaped high-efficiency floor cleaner for oval or egg-shaped pipes. The 3D fluid mechanics create a powerful jet pattern that is mainly directed towards the pipe bottom to move heavy debris. The nozzle is constructed of hardened stainless steel and comes standard with one-piece ceramic inserts and a high-pressure swivel.











# VENTURI NOZZLE



2704



2702

 P/N	 Hose Con.	 Minimum/GPM	 Pipe Diameter	 L x W Dimensions	 lbs. Weight	 Rear Jets	 Front Jets	 Radial Jets	 # Tier
2704	1", 1 ¼"	80	48" and 120"	27.16" x 15.74"	101,41	2	—	—	2
2702	1", 1 ¼"	80	32" - 60"	27.55" x 15.74"	92,59	1	—	—	2
2700	1"	60	32" - 48"	25.59" x 11.81"	59,52	1	—	—	2

## Clean large sewer pipes with continuous flow

USB has designed a specialized nozzle to clean large sewer pipes with continuous flow. The **Venturi Nozzle** creates a constriction within the pipe that varies the flow of fluids (the Venturi effect), enabling it to clean and move large volumes of sand, mud, sludge, gravel and other debris out of the pipe. The Venturi nozzle comes standard with a high-pressure swivel. Available in two models.

**NOTE: The nozzle must be completely submerged in water when operating.**











# CYCLE NOZZLE 3D



3002



3002

 P/N	 Hose Con.	 Minimum/GPM	 Pipe Diameter	 L x W Dimensions	 lbs. Weight	 Rear Jets	 Front Jets	 Radial Jets	 # Tier
3001	3/4"	50	8" - 20"	7.00" x 3.8"	11	8	---	---	3
3002	1"	60	8" - 20"	7.00" x 3.8"	11	8	---	---	3
3003	1 1/4"	80	8" - 20"	7.00" x 3.8"	11	8	---	---	3

## Spray angles for pipe cleaning and maintenance (12°/20°)

Produced from hardened stainless steel, the **Cycle Nozzle 3D** includes 3D fluid mechanics and two different rear spray angles of 12°/20°. These spray angles are ideal for general pipe cleaning and preventative maintenance work. This nozzle comes standard with one-piece ceramic inserts.

# SUPER CYCLE NOZZLE 3D



P/N	Hose Con.	Minimum/GPM	Pipe Diameter	L x W Dimensions	lbs. Weight	Rear Jets	Front Jets	Radial Jets	# Tier
3000	1"	60	10" - 40"	7.80" x 4.20"	17,5	12	---	---	3
2999	1¼"	80	10" - 40"	7.80" x 4.20"	17,5	12	---	---	3

## 12 rear jets ideal for large pipes

The **Super Cycle Nozzle 3D** is a large, heavy-weight nozzle constructed from hardened stainless steel with 12 rear jets. Set at spray angles of 12° and 28°, the rear jets make this nozzle ideal for cleaning sewer, storm or other large pipes. Its powerful jet pattern and 3D fluid mechanics are excellent for flushing dirt from roots before cutting or general cleaning. This nozzle comes standard with one-piece ceramic inserts.











# COMBINATOR 3D



1186



1186

 P/N	 Hose Con.	 Minimum/GPM	 Pipe Diameter	 L x W Dimensions	 lbs.	 Rear Jets	 Front Jets	 Radial Jets	 #
1182	1", 1 1/4"	80	15" - 48"	7.87" x 4.72"	23,14	12	---	---	3
1186	1"	60	10" - 32"	7.08" x 4.33"	17,63	10	---	---	3
1187	1"	60	8" - 20"	6.10" x 3.93"	12,12	8	---	---	3
1188	3/4"	35	8" - 20"	6.10" x 3.93"	12,12	8	---	---	3

## Spray angles for pipe cleaning and maintenance (15° /25°)

The **Combinator 3D** nozzle is produced from hardened stainless steel and includes 3D fluid mechanics and two different rear spray angles of 15° /25°. These spray angles are ideal for general pipe cleaning and preventative maintenance work. This nozzle comes standard with one-piece ceramic inserts.

# ROCKET LARGE 3D



1157



1154

P/N	Hose Con.	Minimum/GPM	Pipe Diameter	L x W Dimensions	lbs. Weight	Rear Jets	Front Jets	Radial Jets	# Tier
1152	1½"	110	16" - 48"	10.23" x 6.29"	44,09	12	---	---	3
1154	1", 1¼"	80	12" - 32"	7.87" x 4.72"	20,94	10	---	---	3
1156	1"	60	10" - 24"	7.08" x 4.33"	17,63	8	---	---	3
1157	1"	60	8" - 20"	6.10" x 3.93"	11,46	8	---	---	3
1158	¾"	35	8" - 15"	6.10" x 3.93"	11,46	8	---	---	3

## Rocket-like power!

The tight spray angle of 7° combined with one piece-ceramic inserts and 3D fluid mechanics produce incredible results. Constructed from hardened stainless steel, the **Rocket Nozzle 3D Large** has a powerful jet pattern can flush dirt, mud, rocks and other large or heavy material found in sewer or storm pipes.



# 3D RADIAL CLEAN NOZZLE













P/N	Hose Con.	Minimum/GPM	Pipe Diameter	L x W Dimensions	lbs.	Rear Jets	Front Jets	Radial Jets	#
1191	1½"	110	12" - 24"	12.40" x 7.48"	79,36	6	---	12	3
1190	1", 1¼"	80	10" - 20"	7.87" x 4.72"	20,94	5	---	10	3
1194	1"	60	8" - 15"	6.10" x 3.93"	12,12	6	---	6	3
1195	¾"	30	6" - 12"	4.92" x 3.14"	6,17	5	---	5	3

## Powerful spray pattern leaves no streaks behind

Streaks are a thing of the past with the **3D Radial Clean Nozzle**! 3D fluid mechanics deliver smooth water to the rear 45° fan jets, creating a powerful 360° spray pattern capable of removing grease, scale, dirt and sand from pipe walls—without leaving streaks behind. The additional rear 15° propulsion jets move the nozzle up the line and help transport material back to the manhole. This high-performing nozzle is perfect before CCTV inspection.

# TRI-JET 3D











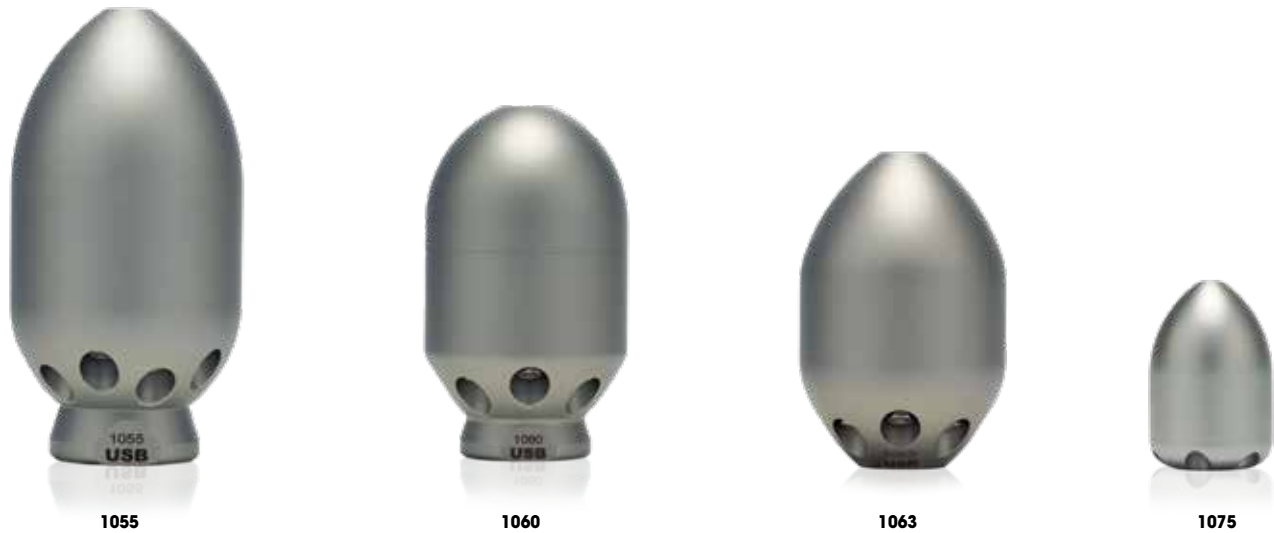

 P/N	 Hose Con.	 Minimum/GPM	 Pipe Diameter	 L x W Dimensions	 Weight	 Rear Jets	 Front Jets	 Radial Jets	 Tier
1225	1½"	110	16" - 48"	10.23" x 6.29"	44,09	15	---	---	3
1220	1", 1¼"	80	12" - 40"	7.87" x 4.72"	23,14	15	---	---	3
1218	1"	80	10" - 32"	7.08" x 4.33"	17,63	15	---	---	3
1213	1"	60	8" - 20"	6.10" x 3.93"	12,12	12	---	---	3
1213AL	1"	60	8" - 20"	6.10" x 3.93"	6,00	12	---	---	3
1210	¾"	50	4" - 12"	4.92" x 2.75"	4,85	12	---	---	3

## A high-performance nozzle with options

The **Tri-Jet 3D**, available in aluminum or stainless steel, makes use of three different optimal rear spray angles, 7°/14°/21°. As an option, one of the spray angles can be blocked off all the way around the nozzle to focus the cleaning process on pulling, flushing or cleaning with the remaining two spray angles. This nozzle comes standard with one-piece ceramic inserts.

# 3D CLEANING NOZZLE



 P/N	 Hose Con.	 Minimum/GPM	 Pipe Diameter	 L x W Dimensions	 lbs.	 Rear Jets	 Front Jets	 Radial Jets	 Tier
1052	1"	60	8" - 24"	7.08" x 3.14"	8,81	10	1	----	3
1055	1"	60	8" - 24"	4.72" x 3.14"	6,17	10	1	----	3
1060	1"	50	6" - 15"	4.92" x 2.75"	4,85	8	1	----	3
1063	3/4"	30	6" - 10"	4.13" x 2.75"	3,96	8	1	----	3
1070	3/4"	30	6" - 10"	3.74" x 2.36"	2,64	8	1	----	3
1062	1/2"	18	4" - 8"	4.13" x 2.75"	3,96	6	1	----	3
1071	1/2"	18	4" - 8"	3.74" x 2.36"	2,64	6	1	----	3
1075	1/2"	12	4" - 8"	2.36" x 1.57"	0,66	6	1	----	3

## Rear-spraying angles and a forward-spraying jet

Hardened stainless steel construction with 3D fluid mechanics and two different rear-spraying angles of 15° /25° make this **3D Cleaning Nozzle** ideal for general pipe cleaning and preventative maintenance work. A forward-spraying jet is also included. This nozzle comes standard with one-piece ceramic inserts.

# ROCKET NOZZLE 3D

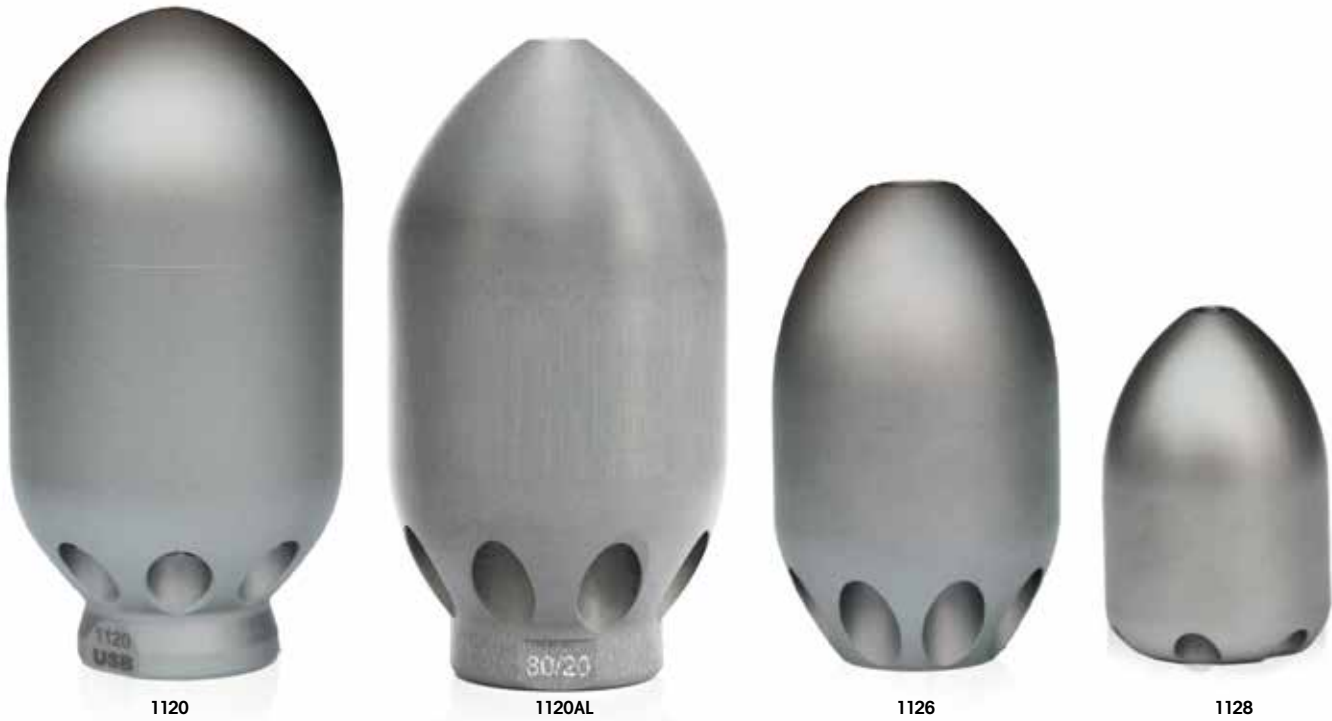

P/N	Hose Con.	Minimum/GPM	Pipe Diameter	L x W Dimensions	lbs. Weight	Rear Jets	Front Jets	Radial Jets	# Tier
1121	1"	50	6" - 24"	4.92" x 3.14"	7.27	10	---	---	3
1120	1"	50	6" - 15"	4.92" x 2.75"	4.85	8	---	---	3
1120AL	1"	50	6" - 15"	4.92" x 2.75"	2.00	8	---	---	3
1126	3/4"	30	6" - 12"	3.74" x 2.36"	2.64	8	1	---	3
1128	1/2"	12	4" - 8"	2.36" x 1.57"	0.66	6	1	---	3

## Small but powerful

The **Rocket Nozzle 3D** has a tight spray angle of 7°. This combined with the one piece-ceramic inserts and 3D fluid mechanics, produces incredible pulling power. Constructed from hardened stainless steel, the powerful jet pattern can flush dirt, mud, rocks and any other large heavy material you may find in sewer or storm pipes. "The 1" Rocket nozzle is also available in aluminum for hilly difficult terrain".

# RADI 70 3D













1112



1114



1117

 P/N	 Hose Con.	 Minimum/GPM	 Pipe Diameter	 L x W Dimensions	 lbs.	 Rear Jets	 Front Jets	 Radial Jets	 #
1112	1"	80	10" - 32"	7.08" x 3.14"	9,70	10	1	10	3
1114	1"	60	6" - 24"	5.11" x 2.75"	4,85	8	1	8	3
1115	3/4"	30	6" - 12"	3.74" x 2.36"	2,64	8	1	8	3
1117	1/2"	18	4" - 8"	2.36" x 1.57"	0,66	6	1	6	3

## Multiple spray angles blast materials away

3D fluid mechanics and multiple spray angles, including jets that are 70° perpendicular to the interior wall of the pipe, enable the **RADI 70 3D** to blast material off the pipe wall. The two remaining two spray angles of 15°/25° effectively propel the nozzle and clean the pipe. This nozzle comes standard with one-piece ceramic inserts.

# EGG NOZZLE 3D



P/N	Hose Con.	Minimum/GPM	Pipe Diameter	L x W Dimensions	lbs.	Rear Jets	Front Jets	Radial Jets	#
1081	1"	50	6" - 12"	4.13" x 2.75"	3,74	8	1	----	3
1082	3/4"	30	6" - 10"	2.75" x 1.96"	1,76	8	1	----	3
1083	1/2"	12	4" - 8"	2.16" x 1.57"	0,44	6	1	----	3
1084	3/8"	8	4" - 6"	1.96" x 1.37"	<0,44	5	1	----	2
1085	1/4"	6	2" - 4"	1.57" x 1.18"	<0,44	6	1	----	2
1086	1/8"	3	2" - 4"	0.78" x 0.62"	<0,44	3	1	----	1
1087	1/8"	3	2" - 4"	0.78" x 0.62"	<0,44	3	1	----	1

## Designed for easy mobility and powerful cleaning

With its contoured egg-shaped design and 20° rear propulsion jets, the **Egg Nozzle 3D** is designed to slide easily down the pipe. 3D fluid mechanics and one-piece ceramic inserts deliver water that efficiently and effectively cleans while propelling the nozzle.

# FS NOZZLE 3D



P/N	Hose Con.	Minimum/GPM	Pipe Diameter	L x W Dimensions	lbs. Weight	Rear Jets	Front Jets	Radial Jets	# Tier
1172	1"	60	6" - 15"	4.13" x 2.75"	3,74	8	4	----	3
1173	3/4"	30	6" - 12"	2.95" x 1.96"	1,54	8	4	----	3
1174	1/2"	14	4" - 8"	2.36" x 1.57"	0,66	6	4	----	3
1175	3/8"	8	2" - 4"	1.96" x 1.37"	0,44	5	4	----	2
1176	1/4"	6	2" - 4"	1.57" x 1.18"	0,22	6	4	----	2









## A penetrating nozzle that opens tough blockages and slides with ease

Designed to penetrate pipes with tough blockages, the **FS Nozzle 3D** is made from hardened stainless steel and features 3D fluid mechanics and four forward-facing one-piece ceramic inserts at 0° /15°. The 20° rear propulsion jets combined with the smooth egg shape enables the nozzle to slide easily down the pipe.

# SUPER 12



1205

 P/N	 Hose Con.	 Minimum/GPM	 Pipe Diameter	 Dimensions	 Weight	 Rear Jets	 Front Jets	 Radial Jets	 Tier
1205	1/2"	14	2" - 4"	1.96" x 1.18"	<1.0	12	1	---	2

## A small nozzle that packs a punch—and navigates tight corners

Don't be fooled by its small size, the **Super 12** gets the job done. The 12 rear propulsion jets are more than any other 1/2" nozzle in our inventory. And the 15° spray angle makes this nozzle ideal for use around tight corners.



# STANDARD NOZZLE



1256













1260



1255



1262

 P/N	 Hose Con.	 Minimum/GPM	 Pipe Diameter	 L x W Dimensions	 Weight	 Rear Jets	 Front Jets	 Radial Jets	 Tier
1251	1 1/4"	80	8" - 12"	3.14" x 2.36"	2,2	10	1	---	2
1256	1"	50	6" - 12"	3.14" x 2.16"	1,76	10	1	---	2
1255	1"	50	6" - 12"	2.04" x 2.28"	1,5	12	4	---	2
1257	3/4"	30	6" - 8"	2.55" x 1.69"	0,88	8	1	---	2
1259	3/4"	30	6" - 8"	2.55" x 1.69"	0,88	6	1	---	2
1260	1/2"	12	4" - 6"	1.18" x 1.96"	0,22	6	1	---	1
1262	1/2"	12	2" - 6"	1.06" x 1.25"	0,22	6	1	---	2
1268	3/8"	8	2" - 4"	1.37" x 0.98"	<0,22	6	1	---	1
1273	1/4"	3	up to 4"	0.78" x 0.78"	<0,22	6	1	---	1
1274	1/4"	3	up to 4"	0.78" x 0.78"	<0,22	6	---	---	1

## A nozzle that sets new standards for cleaning smaller pipes

Compact, lightweight and inexpensive are three words that sum up the **Standard Nozzle**. Made from hardened stainless steel with a rear spray angle of 20°, this nozzle is perfect for cleaning smaller pipes. A front jet for penetration is also available.

# CHISEL NOZZLE



P/N	Hose Con.	Minimum/GPM	Pipe Diameter	L x W Dimensions	Weight	Rear Jets	Front Jets	Radial Jets	Tier
1316	1 1/4"	100	8" - 24"	7.08" x 3.34"	9,70	6	5	----	2
1317	1 1/4"	80	8" - 20"	6.29" x 2.95"	5,51	6	5	----	2
1318	1"	60	8" - 20"	6.29" x 2.95"	5,51	6	5	----	2
1319	1 1/4"	80	8" - 20"	3.93" x 2.36"	1,76	10	4	----	2
1320	1"	60	8" - 15"	3.74" x 2.36"	1,50	8	4	----	2
1323	3/4"	30	6" - 12"	2.95" x 1.96"	0,66	6	4	----	2
1326	1/2"	12	4" - 8"	2.36" x 1.18"	0,33	6	4	----	1
1328	3/8"	12	2" - 4"	1.57" x 0.98"	<0,22	6	4	----	1
1330	1/4"	6	2" - 4"	1.18" x 0.78"	<0,22	6	4	----	1

## Reliable, powerful and effective at tough blockages

The **Chisel Nozzle** is a reliable sewer cleaning nozzle that is a must have! Sharp edges and multiple forward jets deliver powerful penetration to effectively open tough total blockages. A drill point can be added to the front of the Chisel as well.











# RADIAL CHISEL NOZZLE



1313



1314

 P/N	 Hose Con.	 Minimum/GPM	 Pipe Diameter	 Dimensions	 Weight	 Rear Jets	 Front Jets	 Radial Jets	 Tier
1313	1"	80	8" - 20"	6.29" x 2.95"	5.51	6	5	6	2
1314	3/4"	30	6" - 12"	4.13" x 2.36"	2.42	6	5	6	2

## Greater penetrating power that restores flow

The **Radial Chisel Nozzle** uses sharp edges, multiple forward-penetrating jets and radial spray jets at 70° to break up blockages from within. This nozzle is designed for ultimate penetrating power.

# 3D EXTREME



1136



1136

P/N	Hose Con.	Minimum/GPM	Pipe Diameter	L x W Dimensions	lbs. Weight	Rear Jets	Front Jets	Radial Jets	# Tier
1136	1"	60	6" - 15"	8.74" x 2.75"	9.47	8	1	---	3
1136,75	3/4"	30	6" - 15"	8.74" x 2.75"	9.47	8	1	---	3

## Exceptional cleaning and pulling power

Ideal for pipes that may have holes in the bottom or offsets, the **3D Extreme** nozzle is a worthy tool to have in your tool box. 3D fluid mechanics and one-piece ceramic inserts create a strong jet pattern with a spray angle of 11°, resulting in exceptional cleaning and pulling power. One forward jet offers a penetration option as well.

# FD2 NOZZLE 3D



P/N	Hose Con.	Minimum/GPM	Pipe Diameter	L x W Dimensions	lbs.	Rear Jets	Front Jets	Radial Jets	#
1278	1 1/4"	100	12"	7.87" x 3.54"	14,33	8	---	---	3
1279	1"	80	12"	7.87" x 3.54"	14,33	8	---	---	3
1280	1"	60	8"	6.29" x 2.95"	8,37	8	---	---	3
1282	3/4"	30	6"	5.51" x 2.36"	3,96	8	---	---	3
1290	1/2"	12	4"	4.72" x 1.96"	2,64	6	---	---	3

## Power meets control

The **FD2 Nozzle 3D** was designed to clean half open or completely open drain pipes! The hardened stainless steel nozzle includes 3D fluid mechanics that provide excellent cleaning and pulling power. At the same time, the one-piece ceramic inserts spray at an angle, preventing water from splashing upwards out of the channel.

# DIGGER NOZZLE



1144













1140



1141



1145

 P/N	 Hose Con.	 Minimum/GPM	 Pipe Diameter	 Dimensions	 Weight	 Rear Jets	 Front Jets	 Radial Jets	 Tier
1140	1/2"	12	2" - 8"	1.57" x 1.18"	0,22	---	---	7	2
1142	1/4"	6	Up to 3"	1.18" x 0.78"	<0,22	---	---	7	2
1144	Digger Nozzle Holder			0.98" x 1.96"	0,22	---	---	---	N/A

## A front-focused nozzle

Used as is or together with a special push rod attachment, the **Digger Nozzle** is strictly made for pushing material out of small pipes. The absence of rear jets focus all the water to the front of the nozzle, enabling it to clean effectively.

# PRIMUS

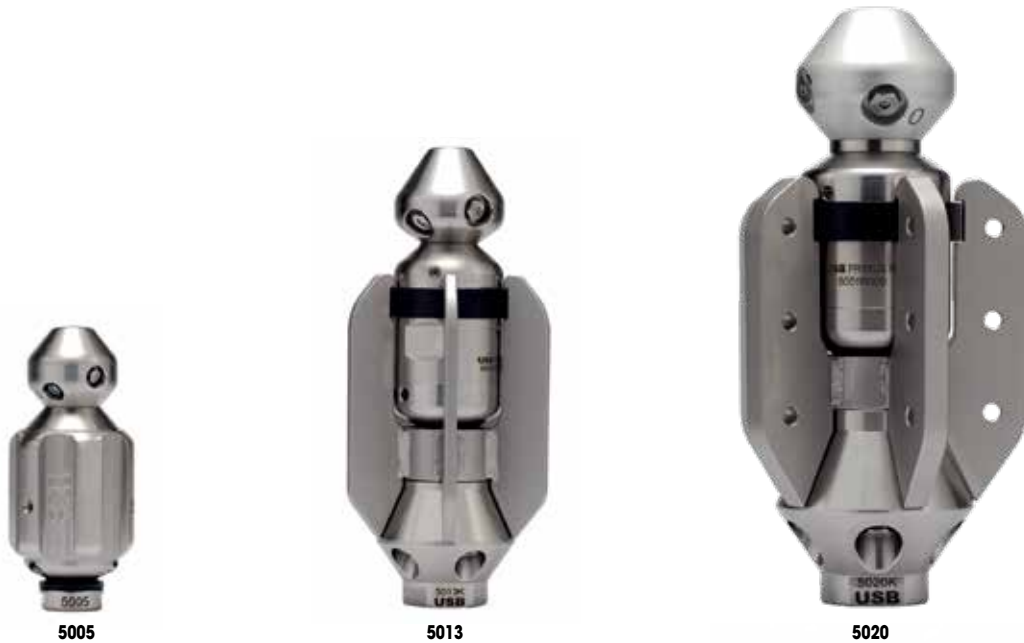

## PRIMUS I

P/N	Hose Con.	Minimum/GPM	Pipe Diameter	L x W Dimensions	lbs.	Rear Jets	Front Jets	Radial Jets	#
5005	1/2"	12	4" - 8"	5.36" x 2.36"	3	3	1	4	3

## PRIMUS II

P/N	Hose Con.	Minimum/GPM	Pipe Diameter	L x W Dimensions	lbs.	Rear Jets	Front Jets	Radial Jets	#
5010	3/4"	30	6" - 10"	9" x 4.72"	8	5	1	4	3
5013	1"	60	6" - 15"	9" x 4.72"	8	5	1	4	3

## PRIMUS III

P/N	Hose Con.	Minimum/GPM	Pipe Diameter	L x W Dimensions	lbs.	Rear Jets	Front Jets	Radial Jets	#
5020	1", 1 1/4"	80	12" - 24"	11.63" x 5.90"	20,94	5	1	4	3

### A user-friendly, innovative nozzle that flushes out debris

Designed for controlled rotation and use with recycled water, the innovative **Primus** requires no lubrication or replacement of internal parts for at least one year. The nozzle is built from hardened stainless steel. A rotating head removes grease, light scale and roots. And the 3D fluid mechanics in the propulsion unit flush out debris, providing outstanding results.

# PRIMUS ANTIBLASTER 3D



5018



5019

## PRIMUS ANTIBLASTER II 3D

P/N	Hose Con.	Minimum/GPM	Pipe Diameter	L x W Dimensions	lbs. Weight	Rear Jets	Front Jets	Radial Jets	# Tier
5017	3/4"	30	6" - 10"	9" x 4.72"	8	5	1	4	3
5018	1"	60	6" - 15"	9" x 4.72"	8	5	1	4	3

## PRIMUS ANTIBLASTER III 3D

P/N	Hose Con.	Minimum/GPM	Pipe Diameter	L x W Dimensions	lbs. Weight	Rear Jets	Front Jets	Radial Jets	# Tier
5019	1, 1 1/4"	80	12" - 24"	11.63" x 5.9"	20,94	5	1	4	3











### Controlled rotation for shallow sewer lines

Designed to reduce the chances of blowing toilets, the **Primus Antiblaster Nozzle 3D** is a controlled rotating nozzle that is also low maintenance. The nozzle is built from hardened stainless steel and requires no maintenance or replacement of internal parts for at least one year. A rotating head removes grease, light scale and roots while the wide 42° rear spray angles in the propulsion unit clean / flush out debris.



# ROTOR NOZZLES



 P/N	 Hose Con.	 Minimum/GPM	 Pipe Diameter	 L x W Dimensions	 Weight	 Rear Jets	 Front Jets	 Radial Jets	 Tier
1345	1 1/4"	100	10" - 20"	7.08 x 3.54"	14,1	6	---	3	2
1350	1"	80	6" - 15"	5.51" x 3.14"	9,25	6	---	3	2
1351	1"	40	6" - 12"	4.13" x 2.36"	3,30	6	---	3	2
1352	3/4"	30	6" - 10"	3.74" x 1.96"	3,30	6	---	3	2
1357	1/2"	12	4" - 8"	2.95" x 1.57"	1,10	3	---	3	2
1360	3/8"	6	2" - 6"	2.16" x 1.18"	0,66	3	---	3	2
1362	1/4"	6	2" - 6"	2.16" x 1.18"	0,66	3	---	3	2
1364	1/4"	6	Up to 4"	1.57" x 0.78"	0,33	3	---	---	1
1365	1/8"	3	Up to 4"	1.33" x 0.62"	0,22	3	---	---	1

## Multi-angled inserts and rear propulsion jets remove and flush debris

**Rotor Nozzles** feature three one-piece ceramic inserts in the middle rotating section with spray angles of 90° /75° /60°, effectively removing grease, dirt and light roots from pipes. Rear propulsion jets help flush the debris. Constructed of hardened stainless steel, the nozzles include non-corrosive, low-maintenance rotating centers.











# FRONT PUSH ROTOR



1308



1309 | 1310

 P/N	 Hose Con.	 Minimum/GPM	 Pipe Diameter	 L x W Dimensions	 lbs. Weight	 Rear Jets	 Front Jets	 Radial Jets	 # Tier
1308	1/2"	14	4" - 8"	2.75" x 1.57"	0.88	3	4	3	2
1309	3/8"	8	up to 6"	2.16" x 1.18"	0.66	3	4	3	2
1310	1/4"	8	up to 6"	2.16" x 1.18"	0.66	3	4	3	2

## A front-pushing nozzle designed for laterals and small pipes

The stainless steel **Front Push Rotor nozzle** is designed for effective cleaning of laterals and other small pipes. Rear jets propel the nozzle in the pipe, front rotating jets move material forward and additional rotating radial jets thoroughly clean the interior circumference of the pipe.











# T-HAMMER



1334



1335

 P/N	 Hose Con.	 Minimum/GPM	 Pipe Diameter	 L x W Dimensions	 lbs. Weight	 Rear Jets	 Front Jets	 Radial Jets	 # Tier
1333	1 ¼"	100	10" - 24"	10.23" x 5.19"	33,06	6	3	3	2
1334	1, 1 ¼"	80	8" - 20"	7.08" x 3.54"	14,33	6	3	3	2
1335	1	80	6" - 15"	5.51" x 3.14"	8,81	6	3	3	2











## Controlled force for plastic pipes

The T-Hammer's middle rotor section generates vibration in plastic pipes to break up deposits and other hard materials. Turbine technology controls the agitation. This stainless steel nozzle can be used with recycled water and comes standard with one-piece ceramic inserts.

**WARNING: Use in thick plastic pipes only!! NEVER use in clay, concrete or thin plastic pipes**

# V-HAMMER



 P/N	 Hose Con.	 Minimum/GPM	 Pipe Diameter	 L x W Dimensions	 lbs.	 Rear Jets	 Front Jets	 Radial Jets	 Tier
1337	1"	40	6" - 12"	4.13" x 2.36"	3,08	6	---	3	2
1338	¾"	30	6" - 10"	3.62" x 1.96"	1,76	6	---	3	2
1339	½"	12	4" - 8"	2.75" x 1.57"	1,32	3	---	3	2
1340	¼"	6	up to 4"	2.16" x 1.18"	0,33	3	---	3	2
1341	⅜"	6	up to 4"	2.16" x 1.18"	0,33	3	---	3	2

## Powerful impact for plastic pipes

The V-Hammer's middle rotor section generates vibration in plastic pipes to break up deposits and other hard materials that can then be flushed out. Less aggressive options for the top cap section are also available.

**WARNING: Use in thick plastic pipes only!! NEVER use in clay, concrete or thin plastic pipes.**

# GATOR Mini-Gator



5022



5030



5025/5035









P/N	Hose Con.	Minimum/GPM	Pipe Diameter	L x W Dimensions	lbs. Weight	Rear Jets	Front Jets	Head	# Tier
5022	3/8 - 1/2"	9	3" - 8"	4.33 x 1.57"	1.32	----	1	4	3
5025	CASE KIT 1/2"								
5030	3/4 - 1"	50	6" - 24"	8.66" x 4.52"	14.33	----	1	4	3
5035	CASE KIT 1"								

## High Performance Rotating Nozzle

The Gator and Mini Gator nozzles cut and remove roots, grease, blockages, and scale in various pipes ranging from 2" - 20". Encased in a compact stainless-steel body the strong reinforced internal design rotates the head. 3D fluid mechanics in the head smoothly direct all the incoming high-pressure water to the four rotating jets in the rear of the head and one in front. These rotating jets create an extremely powerful 360 degree all around complete cleaning of the pipe, flushing, and removing debris in less passes. The offset front jet eliminates blockages easily and effectively. A case kit is available which includes an additional skid.

# MINI T-CUTTERS



 P/N	 Hose Con.	 Minimum/GPM	 Pipe Diameter	 L x W Dimensions	 lbs. Weight	 Rear Jets	 Turbine Jets	 # Tier
1978	1/2"	8	2" - 4"	4.13" x 1.65"	1.54	6	3	2
1979	1/2"	8	2" - 4"	3.38" x 1.37"	0.88	6	3	2
1995	1/2"	8	2" - 4"	3.07" x 1.37"	0.88	6	3	2
1996	1/2"	8	2" - 4"	3.93" x 1.65"	1.32	6	3	2

## Mini turbine tools perfect for slight bends and lower pump outputs

Made from hardened stainless steel and designed for small pipes, **Mini T Cutters** are high-efficiency turbine tools that effectively remove roots and deposits and open blockages. Their small size enables the Mini T Cutters to navigate around slight bends. Most uniquely, the cutters can be reduced to 3/8" and 1/4" for lower pump outputs.

# TURBO 0



TURBO 0

## A small chain cutter with multiple attachments

One of the smallest chain cutters offered by USB, the **Turbo 0** utilizes turbine technology and 3D fluid mechanics to deliver supreme cutting and cleaning power. Multiple chain attachments, and rigid guide skids 4" to 6" make the removal of roots, grease and mineral deposits much easier. This cutter is constructed from hardened stainless steel, comes standard with one-piece ceramic nozzle inserts and is capable of use with recycled water.

P/N	Hose Con.	Minimum/GPM	Pipe Diameter	L x W Dimensions	lbs. Weight	Rear Jets	Turbine Jets	# Tier
2000	1/2"	12	4" - 6"	3.39" x 1.96"	0,88	3	3	3

# TURBO 0 - SPECIAL CASE



2050

## Turbo 0 CASE KIT

- Includes:
- 4" Guide Skid
  - 4" Chain retainer w/chain and bits
  - 6" Guide Skid
  - 6" Chain retainer w/chain and bits
  - Tools for cutter

# TURBO 0 - ACCESSORIES



**2001** Guide skid 4"  
**2003** Guide skid 6"



**2010M** Chain retainer w/ chain and bits 4"  
**2012M** Chain retainer w/ chain and bits 6"



**2010S** Chain w/ blocks 4"  
**2012S** Chain w/ blocks 6"



**2035** Slide-thru chain retainer



**2038** Block for chain



**2020** 4ft Replacement chain



# TURBO I



## Outmatched cutting performance with 4"-6" rigid skids\*

The **Turbo I** rigid chain cutter was engineered to be powerful, durable, user friendly and require low maintenance. This cutter uses turbine technology in combination with 3D fluid mechanics to deliver outmatched cutting performance in its operating range. Roots, grease and mineral deposits do not stand a chance against the Turbo I. Rigid guide skids are available from 4" to 6". The cutter comes standard with one-piece ceramic inserts and a high-pressure swivel and is capable of use with recycled water.

\*Skids sold separately

P/N	Hose Con.	Minimum/GPM	Pipe Diameter	L x W Dimensions	lbs. Weight	Rear Jets	Turbine Jets	# Tier
2100	1/2", 3/4"	14	4" - 6" ****	5.51" x 2.36"	2,64	3	3	3

# TURBO I - SPECIAL CASE



2150

## Turbo I CASE KIT

Includes:

- 4" Guide Skid
- 4" Chain retainer w/chain and bits
- 6" Guide Skid
- 6" Chain retainer w/chain and bits
- Tools for cutter

\*\*\*\* the skids are sold separate

# TURBO I - ACCESSORIES



- 2101** Guide skid 4"
- 2103** Guide skid 6"



- 2110M** Chain retainer w/ chain and bits 4"
- 2112M** Chain retainer w/ chain and bits 6"



- 2110S** Chain w/ blocks 4"
- 2112S** Chain w/ blocks 6"



- 2136** Slide-thru chain retainer



- 2138** Block for chain



- 2120** 4ft Replacement chain



- 2160** Diamond face cutter 4"
- 2164** Diamond face cutter 6"











- 2168** Center cap for face cutter



- 2170** Diamond barrel cutter 4"
- 2172** Diamond barrel cutter 5"
- 2175** Cap for barrel

# TURBO II RIGID



 P/N	2250 - chain cutter w/one guide skid, tool box, one set of chains w/bits and tools for the cutter	
 Hose Con.	3/4", 1"	
 Minimum/GPM	30	
 L x W Dimensions	9.05" x 5.31"	
 lbs. Weight	6,61	
 Pipe Diameter	6" - 12" - Guide Skids sold separately	
 Rear Jets	 Turbine Jets	 Tier
3	3	3

## Outmatched cutting performance with 6"-12" rigid skids

The **Turbo II Rigid** chain cutter was engineered to be powerful, durable, user friendly and require low maintenance. This cutter uses turbine technology in combination with 3D fluid mechanics to deliver outmatched cutting performance in its operating range. Roots, grease, and mineral deposits do not stand a chance against the Turbo II. Rigid guide skids are available from 6" - 12". The cutter comes standard with one-piece ceramic inserts and a high-pressure swivel and is capable of use with recycled water.

# TURBO II RIGID - ACCESSORIES



- 2251** Guide skid 6"
- 2252** Guide skid 8"
- 2253** Guide skid 10"
- 2254** Guide skid 12"



- 2210M** 3 Piece set of chain w/bits 6"
- 2211M** 3 Piece set of chain w/bits 8"
- 2212M** 3 Piece set of chain w/bits 10"
- 2213M** 3 Piece set of chain w/bits 12"



- 2210S** 3 Piece set of chain w/T-Hammer bits 6"
- 2211S** 3 Piece set of chain w/T-Hammer bits 8"
- 2212S** 3 Piece set of chain w/T-Hammer bits 10"
- 2213S** 3 Piece set of chain w/T-Hammer bits 12"



- 2238** T-Hammer bit



- 2210D** 3 Piece set of chain w/diamond bits 6"
- 2211D** 3 Piece set of chain w/diamond bits 8"
- 2212D** 3 Piece set of chain w/diamond bits 10"
- 2213D** 3 Piece set of chain w/diamond bits 12"





- 2220** 6ft Replacement chain



- 9005-TII** Quick change chain retainer

# TURBO II



 P/N	2200 - chain cutter w/tool box, one set of chains w/bits and tools for the cutter
 Hose Con.	3/4", 1"
 Minimum/GPM	40
 Dimensions	16.92" x 5.31"
 Weight	16,09
 Pipe Diameter	6" - 12"
 Rear Jets	3
 Turbine Jets	3
 Tier	3

## An impressive cutter with flexible guide skid (6" - 12")

The **Turbo II** flexible chain cutter was engineered to be powerful, durable, user friendly and require low maintenance. Made from high quality stainless steel and aluminum, this cutter uses turbine technology in combination with 3D fluid mechanics to deliver unmatched cutting performance in its operating range. Roots, grease, mineral deposits and protruding taps don't stand a chance against this impressive cutter. The flexible guide skid is adjustable between 6"-12" within 1/16", making it capable of handling offsets in the pipe. The cutter comes standard with one-piece ceramic inserts, a high-pressure swivel and is capable of use with recycled water.

# TURBO II - ACCESSORIES



- 2210M** 3 Piece set of chain w/ bits 6"
- 2211M** 3 Piece set of chain w/ bits 8"
- 2212M** 3 Piece set of chain w/ bits 10"
- 2213M** 3 Piece set of chain w/ bits 12"



- 2210S** 3 Piece set of chain w/ T-Hammer bits 6"
- 2211S** 3 Piece set of chain w/ T-Hammer bits 8"
- 2212S** 3 Piece set of chain w/ T-Hammer bits 10"
- 2213S** 3 Piece set of chain w/ T-Hammer bits 12"



- 2210D** 3 Piece set of chain w/ diamond bits 6"
- 2211D** 3 Piece set of chain w/ diamond bits 8"
- 2212D** 3 Piece set of chain w/ diamond bits 10"
- 2213D** 3 Piece set of chain w/ diamond bits 12"



- 2220** 6ft Replacement chain



- 9000-TII** Slide-thru chain retainer



- 2260** Diamond face cutter 6"
- 2262** Diamond face cutter 8"



- 2265** Center cap for face cutter 6"
- 2268** Center cap for face cutter 8"



- 2270** Diamond tap cutter 6"
- 2272** Diamond tap cutter 8"
- 2275** Cap for barrel











- 2295** Pulling eye swivel



- 9005-TII** Quick change chain retainer

# TURBO S 400



 P/N	2500 - chain cutter w/tool box, one set of chains w/bits and tools for the cutter
 Hose Con.	3/4", 1"
 Minimum/GPM	50
 Dimensions	21.15" x 7.08"
 Weight	26,45
 Pipe Diameter	8" - 16" up to 24" w/extension kit sold separate
 Rear Jets	3
 Turbine Jets	3
 Tier	3

## A heavy-duty cutter that leaves nothing in its path (flexible guide skid 8" - 16")

The **Turbo S400** flexible chain cutter was engineered to be powerful, durable, user friendly and require low maintenance. Made from high quality stainless steel and aluminum, this heavy-duty cutter uses turbine technology in combination with 3D fluid mechanics to deliver unmatched cutting performance in its operating range. Roots, grease, mineral deposits and protruding taps don't stand a chance against this impressive cutter. The flexible guide skid is adjustable between 8" - 16" within 1/16", making it capable of handling offsets in the pipe. An extension kit increases the cutters operation up to 24". The cutter comes standard with one-piece ceramic inserts and a high-pressure swivel and is capable of use with recycled water.

# TURBO S-400 - ACCESSORIES



- 2510M** 3 Piece set of chain w/ bits 8"
- 2511M** 3 Piece set of chain w/ bits 10"
- 2512M** 3 Piece set of chain w/ bits 12"
- 2513M** 3 Piece set of chain w/ bits 15"
- 2514M** 3 Piece set of chain w/ bits 18"
- 2515M** 3 Piece set of chain w/ bits 21"
- 2516M** 3 Piece set of chain w/ bits 24"



- 2510D** 3 Piece set of chain w/ diamond bits 8"
- 2511D** 3 Piece set of chain w/ diamond bits 10"
- 2512D** 3 Piece set of chain w/ diamond bits 12"
- 2513D** 3 Piece set of chain w/ diamond bits 15"
- 2514D** 3 Piece set of chain w/ diamond bits 18"
- 2515D** 3 Piece set of chain w/ diamond bits 21"
- 2516D** 3 Piece set of chain w/ diamond bits 24"



- 2510S** 3 Piece set of chain w/ T-Hammer bits 8"
- 2511S** 3 Piece set of chain w/ T-Hammer bits 10"
- 2512S** 3 Piece set of chain w/ T-Hammer bits 12"
- 2513S** 3 Piece set of chain w/ T-Hammer bits 15"
- 2514S** 3 Piece set of chain w/ T-Hammer bits 18"
- 2515S** 3 Piece set of chain w/ T-Hammer bits 21"
- 2516S** 3 Piece set of chain w/ T-Hammer bits 24"



**2538** T-Hammer bit



**9002-TS400** Slide thru chain retainer



**2520** 6ft Replacement chain



**2548** Pulling eye swivel



**9005-TS400** Quick change chain retainer



- 2571** Diamond tap cutter 8"
- 2572** Diamond tap cutter 10"
- 2573** Diamond tap cutter 12"



# TURBO III



	P/N	2300 - chain cutter w/tool box, one set of chains w/bits and tools for the cutter
	Hose Con.	¾", 1", 1¼"
	Minimum/GPM	50
	Dimensions	28.34" x 9.25"
	Weight	44,09
	Pipe Diameter	10" - 20" up to 32" w/extension kit sold separate
	Rear Jets	3
	Turbine Jets	3
	Tier	3

## A heavy-duty cutter that leaves nothing in its path (flexible guide skid 10" - 20")

The **Turbo III** flexible chain cutter was engineered to be powerful, durable, user friendly and require low maintenance. Made from high quality stainless steel and aluminum, this heavy-duty cutter uses turbine technology in combination with 3D fluid mechanics to deliver unmatched cutting performance in its operating range. Roots, grease, mineral deposits and protruding taps do not stand a chance against this impressive cutter. The flexible guide skid is adjustable between 10" - 20" within 1/16", making it capable of handling offsets in the pipe. An extension kit increases the cutters operation up to 32". The cutter comes standard with one-piece ceramic inserts and a high-pressure swivel and is capable of use with recycled water.

# TURBO III - ACCESSORIES



- 2310M** 3 Piece set of chain w/bits 10"
- 2311M** 3 Piece set of chain w/bits 12"
- 2312M** 3 Piece set of chain w/bits 15"
- 2313M** 3 Piece set of chain w/bits 18"
- 2314M** 3 Piece set of chain w/bits 20"
- 2315M** 6 Piece set of chain w/bits 24"
- 2316M** 6 Piece set of chain w/bits 28"
- 2317M** 6 Piece set of chain w/bits 30"
- 2318M** 6 Piece set of chain w/bits 32"



- 2310D** 3 Piece set of chain w/diamond bits 10"
- 2311D** 3 Piece set of chain w/diamond bits 12"
- 2312D** 3 Piece set of chain w/diamond bits 15"
- 2313D** 3 Piece set of chain w/diamond bits 18"
- 2314D** 3 Piece set of chain w/diamond bits 20"
- 2315D** 3 Piece set of chain w/diamond bits 24"
- 2316D** 3 Piece set of chain w/diamond bits 28"
- 2317D** 3 Piece set of chain w/diamond bits 30"
- 2318D** 3 Piece set of chain w/diamond bits 32"



- 2310S** 3 Piece set of chain w/T-Hammer bits 10"
- 2311S** 3 Piece set of chain w/T-Hammer bits 12"
- 2312S** 3 Piece set of chain w/T-Hammer bits 15"
- 2313S** 3 Piece set of chain w/T-Hammer bits 18"
- 2314S** 3 Piece set of chain w/T-Hammer bits 20"
- 2315S** 3 Piece set of chain w/T-Hammer bits 24"
- 2316S** 3 Piece set of chain w/T-Hammer bits 28"
- 2317S** 3 Piece set of chain w/T-Hammer bits 30"
- 2318S** 3 Piece set of chain w/T-Hammer bits 32"



**2336** Slide -thru chain retainer



**2320** 6ft Replacement chain 16B

**2330** 6ft Replacement chain 12B



**2604** Extension skids up to 32"

**2370** Extension skids for Egg Shaped Pipe



**2362** Chain retainer wheel small w/6 tabs for 12B and 16B up to 32"











**2344** Diamond tap cutter 10"

**2345** Diamond tap cutter 12"

**2346** Cap for barrel cutter

# TURBO S-200



	P/N	2750 - chain cutter w/tool box and one set of chains w/bits and tools for the cutter
	Hose Con.	1", 1 1/4"
	Minimum/GPM	80
	Dimensions	29.52" x 10.23"
	Weight	77,16
	Pipe Diameter	8" - 15"
	Rear Jets	3
	Turbine Jets	6
	Tier	3

## A heavy-duty cutter that leaves nothing in its path (flexible guide skid 8" - 15")

The **Turbo S200** flexible chain cutter was engineered to be powerful, durable, user friendly and require low maintenance. Made from tempered stainless steel and aluminum, this heavy-duty cutter uses turbine technology in combination with 3D fluid mechanics to deliver unmatched cutting performance in its operating range. Roots, grease, mineral deposits and protruding taps do not stand a chance against this impressive cutter. The flexible guide skid is adjustable between 8" - 15" within 1/16" making it capable of handling offsets in the pipe. The cutter comes standard with one-piece ceramic inserts, a high-pressure swivel and is capable of being used with recycled water.

# TURBO S-200 - ACCESSORIES



- 2751M** 3 Piece set of chain w/bit 8"
- 2752M** 3 Piece set of chain w/bit 10"
- 2753M** 3 Piece set of chain w/bit 12"
- 2754M** 3 Piece set of chain w/bit 15"



- 2755S** 3 Piece set of chain w/blocks 8"
- 2756S** 3 Piece set of chain w/blocks 10"
- 2757S** 3 Piece set of chain w/blocks 12"
- 2758S** 3 Piece set of chain w/blocks 15"



- 2759D** 3 Piece set of chain w/diamond bits 8"
- 2760D** 3 Piece set of chain w/diamond bits 10"
- 2761D** 3 Piece set of chain w/diamond bits 12"
- 2762D** 3 Piece set of chain w/diamond bits 15"



- 2720** 6ft Replacement chain



- 9002-TS200** Slide thru chain retainer



- 2738** Block for chain



- 2740** Hex Bit (outside link)



- 2741** Hex Bit (inside link)



- 2739** Diamond bit











- 9005-TS200** Quick change chain retainer



- 2798** Pulling eye swivel

# TURBO S-600



 P/N	2650 - chain cutter w/one set of chains w/bits and tools for the cutter
 Hose Con.	1", 1 1/4"
 Minimum/GPM	80
 Dimensions	29.52" x 10.23"
 Weight	77,16
 Pipe Diameter	12" - 24"
 Rear Jets	3
 Turbine Jets	6
 Tier	3

## A heavy-duty cutter that leaves nothing in its path (flexible guide skid 12" - 24")

The Turbo S600 flexible chain cutter was engineered to be powerful, durable, user friendly and require low maintenance. Made from high quality stainless steel and aluminum, this heavy-duty cutter uses turbine technology in combination with 3D fluid mechanics to deliver unmatched cutting performance in its operating range. Roots, grease, mineral deposits and protruding taps do not stand a chance against this impressive cutter. The flexible guide skid is adjustable between 12" - 24" within 1/16", making it capable of handling offsets in the pipe. The cutter comes standard with one-piece ceramic inserts, a high-pressure swivel and is capable of being used with recycled water.

# TURBO S-600 - ACCESSORIES



- 2610M** 3 Piece set of chain w/bits 12"
- 2611M** 3 Piece set of chain w/bits 15"
- 2612M** 3 Piece set of chain w/bits 18"
- 2613M** 3 Piece set of chain w/bits 20"
- 2614M** 3 Piece set of chain w/bits 24"



- 2610S** 3 Piece set of chain w/blocks 12"
- 2611S** 3 Piece set of chain w/blocks 15"
- 2612S** 3 Piece set of chain w/blocks 18"
- 2613S** 3 Piece set of chain w/blocks 20"
- 2614S** 3 Piece set of chain w/blocks 24"



- 2610D** 3 Piece set of chain w/diamond bits 12"
- 2611D** 3 Piece set of chain w/diamond bits 15"
- 2612D** 3 Piece set of chain w/diamond bits 18"
- 2613D** 3 Piece set of chain w/diamond bits 20"
- 2614D** 3 Piece set of chain w/diamond bits 24"



- 2620** 6ft Replacement chain



- 9002-TS600** Slide thru chain retainer



- 2638** Block for chain



- 2639** Diamond bit











- 9005-TS600** Quick change chain retainer



- 2698** Pulling eye swivel

# TURBO IV



	P/N	2350 - chain cutter w/one set of chains w/bits and tools for the cutter
	Hose Con.	1", 1 1/4"
	Minimum/GPM	80
	Dimensions	39.37" x 14.96"
	Weight	99,2
	Pipe Diameter	15" - 36"
	Rear Jets	3
	Turbine Jets	6
	Tier	3

## A heavy-duty cutter that leaves nothing in its path (flexible guide skid 15" - 36")

The **Turbo IV** flexible chain cutter was engineered to be powerful, durable, user friendly and require low maintenance. Made from tempered stainless steel and aluminum, this heavy-duty cutter uses turbine technology in combination with 3D fluid mechanics to deliver unmatched cutting performance in its operating range. Roots, grease, mineral deposits and protruding taps do not stand a chance against this impressive cutter. The flexible guide skid is adjustable between 15" - 36" within 1/16" making it capable of handling offsets in the pipe. An extension kit increases the cutters operation up to 48". The cutter comes standard with one-piece ceramic inserts and a high-pressure swivel and is capable of use with recycled water.

# TURBO IV - ACCESSORIES



- 2354M** 3 Piece set of chain w/bits 15"
- 2355M** 3 Piece set of chain w/bits 18"
- 2356M** 3 Piece set of chain w/bits 20"
- 2357M** 6 Piece set of chain w/bits 24"
- 2358M** 6 Piece set of chain w/bits 28"
- 2359M** 6 Piece set of chain w/bits 30"
- 2360M** 6 Piece set of chain w/bits 32"
- 2361M** 6 Piece set of chain w/bits 36"



- 2354D** 3 Piece set of chain w/diamond bits 15"
- 2355D** 3 Piece set of chain w/diamond bits 18"
- 2356D** 3 Piece set of chain w/diamond bits 20"
- 2357D** 3 Piece set of chain w/diamond bits 24"
- 2358D** 3 Piece set of chain w/diamond bits 28"
- 2359D** 3 Piece set of chain w/diamond bits 30"
- 2360D** 3 Piece set of chain w/diamond bits 32"
- 2361D** 3 Piece set of chain w/diamond bits 36"



**2338** Block for chain



**2339** Diamond bits



**2320** 6ft Replacement chain



**2362M** Chain retainer wheel large w/6 tabs for 12B and 16B up to 36"



**2364S** Chain retainer wheel large w/6 tabs for 12B up to 48"











**2398** Pulling eye swivel

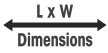

# TURBIKIT 3D



 P/N	 Hose Con.	 Minimum/GPM	 Pipe Diameter	 L x W Dimensions	 lbs. Weight	 Rear Jets	 Turbine Jets	 # Tier
2400	½", ¾", 1"	14	4" – 8"	5.90" x 2.36"	3,3	6	3	2
2410	6ft Replacement chain							
2411	3 Piece set of chains x 7 links		4"					
2411D	3 Piece set of chain w/diamond bits		4"					
2412	2 Piece set of chains x 9 links		6"					
2412D	3 Piece set of chain w/diamond bits		6"					
2413	3 Piece set of chains x 11 links		8"					
2413D	3 Piece set of chain w/diamond bits		8"					
2420	6ft Replacement screws M6 x 6							

## High strength open-link chain

Open-link chain makes the **Turbikit 3D** unique from other chain cutters offered by USB. Driven by a turbine technology, the high strength open link chain delivers extremely effective cutting power. The cutter can be used to remove roots and mineral deposits from the sewer pipe without a centralizing skid. The cutter comes standard with one-piece ceramic inserts and a high-pressure swivel and is capable of use with recycled water.

# PIPE WOLF NOZZLE 3D











1984



1982



1980

 P/N	 Hose Con.	 Minimum/GPM	 Pipe Diameter	 L x W Dimensions	 lbs. Weight	 Rear Jets	 Turbine Jets	 # Tier
1984	1", 1 1/4"	80	8" - 24"	7.48" x 3.74"	11,9	6	3	3
1982	1"	60	6" - 15"	6.29" x 2.83"	5,73	6	3	3
1982,75	3/4"	30	6" - 12"	6.29" x 2.83"	5,73	6	3	3
1980	1/2"	12	4" - 8"	4.56" x 2.12"	2,42	6	3	3

## A beast for organic blockages

The **Pipe Wolf Nozzle 3D** is an extremely aggressive specialty tool perfect for total blockages that are made from organic material. A hardened, tapered head with sharp edges utilizes turbine technology and spins at approximately 10,000 rpms, boring a hole and opening up the blockage. This essential nozzle comes standard with one-piece ceramic inserts, can be used with recycled water and delivers in emergency situations.

# DIAMOND FACE CUTTER 3D



2453



1986



1987



2452

P/N	Hose Con.	Minimum/GPM	Pipe Diameter	L x W Dimensions	lbs. Weight	Rear Jets	Turbine Jets	# Tier
2453	1", 1 1/4"	80	6" - 10"	5.74" x 3.74"	11,24	6	3	3
2452	1"	60	6" - 8"	4.92" x 2.87"	5,29	6	3	3
2451	3/4"	30	6" - 8"	4.92" x 2.87"	5,29	6	3	3
2450	1/2"	14	4" - 6"	3.85" x 2.24"	2,42	6	3	3

1986 Replacement head for Diamond Cutter No. 2450

1987 Replacement head for Diamond Cutter No. 2451 and 2452

1988 Replacement head for Diamond Cutter No. 2453

## An aggressive tool for total blockages and mineral deposits

The **Diamond Face Cutter 3D** is an extremely aggressive specialty tool perfect for total blockages and some hardened mineral deposits. Turbine technology and 3D fluid mechanics spin a cutting head equipped with diamond bits and sharp edges at approximately 10,000 rpms, boring a hole and opening the blockage. This nozzle comes standard with one-piece ceramic inserts and can be used with recycled water.

# ROTOR WOLF













1974



1975



1977

 P/N	 Hose Con.	 Minimum/GPM	 Pipe Diameter	 L x W Dimensions	 lbs. Weight	 Rear Jets	 Front Jets	 Radial Jets	 # Tier
1974	1/2"	12	4" - 6"	3.70" x 1.57"	0,88	3	---	3	2
1975	1/4"	8	1" - 2"	2.75" x 1.18"	0,44	3	---	3	2
1976	3/8"	8	2" - 4"	2.75" x 1.18"	0,44	3	---	3	2
1977	1/4"	6	1" - 2"	1.65" x 0.78"	< .22	3	---	3	1

## Two nozzles in one to pierce and penetrate blockages

USB combined two nozzles to create the **Rotor Wolf!** Designed for use in smaller pipes, the hardened tapered head with sharp edges effectively pierces and penetrates blockages fast. The middle 90° rotating jets spin the head as they clean the interior walls of the pipe.

# BEAVER













2475

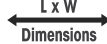

2485



 P/N	 Hose Con.	 Minimum/GPM	 Pipe Diameter	 L x W Dimensions	 lbs. Weight	 Rear Jets	 Turbine Jets	 Radial Jets	 Tier
2475	½"	12	4"	3.74 x 2.95"	3,00	6	3	---	3
2485	½"	12	4"	3.74 x 2.95"	3,00	6	3	---	3

## High efficiency cutter in a compact design

The **Beaver** nozzle is a small maneuverable cutting head for removing roots and mineral deposits from pipes. A quick-change system for the rotating heads allows the user to easily change between the standard cutting head or the diamond cutting head. The 3D fluid mechanics and turbine technology propel and spin the head aggressively to open blockages. Once-piece ceramic inserts come standard and the nozzle can be used with recycled water.

# RADIAL FLEX SKID













P/N	Hose Con.	Minimum/GPM	Pipe Diameter	L x W Dimensions	lbs. Weight	Rear Jets	Front Jets	Radial Jets	# Tier
5250	1", 1¼"	80	20" - 48"	38,18" x 18,5"	72,75	3	---	4	2
5070	1" Nozzle extension								
5072	2" Nozzle extension								
5074	4" Nozzle extension								

## Tackle large diameter pipes

The **Radial Flex Skid** is a controlled rotating nozzle with flexible guide skid for large diameter pipes of up to 48". The 360° cleaning thoroughly removes hardened grease and some mineral deposits from the top of the pipe. Constructed from high quality stainless steel and aluminum, this flexible skid is adjustable within 1/16", very user friendly and can be used with recycled water.

# HANDY CART



 P/N	 Hose Con.	 Minimum/GPM	 Pipe Diameter	 L x W Dimensions	 lbs. Weight	 Rear Jets	 Front Jets	 Radial Jets	 # Tier
2550	1", 1¼"	80	40" and up	39.37" x 16.53"	88,18	5	6	4	2
5070	1" Nozzle extension								
5072	2" Nozzle extension								
5074	4" Nozzle extension								

## Powerful cleaning for rectangular or large diameter pipes

The **Handy Cart** includes a controlled rotating nozzle with a robust transporter skid for various rectangular or large diameter pipes of up to 16 feet! The 360° cleaning thoroughly removes hardened grease and some mineral deposits from the top of the pipe. Constructed from high quality stainless steel this Handy Cart is very user friendly and ready for immediate use.

# EIBOW FLEX SKID



P/N	Hose Con.	Minimum/GPM	Pipe Diameter	L x W Dimensions	lbs. Weight	Rear Jets	Front Jets	Radial Jets	# Tier
2555	1", 1¼"	80	24" - 72"	---	55,11	5	---	4	2
5070	1" Nozzle extension								
5072	2" Nozzle extension								
5074	4" Nozzle extension								

## Powerful cleaning for large egg-shaped pipes

The **Eibow Flex Skid** offers a controlled rotating nozzle with flexible guide skid for large egg-shaped pipes up to 72". The 360° cleaning thoroughly removes hardened grease and some mineral deposits from the top of pipes. The start-of-the-art flexible skid is adjustable within 1/16", very user friendly and can be used with recycled water.





3330











P/N	Hose Con.	Minimum/GPM	Pipe Diameter	L x W x H Dimensions	lbs. Weight	Rear Jets	Front Jets	Radial Jets	# Tier
3330	3/8 - 1/2"	9	3" - 6"	12.54" x 12.99 x 15.74"	16.53	5	---	2	3

### Innovative inspection nozzle

The **NOZZCAM™** is a steering nozzle with a built-in CCTV camera and display that provides exceptionally clear imagery and extreme maneuverability in any size pipe. It's fixed (non-leveling) camera allows operators to know their place in the pipe and easily steer down laterals. With an additional light package and flexible guide skid the NOZZCAM™ can be used in larger pipe for mainline inspection.

# SPIN-JET



 P/N	 Hose Con.	 Minimum/GPM	 Pipe Diameter	 L x W Dimensions	 lbs. Weight	 Rear Jets	 Front Jets	 Radial Jets	 # Tier
5050	½", 1"	12	Man Hole or Lift Station 4'-15'	6.29" x 9.84"	4,85	----	3	3	2
5052	¾"	30	Man Hole or Lift Station 4'-15'	6.29" x 11.02"	7,05	----	3	6	2
5055	1"	60	Man Hole or Lift Station 4'-15'	9.44" x 11.81"	12,34	----	3	3	2
5058	Centering Aid	5050   5052							
5059	Centering Aid	5055							
5070	Nozzle Extension	1"							
5072	Nozzle Extension	2"							
5074	Nozzle Extension	4"							

## A controlled, rotating nozzle for cleaning lift stations, barrels and manholes

The **Spin-Jet** is a self-centering, controlled rotating nozzle that is used for cleaning lift stations, barrels and manholes prior to rehabilitation. Available in three different versions, the Spin-Jet has driving nozzles that rotate in a 360° horizontal plane only. This action eliminates the need to cover the manhole during operation, allowing for constant viewing of the cleaning process. Front jets thoroughly clean any grease, sludge or mud at the bottom.

# STEERING NOZZLE



1241



1245



1243













1246



1239



1240

 P/N	 Hose Con.	 Minimum/GPM	 Pipe Diameter	 L x W Dimensions	 lbs. Weight	 Rear Jets	 Front Jets	 Radial Jets	 # Tier
---	---	---	---	---	--	---	--	---	---

1239	Replacement Hose with Threaded Ends								
1240	1/2"	12	3" - 8"	10.62" x 1.25"	0,22	4	4	---	2
1241	1/2"	12	3" - 8"	9.05" x 1.25"	0,55	6	4	---	2
1243	1/2"	12	3" - 8"	9.44" x 1.57"	0,99	6	4	---	2
1245	1/2"	12	3" - 8"	9.84" x 1.57"	1,54	3	4	3	2
1246	1/2"	12	3" - 8"	9.84" x 1.57"	1,43	3	4	3	2

## A nozzle for navigating

As the name suggest, the **Steering Nozzle** can be navigated into and through laterals and other branches. Simply twist your high-pressure hose to the left or right to direct the nozzle exactly where you want it to go.

# ANTIBLASTER













1198



1199



1200











 P/N	 Hose Con.	 Minimum/GPM	 Pipe Diameter	 L x W Dimensions	 Weight	 Rear Jets	 Front Jets	 Radial Jets	 Tier
1198	1"	60	6" - 12"	4,52" x 2,75"	3,74	8	1	---	3
1198,75	3/4"	30	6" - 10"	4,52" x 2,75"	3,74	8	1	---	3
1199	1"	80	6" - 12"	4,52" x 2,75"	3,74	8	1	8	3
1200	1"	80	8" - 15"	5,90" x 3,93"	10,58	6	—	6	3

## Smooth propulsion for shallow depths and pipes near homes

With a wide 35 and 70 degree spray angles, the **Antiblaster** nozzle is perfect for reducing the chances of blowing toilets. Constructed from hardened stainless steel, the nozzle was designed for cleaning pipes at a shallow depths and pipes that are adjacent to homes. The 3D fluid mechanics and one-piece ceramic inserts provide powerful cleaning and smooth propulsion. An optional front jet is also available.

# OVERSIZED NOZZLES



 P/N	 Hose Con.	 Minimum/GPM	 Pipe Diameter	 L x W Dimensions	 lbs.	 Rear Jets	 Front Jets	 Radial Jets	 Tier
1010	1½"	120	40" - 196"	32.28 x 17.32"	167	14	---	---	3
1030	1½"	100	12" - 78"	16.53 x 7.48"	105	8	---	---	3
1191	1½"	100	12" - 24"	12.40 x 7.48"	79	6	---	10	3
1227	1½"	100	15" - 120"	10.23 x 6.29"	79	15	---	---	3

## Special applications require special tools

Oversized nozzles are larger and heavier than ordinary cleaning nozzles. These nozzles are mainly used in conjunction with high water volumes and large hose diameters in big sewer lines. With 120 - 210 GPM and high-pressure hose 1¼" to 1½", deposits can be loosened and transported in these, constantly water bearing sewers. Due to their mass, the oversized nozzles will stay on the bottom of the sewer and never float. These nozzles come with one-piece ceramic inserts.

# HIGH PRESSURE SWIVEL



1653



1652



1651



1650



P/N



Hose Con.



1650	1 ¼"	Swivel Joint male/female
1651	1"	Swivel Joint male/female
1652	¾"	Swivel Joint male/female
1653	½"	Swivel Joint male/female

## Keep nozzles stationary

**High Pressure Swivels** are made from hardened stainless steel and allow for the hose to twist and swivel without turning what's connected to it while in use. High-pressure swivels are made for chain cutters, bottom cleaners and nozzles.

# CROWN NOZZLE



 P/N	 Hose Con.	Jets	Suction Pipe Diameter
2730	1/2"	6	2.95/3.14"
2732	1/2"	6	3.93/4.33"
2734	1/2"	6	4.92/5.31"
2736	3/4"	6	5.9"

## The crown jewel of hydro-excavation

The **Crown Nozzle** can be easily attached to the suction tube for hydro-excavation. Six powerful jets loosen and break up material, which can then be effortlessly transported to the debris tank. The crown is constructed of hardened stainless steel and has replaceable one-piece ceramic jets.







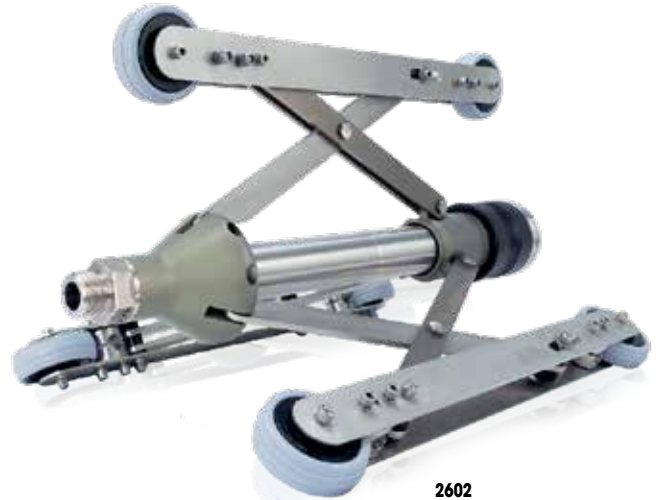

# UNI-FLEX SKID



2601



2602

 P/N	 Hose Con.	 Minimum/GPM	 Pipe Diameter	 L x W Dimensions	 lbs. Weight	 Rear Jets	 Front Jets	 Radial Jets
2602	1"	N/A	10" - 20"	25.59" x 9.25"	33,06	3	---	---
2601	1"	N/A	6" - 12"	15.74" x 5.31"	15,43	3	---	---

## Adjustable and accommodating

Used for centralization in the pipe, the **Uni-Flex Skid** is continuously adjustable by increments of 1/16" within its operating range. The front 1" NPT threads accommodate most cleaning, rotor and radial cleaning nozzles. The universal flex skid comes standard with a high-pressure swivel.



# REDUCERS | COLLARS



## ENLARGING COLLAR - STAINLESS STEEL

Barcode	Spring	Image	Part No.	Size 1	Gender	Size 2	Gender
1810	1"	male	x	1 1/4"	female		
1811	3/4"	male	x	1"	female		
1812	1/2"	male	x	3/4"	female		
1813	3/8"	male	x	1/2"	female		
1814	1/4"	male	x	1/2"	female		

## STRAIGHT COLLARS - STAINLESS STEEL

Barcode	Spring	Image	Part No.	Size 1	Gender	Size 2	Gender
1850	1 1/4"	male	x	1 1/4"	female		
1851	1"	male	x	1"	female		
1852	3/4"	male	x	3/4"	female		
1853	1/2"	male	x	1/2"	female		
1854	3/8"	male	x	3/8"	female		
1855	1/4"	male	x	1/4"	female		

## REDUCER - STAINLESS STEEL

Barcode	Spring	Image	Part No.	Size 1	Gender	Size 2	Gender
1820	1 1/4"	male	x	1"	female		
1821	1"	male	x	3/4"	female		
1822	3/4"	male	x	1/2"	female		
1823	1/2"	male	x	3/8"	female		
1824	3/8"	male	x	1/4"	female		

## FEMALE TO FEMALE FITTING - GALVANIZED

Barcode	Spring	Image	Part No.	Size 1	Gender	Size 2	Gender
1860	1 1/4"	female	x	1 1/4"	female		
1861	1"	female	x	1"	female		
1862	3/4"	female	x	3/4"	female		
1863	1/2"	female	x	1/2"	female		
1864	3/8"	female	x	3/8"	female		
1865	1/4"	female	x	1/4"	female		

## DOUBLE NIPPLE - GALVANIZED

Barcode	Spring	Image	Part No.	Size 1	Gender	Size 2	Gender
1830	1 1/4"	male	x	1 1/4"	male		
1831	1 1/4"	male	x	1"	male		
1832	1"	male	x	1"	male		
1833	1"	male	x	3/4"	male		
1834	3/4"	male	x	3/4"	male		
1835	3/4"	male	x	1/2"	male		
1836	1/2"	male	x	1/2"	male		
1837	1/2"	male	x	3/8"	male		
1838	3/8"	male	x	1/4"	male		
1839	1/4"	male	x	1/4"	male		
1840	1/4"	male	x	1/8"	male		
1841	1/8"	male	x	1/8"	male		

## SWIVEL FITTING - GALVANIZED

Barcode	Spring	Image	Part No.	Size 1	Gender	Size 2	Gender
1870	1 1/4"	male	x	1 1/4"	female		
1871	1 1/4"	male	x	1"	female		
1872	1"	male	x	1"	female		
1873	1"	male	x	3/4"	female		
1874	3/4"	male	x	3/4"	female		
1875	3/4"	male	x	1/2"	female		
1876	1/2"	male	x	1/2"	female		
1877	1/2"	male	x	3/8"	female		
1878	3/8"	male	x	3/8"	female		
1879	3/8"	male	x	1/4"	female		
1880	1/4"	male	x	1/4"	female		

# TOOLS | ACCESSORIES



## INSERT GAUGE



8000 0.45 - 1.5

8001 1.5 - 3.0

## T-HANDLE WRENCH FOR ISK INSERTS



8010 2,0

8011 2,5

8012 3,0

8013 4,0

8014 5,0

8014 6,0

8016 8,0

## T-HANDLE WRENCH FOR ASK INSERTS



8020 SW6

8021 SW8

8022 SW9

8023 SW10

8024 SW12

8025 SW14

8026 SW17

## AKTIVATOR

8050 Aktivator 200 ML



## NOZZLE ADHESIVE

8055 Medium strength, blue 50 ml

8057 High strength, green 50 ml

## ALLEN WRENCH



8040 2,0

8041 2,5

8042 3,0

8043 4,0

8044 5,0

8045 6,0

## PUNCH FOR TURBOS



8065 4,0

8067 5,0

8069 6,0

8070 8,0

8072 10,0

## TEFLON

8080 Teflon 1 l



## TEFLONSPRAY

8082 Teflonspray 500 ml

8085 Teflonspray FIN SUPER 100 ml

## CARE SPRAY

8095 Care spray 500 ml

# NOZZLE INSERTS



Barcode	Thread	wrench size
1561	G 1/4"	SW 14
1563	M 10 x 1	SW 10
1564	G 1/8"	SW 14
1567	M6	SW 6
1568	M8	SW 8

Barcode	Thread	wrench size
1550	G 1/4"	SW 14
1551	G 1/4"	SW 9
1563 K	M 10 x 1	SW 10
1564 K	G 1/8"	SW 14
1527 AK	M6	SW 6
1528 AK	M8	SW 8

Barcode	Thread
1532	M 12
1528	M 8
1527	M 6
1526	M 5
1525	M 4

Barcode	Thread
1552	M 12
1529 K	M 10
1528 K	M 8
1527 K	M 6

Barcode	Thread
1572	G 1/4"
1576	G 1/4"

Barcode	Thread	wrench size
1573 K	G 1/4"	SW 14
1574 K	G 1/8"	SW 14
1575 K	M 10 x 1	SW 10

# WARRANTY



Thank you for your interest in the products and services of USB-USA LLC. This limited warranty applies to physical goods, and only for physical goods, purchased from USB-USA LLC.

## **What does this limited warranty cover?**

This limited warranty covers any manufacturer's defect in material or workmanship under normal use during the warranty period.

During the warranty period, USB-USA LLC will repair or replace, at no charge, products or parts of a product that proves defective because of improper material or workmanship, under normal use and maintenance.

## **What will we do to correct problems?**

USB-USA LLC will repair the product at no charge, using new or refurbished replacement parts. If necessary full replacement is offered.

## **How long does the coverage last?**

The warranty period for physical goods purchased from USB-USA LLC is one year for any physical nozzle or chain cutter that spins (Turbo Chain Cutter, Rotors, Primus etc.) and three years for any nozzle with ceramic nozzle inserts and 3D fluid mechanics from the date of purchase.

A replacement physical good or part assumes the remaining warranty of the original physical good or 90 days from the date of replacement or repair, whichever is longer.

## **What does this limited warranty not cover?**

This limited warranty does not cover any problem that is caused by conditions, malfunctions or damage not resulting from defects in material or workmanship.

## **What do you have to do?**

To obtain warranty service, you must first contact us to determine the problem and most appropriate solution for you.

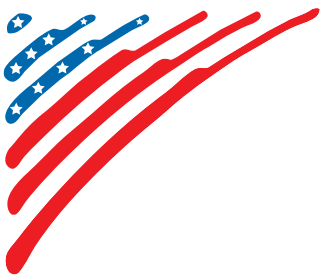

**USB-USA**

1-844-285-5770 | [info@usb-usa.com](mailto:info@usb-usa.com)



**USB-USA**

1-844-285-5770

| [INFO@USB-USA.COM](mailto:INFO@USB-USA.COM)

| 7565 OWL CREEK DRIVE, DOUGLASVILLE, GA 30134