

Pole Position

Bearing self study guide

Expanding your knowledge
of bearings and related
components.



\$10.00

Table of contents

Introduction	2	Chapter 8	
Chapter 1		Installation	38
History of bearings	3	Pre-installation	38
The parts of a bearing	3	Press fitting, mounting	39
Review	5	Clutch release bearing:	
		Special mounting procedures	40
		Installation checklist	41
		Review	42
Chapter 2		Chapter 9	
The bearing	7	Bearing adjustment	44
Review	9	Review	46
Chapter 3		Chapter 10	
Operation conditions	11	Bearing lubrication	48
Internal bearing clearance	11	Lubrication selection	49
Shaft and housing conditions	12	Grease lubrication	50
Review	14	General recommendations	51
		Review	52
Chapter 4		Chapter 11	
Roller bearing types	16	Bearing maintenance	54
Tapered roller bearing	16	Review	56
Cylindrical roller bearing	17	Chapter 12	
Needle roller bearing	18	Troubleshooting	58
Review	19	Brinelling	58
		Contamination	59
		Fretting	59
		Peeling	60
		Spalling	60
		Misalignment	61
		Electric Arcing	62
		Seizing	62
		Review	64
Chapter 5		Glossary of terms	66
Ball bearing types	21		
Single row ball bearing	22		
Angular contact ball bearing	22		
Double row ball bearing	23		
Ball thrust	23		
Review	24		
Chapter 6			
Hub units	26		
Hub installation guide	27		
Review	31		
Chapter 7			
Bearing removal & cleaning	33		
Bearing removal	33		
Cleaning bearings	35		
Review	36		

Introduction

This book, produced for use by SKF distributors and customers, should prove of practical value to mechanics, maintenance superintendents and anyone who can benefit from a thorough understanding of roller and ball bearings. It will explain:

- How to remove, inspect, and install bearings;
- How to improve performance with proper lubrication and maintenance techniques;
- How to spot bearing failures, correct them and prevent them from happening again.

This self-study guide is programmed to increase performance productivity. Each chapter consists of a logical organization of material, technical diagrams and a short quiz to help you retain what you study.

How to use this study guide

Start by carefully reading the text portion of each chapter. Make notes or underline if you wish; this can help you remember what you've read.

Study at your own pace. Nobody is going to grade or score the chapter reviews.

The chapter quizzes are an important phase in self-study learning since they are intended to reinforce the material covered. The quiz questions are straightforward multiple choice and true and false. There are no "trick questions." Your answers can easily be checked within the context of the chapter.

Answer the questions at the end of each chapter before moving on. If you are unsure about an answer to a question, check in the chapter and review that portion again.

History of bearings

For centuries, man had to rely on his own power to push or pull large objects over the earth. The concept of a bearing – to lessen friction between an object and the surface over which it is moved – is nearly as old as man himself.

The first solution to relieving some of this sliding friction was recorded as early as 3,500 B.C. It was then that Mesopotamians were using one of the first bearings known to man, an invention called the wheel. Where the wheel and axle touched, they put a bearing made of leather or wood and lubricated it with animal fat.

Ancient drawings from 1,100 B.C. show the Assyrians and Babylonians moving huge rocks for their monuments and palaces with rollers, illustrating the basic bearing principle – to lessen friction. But this was sliding – not rolling – friction.

The roller and ball bearings of today may bear little resemblance to their predecessors but the concept has remained the same: to lessen friction. Today, bearings are used in almost every imaginable application, such as roller skates and bicycles, where two surfaces are turning or moving against each other. They are used in thousands of ways, from the minute internal workings of a clock to large turbine engines in a ship.

The bearings with which we are concerned fit two basic categories – ball and roller. We will discuss both categories, and cover bearing types, installation, operating conditions, maintenance and troubleshooting. In addition, we will feature one particular type – the tapered roller bearing – which has numerous fleet applications.

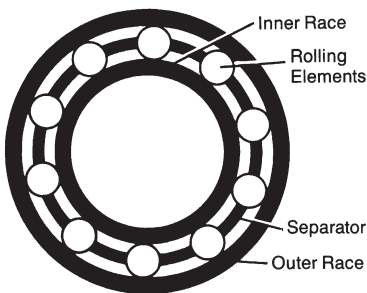

Bearing parts
(fig. 1)

The parts of a bearing

A bearing's smooth performance is assured by a combination of four basic working parts (fig. 1):

- Outer race (also called outer ring or cup)
- Inner race (also called inner ring or cone)
- Rolling elements (either balls or rollers)
- Separator (also called cage or retainer)

The outer race, or cup, is the bearing's exterior ring. Since it protects the bearing's internal parts, it must be machined smoothly and accurately. The inner race, or cone, is the part of the bearing that sits directly on the shaft.

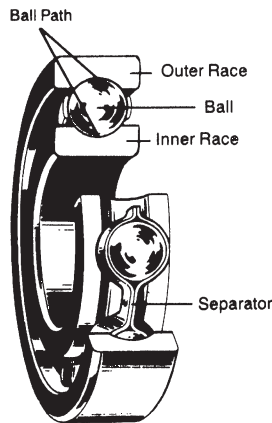

Ball bearing components
(fig. 2)

The rolling elements, shaped as balls or rollers, provide the cushion that eases the moving friction of the shaft within its housing. These elements keep the outer and inner races separated and enable them to move smoothly and freely. The shape of the rolling elements depends on the type of load, operating conditions and particular applications. It is the rolling elements that distinguish the two basic bearing categories – ball bearings and roller bearings.

There is a groove called the ball path on both the inner and outer races of ball bearings in which the balls roll. For roller bearings, the rollers roll on the flat surface of each race. This surface is called the roller path.

Finally, the separator is a metal retainer that holds the balls or rollers. Positioned between the inner and outer races, the separator keeps the rolling elements evenly spaced (fig. 2).

Ball bearing

The most popular type of ball bearing has a single row of balls. In addition to the single row design, there also are double row, angular contact and ball thrust bearings. The characteristics and uses of each type will be covered in Chapter Five.

Roller bearing

One variation of roller bearings – the tapered roller – is used extensively for fleet, automotive and other vehicular applications. Its construction differs significantly from ball bearings and other types of roller bearings.

The rolling elements and both races slant inward, much like a cone. If you extend a line along the surface of the races and rollers, and also draw one through the bearing's axis, those lines would all meet at a common point (fig. 3). Those same lines along the surfaces of ball or cylindrical roller bearings are parallel. The advantage of this design is that the tapered rollers have a positive alignment with the shaft. That is, each roller will align itself perfectly on the tapered faces of the cup (outer race) and cone (inner race).

In addition to tapered roller bearings, there are a number of other roller bearing types including cylindrical and needle bearings. The characteristics and uses of each type will be detailed in Chapter Four.

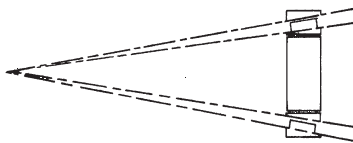

In a tapered roller bearing, all center lines converge at a common point.
(fig. 3)

Chapter 1 Review

To take this test simply place a card or sheet of paper under the first question. After you've read it (and answered it to yourself), slide the paper down below the next question. The correct answer to the first problem will appear directly to the right of the new question. Be sure not to skip any of the questions. This learning technique assures more than four times the normal retention rate for even this technical subject.

1. The bearing's smooth performance is assured by the _____.
 A. inner and outer race
 B. rolling elements
 C. separator
 D. all of the above
1. D

2. The _____ is the part of the bearing that sits directly on the shaft.
 A. outer race
 B. inner race
 C. cage
 D. cup
2. B

3. The cone is another name for the _____.
 A. separator
 B. inner race
 C. cup
 D. retainer
3. B

4. The outer race _____.
 A. is the bearing's exterior ring
 B. protects the bearings internal parts
 C. must be machined smoothly and accurately
 D. all of the above
4. D

5. The _____ is a metal retainer that keeps the rolling elements evenly spaced.
 A. seal
 B. separator
 C. bearing
 D. outer race
5. B

6. The rolling elements consist of _____.
 A. balls or rollers
 B. retainer or cage
 C. ring or cup
 D. ring or cone
6. A

7. The shape of the rolling elements depends on the _____.
- A. type of load
 - B. operating conditions
 - C. particular applications
 - D. all of the above
7. D
8. The most popular type of ball bearing has a triple row of balls.
- True
 - False
8. F
9. The concept of a bearing is to lessen the friction between an object and the surface over which it is moved.
- True
 - False
9. T
10. One variation of roller bearings – the tapered roller – is used extensively in fleet, automotive and other vehicular applications.
- True
 - False
10. T
11. The rolling elements distinguish the two basic bearing types – ball bearings and roller bearings.
- True
 - False
11. T
12. In a tapered roller bearing, the center lines do not converge at a common point.
- True
 - False
12. F
13. The separator, which retains the balls or rollers, is also called the cage.
- True
 - False
13. T
14. The roller path is the flat surface of each race on which the rollers roll.
- True
 - False
14. T
15. The separator keeps the rolling elements evenly spaced.
- True
 - False
15. T

The Bearing

As described in Chapter One, a bearing is a device used to support and guide a rotating, oscillating, or sliding shaft, pivot or wheel. Whenever a shaft rotates, it needs a bearing for smooth, effective operation.

A bearing is designed to:

- Reduce friction
- Support a load
- Guide moving parts – wheel, shafts, pivots

Reduce friction

Whether they are used in fleet, automotive or industrial applications, bearings perform the same function and have the same objective – to keep the shaft moving smoothly and consistently while reducing friction.

A bearing's rolling internal mechanism greatly reduces the effort and energy it takes to slide or move an object over the surface. This is why the invention of the bearing is so important.

Support a load

A shaft will try to push the bearing in the same direction in which the load moves. The load is dependent on both weight and direction. If the wrong type of bearing is used it may not be able to carry the required load.

There are three types of loads:

1. When the direction of the load (weight being moved) is at right angles to the shaft, it is called a "radial" load. The load pushes down on the bearing (fig. 1).
2. When the direction of the load is parallel to the shaft, it is called a "thrust" load. The load pushes sideways on the bearing (fig. 2).
3. When the direction of the load is a combination of radial and thrust, the load pushes down sideways on the bearing. This combination is called an "angular" load (fig.3).

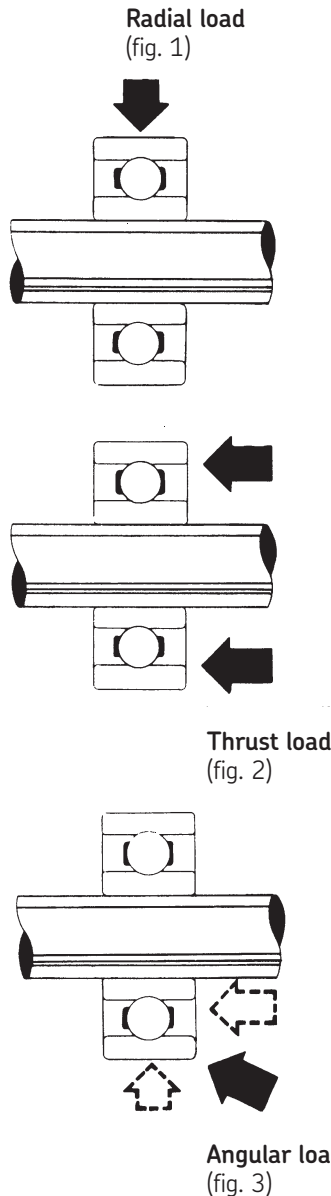

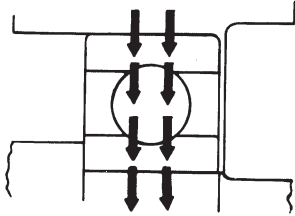

Radial load
(fig. 4)

The word “radial” means in the direction of a radius: moving from the circumference inward, or the center outward. In this case it moves from the outside in. A radial load pushes down, from the outer race inward to the balls, cage and inner race at the center of the bearing. The load is at right angles (90°) to the shaft on which it is being supported. (fig. 4).

“Thrust” means a pressure or pushing force exerted by one part against a touching part. Pressure is exerted sideways, pushing the shaft either right or left. This shaft movement then pushes the inner race of the bearing in the same sideways direction. The line of pressure, that is, the load, runs parallel to the shaft (fig. 5).

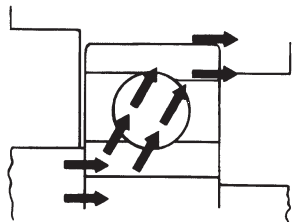

Thrust load
(fig. 5)

An “angular” load is actually a combination of radial and thrust loads. As the load moves at an angle toward the shaft, it pushes against the corner of the inner race. Pressure is transmitted diagonally, through the corner of the race, cage and rolling elements, to the opposite corner of the outer race (fig. 6).

Guide moving parts

The third function, to guide moving parts, is a result of the other two functions. By supporting a load while reducing friction, a bearing guides shaft operation. It assists the movement of crucial shafts, wheels and pivots. Without a bearing, the rotating part could not continue operating on a smooth, constant basis.

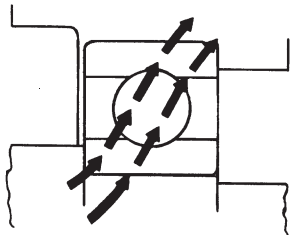

Angular load
(fig. 6)

The arrows above show how a load is dispersed through the balls or rollers of a bearing.

Chapter 2 Review

To take this test simply place a card or sheet of paper under the first question. After you've read it (and answered it to yourself), slide the paper down below the next question. The correct answer to the first problem will appear directly to the right of the new question. Be sure not to skip any of the questions. This learning technique assures more than four times the normal retention rate for even this technical subject.

1. A bearing is designed to _____.
 A. reduce friction
 B. support a load
 C. guide moving parts such as wheels, shafts and pivots
 D. all of the above
1. D
2. A bearing's rolling internal mechanism _____ the effort and energy it takes to slide or move an object over a surface.
 A. greatly increases
 B. greatly reduces
 C. has no effect on
 D. has little effect on
2. B
3. Bearings are used in _____ applications.
 A. fleet
 B. automotive
 C. industrial
 D. all of the above
3. D
4. An angular load is _____.
 A. a combination of a radial load and a thrust load
 B. a thrust load
 C. a radial load
 D. self-aligning
4. A
5. In a radial load, the load is _____.
 A. parallel to the shaft
 B. at right angles to the shaft
 C. angular with respect to the shaft
 D. none of the above
5. B
6. In a _____ load, the load is parallel to the shaft.
 A. angular
 B. thrust
 C. radial
 D. none of the above
6. B

7. A shaft will try and push the load in the opposite direction in which the load moves.

- True
- False

7. F

8. The load is only dependent on its weight.

- True
- False

8. F

9. If the wrong type of bearing is used, it may not be able to carry the required load.

- True
- False

9. T

10. "Load" refers to the direction in which the bearing moves.

- True
- False

10. F

11. A bearing guides shaft operation.

- True
- False

11. T

12. A shaft does not need a bearing for smooth, effective operation.

- True
- False

12. F

13. A bearing assists the movement of crucial shafts, wheels and pivots.

- True
- False

13. T

14. Bearings cut down on the energy needed to move an object over the surface.

- True
- False

14. T

Operating conditions

Tolerance

When it comes to size, finish and diameter requirements, all bearings of like type must meet AFBMA (Anti-Friction Bearing Manufacturers Association) standards, regardless of bearing manufacturer or the ultimate use of the bearing. In tapered roller bearings, for example, cups and cones are interchangeable. No matter how sophisticated or refined the production method, there are variances in manufacturing that will affect the bearing's dimensions.

Tolerance is the amount of deviation from prescribed nominal dimensions permitted by the industry. For example, if the nominal bore dimensions of bearing "x" (bore being the inside diameter for the inner race) is 1.838", and the tolerance is +0, -.0003", the actual size of the bore must be within the parameters established by tolerance levels. That is, the actual dimension of the bore could be as small – but no smaller – than 1.8377". It also can be no larger than 1.838", since bearing "x" cannot accommodate a larger diameter (fig. 1).

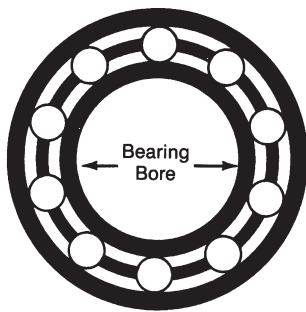

Bore Diameter
(fig. 1)

Bearing "x"	Bore Diameter
Tolerance	1.838"
+0, -.0003"	Bore Can Be
	1.8377-1.838"

Our tolerance here (+0, -.0003") is only one example for a particular bearing "x" and is not representative of all bearings. In addition to the bore, there also are tolerance levels prescribed for the bearing's outer race diameter, as well as for the width of both the outer and inner races.

In addition to the variance allowed for the bore diameter, there is also a variance permitted for the bearing's radial runout. That is the running accuracy of the inner and outer races. Radial runout is measured for each race separately.

Internal bearing clearance

Clearance is necessary so that the rollers have room to turn without building up excessive heat and friction during operation. The amount the inner race moves as opposed to the outer race, under a given radial or thrust load, is called bearing clearance. This can be measured by how much space there is between the internal parts during operation (fig. 2).

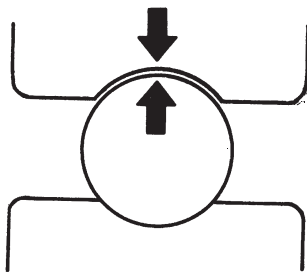

Bearings need clearance between rolling elements and races for proper operation.
(fig. 2)

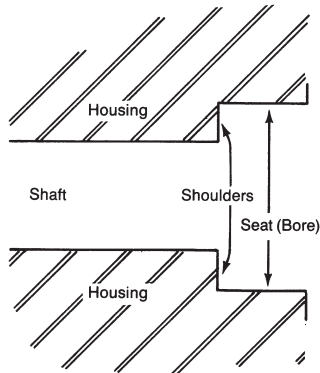

Seat components
(fig. 3)

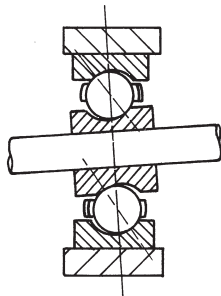

The inner race of this bearing is not aligned properly.
(fig. 4)



Inner race damage from misalignment.
(fig. 5)

Roller bearings need a small amount of space – internal clearance – to prevent excess heat build-up when the rollers turn at higher operating speeds. For the best performance under radial loads, ball bearings should have minimal clearance. This is because the groove in both races of a ball bearing is designed to provide ample clearance.

Cage clearance

In tapered roller bearings, there should be enough clearance in the housing for the cage as well, because if the cage rubs against the housing it can cause the rollers to drag. If the clearance is not sufficient, the cage may become distorted and worn, resulting in misalignment and slanting of rollers. Premature bearing failure then becomes possible.

Bearing seats

Bearing races are mounted on areas called “seats.” The cup seat is the housing (fig. 3), while the cone seat is the shaft. Within these two seats are upward extensions on which the races rest. They are called “shoulders.”

Alignment

The bearing cup and cone seats – the shaft and housing – must be properly aligned. Misalignment will reduce the capacity and life of the bearing proportionately to the amount of misalignment (fig. 4).

Here’s what happens. When the bearing is misaligned, the rollers will not carry the load along its entire length. They will carry the load, but only on a small portion near or at the ends of the rollers. This causes a concentration of load in a small area on the inner and outer race, which could result in chipping and early bearing failure (fig. 5).

Shaft and housing conditions

To assure proper bearing performance, the condition of the area in which the bearing sits – the shaft and housing – is pivotal.

Since the seat – the shaft as well as the housing – supports the bearing, there must be good surface-to-surface contact. When either seat has a rough finish or is not round, the bearing does not have the surface contact area necessary for proper performance.

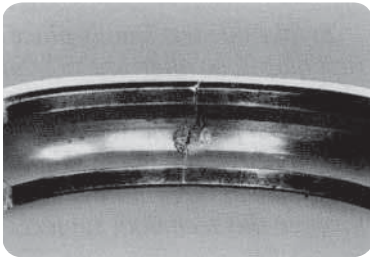

This high spot was caused by a burr in the bore.
(fig. 6)

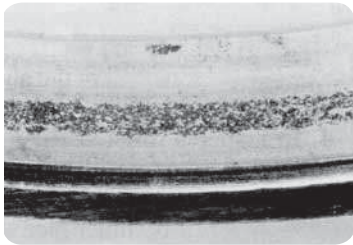

Heat damage can be caused by inadequate lubrication.
(fig. 7)

There should be no high spots or burrs. Any high spot in the housing will cause a corresponding high spot in the race. The high spot then will cause the load to concentrate in that small area. If the roller continues to hit this area, premature bearing failure will result. A burr on the shoulder or dirt on the shaft also can prevent the race from being seated properly. This may affect bearing adjustment (fig. 6).

Correct fit and surface characteristics within both the shaft and housing are as important as surface conditions to bearing performance. If either race fits too loosely, the race will creep or turn during operation. This will wear down the shaft and/or housing, and change the bearing adjustment.

Operating temperature

Type of load, shaft speed, and amount of friction all contribute to one of the most critical conditions for operation – temperature. Each component of the bearing must be constructed of materials that not only handle the load but also accommodate temperature fluctuations.

Not all heat is due to environment. The bearings themselves may cause excessive heat, because of:

1. Too heavy of a load, resulting in deformed races and rollers;
2. Friction between the rolling elements, retainer and races;
3. Excessive churning, from too much lubricant;
4. Surface friction, from too little lubricant (fig. 7).

Lubrication

Using the right type and amount of lubricant for the job is another factor critical to bearing performance. Whenever bearing use causes excess friction, heat rises accordingly. Regular lubrication helps relieve the heat that results from bearing friction. Lubrication will be covered further in Chapter Ten.

Chapter 3 Review

To take this test simply place a card or sheet of paper under the first question. After you've read it (and answered it to yourself), slide the paper down below the next question. The correct answer to the first problem will appear directly to the right of the new question. Be sure not to skip any of the questions. This learning technique assures more than four times the normal retention rate for even this technical subject.

1. _____ is necessary so that rollers have room to turn without building up excessive heat and friction during operation.
 A. Internal bearing clearance
 B. A snap ring
 C. Alignment
 D. None of the above
1. A

2. Bearing races are mounted on _____.
 A. grooves
 B. seats
 C. cages
 D. loads
2. B

3. Bearings themselves can cause excessive heat as a result of _____.
 A. too heavy of a load
 B. friction between the rollers and lubricant
 C. too much or too little lubricant
 D. all of the above
3. D

4. In a tapered roller bearing, the _____, also called the cage, is constructed with an open space over each roller.
 A. separator
 B. inner race
 C. cone
 D. cylinder
4. A

5. Roller bearings need a small amount of space, called _____, to prevent excess heat build-up when the rollers turn at higher operating speeds.
 A. alignment
 B. internal bearing clearance
 C. cage clearance
 D. none of the above
5. B

6. Operating temperature is dependent on _____.
 A. type of load
 B. shaft speed
 C. cage clearance
 D. none of the above
6. D

7. Cups and cones are interchangeable in _____.
- A. roller bearings
 - B. ball bearings
 - C. tapered roller bearings
 - D. all of the above
7. C
8. When the bearing is misaligned, the load is concentrated in a small area on the _____.
- A. races
 - B. rollers
 - C. both of the above
 - D. none of the above
8. A
9. The bearing cup and cone seats – the shaft and housing – need not be properly aligned.
- True
 - False
9. F
10. Too heavy of a load can result in deformed races and rollers.
- True
 - False
10. T
11. Heat damage can be caused by inadequate lubrication.
- True
 - False
11. T
12. Insufficient cage clearance can cause premature bearing failure.
- True
 - False
12. T
13. Misalignment may result in chipping and premature bearing failure.
- True
 - False
13. T
14. Regular lubrication helps relieve friction.
- True
 - False
14. T
15. The groove in both races of a ball bearing is designed to hold the lubricant.
- True
 - False
15. F

Roller bearing types

There are two broad categories of rolling bearings – ball and roller. In this chapter, we will discuss roller bearing types, including:

- Tapered Rollers
- Cylindrical Rollers
- Needle Rollers

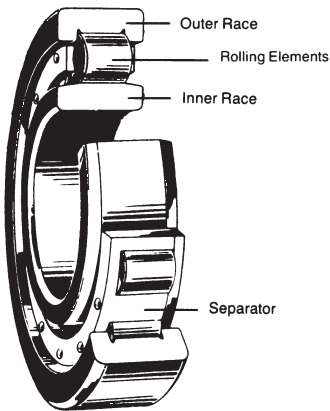

One example of a non-tapered roller bearing is the cylindrical roller bearing. (fig. 1)

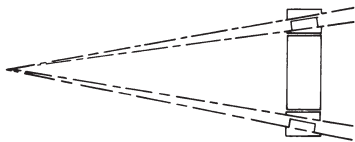

Lines extending the tapered roller bearing's inner and outer races will eventually coincide. (fig. 2)

There are two styles of roller bearings: those with “non-tapered” rollers (cylindrical and needle) and those with “tapered” rollers.

The most apparent difference between the two types is the shape of the rollers and the curvature of the races. In a non-tapered roller bearing, the centers of each part run parallel to one another (fig. 1). In the tapered roller, if the imaginary lines were run through the outer race and inner race, they would taper off and eventually coincide at a point even on a line extended through the bearing's center (fig. 2).

Other differences between non-tapered and tapered rollers, such as operating conditions, load capacity and shaft direction, will be explained in this chapter.

Tapered roller bearing

In profile, the tapered roller bearing resembles the wide edge of a cone rather than a circle. There are two major benefits to this design. First, true rolling motion is obtained. Secondly and more importantly, the bearing can handle all loads – radial, thrust or both – in any combination.

Benefits/advantages

► The first benefit of the tapered roller bearing is its cone shaped design. Each roller in the bearing can align itself perfectly between the tapered faces of the cup and cone, without guidance by the cage. That is a major development in bearing design and operation. The large end of each roller has been ground so that it is square against the rib along the back of the inner race (fig. 3). Without the “rib,” rollers would be forced from the cage (fig. 4). As each roller revolves about the cone, a wide area of contact is made between the large end of the roller and the rib. This wide area of contact compels each roller to maintain accurate alignment. With each roller perfectly aligned between the two races, the bearing works to maximum productivity. Each roller has an equal share in the total workload.

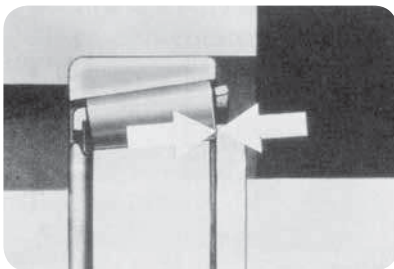

Rib restrains rollers in bearing. (fig. 3)

The separator, also called the cage, is constructed with an open space over each roller. There are grooves cut in the sides of the roller pockets that correspond to the curvature of the roller when it is in the cage. This permits the rollers to turn evenly, unhampered by cage interference.

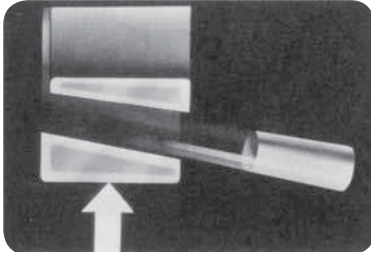

Without proper restraint the rollers would be forced from the cage.
(fig. 4)

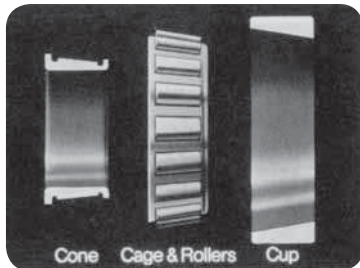

Tapered roller bearing races are separable.
(fig. 5)

► The second benefit – the bearing’s ability to support radial and thrust loads simultaneously – is a result of its internal design. A radial load on a tapered bearing produces both a radial and thrust reaction. The rib restrains the rollers and counteracts the load.

That is why adequate lubrication and proper end play adjustment are necessary to prevent excess operating temperatures. When carrying simultaneous loads, the bearing should be adjusted toward another bearing capable of carrying thrust loads in the opposite direction.

► One construction feature makes tapered roller bearings unique from most other designs: the races are separable (fig. 5). When mounted, the inner race (cone) and rollers are assembled as one unit and the outer race (cup) as another. Industry standards in size and design permit cups and cones to be interchanged when necessary.

Applications

Tapered roller bearings are used in automobiles, trucks, tractors, and various farming vehicles, including:

- Transmissions
- Transfer cases
- Rear axle shafts
- Differentials
- Front wheels
- Trailer wheels

Cylindrical roller bearing

The cylindrical type consists of four basic roller bearing parts: inner race, outer race, cage and rollers. The cylinder shaped rollers are kept evenly spaced by the cage, which guides their turning movement on the flat surface of the two races (fig. 1).

Some types have flanges or ribs, projecting from the edge of one or both of the races. This supports the rollers while permitting limited free axial movement of the shaft in relation to the housing.

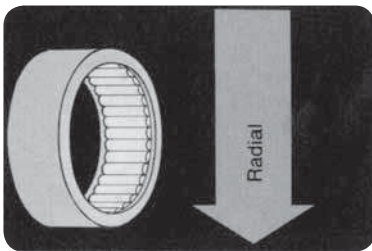

Needle roller bearing is designed to carry radial loads.
(fig. 6)

Benefits/advantages

- ▶ High capacity under radial loads
- ▶ Accurate guiding of the rollers
- ▶ Limited free axial movement (single flange design only)

Applications

- Transmissions
- Differentials
- Rear Axle Shafts

Needle roller bearing

The needle roller bearing is a variation of the cylindrical roller bearing. The main difference is in roller design capacity. The rollers are thinner in diameter, but there are more rollers per bearing. Full complement needle roller bearings do not have a cage. In this type of bearing one roller pushes against the other holding everything in place.

Benefits/advantages

- ▶ Good capacity under radial loads

Applications

- Transmissions
- Alternators
- Steering gears
- Universal joints

Chapter 4 Review

To take this test simply place a card or sheet of paper under the first question. After you've read it (and answered it to yourself), slide the paper down below the next question. The correct answer to the first problem will appear directly to the right of the new question. Be sure not to skip any of the questions. This learning technique assures more than four times the normal retention rate for even this technical subject.

1. An example of a non-tapered roller bearing is the _____.

- A. cylindrical roller bearing
- B. needle roller bearing
- C. both of the above
- D. none of the above

1. C

2. The construction feature which makes tapered roller bearings unique is that the races are _____.

- A. attachable
- B. separable
- C. self-aligning
- D. none of the above

2. B

3. The advantage of the tapered roller bearing is that _____.

- A. each roller has a share in the total workload
- B. each roller can align itself perfectly between the tapered faces of the cup and cone, without guidance by the cage
- C. its wide contact area compels each roller to maintain accurate alignment
- D. all of the above

3. D

4. Cylindrical roller bearing applications include _____.

- A. transmissions
- B. differentials
- C. rear axle shafts
- D. all of the above

4. D

5. A tapered roller bearing has the ability to handle _____.

- A. all loads in any combination
- B. radial loads only
- C. thrust loads only
- D. none of the above

5. A

6. The rib _____ the rollers in a tapered roller bearing.

- A. lubricates
- B. turns
- C. restrains
- D. none of the above

6. C

7. Some cylindrical roller bearings have flanges or ribs, projecting from the edge of one or both of the races.

- True
- False

7. T

8. Needle roller bearings have rollers thicker in diameter, with fewer rollers per bearing, than cylindrical roller bearings.

- True
- False

8. F

9. Cylindrical and needle roller bearings are examples of "tapered" roller bearings.

- True
- False

9. F

10. Adequate lubrication and proper end play adjustment are necessary to prevent excess operating temperatures.

- True
- False

10. T

Ball bearing types

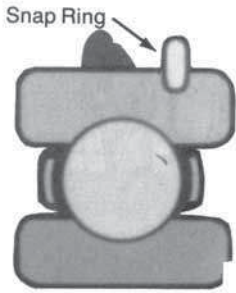

Snap rings mount ball bearings in the housing. (fig. 1)

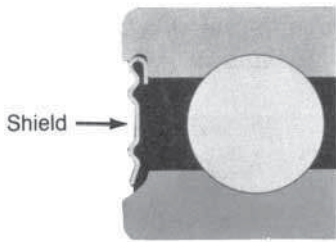

Shields prevent dirt from getting in the bearing. (fig. 2)

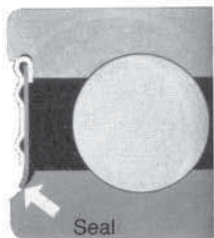

Seals prevent lubricants from leaking out of the bearing. (fig. 3)

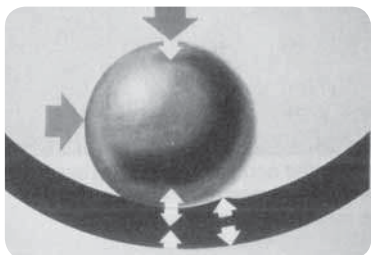

Metal bulges out in front of the ball when a load is applied to the bearing. (fig. 4)

As a group, ball bearings have many uses in trucks, cars, and off-the-road vehicles. Some of the most common are in steering assemblies, transmissions and differentials. In other applications, such as heavy-duty wheel hubs, they have been replaced by roller bearings.

In addition to the inner and outer races, rolling element and separator, there are three accessory components frequently used with ball bearings:

- Snap rings
- Shields
- Seals

Snap rings are separate components used to locate ball bearings in the housing (fig. 1). They hold the bearing in place the same way a shoulder on the shaft or in the housing would.

Shields are circular rims that cover the open space between the two races, on one or both sides of the bearing (fig. 2). They are attached to the edge of only one race, with clearance left at the inner race. Shields prevent dirt and particles from getting in the bearing, while letting excess lubrication flow through the bearing and escape if necessary.

A seal is a metal-based ring lined with a single, double or triple lip made of rubber, elastomers, synthetic or non-synthetic materials (fig. 3). It is a barrier designed to retain lubricants while excluding moisture, fine dirt, dust, or other contaminants from damaging the bearing. Unlike shields, seals prevent lubricants from leaking out of the bearing.

Operation

Though ball bearings and roller bearings share the same objective – to lessen friction – their strategies are quite different. The mechanical forces underlying ball bearing operation are simple to understand.

When a ball bearing is inactive and still, the load applied will be distributed evenly through the races and balls on the contact area. Once the bearing is nudged by a moving load, the ball starts to roll. Material in the race bulges out in front of the ball, then flattens out behind the ball. The ball flattens out in the lower front quadrant, then bulges in the lower rear quadrant (fig. 4). This process continues for each ball as long as the load is in motion.

Continual metal-to-metal contact between the balls and races will eventually wear down the parts and result in bearing failure. So even in doing its job – to lessen friction between two surfaces – the bearing creates its own internal friction. This is one reason why lubrication within the bearing is critical in relieving friction.

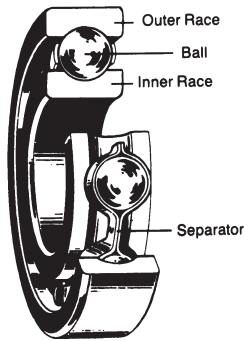

Ball bearing components
(fig. 5)

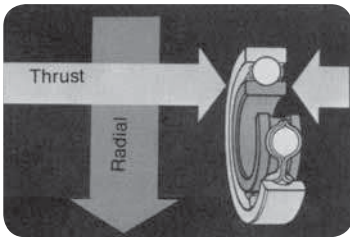

The single row ball bearing supports the thrust load in either direction.
(fig. 6)

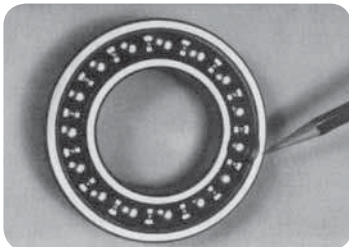

The maximum capacity bearing is a variation of the single row ball bearing.
(fig. 7)

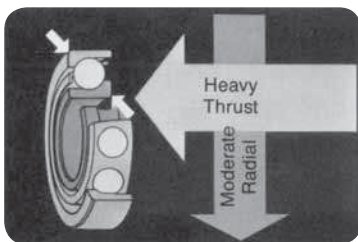

An angular contact ball bearing supports the load between opposite shoulders of the inner and outer races.
(fig. 8)

There are four different ball bearing types used in automotive and fleet applications:

- Single row
- Angular contact
- Double row
- Ball thrust

Single row ball bearing

The single row is one of the most popular ball bearing designs. A crescent-shaped cut in both the inner and outer races forms a wide groove in which a single row of balls roll (fig. 5). Though designed primarily for radial load capacity, this bearing can support substantial thrust loads in either direction, even at high operating speeds (fig. 6). Careful alignment between the shaft and housing is critical to its performance. The bearing is available with seals and shields for extra protection against contaminants, plus retention of lubricant.

A variation of the single row bearing is the maximum capacity bearing. Additional balls can be assembled in the bearing for greater radial load capacity (fig. 7). However, the extra loading area limits the bearing's thrust load capacity.

Benefits/advantages

- ▶ Good performance under radial loads
- ▶ Deep groove permits thrust load capacity in either shaft direction
- ▶ Assures contaminant-free operation when seals are mounted on the bearing

Applications

- Transmission
- Alternator
- Differential
- Steering gear
- Air conditioner clutch

Angular contact ball bearing

The angular contact ball bearing features two high thrust supporting shoulders – one on the inner race, the other at the opposite side on the outer race. The two shoulders form a steep contact angle slanted toward the bearing's axis, assuring the highest thrust capacity and axial rigidity. This design can support a heavy thrust load in one direction, sometimes combined with a moderate radial load (fig. 8).

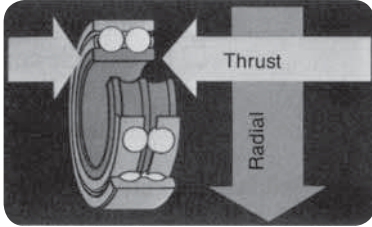

Arrows show how load lines converge at the angle of contact in a double row bearing. (fig. 9)

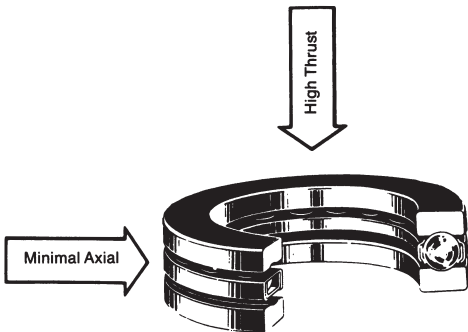

A ball thrust bearing offers high thrust capacity with minimal axial displacement. (fig. 10)

Benefits/advantages

- ▶ High thrust capacity
- ▶ Axial rigidity

Applications

- Clutch release

Double row ball bearing

The double row ball bearing combines the design principles of the single row and angular contact bearings. Like the angular contact bearing, it has grooves in the outer and inner races which are positioned so that the load lines through the balls form either an outwardly or inwardly converging angle of contact (fig. 9).

The two rows of balls assure a lower axial displacement than the single row design. That is, the bearing is less likely to become misaligned on the shaft or in the housing. The double rows can support heavy radial loads and work well under thrust loads in either direction.

Benefits/advantages

- ▶ Thrust capacity in either direction
- ▶ High radial capacity
- ▶ Less axial displacement

Applications

- Air conditioner clutch

Ball thrust

Designed primarily for clutch release applications, the ball thrust bearing has high thrust capacity. The load line runs parallel through its balls to the shaft axis, so there is little axial displacement (fig. 10). Flat shoulders on the shaft and housing are recommended under heavy loads.

Benefits/advantages

- ▶ High thrust capacity
- ▶ Minimal axial displacement

Applications

- Clutch release

Chapter 5 Review

To take this test simply place a card or sheet of paper under the first question. After you've read it (and answered it to yourself), slide the paper down below the next question. The correct answer to the first problem will appear directly to the right of the new question. Be sure not to skip any of the questions. This learning technique assures more than four times the normal retention rate for even this technical subject.

1. A seal is a barrier designed to _____.

- A. retain lubricants
- B. exclude contaminants
- C. both of the above
- D. neither of the above

1. C

2. Ball bearings are often used in _____.

- A. transmission
- B. differentials
- C. steering assemblies
- D. all of the above

2. D

3. In a single row ball bearing, a crescent-shaped cut in the _____ forms a wide groove in which a single row of balls roll.

- A. shield
- B. inner and outer races
- C. separator
- D. all of the above

3. B

4. A ball thrust bearing and a _____ bearing are used primarily in clutch release applications.

- A. single row
- B. angular contact
- C. double row
- D. all of the above

4. B

5. _____ prevent lubricants from leaking out of the bearing.

- A. Seals
- B. Shields
- C. Snap rings
- D. None of the above

5. A

6. _____ are circular rims that cover the open space between the two races, on one or both sides of a ball bearing.

- A. Snap rings
- B. Shields
- C. Retainers
- D. None of the above

6. B

7. _____ bearings are used for clutch release applications.
- A. Single row ball
 - B. Ball thrust
 - C. Tapered roller
 - D. Needle roller
7. B
8. Snap rings are used to _____ ball bearings in the housing.
- A. lubricate
 - B. relieve friction from
 - C. hold
 - D. all of the above
8. C
9. The maximum capacity bearing is a variation of the single row bearing.
- True
 - False
9. T
10. A ball thrust bearing offers low thrust capacity with maximum axial displacement.
- True
 - False
10. F
11. An angular contact ball bearing supports the load between opposite shoulders of the inner and outer races.
- True
 - False
11. T
12. Both single row and double row ball bearings are used in air conditioner clutch applications.
- True
 - False
12. T
13. The ball thrust bearing was designed primarily for clutch release applications.
- True
 - False
13. T
14. Seals mount ball bearings in the housing.
- True
 - False
14. F
15. Ball bearings do not have rolling elements or separators.
- True
 - False
15. F

Hub units



**Hub bearing
Gen.1 - ABS/TCS
(fig. 1)**



**Hub bearing
Gen. 2 - ABS/TCS
(fig. 2)**



**Hub bearing
Gen. 3 - ABS/TCS
(fig. 3)**

In the 1970's, the twin blows of expensive fuel and inexpensive imports led the US auto industry to move to front wheel drive vehicles. Incorporating the front driving mechanism into the hub and suspension greatly complicated the adjustment and maintenance of conventional tapered bearing sets. This led to the development of the hub unit, an easy to install, pre-adjusted, and lubricated for life bearing assembly. These precision engineered, more expensive units had the advantage of a pre-adjusted internal clearance which minimizes wheel wobble, premium grease and seals providing maintenance free operation, and longer service life. Hub units come in 3 styles – Gen. 1, Gen. 2, and Gen. 3.

Hub bearing Gen. 1 – ABS/TCS

Based on a double row angular contact ball bearing, Generation 1 Hub is optimized for the special operating characteristics encountered on car wheel applications. The unit offers specific support the moment load is applied to the bearing during cornering. The main components, an outer ring and two inner rings, are matched with the ball set to give the correct clearance (fig. 1).

The cages for the two ball rows are made from glass fiber reinforced polyimide. Gen. 1 is greased and sealed for life.

Used mainly for driven wheels, Gen. 1 is also found in integral drum designs on the non-driven wheels of smaller cars. With assembly space at a premium, the very compact taper units (Gen. 1 T's) are often selected.

Hub bearing Gen. 2 – ABS/TCS

Designed with the experience gained with Generation 1, Generation 2 has an outer ring with an integral flange, replacing the function of a separate hub (fig. 2).

The flanged outer ring is designed as a lightweight structural component; outer ring raceways are induction hardened for bearing performance. The flange is tough with threaded holes or studs and a spigot to center and mount brake and wheel.

The dimensions of the flange and spigot are to customer requirements. Gen. 2 is typically used with a rotating outer ring for non-driven front or rear wheels.

Hub bearing Gen. 3 – ABS/TCS

The third-generation hub bearing units carry a flange for wheel and brake rotor attachment and a second flange for fixing the unit to the suspension (fig. 3). This fully integrated system provides a significant simplification in corner design and handling when compared with more traditional designs.

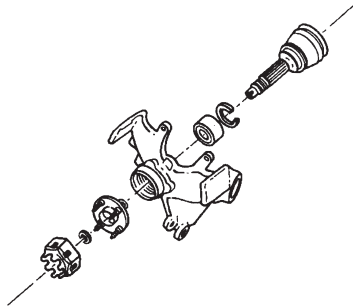

Inspect the knuckle for signs of fatigue or distortion of the bore. Replace it if in doubt.
(fig. 1)

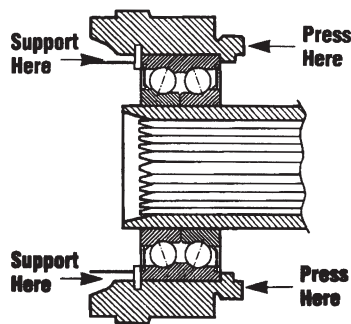

Press the bearing into the knuckle by applying force only to the outer ring of the bearing.
(fig. 2)

Press the hub into the bearing by applying force only to the inner ring and hub.
(fig. 3)

SAFETY NOTE

Never reuse the axle nut. Most self-locking nuts are deformed to hold torque loads and therefore lose their holding ability once they have been used.

The dynamic load carrying capacity is maximized by the use of a separate inner ring for the inboard ball row. This ring is mounted with an interference fit. The outer flange is bolted to the suspension. The rotating inner ring, with its tough flange, spigot and threaded holes or studs, is designed for mounting of the brake and wheel.

Gen. 3 is greased and sealed for life, and used for both driven and non-driven wheel applications. For driven wheel applications, torque is transmitted to the inner ring via an involute spline.

Hub units – fitting guidelines

Fitting instructions for hub bearing replacement in passenger cars.

When mounting or adjusting hub bearings, it is extremely important for the safety of the vehicle, as well as for the operation of the bearings, that the shop manual for the vehicle concerned is followed in detail.

Due to differences in car construction, the following guidelines are only of a general technical nature.

When replacing bearings, it is essential that the correct mounting methods are used, that the proper tools are used, and that the clean procedures are observed in handling and installing all components, particularly the bearings. Do not open the bearing package until you are ready to install the bearing. Let the rust preventive compound remain in the bearing during mounting.

Gen. 1: FWD Bearing Installation Guide

1. Loosen the axle nut while the vehicle is still on the ground. Do not re-use the old nut. Never use an impact gun on the axle nut.
2. To avoid damage to components, be sure to use the proper specialized pullers to remove the CV joint, hub and knuckle from the bearing.
3. Inspect all components for signs of fatigue or damage. Check bearing mounting bore for distortion or out-of-roundness. Any irregularities will improperly load the bearing and cause premature failure, so replace if in doubt (fig. 1).
4. Clean the bearing area in the knuckle and hub to facilitate smooth insertion. A light coating of lubricant can be applied to the knuckle cavity and hub to ease installation and inhibit corrosion.
5. When press-fitting the bearing into the knuckle, be sure to apply pressure only to the outer ring (fig. 2). When pressing the hub into the inner ring, force must only be applied to the inner ring and the hub (fig. 3). The inner ring must not move in relation to the outer ring. The application of force to the wrong part of the bearing will render it useless by severely damaging the balls and raceways. After each step, check for binding or damage by rotating the bearings to be sure it turns smoothly.

Press-fitting locks the bearing radially but to lock it axially, be sure to install the snap ring where required.

6. On older or higher mileage vehicles, consider installing a new CV Joint boot as a good preventive measure. Manufacturers recommend replacement after 60,000 miles.
7. Lightly lubricate and then carefully align the splines of the CV shaft with the splines of the hub to prevent damage. Using the proper tool, pull the axle yoke into the hub and seat against the bearing. Install a new axle nut, using the specific torque nut for that application. With the vehicle on the ground, do the final torquing to the OEM specifications. This assures the proper mating of the split inner rings of the bearing needed to achieve the proper internal clearance. (These torque specifications are now contained in the SKF Torque Specification Guide #457377).

For specific mounting instructions, refer to the vehicle manufacturer's service manual for that model.

Gen. 2: FWD Bearing Installation Guide for rear hub

1. Lift vehicle and remove rear wheel(s). Remove axle nut. Check axle nut for any thread damage and replace if needed. Loosen adjusting nut on parking brake lever, if necessary.
2. Remove disc brake caliper from back plate and disc rotor from hub (if equipped with disc brakes).
3. Remove brake drum from hub and disconnect brake pipe from wheel cylinder (if equipped with drum brakes).
4. Disconnect ABS speed sensor if equipped. Remove hub-mounting bolts. Remove rear brake shoes, stabilizer bar or other components that may interfere with hub removal. Remove hub separating axle hub and bearing if needed.
5. Installation is done in the reverse order. Be sure mounting surface is clean. Check other components for damage. Make sure torque specifications are used for all components as needed, including hub mounting bolts and axle nut.

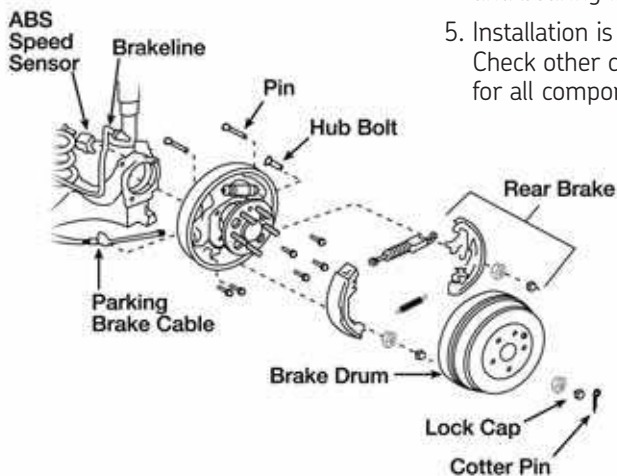

Note: Two piece axle and hub assemblies may need to be pressed apart.

Note: Some models equipped with ABS tone rings may need the tone ring switched over from the old hub unit to the new hub unit.

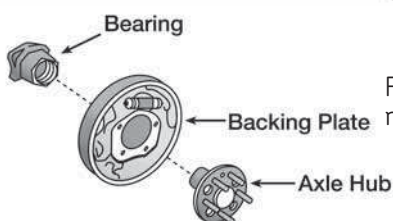

For specific mounting instructions, refer to the vehicle manufacturer's service manual for that model.

Gen. 3: FWD Bearing Installation Guide for front hub

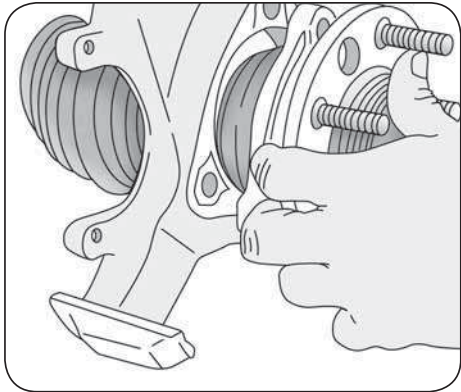

1. Lift vehicle and remove front wheel(s). Remove caliper and secure it aside.
2. Remove brake disc rotor. Remove cotter pin and axle nut. Check axle nut for any thread damage and replace if needed.
3. On models equipped with ABS, disconnect sensor connector if needed. Using steering linkage puller, loosen upper arm ball joint nut. Always be careful not to damage ball joint of toothed rotor (if equipped). Shift knuckle to outside to maintain clearance between hub mounting bolts and drive shaft.
4. Remove hub mounting bolts. Remove front hub assembly. Check other components for wear.
5. To install, reverse removal procedures. Install mounting bolts and torque to specification. Slide CV shaft stub through hub assembly. Install axle nut and torque to specifications.

6

For specific mounting instructions, refer to the vehicle manufacturer's service manual for that model.

Hub sealing problems

The function of the seal is to keep the grease inside the bearing and to avoid the entrance of water, dust and dirt, which will cause corrosion and premature bearing failure.

Appearance of a moderate amount of grease leakage is acceptable – this helps protect the seal lips from external agents such as dirt.



Appearance of a new bearing in conformance with drawing specifications.



Seal in an oblique position due to wrong fitting during mounting into the knuckle.



Seal standing out from inner and outer ring due to wrong fitting.



Detail of picture at left showing grease leakage.

Impact damage

All bearings are sensitive to shock and impact. You should **never use a hammer** in fitting a bearing. SKF recommends only proper fitting tools be used.

Remember, the wheel bearing is a safety component!

Also, before re-fitting the bearing in a knuckle, be sure that the bearing seat is clean and lightly lubricated.

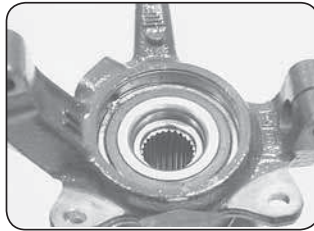

The wrong position of the seal flinger is due to improper fitting on the knuckle and spindle. Always verify lineup of the inner and outer rings.



Close-up showing damage to the spindle and incomplete fitting of the inner ring to the spindle.



ABS sensor ring is broken as a result of an external agent while car is running.



ABS cup is broken due to incorrect handling or improper fitting.

Chapter 6 Review

To take this test simply place a card or sheet of paper under the first question. After you've read it (and answered it to yourself), slide the paper down below the next question. The correct answer to the first problem will appear directly to the right of the new question. Be sure not to skip any of the questions. This learning technique assures more than four times the normal retention rate for even this technical subject.

1. A front wheel drive hub unit is _____.

- A. easy to install
- B. pre-adjusted
- C. lubricated for life
- D. all of the above

1. D

2. The integral design hub incorporates the _____ into the bearing unit.

- A. CV joint
- B. mounting carrier
- C. brake rotor
- D. tie rod end

2. B

3. After the old bearing has been removed, the mounting bore in the knuckle should be _____.

- A. checked for out-of-roundness
- B. thoroughly cleaned
- C. lubricated with a light coat of lubricant (grease)
- D. all of the above

3. D

4. When press-fitting the bearing into the knuckle, pressure should be applied _____.

- A. only to the outer ring
- B. only to the inner ring
- C. both a and b
- D. neither a or b

4. A

5. The axle nut must be torqued to the proper specification to _____.

- A. lock the bearing in place
- B. assure the proper mating of the split inner rings
- C. maintain proper internal bearing clearance
- D. all of the above

5. D

6. The two types of design used in a non-integral hub unit are a double-row angular contact ball bearing and a pair of tapered roller bearings mounted in tandem.

- True
- False

6. T

7. The non-integral hub design does not require the pressing of the drive hub into the bearing bore.

- True
- False

7. F

8. On a driven wheel the drive flange may be splined to the drive shaft.

- True
- False

8. T

9. Gen. 3 hubs do not incorporate the ABS sensing unit if vehicle is equipped with ABS braking system.

- True
- False

9. F

10. A self-locking axle nut should not be reused because the threads lose their holding ability once they have been used.

- True
- False

10. T

11. On older or high mileage vehicles it is not necessary to replace the CV joint boot as a good preventive measure.

- True
- False

11. F

12. The final torquing of the axle nut should be done with the vehicle on the ground.

- True
- False

12. T

Bearing removal and cleaning



An arbor press may be used for bearing removal.
(fig. 1)

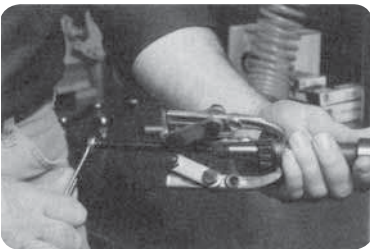

Jaw pullers grip the outer race to remove the bearing.
(fig. 2)

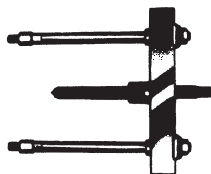

Push-pullers, manual or hydraulic, are safe for bearing removal.
(fig. 3)



Slide hammer pullers, which can remove parts from blind holes, also may be used to remove the bearing.
(fig. 4)

Proper bearing removal and cleaning can mean the difference between good performance and bearing failure. If done incorrectly, either procedure can damage the bearing, shaft or housing before installation even begins.

Bearing removal

There are a number of recommended tools and methods that assure safe, reliable bearing removal. Using hammers and drift pins, or an uneven application of force, for example, can cause as much damage to the shaft and housing as to the bearing itself.

Safe bearing removal tools include:

1. Arbor press (fig.1);
2. Mechanical (or hydraulic) jaw-type pullers that grip parts by their press-fit edges (fig.2);
3. Mechanical (or hydraulic) push-pullers that use forcing screws to push or pull parts out of the housing (fig.3);
4. Slide hammer pullers with a weighted sliding handle. It strikes a "stop" on its own rod and removes parts from blind holes (fig.4);
5. Special purpose pullers for timing gears, crankshaft sprockets, flywheel pilot bearings.

Selecting the right puller for bearing removal depends on how well the part can be gripped, how much reach and spread (height and width) are needed, and how much power or force is required. To aid in bearing removal, accessories such as extensions for jaw and cross-block pullers, attachments that split bearings, and shaft protectors are also required.

Here are some suggested methods for safe, reliable bearing removal.

Arbor press method

An arbor press applies great force, so it requires little manpower to remove bearings. It is a good method to use where one or both races have been press-fit during installation (fig.1).

An arbor press can be set up to:

- Support the bearing while the press forces the shaft out of the bearing, or;
- Support the shaft while the bearing is being forced off the shaft.

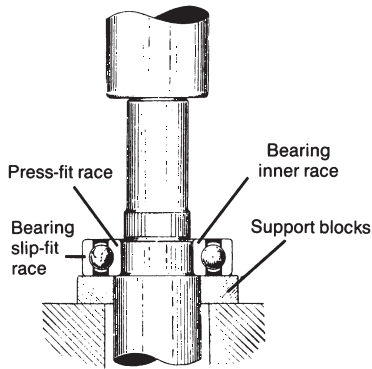

Apply force only to the press-fit race.
(fig. 5)



Pull the bearing off the shaft.
(fig. 6)

To remove a bearing with a press-fit inner race, first support the inner race on the press base plate with a bar or ring. Using the press, apply force only to that race (fig. 5). This should loosen the race and force the shaft out of the bearing. With two separable races, such as tapered roller bearings, both races may have been press-fit and should be loosened. **Never** apply force to the slip fit race or the cage.

Bearing pullers

Bearing pullers should be used when the shaft is too large, obstructed or inappropriate for removal with an arbor press.

Mount the puller so that the grip is firm and the puller is square with the surface. Again, apply force only through the press-fit race. The bearing should start to give and be easy to pull out of the housing (fig. 6).

With either the bearing pullers or the arbor press, be sure to cover the parts around the bearing to prevent them from damage. Be sure to wear safety goggles to protect yourself against eye injury.

Methods not recommended

Hammering the inner race and flame heating the bearings are two commonly used, but dangerous, methods of bearing removal.

The practice of hammering or prying to force removal can be costly and dangerous. The blunt force of the hammer can damage the shaft as well as the bearing. Even when a wood block is used to muffle the blow, splinters and wood chips can get into the housing and damage the bearing.

Using a torch to remove parts is even more dangerous. In addition to the possibility of igniting grease, oil or gas, the intense heat and open flame can weaken component parts and cause subsequent failures.



Rinse the bearing in clean solvent.
(fig. 7)

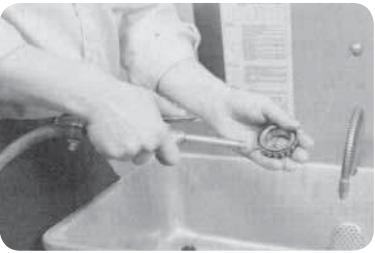

Compressed air may be used to dry the cleaned bearing.
(fig. 8)

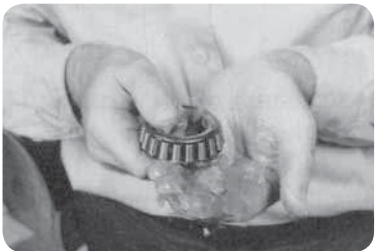

Grease the bearing.
(fig. 9)



Wrap the bearing in waterproof paper.
(fig. 10)

Cleaning bearings

Soak the bearings in a metal basket suspended in a clean container or tank holding a recommended solvent, overnight if possible. If a basket is not available, suspend the bearings with a wire or place them on a metal plate at the bottom of the container. Do not rest the bearings directly on the bottom of the bucket. (They may not clean as efficiently due to sediment on the bottom of the container.)

Under ordinary conditions you can use recommended solvents for cleaning bearings. Oils heavier than SAE 10 should not be used. Gasoline or high flash point naphthas should never be used; they are flammable as well as carcinogenic (that is, they have been known to cause cancer if handled or inhaled).

After dirt and grease are removed, rinse the bearings in another clean bucket of solvent (fig. 7). The bearings should then be thoroughly dried. The safest method is natural air-drying. Compressed air, which is free from condensed moisture, may be used to blow out the bearings, but only after all dirt and chips have been removed (fig. 8). If compressed air is used, do not allow bearings to spin and always wear safety glasses to protect your eyes from injury. **Caution: Equipment must conform to OSHA standards.**

After cleaning, inspect the bearing thoroughly for nicks, leftover dirt and damage. Inspected bearings, which are considered “good” may be used again. However, if re-assembly can not be done immediately they should be protected. Dip the cleaned bearings in a protective lubricant or coat all surfaces with a light grease (fig. 9). Rotate each bearing to work the grease thoroughly in and around the roller and on the races. Then wrap the bearings in waterproof paper and place each in a clean box or carton (fig. 10). If cartons are not available, just wrap them in waterproof paper. Mark the outside of each package to identify the bearing enclosed.

Bearings which have a shield or a seal on only one side should be washed, inspected, and handled in the same manner as bearings without shields or seals.

Bearings with shields or seals on both sides should not be washed. Instead, wipe them off to keep dirt from getting inside. Smooth rotating bearings can be coated with a protective lubricant, then wrapped and stored until they are used again.

Chapter 7 Review

To take this test simply place a card or sheet of paper under the first question. After you've read it (and answered it to yourself), slide the paper down below the next question. The correct answer to the first problem will appear directly to the right of the new question. Be sure not to skip any of the questions. This learning technique assures more than four times the normal retention rate for even this technical subject.

1. Improper bearing removal and cleaning can damage the _____.

- A. shaft
- B. bearing
- C. housing
- D. all of the above

1. D

2. The _____ is a safe bearing removal tool.

- A. arbor press
- B. drift pin
- C. hammer
- D. chisel

2. A

3. Bearing pullers should be used when the shaft is _____ for removal with an arbor press.

- A. too large
- B. inappropriate
- C. obstructed
- D. all of the above

3. D

4. The safest method of drying bearings is _____.

- A. compressed air
- B. natural air
- C. heat
- D. all of the above

4. B

5. If bearings cannot be reassembled immediately, they should be protected by _____.

- A. wrapping them in waterproof paper
- B. coating the surfaces with a light grease
- C. storing them in a clean container
- D. all of the above

5. D

6. Under ordinary conditions, use _____ for cleaning bearings.

- A. gasoline
- B. recommended solvents
- C. SAE 15 or heavier weight oil
- D. all of the above

6. B

7. When an arbor press or a bearing puller is used for bearing removal, force should only be applied to the bearing's _____.

- A. slip-fit race
- B. cage
- C. shaft
- D. press-fit race

7. D

8. To clean bearings, soak them in a _____.

- A. metal basket
- B. container with the bearings suspended from a wire or on a plate
- C. both A. and B.
- D. none of the above

8. C

9. Hammering the inner race and flame heating the bearings are safe methods of bearing removal.

- True
- False

9. F

10. Inspected bearings which are considered "good" should not be used again.

- True
- False

10. F

11. Bearings with shields or seals on both sides should be washed and stored until ready for use again.

- True
- False

11. F

12. Bearings should be allowed to spin when using compressed air.

- True
- False

12. F

13. Bearings with a seal or shield on one side only should be washed, inspected and handled the same way as bearings without shields or seals.

- True
- False

13. T

14. Using a torch to remove bearings can weaken the component parts and cause subsequent bearing failures.

- True
- False

14. T

15. Force can be applied to the slip-fit race and the cage.

- True
- False

15. F

Installation

Cleanliness, proper tools, and specific mounting guidelines are needed to assure proper installation as well as long-lasting bearing performance. Improper bearing installation is a common cause of premature bearing failure.

Pre-installation

Check the shaft and housing

A bearing cannot operate properly if the shaft or housing is not in good condition.

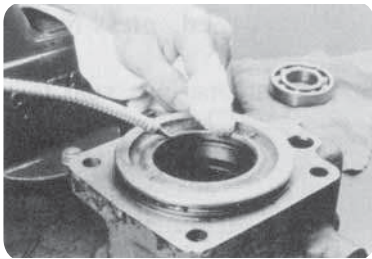

The housing must be thoroughly cleaned before installing the bearing.
(fig. 1)

Before mounting the bearing, be sure shaft and housing bore dimensions are within recommended tolerances. The bearing seat in the housing bore should be perfectly round and not tapered. The shaft and housing also should be clean and free from nicks and burrs (fig. 1).

Extra care should be taken when mounting a bearing in a solid housing. Before any installation pressure is applied, the outer race should be perfectly square with the housing bore.

Check the seal

Check the seal, which will be mounted on the shaft. Also check the shaft. Its condition is just as crucial to correct seal placement as it is to bearing operation.

Be sure to follow proper seal installation guidelines and use only the recommended tools. Always replace used seals with new ones. Use the same seal design and size as the original. A seal installed next to the bearing is a sure way to prevent fine dirt, dust, moisture and contaminants from reaching the bearing, while also retaining lubricant.

Bearing assembly

With all parts ready for assembly – bearing, shaft and housing – installation can now begin.

Do not remove the bearing from its container until you're ready to install it. Everything must be clean – tools, hands, work area, shaft and housing (fig. 2). Then take the bearing out of its protective wrapper, place it on clean paper and cover it with a lint free cloth or oiled paper.

The protective grease or oil coating on the bearing should not be removed. This protective coating was put on by the manufacturer to prevent corrosion, dirt or dust from damaging the bearing before and during use and is compatible with all lubricants.

Coat the bearing, housing and shaft with the same lubricant being used in the machinery in which it will be placed. This will ease mounting and prevent rust from building up at the press-fit contact area.



The work area should be clean before you take the bearing out of its package.
(fig. 2)

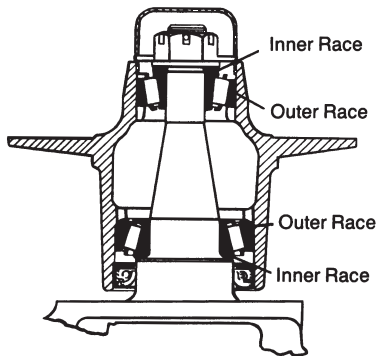

This wheel hub has the bearing's inner races mounted with a slip fit. (fig. 3)

Press-fitting the bearing

Press-fit refers to the amount of interference between the race and the seat: the inner race with the shaft, and the outer race with the housing.

If the inner race is press-fit then it will rotate with the shaft. If the outer race is to be press-fit then it will rotate with the housing. One example is in a truck's front wheel hub. Here, the inner race is mounted with a slip fit on the shaft, while the outer race is press-fit (fig. 3).

A press-fit is accomplished by stretching the inner race over a shaft slightly larger than the bore of the bearing. Press-fits that are too tight can also be damaging to the bearing. Too tight a fit squeezes the two races together, preventing the balls or rollers from turning correctly and causing excess heat and wear. The result is premature bearing failure.

In applications where only one race is press-fit, the other race gets a slip-fit – or a slightly looser fit. This slip-fit is just as important as the press-fit. When the race is too loose, it will creep up on the shaft or in the housing causing it to slam into the surface on which it is stationed. This results in friction, overheating, excessive wear and contact erosion between the shaft and inner race, or housing and outer race.

Mounting the bearing

Start the bearing on the shaft with the rounded corner of the bearing going on first. Fit a clean pipe over the shaft so that it rests only on the race being press-fit. Be sure the bearing is square on the shaft. Then apply pressure to the press-fit race only. Push the press-fit race firmly against the shoulder on the shaft. If the cup is to be press-fit, for example, apply pressure only to that race as you drive it into the housing.

Arbor press

The arbor press is one of the best means of mounting bearings and races (fig. 4). Its action is rapid and pressure can be applied continuously. During bearing installation be sure to support the inner race with two flat bars placed between the inner race and the press's adaptor plate. Special precautions should be taken when using the arbor press to align the race squarely on the shaft. Too much pressure exerted by the press could easily cause the race to crack or the shaft to become severely scored. Accessory equipment such as drive plates, tubing or pipes, which will carry the force through the press-fit race, should be used whenever possible.

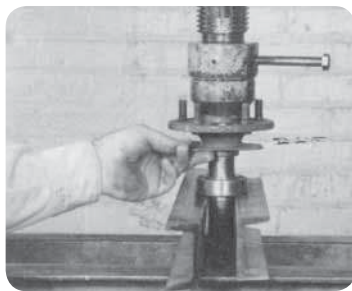

An arbor press may be used for bearing installation. (fig. 4)



Use proper installation tools.
(fig. 5)

Drivers

Drivers may be used for assembling cups, cones and tapered roller bearings. Drivers assure easier assembly by straightening the cups or cones. They also will prevent damage to bearing cages and internal parts (fig. 5).

To use the driver method, first separate the cup from the cone. Apply pressure to the races only, and drive each into position. Be careful not to hit the cage. Pressure against the cage will distort and loosen it, causing slanting of the rollers and premature bearing failure.

Never use hammers or drift pins directly on the surface of the bearing. If a hammer must be used to mount the bearing, apply pressure to a drive block, adapter sleeve, pipe or tube placed above the bearing. Direct blows to the bearing can cause cocking, denting, cracking and bearing failure (fig. 6).

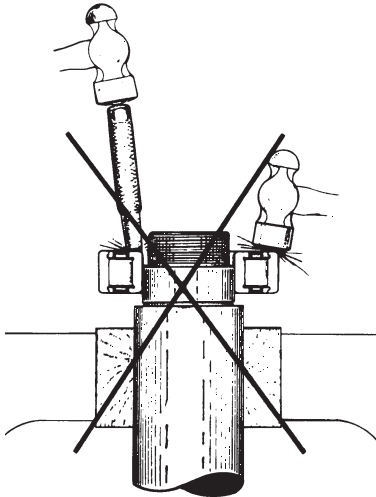

Never hammer directly on a bearing.
(fig. 6)

Clutch release bearing: a special mounting procedure

The procedure for mounting a clutch release bearing onto a carrier or sleeve that will be installed in a vehicle is somewhat different from other installation methods.

First, lubricate the bearing shoulder on the carrier with a few drops of oil. Place the bearing on a clean drill press table, with the clutch finger face down. Be sure all parts are square. Start the bearing carrier or sleeve into the bore of the bearing by hand.

Shift the drill press into the lowest available spindle speed, and close the chuck completely without the drill bit installed. While the spindle is turning, feed the chuck into the bore of the bearing carrier or sleeve until the bearing is completely seated (fig. 7). If the chuck diameter is too small or too large, use a small shanked pilot clamped in the chuck to seat the bearing.

Finally, pack the carrier or sleeve with grease before installing it in the vehicle.

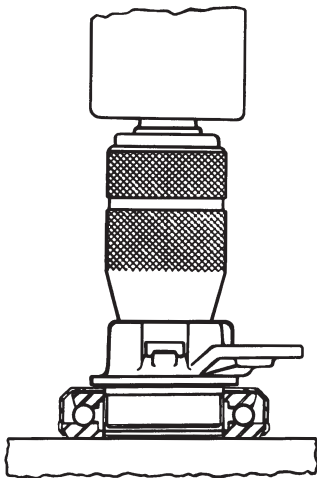

Turn the clutch release bearing while installing the sleeve.
(fig. 7)

Installation checklist

1. Work only with clean tools, clean hands and clean surroundings to avoid damage to the bearing.
2. Shaft seat and housing bore should be clean, smooth, with the correct dimensions.
3. Leave bearings in the package until ready for assembly. Do not wash off the lubricant covering them.
4. Lubricate the race being press-fit, and shaft or housing seat on which it will sit.
5. Start the bearing on the shaft with the rounded corner of the race going on first.
6. Apply even, driving pressure directly only to the race being press-fit. Be sure that pressure is straight and square.
7. Never hammer directly on races or rollers. Do not use a wooden or soft metal mallet, as chips or splinters may enter the bearing.
8. Use smart, quick taps rather than heavy ones.
9. Be sure all driving accessories and fixtures have straight, square ends.
10. Drive races solidly up against the shoulder of the shaft and housing.
11. Pre-lube bearing prior to installation.

Chapter 8 Review

To take this test simply place a card or sheet of paper under the first question. After you've read it (and answered it to yourself), slide the paper down below the next question. The correct answer to the first problem will appear directly to the right of the new question. Be sure not to skip any of the questions. This learning technique assures more than four times the normal retention rate for even this technical subject.

1. When mounting a bearing, the _____ of the bearing should be started on the shaft first.
 A. rounded corner
 B. outside edge
 C. ball or roller
 D. cage
1. A

2. Installing a _____ next to the bearing will prevent contaminants from reaching the bearing while also retaining lubricant.
 A. inner race
 B. seal
 C. shaft
 D. housing
2. B

3. Direct hammer blows to the bearing can cause _____.
 A. cocking
 B. denting
 C. bearing failure
 D. all of the above
3. D

4. The protective grease or coating applied to the bearing by the manufacturer _____.
 A. should not be removed
 B. prevents corrosion
 C. is compatible with all lubricants
 D. all of the above
4. D

5. The _____ method of bearing installation straightens the cups and cones and prevents damage to bearing cages and internal parts.
 A. slip-fit
 B. heat
 C. driver
 D. press-fit
5. C

6. Coating the bearing, housing or shaft with the same lubricant used in the machinery will _____.
- A. ease mounting
 - B. prevent rust from building up at the press-fit contact area
 - C. both of the above
 - D. none of the above

6. C

7. Premature bearing failure can result when the press-fit race is installed _____.
- A. too tight
 - B. too loose
 - C. both of the above
 - D. none of the above

7. C

8. A bearing will operate properly even when the shaft and housing are not in good condition.

- True
- False

8. F

9. Improper bearing installation is a common cause of premature bearing failure.

- True
- False

9. T

10. A bearing should not be removed from its container until it is ready for installation.

- True
- False

10. T

11. It is unnecessary to replace used seals with new ones.

- True
- False

11. F

12. A wooden hammer or soft mallet may be applied directly on the races or rollers.

- True
- False

12. F

Bearing adjustment

Once the bearing is seated on the shaft and in the housing, it is necessary to recheck installation and adjust the bearing so it operates properly for the application. Bearing adjustment recommendations vary per manufacturer, vehicle and use. Before starting any bearing adjustments, check the service manual.

First, be sure the bearing is seated squarely on the shaft, and has not been cocked or misaligned during mounting. Then check the end play (fig. 1). For tapered roller bearings, as in most applications, the best setting has free running clearance with no appreciable end play.

In general, the bearings in wheels, transmissions, and similar applications are set with free running clearance. Bearings in wheels for automobiles, farm vehicles, and tractors are set with free running clearance or end play of .001" to .010". It is a good idea to check the service manual for proper adjustment procedures.

Sometimes it is necessary to hold shafts, gears or spindles absolutely rigid in order to obtain proper performance. This can be done by pre-loading the bearing, without affecting its capacity for radial or thrust loads.

Preloaded bearings are used in pinions, differentials or other cases where the shaft must be held rigid. Check manufacturer manuals for torque recommendations. The amount of preload or the amount of end play in the bearing will depend on the bearing's overall function.

Bearing adjustment methods

Since bearing adjustment can be as critical as installation to bearing performance, it is not surprising why so many manufacturers provide adjustment guidelines. Two of the most common methods follow.

Wheel bearing

Single adjusting nut

While rotating the wheel, tighten the adjusting nut until there is a slight bind and all bearing surfaces are in contact. Then back off the adjusting nut $\frac{1}{6}$ to $\frac{1}{4}$ turn to the nearest locking hole, until the wheel rotates freely with .001" to .010" end play, or clearance. Lock the nut at this position (fig. 2).

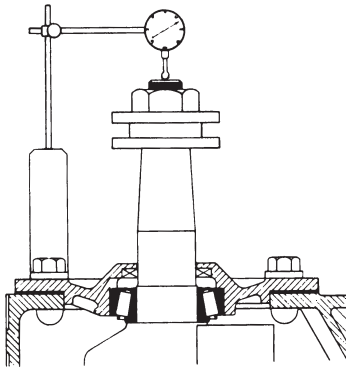

Dial indicators are used to check the amount of end play in the bearing.
(fig. 1)

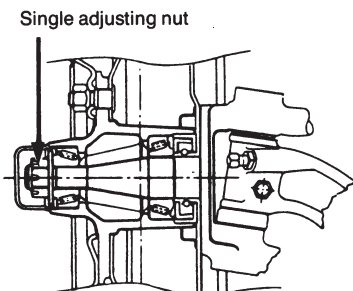

The diagram above shows a single adjusting nut in place in the wheel hub.
(fig. 2)

Double adjusting nut

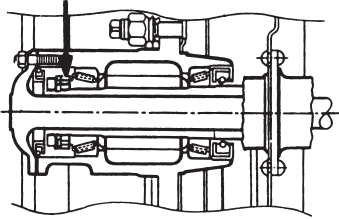

This diagram shows a wheel bearing adjustment with a double adjusting nut.
(fig. 3)

Wheel bearing

Double adjusting nut

Again, rotate the wheel and tighten the inner nut until there is a slight bind and bearing surfaces are in contact. Then back off the inner nut $\frac{1}{4}$ to $\frac{1}{3}$ turn and allow the wheel to rotate freely. Install a lockwasher, and tighten the jam, or outer nut. There should be $.001''$ to $.010''$ of end play. Lock the outer nut at this position (fig. 3).

Note: Some procedures call for the adjusting nut to be tightened to specific torque specifications. Always check the manufacturer's service manual for specific recommendations.

With either adjustment method, proper procedures must be followed. If not, bearing adjustment may be too tight or too loose, which can cause overheating and damage the bearing.

Different devices for adjusting bearings are available such as torque wrenches and dial indicators. Selection depends on the bearing type and the application in which it's being used. Basically, these devices hold the bearing in proper position, support the race, provide the end play or clearance needed and assure that the bearing is not misaligned, cocked or operating improperly.

Chapter 9 Review

To take this test simply place a card or sheet of paper under the first question. After you've read it (and answered it to yourself), slide the paper down below the next question. The correct answer to the first problem will appear directly to the right of the new question. Be sure not to skip any of the questions. This learning technique assures more than four times the normal retention rate for even this technical subject.

1. Bearings in wheels for _____ are set with free running clearance or end play of .001" to .010".
 A. automobiles
 B. farm vehicles
 C. tractors
 D. all of the above
1. D

2. Preloaded bearings are used in _____.
 A. differentials
 B. cases where the shaft must be held rigid
 C. pinions
 D. all of the above
2. D

3. The most common method(s) of wheel bearing adjustment include _____.
 A. double adjusting nut
 B. single adjusting nut
 C. both of the above
 D. none of the above
3. C

4. When installing bearings, check that the shaft seat and housing bore are _____.
 A. clean
 B. smooth
 C. the correct dimensions
 D. all of the above
4. D

5. Pack the carrier or sleeve with grease before installing it in the vehicle.

- True
- False

5. T

6. The single adjusting nut method requires that the wheel rotates freely with .001" to .010" end play or clearance.

- True
- False

6. T

7. Hammering directly on races and rollers with a steel mallet is recommended for bearing installation.

- True
- False

7. F

8. Start the bearing on the shaft with the rounded corner of the race going first.

- True
- False

8. T

9. If bearing adjustment is too tight or too loose, damage to the bearing may occur.

- True
- False

9. T

10. Some double adjusting nut methods call for the adjusting nut to be tightened to specific torque specifications. They should be checked in the manufacturer's service manual.

- True
- False

10. T

Bearing lubrication

Lubrication – coating the contact surfaces of the bearing shaft and housing with grease or oil – is one procedure used in almost every step of bearing storage and operation. With their protective coating against rust and corrosion, lubricants are applied to bearings during storage, during assembly and mounting, during operation, before removal, and after cleaning. Lubricants have four major purposes:

- Reduce friction and wear
- Dissipate heat
- Protect surfaces from dust and corrosion
- Help seals protect bearings

Reduce friction

Bearings are constantly moving during operation. Their moving races and rollers rub against each other as well as the housings around them. In application of high speeds and under heavy loads, bearings build up tremendous friction. Too much friction will wear down the surfaces by rubbing together. This results in premature failure and damage to the bearing, shaft and housing.

Lubricants reduce friction. When applied on and around the entire bearing, lubrication smooths rubbing action and saves bearing parts from early failure (fig. 1). Lubricants protect the shaft and housing in the same way.

Dissipate heat

Heat is caused by bearing friction. With shaft speed and load conditions also contributing to friction, it is not hard for overheating to occur. Heat wears down contact surfaces between the races and shaft and housing seats.

By dissipating, or carrying away this heat, lubricants can prevent temperatures from reaching a point where they can cause severe wear and destruction.

Protect surfaces from dust and corrosion

The smallest amount of moisture, dirt or dust can cause the metal in bearing parts to corrode. Because bearings must be clean and smooth in order to operate properly, corroded bearings are useless.

For this reason, bearing lubrication starts during the packaging process. Immediately after production, a new bearing is coated with oil or grease so it will not be harmed by moisture or dust that can accumulate during storage and handling prior to installation. Lubrication also protects against corrosion that can occur between the tight press-fit of a race with the bearing seat.



Lubricants reduce friction, protecting the bearing from damage.
(fig. 1)

Help seals protect bearings

Seals installed on the shaft next to the bearing retain lubricants in the housing and prevent dirt or dust from getting in (fig. 2). Not only will these contaminants nick and scratch a bearing, they also wear down the shaft and housing. A thick coating of lubricant is a barrier to contaminants, assisting the seal in lubricant retention and dirt exclusion.

Lubricant selection

Lubricant selection depends on a combination of factors: the type of housing, operating temperature, operating speed and any particular requirement of that bearing type. In all cases, the best guide for proper selection of a lubricant is the recommendation of the vehicle's manufacturer.

There are two lubricant types – grease and oil. Due to the design of equipment and the conditions under which it must operate, grease is the more widely used lubricant. Various types of grease are available and should be selected carefully.

There are certain guidelines to follow when selecting the right lube for the job. For example, open bearings are only lubricated with a film of oil or light grease to protect them from corrosion before use. They must also be lubricated while running. Sealed and shielded bearings are grease packed from the factory and are sealed for life. The lubrication used in ball and other bearing types is usually a sodium or lithium based grease or oil.

As a general rule, bearings run the coolest, and with the least amount of friction, when a minimum amount of the lightest-bodied lubricant that will keep bearing surfaces apart is used.

Use a heavier lubricant only if:

- Operating conditions require it;
- The load is too heavy for the lube;
- It is specifically called for in the application.

Heavy penetration grease will normally increase friction.

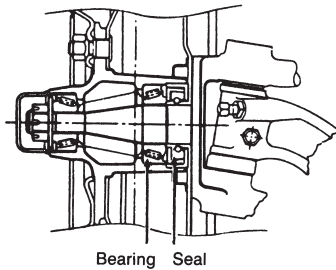

Note placement of the grease seal against the bearing in the wheel hub shown above.
(fig. 2)

Wheel bearing grease specification

Here are some general recommendations in selecting the grease for wheel bearing uses. The grease should be smooth textured, consist of soaps and oils, and be free of filler and abrasives. Recommended are lithium complex (or equivalent) soaps, or solvent refined petroleum oils. Additives could inhibit corrosion and oxidation. The grease should be non-corrosive to bearing parts with no chance of it separating during storage or use.



To lubricate the bearing, force grease around the outside of the bearing and between internal parts.
(fig. 3)

Using the correct amount of lube is essential. Failure to correctly lubricate the bearing or maintain proper lubrication may result in bearing damage, causing a wheel to lock.

To lubricate the bearing, force grease around the **outside of the bearing; between the rollers, cone and cage**. Pack more grease in the wheel hub. The depth of the grease should be level with the inside diameter of the cup. The hubcap should also be filled with grease (fig. 3).

Grease lubrication features

1. Reduces maintenance time. There are no minimum grease levels to maintain, so lubrication cycles are less frequent.
2. Is confined to the housing or bearing. This means a simpler seal design can be used to retain lubricant and exclude dirt.
3. Grease is more viscous than oil lubricants.

Oil lubrication

Since it is thinner than grease, oil needs more frequent lubrication intervals. Generally, oil is used to lubricate bearings in high temperature and/or high speed applications. It is used in heavy-duty fleet, automotive and agricultural vehicles.

Gear drivers, for example, work well with oil lubricants. For hypoid gears, where both the gears and bearings used in the units require lubrication, S.A.E. grades No. 90 and No. 140 oil are normally used. For extremely cold operating conditions (around -40°F to -60°F), a lighter No. 80 grade is used. At high temperature and for heavy-duty applications, use the S.A.E. 140 grade. For extremely heavy loads and extremely high temperatures, S.A.E. 250 is recommended.

Be sure not to mix vehicle motor oil with gear oils, as they could be incompatible.

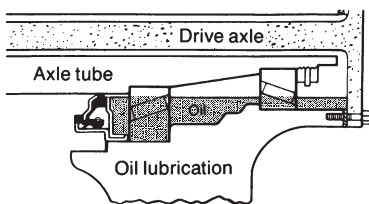

The depth of the oil should be level with the inside diameter at the cup.
(fig. 4)

Oil lubrication features

1. The correct amount of oil lubricant is easier to control than grease.
2. Oil lends itself more to the lubrication of all parts.
3. Oil flows better in lower and higher temperatures than grease.

General recommendation

Whatever type of lube – grease or oil – is selected, be sure to remember some very fine points that will help a bearing to continue performing well, or cause it to fail.

1. Never wash the protective lubricant off new bearings.
2. Use clean lubricants contained in clean, air-tight cans or drums. Store them in a cool, dry area. Dirt, dust or moisture in the lube can lead to eventual bearing failure.
3. Use only the lubricant called for in the job. No substitutes or interchanges (grease instead of oil, for example) should be made unless specified by the equipment manufacturer.
4. Do not overfill the housing (fig. 4). Too much grease or oil can seep out of overfilled housings, past seals and closures. The lube that escapes can collect dirt and cause damage to the bearings.
5. Too much lubricant can also cause overheating. This is particularly true of bearings running at high speeds, where the churning of the lubricant will cause the bearing to run too hot.

Chapter 10 Review

To take this test simply place a card or sheet of paper under the first question. After you've read it (and answered it to yourself), slide the paper down below the next question. The correct answer to the first problem will appear directly to the right of the new question. Be sure not to skip any of the questions. This learning technique assures more than four times the normal retention rate for even this technical subject.

1. Lubricants are applied to bearings _____ to protect against rust and corrosion.
 A. during storage, assembly, mounting and operation
 B. before removal
 C. after cleaning
 D. all of the above 1. D

2. Use a heavier lubricant only if _____.
 A. operating conditions require it
 B. the load is too heavy for the lube
 C. it is specifically called for in the application
 D. all of the above 2. D

3. Grease used for wheel bearings should be _____.
 A. non-corrosive to bearing parts
 B. smooth textured
 C. made up of soaps and oils
 D. all of the above 3. D

4. Too much bearing lubrication can cause _____.
 A. contamination
 B. overheating
 C. leakage
 D. all of the above 4. D

5. Oil is generally used to lubricate _____ applications.
 A. high temperature
 B. high speed
 C. heavy-duty fleet, automotive and agricultural vehicles
 D. all of the above 5. D

6. Grease lubrication features include _____.
 A. reduced maintenance time
 B. less leakage than oil
 C. confines itself to the housing or bearing
 D. all of the above 6. D

7. When lubricating bearings, the depth of the grease should be _____ the inside diameter of the cup.
- A. level with
 - B. higher than
 - C. lower than
 - D. none of the above
7. A
8. Lubrication does not protect against corrosion occurring between the tight press-fit of a race with the bearing seat.
- True
 - False
8. F
9. SAE 250 is the recommended oil lubrication for extremely heavy loads or high temperatures.
- True
 - False
9. T
10. Lubricants do not reduce friction or protect bearings from damage.
- True
 - False
10. F
11. Sealed and shielded bearings are grease packed and sealed for life.
- True
 - False
11. T
12. Since grease is thinner than oil, oil requires less frequent lubrication intervals.
- True
 - False
12. F
13. Vehicle motor oil and gear oils can be mixed.
- True
 - False
13. F
14. Oil flows better in lower and higher temperatures than grease.
- True
 - False
14. T
15. Applying the correct amount of grease lubricant is easier to control than oil.
- True
 - False
15. F

Bearing maintenance

Now the bearing has been selected, assembled, mounted, adjusted and lubricated. Assuming that the procedures have been done carefully to manufacturer's specifications, the bearing should do its job correctly.

But how well – and how long – a bearing wears also depends on maintenance. This includes:

- Inspection of the bearing, shaft, and housing for damage;
- Double checking the mounting and assembly;
- Re-lubrication at suggested intervals;
- Making adjustments as necessary; and
- Cleaning the bearing.



A simple inspection can provide valuable insight into bearing performance and failure.
(fig. 1)

Regular inspection

Regular schedules for inspection of the bearing should be set up on an individual basis. Follow the timetable suggested by the vehicle manufacturer. Inspection includes checking for anything that could affect bearing operation (fig. 1). Look for nicks, grooves and polished surfaces on the shaft and in the housing. Check surface color. Are there rust spots? Generally, any bands that are blue or brown signal overheating of the bearing; whether it's caused by poor lubrication, tight fit or misalignment. Check to see that the bearing, shaft and housing fit squarely, without cocking.

As far as maintenance schedules, there are two basic categories of bearing use. The first includes gear drives, transmissions and similar equipment where the bearings are designed to last as long as the machine or gears. As long as the bearings are sealed and lubricated well, they should be inspected only when the unit is down for repairs or a complete overhaul. Otherwise, it is recommended that the gear drives, transmissions and similar equipment be flushed out annually with kerosene or light oil, to clean out any dirt or foreign materials that may have collected. Also, whenever the unit is down for a long period of time, old lubricants should be removed and replaced with fresh oil or grease. This prevents any moisture or foreign matter which might have been in the old lubricant for settling. It also prevents pitting or corrosion in the bearings.

The second maintenance schedule group includes bearings which must be removed on a frequent basis. In wheel bearings packed with grease, for example, the grease should be changed and the seals replaced at regular intervals. The recommended practice is to repack the wheel bearings in automobiles every 20,000–30,000 miles. Wheels in trucks, trailers, farming and other vehicles may go for longer or shorter periods depending on design and use. They should never run more than a year without repacking. Remember, when the wheel bearings are repacked, the old seals must be replaced.

Double checking installation and adjustment

In checking installation, compare your method with the steps detailed in Chapter Eight. Do the same with bearing adjustment.

Check lubrication

Check lubrication levels so that friction, excess heat and corrosion are not building up to bearing failure levels. Also, be sure lubrication levels have not been exceeded, and that the lube specified for the job is the one being used. This was detailed in Chapter Ten.

Cleaning the bearing

Finally, remove the bearing for inspection. Clean or replace them when necessary, or according to manufacturer recommendations. Complete bearing removal and cleaning were explained in Chapter Seven.

During your bearing maintenance procedures, you may spot problems that can cause bearing failure or damage to the surrounding parts. Troubleshooting – from spotting the problem to solving it – will be covered in Chapter Twelve.

Chapter 11 Review

To take this test simply place a card or sheet of paper under the first question. After you've read it (and answered it to yourself), slide the paper down below the next question. The correct answer to the first problem will appear directly to the right of the new question. Be sure not to skip any of the questions. This learning technique assures more than four times the normal retention rate for even this technical subject.

1. Bearing maintenance includes _____.
 A. inspecting the bearing, shaft and housing for damage
 B. cleaning the bearing
 C. re-lubricating
 D. all of the above
1. D
2. Bearing inspection schedules should be based on _____.
 A. mileage
 B. the manufacturer's timetable
 C. both of the above
 D. none of the above
2. C
3. For proper operation, the _____ must fit squarely.
 A. bearing
 B. shaft
 C. housing
 D. all of the above
3. D
4. When wheel bearings are replaced, the seals must be _____.
 A. cleaned
 B. replaced
 C. repaired
 D. checked
4. B
5. Blue or brown bands on a bearing generally indicate _____.
 A. overheating
 B. rust
 C. inadequate lubrication
 D. shaft nicks
5. A
6. In _____, the grease should be changed and the seals replaced at regular intervals.
 A. sealed bearings
 B. gear drives
 C. wheel bearings packed with grease
 D. machine gears
6. C

7. Automotive wheel bearings should be replaced every 45,000-55,000 miles.

- True
- False

7. F

8. A simple inspection can provide valuable insight into bearing performance and failure.

- True
- False

8. T

9. Check to see that the bearing, shaft and housing fit squarely, without cocking, during regular inspections.

- True
- False

9. T

10. When a unit is down for a long time period, it is unnecessary to replace the oil or grease.

- True
- False

10. F

11. Wheels should never run more than a year without repacking.

- True
- False

11. T

12. The seals should be replaced when bearings are repacked.

- True
- False

12. T

13. Lubrication levels can cause friction, excess heat and corrosion to build up to bearing failure levels.

- True
- False

13. T

Troubleshooting

Ball and roller bearings are designed for longevity. Their life expectancy, based on metal fatigue, can usually be calculated if general operating conditions are known. Bearing failures not caused by normal material fatigue are called premature failures. The causes may range from improper lubrication to incorrect mounting, to poor condition of shaft housing or bearing surfaces.

Premature bearing failure can be avoided. That's the objective of this chapter: to identify the visible "danger" signs on bearing, shaft and housing surfaces. These signs of bearing damage include:

- Brinelling
- Contamination
- Fretting
- Peeling
- Spalling
- Misalignment
- Electric Arcing
- Seizing

Brinelling

Brinelling refers to indentations pressed into the bearing race, so tiny that they are hardly visible to the eye (fig. 1). These indentations, although minor, usually precede more serious, deeper cuts and dents that ultimately result in bearing failure.

Brinelling found on the race causes corresponding dents on the balls or rollers. Though less visible than those on the race, the brinelling on balls or rollers is more noticeable in its interference with bearing movement.

Causes

Brinelling on the high part of the race shoulder is often caused by pressure against the unmounted – rather than the press-fit – race during installation. Hammering the bearing during installation or removal may cause brinelling on the shoulder of the race.

Brinelling also is caused by bearing impact during operation. In a wheel, for example, a bearing set with excessive end play may not resist the impact and pounding action as the wheel goes over uneven or rough roads. The rapid short impact pounds the rollers into the races, causing brinelling and even fracturing.

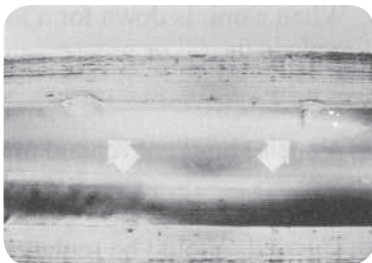

Brinelling found on the bearing race usually causes more serious dents on the balls or rollers.
(fig. 1)

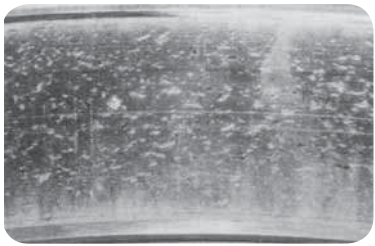

Contamination appears as scratches, pitting and scoring along the bearing's raceways.
(fig. 2)

Prevention

Brinelling caused by incorrect mounting can be prevented by exerting pressure only on the press-fit race. Eliminating any direct hits with a hammer on the bearing is another measure worth taking. Brinelling caused by heavy impact during operation is usually avoided by setting the bearing to the recommended amount of end play.

Contamination

Contamination of the bearing shows up as scratches, pitting and scoring along the raceways, with corresponding marks on the ball and roller surfaces (fig. 2). Unlike brinelling, these small indentations are scattered, rather than centralized, on the bearing surface.

Causes

When seals or shields are defective it is not hard for abrasive particles, dirt, or dust to get into the bearing. There can even be dirt or dust in the lubricant.

Wherever foreign material enters into the bearing by way of contaminated lubricant, the particles are pressed into the metal surface. Small dents and pits are formed which roughen the load-carrying surface. Severe roughness will result in flaking and premature bearing failure.

Contamination can also be caused by improper cleaning of the housing or shaft, or by using dirty tools and hands during mounting and assembly.

Prevention

Everything coming into contact with the bearing, shaft or housing should be clean, including your hands, tools and work area. Lubricant should be stored only in clean containers and covered with a tight lid during storage. Before mounting a new bearing, be sure the shaft and housing are free of dirt, dust and moisture. When changing the wheel or installing a new bearing, use only new, not used, seals.

Fretting

When small metal particles decay and break off of the bearing races, it is called fretting (fig. 3). Fretting occurs when there is excessive rubbing between the inner race and the shaft, or the outer race and the housing, or any surface overstressed under excessive oscillated loads. This excess friction causes the contact area to wear down or corrode.

Some fretting corrosion is a normal part of the bearing fatigue process. The condition worsens until the contact surfaces become so weakened that soon, the bearing fails.



Fretting occurs when excessive friction causes metal particles to break off the bearing race.
(fig. 3)

Causes

Fretting frequently is caused by poor shaft or housing fits. Races with too loose a fit, for example, may rub against the shaft or housing when they should be stationary. Lubricant levels kept too low also permit excess friction and corrosion.

Prevention

Be sure shaft and housing fits are correct for the application, so the bearing cannot move out of place. Micronized graphite and other special lubricants are sometimes used to relieve the rubbing pressure.

Peeling

Peeling is a light scraping away of the bearing's surface (fig. 4). The damage is usually just superficial, normally less than .001" deep. It should not affect bearing performance unless conditions exist that promote greater damage.

Causes

Peeling damage most often is related to improper lubrication. There may not, for example, be enough lubrication in the bearing (along the inner diameter of the cup) which can result in peeling on the unprotected surface. Use of a high viscosity lubricant – one that is unable to flow freely – also promotes peeling. Misalignment, which will be covered later in this chapter, may cause peeling at the edge of heavy contact.

Prevention

Check lubrication levels in the bearing to be sure an ample amount is present at all times. When lubricating a wheel hub, for example, force grease into and around the races, cage and rollers. Also check the shaft, housing and bearing during mounting for misalignment.

Spalling

Spalling is an advanced stage of bearing decay. Caused by metal fatigue, the failure begins as microscopic cracks beneath the bearing surface. These tiny fractures work their way to the surface, and eventually result in the flaking away of metal particles (fig. 5). The uneven surfaces caused by metal flaking away prevent normal bearing operation. Failure is inevitable. Because of the rough race surface and loose metal chips, there also will be bearing vibration and noise.

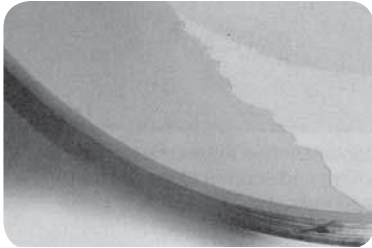

A superficial scraping of the bearing's surface is known as peeling.
(fig. 4)



Spalling begins as small fractures under the bearing's surface.
(fig. 5)

Causes

Spalling occurs under normal conditions as part of bearing fatigue. However, it can result from another type of initial bearing damage, such as brinelling or fretting, that has caused indentations, weakening or abrasion, on one or both of the races.

Almost any type of handling, installation, mounting or maintenance procedure done incorrectly can result in spalling. For example, a bearing mounted on a shaft with excess press-fit causes friction to build up and wear down the bearing surfaces. Dirt, dust and contamination will abrade and score the races. Moisture in the housing can settle on and then corrode the bearing surface, resulting in flaking. Improper lubrication can fail to relieve friction, leading first to peeling, and then possibly to spalling. Misalignment prevents even load distribution, and spalling may occur in the high stress areas. High spots or grooves in the housing also may cause corresponding grooves in the bearing that lead to spalling. Whether it is normal or premature, bearing failure from spalling is irreversible.

Prevention

Use proper procedures for handling, assembling and inspecting bearings. Replace defective seals and shields, so contaminants cannot get into the bearing. Use only clean lubricants and tools and be sure lubrication levels are adequate. Check for scratches, nicks and grooves on the shaft and in the housing. Double check bearing alignment and press-fit.

Misalignment

If the balls or rollers of a bearing are running from one side of the race to the other side – and not along a straight path – then one race is misaligned with respect to the other. That is, the two races are not square with each other. Because of the misalignment, there will be uneven load distribution on the races and rollers, causing friction and heat to build up at the points where there is excess pressure and weight.

Misalignment can be identified by a diagonal polishing on the inside of the stationary ring, while the rotating ring develops flaking across the entire raceway. The excess friction that builds up will eventually discolor the roller path and rollers, and destroy the lubricant (fig. 6).

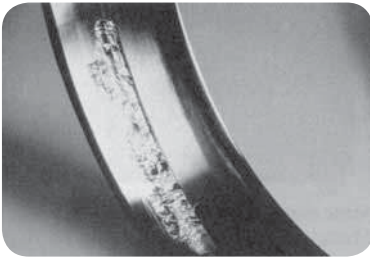

Friction caused by misalignment will discolor the roller path and rollers.
(fig. 6)

Causes

The shaft may be misaligned in relation to the housing, causing an overload on the balls or rollers and eventual bearing failure. Misalignment also may be caused by the housing being cocked and not square with the shaft. The housing shoulder may become disoriented, forcing the bearing's outer race to cock in relation to the inner race. The bearing may have been installed with too much clearance or press-fit, causing the two races to be out of line with each other.

Prevention

Misalignment of the shaft and housing should be checked and corrected before bearing installation. Be sure the shoulders are in line and square. When press-fitting a bearing, follow the steps outlined in Chapter Seven.

Electric Arcing

Electric currents can damage a bearing. When even a small amount of voltage passes through a bearing, it will burn a pit into the race at the point of contact.

Causes

Electric current passing through a bearing, such as during welding on a vehicle without proper grounding, causes arcing and burning at the point of contact between the races and rollers (fig. 7). This can range from a single burn spot, or, as often happens with roller bearings, a series of small burns between the roller and race along the line of contact. These burns cause grooves along the affected surface (fig. 8). As the current continues to pass through the bearing, the contact points change as the bearing turns.

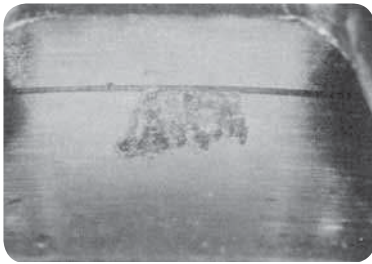

Electric currents passing through a bearing cause arcing and burning.
(fig. 7)

Prevention

Properly ground the vehicle so that it will route electrical current around the bearings. Inspect the bearing to be sure that any stray currents have not passed through the races.

Seizing

Seizing is a common form of failure when bearings are first put into service. When the rolling elements fail to roll, the resulting friction generates excessive heat very rapidly (fig. 9). Seizing frequently occurs between the cone back face and the large end of the roller on tapered roller bearings. The cages are usually either damaged or destroyed when this occurs.

Causes

Improper or inadequate lubrication can result in a breakdown of the oil film between the rolling elements and raceways. The resulting metal to metal contact generates excessive heat which reduces the hardness of the metal. Localized welding of the rollers or balls to the raceways will rapidly seize the bearing.

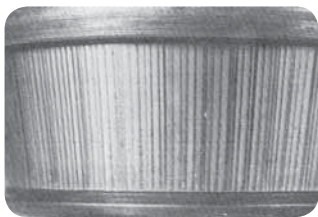

Electric current also causes grooves on the bearing.
(fig. 8)

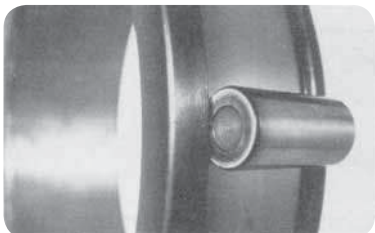

Seizing damage usually appears on the rollers.
(fig. 9)

Prevention

Carefully select the proper amount and type of lubricant that will maintain a film between the rolling elements and raceways. Remember to prelubricate whenever necessary before installation.

Conclusion

Preventing bearing failure depends on how well you know the bearing, and the application for which it will be used. This study guide should provide you with the basics for bearing care. Remember, it takes only a small mistake in handling, lubrication, installation or maintenance to result in large scale damage – not only to the bearing, but to the overall area in which it operates.

Whenever there is a bearing, there is a seal – either working in tandem or close by. To help you become as familiar with seals as you now should be with bearings, there is a companion self-study program. The SKF Shaft Seals Self-Study Program covers selection, installation and maintenance of grease and oil seals, along with the Speedi-Sleeve line of wear sleeves.

Copies of the SKF Shaft Seals Self-Study Program are available by contacting the SKF Customer Service through the Marketing Communications Department of SKF. Be sure to specify SKF Shaft Seals Self-Study Guide for automotive #457492 or for heavy duty #457935.

Chapter 12 Review

To take this test simply place a card or sheet of paper under the first question. After you've read it (and answered it to yourself), slide the paper down below the next question. The correct answer to the first problem will appear directly to the right of the new question. Be sure not to skip any of the questions. This learning technique assures more than four times the normal retention rate for even this technical subject.

1. _____ may result in premature bearing failure.
 A. Contamination
 B. Electric arcing
 C. Peeling
 D. All of the above
1. D

2. Brinelling caused by incorrect mounting can be prevented by _____.
 A. tightening bearing adjustment
 B. applying pressure only to the slip-fit race
 C. applying pressure only to the press-fit race
 D. forcing grease into the races
2. C

3. _____ occurs when small particles decay and break off of the bearing races.
 A. Fretting
 B. Peeling
 C. Electric arcing
 D. Seizing
3. A

4. Contamination can be caused by _____.
 A. defective shields
 B. improper cleaning of the housing or shaft
 C. using dirty tools or hands
 D. all of the above
4. D

5. Premature bearing failure may occur if there is _____.
 A. a hairline indentation on the bearing
 B. a sudden impact
 C. an electric current passing through a bearing
 D. all of the above
5. D

6. _____ occurs when the balls or rollers of a bearing are running from one side of a race to the other, instead of along a straight path.
 A. Spalling
 B. Misalignment
 C. Peeling
 D. Fretting
6. B

7. Misalignment of the shaft and housing should be checked and corrected _____ bearing installation.

- A. during
- B. after
- C. before
- D. without regard to

7. C

8. To prevent peeling, lubricate the _____.

- A. races
- B. cage
- C. rollers
- D. all of the above

8. D

9. _____ occurs under normal conditions as part of bearing fatigue.

- A. Spalling
- B. Misalignment
- C. Electric arcing
- D. Peeling

9. A

10. A _____ on the bearing's surface indicates peeling damage.

- A. blue or brown band
- B. superficial scraping
- C. high spot
- D. none of the above

10. B

11. Premature bearing failure cannot be avoided.

- True
- False

11. F

12. Bearing failures caused by normal material fatigue are known as premature failures.

- True
- False

12. F

13. Contamination appears as scratches, pitting and scoring along the bearing's raceways.

- True
- False

13. T

14. When lubricating a wheel hub, force grease only into the rollers.

- True
- False

14. F

15. A high viscosity lubricant will help prevent peeling.

- True
- False

15. F

Glossary of Terms

Angular contact ball bearing

Features two high thrust supporting shoulders that form a steep contact angle slanted toward the bearing's axis to assure high thrust capacity and axial rigidity.

Anti-friction bearing

A term commonly given to ball and roller bearings.

Axial

Pertaining to the line about which the shaft rotates.

Ball bearing

An anti-friction bearing using balls as rolling elements.

Bore

Inside diameter of the inner ring.

Brinelling

Indentations pressed into the bearing race that precede more serious dents ultimately resulting in bearing failure.

Cage

A device which partly surrounds the rolling elements and travels with them, the main purpose of which is to space the rolling elements in ball bearings and space and guide in roller bearings.

Cone

The inner ring of a tapered roller bearing.

Contamination

Dirt, dust and fine metal particles trapped in the bearing, causing surface scratches along the raceways, with corresponding marks on the ball and roller surfaces.

Cup

The outer ring of a tapered roller bearing.

Cylindrical Roller

Roller having a cylindrical shape.

Cylindrical roller bearing

Rolling surface parallel to bearing axis.

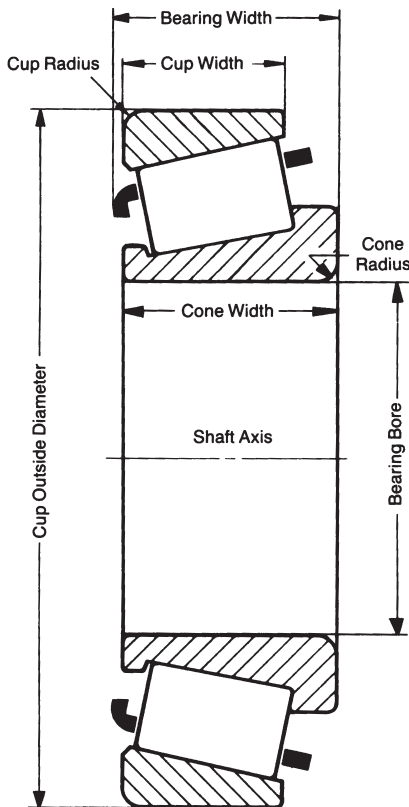

Double row ball bearing

Combination of the design principles behind the single row and angular contact bearings.

Fretting

When small metal particles decay and break off of the bearing races, due to corrosion.

Housing

Any fixture in which a bearing is mounted.

Housing fit

The amount of interference or clearance between the bearing outside diameter and housing bore seat.

Inner races

Also known as the inner race, sits directly on the shaft.

Needle roller

A load carrying rolling element of a needle roller bearing, generally understood to be long in relation to its diameter.

Outer rings

Also known as the outer race, the bearing's exterior ring that protects its internal parts.

Peeling

A light scraping away of the bearing's surface.

Preload

Preload commonly refers to internal loading characteristics in a bearing which is independent of any external radial and/or axial load carried by the bearing.

Press fit

Refers to the amount of clearance between the race and the seat, the inner race with the shaft, and the outer race with the bearing.

Races

The inner ring or outer ring of a cylindrical or needle roller bearing.

Radial load

Load which may result from a single force or the "resultant" of several forces acting in a direction at right angles to the bearing axis.

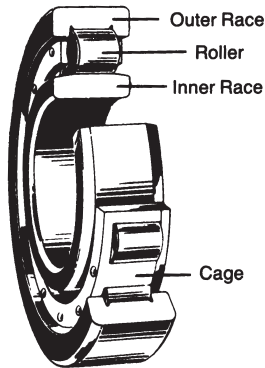

Cylindrical roller bearing

Retainer

See Cage.

Roller

Load carrying rolling element.

Roller diameter

Nominal diameter of roller.

Sealed bearing

A ball or roller bearing protected against the loss of lubricant and from outside contamination.

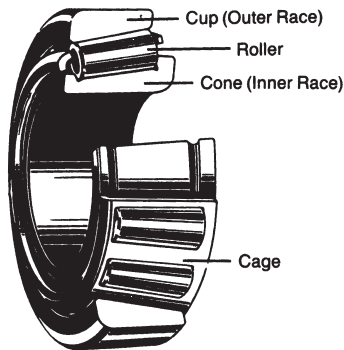

Tapered roller bearing

Seat

An area on which bearing races are mounted.

Shoulders

Upward extensions against which the races rest, within the cup seat and cone seat.

Single row ball bearing

Designed primarily for radial load capacity, this bearing has a crescent-shaped cut in the inner and outer rings to form a wide groove for the single row of balls to roll.

Snap ring (bearing location)

A removable ring used to axially position a bearing or outer ring in a housing bore.

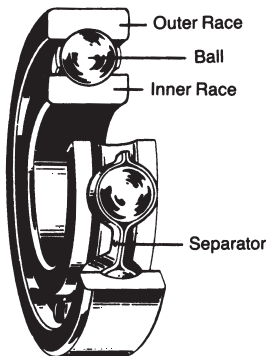

Ball bearing

Spalling

Microscopic fractures beneath bearing surface that eventually enlarge, weaken the metal surface and cause advanced, irreversible bearing decay.

Thrust load

Load which results from a single force or the "resultant" of several forces acting in a direction parallel with the bearing axis.

Viscosity

Resistance to flow.

Notes

Install confidence

with the growing line of high quality
SKF automotive products



Automotive technicians worldwide are installing confidence – and building long-term customer loyalty – with high quality SKF brand components. Our expanding product line includes wheel bearing kits and unitized hubs, transmission rebuild kits, seals, timing belt kits, Speedi-Sleeve® shaft repair kits and more. Broad market coverage and world-class logistics assure the right part, at the right place, at the right time. For more information about all the ways we can help you install confidence in your customers, too, contact your SKF distributor. Or visit us online: www.vsm.skf.com.



Be Car Care Aware

