

REIMAGINING THE MID-MARKET ENGINEERING EXPERIENCE

Accelerate design innovation and get products to market
faster with the power of cloud technology

THE CHANGING WORLD

Market trends are greatly impacting engineering processes.

Technological advances and shifting consumer demands are changing the nature of products.

According to a report by McKinsey, more and more everyday objects will become smart in the future and demand for them is set to increase.¹

The same report estimates that, by 2020, consumers in Western Europe will spend more than €12 billion annually on smart devices and applications.

In our hyper-connected, hyper-speed world, it's not enough to just develop products and services. Consumers now expect full experiences.

A report by Deloitte said that consumers are not just embracing personalization and customization, they want to put a "personal stamp" on the products they consume.²

This places pressure on manufacturers to deliver products that enable a higher level of engagement and authenticity.

As a result of all these forces, products are getting more complex, intricate and advanced than ever before.

To deliver in this environment, small- and medium-sized companies with tight resources need a solution that can address the engineering and design challenges they face regularly.

In this space, engineers and designers can gain the confidence to create in an increasingly complex ecosystem.

And this has to be done without delay: The market is getting more competitive as more businesses enter the market.

Therefore, to emerge victorious in this market, companies need to meet consumer demands and get products to market faster and at lower costs.

Companies that fail to deliver will lose customers and be deemed irrelevant, but those that can will emerge victorious in a competitive and changing world.

The following pages will detail the solution that will help you conquer these challenges.

THE POWER OF THE CLOUD

Companies are becoming aware that in order to emerge as winners in a changing and competitive market, it is vital to invest in technology.

Many are turning to cloud solutions.

IDC, a US-based global technology analyst firm, reported that 90 percent of organizations that are best-in-class in digital transformation are using multiple cloud services and platforms.³

“Year over year, total public cloud software spending is growing around 27 percent,” said Eric Newmark, its program vice president for SaaS (software as a service), enterprise apps and industry cloud.⁴

Cloud users list the following benefits driving their interest in public cloud:

- Increased business agility
- Improved security
- Improved staff productivity

The migration to cloud platforms is set to continue, and Gartner expects company expenditure on cloud-related services to increase to 28 percent by 2022.⁵

“Cloud shift highlights the appeal of greater flexibility and agility, which is perceived as a benefit of on-demand capacity and pay-as-you-go pricing in cloud.”

— Michael WARRILOW,
Research Vice President, Gartner.⁶

Cloud technology is especially beneficial for smaller and newer firms, as its many qualities provide the ability to compete with bigger players.²

Here's how:

LOWER COSTS: Access to high-powered computing without the need to invest in expensive IT infrastructure and experts.

OPERATIONAL FLEXIBILITY: Rapidly scale up or down to suit project requirements. This allows companies to experiment with new products and to quickly adapt to a fast-paced, uncertain and competitive environment.

SECURITY: Intellectual property is protected by eliminating the need for users to download or copy data.

SIMPLICITY: Most cloud platforms have simple, consistent user experience, which allows even non-technical users to collaborate.

COLLABORATION AND CONNECTIVITY: Instantly communicate and collaborate with colleagues and partners anywhere and anytime.



ENGINEERING WITH THE CLOUD



INTRODUCING: CATIA ON THE CLOUD

Dassault Systèmes has been helping engineers and designers create complex designs for decades via CATIA, a product design and experience solution that has been used in multiple industries to develop products.

With CATIA's ability to model any product, engineers, designers and all contributors can effortlessly imagine, define and shape products virtually before committing to a prototype.

CATIA, powered by the **3DEXPERIENCE®** platform, enables startups or mid-market engineering companies to achieve engineering excellence via its powerful array of social and collaborative 3D modelling and simulation tools.

Now available as CATIA on the Cloud, mid-market engineering companies can have access to the same solution used by industry leaders at a fraction of the cost. They can start operating on the platform almost immediately without the heavy up-front investments needed for IT infrastructure, personnel or systems.

CATIA on the Cloud's powerful features will enable you to accelerate innovation, get products to market faster and ultimately take you to the top of a tough, competitive market.

ENGINEERING
WITH THE CLOUD

10 REASONS TO CHOOSE CATIA ON THE CLOUD

1. Best-in-class engineering

Design anything you want without limits

CATIA's high geometric accuracy guarantees the highest quality for part and tooling surfaces. Its robust and stable design modification tools allow users to generate many design iterations and explore new solutions. It can achieve this while maintaining high performance even though users are designing models with a huge number of features.

Design for manufacturing

Take into account manufacturability constraints at the early design stage, validate the manufacturability of designs with advanced analysis tools and create associative data for the tooling and manufacturing process.

Work without limits on large and complex assemblies

Manage large assemblies with agility within a realistic visualization environment, and easily define and retrieve a working context. Ensure assembly integrity with clash detection and clearance check capabilities.

Enjoy a smooth engineering process workflow

Get everything done within a single environment that unifies all engineering disciplines. This allows for digital continuity throughout the whole project, from concept design, detailed design, simulation, manufacturing and so on.

This means that users can easily explore more ideas and disruptive engineering solutions without losing time. Users can also enjoy an integrated experience with no separation between 3D authoring and data management.



2. Collaboration and connection

To speed up innovation and processes, seamless collaboration is essential. With CATIA on the Cloud's powerful database platform, colleagues, suppliers and external partners can innovate together more efficiently and effortlessly. This results in compressed cycle times and fewer late changes.

Work in parallel

Work together on the same project data on the same platform. Collaborate and work in parallel. This means multiple stakeholders can securely open and work on the same project with security. They can all save their different modifications at the same time too.

Protect engineering intellectual property

Banish worry about unauthorized access to intellectual property by easily giving project collaborators different rights. For example, some users can be given read and write access only on some parts of the product, and modification or editing rights on other parts.

Speed up collaboration

Easily integrate external parties by using the platform's user and license management system. The platform's security features can place limits on external partners' access to confidential data.

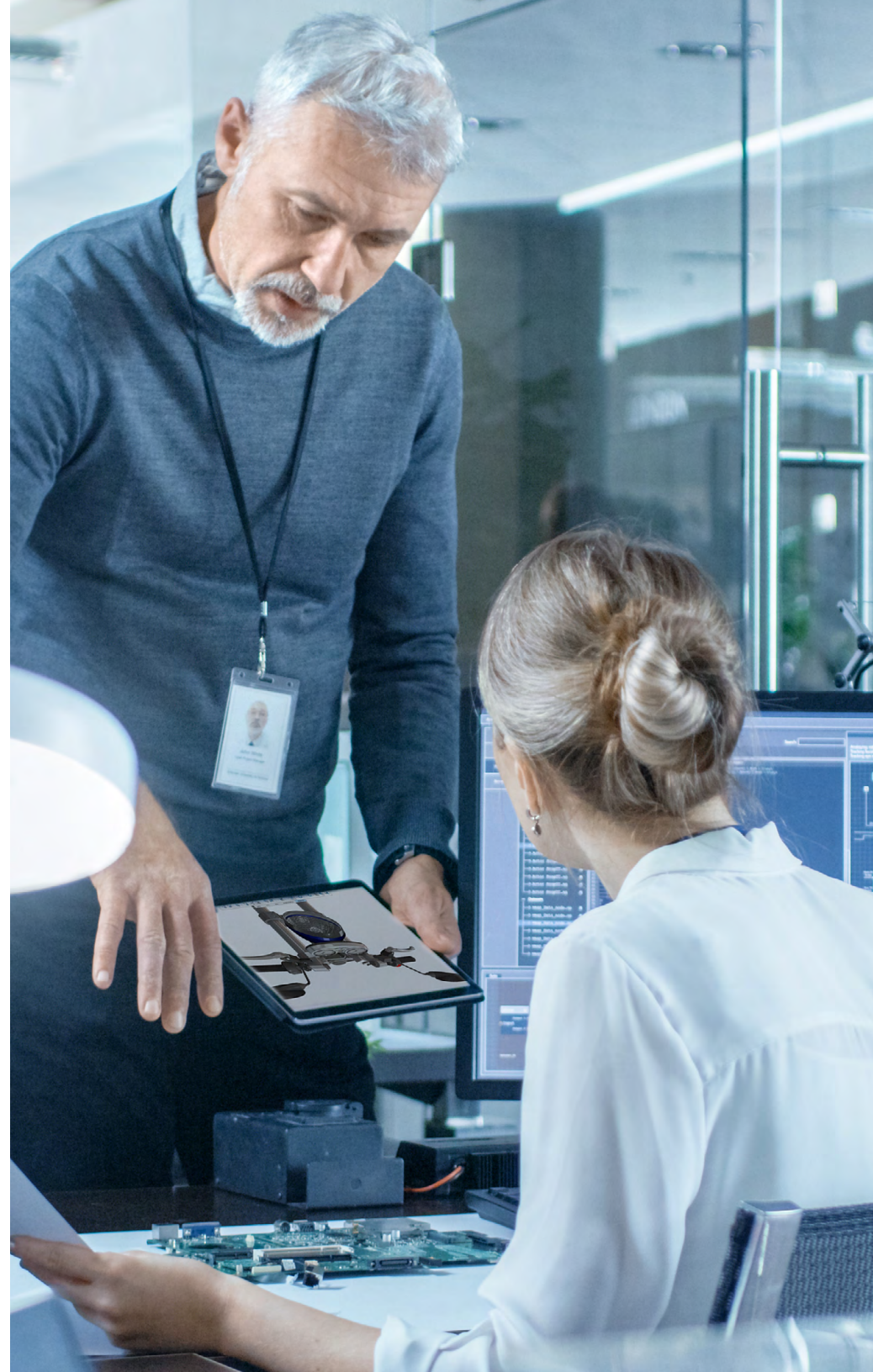

3. Easy to install and maintain

Work flexibly and efficiently while reducing the need for expensive hardware, complex IT systems and IT administrators.

Here's why:

Instant deployment

All it takes is a few clicks and a few minutes.

Scalability

Easily install new applications, add users and increase data storage according to the project's needs.

Reduced total cost of ownership

Keep investments low by relying less on hardware, IT infrastructure and IT specialists.

24/7/365 support and operation

When working via CATIA on the Cloud, everything is maintained and supported by Dassault Systèmes around the clock.

Operational flexibility

Easily scale stakeholder access to projects as they become larger and require more resources.

4. Succeed in complex design

As products grow in complexity and variance, it is becoming more and more essential to have powerful tools that enable users to execute complex designs. Fortunately, the platform has several features that will make this a reality:

Quickly model complex shapes using advanced parametric surface features

Create high-quality and complex mechanical shapes with a robust feature-based approach. Users can simplify, accelerate and check surface designs while increasing efficiency on repetitive and manual tasks.

Check the validity and repair advanced imported surfaces to guarantee downstream usage

Benefit from assets and reuse existing designs. Check the validity and repair advanced imported surfaces to guarantee downstream usage, such as manufacturing or tooling design, by improving the topology and the geometry.

Reuse surfaces – whatever their quality – with tolerant modeling capabilities

CATIA's geometrical modeler is able to manage operations on surfaces that have some small geometrical gaps and defects. The smoothing capabilities and the tolerant lay down options help designers perform their usual tasks by compensating for the gaps and still generating high-end quality surfaces.

Develop and morph any parametric surfaces

Work with folded and unfolded surfaces to verify producibility and to enable bulk calculation and raw material costs for flattened shapes. Shapes can be morphed under the control of reference and target elements while maintaining quality and accuracy for manufacturability.

Accelerate designs with a better user experience

The CATIA Generative Shape Design extension significantly speeds up the design process with a clear and intuitive user interface, with natural manipulation and contextual interactions.

Depending on your selection, relevant commands are suggested directly in the 3D model. This improves productivity, not only in completing the design more quickly, but also in reducing the time needed to understand and perform the modeling changes.



Create high-quality and complex mechanical shapes with CATIA on the Cloud's robust features

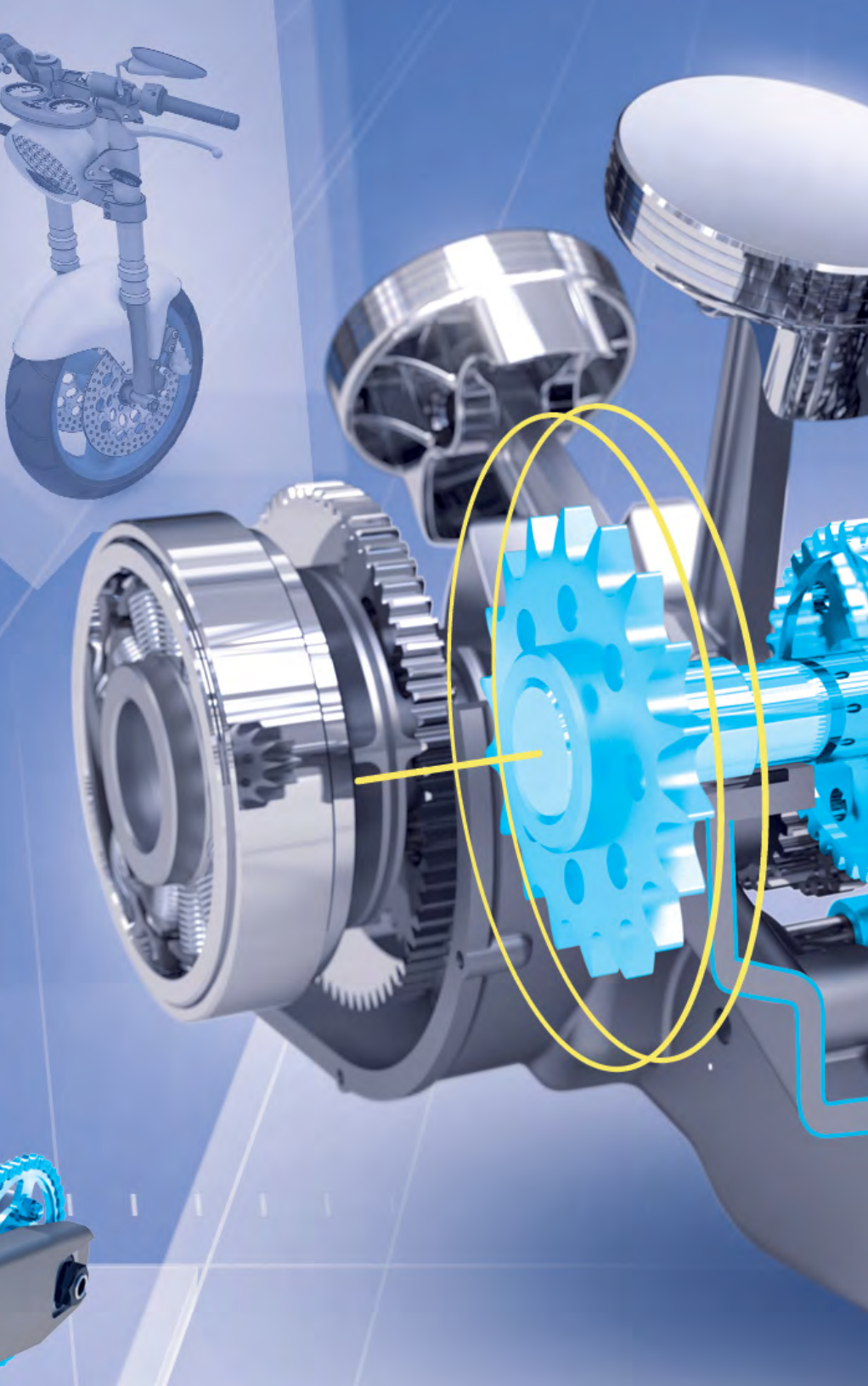

5. Improve the quality of your product

In the modeling phase, poor quality geometry causes longer update times, reduces the number of possible iterations, and induces larger amounts of data, which results in a need for more storage space.

In downstream processes, the level of quality doesn't just impact updates, but also computation time.

The impact of these factors can differ from one company to another depending on their chosen methodologies and processes. This demonstrates that shape quality has a major influence and must be taken into account as it has an impact on processes.

With CATIA, you can reach the best level of high-end surface quality using local surface modifiers and global deformation.

Design intent is respected because surfaces match both aesthetic and manufacturing requirements.

Also, data exchange workflows and manufacturing operations can be streamlined by creating controlled simplified surfaces. This ensures that users receive data they can readily use.

6. Optimize the manufacturing process

Work in a highly productive environment to compute, update and optimize shapes to compensate for complex manufacturing deformation effects such as springback. There's no need to redesign the product or its tooling.

Bring virtual definition closer to real-life definition when you can create virtual shapes from simulation, computation or digitization results.

CATIA on the Cloud's breakthrough technology allows the morphing of complex shapes while maintaining their original quality characteristics, thus optimizing:

- Manufacturing processes by compensating forming deformation
- Product definition by taking into account product representation in operational conditions, whatever the domain (mechanical, thermal, fluidic or more)

7. Capitalize, automate and reuse

Boost productivity by reusing existing functions or components that include a company's best practices.

Users can capitalize on assets and generate a family of components to accelerate design.

Some of the ways the platform can ease users' work:

Reduce tedious and repetitive tasks with intuitive automation functionalities

Repetitive tasks that need to be done hundreds of times a day can be automated via CATIA's simple and lean knowledgeware language.

Achieve first-time-right product engineering with adaptive templates

Create templates to store the intelligence and expertise of your company. For example, specific 3D models can be reused in different contexts.

Ensure product data quality by applying capitalized design rules

Create specific rules to ensure that all the products designed are compliant with your company's design rules.

New products are rarely developed from scratch, therefore it's important to be able to carry over previous designs.

Reuse existing CATIA V5 data in 3DEXPERIENCE CATIA

CATIA V5 is a proven and widely adopted solution that is deeply embedded in the corporate engineering process. This is why Dassault Systèmes planned for the two solutions to co-exist from the beginning. Users can work with people on the same project regardless of whether they are working on CATIA V5 or 3DEXPERIENCE CATIA.

Interact efficiently with your ecosystem by using and modifying any kind of computer-aided design (CAD) data

Choose what should be duplicated, reused or deleted.

Reduce costs and improve quality

Reuse existing assets and standards with smart carry-over using a graphics-based duplication tool and component family.

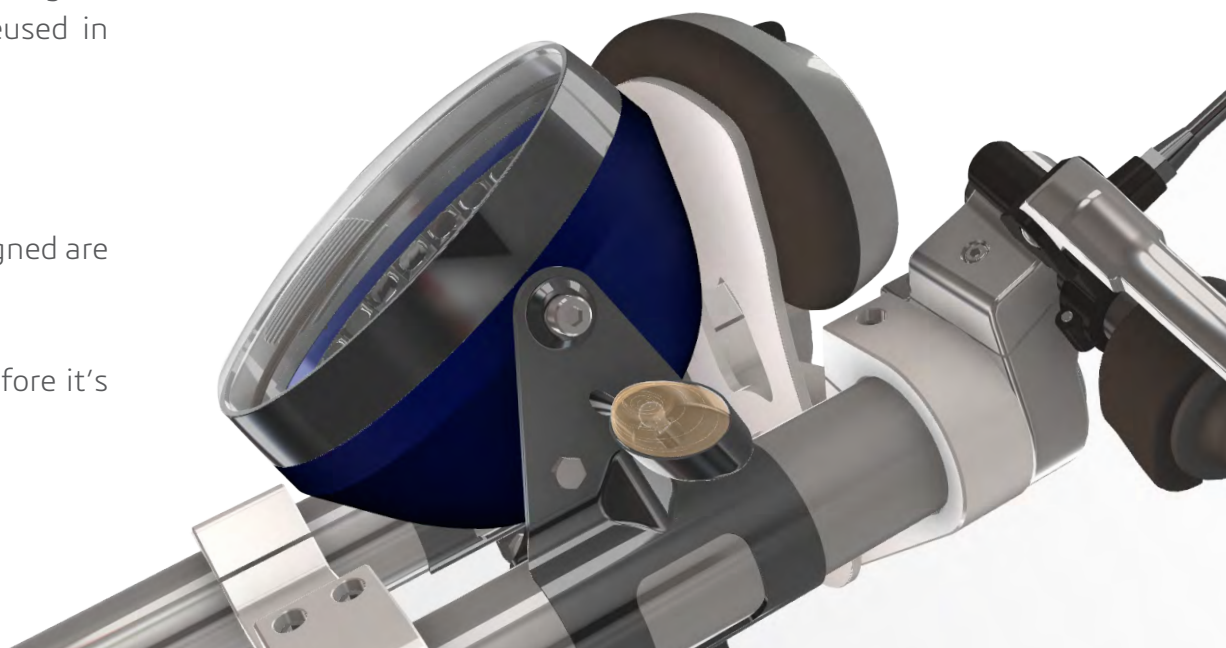

8. Access the right information directly in 3D

Although 3D is commonly used in the design process, 2D still remains, for some, the master reference for product definition. As a result, many companies are still suffering from errors and delays because 2D inherently has limitations on what can be shown.

Using CATIA, one can completely define a part and assembly with tolerances and annotations directly in 3D, making the definition more accurate. This, in turn accelerates the development processes.

This 3D Master approach means there is one single, full 3D definition of a product for manufacturing. Users can create dimensions and tolerances on the 3D geometry while respecting regulations and standards.

The semantic tolerancing advisor helps users create consistent dimensional definitions and prevent errors.

If required, 2D layouts can be created for printing based on the 3D definition. These representations are associative to and synchronized with the 3D model ensuring consistency.

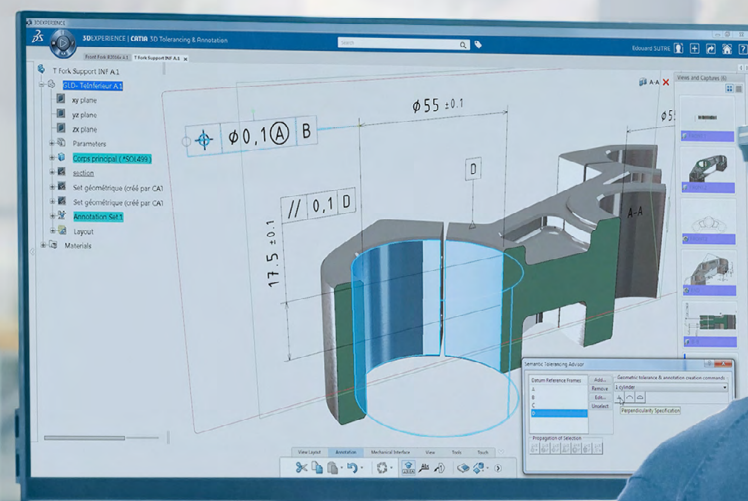

9. Set in motion and validate your ideas

It's vital for product engineers and designers to limit physical prototypes and get the design right the first time.

By simulating complex product behavior in one unified environment, decisions can be made during the virtual stage of development before investing in expensive prototypes.

Engineers and designers can understand the structural behavior of a product early in the design process by simulating them in motion. Concepts can be quickly validated for structural strength at an early stage with intuitive stress simulation tools for solid parts and assemblies.

They can also track and analyze the entire kinematics behavior of the system and make necessary adjustments.

With CATIA on the Cloud's ability to create digital mockups, designs and concepts can be quickly validated at an early stage and verified.

In the end, digital mockups allow a better understanding of problems so that one can quickly solve it.

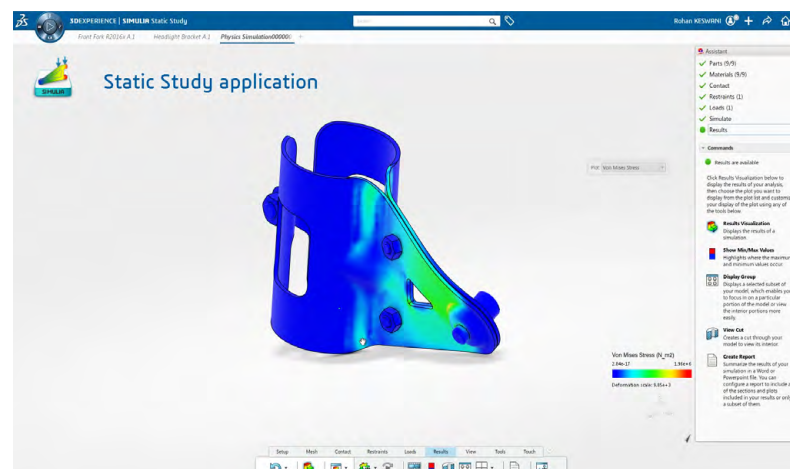
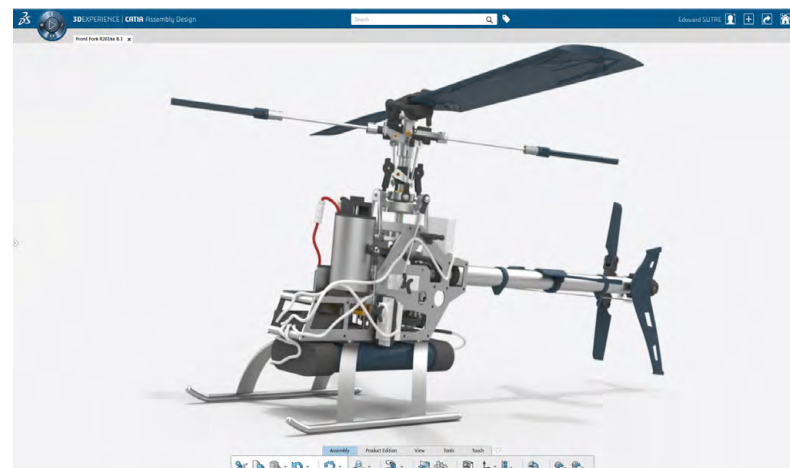

Simulate complex product behavior virtually

10. Productive user experience

The platform's lean and intuitive user interface ensures that it will be simple to use — even for new or casual users. This allows engineers to focus on being engineers.

One behavior for all applications

Applications have the same user interface with the same elements to ensure ease of use and a quick learning curve.

Direct geometry manipulation

Work directly with models by visually manipulating their geometric dimensions.

Customizable Action Pad for quick access to favorite commands

With the Action Pad, users do not need to use the action bar to find the right commands. Everything is available at the click of a mouse via the Action Pad.

CATIA ON THE CLOUD: THREE SPECIAL OFFERS

There are three specific offers within CATIA for mid-market engineering companies. Each has a unique level of specialization:

1. Sheet Metal Excellence Designer

This entry-level core engineering package allows users to design core mechanical and sheet metal parts.

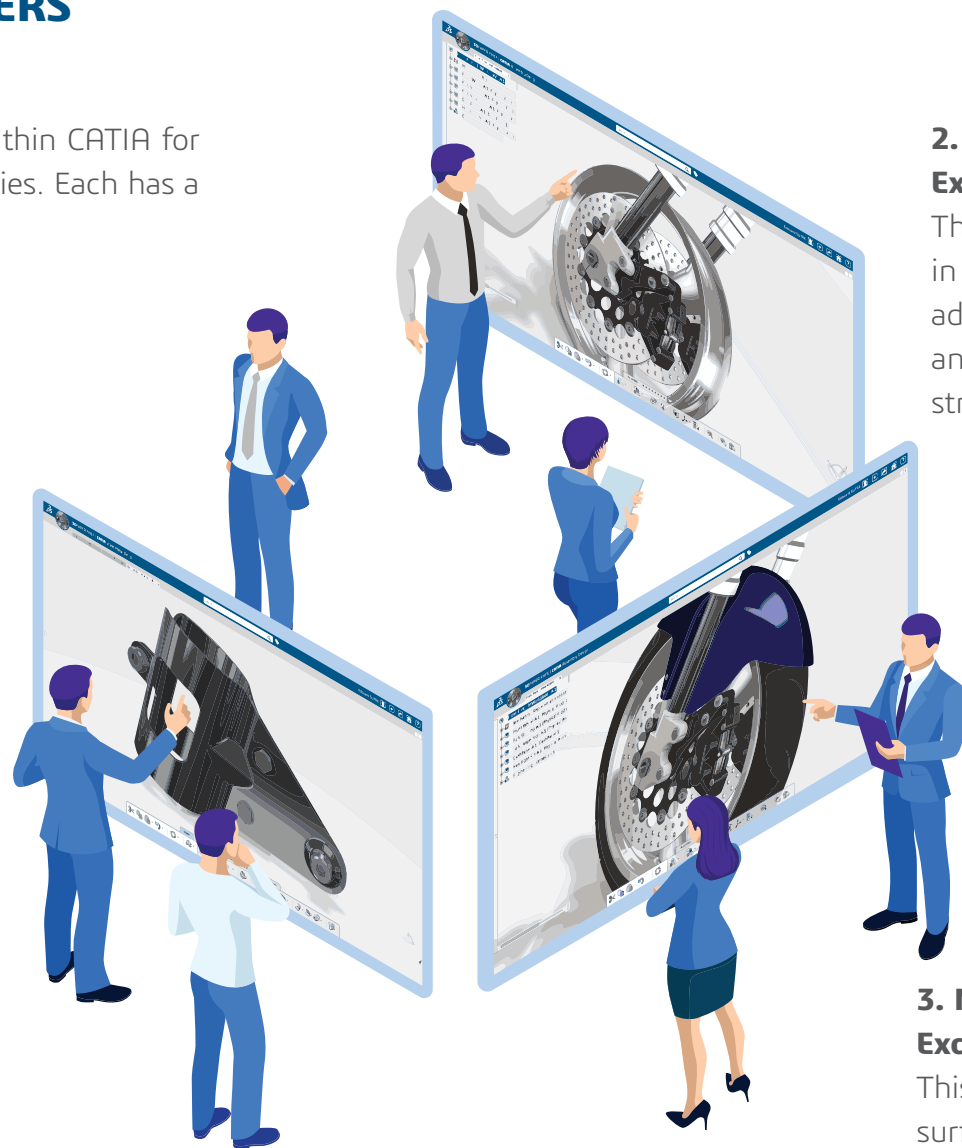

2. Mechanical Excellence Designer

This package is a step higher in functionality for more advanced part design, 3D Master annotations, mechanisms and structural simulation.

3. Mechanical and Shape Excellence Designer

This package provides advanced surface design capabilities in addition to what is available in the previous package.

GET ON THE CLOUD NOW

To compete in today's fast-paced and competitive market, smaller and newer firms need a powerful platform that will enable them to compete with bigger players without the heavy investments needed in computer hardware, software and personnel.

CATIA on the Cloud's user-friendly and ready out of the box nature ensures that companies, whatever their size, can get up and running on the platform in a matter of minutes.

Engineers and designers can innovate and create with teams in a collaborative, interactive environment where digital continuity is assured with a single source of truth.

Many companies have discovered that CATIA on the Cloud has revolutionized the way they conceive, develop and deliver their new products.

Will you be one of them?

Explore the various [solutions available](#).

Get on the cloud today.

Our 3DEXPERIENCE® platform powers our brand applications, serving 11 industries, and provides a rich portfolio of industry solution experiences.

Dassault Systèmes, the 3DEXPERIENCE® Company, provides business and people with virtual universes to imagine sustainable innovations. Its world-leading solutions transform the way products are designed, produced, and supported. Dassault Systèmes' collaborative solutions foster social innovation, expanding possibilities for the virtual world to improve the real world. The group brings value to over 250,000 customers of all sizes in all industries in more than 140 countries. For more information, visit www.3ds.com.



Europe/Middle East/Africa
Dassault Systèmes
10, rue Marcel Dassault
CS 40501
78946 Vélizy-Villacoublay Cedex
France

Asia-Pacific
Dassault Systèmes K.K.
ThinkPark Tower
2-1-1 Osaki, Shinagawa-ku
Tokyo 141-6020
Japan

Americas
Dassault Systèmes
175 Wyman Street
Waltham, Massachusetts
02451-1223
USA