

SINGAPORE CHINESE GIRLS' SCHOOL (PRIMARY)

FIRST SEMESTRAL ASSESSMENT 2019

NAME: \_\_\_\_\_ ( )

DATE: 14 May 2019

CLASS: PRIMARY 6 SY / C / G / SE / P

Parent's Signature:

\_\_\_\_\_

**SCIENCE**

**BOOKLET A**

28 questions

56 marks

Total time for Booklets A & B: 1 h 45 min

**DO NOT OPEN THIS BOOKLET UNTIL YOU ARE TOLD TO DO SO.**

**FOLLOW ALL INSTRUCTIONS CAREFULLY.**

**Part I (56 marks)**

For each question from 1 to 28, four options are given. One of them is the correct answer. Make your choice (1, 2, 3 or 4). Shade the correct oval (1, 2, 3 or 4) on the Optical Answer Sheet.

1. Roger classified the animals below into two groups, X and Y.

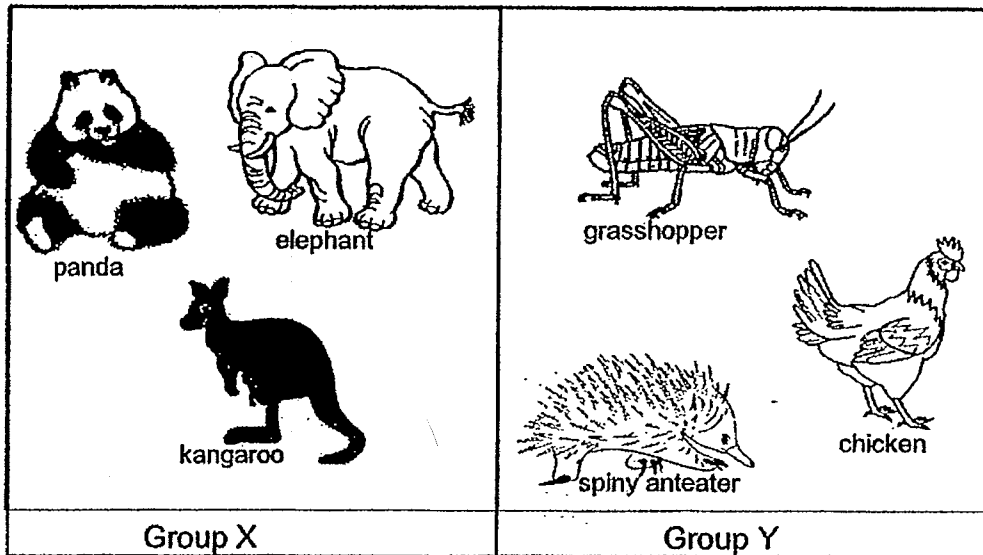

He grouped them according to:

- |                           |                    |
|---------------------------|--------------------|
| 1) how they are reproduce | 3) what they eat   |
| 2) their outer covering   | 4) where they live |

2. Which of the following is true about reproduction in both plants and animals?

- A: Eggs in both plants and animals are the female reproductive cells.
- B: The pollen grains and testes are the male reproductive cells.
- C: After fertilisation, plants develop seeds and animals develop their youngs.

- |                 |                 |
|-----------------|-----------------|
| 1) A and B only | 3) A and C only |
| 2) B and C only | 4) A, B and C   |

3. Which one of the classifications of the animals shown below is correct?

	Fish	Mammals that lay eggs	Mammals that give birth to young alive
1)	dolphin	platypus	guppy
2)	platypus	shark	dolphin
3)	shark	platypus	dolphin
4)	shark	dolphin	platypus

4. Study the flowchart below. Identify the parts P; Q and R of a cell.

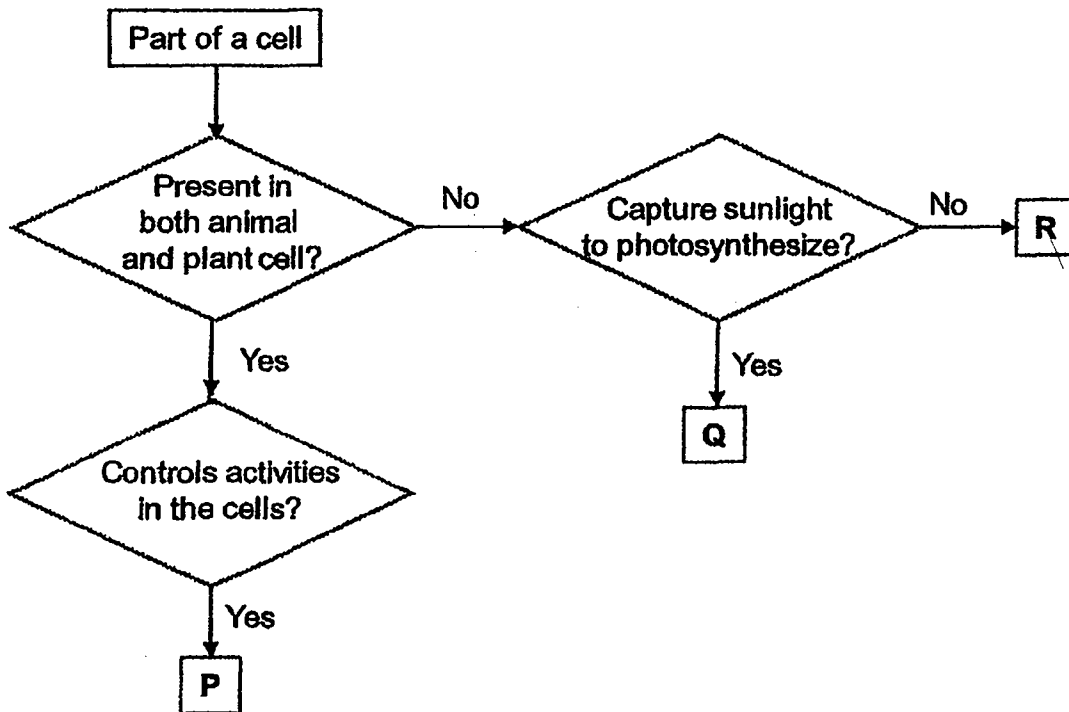

Which one of the following represents P, Q and R respectively?

	P	Q	R
1)	cell membrane	chloroplasts	cytoplasm
2)	nucleus	chloroplasts	cell membrane
3)	nucleus	cytoplasm	nucleus
4)	nucleus	chloroplasts	cell wall

5. Which of the following systems are used when a person exercises?

- A: Skeletal System
- B: Muscular System
- C: Respiratory System
- D: Circulatory System

- 1) A only
- 2) C only
- 3) B and C only
- 4) A, B, C and D

6. Layla used the set-ups below to investigate if the presence of water plants would affect the amount of carbon dioxide in water at different times of the day.

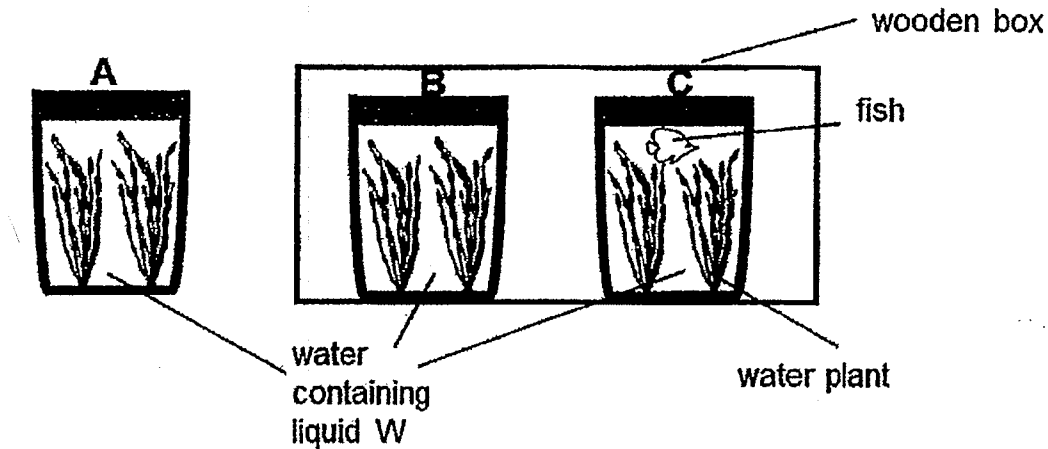

A few drops of liquid W were added to the water and the set-ups were placed in a well-lit place. Liquid W changes colour as the amount of carbon dioxide varies as shown in the table below.

Amount of carbon dioxide	Colour of Liquid W
Low	Red
Moderate	Blue
High	Yellow

What would the colour of the water with liquid W be in each set-up after some time?

Colour of liquid W			
	A	B	C
1)	Red	Red	Yellow
2)	Red	Yellow	Yellow
3)	Blue	Yellow	Red
4)	Yellow	Blue	Red



9. Mrs Tan wanted to find out the conditions necessary for the plant to photosynthesize. She set up the experiment below and placed Plant X in the cupboard for two days before putting it under the sun.

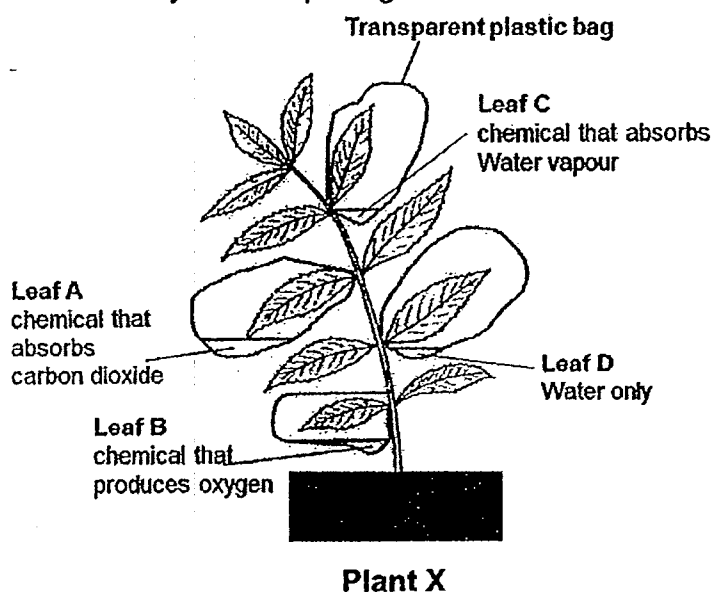

After a few hours in the sun, Mrs Tan removed leaves A, B, C and D from the plastic bags and plant. She conducted a starch test on the leaves. Which of the leaves would likely turn iodine solution dark blue to show that the plant has photosynthesized?

Note : Iodine turns dark blue when it reacts with starch.

- |                 |                    |
|-----------------|--------------------|
| 1) A and D only | 3) A, B and C only |
| 2) B and D only | 4) B, C and D only |

10. The table below shows the boiling point and freezing point of some substances.

Substance	Boiling Point (°C)	Freezing Point (°C)
P	55	2
Q	60	10
R	75	15
S	95	30

Based on the table above, which of the following statements are true about the substances?

- A: Substance P is in the solid state at 5°C.  
 B: Substance S is in the liquid state at 90°C.  
 C: All the four substances are in the liquid state at 40°C.  
 D: Substances Q and R are in the gaseous state at 70°C.

- |                 |                    |
|-----------------|--------------------|
| 1) A and B only | 3) C and D only    |
| 2) B and C only | 4) B, C and D only |

11. 3 rods, X, Y and Z, made of different materials were placed at the positions P, Q and R in the circuit below.

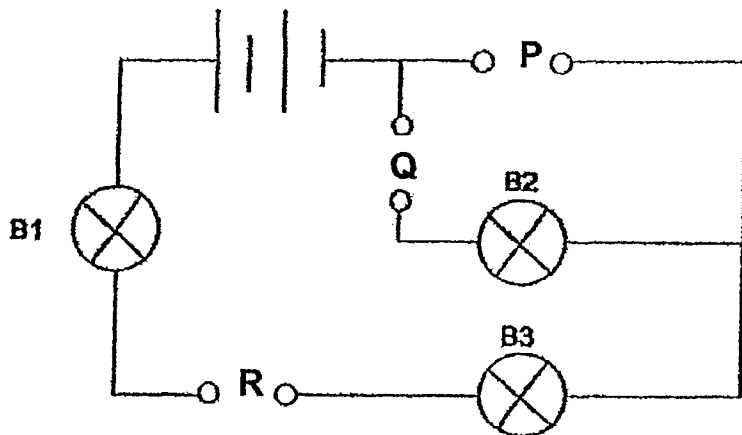

The table below shows the results collected at the end of the experiment.

Position where rods were placed			Did the bulb light up ?		
P	Q	R	B1	B2	B3
X	Y	Z			
Y	Z	X	✓		✓
Z	X	Y			

Based on the table above, which of the following statements is true ?

- 1) Only Rod Z is a non-conductor of electricity
- 2) Only Rod X is a non-conductor of electricity.
- 3) Only Rod Y and Rod Z are non-conductors of electricity.
- 4) Both Rod X and Rod Z are conductors of electricity.

12. Mary filled a 300ml conical flask with 100ml of water. She then attached a syringe to the flask and pumped in 100ml of air into the conical flask. What should be the final volume of air in the conical flask?

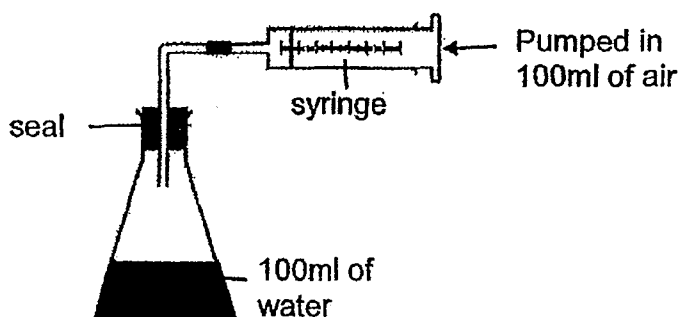

- 1) 100ml
- 2) 200ml
- 3) 300ml
- 4) 400ml

13. Study the following food chain carefully.

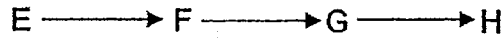

The food chain above shows 4 different organisms E, F, G and H found in a rainforest. What are the possible causes that are likely to increase the population of organism F?

- A: There are more Organism E in the rainforest.
- B: Population of Organism H decrease in the rainforest.
- C: There are more Organism G in the rainforest.
- D: Population of Organism H increase in the rainforest.

- 1) A only
- 2) A and D only
- 3) A, B and C only
- 4) A, C and D only

14. Diagram A shows a human reproductive system and Diagram B shows a plant reproductive system.

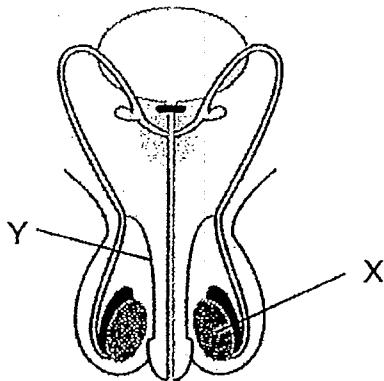

A

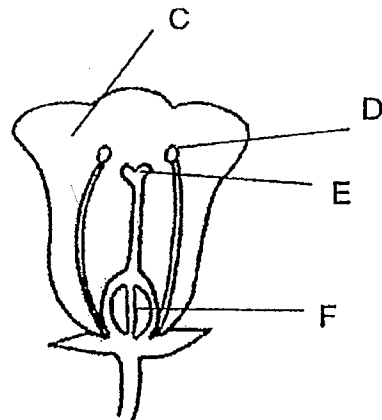

B

Which parts are female parts?

- 1) X, E and F only
- 2) X, Y and D only
- 3) C, E and F only
- 4) E and F only



15. The graph below shows the changes in the population of rabbits in a plantation over a period of time.

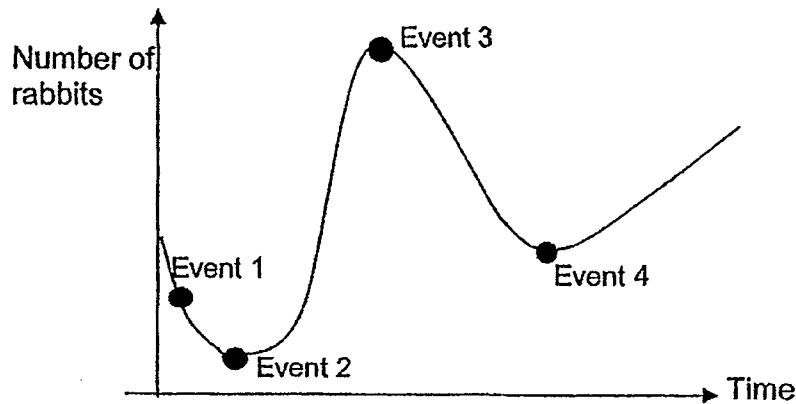

A, B, C and D are four events that occurred during this period of time.

- A: There was a decrease in the number of foxes.
- B: There was an increase in the number of foxes.
- C: Crops were removed by farmers during harvesting.
- D: New crops were planted by farmers.

Which of the following shows the correct sequence of events?

	Event 1	Event 2	Event 3	Event 4
1)	A	B	C	D
2)	B	A	C	D
3)	C	A	D	B
4)	D	C	A	B

16. Cormorant is a kind of bird that swims and hunts for fish in water. Which one of the following pairs of feet and beak are most probably those of the bird?

	Feet	Beak
1)		
2)		
3)		
4)		

17. Alayna counted the number of organisms in a pond and recorded the findings below.

Organisms	Number of organisms
Guppy	15
Tadpole	3
Mosquito larva	10
Frog	4
Mosquito	3
Water lily	10
Dragonfly	8
Algae	15

Which of these statements about the organisms in the pond community is true?

- 1) There are 6 populations of animals.
- 2) There are 8 populations of organisms.
- 3) The guppy and mosquito have the same population size.
- 4) There are 6 populations of organisms.

18. Nathan kept an insect in an air-tight jar as shown below.



Which of the following shows the correct composition of various gases in the jar after a few days?

- 1)
  - 2)
  - 3)
  - 4)
- Oxygen

carbon dioxide

nitrogen

19. There are four iron bars, P, Q, R and S. Only two of them are magnets. The ends of the iron bars are labelled as shown below.



The ends of the iron bars are brought close to each other to find out how they would interact. The observations are recorded below.

Ends that are brought close to each other	Observations
D and G	Attract
C and F	Repel
B and F	Attract
B and E	Attract
A and C	Attract

Based on the above observations, which one of the iron bars is definitely not a magnet?

- |      |      |
|------|------|
| 1) P | 3) R |
| 2) Q | 4) S |

20. The graph shows the changes of temperature of water as shown below.

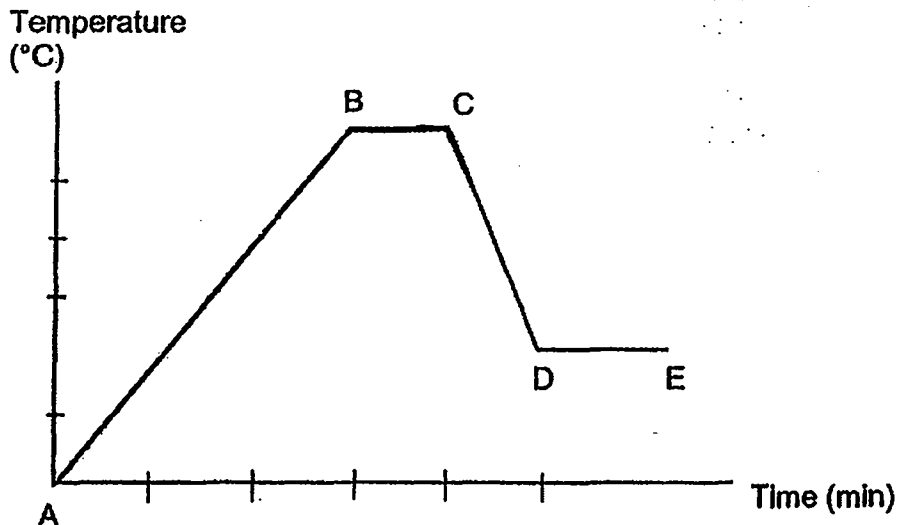

Which of the following shows the stages when heat is gained?

- |              |              |
|--------------|--------------|
| 1) AB and BC | 3) BC and DE |
| 2) BC and CD | 4) CD and DE |

21. The graph below shows the increase in length of two springs, A and B, when a 100g load is hung on them.

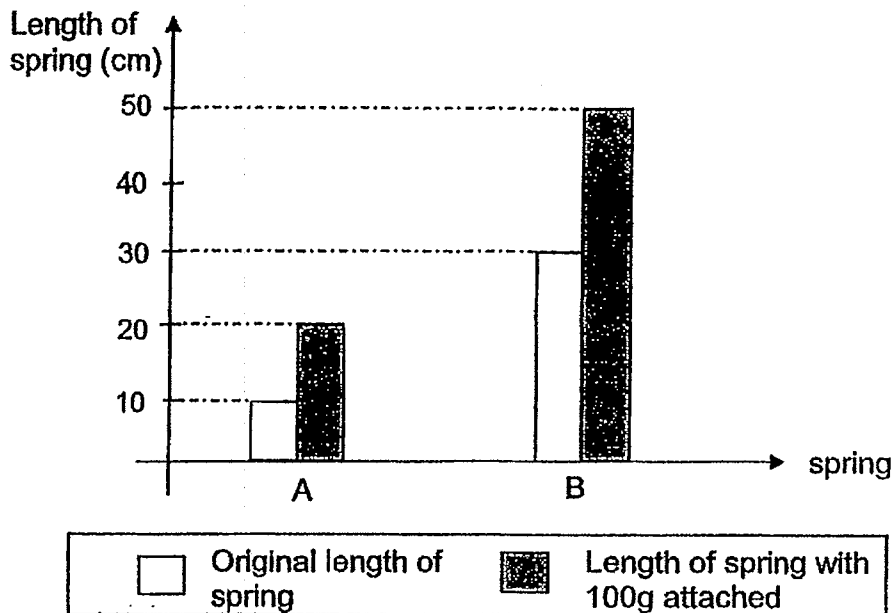

Based on the graph above, which of the following statements is true ?

- 1) The extension of both springs is the same for the same load hung.
- 2) The original length of spring A is longer than the length of spring B.
- 3) Spring A will be 25 cm long when 150g is hung on it.
- 4) Spring B will be 55 cm long when 150g is hung on it.

22. The diagram below shows a person holding a pencil to write.



Which one of the following type of force enables the person to write using a pencil?

- 1) Frictional force
- 2) Elastic Spring force
- 3) Magnetic force
- 4) Gravitational force

23. The diagram below shows a ball rolling down a slope.

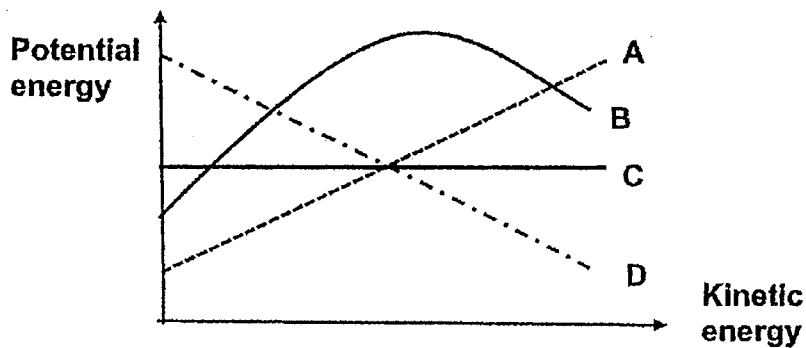
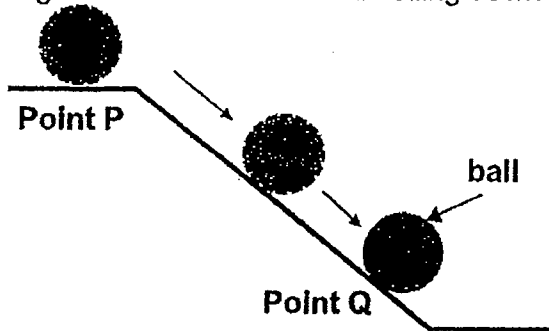

What line, A, B, C or D, in the graph above shows the correct relationship between of potential energy and kinetic energy of the ball as it rolls down the slope from P to Q ?

- 1) A
- 2) B
- 3) C
- 4) D

24. Weiwei filled a balloon with air. She pushed the balloon into a basin full of water as shown in the diagram below. She noticed that some water had overflowed.

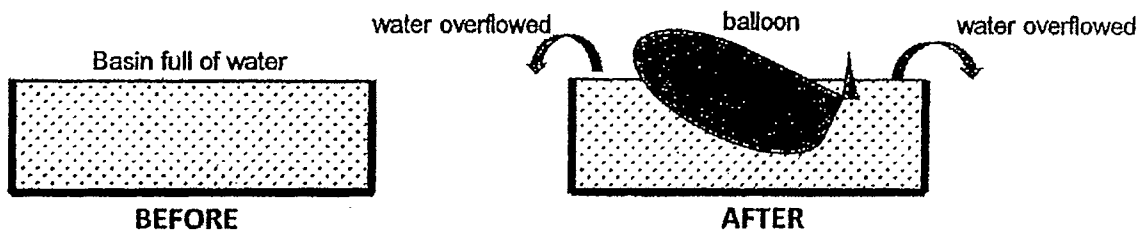

Explain why some water had overflowed.

- 1) Air occupies space.
- 2) Air has mass.
- 3) Air can be compressed.
- 4) Air does not have a definite shape.

25. Study the life cycle of Insect W.

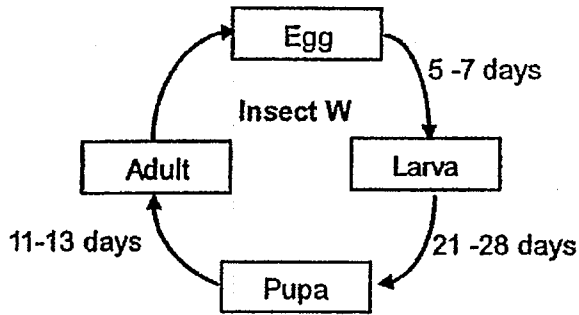

Which of the following statements is true?

- 1) Insect W can be a cockroach.
- 2) Insect W took between 32 days to 41 days to develop from egg to adult.
- 3) Insect W spends more days eating than not eating while developing into an adult.
- 4) Insect W must be in the pupa stage 21 days after egg is laid.

26. Which of the following statements are true about human digestive system?

- A: The saliva in our mouth helps to digest the food.  
B: Digestion of food is completed in the small intestine.  
C: Digestion of food takes place in the gullet and the stomach only.

- 1) A only
- 2) A and B only
- 3) B and C only
- 4) C only

27. A rubber ball was dropped from Position A. The ball bounced as show below.

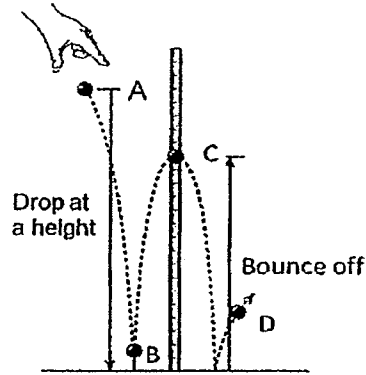

At which of these positions does the ball have the greatest kinetic energy and least potential energy?

- |               |               |
|---------------|---------------|
| 1) Position A | 3) Position C |
| 2) Position B | 4) Position D |

28. The diagram below shows 3 pieces of wood of different shapes.

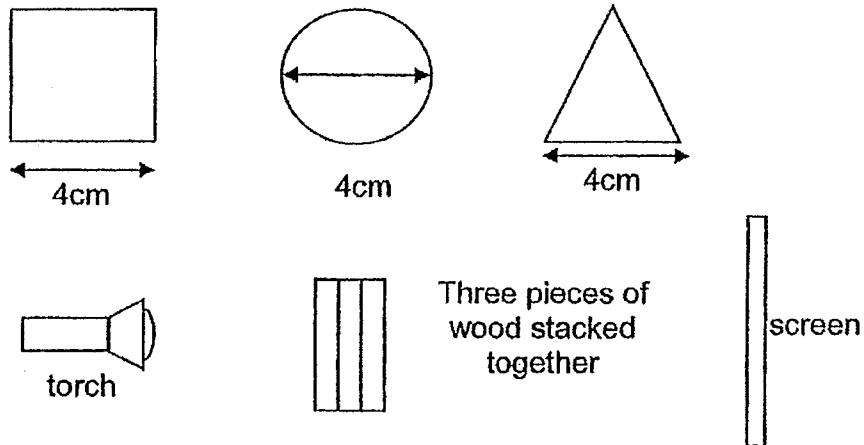

Which of the following shadows would be observed on the screen?

<p>1)</p>	<p>3)</p>
<p>2)</p>	<p>4)</p>

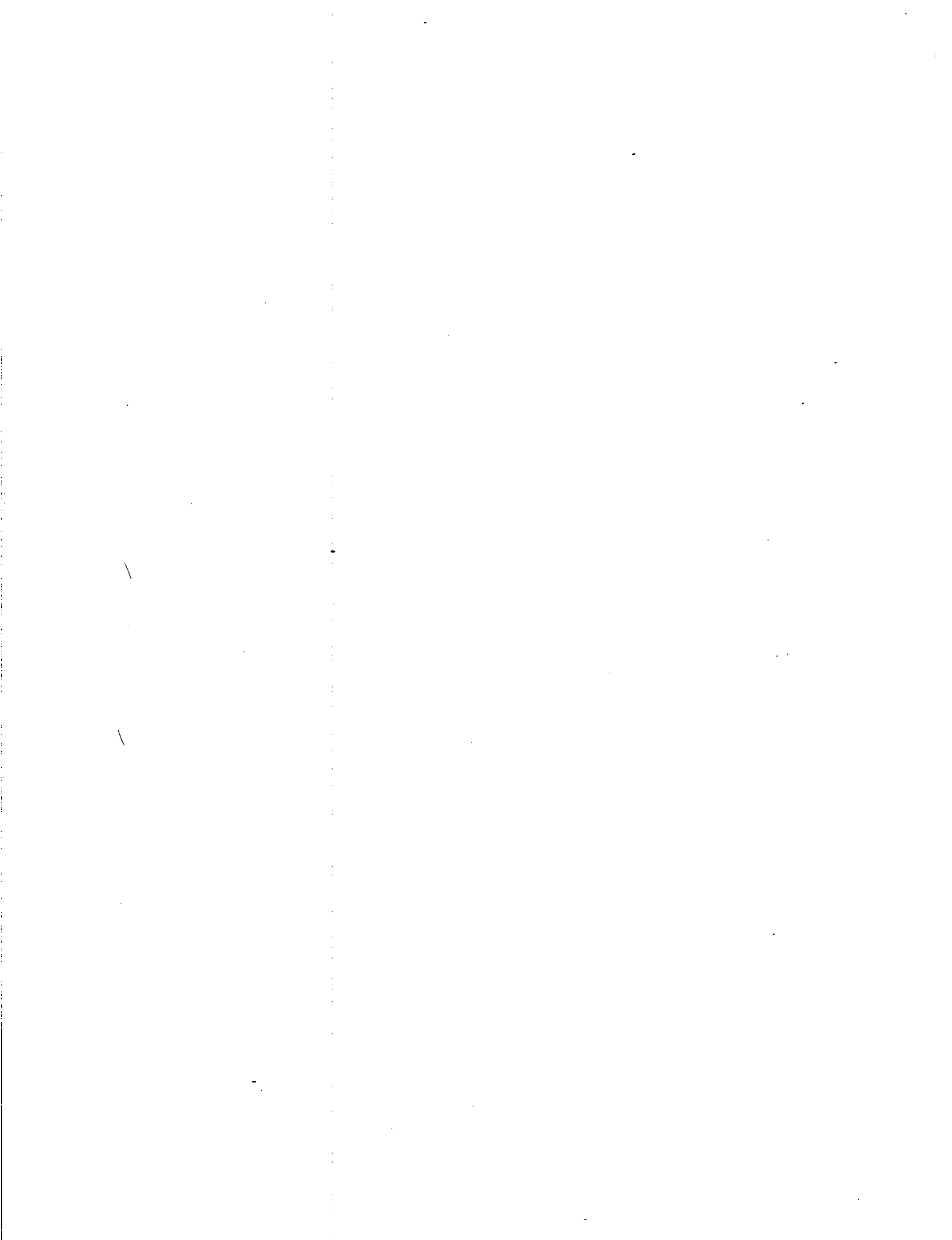



SINGAPORE CHINESE GIRLS' SCHOOL (PRIMARY)

FIRST SEMESTRAL ASSESSMENT 2019

NAME: \_\_\_\_\_ ( )

DATE: 14 May 2019

CLASS: PRIMARY 6 SY / C / G / SE / P

Parent's Signature.

\_\_\_\_\_

**SCIENCE**

**BOOKLET B**

	Total Actual Marks	Total Possible Marks
Booklet A		56
Booklet B		44
Total		100

13 questions

44 marks

Total time for Booklets A & B: 1 h 45 min

**DO NOT OPEN THIS BOOKLET UNTIL YOU ARE TOLD TO DO SO.**

**FOLLOW ALL INSTRUCTIONS CAREFULLY.**

**Part II (44 marks)**

Answer all the following questions.

29. The diagram below shows some stages in the growth of a bean plant.

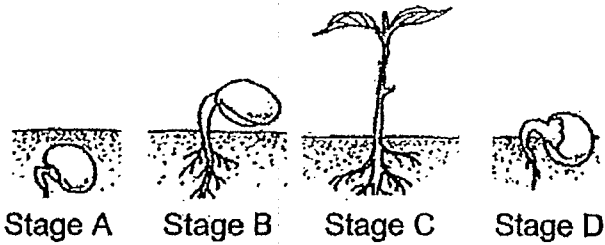

a) At stage B, where does the seedling get its food from? [1]

b) State the stage(s), A, B, C or/and D, which require(s) oxygen. Explain your answer. [1]

c) A Science teacher set up the following experiment with set-ups P, Q, R and S.

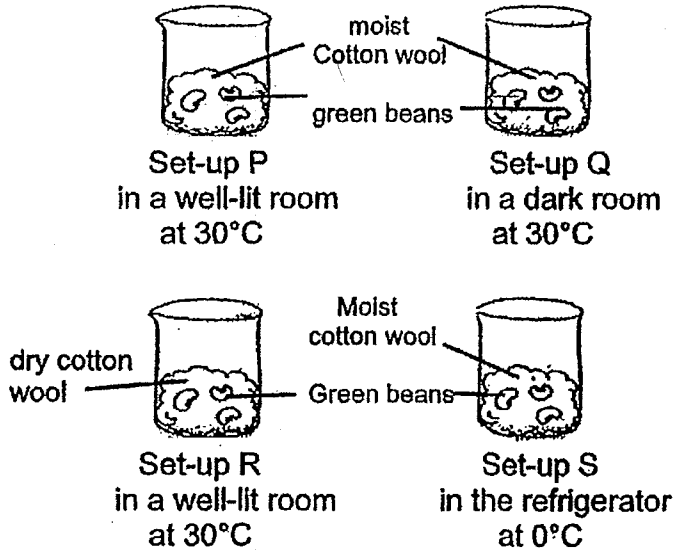

Huijuan concluded that the seed could not germinate in Set-up S because there was no light. Was she correct? Explain. [1]

30. Yasmin carried out an experiment as shown below. She wanted to find out whether carbon dioxide is needed for the plants to carry out photosynthesis. She placed set-ups, A and B, near the window in the same room.

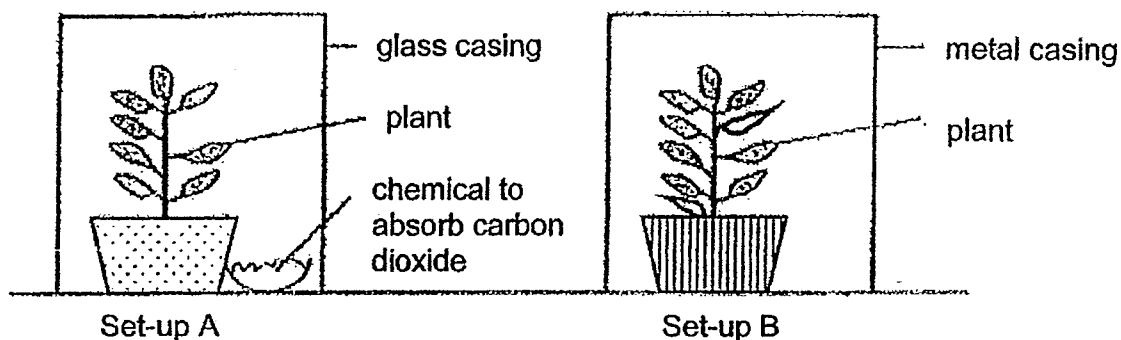

- a) Suggest two changes to Set-up B to ensure that the experiment will be a fair test. [2]

- (i) \_\_\_\_\_
- (ii) \_\_\_\_\_

31. Mrs Tan boiled some water in a kettle at room temperature. She noticed 'white mist' forming near the spout of the kettle when the temperature of the water reached 100°C.

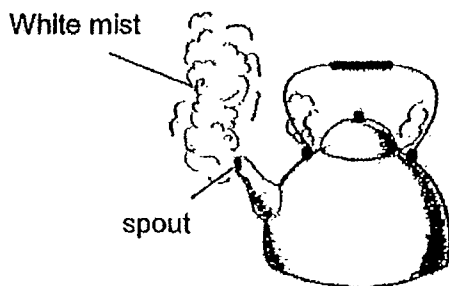

- a) Explain how the 'white mist' was produced when the water was boiling. [2]

\_\_\_\_\_

\_\_\_\_\_

- b) Mrs Tan wanted to find out if water droplets will form on 2 metal plates placed near the spout of the kettle. Put a tick (✓) in the box(es) below to indicate if water droplets can be seen on the metal plate(s). [1]

	Temperature of metal plate	Tick (✓) below if water droplets were observed
Plate A	30°C	
Plate B	100°C	

32. At 12 noon, Sally conducted an experiment by putting three identical pairs of wet pants, A, B and C, in an open area. The initial mass of the soaked pants was recorded. The mass of each pair of pants was recorded again every two hours for 8 hours.



Pants A



Pants B



Pants C

- a) What is the aim of the experiment? [1]

---



---

- b) The results of the experiment are shown in the table below.

	Mass of pants at 12pm (g)	Mass of pants at 2pm (g)	Mass of pants at 4pm (g)	Mass of pants at 6pm (g)	Mass of pants at 8pm (g)
A	600	430	350	280	260
B	600	550	510	480	465
C	600	500	430	390	370

- i) Explain why Pants B weighed the heaviest at the end. [1]

---



---

- ii) Why did the mass of the pants change most slowly in the last 2 hours? [1]

---



---

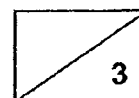

33. Study the diagrams below.

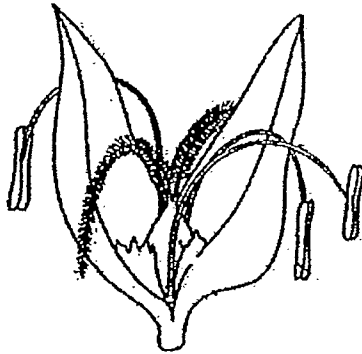

Flower A

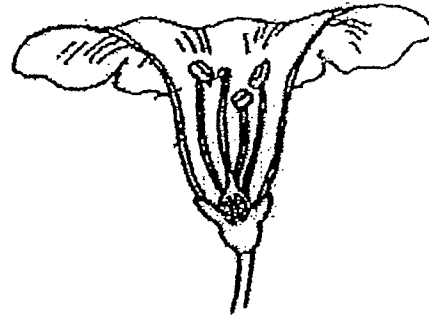

Flower B

a) Based on the diagrams, identify which flower, Flower A or Flower B, is pollinated by: [1]

(i) Wind : \_\_\_\_\_

(ii) Animals : \_\_\_\_\_

b) Support your answers in (a). [2]

Flower	Reason
A	
B	

34. Ben wanted to find out how the number of bulbs arranged in series will affect the brightness of the bulbs. He set up 2 arrangements, Circuit E and Circuit F, using the same type of components, as shown in the diagram below.

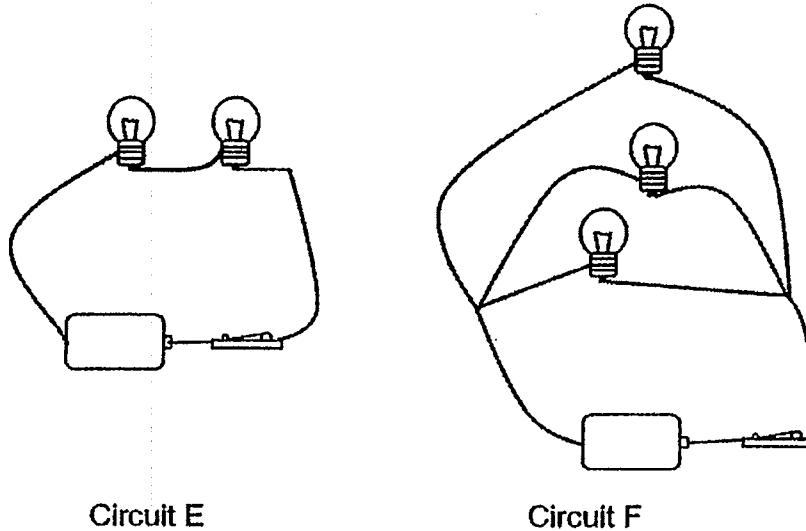

Ben concluded that when the number of bulbs arranged in series increases, the brightness of the bulbs increases.

- a) Based on the diagrams above, explain why Ben made a wrong conclusion. [1]

- b) Ben was given some materials, 5 bulbs, 2 switches, 2 batteries and some wires. Draw a **circuit diagram using symbols** below to show how **Circuit E** and **Circuit F** should be set up to achieve his aim. [3]

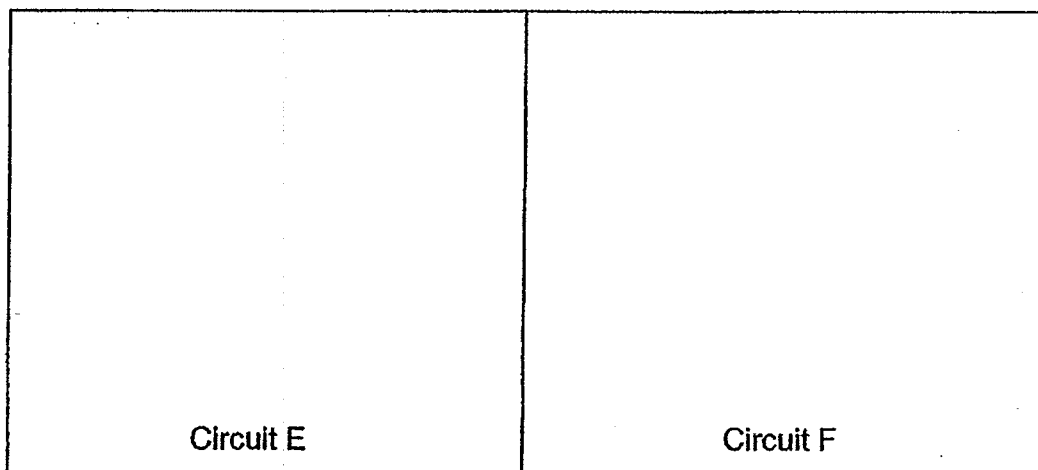

- c) Explain how the rubber coating on the copper wire prevent us from being electrocuted. [1]

35. The following picture shows a camel. It has survived well in places with extremely high temperatures like the desert.



a) Below are 2 structural adaptations of the camel that help it to survive in deserts. Explain how each adaptation has helped the camel to survive in deserts. [2]

Structural adaptation	How adaptation is helpful
Large padded feet	
Long eyelashes	

b) Below are 2 animals, P and Q.

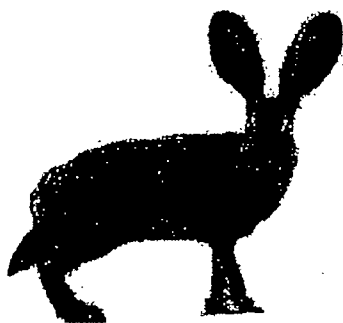

Animal P



Animal Q

Why will Animal P survive better in the desert? [1]

---



---

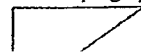

36. The graph below shows the changes in the pulse rate as Annie jogs around a running track.

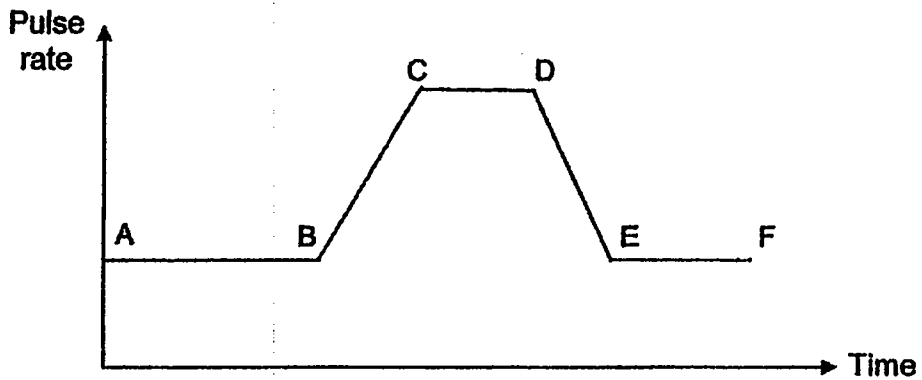

a) When Annie starts running at B, the pulse rate increases. Explain why. [1]

---



---

b) At which point does Annie stop jogging? [1]

---

c) Annie's muscle cells produce more carbon dioxide as she jogs. Write the path taken by the carbon dioxide as it travels from her muscle cells to leave the body. [1]

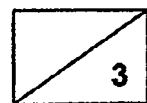



37. Raymond set up an experiment to measure the amount of light that passes through Material A. He switched on the light and measured the amount of light that passed through Material A using a light sensor that was connected to a datalogger as shown below.

He repeated the experiment with more pieces of Material A stacked together and recorded the results as shown in the table below.

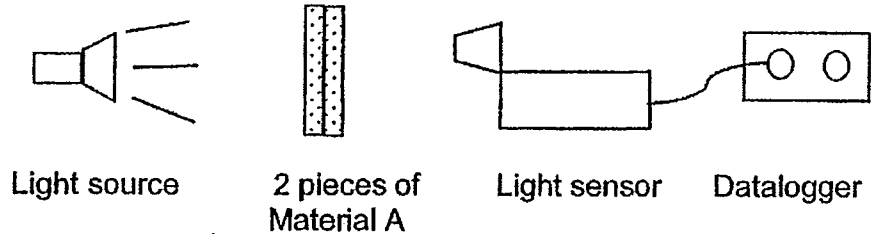

Number of pieces of Material A in front of light sensor	Amount of light recorded (lux)
1	4000
2	2000
3	1000
4	0

Table 1

a) Based on the results above, describe the relationship between the number of pieces of material A used and the amount of light detected by the datalogger. [1]

---



---

b) 4 shapes are made of Material A as shown below.

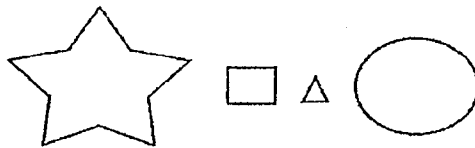

They are put together and the outline has been drawn as shown below. Based on the results as shown in Table 1 above, indicate the amount of light that would be recorded by the datalogger for **Points P and Q** : [2]

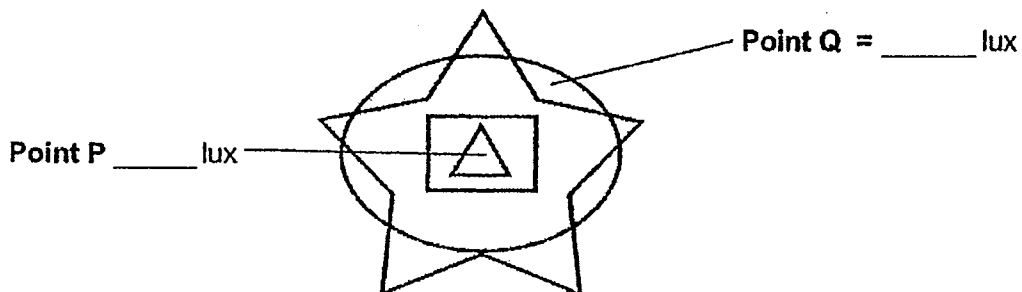

38. Alex has two containers, D and M, each made of different material as shown below. He filled them with the same amount of water measuring  $3^{\circ}\text{C}$  at the same time.

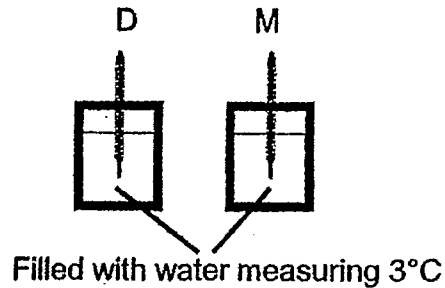

When he touched the containers, container D felt colder to his hands than container M.

- a) Which container, D or M, is a better conductor of heat? Explain your answer. [1]

---

---

- b) Alex then left the containers in the room and recorded the temperature of the water over time. The graph below shows the temperature of the water in Container D and M over a period of 20 minutes.

- i) Alex forgot to label the graph for Container D and M. Please **label** the graph for Container D and M accordingly. [1]

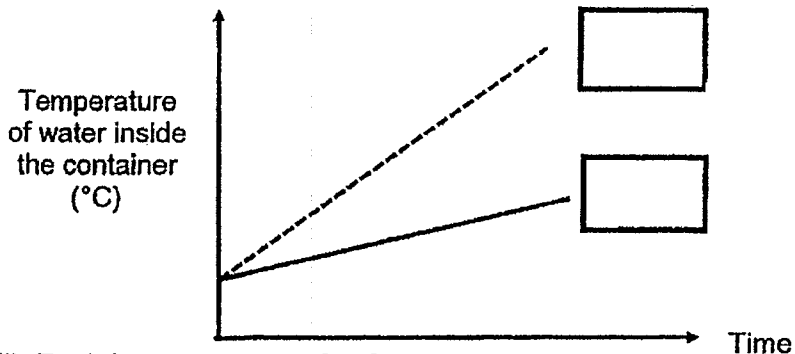

- ii) Explain your answer for Container D. [1]

---

---

- c) Using the above information from the experiment, which container, D or M, will be more suitable to be used as a flask for keeping hot drink warm for as long as possible? Explain your answer. [1]

---

---

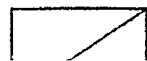

39. A metal box was attached to a wooden cart by a string as shown in the diagram below.

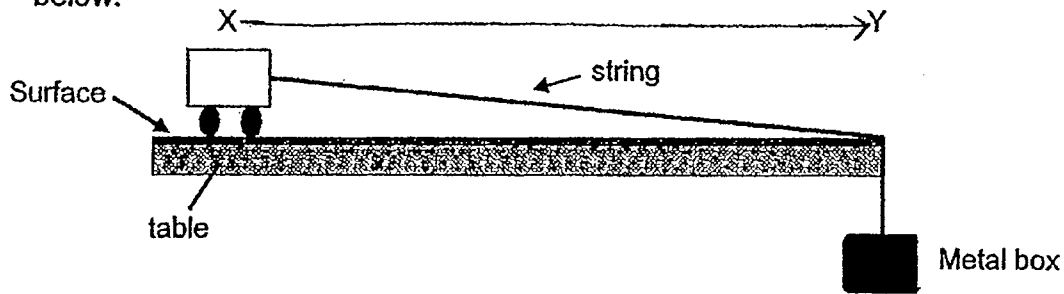

The time was taken for the wooden cart to travel from X to Y was recorded in the table below. The whole experiment was repeated using different surfaces on which the wooden cart moved across.

Surface	Time taken for the wooden cart to travel from X to Y (s)
A	36
B	14
C	20
D	30

- a) Which surface would be the most suitable to cover a table used for pushing heavy boxes across the surface? Explain your answer using the information from the table. [2]

---



---

- b) Without changing the wooden cart, what could be done to the set-up above to enable the cart to move faster across the table? [1]

---



---



---

- c) Why does it take a greater effort to walk up the stairs than to walk down the stairs? [2]

---



---

40. The graph shows the number of young plants, A and B, at various distances from their parent plant in the garden. The results are shown below.

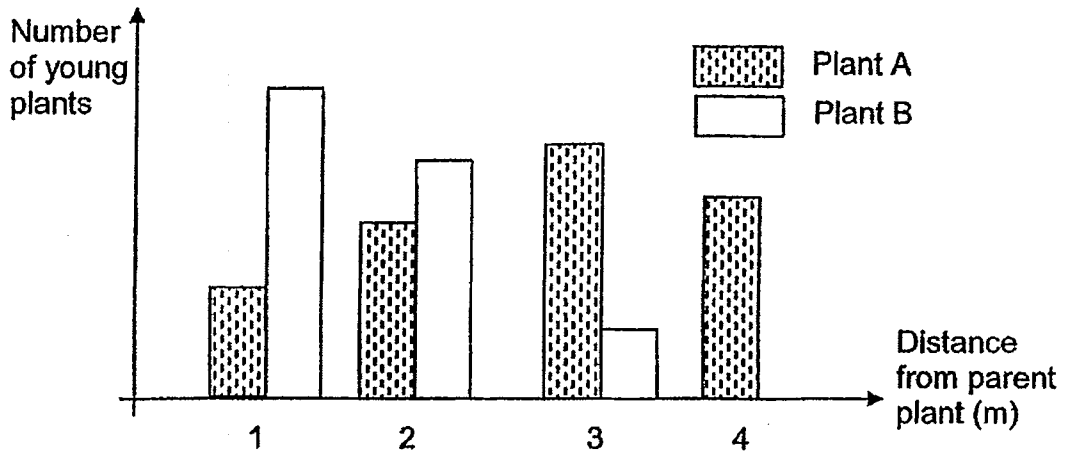

- a) Based on the graph above, which of the following below best represents the fruits from Plant A and B ? [1]

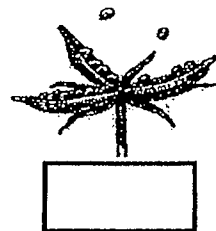
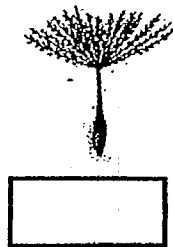

- b) Explain how you identify the fruits from Plant A and Plant B. [2]

Plant A :

---

Plant B :

---



- c) Based on the picture above, which plant, X or Y, is more likely to be dispersed further away from the parent plant ? Explain. [1]

---



---



41. John went to the bowling alley to bowl.

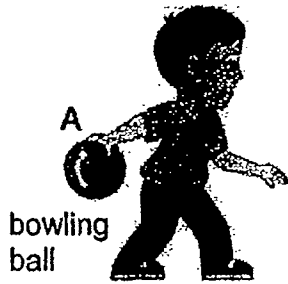

- a) As John released the bowling ball, it started to fall and roll on the ground towards the pins. The bowling ball collided into the pins.

Write the energy conversion of the bowling ball from B to C. [1]

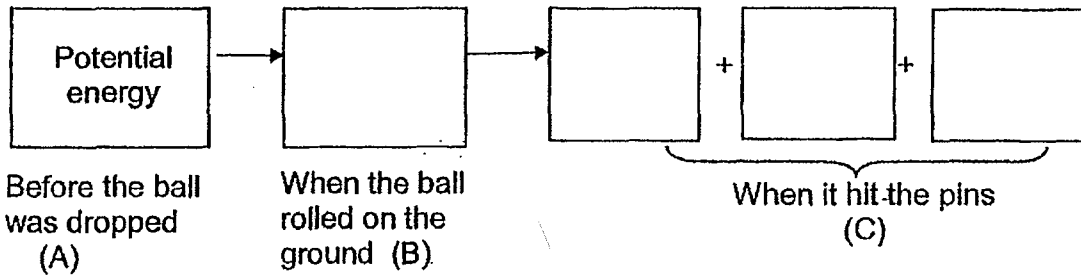

- b) John decided to change to a heavier bowling ball in order to increase his chance of hitting more pins. (The speed of bowling ball remains the same). Do you agree with him? Explain your answer. [1]

- c) John needs to choose a pair of shoes that allows him to slide easily along the polished surface of the bowling lanes. Which soles, P or Q, should he choose? Explain your answer. [1]





[SgTestPaper.com](#) | [P6](#) | [P5](#) | [P4](#) | [P3](#) | [P2](#) | [P1](#) |  
[ENGLISH](#) | [MATHS](#) | [SCIENCE](#) | [CHINESE](#) |  
[TAMIL](#) | [2019](#) | [2018](#) | [2017](#) | [2016](#) |  
[PAST WORKSHEETS](#) | [SG MATH](#) |  
[ENGLISH COMPOSITION](#) |  
[ASSESSMENT BOOKS](#) |



## Free Downloads

### SgTest Papers

- [Primary 6](#)
- [Primary 5](#)
- [Primary 4](#)
- [Primary 3](#)
- [Primary 2](#)
- [Primary 1](#)

### Top School Test Papers

- [Nanyang](#)
- [Raffles](#)
- [Rosyth](#)
- [Tao Nan](#)
- [CHIJ St Nicholas](#)
- [Red Swastika](#)

### Free Weekly Worksheet Subscription

[Model English Composition samples for Primary School](#)

[2018 & Earlier Worksheets](#)

[One-Click Download of All 2019 P6 papers](#)

[One-Click Download of All 2019 P5 papers](#)

[One-Click Download of All 2019 P4 papers](#)

Free Weekly Step-By-Step Maths  
Worked Solutions and Top 3  
English Topical Worksheets are  
available at the links below:

[Primary 6 English 2019 Test Paper Page](#)

[Primary 6 Maths 2019 Test Paper Page](#)

[Primary 5 English 2019 Test Paper Page](#)

[Primary 5 Maths 2019 Test Paper Page](#)

[Primary 4 English 2019 Test Paper Page](#)

[Primary 4 Maths 2019 Test Paper Page](#)

Click on the links to go to the pages

**SCHOOL : SCGS PRIMARY SCHOOL**  
**LEVEL : PRIMARY 6**  
**SUBJECT : SCIENCE**  
**TERM : 2019 SA1**

---

**SECTION A**



<b>Q 1</b>	<b>Q2</b>	<b>Q3</b>	<b>Q4</b>	<b>Q5</b>	<b>Q6</b>	<b>Q7</b>	<b>Q8</b>	<b>Q9</b>	<b>Q10</b>
<b>1</b>	<b>3</b>	<b>3</b>	<b>4</b>	<b>4</b>	<b>2</b>	<b>3</b>	<b>3</b>	<b>4</b>	<b>2</b>
<b>Q 11</b>	<b>Q12</b>	<b>Q13</b>	<b>Q14</b>	<b>Q15</b>	<b>Q16</b>	<b>Q17</b>	<b>Q18</b>	<b>Q19</b>	<b>Q20</b>
<b>1</b>	<b>2</b>	<b>2</b>	<b>4</b>	<b>2</b>	<b>1</b>	<b>4</b>	<b>2</b>	<b>1</b>	<b>1</b>
<b>Q 21</b>	<b>Q22</b>	<b>Q23</b>	<b>Q24</b>	<b>Q25</b>	<b>Q26</b>	<b>Q27</b>	<b>Q28</b>		
<b>3</b>	<b>1</b>	<b>4</b>	<b>1</b>	<b>3</b>	<b>2</b>	<b>2</b>	<b>4</b>		

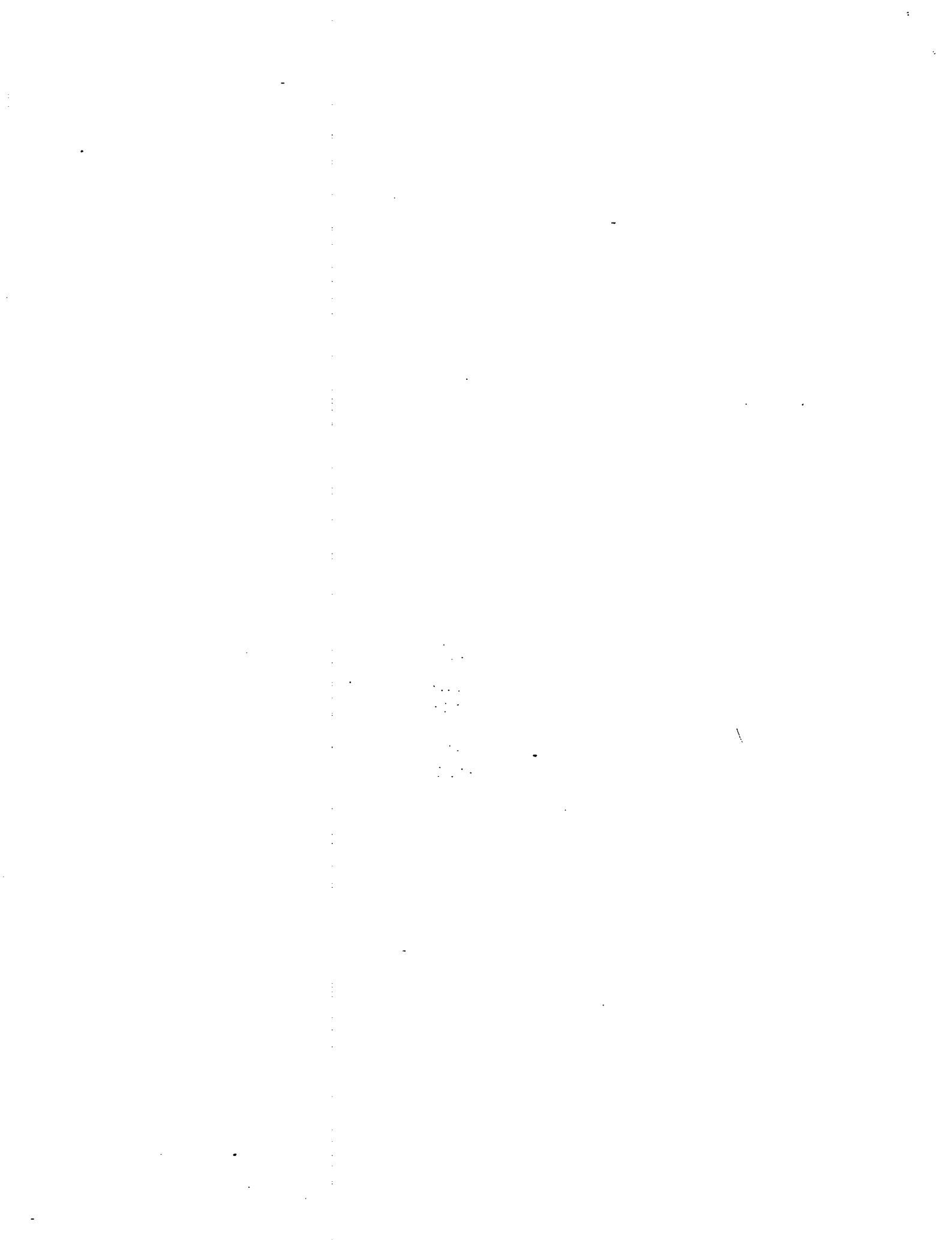

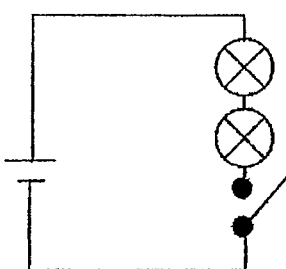
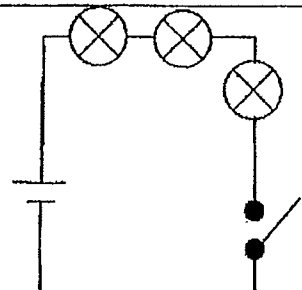

## 2019 PRIMARY 6 SCIENCE SA1

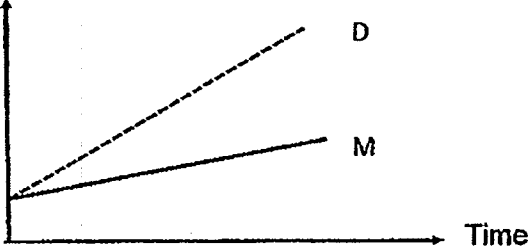
Booklet B Answers	
29a	Seed leaves
29b	A,B,C and D OR All stages. It is a living thing so it needs oxygen to respire at all stages
29c	No. Light is not needed for germination.
30a	(i) Change the metal casing to a glass casing. (ii) Remove 2 leaves to make the number of leaves the same.
31a	The <b>steam from the boiling water</b> touches the <b>cooler air</b> in the surroundings, <b>loses heat</b> and <b>condenses</b> to form the mist. (Note – Steam is invisible – it is not the white mist)
31b	Tick 30°C only
32a	To find out if the exposed surface area of the pants affect the rate of the evaporation.
32bi)	Pants B has the <u>least /smallest exposed surface area</u> , it had <u>the slowest rate of evaporation of water</u> .
32c	<b>Temperature</b> decreases / is lower from 6 to 8pm, so there is a slower rate of evaporation. OR It's cooler from 6 to 8pm, so there is slower rate of evaporation.
33a	(i) Wind – Flower A (ii) Animal – Flower B
33b	A – The anthers / stigma are exposed to the wind outside the petals. B – The anthers are inside the petals.
34a	The bulbs in Circuit F are arranged in parallel OR The bulbs in Circuit F are not arranged in series.
34b	<div style="display: flex; justify-content: space-around; align-items: center;"> <div style="text-align: center;">  <p>Circuit E</p> </div> <div style="text-align: center;">  <p>Circuit F</p> </div> </div>
33c	Rubber is a non-conductor of electricity.
35a	<b>Large padded feet</b> – (to spread out its weight when walking and) prevent the camel from sinking into the sand.  <b>Long eyelashes</b> – to block the sand from reaching the eyes
35b	Animal P has <b>larger ears</b> to enable it to <b>lose heat faster</b> in desert. OR Animal P has a <b>darker</b> coloured fur to <b>blend into the colour of sand</b> .
36a	Pulse rate increases as the body needs <b>more oxygen</b> and <b>more food</b> during exercise so oxygen and food need to be pumped at a faster rate to all parts of the body.
36b	Point D.

S/N	Booklet B Answers
36c	Muscle Cells → Blood → <b>Heart</b> → <b>Lungs</b> → Nose
37a	The greater the number of pieces of A, the lower the amount of light detected by the datalogger <b>BUT with 4 or more pieces of material A, no more light can be detected by datalogger.</b>
37b	Point Q : 4000 lux Point P : 0 lux
38a	D is a <b>better conductor of heat</b> than M. D will conduct heat <u>from the hand to the container faster</u> , thus the hand felt colder.
38bi)	<p>Temperature of water inside the container (°C)</p>  <p>Time</p>
38bi)	D is a better conductor of heat than M So it will conduct heat <u>from the surrounding air to the water faster</u> .
38c.	Container M. M is a <b>poorer conductor of heat</b> so it will conduct heat <u>from the hot water in the flask to the surroundings slower</u> .
39a.	Surface B. It takes the shortest time for the wooden cart to move from X to Y, so the <u>friction between the surfaces of the ramp and the heavy box is the least</u> .
39b	Add lubricant OR Use heavier metal box
39c.	It has to go against the direction of gravity when going up the stairs so it takes greater effort than coming down the stairs which is going in the same direction as gravity.
40a	 <p>Fruit from Plant A      Fruit from Plant B</p>
40b	Fruit / Seed A has hair-like structures that enable them to float/stay in the air longer and disperse further away from parent plant Fruit/ Seed B has pod-like structure and dispersed by splitting, and disperse at a shorter distance away from parent plant
40c	Fruit/ Seed Y has longer hair than X, thus it will have more surface area against air / stay in the air longer , allowing Y to travel a longer distance away from its parent plant.
41a	Potential Energy → <b>Kinetic Energy</b> → <b>Kinetic Energy</b> + <b>Sound Energy</b> + <b>Heat Energy</b>
41b	Yes, the heavier ball has <b>more kinetic energy</b> to knock more pins down.
41c	Sole P has less grooves than Sole Q, thus P will have less friction than Q. This enables John to slide on the polished surface easier.