

MALIBU MIRAGE

PA-46-350P

SN 4636196 AND UP

PILOT'S OPERATING HANDBOOK

AND

FAA APPROVED
AIRPLANE FLIGHT MANUAL

AIRPLANE
SERIAL NO. _____

AIRPLANE
REGIST. NO. _____

PA-46-350P

REPORT: VB-1710 FAA APPROVED BY: _____



PETER E. PECK
D.O.A. NO. SO-1
THE NEW PIPER AIRCRAFT, INC.
VERO BEACH, FLORIDA

DATE OF APPROVAL:
FEBRUARY 23, 1999

THIS HANDBOOK INCLUDES THE MATERIAL REQUIRED TO BE FURNISHED TO THE PILOT BY THE FEDERAL AVIATION REGULATIONS AND ADDITIONAL INFORMATION PROVIDED BY THE MANUFACTURER AND CONSTITUTES THE FAA APPROVED AIRPLANE FLIGHT MANUAL. THIS HANDBOOK MUST BE CARRIED IN THE AIRPLANE AT ALL TIMES.



PiperTM

WARNING

EXTREME CARE MUST BE EXERCISED TO LIMIT THE USE OF THIS HANDBOOK TO APPLICABLE AIRCRAFT. THIS HAND- BOOK IS VALID FOR USE WITH THE AIRPLANE IDENTIFIED ON THE FACE OF THE TITLE PAGE. SUBSEQUENT REVISIONS SUPPLIED BY PIPER MUST BE PROPERLY INSERTED.

FOR REFERENCE ONLY
NOT FOR FLIGHT

Published by
PUBLICATIONS DEPARTMENT
Issued: FEBRUARY 23, 1999
© 1997 THE NEW PIPER AIRCRAFT, INC.
All Rights Reserved

APPLICABILITY

Application of this handbook is limited to the specific Piper PA-46-350P model airplane designated by serial number and registration number on the face of the title page of this handbook.

This handbook cannot be used for operational purposes unless kept in a current status.

WARNING

INSPECTION, MAINTENANCE AND PARTS REQUIREMENTS FOR ALL NON-PIPER APPROVED STC INSTALLATIONS ARE NOT INCLUDED IN THIS HANDBOOK. WHEN A NON-PIPER APPROVED STC INSTALLATION IS INCORPORATED ON THE AIRPLANE, THOSE PORTIONS OF THE AIRPLANE AFFECTED BY THE INSTALLATION MUST BE INSPECTED IN ACCORDANCE WITH THE INSPECTION PROGRAM PUBLISHED BY THE OWNER OF THE STC. SINCE NON-PIPER APPROVED STC INSTALLATIONS MAY CHANGE SYSTEMS INTERFACE, OPERATING CHARACTERISTICS AND COMPONENT LOADS OR STRESSES ON ADJACENT STRUCTURES, PIPER PROVIDED INSPECTION CRITERIA MAY NOT BE VALID FOR AIRPLANES WITH NON-PIPER APPROVED STC INSTALLATIONS.

REVISIONS

The information compiled in the Pilot's Operating Handbook, with the exception of the equipment list, will be kept current by revisions distributed to the airplane owners. The equipment list was current at the time the airplane was licensed by the manufacturer and thereafter must be maintained by the owner.

Revision material will consist of information necessary to update the text of the present handbook and/or to add information to cover added airplane equipment.

I. Revisions

Revisions will be distributed whenever necessary as complete page replacements or additions and shall be inserted into the handbook in accordance with the instructions given below:

1. Revision pages will replace only pages with the same page number.
2. Insert all additional pages in proper numerical order within each section.
3. Insert page numbers followed by a small letter in direct sequence with the same common numbered page.

II. Identification of Revised Material

Each handbook page is dated at the bottom of the page showing the date of original issue and the date of the latest revision. Revised text and illustrations are indicated by a black vertical line located along the outside margin of each revised page opposite the revised, added, or deleted information. A vertical line next to the page number indicates that an entire page has been changed or added.

Vertical black lines indicate current revisions only. Correction of typographical or grammatical errors or the physical relocation of information on a page will not be indicated by a symbol.

ORIGINAL PAGES ISSUED

The original pages issued for this handbook prior to revision are given below:

Title, ii through viii, 1-1 through 1-12, 2-1 through 2-16, 3-1 through 3-38, 4-1 through 4-42, 5-1 through 5-34, 6-1 through 6-14, 7-1 through 7-64, 8-1 through 8-24, 9-1 through 9-114, and 10-1 through 10-2.

PILOT'S OPERATING HANDBOOK LOG OF REVISIONS

Current Revisions to the PA-46-350P Malibu Pilot's Operating Handbook,
REPORT: VB-1710 issued FEBRUARY 23, 1999.

Revision Number and Code	Revised Pages	Description of Revisions	FAA Approved Signature and Date
Rev. 1 (PR990920)	v	Added Rev. 1 to L of R pg.	
	3-11	Revised para. 3.3m	
	3-12	Revised para. 3.3m	
	3-32	Revised para. 3.27	
	3-35	Revised para. 3.43	
	4-13	Revised para. 4.5g	
	5-3	Revised para. 5.5	
	5-4	Revised para. 5.5	
	5-7	Revised para. 5.5	
	5-8	Revised para. 5.5	
	5-9	Revised List of Fig.'s	
	5-22	Revised Fig. 5.23	
	5-23	Revised Fig. 5.24	
	5-24	Revised Fig. 5.25	
	5-28	Revised Fig. 5.29	
	5-33	Revised Fig. 5.39	
	5-34	Revised Fig. 5.41	
	6-5	Revised para. 6.3	
	6-11	Revised para. 6.9	
	6-12	Revised para. 6.9	
	6-14	Revised Fig. 6.15	
	7-34	Revised para. 7.17	
	7-35	Revised para. 7.19	
	7-38	Revised para. 7.19	
	7-43	Revised para. 7.21	
	7-48	Revised para. 7.25	
	7-49	Revised para. 7.25	
	7-50	Revised para. 7.25	
	9-i	Revised TOC	
	9-10	Revised Section 4	
9-24	Revised Section 7		
9-87	Revised Title		

PILOT'S OPERATING HANDBOOK LOG OF REVISIONS (cont)

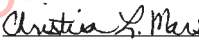
Revision Number and Code	Revised Pages	Description of Revisions	FAA Approved Signature and Date
Rev. 1 (continued)	9-115 thru 9-122	Added Section 9 Supplement 15	 Peter E. Peck <u>Sept. 10, 1999</u> Date
Rev. 2 (PR991112)	vi 2-14 9-ii 9-115 thru 9-122 9-123 9-124	Added Rev. 2 to L of R. Revised para. 2.35. Revised T of C. Revised headers. Added page and Supp. 16. Added page.	 Christina L. Marsh <u>Nov. 12, 1999</u> Date
Rev. 3 (PR010910)	vi vi-a vi-b 2-16 3-9 3-28 6-4 7-14 7-15 7-29 9-ii 9-32 9-118 9-125 thru 9-132	Added Rev. 3 to L of R. Added page and Rev. 3. Added page. Revised para. 2.35. Revised para. 3.3k. Revised para. 3.24. Revised Fig. 6-3. Revised para. 7.8. Revised para. 7.8. Revised para. 7.11. Revised T of C. Revised Section 4. Revised Section 2. Added pages and Supplement 17.	

PILOT'S OPERATING HANDBOOK LOG OF REVISIONS (cont)

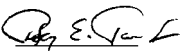
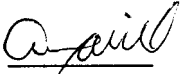
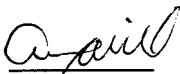
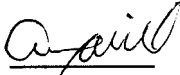
Revision Number and Code	Revised Pages	Description of Revisions	FAA Approved Signature and Date
Rev. 3 (PR010910) continued	9-133 thru 9-142 9-143 thru 9-150 9-151 thru 9-156 9-157 thru 9-160	Added pages and Supplement 18. Added pages and Supplement 19. Added pages and Supplement 20. Added pages and Supplement 21.	 Peter E. Peck <u>Sept. 10, 2001</u> Date
Rev. 4 (PR011220)	vi-a 9-116	Added Rev. 4 to L of R. Revised Section 1.	 Albert J. Mill <u>Dec. 20, 2001</u> Date
Rev. 5 (PR020415)	vi-a 2-16	Added Rev. 5 to L of R. Revised para. 2.35.	 Albert J. Mill <u>April 15, 2002</u> Date
Rev. 6 (PR020419)	vi-a 9-ii 9-161 9-162	Added Rev. 6 to L of R. Revised T of C. Added pages and Supplement 22.	 Albert J. Mill <u>April 19, 2002</u> Date

PILOT'S OPERATING HANDBOOK LOG OF REVISIONS (cont)

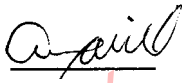
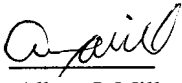
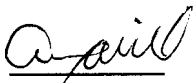
Revision Number and Code	Revised Pages	Description of Revisions	FAA Approved Signature and Date
Rev. 7 (PR021014)	iii	Added Warning and moved info. to page iv.	 Albert J. Mill <u>Oct. 14, 2002</u> Date
	iv	Moved info. from page iii.	
	vi-b	Added Rev. 7 to L of R.	
	8-1	Moved info. to page 8-1B and revised para. 8.1.	
	8-1A	Added page and revised para. 8.1.	
	8-1B	Added page and moved info. from pages 8-1 and 8-2.	
	8-2	Moved info. to page 8-1B and revised para. 8.3.	
Rev. 8 (PR021108)	vi-b	Added Rev. 8 to L of R.	 Albert J. Mill <u>Nov. 8, 2002</u> Date
	9-ii	Revised T of C.	
	9-163 thru 9-164	Added pages and Supplement 23.	
Rev. 9 (PR040120)	vi-b	Added Rev. 9 to L of R.	 Albert J. Mill <u>Jan. 20, 2004</u> Date
	4-i	Revised page headers.	
	thru 4-iv		
	4-1	Revised page headers.	
	thru 4-14		
	4-41	Revised para. 4.50.	
	9-ii	Revised T of C.	
	9-165 thru 9-168	Added pages and Supplement 24.	

PA-46-350P, MALIBU

PILOT'S OPERATING HANDBOOK LOG OF REVISIONS (cont)

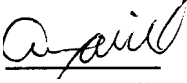
Revision Number and Code	Revised Pages	Description of Revisions	FAA Approved Signature and Date
Rev. 10 (PR040724)	vi-c vi-d 4-41	Added page and Rev. 10 to L of R. Added page. Revised para. 4.50.	 Albert J. Mill July 24, 2004

FOR REFERENCE ONLY
NOT FOR FLIGHT

PILOT'S OPERATING HANDBOOK LOG OF REVISIONS (cont)

Revision Number and Code	Revised Pages	Description of Revisions	FAA Approved Signature and Date
<p>FOR REFERENCE ONLY NOT FOR FLIGHT</p>			

TABLE OF CONTENTS

SECTION 1	GENERAL
SECTION 2	LIMITATIONS
SECTION 3	EMERGENCY PROCEDURES
SECTION 4	NORMAL PROCEDURES
SECTION 5	PERFORMANCE
SECTION 6	WEIGHT AND BALANCE
SECTION 7	DESCRIPTION AND OPERATION OF THE AIRPLANE AND ITS SYSTEMS
SECTION 8	AIRPLANE HANDLING, SERVICING AND MAINTENANCE
SECTION 9	SUPPLEMENTS
SECTION 10	OPERATING TIPS

TABLE OF CONTENTS

SECTION 1

GENERAL

Paragraph No.		Page No.
1.1	Introduction	1-1
1.3	Engine.....	1-3
1.5	Propeller	1-3
1.7	Fuel.....	1-4
1.9	Oil	1-4
1.11	Maximum Weights	1-5
1.13	Standard Airplane Weights.....	1-5
1.15	Cabin and Entry Dimensions.....	1-5
1.17	Baggage Space and Entry Dimensions.....	1-5
1.19	Specific Loading.....	1-5
1.21	Symbols, Abbreviations and Terminology	1-7

FOR REFERENCE ONLY
NOT FOR FLIGHT

SECTION 1

GENERAL

1.1 INTRODUCTION

This Pilot's Operating Handbook is designed for maximum utilization as an operating guide for the pilot. It includes the material required to be furnished to the pilot by the Federal Aviation Regulations and additional information provided by the manufacturer and constitutes the FAA Approved Airplane Flight Manual.

This handbook is not designed as a substitute for adequate and competent flight instruction, knowledge of current airworthiness directives, applicable federal air regulations or advisory circulars. It is not intended to be a guide for basic flight instruction or a training manual and should not be used for operational purposes unless kept in a current status.

Assurance that the airplane is in an airworthy condition is the responsibility of the owner. The pilot in command is responsible for determining that the airplane is safe for flight. The pilot is also responsible for remaining within the operating limitations as outlined by instrument markings, placards, and this handbook.

Although the arrangement of this handbook is intended to increase its in-flight capabilities, it should not be used solely as an occasional operating reference. The pilot should study the entire handbook to familiarize himself with the limitations, performance, procedures and operational handling characteristics of the airplane before flight.

The handbook has been divided into numbered (arabic) sections each provided with a finger-tip tab divider for quick reference. The limitations and emergency procedures have been placed ahead of the normal procedures, performance and other sections to provide easier access to information that may be required in flight. The Emergency Procedures Section has been furnished with a red tab divider to present an instant reference to the section. Provisions for expansion of the handbook have been made by the deliberate omission of certain paragraph numbers, figure numbers, item numbers and pages noted as being intentionally left blank.

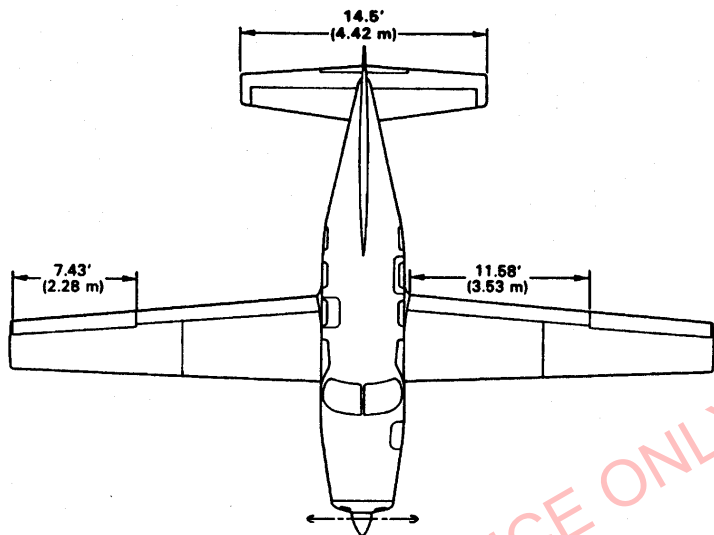

Wing Area 175.0 sq. ft. (16.3 sq. meters)
 Min. Turning Radius (from pivot point to wing tip) 35.4 ft. (10.8 meters)

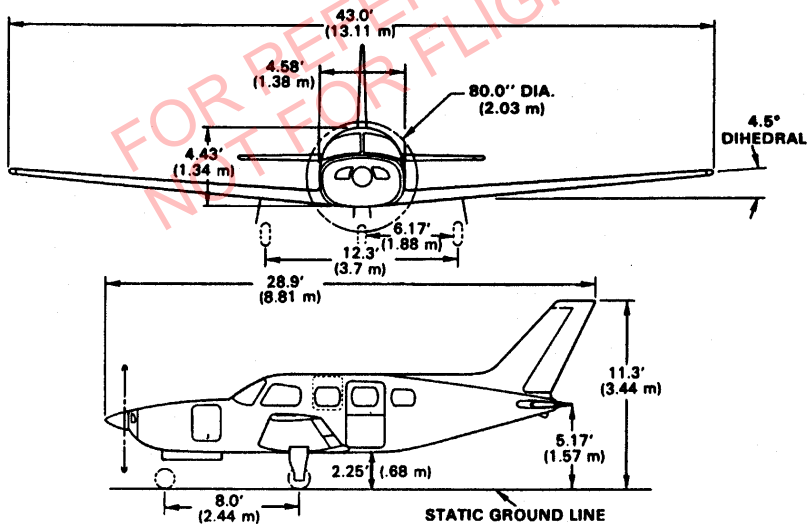

THREE VIEW
Figure 1-1

1.3 ENGINE

(a) Number of Engines	1
(b) Engine Manufacturer	Textron Lycoming
(c) Engine Model Number	TIO-540-AE2A
(d) Rated Horsepower	350
(e) Rated Speed (rpm)	2500
(f) Maximum Manifold Pressure (in. Hg.)	42.0
(g) Bore (inches)	5.125
(h) Stroke (inches)	4.375
(i) Displacement (cubic inches)	541.5
(j) Compression Ratio	7.3:1
(k) Engine Type	Six Cylinder, Direct Drive, Horizontally Opposed, Air Cooled, Turbocharged, Fuel Injected

1.5 PROPELLER (Standard)

(a) Number of Propellers	1
(b) Propeller Manufacturer	Hartzell
(c) Blade Model	7890K
(d) Number of Blades	3
(e) Hub Model	HC-I3YR-1E
(f) Propeller Diameter (inches)	80
(g) Propeller Type	Constant Speed, Hydraulically Actuated

1.7 FUEL

AVGAS ONLY

- (a) Fuel Capacity (U.S. gal.) (total) 122
- (b) Usable Fuel (U.S. gal.) (total) 120
- (c) Fuel
 - (1) Minimum Grade 100- Green or 100LL
Blue Aviation Grade
 - (2) Alternate Fuels Refer to latest revision of
Lycoming Service Instruction 1070,
except alcohol is *not* approved
for use in this airplane.

1.9 OIL

- (a) Oil Capacity (U.S. quarts) 12
- (b) Oil Specification Refer to latest revision of
Lycoming Service Instruction 1014.
- (c) Oil Viscosity per Average Ambient Temperature for Starting

<u>Average Ambient Temperature</u>	<u>MIL-L-22851 Ashless Dispersant SAE Grades</u>
All Temperatures	15W-50 or 20W-50
Above 80F	60
Above 60F	40 or 50
30F to 90F	40
0F to 70F	30, 40 or 20W-40
Below 10F	30 or 20W-30

When operating temperatures overlap indicated ranges, use the lighter grade oil. Use ashless dispersant oil only per the latest revision of Textron Lycoming Service Instruction 1014.

1.11 MAXIMUM WEIGHTS

(a) Maximum Ramp Weight (lb)	4358
(b) Maximum Takeoff Weight (lb)	4340
(c) Maximum Landing Weight (lb)	4123
(d) Maximum Zero Fuel Weight (lb)	4123
(e) Maximum Weights in Baggage Compartments (lb)	
(1) Forward	100
(2) Aft	100

1.13 STANDARD AIRPLANE WEIGHTS

Refer to Figure 6-5 for the Standard Empty Weight and the Useful Load.

1.15 CABIN AND ENTRY DIMENSIONS (IN.)

(a) Cabin Width (max.)	49.5
(b) Cabin Length (Instrument panel to rear bulkhead)	148
(c) Cabin Height (max.)	47
(d) Entry Width	24
(e) Entry Height	46

1.17 BAGGAGE SPACE AND ENTRY DIMENSIONS

(a) Compartment Volume (cu. ft.)	
(1) Forward	13
(2) Aft	20
(b) Entry Dimensions (in.)	
(1) Forward	19 x 23
(2) Aft	24 x 46

1.19 SPECIFIC LOADING

(a) Wing Loading (lbs. per sq. ft.)	24.8
(b) Power Loading (lbs. per hp)	12.4

1.21 SYMBOLS, ABBREVIATIONS AND TERMINOLOGY

The following definitions are of symbols, abbreviations and terminology used throughout the handbook and those which may be of added operational significance to the pilot.

(a) General Airspeed Terminology and Symbols

CAS	Calibrated Airspeed means the indicated speed of an aircraft, corrected for position and instrument error. Calibrated airspeed is equal to true airspeed in standard atmosphere at sea level.
KCAS	Calibrated Airspeed expressed in "Knots."
GS	Ground Speed is the speed of an airplane relative to the ground.
IAS	Indicated Airspeed is the speed of an aircraft as shown on the airspeed indicator when corrected for instrument error. IAS values published in this handbook assume zero instrument error.
KIAS	Indicated Airspeed expressed in "Knots."
M	Mach Number is the ratio of true airspeed to the speed of sound.
TAS	True Airspeed is the airspeed of an airplane relative to undisturbed air which is the CAS corrected for altitude, temperature and compressibility.
V _A	Maneuvering Speed is the maximum speed at which application of full available aerodynamic control will not overstress the airplane.
V _{FE}	Maximum Flap Extended Speed is the highest speed permissible with wing flaps in a prescribed extended position.

1.21 SYMBOLS, ABBREVIATIONS AND TERMINOLOGY (Continued)

V _{LE}	Maximum Landing Gear Extended Speed is the maximum speed at which an aircraft can be safely flown with the landing gear extended.
V _{LO}	Maximum Landing Gear Operating Speed is the maximum speed at which the landing gear can be safely extended or retracted.
V _{NE} /M _{NE}	Never Exceed Speed or Mach Number is the speed limit that may not be exceeded at any time.
V _{NO}	Maximum Structural Cruising Speed is the speed that should not be exceeded except in smooth air and then only with caution.
V _S	Stalling Speed or the minimum steady flight speed at which the airplane is controllable.
V _{SO}	Stalling Speed or the minimum steady flight speed at which the airplane is controllable in the landing configuration at maximum gross weight.
V _X	Best Angle-of-Climb Speed is the airspeed which delivers the greatest gain of altitude in the shortest possible horizontal distance.
V _Y	Best Rate-of-Climb Speed is the airspeed which delivers the greatest gain in altitude in the shortest possible time.

1.21 SYMBOLS, ABBREVIATIONS AND TERMINOLOGY (Continued)

(b) Meteorological Terminology

ISA	International Standard Atmosphere in which: (1) The air is a dry perfect gas; (2) The temperature at sea level is 15° Celsius (59° Fahrenheit); (3) The pressure at sea level is 29.92 inches hg. (1013.2 mb); (4) The temperature gradient from sea level to the altitude at which the temperature is -56.5C (-69.7F) is -0.00198C (-0.003564F) per foot and zero above that altitude.
OAT	Outside Air Temperature is the free air static temperature obtained either from inflight temperature indications or ground meteorological sources, adjusted for instrument error and compressibility effects.
Indicated Pressure Altitude	The number actually read from an altimeter when the barometric subscale has been set to 29.92 inches of mercury (1013.2 millibars).
Pressure Altitude	Altitude measured from standard sea-level pressure (29.92 in. Hg) by a pressure or barometric altimeter. It is the indicated pressure altitude corrected for position and instrument error. In this handbook, altimeter instrument errors are assumed to be zero.
Station Pressure	Actual atmospheric pressure at field elevation.
Wind	The wind velocities recorded as variables on the charts of this handbook are to be understood as the headwind or tailwind components of the reported winds.

1.21 SYMBOLS, ABBREVIATIONS AND TERMINOLOGY (Continued)

(c) Power Terminology

Takeoff Power	Maximum power permissible for takeoff.
Maximum Continuous Power	Maximum power permissible continuously during flight.
Maximum Climb Power	Maximum power permissible during climb.
Maximum Cruise Power	Maximum power permissible during cruise.

(d) Engine Instruments

T.I.T. Gauge	Turbine Inlet Temperature
--------------	---------------------------

(e) Airplane Performance and Flight Planning Terminology

Climb Gradient	The demonstrated ratio of the change in height during a portion of a climb, to the horizontal distance traversed in the same time interval.
Demonstrated Crosswind Velocity	The demonstrated crosswind velocity is the velocity of the crosswind component for which adequate control of the airplane during takeoff and landing was actually demonstrated during certification tests.
Accelerate-Stop Distance	The distance required to accelerate an airplane to a specified speed and, assuming failure of an engine at the instant that speed is attained, to bring the airplane to a stop.
Route Segment	A part of a route. Each end of that part is identified by (1) a geographical location or (2) a point at which a definite radio fix can be established.

1.21 SYMBOLS, ABBREVIATIONS AND TERMINOLOGY (Continued)

(f) Weight and Balance Terminology

Reference Datum	An imaginary vertical plane from which all horizontal distances are measured for balance purposes.
Station	A location along the airplane fuselage usually given in terms of distance from the reference datum.
Arm	The horizontal distance from the reference datum to the center of gravity (C.G.) of an item.
Moment	The product of the weight of an item multiplied by its arm. (Moment divided by a constant is used to simplify balance calculations by reducing the number of digits.)
Center of Gravity (C.G.)	The point at which an airplane would balance if suspended. Its distance from the reference datum is found by dividing the total moment by the total weight of the airplane.
C.G. Arm	The arm obtained by adding the airplane's individual moments and dividing the sum by the total weight.
C.G. Limits	The extreme center of gravity locations within which the airplane must be operated at a given weight.
Usable Fuel	Fuel available for flight planning.
Unusable Fuel	Fuel remaining after a runout test has been completed in accordance with governmental regulations.
Standard Empty Weight	Weight of a standard airplane including unusable fuel, full operating fluids and full oil.

1.21 SYMBOLS, ABBREVIATIONS AND TERMINOLOGY (Continued)

Basic Empty Weight	Standard empty weight plus optional equipment.
Payload	Weight of occupants, cargo and baggage.
Useful Load	Difference between takeoff weight, or ramp weight if applicable, and basic empty weight.
Maximum Ramp Weight	Maximum weight approved for ground maneuver. (It includes weight of start, taxi and run up fuel.)
Maximum Takeoff Weight	Maximum Weight approved for the start of the takeoff run.
Maximum Landing Weight	Maximum weight approved for the landing touchdown.
Maximum Zero Fuel Weight	Maximum weight exclusive of usable fuel.

FOR REFERENCE ONLY
NOT FOR FLIGHT

TABLE OF CONTENTS
SECTION 2
LIMITATIONS

Paragraph No.		Page No.
2.1	General	2-1
2.3	Airspeed Limitations	2-1
2.5	Airspeed Indicator Markings	2-2
2.7	Power Plant Limitations	2-3
2.9	Leaning Limitations	2-4
2.11	Power Plant Instrument Markings	2-4
2.13	Weight Limits	2-5
2.15	Center of Gravity Limits	2-5
2.17	Maneuver Limits	2-5
2.19	Flight Load Factors	2-5
2.21	Kinds of Operation Equipment List	2-6
2.23	Fuel Limitations	2-12
2.25	Operating Altitude Limitations	2-12
2.27	Cabin Pressurization Limits	2-12
2.29	Air Conditioning System Limitations	2-12
2.31	Electric Auxiliary Cabin Heater Limitations	2-12
2.33	Maximum Seating Configuration	2-13
2.34	Icing Information	2-13
2.35	Placards	2-14

SECTION 2
LIMITATIONS

2.1 GENERAL

This section provides the FAA Approved operating limitations, instrument markings, color coding and basic placards necessary for operation of the airplane and its systems.

Limitations associated with those optional systems and equipment which require handbook supplements can be found in Section 9 (Supplements).

2.3 AIRSPEED LIMITATIONS

SPEED	KIAS	KCAS
Never Exceed Speed (V_{NE}) - Do not exceed this speed in any operation.	198	200
Maximum Structural Cruising Speed (V_{NO}) - Do not exceed this speed except in smooth air and then only with caution.	168	170
Design Maneuvering Speed (V_A) - Do not make full or abrupt control movements above this speed.		
At 4340 LBS. Gross Weight	133	135
At 2450 LBS. Gross Weight	100	102

CAUTION

Maneuvering speed decreases at lighter weight as the effects of aerodynamic forces become more pronounced. Linear interpolation may be used for intermediate gross weights. Maneuvering speed should not be exceeded while operating in rough air.

2.3 AIRSPEED LIMITATIONS (CONTINUED)

SPEED	KIAS	KCAS
Maximum Speed for Pneumatic Boot Inflation.	178	180
Maximum Flaps Extended Speed (V_{FE}) - Do not exceed this speed at the given flap setting.		
10°	165	167
20°	130	132
36°	116	115
Maximum Landing Gear Extension Speed (V_{LO}) - Do not exceed this speed when extending the landing gear.	165	167
Maximum Landing Gear Retraction Speed (V_{LO}) - Do not exceed this speed when retracting the landing gear.	126	128
Maximum Landing Gear Extended Speed (V_{LE}) Do not exceed this speed with the landing gear extended.	195	197

2.5 AIRSPEED INDICATOR MARKINGS

MARKING	IAS
Red Radial Line (Never Exceed)	198 KTS
Yellow Arc (Caution Range - Smooth Air Only)	168 KTS to 198 KTS
Green Arc (Normal Operating Range)	69 KTS to 168 KTS
White Arc (Flap Down)	58 KTS to 116 KTS

2.7 POWER PLANT LIMITATIONS

(a) Number of Engines	1
(b) Engine Manufacturer	Textron Lycoming
(c) Engine Model No.	TIO-540-AE2A
(d) Engine Operating Limits	
(1) Maximum Engine Speed	2500 RPM
(2) Maximum Oil Temperature	245°F
(3) Maximum Cylinder Head Temperature	500°F
(4) Maximum Turbine Inlet Temperature	1750°F
(5) Maximum Manifold Pressure (inches of mercury)	
To 20,600 feet	42
20,600 to 25,000 feet	42 -1.6 per 1000 foot increase
(e) Oil Pressure	
Minimum (red line)	25 PSI
Maximum (red line)	115 PSI
(f) Fuel (AVGAS ONLY) (minimum grade)	100 or 100LL Aviation Grade
(g) Number of Propellers	1
(h) Propeller Manufacturer	Hartzell
(i) Propeller Hub and Blade Model (3 Blade)	HC-I3YR-1E/7890K
(j) Propeller Diameter (inches) 3 Blade	80
(k) Blade Angle Limits	
Low Pitch Stop (3 Blade) Min./Max.	13.5°/13.8°
High Pitch Stop (3 Blade) Min./Max.	38.2°/39.2°

2.9 LEANING LIMITATIONS

Mixture full RICH at all engine powers above high speed cruise power.

2.11 POWER PLANT INSTRUMENT MARKINGS

- (a) Tachometer
Green Arc (Normal Operating Range) 600 to 2500 RPM
Red Line (Maximum) 2500 RPM
- (b) Manifold Pressure
Green Arc (Normal Operating Range) 10 to 42.0 in. Hg
Red Line (Takeoff Power) 42.0 in. Hg
- (c) Oil Temperature
Green Arc (Normal Cruise Range) 100° to 245°F
Red Line (Maximum) 245°F
- (d) Oil Pressure
Green Arc (Normal Cruise Range) 55 PSI to 95 PSI
Yellow Arc (Caution Range) (Idle) 25 PSI to 55 PSI
Yellow Arc (Caution Range)
(Start and Warm Up) 95 PSI to 115 PSI
Red Line (Minimum) 25 PSI
Red Line (Maximum) 115 PSI
- (e) Turbine Inlet Temperature
Green Arc (Normal Operating Range) 1200°F to 1750°F
Red Line (Maximum) 1750°F
- (f) Cylinder Head Temperature
Green Arc (Normal Operating Range) 200°F to 500°F
Red Line (Maximum) 500°F
- (h) Vacuum Pressure
Green Arc (Normal Operating Range) 4.5 to 5.2 in. Hg
Red Line (Minimum) 4.5 In. Hg
Red Line (Maximum) 5.2 In. Hg

2.13 WEIGHT LIMITS

(a) Maximum Ramp Weight	4358 LB
(b) Maximum Takeoff Weight	4340 LB
(c) Maximum Landing Weight	4123 LB
(d) Maximum Zero Fuel Weight	4123 LB
(e) Maximum Baggage (100 lb each compartment)	200 LB

NOTE

Refer to Section 5 (Performance) for maximum weight as limited by performance.

2.15 CENTER OF GRAVITY LIMITS

Weight Pounds	Forward Limit Inches Aft of Datum	Rearward Limit Inches Aft of Datum
4340	144.1	147.1
4123	139.6	147.1
4000	137.0	146.5
2450 (and less)	130.7	137.6
2400		137.3

NOTES

Straight line variation between points given.

The datum used is 100.0 inches ahead of the forward pressure bulkhead.

It is the responsibility of the airplane owner and the pilot to ensure that the airplane is properly loaded. See Section 6 (Weight and Balance) for proper loading instructions.

2.17 MANEUVER LIMITS

No acrobatic maneuvers including spins approved.

2.19 FLIGHT LOAD FACTORS

(a) Positive Load Factor (Maximum)	
(1) Flaps Up	3.8 G
(2) Flaps Down	2.0 G
(b) Negative Load Factor (Maximum)	No inverted maneuvers approved

2.21 KINDS OF OPERATION EQUIPMENT LIST

This airplane may be operated in day or night VFR, day or night IFR and known icing when the appropriate equipment is installed and operable.

The following equipment list identifies the systems and equipment upon which type certification for each kind of operation was predicated and must be installed and operable for the particular kind of operation indicated.

NOTE

The following system and equipment list does not include specific flight instruments and communication/navigation equipment required by the FAR Part 91 and 135 operating requirements.

System	Number Required	Types of Operation and Remarks (DAY, NIGHT, VFR, IFR and ICING Conditions)
1. ELECTRICAL		
Alternators	1	DAY, NIGHT, VFR, IFR
DC Voltmeter	1	DAY, NIGHT, VFR, IFR, ICING
Ammeters	2	DAY, NIGHT, VFR, IFR, ICING
ALT INOP Annunciator	2	DAY, NIGHT, VFR, IFR, ICING
LO BUS VOLT Annunciator	1	DAY, NIGHT, VFR, IFR, ICING
Propeller Heat LED Indicator	1	ICING
Stall Warning	1	DAY, NIGHT, VFR, IFR, ICING
2. EQUIPMENT/ FURNISHINGS		
Safety Restraint Each Occupant	AR	DAY, NIGHT, VFR, IFR, ICING

2.21 KINDS OF OPERATION EQUIPMENT LIST (Continued)

System	Number Required	Types of Operation and Remarks (DAY, NIGHT, VFR, IFR and ICING Conditions)
3. FLIGHT CONTROLS		
Flap Position Indicator	1	DAY, NIGHT, VFR, IFR, ICING
Elevator and Rudder Trim Position Indicator	1 ea.	DAY, NIGHT, VFR, IFR, ICING
4. FUEL		
Fuel Quantity Indicating System	2	DAY, NIGHT, VFR, IFR, ICING
BOOST PUMP Annunciator	1	DAY, NIGHT, VFR, IFR, ICING
FUEL PRESS Annunciator	1	DAY, NIGHT, VFR, IFR, ICING
5. ICE PROTECTION		
Pneumatic Deice System (Wing and Empennage Protection)	1	ICING
Wing Ice Detection Light	1	ICING
Electrothermal Propeller Deice Pads	1 per Blade	ICING
Heated Windshield	1	ICING

2.21 KINDS OF OPERATION EQUIPMENT LIST (CONTINUED)

System	Number Required	Types of Operation and Remarks (DAY, NIGHT, VFR, IFR and ICING Conditions)
5. ICE PROTECTION (Continued)		
Heated Stall Warning Transducer	1	ICING
Heated Pitot Head	1	ICING
Alternate Static Source	1	ICING
WSHLD HEAT Annunciator	1	ICING
Vac Pump	2	ICING
SURF DEICE Annunciator	1	ICING
Alternator	2	ICING
6. INSTRUMENTA- TION - ENGINE		
Tachometer	1	DAY, NIGHT, VFR, IFR, ICING
Oil Pressure Indicator	1	DAY, NIGHT, VFR, IFR, ICING
Oil Temperature Indicator	1	DAY, NIGHT, VFR, IFR, ICING
Manifold Pressure Indicator	1	DAY, NIGHT, VFR, IFR, ICING
Cylinder Head Tem- perature Indicator	1	DAY, NIGHT, VFR, IFR, ICING
Turbine Inlet Tem- perature Indicator	1	DAY, NIGHT, VFR, IFR, ICING

2.21 KINDS OF OPERATION EQUIPMENT LIST (CONTINUED)

System	Number Required	Types of Operation and Remarks (DAY, NIGHT, VFR, IFR and ICING Conditions)
7. INSTRUMENTATION - FLIGHT		
Airspeed Indicator	1	DAY, NIGHT, VFR, IFR, ICING
Altimeter	1	DAY, NIGHT, VFR, IFR, ICING
Free Air Temperature Gauge	1	DAY, NIGHT, VFR, IFR, ICING
Gyroscopic Attitude Indicator	1	IFR, ICING
Gyroscopic Heading Indicator	1	IFR, ICING
Turn Coordinator	1	IFR, ICING
8. LANDING GEAR		
Hydraulic Pump	1	DAY, NIGHT, VFR, IFR, ICING
HYD PUMP Annunciator	1	DAY, NIGHT, VFR, IFR, ICING
Landing Gear Down Position Indicating Lights	3	DAY, NIGHT, VFR, IFR, ICING
Landing Gear Warning Horn	1	DAY, NIGHT, VFR, IFR, ICING
GEAR WARN Annunciator	1	DAY, NIGHT, VFR, IFR, ICING

2.21 KINDS OF OPERATION EQUIPMENT LIST (CONTINUED)

System	Number Required	Types of Operation and Remarks (DAY, NIGHT, VFR, IFR and ICING Conditions)
9. LIGHTS - EXTERNAL		
Position Lights		
a. Left Wing - Red and White	1 ea.	NIGHT
b. Right Wing - Green and White	1 ea.	NIGHT
Anti-Collision (Strobe) Lights	2	NIGHT
10. LIGHTS - COCKPIT		
Instrument Panel Switch Lights	AR	NIGHT
Instrument Lights	AR	NIGHT
Map Lights	2	NIGHT
11. PNEUMATIC/ VACUUM		
Vacuum Pumps	1	IFR
Gyro Suction Indicator	1	IFR, ICING

2.21 KINDS OF OPERATION EQUIPMENT LIST (CONTINUED)

System	Number Required	Types of Operation and Remarks (DAY, NIGHT, VFR, IFR and ICING Conditions)
12. PRESSURIZED FLIGHT		
Cabin Altimeter	1	DAY, NIGHT, VFR, IFR, ICING
Cabin Differential Pressure Indicator	1	DAY, NIGHT, VFR, IFR ICING
Cabin Vertical Speed Indicator	1	DAY, NIGHT, VFR, IFR ICING
Pressure Control Valve	1	DAY, NIGHT, VFR, IFR ICING
Pressure Relief Safety Valve	1	DAY, NIGHT, VFR, IFR ICING
Pressurization Controller	1	DAY, NIGHT, VFR, IFR ICING
CAB ALT Annunciator	1	DAY, NIGHT, VFR, IFR ICING
Vacuum Pump	1	DAY, NIGHT, VFR, IFR ICING
13. MISCELLANEOUS		
Stall Warning System	1	DAY, NIGHT, VFR, IFR, ICING
STALL WARN FAIL Annunciator	1	DAY, NIGHT, VFR, IFR, ICING
Annunciator Test System	1	DAY, NIGHT, VFR, IFR, ICING

2.23 FUEL LIMITATIONS

- (a) Minimum Aviation Fuel Grade..... 100LL/100
- (b) Total Capacity..... 122 U.S. GAL.
- (c) Unusable Fuel..... 2 U.S. GAL.
The unusable fuel for this airplane has been determined as 1.0 gallon in each wing in critical flight attitudes.
- (d) Usable Fuel..... 120 U.S. GAL.
The usable fuel in this airplane has been determined as 60 gallons in each wing.
- (e) Fuel Imbalance
Maximum fuel imbalance is 10 gallons.

2.25 OPERATING ALTITUDE LIMITATIONS

Flight above 25,000 feet pressure altitude is not approved. Flight up to and including 25,000 feet is approved if equipped with avionics in accordance with FAR 91 or FAR 135.

2.27 CABIN PRESSURIZATION LIMITS

- (a) Pressurized flight operation approved at maximum cabin differential pressure of 5.5 psi.
- (b) Pressurized landing not approved.

2.29 AIR CONDITIONING SYSTEM LIMITATIONS

AIR COND switch in OFF position for takeoffs and landings.

NOTE

BLOWER LOW or BLOWER HIGH switch may be selected

2.31 ELECTRIC AUXILIARY CABIN HEATER LIMITATIONS

- (a) Both alternators must be functioning.
- (b) The low voltage monitor system and annunciator must be functional.
- (c) The Vent/Defog Fan must be operational for heater ground operation.
- (d) Maximum ambient temperature for heater operation is 20°C (68°F).

2.33 MAXIMUM SEATING CONFIGURATION

The maximum seating capacity is 6 (six) persons.

2.34 ICING INFORMATION

"WARNING"

Severe icing may result from environmental conditions outside of those for which the airplane is certified. Flight in freezing rain, freezing drizzle, or mixed icing conditions (supercooled liquid water and ice crystals) may result in ice build-up on protected surfaces exceeding the capability of the ice protection system, or may result in ice forming aft of the protected surfaces. This ice may not be shed using the ice protection systems, and may seriously degrade the performance and controllability of the airplane.

During flight, severe icing conditions that exceed those for which the airplane is certificated shall be determined by the following visual cues. If one or more of these visual cues exists, immediately request priority handling from Air Traffic Control to facilitate a route or an altitude change to exit the icing conditions.

Unusually extensive ice accumulation on the airframe and windshield in areas not normally observed to collect ice.

Accumulation of ice on the upper surface of the wing, aft of the protected area.

Accumulation of ice on the engine nacelles and propeller spinners farther aft than normally observed.

Since the autopilot, when installed and operating, may mask tactile cues that indicate adverse changes in handling characteristics, use of the autopilot is prohibited when any of the visual cues specified above exist, or when unusual lateral trim requirements or autopilot trim warnings are encountered while the airplane is in icing conditions.

All wing icing inspection lights must be operative prior to flight into known or forecast icing conditions at night. [NOTE: This supersedes any relief provided by the Master Minimum Equipment List (MMEL).]

2.35 PLACARDS

In full view of the pilot:

The markings and placards installed in this airplane contain operating limitations which must be complied with when operating this airplane in the normal category. Other operating limitations which must be complied with when operating this airplane in this category are contained in the airplane flight manual. No aerobatic maneuvers, including spins, approved.

This aircraft approved for V.F.R., I.F.R., day and night icing flight when equipped in accordance with the Airplane Flight Manual.

On the instrument panel in full view of the pilot:

VA 133 KIAS at 4340 LBS.
(See A.F.M.)

In full view of the pilot:

VLO 165 DN, 126 UP
VLE 195 MAX

Near emergency gear release:

EMERGENCY GEAR EXTENSION
PULL TO RELEASE. SEE A.F.M.
BEFORE RE-ENGAGEMENT

In full view of the pilot:

WARNING

TURN OFF STROBE LIGHTS WHEN IN
CLOSE PROXIMITY TO GROUND OR
DURING FLIGHT THROUGH CLOUD,
FOG OR HAZE.

In full view of the pilot and passengers:

NO SMOKING

2.35 PLACARDS (CONTINUED)

Near the magnetic compass:

CAUTION - COMPASS CAL. MAY BE IN
ERROR WITH ELECT. EQUIPMENT
OTHER THAN AVIONICS ON.

In full view of the pilot when the air conditioner is installed:

WARNING: AIR CONDITIONER MUST BE
OFF TO INSURE NORMAL TAKEOFF
CLIMB PERFORMANCE.

On the inside of the forward baggage door:

MAXIMUM BAGGAGE THIS COMPART-
MENT 100 LBS.

On aft baggage closeout:

MAXIMUM BAGGAGE THIS COMPART-
MENT 100 LBS.

In full view of the pilot:

PRESSURIZED LANDING NOT APPROVED

Adjacent to fuel tank filler caps:

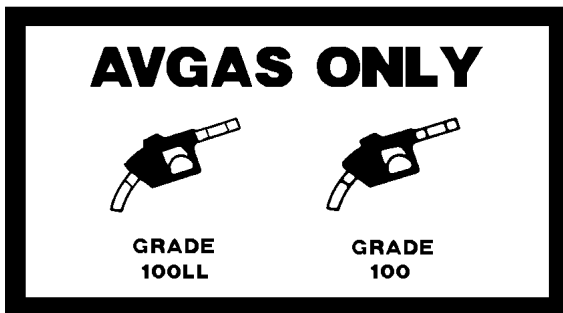

2.35 PLACARDS (CONTINUED)

Over emergency exit handle:

EMERGENCY EXIT
REMOVE GLASS
PULL DOOR IN - LIFT UP

On aft baggage closeout:

MAXIMUM LOAD EACH COAT HOOK 8 LBS

On aft close out panel, if required:

Rear Passenger / Baggage Areas
MAXIMUM ALLOWABLE WEIGHT
MAXIMUM ALLOWABLE COMBINED WEIGHT IN AFT SEATS IS
_____ POUNDS

LOAD IN ACCORDANCE WITH
WEIGHT AND BALANCE DATA

(Serial numbers 4636314 and up) On lower cabin door stop, and left and right side of upper cabin door bottom edge.

CAUTION
DO NOT ATTEMPT
TO CLOSE DOOR
WITH HANDLE IN
LATCHED POSITION

TABLE OF CONTENTS

SECTION 3

EMERGENCY PROCEDURES

Paragraph No.		Page No.
3.1	General	3-1
3.3	Emergency Procedures Checklist	3-2
3.3a	Engine Fire During Start (3.7)	3-2
3.3b	Turbocharger Failure (3.8)	3-2
3.3c	Engine Power Loss During Takeoff (3.9)	3-3
3.3d	Engine Power Loss In Flight (3.11)	3-4
3.3e	Power Off Landing (3.13)	3-5
3.3f	Fire In Flight (3.15)	3-6
3.3g	Loss of Oil Pressure (3.17)	3-7
3.3h	Loss of Fuel Flow (3.19)	3-7
3.3i	Engine Driven Fuel Pump Failure (3.21)	3-8
3.3j	High Oil Temperature (3.23)	3-8
3.3k	TIT Indicator Failure (3.24)	3-9
3.3l	High Cylinder Head Temperature (3.25)	3-10
3.3m	Electrical Failures (3.27)	3-10
3.3n	Propeller Overspeed (3.29)	3-12
3.3o	Emergency Landing Gear Extension (3.31)	3-12
3.3p	Spin Recovery (3.33)	3-13
3.3q	Engine Roughness (3.35)	3-13
3.3r	Emergency Descent (3.37)	3-13
3.3s	Pressurization System Malfunction (3.39)	3-14
3.3t	Cabin Air Contamination/Smoke Evacuation (Pressurized) (3.41)	3-15
3.3u	Vacuum System Failure (3.43)	3-16
3.3v	Inadvertent Icing Encounter (3.45)	3-16

TABLE OF CONTENTS

SECTION 3 (cont)

EMERGENCY PROCEDURES

Paragraph No.		Page No.
3.3w	Hydraulic System Malfunction (3.49).....	3-17
3.3x	Flap System Malfunction (3.51).....	3-17
3.3y	Fuel Tank Submerged Pump Failure (3.53)	3-18
3.3z	Stall Warning Failure (3.55).....	3-18
3.3aa	Annunciator Light Panel Failure (3.57)	3-18
3.3ab	Emergency Exit (3.59)	3-19
3.5	Amplified Emergency Procedures (General)	3-21
3.7	Engine Fire During Start (3.3a).....	3-21
3.8	Turbocharger Failure (3.3b)	3-21
3.9	Engine Power Loss During Takeoff (3.3c).....	3-23
3.11	Engine Power Loss In Flight (3.3d)	3-24
3.13	Power Off Landing (3.3e).....	3-25
3.15	Fire In Flight (3.3f).....	3-26
3.17	Loss of Oil Pressure (3.3g).....	3-27
3.19	Loss of Fuel Flow (3.3h)	3-27
3.21	Engine Driven Fuel Pump Failure (3.3i)	3-28
3.23	High Oil Temperature (3.3j).....	3-28
3.24	TIT Indicator Failure (3.3k)	3-28
3.25	High Cylinder Head Temperature (3.3l).....	3-29
3.27	Electrical Failures (3.3m).....	3-30
3.29	Propeller Overspeed (3.3n).....	3-32
3.31	Emergency Landing Gear Extension (3.3o)	3-32
3.33	Spin Recovery (3.3p).....	3-32
3.35	Engine Roughness (3.3q)	3-33
3.37	Emergency Descent (3.3r).....	3-33
3.39	Pressurization System Malfunction (3.3s)	3-34
3.41	Cabin Air Contamination/Smoke Evacuation (3.3t)	3-34
3.43	Vacuum Failure (3.3u).....	3-35

TABLE OF CONTENTS
SECTION 3 (cont)
EMERGENCY PROCEDURES

Paragraph No.		Page No.
3.45	Inadvertent Icing Encounter (3.3v)	3-35
3.49	Hydraulic System Malfunction (3.3w)	3-36
3.51	Flap System Malfunction (3.3x)	3-36
3.53	Fuel Tank Submerged Pump Failure (3.3y)	3-37
3.55	Stall Warning Failure (3.3z)	3-37
3.57	Annunciator Light Panel Failure (3.3aa)	3-37
3.59	Emergency Exit (3.3ab)	3-38

FOR REFERENCE ONLY
NOT FOR FLIGHT

SECTION 3

EMERGENCY PROCEDURES

3.1 GENERAL

This section provides the recommended procedures for coping with various emergency or critical situations. All of the emergency procedures required by the FAA as well as those necessary for operation of the airplane, as determined by the operating and design features of the airplane, are presented.

Emergency procedures associated with optional systems and equipment which require handbook supplements are presented in Section 9, Supplements.

This section is divided into two basic parts. The first part contains the emergency procedures checklists. These checklists supply an immediate action sequence to be followed during critical situations with little emphasis on the operation of the systems. The numbers located in parentheses after each checklist heading indicate where the corresponding paragraph in the amplified procedures can be found.

The second part of the section provides amplified emergency procedures corresponding to the emergency procedures checklist items. These amplified emergency procedures contain additional information to provide the pilot with a more complete description of the procedures so they may be more easily understood. The numbers located in parentheses after each paragraph heading indicates the corresponding checklist paragraph.

Pilots must familiarize themselves with the procedures given in this section and must be prepared to take the appropriate action should an emergency situation arise. The procedures are offered as a course of action for coping with the particular situation or condition described. They are not a substitute for sound judgement and common sense.

Most basic emergency procedures are a normal part of pilot training. The information presented in this section is not intended to replace this training. This information is intended to provide a source of reference for the procedures which are applicable to this airplane. The pilot should review standard emergency procedures periodically to remain proficient in them.

3.3 EMERGENCY PROCEDURES CHECKLIST

3.3a ENGINE FIRE DURING START (3.7)

Starter (crank engine).....PUSH
MixtureIDLE CUT-OFF
ThrottleOPEN
Fuel Selector.....OFF
Emergency (EMERG) Fuel Pump.....CHECK OFF
Abandon if fire continues

3.3b TURBOCHARGER FAILURE (3.8)

CAUTION:

If a turbocharger failure is the result of loose, disconnected or burned through exhaust system components, a potentially serious fire hazard exists as well as the risk of carbon monoxide migration into the passenger compartment of the aircraft. If a failure within the exhaust system is suspected in flight, immediately reduce power to idle (or as low a power setting as possible) and **LAND AS SOON AS POSSIBLE**. If a suspected exhaust system failure occurs prior to takeoff, **DO NOT FLY THE AIRCRAFT**.

NOTE:

A turbocharger malfunction may result in an overly rich fuel mixture, which could result in a partial power loss and/or a rough running engine. In worst-case conditions a complete loss of engine power may result.

COMPLETE LOSS OF ENGINE POWER:

If a suspected turbocharger or turbocharger control system failure results in a complete loss of engine power, the following procedure is recommended:

MixtureIDLE CUTOFF
Throttle.....CRUISE
Propeller ControlTAKEOFF
MixtureADVANCE SLOWLY until engine restarts
and adjust for smooth engine operation

Reduce power and land as soon as possible

3.3b TURBOCHARGER FAILURE (3.8) (Cont'd)**PARTIAL LOSS OF ENGINE POWER**

If the turbocharger wastegate fails in the OPEN position, a partial loss of engine power may result. The following procedure is recommended if a suspected turbocharger or turbocharger wastegate control failure results in a partial loss of engine power.

Throttle.....AS REQUIRED
 Propeller Control.....AS REQUIRED
 Mixture.....AS REQUIRED
 Continue Flight.....LAND AS SOON AS POSSIBLE

ENGINE POWER OVERBOOST

If the turbocharger wastegate control fails in the CLOSED position, an engine power overboost condition may occur. The following procedure is recommended for an overboost condition:

Throttle...REDUCE as necessary to keep manifold pressure within limits

NOTE

Expect manifold pressure response to throttle movements to be sensitive.

Propeller.....AS REQUIRED
 Mixture.....AS REQUIRED
 Continue Flight.....LAND AS SOON AS POSSIBLE

3.3c ENGINE POWER LOSS DURING TAKEOFF (3.9)

If sufficient runway remains for a normal landing, leave gear down and land straight ahead.

If area ahead is rough, or if it is necessary to clear obstructions:

Landing Gear SelectorUP
 MixtureIDLE CUT-OFF
 Emergency (EMERG) Fuel PumpOFF
 Fuel SelectorOFF
 Battery Master (after
 gear retraction).....OFF

3.3c ENGINE POWER LOSS DURING TAKEOFF (3.9) (Cont'd)

If sufficient altitude has been gained to attempt a restart:

Maintain Safe Airspeed

Emergency (EMERG) Fuel Pump.....Check ON
Fuel SelectorSWITCH to tank
containing fuel
MixtureFULL RICH
Induction AirALTERNATE

CAUTION

If normal engine operation and fuel flow are not reestablished, the emergency (EMERG) fuel pump should be turned OFF. The lack of a fuel flow indication could indicate a leak in the fuel system. If fuel system leak is verified, switch fuel selector to OFF.

If power is not regained:

Prepare for power off landing.

3.3d ENGINE POWER LOSS IN FLIGHT (3.11)

Trim for 90 KIAS (Power off glide speed)

Emergency (EMERG) Fuel Pump.....ON
Fuel selectorSWITCH to tank
containing fuel
MixtureRICH
Induction AirALTERNATE
Engine GaugesCHECK for indication
of cause of power loss

3.3d ENGINE POWER LOSS IN FLIGHT (3.11) (Cont'd)

If power is restored:

Induction AirPRIMARY
(Remain in ALTERNATE if induction ice is suspected)

Emergency (EMERG) Fuel Pump (Except in case of engine driven pump failure).....OFF

Mixture.....AS REQUIRED

Land as soon as practical and investigate cause of power loss.

CAUTION

If normal engine operation and fuel flow are not reestablished, the emergency (EMERG) fuel pump should be turned OFF. The lack of a fuel flow indication could indicate a leak in the fuel system. If fuel system leak is verified, switch fuel selector to OFF.

If power is not restored:

Prepare for power off landing.

3.3e POWER OFF LANDING (3.13)

Propeller ControlFULL DECREASE

Best gliding angle 90 KIAS.

Locate suitable field.

Establish spiral pattern.

1000 ft. above field at downwind position for normal landing approach.

When field can easily be reached slow to 77 KIAS for shortest landing.

Touchdowns should normally be made at lowest possible airspeed with flaps fully extended.

3.3e POWER OFF LANDING (3.13) (Continued)

When committed to landing:

Landing Gear SelectorAS REQUIRED
ThrottleCLOSED
MixtureIDLE CUT-OFF
FlapsAS REQUIRED
Fuel SelectorOFF
ALTR SwitchesOFF
Magneto SwitchesOFF
Emergency (EMERG) Fuel PumpOFF
Battery Master SwitchOFF
Seat Belt and HarnessTIGHT
Seatsadjusted and locked in position

NOTE

If the battery master and alternator switches are OFF, the gear position lights and flaps will be inoperative.

3.3f FIRE IN FLIGHT (3.15)

Source Of FireCHECK

NOTE

If pressurized, the following procedure will result in an immediate loss of pressurization and the cabin altitude will rise at an uncontrolled rate.

Electrical Fire (smoke in cabin):

Cabin Pressure Dump/Normal SwitchDUMP
Cabin Pressurization ControlPULL to unpressurize

After 5 second delay:

Battery Master SwitchOFF

NOTE

Activation of the Ground Clearance switch can be used to maintain communications on Comm 1.

ALTR SwitchesOFF
Cabin HeatOFF

3.3f FIRE IN FLIGHT (3.15) (Continued)

CAUTION

The cabin pressure dump valve will remain open if the cabin pressure dump/normal switch is positioned to DUMP prior to turning the aircraft electrical system OFF. This provides maximum airflow through the cabin for smoke evacuation. Do not turn the cabin pressure dump/normal switch to NORM. The dump valve will close and cannot be reactivated unless electrical power is turned on.

Emergency descentTO A SAFE ALTITUDE
CONSISTENT WITH TERRAIN

Land as soon as possible.

WARNING

If emergency oxygen is installed, use ONLY if flames and heat are not present.

Engine fire:

ThrottleCLOSED
MixtureIDLE CUT-OFF
Fuel SelectorOFF
Magneto SwitchesOFF
Emergency (EMERG) Fuel PumpCHECK OFF
Vent/Defog FanOFF
Temperature Control KnobPUSH OFF
Auxiliary Heat SwitchOFF
Proceed with power off landing procedure (3.3e).

3.3g LOSS OF OIL PRESSURE (3.17)

Land as soon as possible and investigate cause. Prepare for power off landing.

3.3h LOSS OF FUEL FLOW (3.19)

CAUTION

Turn emergency (EMERG) fuel pump OFF if fuel flow and power is not immediately restored. The lack of fuel flow indication could indicate a leak in the fuel system. If fuel system leak is verified, switch fuel selector to OFF.

3.3h LOSS OF FUEL FLOW (3.19) (Continued)

Emergency (EMERG) Fuel Pump.....ON
Fuel SelectorCHECK on tank
containing usable fuel

If power restored:

Emergency (EMERG) Fuel Pump (except in
case of engine driven pump failure).....OFF
Mixture.....AS REQUIRED

If power not restored:

Emergency (EMERG) Fuel PumpOFF
Fuel SelectorOFF
Proceed with power off landing procedure (3.3e).

3.3i ENGINE DRIVEN FUEL PUMP FAILURE (FUEL PRESS light illuminated - annunciator panel) (3.21)

ThrottleRETARD
Emergency (EMERG) Fuel Pump.....ON
ThrottleRESET AS REQUIRED
MixtureRESET AS REQUIRED

CAUTION

If normal engine operation and fuel flow are not reestablished the emergency (EMERG) fuel pump should be turned OFF. The lack of a fuel flow indication could indicate a leak in the fuel system. If system leak is verified, switch fuel selector to OFF.

If power is not restored, proceed with power off landing procedure (3.3e).

3.3j HIGH OIL TEMPERATURE (3.23)

Power.....REDUCE
Mixture.....ENRICH, if practical
Airspeed.....INCREASE, if practical

If condition is not corrected:

Land at nearest airport and investigate the problem. Prepare for power off landing.

**3.3k TURBINE INLET TEMPERATURE (TIT) INDICATOR FAILURE
(3.24)**

If failure occurs during takeoff, climb, or landing:

Mixture.....Full Rich

NOTE

During cruise climb operations, a fuel flow of 32 gph may be used.

If failure occurs prior to setting cruise power:

PowerSet Power per POH Section 5
Power Setting Table

MixtureLean to Approx. POH Section 5
Power Setting Table Fuel Flow
+4 GPH. Monitor CHT and Oil Temp.

CAUTION

Aircraft POH range and endurance data presented in Section 5 will no longer be applicable. Less range/endurance will result due to higher fuel flow/fuel consumption.

If failure occurs after setting cruise power and mixture:

Power.....Note/Maintain Power Setting
MixtureIncrease indicated Fuel Flow +1 GPH.
Monitor CHT and Oil Temp.

CAUTION

Aircraft POH range and endurance data presented in Section 5 will no longer be applicable. Less range/endurance will result due to higher fuel flow/fuel consumption.

If failure occurs prior to or during descent:

Power.....Set for Descent (20"MAP min.)
Mixture.....Full Rich

SECTION 3

EMERG PROCEDURES

PA-46-350P, MALIBU

3.3l HIGH CYLINDER HEAD TEMPERATURE (3.25)

If indicated cylinder head temperature reaches 480°F:

- CHT Cycle Push ButtonCYCLE THRU ALL CYLINDERS
- PowerREDUCE
- MixtureENRICH, if practical
- AirspeedINCREASE, if practical

If condition is not corrected:

Land at nearest airport and investigate problem.

3.3m ELECTRICAL FAILURES (3.27)

NOTE

Anytime total tie bus voltage is below 25 Vdc, the LOW BUS VOLTAGE annunciator will illuminate.

Single alternator Failure (Zero amps or ALTERNATOR #1 or #2 INOP light illuminated - annunciator panel).

- Verify failureCHECK AMMETER
- Electrical Load (if LOW BUS VOLTAGE annunciator illuminated)REDUCE until total load is less than 75 amps & LOW BUS VOLTAGE annunciator extinguished
- Failed ALTR SwitchOFF
- Failed ALTR Circuit BreakerCHECK and RESET as required
- Failed ALTR Switch (after OFF at least one second)ON

If power not restored:

- Failed ALTR SwitchOFF
- AmmeterMonitor and maintain BELOW 75 AMPS

While one alternator will supply sufficient current for minimum required avionics and cockpit lighting, use of deicing equipment, particularly windshield or propeller heat, may be limited. Immediate action should be taken to avoid or exit icing conditions. Under no circumstances may the total electrical load exceed 75 amps. The supplemental electric cabin heater, cabin recirculation blowers, and position, strobe, and landing lights should not be used unless absolutely necessary.

3.3m ELECTRICAL FAILURES (3.27) (Continued)

Dual Alternator Failure (Zero amps both ammeters or ALTERNATOR #1 and #2 INOP lights illuminated - annunciator panel).

NOTE

Anytime total tie bus voltage is below 25 Vdc, the LOW BUS VOLTAGE annunciator will illuminate.

- Electrical LoadREDUCE TO MINIMUM required for safe flight
- ALTR NO. 1 and NO. 2Switches OFF
- Circuit Breakers.....CHECK and RESET as required
- ALTR NO. 1 Switch (after OFF at least one second)ON
- ALTR NO. 2 Switch (after OFF at least one second)ON
- If only one alternator resets:
- Operating ALTR SwitchON
- Failed ALTR SwitchOFF
- Electrical LoadMAINTAIN LESS THAN 75 AMPS
- AmmeterMONITOR
- If neither alternator resets:
- Both ALTR SwitchesOFF

Continue flight with reduced electrical load on battery power only.

NOTE

LOW BUS VOLTAGE annunciator will be illuminated.

Land as soon as practical. Anticipate complete electrical failure. Duration of battery power available will be dependent on electrical load and battery condition prior to failure.

NOTE

If the battery is depleted, the landing gear must be lowered using the emergency extension procedure. The gear position lights will be inoperative. The flaps will also be inoperative and a flaps up landing will be required.

3.3m ELECTRICAL FAILURES (3.27) (Continued)

Supplemental Heater Control Circuit Failure (Heater Continues to Operate With AUX CBN HEAT and VENT/DEFOG switches OFF):

VENT DEFOG Circuit BreakerPULL

If the heater still operates:

BATT MASTER SwitchOFF

ALTR SwitchesOFF

Land as soon as practical.

3.3n PROPELLER OVERSPEED (3.29)

ThrottleRETARD

Oil PressureCHECK

Propeller ControlFULL DECREASE rpm,
then set if any
control available

AirspeedREDUCE

ThrottleAS REQUIRED to remain
below 2500 rpm

Land as soon as practical and investigate cause of overspeed.

3.3o EMERGENCY LANDING GEAR EXTENSION (3.31)

If emergency gear extension is required due to electrical power failure, the gear position indicator lights will not illuminate.

Prior to emergency extension procedure:

Battery Master SwitchCHECK ON

Circuit BreakersCHECK

DAY/NIGHT Dimming Switch (in daytime)DAY

If landing gear does not check down and locked:

AirspeedBELOW 90 KIAS

Hydraulic Pump Power Circuit Breaker (25 amp)PULL

Landing Gear SelectorDOWN

Emergency Gear Extend ControlPULL

(while fishtailing airplane)

CAUTION:

The Emergency Gear Extension procedure will require the pilot to pull the emergency gear extend control knob through a region of high resistance (up to 25 lbs.) in order to reach the stop and extend the landing gear.

3.3p SPIN RECOVERY (3.33)

RudderFULL OPPOSITE to
DIRECTION of ROTATION
Control Wheel.....FULL FORWARD while
NEUTRALIZING AILERONS
ThrottleCLOSED
Rudder (when rotation stops)NEUTRAL
Control Wheel.....AS REQUIRED to smoothly
regain level flight attitude

3.3q ENGINE ROUGHNESS (3.35)

MixtureADJUST FOR MAXIMUM
SMOOTHNESS
Induction AirALTERNATE
Emergency (EMERG) Fuel Pump.....ON
Fuel SelectorSELECT ANOTHER TANK

3.3r EMERGENCY DESCENT (3.37)

NOTE

If pressurized, the following procedure will result in an immediate loss of pressurization and the cabin altitude will rise at an uncontrolled rate.

ThrottleCLOSED
Propeller ControlFULL INCREASE
Mixture.....AS REQUIRED
Landing GearDOWN
(165 KIAS maximum)
FlapsUP

SMOOTH AIR

Airspeed After Landing Gear Is Fully Extended 180-195 KIAS

ROUGH AIR

Airspeed After Landing Gear Is Fully Extended4340 lbs. 133 KIAS
2450 lbs. 100 KIAS

3.3s PRESSURIZATION SYSTEM MALFUNCTION (3.39)

Should the differential pressure rise above 5.5 psi maximum or a structural failure appear imminent, proceed as follows:

NOTE

If pressurized, the following procedure will result in an immediate loss of pressurization and the cabin altitude will rise at an uncontrollable rate.

Cabin Pressure Dump/Normal SwitchDUMP
Cabin Pressurization ControlPULL to unpressurize
Emergency DescentTO A SAFE ALTITUDE
CONSISTENT WITH TERRAIN

NOTE

If emergency oxygen is installed, don masks, activate oxygen generators, check flow, and descend.

Should the aircraft suddenly lose pressurization, proceed as follows:

Cabin Pressure Dump/Normal SwitchCHECK NORM
Cabin Pressurization ControlCHECK IN
Emergency DescentTO A SAFE ALTITUDE
CONSISTENT WITH TERRAIN

NOTE

If emergency oxygen is installed, don masks, activate oxygen generators, check flow, and descend.

**3.3t CABIN AIR CONTAMINATION/SMOKE EVACUATION (3.41)
(Pressurized)**

NOTE

If pressurized, the following procedure will result in an immediate loss of pressurization and the cabin altitude will rise at an uncontrollable rate.

- Cabin Pressure Dump/Normal SwitchDUMP
- Cabin Pressurization ControlPULL to unpressurize
- Auxiliary Cabin Heat SwitchOFF
- Vent/Defog SwitchON
- AIR COND SwitchOFF
- Storm Windowclosed
- Emergency DescentTO A SAFE ALTITUDE
CONSISTENT WITH TERRAIN

Land as soon as practical.

NOTE

If emergency oxygen is installed, don masks, activate oxygen generators, check flow, and descend.

NOTE

If fumes/smoke dissipate, land as soon as practical to investigate problem. If fumes/smoke persist, refer to Fire in Flight paragraph 3.3f.

3.3u VACUUM SYSTEM FAILURE (3.43)

Single Vacuum System Failure (Reduced suction pressure and left or right Vacuum Inoperative Annunciators illuminated.)

Gyro Suction GaugeCHECK (within normal operating range)
Operating Pump annunciator lightEXTINGUSHED

Although either vacuum pump independently has sufficient capacity to operate the flight instruments and the deice boots in a normal manner, intentional or continued operation in icing conditions is not recommended. Immediate action should be taken to avoid or exit icing conditions.

Dual Vacuum System Failure (Suction below 4.0 in. Hg, both Vacuum Inoperative Annunciators illuminated.)

If both vacuum systems are inoperable, the turn coordinator and pilot's directional gyro will be the only usable gyroscopic flight instruments, wing and tail deicer boots will be inoperative, and loss of cabin pressure control is possible. Manually dump cabin pressure before landing. A precautionary landing should be considered depending on operating conditions.

3.3v INADVERTENT ICING ENCOUNTER (3.45)

WARNING

Flight into known icing conditions is prohibited unless Ice Protection System is installed and fully operational. Refer to Section 9, Supplement 3.

Induction AirALTERNATE
Pitot HeatON
Stall Warning HeatON
Windshield DefrostON
Propeller HeatON

3.3v INADVERTENT ICING ENCOUNTER (3.45) (Continued)

Vent/Defog Fan.....ON
Electric Windshield HeatLOW or HIGH,
as required

Change heading and/or altitude to exit icing conditions.

3.3w HYDRAULIC SYSTEM MALFUNCTION (3.49)

HYDRAULIC PUMP annunciator light illuminates continuously, or cycles on and off rapidly:

HYDRAULIC PUMP POWER Circuit BreakerPULL
Land as soon as practical and investigate the cause.

Prior to landing, the HYDRAULIC PUMP POWER circuit breaker must be reset in order to extend the landing gear. If pump continues to run after gear is locked down, pull the HYDRAULIC PUMP POWER circuit breaker. If gear fails to extend, refer to Emergency Landing Gear Extension (3.3o).

3.3x FLAP SYSTEM MALFUNCTION (3.51)

FLAPS annunciator light illuminated:

FLAP WARN circuit breakerPULL and RESET
VERIFY Normal Flap Operation.

If FLAPS annunciator light remains illuminated:

FLAP MOTOR Circuit BreakerPULL

CAUTION

Higher than normal approach and landing speeds may be required if full symmetrical flap extension is not available. Longer landing distances than shown in Section 5 will result from increased airspeed approaches.

Land as soon as practical and investigate the cause.

3.3y FUEL TANK SUBMERGED PUMP FAILURE (BOOST PUMP light illuminated - annunciator panel) (3.53)

Fuel SelectorCHECK
Boost Pump Circuit BreakerCHECK - RESET
if necessary
BOOST PUMP Annunciator LightEXTINGUISHED

If annunciator remains lit:

Emergency (EMERG) Fuel Pump.....ON
Fuel FlowCHECK for
fluctuation

Continue flight if no fuel flow fluctuations are observed. If fuel flow fluctuations are observed, descend to an altitude where the fluctuations cease and continue flight. After landing, have the inoperative boost pump repaired prior to further flight.

3.3z STALL WARNING FAILURE (STALL WARN FAIL light illuminated - annunciator panel) (3.55)

STALL WARN Circuit BreakerCHECK - RESET
if necessary

If circuit breaker does not remain closed, or STALL WARN FAIL annunciator does not extinguish, the stall warning system will be inoperative for remainder of flight. After landing, have system repaired prior to further flight.

3.3aa ANNUNCIATOR LIGHT PANEL FAILURE (ANNUNCIATOR INOP light illuminated - annunciator panel) (3.57)

ANNUN Circuit BreakerCHECK - RESET
if necessary
ANNUNCIATOR INOP LightEXTINGUISHED

If ANNUN circuit breaker not open:

Annunciator Test SwitchPUSH

3.3aa ANNUNCIATOR LIGHT PANEL FAILURE (ANNUNCIATOR INOP light illuminated - annunciator panel) (3.57) (Continued)

If annunciator lights illuminate, annunciator panel is functioning properly. ANNUNCIATOR INOP will remain lit.

If ANNUN circuit breaker does not remain closed, or lights fail to illuminate when tested, annunciator lights will be inoperative for remainder of flight.

System should be repaired prior to further flight.

3.3ab EMERGENCY EXIT (3.59)

Exit (second window from front
on right sideLOCATE

NOTE

The cabin must be depressurized before attempting to open the emergency exit.

Plexiglas CoverREMOVE
HandlePULL
Emergency Exit WindowPULL IN

FOR REFERENCE ONLY
NOT FOR FLIGHT

3.5 AMPLIFIED EMERGENCY PROCEDURES (GENERAL)

The following paragraphs are presented to supply additional information for the purpose of providing the pilot with a more complete understanding of the recommended course of action and probable cause of an emergency situation.

3.7 ENGINE FIRE DURING START (3.3a)

Engine fires during start are usually the result of overpriming. The first attempt to extinguish the fire is to try to start the engine and draw the excess fuel back into the induction system.

If a fire is present before the engine has started, move the mixture control to idle cut-off, open the throttle and crank the engine. This is an attempt to draw the fire back into the engine.

If the engine has started, continue operating to try to pull the fire into the engine.

In either case (above), if fire continues more than a few seconds, the fire should be extinguished by the best available external means.

Turn OFF the emergency fuel pump. The fuel selector valve should be OFF and the mixture at idle cut-off if an external fire extinguishing method is to be used.

3.8 TURBOCHARGER FAILURE (3.3b)

CAUTION:

If a turbocharger failure is the result of loose, disconnected or burned through exhaust system components, a potentially serious fire hazard exists as well as the risk of carbon monoxide migration into the passenger compartment of the aircraft. If a failure within the exhaust system is suspected in flight, immediately reduce power to idle (or as low a power setting as possible) and LAND AS SOON AS POSSIBLE. If a suspected exhaust system failure occurs prior to takeoff, DO NOT FLY THE AIRCRAFT.

NOTE:

A turbocharger malfunction may result in an overly rich fuel mixture, which could result in a partial power loss and/or a rough running engine. In worst-case conditions a complete loss of engine power may result.

3.8 TURBOCHARGER FAILURE (3.3b)(CONT'D)

COMPLETE LOSS OF ENGINE POWER:

If a suspected turbocharger or turbocharger control system failure results in a complete loss of engine power, the following procedure is recommended. Retard the mixture control to the IDLE CUTOFF position. If necessary, reset the throttle to cruise power position and the propeller control to the full forward position. Slowly advance the mixture until the engine restarts and adjust for smooth engine operation. Reduce the power to the minimum required and ***land as soon as possible***.

Set the propeller and mixture control as necessary. ***Land as soon as possible***.

PARTIAL LOSS OF ENGINE POWER

If the turbocharger wastegate fails in the OPEN position, a partial loss of engine power may result. The following procedure is recommended if a suspected turbocharger or turbocharger wastegate control failure results in a partial loss of engine power.

Should a partial loss of engine power occur (i.e. wastegate fails open), the throttle, propeller and mixture controls can be set as required for flight. Monitor all engine gauges and ***land as soon as possible*** to have the cause of the power loss investigated.

ENGINE POWER OVERBOOST

If the turbocharger wastegate control fails in the CLOSED position, an engine power overboost condition may occur. The following procedure is recommended for an overboost condition:

Throttle...REDUCE as necessary to keep manifold pressure within limits

NOTE

Expect manifold pressure response to throttle movements to be sensitive.

Set the propeller and mixture control as necessary. ***Land as soon as possible***.

3.9 ENGINE POWER LOSS DURING TAKEOFF (3.3c)

The proper action to be taken if loss of power occurs during takeoff will depend on the circumstances of the particular situation.

If sufficient runway remains to complete a normal landing, leave the landing gear down and land straight ahead.

If the area ahead is rough, or if it is necessary to clear obstructions, move the landing gear selector switch to the UP position and prepare for a gear up landing. If time permits, move mixture control to idle cut-off, turn OFF the emergency (EMERG) fuel pump, move the fuel selector to OFF and, after the landing gear is retracted, turn battery master switch OFF.

If sufficient altitude has been gained to attempt a restart, maintain a safe airspeed, turn the emergency (EMERG) fuel pump ON, and switch the fuel selector to another tank containing fuel. Ensure the mixture is full RICH and move the induction air lever to the ALTERNATE position.

CAUTION

If normal engine operation and fuel flow are not reestablished, the emergency (EMERG) fuel pump should be turned OFF. The lack of a fuel flow indication could indicate a leak in the fuel system. If fuel system leak is verified, switch fuel selector to OFF.

If engine failure was caused by fuel exhaustion, power will not be regained after switching fuel tanks until the empty fuel lines are filled. This may require up to ten seconds.

If power is not regained, proceed with Power Off Landing procedure (refer to paragraph 3.13).

3.11 ENGINE POWER LOSS IN FLIGHT (3.3d)

Complete engine power loss is usually caused by fuel flow interruption and power will be restored shortly after fuel flow is restored. The first step is to prepare for a power off landing (refer to paragraph 3.13). *An airspeed of 90 KIAS (the power off glide speed) should be maintained.*

If altitude permits, turn the emergency (EMERG) fuel pump ON and switch the fuel selector to another tank containing fuel. Reset the mixture control to RICH and move the induction air lever to ALTERNATE. Check the engine gauges for an indication of the cause of the power loss. If no fuel flow is indicated, check the tank selector position to be sure it is on a tank containing fuel.

If power is restored move the induction air to the PRIMARY position (unless induction ice is suspected). Turn OFF the emergency (EMERG) fuel pump (except in case of engine driven fuel pump failure) and adjust the mixture control as necessary. Land as soon as practical and investigate cause of power loss.

CAUTION

If normal engine operation and fuel flow are not reestablished, the emergency (EMERG) fuel pump should be turned OFF. The lack of a fuel flow indication could indicate a leak in the fuel system. If fuel system leak is verified, switch fuel selector to OFF.

If the preceding steps do not restore power, prepare for a power off landing.

If previous procedure has not restored power and time permits, secure one magneto at a time, then back to both ON. Move the throttle and mixture control levers to different settings. This may restore power if the problem is too rich or too lean a mixture or if there is a partial fuel system restriction. Water in the fuel could take some time to be used up, and allowing the engine to windmill may restore power. If power loss is due to water, fuel flow indications will be normal.

If engine failure was caused by fuel exhaustion, power will not be restored after switching fuel tanks until the empty fuel lines are filled. This may require up to ten seconds.

If power is not regained, proceed with the Power Off Landing procedure (refer to paragraph 3.13).

3.13 POWER OFF LANDING (3.3e)

If loss of power occurs at altitude, trim the aircraft for best gliding angle, (90 KIAS) and look for a suitable field. If measures taken to restore power are not effective, and if time permits, check your charts for airports in the immediate vicinity; it may be possible to land at one if you have sufficient altitude. At best gliding angle, with no wind, with the engine windmilling and the propeller control in full DECREASE rpm, the aircraft will travel approximately 2 miles for each thousand feet of altitude. If possible, notify the FAA or any other authority by radio of your difficulty and intentions. If another pilot or passenger is aboard, let them help.

When you have located a suitable field, establish a spiral pattern around this field. Try to be at 1000 feet above the field at the downwind position, to make a normal landing approach. When the field can easily be reached, slow to 77 KIAS with flaps down for the shortest landing. Excess altitude may be lost by widening your pattern, using flaps or slipping, or a combination of these.

Whether to attempt a landing with gear up or down depends on many factors. If the field chosen is obviously smooth and firm, and long enough to bring the plane to a stop, the gear should be down. If there are stumps or rocks or other large obstacles in the field, the gear in the down position will better protect the occupants of the aircraft. If however, the field is suspected to be excessively soft or short, or when landing in water of any depth, a wheels-up landing will normally be safer and do less damage to the airplane.

Touchdowns should normally be made at the lowest possible airspeed with flaps fully extended.

When committed to landing, verify the landing gear selector position as required by field conditions. Close the throttle, move the mixture to idle cut-off. Set the flaps to the desired flap setting, and move the fuel selector valve to OFF. Turn the alternator switches, magneto switches, emergency fuel pump and battery master switches OFF. The seat belts and shoulder harness should be tightened and checked. The seats should be adjusted and locked in position.

NOTE

If the battery master and alternator switches are OFF, the gear position lights and flaps will be inoperative.

3.15 FIRE IN FLIGHT (3.3f)

The presence of fire is noted through smoke, smell, and heat in the cabin. It is essential that the source of the fire be promptly identified through instrument readings, character of smoke, or other indications since the action to be taken differs somewhat in each case.

Check for the source of the fire first.

NOTE

If pressurized, the following procedure will result in an immediate loss of pressurization and the cabin altitude will rise at an uncontrolled rate.

If an electrical fire is indicated (smoke in cockpit), place the cabin pressure dump/normal switch in the DUMP position and PULL the cabin pressurization control to clear the smoke. After a delay of 5 seconds turn off the battery master and alternator switches. The cabin heat should also be turned OFF.

NOTE

Activation of the Ground Clearance switch can be used to maintain communications on Comm 1.

CAUTION

The cabin pressure dump valve will remain open if the cabin pressure dump/normal switch is positioned to DUMP prior to turning the aircraft electrical system OFF. This provides maximum airflow through the cabin for smoke evacuation. Do not set the cabin pressure dump/normal switch to NORM. The dump valve will close and cannot be reactivated unless electrical power is turned ON.

An emergency descent should be executed to a safe altitude consistent with terrain and a landing made as soon as possible.

WARNING

If emergency oxygen is installed, use ONLY if flames and heat are not present.

If an engine fire is present, close the throttle, move the mixture control to idle cut-off and place the fuel selector in the OFF position. Turn the magneto switches OFF and check that the emergency (EMERG) fuel pump is OFF. In

3.15 FIRE IN FLIGHT (3.3f) (Continued)

all cases, the heater and defroster should be OFF. If radio communication is not required turn the battery master and alternator switches OFF. If the terrain permits, a landing should be made immediately (refer to Power Off Landing procedure paragraph 3.13). Because the flaps and landing gear position lights will become inoperative, be sure final flap and gear selection is made before turning the battery master and alternator switches OFF.

3.17 LOSS OF OIL PRESSURE (3.3g)

Loss of oil pressure may be either partial or complete. A partial loss of oil pressure usually indicates a malfunction in the oil pressure regulating system, and a landing should be made as soon as possible to investigate the cause and prevent engine damage.

A complete loss of oil pressure indication may signify oil exhaustion or may be the result of a faulty gauge. In either case, proceed toward the nearest airport and be prepared for a forced landing. If the problem is not a pressure gauge malfunction, the engine may stop suddenly. Maintain altitude until such time as a power off landing can be accomplished. Do not change power settings unnecessarily, as this may hasten complete power loss.

Depending on the circumstances, it may be advisable to make an off airport landing while power is still available, particularly if other indications of actual oil pressure loss, such as sudden increases in temperatures, or oil smoke, are apparent, and an airport is not close.

If engine stoppage occurs, proceed with Power Off Landing procedure (refer to paragraph 3.13).

3.19 LOSS OF FUEL FLOW (3.3h)*CAUTION*

Turn emergency (EMERG) fuel pump OFF if fuel flow and power is not immediately restored. The lack of a fuel flow indication could indicate a leak in the fuel system. If fuel system leak is verified, switch fuel selector OFF.

The most probable cause of loss of fuel flow is either fuel depletion in the fuel tank selected or failure of the engine driven fuel pump. If loss of fuel flow occurs, turn the emergency (EMERG) fuel pump ON and check that the fuel selector is on a tank containing usable fuel.

3.19 LOSS OF FUEL FLOW (3.3h) (Continued)

If power is restored, turn OFF the emergency (EMERG) fuel pump (except in the case of an engine driven fuel pump failure). Adjust the mixture control as necessary.

If power is not restored, turn the emergency (EMERG) fuel pump and the fuel selector OFF, and proceed with Power Off Landing procedure (refer to paragraph 3.13).

3.21 ENGINE DRIVEN FUEL PUMP FAILURE (FUEL PRESS light illuminated - annunciator panel) (3.3i)

If an engine driven fuel pump failure is indicated, retard the throttle and turn the emergency (EMERG) fuel pump ON. The throttle and mixture should then be reset as required. A landing should be made at the nearest appropriate airport as soon as possible and the cause of the failure investigated.

CAUTION

If normal engine operation and fuel flow are not reestablished, the emergency (EMERG) fuel pump should be turned OFF. The lack of a fuel flow indication could indicate a leak in the fuel system. If fuel system leak is verified, switch fuel selector to OFF.

3.23 HIGH OIL TEMPERATURE (3.3j)

An abnormally high oil temperature indication may be caused by a low oil level, an obstruction in the oil cooler, damaged or improper baffle seals, a defective gauge, or other causes. Reduce power and/or enrich the mixture, and increase airspeed if practical. If condition is not corrected, land as soon as practical at an appropriate airport and have the cause investigated.

A steady rapid rise in oil temperature is a sign of trouble. Land at the nearest airport and let a mechanic investigate the problem. Watch the oil pressure gauge for an accompanying loss of pressure.

3.24 TURBINE INLET TEMP (TIT) INDICATOR FAILURE (3.3k)

In the event the Turbine Inlet Temperature (TIT) indicator or sensor fails during flight, continued flight is possible using conservative mixture/TIT settings. If TIT failure occurs during takeoff, climb, descent, or landing, maintain a full rich mixture to assure adequate fuel flow for engine cooling. During cruise climb operations, a fuel flow of 32 gph may be used.

**3.24 TURBINE INLET TEMP (TIT) INDICATOR FAILURE (3.3k)
(CONT'D)**

If TIT failure occurs prior to setting cruise power, set power per the POH Section 5 power setting table and then lean to the approximate POH power setting table fuel flow +4 GPH. This fuel flow will maintain adequate engine cooling and a TIT value below TIT limits. Monitor CHT and Oil Temperature for normal operation.

CAUTION

Aircraft POH range and endurance data presented in Section 5 will no longer be applicable. Less range/endurance will result due to higher fuel flow/fuel consumption.

If TIT failure occurs after setting cruise power and mixture per the POH Section 5 power setting table, maintain the power setting and increase indicated fuel flow by + 1 GPH. This fuel flow will maintain adequate engine cooling and TIT value below TIT limits. Monitor CHT and Oil Temperature for normal operation.

CAUTION

Aircraft POH range and endurance data presented in Section 5 will no longer be applicable. Less range/endurance will result due to higher fuel flow/fuel consumption.

The TIT indicating system should be repaired as soon as practical.

3.25 HIGH CYLINDER HEAD TEMPERATURE (3.3i)

If the standard cylinder head temperature gauge indication reaches 480°, the CHT CYCLE push button should be periodically used to cycle through all cylinder head temperatures to be sure the hottest cylinder is displayed. A difference of 5°F is needed before the displayed CHT switches to another cylinder.

Excessive cylinder head temperature may parallel excessive oil temperature. In any case, reduce power and/or enrich the mixture, and increase airspeed if practical. If the problem persists, land as soon as practical at an appropriate airport and have the cause investigated.

3.27 ELECTRICAL FAILURES (3.3m)

SINGLE ALTERNATOR FAILURE (Zero amps or ALTERNATOR #1 or #2 INOP light illuminated - annunciator panel)

NOTE

Anytime total tie bus voltage is below 25 Vdc, the LOW BUS VOLTAGE annunciator will illuminate.

Loss of either alternator is indicated by a zero reading on the appropriate ammeter and the illumination of the associated annunciator (ALTERNATOR #1 INOP or ALTERNATOR #2 INOP).

If the LOW BUS VOLTAGE annunciator is illuminated, first reduce the electrical load to less than 75 amps, which should extinguish the LOW BUS VOLTAGE annunciator, and prevent overloading the operating alternator.

Next, turn the failed alternator (ALTR NO. 1 or ALTR NO. 2) switch OFF for at least one second. Check the inoperative alternator (ALTNR NO. 1 or ALTNR NO. 2) circuit breaker and reset as required.

If the trouble was caused by a momentary overvoltage condition, the alternator control unit can now be reset by turning the failed alternator switch ON.

If the affected alternator's ammeter continues to read zero, and the annunciator remains lit, turn the failed alternator's switch OFF. Continue flight and monitor the operating alternator's ammeter to ensure the electrical load does not exceed 75 amps. The annunciator of the failed alternator will remain lit.

While one alternator will supply sufficient current for minimum required avionics and cockpit lighting, use of deicing equipment, particularly windshield or propeller heat, may be limited. Immediate action should be taken to avoid or exit icing conditions. Under no circumstances may the total electrical load exceed 75 amps. The electric cabin heater, cabin recirculation blowers, and position, strobe, and landing lights should not be used unless absolutely necessary.

3.27 ELECTRICAL FAILURES (3.3m) (Continued)

DUAL ALTERNATOR FAILURE (Zero amps both ammeters or ALTERNATOR #1 and #2 INOP light illuminated - annunciator panel)

NOTE

Anytime total tie bus voltage is below 25 Vdc, the LOW BUS VOLTAGE annunciator will illuminate.

In the event that both alternators indicate failure simultaneously, reduce electrical load to minimum required for safe flight by turning OFF switches and pulling circuit breakers for all nonessential electrical equipment. Maintain only that equipment required to provide heading, attitude, and altitude information, plus one navigation radio and one communications radio for emergency use only.

Attempt to reestablish alternator power on each alternator individually by first turning OFF both alternators for at least one second, resetting any tripped alternator (ALTR) control circuit breakers, and then turning each alternator ON, one at a time.

If only one alternator can be restored, reinstate electrical load as desired to a maximum of 75 amps. Land as soon as practical for proper repairs.

If neither alternator can be restored to operation, continue flight with reduced electrical load on battery power only.

NOTE

LOW BUS VOLTAGE annunciator will be illuminated.

Land as soon as safely practical, as battery power duration is dependent upon the condition of the battery at time of failure.

NOTE

If battery is depleted, the landing gear must be lowered using the emergency extension procedure. The gear position lights will be inoperative. The flaps will also be inoperative and a flaps up landing will be required.

3.27 ELECTRICAL FAILURES (3.3m) (Continued)

SUPPLEMENTAL HEATER CONTROL CIRCUIT FAILURE (Heater Continues to Operate With AUX CBN HEAT and VENT/DEFOG Switches OFF)

Pull the VENT DEFOG circuit breaker. If the heater still operates, turn the BATT MASTER and ALTR switches OFF. Land as soon as practical.

3.29 PROPELLER OVERSPEED (3.3n)

Propeller overspeed is caused by a malfunction in the propeller governor or low oil pressure which allows the propeller blades to rotate to full low pitch.

If propeller overspeed should occur, retard the throttle and check the oil pressure. The propeller control should be moved to full DECREASE rpm and then reset if any control is available. Airspeed should be reduced and throttle used to maintain 2500 RPM. Land as soon as practical and investigate cause of overspeed.

3.31 EMERGENCY LANDING GEAR EXTENSION (3.3o)

Prior to proceeding with an emergency gear extension, check to ensure that the battery master switch (BATT MSTR) is ON and that the circuit breakers have not popped. If it is daytime, the Day/Night dimmer switch should be in the DAY position.

If the landing gear does not check down and locked, reduce the airspeed to below 90 KIAS, pull out the HYDRAULIC PUMP POWER circuit breaker, place the landing gear selector in the DOWN position, pull the emergency gear extend control OUT and fishtail the airplane. Verify the landing gear position lights indicate down and locked.

CAUTION:

The Emergency Gear Extension procedure will require the pilot to pull the emergency gear extend control knob through a region of high resistance (up to 25 lbs.) in order to reach the stop and extend the landing gear.

If all electrical power has been lost, the landing gear must be extended using the above procedures. The gear position indicator lights will not illuminate.

3.33 SPIN RECOVERY (3.3p)

Intentional spins are prohibited in this airplane. If a spin is inadvertently entered, immediately apply full rudder opposite to the direction of rotation. Move the control wheel full forward while neutralizing the ailerons. CLOSE the throttle. When the rotation stops, neutralize the rudder and relax forward pressure on the control wheel as required to smoothly regain a level flight attitude.

3.35 ENGINE ROUGHNESS (3.3q)

Engine roughness may be caused by dirt in the injector nozzles, induction filter icing, ignition problems, or other causes.

First adjust the mixture for maximum smoothness. The engine will run rough if the mixture is too rich or too lean.

Move the induction air to ALTERNATE and turn the emergency (EMERG) fuel pump ON.

Switch the fuel selector to another tank to determine if fuel contamination is the problem.

Check the engine gauges for abnormal readings. If any gauge readings are abnormal proceed accordingly.

The magneto switches should then be turned OFF individually and then turned back ON. If operation is satisfactory on only one magneto, proceed on the good magneto at reduced power to a landing at the first available airport.

If roughness persists, prepare for a precautionary landing at pilot's discretion.

3.37 EMERGENCY DESCENT (3.3r)**NOTE**

If pressurized, the following procedure will result in the immediate loss of pressurization and the cabin altitude will rise at an uncontrolled rate.

In the event an emergency descent becomes necessary, retard the throttle to idle and move the propeller control to the full INCREASE position. The mixture should be reset as required to ensure the engine will continue operating. Lower the landing gear and immediately initiate a descent. If in smooth air, descend at 180 to 195 KIAS maximum. If extremely rough air is encountered, the airspeed should be limited according to the following airspeed versus Gross Weight Table:

4340 lb = 133 KIAS

2450 lb = 100 KIAS

Use straight line variation between points.

After reaching a safe altitude, advance the throttle and adjust mixture and propeller controls for power as required.

3.39 PRESSURIZATION SYSTEM MALFUNCTION (3.3s)

NOTE

If pressurized, the following procedure will result in an immediate loss of pressurization and the cabin altitude will rise at an uncontrollable rate.

Should the differential pressure rise above 5.5 psi maximum or a structural failure appear imminent, an immediate decrease in differential pressure is required. To accomplish this, select DUMP on the cabin pressure dump/normal switch and PULL the cabin pressurization (CABIN PRESS) control. This will cause the cabin altitude to rise at an uncontrolled rate and cabin differential pressure to decrease, subsequently relieving the overpressure condition. If emergency oxygen is not installed execute an emergency descent to a safe altitude consistent with terrain. If emergency oxygen is installed, don the oxygen masks, activate the oxygen generators and descend to a safe altitude consistent with terrain.

Should the aircraft suddenly lose pressurization, check that the cabin pressure dump/normal switch is in the NORM position and that the cabin pressurization (CABIN PRESS) control is pushed in. If the aircraft does not begin to repressurize and emergency oxygen is not installed, execute an emergency descent to a safe altitude consistent with terrain. If emergency oxygen is installed, don the oxygen masks, activate the oxygen generators and descend to a safe altitude consistent with terrain.

3.41 CABIN AIR CONTAMINATION/SMOKE EVACUATION (3.3t)

NOTE

If pressurized, the following procedure will result in an immediate loss of pressurization and the cabin altitude will rise at an uncontrollable rate.

Strong fumes or smoke in the cabin may indicate a malfunction in the pressurization system or a fire. In any event, the primary concern is to establish maximum airflow through the cabin in order to vent the fumes or smoke. To accomplish this, set the cabin pressure dump/normal switch to DUMP and PULL the cabin pressurization (CABIN PRESS) control out. Turn OFF the auxiliary cabin heater. Turn ON the vent/defog blower and turn OFF the cabin air recirculation blower. Do not open the storm window. This procedure will provide the maximum flow of outside ram air through the cabin. If emergency oxygen is not installed, execute an emergency descent to a safe altitude consistent with terrain. If emergency oxygen is installed, don the oxygen masks, activate the oxygen generators and descend to a safe altitude consistent with terrain. Land as soon as practical and investigate the cause. If the fumes or smoke persist the problem may be a fire (see paragraph 3.15, Fire In Flight).

3.43 VACUUM SYSTEM FAILURE (3.3u)

A failure of either vacuum pump is indicated by the illumination of a vacuum failure annunciator, "VACUUM NO. 1 INOP".or "VACUUM NO. 2 INOP.

In the event one vacuum pump fails, check that the suction gauge still indicates within the normal operating range, and that the operating pump's vacuum failure annunciator is extinguished.

Although either vacuum pump independently has sufficient capacity to operate the flight instruments and the deice boots in a normal manner, intentional or continued operation in icing conditions is not recommended. Immediate action should be taken to avoid or exit icing conditions.

Failure of both vacuum pumps is indicated by the suction gauge reading less than 4.0 inches of mercury and illumination of both annunciators.

If both vacuum systems are inoperable, the turn coordinator and pilot's directional gyro will be the only usable gyroscopic flight instruments. The wing and tail deicer boots will be inoperative. Also, loss of cabin pressure control is possible; the cabin pressure will have to be dumped manually before landing. A precautionary landing should be considered depending on operating conditions.

3.45 INADVERTENT ICING ENCOUNTER (3.3v)**WARNING**

Flight into known icing conditions is prohibited unless Ice Protection System is installed and fully operational. Refer to Section 9, Supplement 3.

If icing conditions are inadvertently encountered, select ALTERNATE induction air and adjust manifold pressure as required. Turn the pitot and stall warning heat ON. Pull ON the windshield defrost and turn the propeller heat ON. Turn the windshield vent/defog fan ON to keep the windshield as clear as possible. If installed, turn the electric windshield heat ON. Change aircraft heading and/or altitude to exit icing conditions as soon as possible.

3.49 HYDRAULIC SYSTEM MALFUNCTION (3.3w)

A hydraulic system malfunction, which causes the hydraulic pump to either run continuously (more than 15-20 seconds), or cycle on and off rapidly (more than 6-8 times), may be detected by the illumination of the HYDRAULIC PUMP amber annunciator light. Pull the HYDRAULIC PUMP POWER circuit breaker to stop operation. The pump is not designed for continuous duty and will fail if left running. Land as soon as practical and investigate the cause. Prior to landing, the HYDRAULIC PUMP POWER circuit breaker must be reset in order to extend the landing gear. If the pump continues to run after the gear is locked down, again pull the HYDRAULIC PUMP POWER circuit breaker. If the gear fails to extend, refer to Emergency Landing Gear Extension (3.31).

3.51 FLAP SYSTEM MALFUNCTION (3.3x)

Illumination of the FLAPS annunciator would normally be the result of an overcurrent condition in the flap motor/actuator circuit. If an overcurrent fault occurs the flap protection circuit will sense the malfunction and automatically remove power from the flap motor/actuator and flap operation will stop. Pulling and resetting the FLAP WARN circuit breaker will restore flap power to normal operation.

After resetting, normal operation of the flaps should be verified.

CAUTION

Higher than normal approach and landing speeds may be required if full symmetrical flap extension is not available. Longer landing distances than shown in Section 5 will result from increased airspeed approaches.

If normal flap operation is not regained, or the FLAPS annunciator remains illuminated, pull the FLAP MOTOR circuit breaker and land as soon as practical to ascertain the cause of the problem. The flaps will remain in the same position as when the malfunction occurred.

3.53 FUEL TANK SUBMERGED PUMP FAILURE (BOOST PUMP light illuminated - annunciator panel) (3.3y)

Illumination of the BOOST PUMP annunciator light indicates the selected fuel tank's submerged fuel boost pump has failed. Immediately check that the fuel selector is in the proper position and check the appropriate FUEL PUMPS (L BOOST or R BOOST) circuit breaker located on the pilot's forward breaker panel; reset as necessary. Check that the BOOST PUMP annunciator is extinguished.

If the FUEL PUMPS circuit breaker does not remain closed, or the BOOST PUMP annunciator remains lit, turn ON the emergency (EMERG) fuel pump and check for fluctuations in the fuel flow indication. Continue flight if no fuel flow fluctuations are observed. If fuel flow fluctuations are observed, descend to an altitude where the fluctuations cease and continue flight. After landing, have the inoperative boost pump repaired prior to further flight.

3.55 STALL WARNING FAILURE (STALL WARN FAIL light illuminated - annunciator panel) (3.3z)

Illumination of the STALL WARN FAIL annunciator light means the lift computer has failed. Check, and if necessary, reset the STALL WARN circuit breaker located on the pilot's forward circuit breaker panel. If the breaker does not remain closed, or if the STALL WARN FAIL annunciator light does not extinguish, the stall warning system will be inoperative for the remainder of the flight. After landing, have the system repaired before further flight.

3.57 ANNUNCIATOR LIGHT PANEL FAILURE (ANNUNCIATOR INOP light illuminated - annunciator panel) (3.3aa)

Should the ANNUNCIATOR INOP light illuminate, check the ANNUN circuit breaker located on the pilot's aft circuit breaker panel. Reset, if necessary, and the ANNUNCIATOR INOP light should extinguish.

If the ANNUN circuit breaker is not open, the annunciator fail relay switch is faulty. Push the annunciator test switch; if all lights illuminate, the annunciator panel is functioning properly. The ANNUNCIATOR INOP light will remain lit.

Should the ANNUN circuit breaker fail to remain closed, or the annunciators fail to illuminate when tested, the annunciator lights will be inoperative for the remainder of the flight. Also, the landing gear position lights cannot be tested nor dimmed. The system should be repaired prior to further flight.

3.59 EMERGENCY EXIT (3.3ab)

The second window aft of the windshield on the right side of the fuselage is an emergency exit.

NOTE

The cabin must be depressurized before attempting to open the emergency exit.

To use the emergency exit, remove the plexiglas cover over the handle, pull the handle, and pull in on the exit window.

FOR REFERENCE ONLY
NOT FOR FLIGHT

TABLE OF CONTENTS

SECTION 4

NORMAL PROCEDURES

Paragraph No.		Page No.
4.1	GENERAL	4-1
4.3	AIRSPEDS FOR SAFE OPERATION.....	4-2
4.5	NORMAL PROCEDURES CHECKLIST.....	4-3
4.5a	Preflight Checklists (4.9).....	4-3
4.5b	Before Starting Engine Checklist (4.11)	4-7
4.5c	Engine Start Checklist (4.13)	4-8
	ENGINE START - GENERAL (4.13a).....	4-8
	NORMAL START - COLD ENGINE (4.13b).....	4-8
	NORMAL START - HOT ENGINE (4.13c).....	4-9
	ENGINE START WHEN FLOODED (4.13d).....	4-9
	ENGINE START WITH EXTERNAL POWER SOURCE (4.13e)	4-10
4.5d	Before Taxiing Checklist (4.15)	4-11
4.5e	Taxiing Checklist (4.17)	4-11
4.5f	Ground Check Checklist (4.19).....	4-11
4.5g	Before Takeoff Checklist (4.21)	4-12
4.5h	Takeoff Checklist (4.23).....	4-13
	NORMAL TECHNIQUE (4.23a)	4-13
	0° FLAP TAKEOFF PERFORMANCE (4.23b).....	4-14
	SHORT FIELD TAKEOFF PERFORMANCE (4.23c)	4-14

TABLE OF CONTENTS

SECTION 4 (cont)

NORMAL PROCEDURES

Paragraph No.		Page No.
4.5i	Climb Checklist (4.25)	4-14
	MAXIMUM CONTINUOUS POWER	
	CLIMB (4.25a)	4-15
	CRUISE CLIMB (4.25b)	4-14
4.5j	Cruise Checklist (4.27)	4-15
4.5k	Descent Checklist (4.29)	4-15
	NORMAL DESCENT (4.29)	4-15
	REDUCED POWER DESCENT (4.29)	4-16
4.5m	Approach And Landing Checklist (4.31)	4-16
	NORMAL TECHNIQUE (4.31a)	4-16
	SHORT FIELD TECHNIQUE (4.31b)	4-17
4.5n	Go-around Checklist (4.33)	4-17
4.5o	After Landing Checklist (4.35)	4-17
4.5p	Stopping Engine Checklist (4.37)	4-18
4.5q	Mooring Checklist (4.39)	4-18
4.7	AMPLIFIED PROCEDURES	4-19
4.9	PREFLIGHT CHECK (4.5a)	4-19
4.9a	Cockpit (4.5a)	4-19
4.9b	Empennage (4.5a)	4-20
4.9c	Right Wing (4.5a)	4-20
4.9d	Nose Section (4.5a)	4-21
4.9e	Left Wing (4.5a)	4-21
4.9f	Miscellaneous (4.5a)	4-22

TABLE OF CONTENTS
SECTION 4 (cont)
NORMAL PROCEDURES

Paragraph No.		Page No.
4.11	BEFORE STARTING ENGINE (4.5b).....	4-22
4.13	ENGINE START (4.5c).....	4-23
4.13a	Engine Start - General (4.5c).....	4-23
4.13b	Normal Start - Cold Engine (4.5c)	4-24
4.13c	Normal Start - Hot Engine (4.5c).....	4-24
4.13d	Engine Start When Flooded (4.5c).....	4-24
4.13e	Engine Start With External Power Source (4.5c).....	4-25
4.15	BEFORE TAXIING (4.5d).....	4-26
4.17	TAXIING (4.5e).....	4-26
4.19	GROUND CHECK (4.5f)	4-27
4.21	BEFORE TAKEOFF (4.5g)	4-28
4.23	TAKEOFF (4.5h).....	4-28
4.23a	Normal Technique (4.5h)	4-29
4.23b	0° Flap Takeoff Performance (4.5h).....	4-29
4.23c	Short Field Takeoff Performance (4.5h).....	4-29
4.25	CLIMB (4.5i)	4-30
4.25a	Maximum Continuous Power Climb (4.5i).....	4-30
4.25b	Cruise Climb (4.5i).....	4-30
4.27	CRUISE (4.5j)	4-30
4.29	DESCENT (4.5k)	4-33
4.31	APPROACH AND LANDING (4.5m)	4-33
4.31a	Normal Technique (4.5m)	4-34
4.31b	Short Field Technique (4.5m).....	4-34

TABLE OF CONTENTS

SECTION 4 (cont)

NORMAL PROCEDURES

Paragraph No.		Page No.
4.33	GO-AROUND (4.5n)	4-35
4.35	AFTER LANDING (4.5o)	4-35
4.37	STOPPING ENGINE (4.5p)	4-35
4.39	MOORING (4.5q)	4-36
4.41	STALLS	4-36
4.43	TURBULENT AIR OPERATION	4-36
4.45	CABIN PRESSURIZATION SYSTEM	4-37
4.47	SUPPLEMENTAL ELECTRIC HEATER	4-39
4.49	NOISE LEVEL	4-40
4.50	ICING INFORMATION	4-41

FOR REFERENCE ONLY
NOT FOR FLIGHT

SECTION 4

NORMAL PROCEDURES

4.1 GENERAL

This section provides the normal operating procedures for the PA-46-350P, Malibu airplane. All of the normal operating procedures required by the FAA are presented as well as those procedures which have been determined as necessary for the operation of the airplane, as determined by the operating and designed features of the airplane, are presented.

Normal operating procedures associated with optional systems and equipment which require handbook supplements are presented in Section 9, Supplements.

These procedures are provided to supply information on procedures which are not the same for all airplanes and as a source of reference and review. Pilots should familiarize themselves with these procedures to become proficient in the normal operation of the airplane.

This section also contains Icing Information. A series of guide lines are presented to help recognize, operate in, and exit from an inadvertent encounter with severe icing.

This section is divided into two parts. The first part is a short form checklist supplying an action - reaction sequence for normal procedures with little emphasis on the operation of the systems. Numbers in parentheses after each checklist section indicate the paragraph where the corresponding amplified procedure can be found.

The second part of this section contains the amplified normal procedures which provide detailed information and explanations of the procedures and how to perform them. This portion of the section is not intended for use as an inflight reference due to the lengthy explanation. The short form checklists should be used on the ground and in flight. Numbers in parentheses after each paragraph title indicate where the corresponding checklist can be found.

4.3 AIRSPEEDS FOR SAFE OPERATIONS

The following airspeeds are those which are significant to the safe operation of the airplane. These figures are for standard airplanes flown at gross weight under standard conditions at sea level.

Performance for a specific airplane may vary from published figures depending upon the equipment installed, the condition of the engine, airplane and equipment, atmospheric conditions and piloting technique.

(a)Best Rate of Climb Speed	110 KIAS
(b)Best Angle of Climb Speed.....	81 KIAS
(c)Turbulent Air Operating Speed (See Subsection 2.3)	133 KIAS
(d)Landing Final Approach Speed (Full Flaps).....	77 KIAS
(e)Maximum Demonstrated Crosswind Velocity	17 KTS
(f)Maximum Flaps Extended Speed	
10°.....	165 KIAS
20°.....	130 KIAS
Full Flaps (36°)	116 KIAS

FOR REFERENCE ONLY
NOT FOR FLIGHT

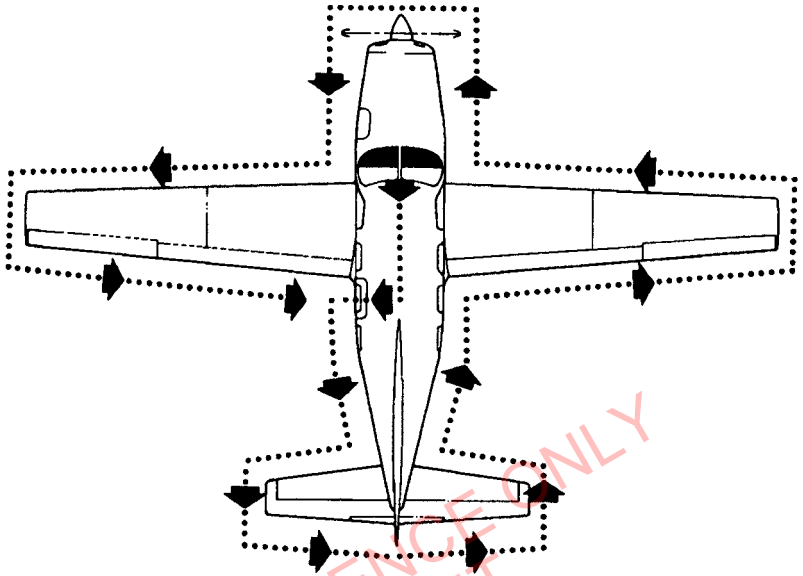

WALK-AROUND

Figure 4-1

4.5 NORMAL PROCEDURES CHECKLIST

4.5a Preflight Checklists (4.9)

COCKPIT (4.9a)

- Control wheel.....release restraints
- Parking BrakeSET
- Gear Handle.....DOWN
- All Switches.....OFF
- Magneto Switches.....OFF
- Radio Master SwitchOFF
- MixtureIDLE CUT-OFF
- Battery Master Switch.....ON

CAUTION

See fuel imbalance limitations, 2.23.

- Fuel Gauges.....check QUANTITY & IMBALANCE

4.5a Preflight Checklist (Continued)

COCKPIT (4.9a) (Continued)

Annunciator PanelCHECK
Switch PanelCHECK
FUEL PRESS AnnunciatorON
Oxygen Light (if installed)CHECK
Stall Warning SystemTEST
FlapsEXTEND
Battery Master SwitchOFF
Primary Flight ControlsPROPER OPERATION
TrimNEUTRAL
Static SystemDRAIN
Alternate Static SystemCHECK NORMAL POSITION
Emergency ExitCHECK
Windowscheck CLEAN
Required Paperscheck ON BOARD
BaggageSTOW PROPERLY - SECURE

EMPENNAGE (4.9b)

AntennasCHECK
Surface ConditionCLEAR OF ICE, FROST, SNOW
Left Static PortCLEAR
Alternate and Pressurization Static PortsCLEAR
ElevatorCHECK
Elevator Trim TabCHECK
RudderCHECK
Static WicksCHECK
Tie DownREMOVE
Right Static PortCLEAR

RIGHT WING (4.9c)

Surface ConditionCLEAR OF ICE, FROST, SNOW
Flap and HingesCHECK
Aileron and HingesCHECK
Static WicksCHECK
Wing Tip and LightsCHECK
Fuel TankCHECK supply
visually - SECURE CAP

4.5a Preflight Checklist (4.9) (Continued)

RIGHT WING (4.9C) (CONTINUED)

- Fuel Tank VentCLEAR
- Tie Down and ChockREMOVE
- Main Gear StrutPROPER
INFLATION (3.44 +/- 0.25 in.)
- TireCHECK
- Brake Block and DiscCHECK

CAUTION

When draining any amount of fuel, care should be taken to ensure that no fire hazard exists before starting engine.

- Fuel Tank SumpDRAIN and CHECK
for water, sediment
and proper fuel

NOSE SECTION (4.9d)

- General ConditionCHECK
- Fuel Filter SumpDRAIN and CHECK
for water, sediment
and proper fuel
- CowlingSECURE
- Windshield.....CLEAN
- Propeller and SpinnerCHECK
- Air InletsCLEAR
- Landing LightCHECK
- ChockREMOVE
- Nose Gear Strut.....PROPER
INFLATION (1.65 ± 0.25 in.)
- Nose Wheel Tire.....CHECK
- Engine Baffle SealCHECK
- Oil...CHECK QUANTITY
- Oil Filler/Dipstick Cap.....PROPERLY SEATED
and SECURE
- Cowl Oil DoorCLOSED
- Tow BarSTOW properly- SECURE
- Baggage Door.....CLOSE and SECURE

4.5a Preflight Checklist (4.9) (Continued)

LEFT WING (4.9)

Surface Condition.....CLEAR of ICE, FROST, SNOW

CAUTION

When draining any amount of fuel, care should be taken to ensure that no fire hazard exists before starting engine.

Fuel Tank SumpDRAIN and CHECK
for water, sediment
Tie Down and Chock.....REMOVE
Main Gear Strut.....INFLATION (3.44 +/- 0.25 INCH
Tire.CHECK
Brake Block and Disc.....CHECK
Pitot Head.....HOLES CLEAR
Fuel TankCHECK supply
visually - SECURE CAP
Fuel Tank Vent.....CLEAR
Wing Tip and Light.....CHECK
Aileron and Hinges.....CHECK
Flap and Hinges.....CHECK
Static Wicks.....CHECK

MISCELLANEOUS (4.9f)

Oxygen System (if installed).....CHECK MASKS and HOSES
Battery Master Switch.....ON
Flaps.....RETRACT
Interior Lighting.....ON and CHECK
Pitot Heat Switch.....ON
Stall Warning Heat Switch.....ON

CAUTION

Care should be taken when an operational check of the heated pitot head and heated lift detector is being performed. The units become very hot. Ground operation should be limited to three minutes to avoid damaging the heating elements

4.5a Preflight Checklist (4.9) (Continued)

MISCELLANEOUS (4.9f) (Continued)

- Exterior Lighting SwitchesON and CHECK
- PitotCHECK - WARM
- Stall Warning HeatCHECK WARM
- All Lighting SwitchesOFF
- Pitot Heat SwitchOFF
- Stall Warning Heat SwitchOFF
- Battery Master SwitchOFF
- PassengersBOARD
- DoorCLOSE and LATCH

WARNING

Do not initiate any flight if all four door pin indicators are not green and/or the DOOR AJAR annunciator is lit.

- Door Pinsall INDICATORS GREEN
- Seatsadjusted and locked in position
- Seat Belts and HarnessFASTEN/ADJUST
 CHECK inertia reel

4.5b Before Starting Engine Checklist (4.11)

BEFORE STARTING ENGINE (4.11)

- Parking BrakeSET
- Propeller ControlFULL INCREASE
- Fuel SelectorDESIRED TANK
- Circuit Breakerscheck IN
- RadiosOFF
- AlternatorsON
- Cabin Altitude SelectorSET
- Altitude Rate ControlSET
- Cabin Pressurization ControlSET
- Cabin Pressure Dump/Normal SwitchNORM
- Induction Air ControlCHECK
 then PRIMARY

4.5c Engine Start Checklist (4.13)

ENGINE START - GENERAL (4.13a)

CAUTION

Do not attempt flight if there is no indication of alternator output.

CAUTION

The STARTER ENGAGE annunciator will illuminate during engine cranking. If the annunciator remains lit after the engine is running, stop the engine and determine the cause.

CAUTION

If a positive oil pressure is not indicated within 30 seconds following an engine start, stop the engine and determine the trouble. In cold weather it will take a few seconds longer to get a positive oil pressure indication.

NOTE

Starter manufacturers recommend that starter cranking periods be limited to 30 seconds with a two minute rest period between cranking periods. Longer cranking periods will shorten the life of the starter.

NORMAL START - COLD ENGINE (4.13b)

Throttle1/2 INCH OPEN
Battery Master SwitchON
Emergency (EMERG) Fuel PumpOFF
MixtureRICH - then IDLE CUT-OFF

4.5c Engine Start Checklist (4.13) (Continued)

NORMAL START - COLD ENGINE (4.13b) (Continued)

NOTE

The amount of prime depends on engine temperature. Familiarity and practice will enable the operator to estimate the amount of prime required.

- Magneto SwitchesON
- Starter.....ENGAGE
- Mixture (when engine fires).....ADVANCE
- Throttle.....ADJUST
- Oil PressureCHECK
- AlternatorsCHECK AMMETER
- Gyro Suction.....CHECK

NORMAL START - HOT ENGINE (4.13c)

- Throttle1/2 INCH OPEN
- Battery Master Switch.....ON
- Emergency (EMERG) Fuel Pump.....OFF
- MixtureIDLE CUT-OFF
- Magneto SwitchesON
- Starter.....ENGAGE
- Mixture (when engine fires).....ADVANCE
- Throttle.....ADJUST
- Oil PressureCHECK
- AlternatorsCHECK AMMETER
- Gyro Suction.....CHECK

ENGINE START WHEN FLOODED (4.13d)

- ThrottleOPEN FULL
- Battery Master Switch.....ON
- Emergency (EMERG) Fuel Pump.....OFF
- MixtureIDLE CUT-OFF
- Magneto SwitchesON
- Starter.....ENGAGE
- Mixture (when engine fires).....ADVANCE
- ThrottleRETARD
- Oil PressureCHECK
- AlternatorsCHECK AMMETER
- Gyro Suction.....CHECK

4.5c Engine Start Checklist (4.13) (Continued)

ENGINE START WITH EXTERNAL POWER SOURCE (4.13e)

Battery Master SwitchOFF
AlternatorsOFF
All Electrical EquipmentOFF
External Power PlugINSERT in receptacle

Proceed with normal start.

NOTE

For all normal operations using an external power source, the battery master switch should be OFF, but it is possible to use the ship's battery in parallel by turning the battery master switch ON. This will give longer cranking capabilities, but will not increase amperage.

CAUTION

Care should be exercised because if the ship's battery has been depleted, the external power supply can be reduced to the level of the ship's battery. This can be tested by turning the battery master switch ON momentarily while the starter is engaged. If cranking speed increases, the ship's battery is at a higher level than the external power supply.

Throttle.....LOWEST POSSIBLE RPM
External Power PlugDISCONNECT from receptacle
Baggage Door.....CLOSED and SECURE
Battery Master Switch.....ON
VoltmeterCHECK
Alternators.....ON
AmmetersCHECK
ThrottleADVANCE to 1000 RPM
Oil PressureCHECK
Gyro Suction.....CHECK

4.5d Before Taxiing Checklist (4.15)

BEFORE TAXIING (4.15)

CAUTION

Do not operate engine above 1200 RPM with cabin doors open.

- Throttle1000 to 1200 RPM
- Radio Master SwitchON
- Environmental SystemAS DESIRED
- Supplemental Electric HeaterAS DESIRED

4.5e Taxiing Checklist (4.17)

TAXIING (4.17)

- Taxi Area.....CLEAR
- ChocksREMOVED
- Parking BrakeRELEASED
- Propeller ControlFULL INCREASE
- ThrottleAPPLY SLOWLY
- BrakesCHECK
- Steering.....CHECK
- Flight Instruments.....CHECK

NOTE: During taxi, if low voltage annunciator comes on, increase engine RPM if possible to retain adequate battery charging.

4.5f Ground Check Checklist (4.19)

GROUND CHECK (4.19)

CAUTION

Alternate air is unfiltered. Use of alternate air during ground or flight operations, when dust or other contaminants are present, may result in engine damage from particle ingestion.

- Parking BrakeSET
- Propeller ControlFULL INCREASE
- Throttle2000 RPM
- Magnetosmax. drop 175 RPM
- max. diff. 50 RPM
- Gyro SuctionCHECK (within normal operating range)

4.5f Ground Check Checklist (4.19) (Continued)

GROUND CHECK (4.19) (Continued)

NOTE

Refer to paragraph 4.50, Icing Information, prior to any flight operations. (Takeoff, cruise, landing, etc.) If flight into icing conditions (in visible moisture below +5°C) is anticipated, conduct a preflight check of the ice protection systems per Supplement No. 3 - Ice Protection System.

Ice protection equipment.....	CHECK AS REQUIRED
Voltmeter	CHECK
Ammeters	CHECK
Oil Temperature	CHECK
Oil Pressure	CHECK
Propeller Control	EXERCISE - then FULL INCREASE
Fuel Flow	CHECK
Throttle	RETARD
Annunciator Panel	PRESS-TO-TEST
Switch Panel	PRESS-TO-TEST

4.5g Before Takeoff Checklist (4.21)

BEFORE TAKEOFF (4.21)

Battery Master Switch	ON
Emergency (EMERG) Fuel Pump	ON
Alternators	ON - CHECK AMMETERS
Flight Instruments	CHECK
Engine Gauges	CHECK
Pressurization Controls	SET
Fuel Selector	PROPER TANK
Induction Air	PRIMARY

WARNING

Refer to paragraph 4.50, Icing Information, prior to any flight operations. (Takeoff, cruise, landing, etc.) If flight into icing conditions (in visible moisture below +5°C) is anticipated or encountered during climb, cruise or descent, activate the aircraft ice protection system, including the pitot heat, as described in supplement no. 3 - Ice Protection System.

4.5g Before Takeoff Checklist (4.21) (Continued)

BEFORE TAKEOFF (4.21) (Continued)

Seat Backs	ERECT
Seats	ADJUSTED & LOCKED IN POSITION
Armrests	STOWED
Mixture	FULL RICH
Propeller Control	FULL INCREASE
Belts/Harness	FASTENED/ADJUSTED
Empty Seats	SEAT BELTS SNUGLY FASTENED
Flaps	SET
Trim	SET
Controls	FREE
Door	LATCHED
Air Conditioner	OFF
Parking Brake	RELEASED

4.5h Takeoff Checklist (4.23)

NORMAL TECHNIQUE (4.23a)

NOTE

Takeoffs are normally made with full throttle. However, under some off standard conditions, the manifold pressure indication can exceed its indicated limit at full throttle. Limit manifold pressure to 42 in. Hg maximum. (See Section 7.)

NOTE

During landing gear operation, it is normal for the HYDRAULIC PUMP annunciator light to illuminate until full system pressure is restored.

NORMAL TECHNIQUE (4.23a)

Flaps	0° to 10°
Trim	SET
Power	SET TO MAXIMUM
Liftoff	80-85 KIAS
Climb Speed	90-95 KIAS
Landing Gear (when straight ahead landing on runway not possible)	UP
Flaps	RETRACT

4.5h Takeoff Checklist (4.23) (Continued)

0° FLAP TAKEOFF PERFORMANCE (4.23b)

Flaps0°
Trim.....SET
BrakesAPPLY
Power.....SET TO MAXIMUM
BrakesRELEASE
Liftoff.....78 KIAS
Obstacle Clearance Speed.....91 KIAS
Landing GearUP

SHORT FIELD TAKEOFF PERFORMANCE (4.23c)

NOTE

Gear warning will sound when the landing gear is retracted with the flaps extended more than 10°.

Flaps20°
Trim.....SET
BrakesAPPLY
Power.....SET TO MAXIMUM
BrakesRELEASE
Liftoff.....69 KIAS
Obstacle Clearance Speed.....80 KIAS
Landing GearUP
Flaps.....RETRACT as
speed builds thru 90 KIAS

4.5i Climb Checklist

MAXIMUM CONTINUOUS POWER CLIMB (4.25a)

MixtureFULL RICH
Propeller Speed.....2500 RPM
Manifold Pressure.....MAXIMUM
CONTINUOUS POWER
Climb Speed
Best Angle (short duration only)81 KIAS
Best Rate110 KIAS
Pressurization ControlsSET
Emergency (EMERG) Fuel PumpOFF at
safe altitude

4.5i Climb Checklist (Continued)

CRUISE CLIMB (4.25b)

Manifold Pressure	35 IN. HG
Propeller Speed	2500 RPM
Mixture	32 GPH
Climb Speed	125 KIAS
Pressurization Controls	SET
Emergency (EMERG) Fuel Pump	OFF at safe altitude

4.5j Cruise Checklist (4.27)

CRUISE (4.27)

WARNING

Operation above 25,000 ft is not approved.

CAUTION

To maintain lateral balance, alternate between right and left fuel tanks. See paragraphs 2.23 and 7.17.

Reference Section 5 power setting table and performance charts.

Cruise Power	SET per power table
Mixture (Refer to para. 4.27)	ADJUST
Pressurization Controls	CHECK'

4.5k Descent Checklist (4.29)

NORMAL DESCENT (4.29)

Power	CRUISE
Mixture	CRUISE SETTING
Airspeed	AS REQUIRED
Pressurization Controls	SET
Altimeter	SET
Windshield Defrost	AS REQUIRED

4.5k Descent Checklist (4.29) (Continued)

REDUCED POWER DESCENT (4.29)

Throttle.....AT or ABOVE 20 in. Hg.
Mixture.....MAINTAIN 1350 TIT
Propeller SpeedCRUISE SETTING
Pressurization Controls.....SET
AltimeterSET
Windshield Defrost.....AS REQUIRED

4.5m Approach And Landing Checklist (4.31)

APPROACH AND LANDING (4.31)

Seat BacksERECT
SeatsADJUSTED & LOCKED IN POSITION
ArmrestsSTOWED
Belts/HarnessFASTEN/ADJUST
Emergency (EMERG) Fuel Pump.....ON
Cabin Pressure.....DEPRESSURIZED
Fuel Selector.....PROPER TANK
MixtureRICH
Propeller Control.....SET
Gear.....DOWN - 165 KIAS max.

NOTE

During landing gear operation it is normal for the HYDRAULIC PUMP annunciator light to illuminate until full system pressure is restored.

Flaps.....SET
Trim (RUDDER).....SET TO NEUTRAL
Air Conditioner.....OFF
Toe Brakes.....DEPRESS to check

WARNING

After pumping several times, if one or both toe brakes are inoperative, DO NOT attempt landing on a short field.

NORMAL TECHNIQUE (4.31a)

FlapsUP to FULL DOWN
Airspeed80 - 85 KIAS (flaps down)
95 KIAS (flaps up)
ThrottleAS REQUIRED
After touchdown:
BrakesAS REQUIRED

4.5m Approach And Landing Checklist (4.31) (Continued)**SHORT FIELD TECHNIQUE (4.31b)**

Flaps.....FULL DOWN
 Airspeed.....78 KIAS
 ThrottleAS REQUIRED
 Over obstacle:
 ThrottleREDUCE TO IDLE
 After touchdown:
 Brakes.....MAXIMUM

4.5n Go-around Checklist (4.33)**GO-AROUND (4.33)**

MixtureFULL RICH
 Propeller ControlFULL INCREASE
 ThrottleFULL POWER
 Control Wheelback pressure to
 ROTATE to CLIMB ATTITUDE
 Airspeed80 KIAS
 GearUP
 FlapsRETRACT SLOWLY
 TrimAS REQUIRED

4.5o After Landing Checklist (4.35)**AFTER LANDING (4.35)**

Induction Air ControlPRIMARY
 FlapsRETRACT
 Air ConditionerAS DESIRED
 RadarOFF
 Emergency (EMERG) Fuel PumpOFF
 Strobe LightsOFF
 Landing Taxi LightsAS REQUIRED

4.5p Stopping Engine Checklist (4.37)

STOPPING ENGINE (4.37)

Radios and Electrical EquipmentOFF
External LightsOFF
Air ConditionerOFF
Propeller ControlFULL INCREASE
ThrottleCLOSED until a
decided decrease in CHT
Throttle.....1000 RPM for
approx. 30 seconds
MixtureIDLE CUT-OFF
MagnetosOFF
AlternatorsOFF
Battery Master SwitchOFF

4.5q Mooring Checklist (4.39)

MOORING (4.39)

Parking BrakeSET
Control Wheel.....SECURED with belts
Flaps.....FULL UP
Wheel ChocksIN PLACE
Tie Downs.....SECURE

FOR REFERENCE ONLY
NOT FOR FLIGHT

4.7 AMPLIFIED NORMAL PROCEDURES (GENERAL)

The following paragraphs are provided to supply detailed information and the explanation of the normal procedures for operation of the airplane.

4.9 PREFLIGHT CHECK (4.5a)

The airplane should be given a thorough preflight and walk-around check. The preflight should include a check of the airplane's operational status, computation of weight and C.G. limits, takeoff distance, and in-flight performance. A weather briefing should be obtained for the intended flight path, and any other factors relating to a safe flight should be checked before takeoff.

4.9a Cockpit (4.5a)

Upon entering the cockpit, release the seat belts securing the control wheel.

Set the parking brake by first depressing and holding the toe brake pedals and then pull the parking brake knob.

Check that the landing gear selector is in the DOWN position. Ensure that all electrical switches and the magneto switches are OFF. Turn OFF the radio master switch. The mixture should be in idle cut-off. Turn the battery master switch ON.

CAUTION

See fuel imbalance limitations, 2.23.

Check the fuel quantity gauges for adequate supply and fuel imbalance (sec. 2.23). Check that the annunciator panel illuminates and that the FUEL PRESS annunciator is ON. If the supplemental oxygen system is installed and its annunciator is lit, the expended canisters must be replaced if oxygen capability is desired for the flight. Press the stall warning test switch and note that the stall warning horn sounds. Extend the flaps for the walk-around inspection. Turn OFF the battery master switch. Check the primary flight controls for proper operation and set the elevator and rudder trim to neutral. Open the static system drain to remove any moisture that has accumulated in the lines. Verify that the alternate static system valve is in the normal position. Check that the emergency exit is in place and securely latched. Check the windows for cleanliness and that the required papers are on board. Properly stow any baggage and secure.

4.9 PREFLIGHT CHECK (4.5a) (Continued)

4.9b Empennage (4.5a)

Begin the walk-around at the left side of the aft fuselage. Check the condition of any antennas located on the fuselage. All surfaces of the empennage must be clear of ice, frost, snow or other extraneous substances. Fairings and access covers should be attached properly. Ensure that the primary static system ports on the left and right side of the aft fuselage and the alternate and pressurization static ports on the underside of the aft fuselage are clear of obstructions. The elevator and rudder should be operational and free from damage or interference of any type. Elevator and rudder static wicks should be firmly attached and in good condition. Check the condition of the tab and ensure that all hinges and push rods are sound and operational. If the tail has been tied down, remove the tiedown rope.

4.9c Right Wing (4.5a)

Check that the wing surface and control surfaces are clear of ice, frost, snow or other extraneous substances. Check the flap, aileron and hinges for damage and operational interference. Static wicks should be firmly attached and in good condition. Check the wing tip and lights for damage.

Open the fuel cap and visually check the fuel color. The quantity should match the indication that was on the fuel quantity gauge. Replace cap securely. The fuel tank vent should be clear of obstructions.

Remove the tiedown and chock.

Next, complete a check of the landing gear. Check the gear strut for proper inflation. There should be 3.44 +/- 0.25 inches of strut exposure under a normal static load. Check for hydraulic leaks. Check the tire for cuts, wear, and proper inflation. Make a visual check of the brake block and disc.

Drain the fuel tank sump through the quick drain located on the lower surface of the wing just inboard of the gear well, making sure that enough fuel has been drained to ensure that all water and sediment is removed. The fuel system should be drained daily prior to the first flight and after each refueling.

CAUTION

When draining any amount of fuel, care should be taken to ensure that no fire hazard exists before starting engine.

4.9 PREFLIGHT CHECK (4.5a) (Continued)**4.9d Nose Section (4.5a)**

Check the general condition of the nose section; look for oil or fluid leakage and that the cowling is secure. Drain the fuel filter sump located on the lower fuselage aft of the cowling. Check the windshield and clean if necessary. The propeller and spinner should be checked for detrimental nicks, cracks, or other defects. The air inlets should be clear of obstructions. The landing light should be clean and intact.

Remove the chock and check the nose gear strut for proper inflation. There should be 1.65 +/- 0.25 inches of strut exposure under a normal static load. Check the tire for cuts, wear, and proper inflation. Check the engine baffle seals. Check the oil level; maximum endurance flights should begin with 12 quarts of oil. Make sure that the oil filler/dipstick cap has been properly seated and secured, and that the cowl oil door is closed. Ensure that the tow bar is secured in the nose baggage area.

Close and secure the nose baggage door.

4.9e Left Wing (4.5a)

The wing surface should be clear of ice, frost, snow, or other extraneous substances. Drain the left fuel tank sump in the same manner as the right wing. Remove the tiedown and chock. Check the main gear strut for proper inflation: there should be 3.44 +/- 0.25 inches of strut exposure under a normal static load. Check for hydraulic leaks. Check the tire and the brake block and disc.

If installed, remove the cover from the pitot head on the underside of the wing. Make sure the holes are open and clear of obstructions.

Open the fuel cap and visually check the fuel color. The quantity should match the indication that was on the fuel quantity gauge. Replace cap securely. The fuel tank vent should be clear of obstructions.

Check the wing tip and lights for damage. Check the aileron, flap, and hinges for damage and operational interference and that the static wicks are firmly attached and in good condition.

4.9 PREFLIGHT CHECK (4.5a) (Continued)

4.9f Miscellaneous (4.5a)

Enter the cockpit and, if installed, check oxygen masks and hoses.

Turn the battery master switch ON and retract the flaps. Check the interior lights by turning ON the necessary switches. After the interior lights are checked, turn ON the pitot heat, stall warning heat, and the exterior light switches. Next, perform a walk-around check on the exterior lights and check the heated pitot head and stall warning vane for proper heating.

CAUTION

Care should be taken when an operational check of the heated pitot head and heated lift detector is being performed. The units become very hot. Ground operation should be limited to three minutes maximum to avoid damaging the heating elements.

Reenter the cockpit and turn all switches OFF. When all passengers are on board, the pilot should check that the cabin door is properly closed and latched, and visually check that all four door pin indicators are green.

WARNING

Do not initiate any flight if all four door pin indicators are not green and/or the DOOR AJAR annunciator is lit.

Seats should be adjusted and locked in position. Seat belts on empty seats should be snugly fastened. All passengers should fasten their seat belts and shoulder harnesses. A pull test of the inertia reel locking restraint feature should be performed.

4.11 BEFORE STARTING ENGINE (4.5b)

Before starting the engine, the parking brake should be set and the propeller control moved to the full INCREASE position. The fuel selector should then be moved to the desired tank. Check to make sure all the circuit breakers are in and the radios are OFF. Turn the alternator switches ON.

4.11 BEFORE STARTING ENGINE (4.5b) (Continued)

If the flight is to be made unpressurized, the cabin pressurization control should be pulled out to dump bleed air overboard and the cabin pressure dump/normal switch should be in the DUMP position in order to provide maximum cabin airflow. If pressurization is to be used during the flight, set the cabin altitude selector to 500 feet above the field elevation and the cabin altitude rate control to the 9 o'clock position. The cabin pressurization control must be pushed in and the cabin pressure dump/normal switch must be in the NORM position.

Check induction air control for freedom of movement by moving lever to ALTERNATE and back to PRIMARY.

4.13 ENGINE START (4.5c)**4.13a Engine Start - General (4.5c)***CAUTION*

Do not attempt flight if there is no indication of alternator output.

CAUTION

The STARTER ENGAGED annunciator will illuminate during engine cranking. If the annunciator remains lit after the engine is running, stop the engine and determine the cause.

CAUTION

If a positive oil pressure is not indicated within 30 seconds following an engine start, stop the engine and determine the trouble. In cold weather it will take a few seconds longer to get a positive oil pressure indication.

NOTE

Starter manufacturers recommend that starter cranking periods be limited to 30 seconds with a two minute rest period between cranking periods. Longer cranking periods will shorten the life of the starter.

4.13 ENGINE START (4.5c) (Continued)

4.13b Normal Start - Cold Engine (4.5c)

Open the throttle lever approximately 1/2 inch. Turn the battery master switch ON, and check that the emergency (EMERG) fuel pump is OFF. Move the mixture control to full RICH for approximately four seconds then to idle cut-off. The engine is now primed.

NOTE

The amount of prime depends on engine temperature. Familiarity and practice will enable the operator to estimate the amount of prime required.

Turn both magneto switches ON and engage the starter. When the engine fires advance the mixture control to full RICH. Move the throttle to the desired setting and check the oil pressure for a positive indication. Confirm that the alternators are on by checking the ammeters for output. Check the gyro suction gauge for a positive indication.

4.13c Normal Start - Hot Engine (4.5c)

Open the throttle 1/2 inch. Turn the battery master switch ON and check that the emergency (EMERG) fuel pump is OFF. Verify the mixture control is at idle cut-off. Turn both magneto switches ON and engage the starter. When the engine fires, slowly advance the mixture control. Move the throttle to the desired setting and check for a positive indication of oil pressure. Confirm that the alternators are on by checking the ammeters for output. Check the gyro suction gauge for a positive indication.

4.13d Engine Start When Flooded (4.5c)

The throttle lever should be full open. Turn the battery master switch ON and check that the emergency (EMERG) fuel pump is OFF. Verify the mixture control is at idle cut-off. Turn both magneto switches ON and engage the starter. When the engine fires, advance the mixture control, retard the throttle, and check for a positive indication of oil pressure. Confirm that the alternators are on by checking the ammeters for output. Check the gyro suction gauge for a positive indication.

4.13 ENGINE START (4.5c) (Continued)

4.13e Engine Start With External Power Source (4.5c)

An optional feature allows the operator to use an external power source to crank the engine without having to gain access to the airplane's battery.

Turn the battery master and alternator switches OFF and turn all electrical equipment OFF. If using an auxiliary power unit, plug the unit into the socket located inside the forward baggage door. If using an external battery, connect the RED lead of the jumper cable to the POSITIVE (+) terminal of an external 24-volt battery and the BLACK lead to the NEGATIVE (-) terminal. Insert the plug of the jumper cable into the socket located inside the forward baggage door. Note that, after the plug is inserted, the airplane's electrical system is ON. Proceed with the normal starting technique.

NOTE

For all normal operations using an external power source, the battery master switch should be OFF, but it is possible to use the ship's battery in parallel by turning the battery master switch ON. This will give longer cranking capabilities, but will not increase the amperage.

CAUTION

Care should be exercised because if the ship's battery has been depleted, the external power supply can be reduced to the level of the ship's battery. This can be tested by turning the battery switch ON momentarily while the starter is engaged. If cranking speed increases, the ship's battery is at a higher level than the external power supply.

After the engine has started, retard the throttle to the lowest possible rpm to reduce sparking. Disconnect the external power source from the aircraft and secure the baggage door. Turn the battery master and alternator switches ON and check the voltmeter and ammeters for an indication of output.

When the engine is firing evenly, advance the throttle to 1000 rpm and check for a positive indication of oil pressure. Check gyro suction gauge for a positive indication.

4.15 BEFORE TAXIING (4.5d)

CAUTION

Do not operate engine above 1200 rpm with cabin doors open.

Warm up the engine at 1000 to 1200 rpm. Avoid prolonged idling at low rpm, as this practice may result in fouled spark plugs. Turn the radio master switch ON, and set environmental system as desired. Set the supplemental heater as desired (refer to paragraph 4.47).

Takeoff may be made as soon as the ground check is completed and the engine is warm.

Care should be taken not to run up the engine over a surface containing loose stones, gravel, or any loose material that may cause damage to the propeller blades.

4.17 TAXIING (4.5e)

Non-pilot personnel should not attempt to taxi the airplane until they have been instructed in taxiing procedures and technique by a qualified person authorized by the owner.

Determine that the propeller back blast and taxi areas are clear.

Release the parking brake by first depressing and holding the toe brake pedals and then push in on the parking brake knob. Taxi with the propeller control set to full INCREASE. Power should be applied slowly to start the taxi roll. Taxi a few feet forward and apply the brakes to determine their effectiveness. While taxiing, make slight turns to ascertain the effectiveness of the steering and to check the flight instruments.

Observe wing clearances when taxiing near buildings or other stationary objects. If possible, station an observer outside the airplane.

Avoid holes and ruts when taxiing over uneven ground.

Do not operate the engine at high rpm when taxiing over ground containing loose stones, gravel, or any loose material that may cause damage to the propeller blades.

4.19 GROUND CHECK (4.5f)*CAUTION*

Alternate air is unfiltered. Use of alternate air during ground or flight operations when dust or other contaminants are present may result in damage from particle ingestion.

NOTE

If flight into icing conditions (in visible moisture below +5°C) is anticipated, conduct a preflight check of the icing systems per Supplement No. 3- Ice Protection System.

WARNING:

Refer to paragraph 4.50, Icing Information, prior to any flight operations. (Takeoff, cruise, landing, etc.)

Set the parking brake. The magnetos should be checked at 2000 rpm with the propeller control set at full INCREASE. Drop off on either magneto should not exceed 175 rpm and the difference between the magnetos should not exceed 50 rpm. Operation on one magneto should not exceed 10 seconds. Conduct a preflight check of the ice protection systems for proper operation.

Check the suction gauge; the indicator should read within the normal operating range at 2000 rpm.

Check the voltmeter and ammeters for proper voltage and alternator outputs. Check oil temperature and oil pressure. The temperature may be low for some time if the engine is being run for the first time of the day.

The propeller control should be moved through its complete range to check for proper operation and then placed in full INCREASE rpm for takeoff. Do not allow a drop of more than 500 rpm during this check. In cold weather, the propeller control should be cycled from high to low rpm at least three times before takeoff to make sure that warm engine oil has circulated.

Check that the fuel flow gauge is functioning, then retard the throttle. Check the annunciator panel lights with the press-to-test button.

4.21 BEFORE TAKEOFF (4.5g)

Ensure that the battery master, emergency fuel pump, and alternator switches are all ON. Check all of the flight instruments and set as required. Check all engine gauges to verify the engine indications are with the normal operating range. Check that the cabin pressurization controls are properly set. Check the fuel selector to make sure it is set to the proper tank. Verify that the induction air control is in the PRIMARY position.

NOTE

If flight into icing conditions (in visible moisture below +5°C) is anticipated or encountered during climb, cruise or descent, activate the aircraft ice protection system, including the pitot heat, as described in supplement no. 3 - ice protection system.

Turn pitot, stall warning, windshield, and propeller heat ON if necessary.

Seats should be adjusted and locked in position. All seat backs should be erect and armrests stowed.

The mixture control should be set to full RICH and propeller control should be set to full INCREASE. Seat belts and shoulder harnesses should be fastened. Fasten the seat belts snugly around the empty seats.

Set the flaps and trim. Ensure proper flight control movement and response. The door should be properly latched and the door ajar annunciator light out. The air conditioner must be OFF to ensure normal takeoff performance. Release the parking brake.

4.23 TAKEOFF (see charts in Section 5) (4.5h)

NOTE

Takeoffs are normally made with full throttle. However, under some off standard conditions, the manifold pressure indication can exceed its indicated limit at full throttle. Limit manifold pressure to 42 in. Hg maximum. (See Section 7.)

NOTE

During landing gear operation, it is normal for the HYDRAULIC PUMP annunciator light to illuminate until full system pressure is restored.

Takeoffs are normally made with flaps 0° to 10°. For short field takeoffs or takeoffs affected by soft runway conditions or obstacles, total distance can be reduced appreciably by lowering the flaps to 20°.

4.23 TAKEOFF (4.5h) (Continued)**4.23a Normal Technique (4.5h)**

When the available runway length is well in excess of that required and obstacle clearance is no factor, the normal takeoff technique may be used. The flaps should be in the 0° to 10° position and the pitch trim set slightly aft of neutral. Align the airplane with the runway, apply full power, and accelerate to 80-85 KIAS.

Apply back pressure to the control wheel to lift off at 80-85 KIAS, then control pitch attitude as required to attain the desired climb speed of 90-95 KIAS. Retract the landing gear when a straight-ahead landing on the runway is no longer possible. Retract the flaps.

4.23b 0° Flaps Takeoff Performance (4.5h)

Retract the flaps in accordance with the Takeoff Ground Roll, 0° Flaps and Takeoff Distance Over 50 Ft. Obstacle, 0° Flaps charts in Section 5. Set maximum power before brake release and accelerate the airplane to 78 KIAS for liftoff. After liftoff, adjust the airplane attitude as required to achieve the obstacle clearance speed of 91 KIAS passing through 50 feet of altitude. Once immediate obstacles are cleared, retract the landing gear and establish the desired enroute climb configuration and speed.

4.23c Short Field Takeoff Performance (4.5h)

NOTE

Gear warning will sound when the landing gear is retracted with the flaps extended more than 10°.

For departure from short runways or runways with adjacent obstructions, a short field takeoff technique with flaps set at 20° should be used in accordance with the Takeoff Ground Roll, 20° Flaps and Takeoff Distance Over 50 Ft. Obstacle, 20° Flaps charts. Maximum power is established before brake release and the airplane is accelerated to 69 KIAS for liftoff. After liftoff, control the airplane attitude to accelerate to 80 KIAS passing through the 50-foot obstacle height. Once clear of the obstacle, retract the landing gear and accelerate through 90 KIAS while retracting the flaps. Then establish the desired enroute climb configuration and speed.

4.25 CLIMB (4.5i)

4.25a Maximum Continuous Power Climb (4.5i)

The best rate of climb at gross weight and maximum continuous power will be obtained at 110 KIAS. The best angle of climb may be obtained at 81 KIAS. The recommended procedure for climb is to use maximum continuous power with the mixture full RICH. Under some off standard conditions, the manifold pressure indication will exceed its indicated limits at full throttle. Adjust power to remain within limits. Set the cabin pressurization controls in accordance with paragraph 4.45. The emergency (EMERG) fuel pump should be OFF when reaching a safe altitude.

4.25b Cruise Climb (4.5i)

For reduced enroute fuel consumption in climb at a higher enroute climb speed of 125 KIAS, reduce the manifold pressure to 35 in. Hg, use 2500 rpm, and lean the mixture to produce a fuel flow of 32 gph. Set the cabin pressurization controls in accordance with paragraph 4.45. The emergency (EMERG) fuel pump should be OFF when reaching a safe altitude.

4.27 CRUISE (4.5j)

WARNING

Operation above 25,000 feet is not approved.

CAUTION

To maintain lateral balance, alternate between right and left fuel tanks. See paragraphs 2.23 and 7.17.

CAUTION

For proper mid range accuracy, fuel quantity readings should be taken when the aircraft is in coordinated level flight at zero degrees bank angle. (Pitch, roll and yaw.) Failure to observe fuel quantity in this manner will result in erroneous readings due to wing cross section, low dihedral angle and fuel tank geometry.

If readings are taken in configurations other than coordinated level flight at zero degrees bank angle, there may be periods during flight when the accuracy of the fuel quantity gauging system will appear to be incorrect by seeming to present an unchanging quantity in spite of fuel being consumed from the tank.

4.27 CRUISE (4.5J) (CONTINUED)

The cruising speed is determined by many factors, including power setting, altitude, temperature, loading, and equipment installed on the airplane. When leveling off at cruise altitude, the pilot may reduce to a cruise power setting in accordance with the *Power Setting Table in Section 5 of this manual. The higher RPM setting for the desired power should be used when operating above 20,000 feet. Proper leaning during cruise is essential for smooth engine operation and optimum fuel economy. This is especially important during power reductions, such as level off, to prevent rough engine operation. For cruise, mixture should be leaned to peak TIT. Always use the TIT gauge for leaning.

NOTE

Do not exceed 1750°F TIT

The maximum permissible cylinder head temperature for all operations is 500°F. To obtain maximum service life of engine components, cylinder head temperature should not exceed 435°F during cruise operation. Adjust cylinder head temperatures by reducing power, adjusting the mixture, or any combination of these methods.

Following level-off for cruise, the airplane should be trimmed and the pressurization system checked.

During flight, keep account of time and fuel used in connection with power settings to determine how the fuel flow and fuel quantity gauging systems are operating.

The emergency (EMERG) fuel pump should always be turned ON before switching tanks, and should be left on for a short period thereafter. To preclude making a hasty selection, and to provide continuity of flow, the selector should be changed to another tank before fuel is exhausted from the tank in use.

NOTE

The BOOST PUMP annunciator will momentarily illuminate when switching fuel tanks.

*To obtain the performance presented in the Performance Section of this handbook, all conditions listed on the performance charts must be met.

4.27 CRUISE (4.5j) (Continued)

During cruise, use the following procedure to maintain lateral balance, and stay within the fuel imbalance limitations of 2.23:

- (a) When starting with a symmetrical fuel load, use the left tank first until 10 gallons are burned, then alternate tanks at approximately one hour intervals.
- (b) When starting with an unsymmetrical fuel load, care must be taken not to allow the fuel imbalance to exceed 10 gallons.

The emergency (EMERG) fuel pump should normally be OFF so that any malfunction of the engine driven fuel pump is immediately apparent. Loss of fuel pressure to the fuel injector is indicated by the illumination of the FUEL PRESS annunciator. If signs of fuel starvation should occur at any time during flight, fuel exhaustion should be suspected, at which time the fuel selector should be immediately positioned to the fullest tank and the emergency (EMERG) fuel pump switched to the ON position. If excessive fuel vapor is suspected, usually indicated by fluctuating fuel flow, turn the emergency (EMERG) fuel pump ON until the fuel flow indications are smooth.

The pilot should monitor weather conditions while flying, and be alert for meteorological conditions which might lead to icing. **Even aircraft equipped with a complete deicing option are not approved for flight in heavy icing, heavy snow, or freezing rain. (See Section 9.)** Immediate steps shall be taken to exit any area where such icing conditions are inadvertently encountered. Saturated air accelerating through the induction system filter can form ice although ambient temperatures are above freezing. If induction system icing is suspected, place the induction air control in the ALTERNATE position. Alternate air should also be selected before entering clouds. Manifold pressure may decrease significantly when alternate air is selected depending on altitude, power setting, and other factors. This loss of manifold pressure can exceed 8 inches of Hg. when selecting alternate air at cruise power settings during icing conditions. If ice is forming on the filter manifold pressure could continue to deteriorate after selecting alternate air. When manifold pressure stabilizes attempt to regain cruise power with throttle and or RPM adjustments. The primary filter may retain ice after leaving icing conditions, making the selection of PRIMARY induction air impractical until ice melts or sublimates.

There are no mechanical uplocks in the landing gear system. In the event of a hydraulic system malfunction, check valves should prevent the gear from extending. However, some hydraulic system malfunctions may cause the gear to free-fall to the gear down position. The true airspeed with gear down is approximately 70% of the gear retracted airspeed for any given power setting. Allowances for the reduction in airspeed and range should be made when planning extended flight between remote airfields or flight over water.

4.29 DESCENT (4.5k)

The recommended procedure for descent is to leave the engine controls at the cruise settings and increase the airspeed to give the desired rate of descent. Monitor the manifold pressure and adjust to maintain the cruise setting. Leave the mixture leaned to the cruise setting. This will prevent rapid engine cooling which may damage the engine. Should additional rate of descent be required, power can be reduced to 20 in. Hg. while maintaining cabin pressurization. At reduced power maintain at least 1350F TIT in order to keep engine temperatures from cooling too rapidly. If descending with the gear retracted does not provide the desired rate of descent the gear may be extended at speeds up to 165 KIAS and the aircraft operated at speeds up to 195 KIAS with the gear extended. This procedure will significantly increase rate of descent.

Shortly after letdown is initiated, set the Cabin Altitude Controller to 500 feet above the pressure altitude of the landing field. Adjust the rate control high enough to allow the cabin to descend to the landing setting before the aircraft descends to that altitude. For normal let down the rate knob should be at the nine o'clock position. A higher setting should be selected for rapid descents so that the aircraft altitude does not catch up with cabin altitude.

Set the altimeter. Adjust the windshield defrost as required during descent.

4.31 APPROACH AND LANDING (See charts in Section 5) (4.5m)

Accomplish the Landing Checklist early in the landing approach.

Seat backs must be fully erect and the seats adjusted and locked in position. Armrests must be stowed and seat belts and shoulder harnesses fastened and properly adjusted. The emergency (EMERG) fuel pump should be ON. Verify that the cabin is depressurized. The fuel selector should be on the fullest tank. The mixture should be RICH and propeller control should be set. The landing gear may be lowered at speeds up to 165 KIAS and the flaps at speeds as follows:

- 10° 165 KIAS maximum
- 20° 130 KIAS maximum
- 36° 116 KIAS maximum

Set the rudder trim to neutral in preparation for landing.

4.31 APPROACH AND LANDING (4.5m) (Continued)

NOTE

During landing gear operation, it is normal for the HYDRAULIC PUMP annunciator light to illuminate until full system pressure is restored.

The air conditioner should be OFF to ensure maximum rate of climb in the event of a go-around. Pump toe brakes to ensure that the system is capable of uniform braking during landing rollout.

WARNING

After pumping several times, if one or both toe brakes are inoperative, DO NOT attempt landing on a short field.

Depending on the field length and other factors the following procedures are appropriate:

4.31a Normal Technique (4.5m)

Landings may be made with any flap setting. Normally, full flaps are used. The aircraft should be flown down the final approach course at 80 - 85 KIAS with full flaps extended (95 KIAS with flaps retracted), and power as required to maintain the desired approach angle. When descending through 50 feet agl, reduce power to idle. Make normal landing, and brake as required during ground roll.

4.31b Short Field Technique (4.5m)

For landings on short runways, or runways with adjacent obstructions, a short field landing technique with full flaps should be used in accordance with the Landing Ground Roll Distance or the Landing Distance Over 50 FT Obstacle charts in Section 5. The airplane should be flown down the final approach at 78 KIAS with flaps fully extended with power set to produce a normal 3° descent (approximately 400 ft/min) angle. As the obstacle is cleared, reduce the power to idle and adjust airplane attitude to maintain 78 KIAS to the flare point. After touchdown, apply maximum braking.

4.33 GO-AROUND (4.5n)

To initiate a go-around from a landing approach, the mixture should be set to full RICH, the propeller control should be at full INCREASE, and the throttle should be advanced to full power while the pitch attitude is increased to obtain the balked landing climb speed of 80 KIAS. Retract the landing gear and slowly retract the flaps when a positive climb is established. Allow the airplane to accelerate to the best angle of climb speed (81 KIAS) for obstacle clearance or to the best rate of climb speed (110 KIAS) if obstacles are not a factor. Reset the longitudinal trim as required.

4.35 AFTER LANDING (4.5o)

When clear of the active runway, move the induction air control to PRIMARY, retract the flaps, and turn the air conditioner on as desired. Turn OFF the radar, emergency (EMERG) fuel pump, and strobe lights. Turn OFF the landing and taxi lights as required.

4.37 STOPPING ENGINE (4.5p)

Prior to shutdown, all radio and electrical equipment and external lights should be turned OFF.

The air conditioner should be turned OFF, the propeller control set in the full INCREASE position, and the throttle should be CLOSED until there is a decided decrease in CHT. Increase throttle to 1000 rpm. Maintain speed for approximately 30 seconds to ensure adequate scavenging of turbocharger oil system. Stop the engine by pulling the mixture control back to idle cut-off. After the engine stops, both magneto switches, alternator switches, and battery master switches must be turned OFF.

4.39 MOORING (4.5q)

If necessary, the airplane should be moved on the ground with the aid of the nose wheel tow bar.

The parking brake should be set and the aileron and elevator controls should be secured by looping the safety belt through the control wheel and pulling it snug. The flaps should be fully retracted. Wheel chocks should be positioned in place.

Tiedowns can be secured to the wing tiedown rings and to the tail skid. The rudder is held in position by its connections to the nose wheel steering and normally does not have to be secured.

4.41 STALLS

The stall characteristics of the Malibu are conventional. An approaching stall is indicated by a stall warning horn which is activated between five and ten knots above stall speed. Mild airframe buffeting and pitching may also precede the stall.

The gross weight stalling speed with power off, landing gear extended, and full flaps is 58 KIAS. With the landing gear retracted and flaps up, this speed is increased to 69 KIAS. Loss of altitude during stalls can be as great as 700 feet, depending on configuration and power.

NOTE

The stall warning system is inoperative with the battery and alternator switches OFF.

During preflight, the stall warning system should be checked by turning the battery switch on and pressing the stall warning test switch to determine if the horn is actuated.

4.43 TURBULENT AIR OPERATION

In keeping with good operating practice used in all aircraft, it is recommended that when turbulent air is encountered or expected, the airspeed be reduced to maneuvering speed to reduce the structural loads caused by gusts and to allow for inadvertent speed build-ups which may occur as a result of the turbulence or of distractions caused by the conditions. (Refer to paragraph 2.3 for maneuvering speeds.)

4.45 CABIN PRESSURIZATION SYSTEM

Cabin pressurization system controls, gauges and switches are located to the right of the pilots control wheel shaft. (Refer to Section 7, Figure 7-39.)

The cabin pressurization system controls, gauges and switches are as follows:

- (a) Cabin Altitude Controller with Rate of Change Control
- (b) Cabin Pressure Altitude/Differential Pressure/Rate of Climb Gauge
- (c) Cabin Pressure Dump/Normal Switch
- (d) Cabin Pressurization Control

Prior to starting engine, check the operation of the cabin pressurization control. Note that a firm effort is required to move the lever out of either the outside air or the pressurized air position. If little effort is required to move the lever, be suspicious of a broken control cable. If a cable is broken, the air control valve may have failed in either the open or closed position. If failed open, pressurized flight will not be possible, but unpressurized flight will be possible. If failed closed, pressurized flight would be possible but should not be attempted, as it would not be possible to bring in fresh air should contamination occur.

Set *cabin* altitude (outer scale) on the cabin altitude controller to 500 feet above the field pressure altitude before takeoff. (Cabin pressurization will begin as the cabin passes through the altitude selected.) If no further adjustments are made, cabin altitude will remain at the selected altitude until maximum cabin differential (5.5 PSI) is reached, at which time the cabin altitude will begin to climb until at 25,000 feet aircraft pressure altitude the cabin pressure altitude will be approximately 8000 feet.

4.45 CABIN PRESSURIZATION SYSTEM (Continued)

For flight below an airplane altitude of 12,500 feet, the cabin altitude control should be left at the takeoff setting. For flight above 12,500 feet, at which point maximum differential will be achieved, smoother operation will result by setting the *cabin* altitude (outer scale) on the cabin altitude controller to 500 feet above field elevation for takeoff. Once the cabin has begun to pressurize and the controller has captured isobaric control, reset the *aircraft* altitude (inner scale) on the cabin altitude controller to 500 feet above the cruise altitude and adjust the cabin rate of climb as desired. The normal 9 o'clock position should provide a cabin rate of climb of approximately 500 feet per minute. No additional adjustment should be required prior to descent unless cruise altitude is changed, at which point the *aircraft* altitude (inner scale) should be reset to 500 feet above the new cruise altitude.

To descend for landing be certain that the selected *cabin* altitude (outer scale) is higher than the pressure altitude of the landing field. Shortly after letdown is initiated, set the *cabin* altitude (outer scale) to 500 feet above the pressure altitude of the landing field and adjust the rate of control high enough to allow the cabin to descend to the landing setting before the aircraft descends to that altitude. For normal letdown the rate knob should be at the normal 9 o'clock position. A higher setting should be selected for rapid descents so that the aircraft altitude does not catch up with the cabin altitude.

WARNING

Do not land with aircraft pressurized.

To repressurize while in flight push the pressurization control in and set the cabin pressure dump/normal switch to NORM.

4.47 SUPPLEMENTAL ELECTRIC HEATER**AFTER ENGINE START**

BATT MASTER Switch	ON
Alternator Switches	OFF
VENT DEFOG Switch	ON
Airflow	CHECK
Voltmeter	LESS than 25 Vdc (increase electrical load as necessary to lower voltage)
LOW BUS VOLTAGE Annunciator	ILLUMINATED
Electrical Switches	OFF
VENT DEFOG Switch	OFF
Alternator Switches	ON

NOTE

Low voltage monitor system and LOW BUS VOLTAGE annunciator must be checked operational before heater operation. VENT/DEFOG BLOWER must be checked operational before heater ground operation.

HEATER OPERATION

VENT DEFOG Switch.....	ON
AUX CBN HEAT Switch	ON

For maximum heat:

AIR COND Switch	OFF
CABIN TEMP Control.	FULL OUT
DEFROST Control	AS REQUIRED to CLEAR WINDSHIELD; then FULL IN

NOTE

This unit should be considered primarily as an auxiliary backup to the standard heating system. There is no external control over the heat produced by the unit.

4.49 NOISE LEVEL

The corrected noise level of this aircraft with a two blade propeller is 74.7 dB(A). as measured per FAR 36 Appendix F. For the three blade propeller, the corrected noise level of this aircraft is 79.7 dB(A) as measured per FAR 36 Appendix G.

No determination has been made by the Federal Aviation Administration that the noise levels of this airplane are or should be acceptable or unacceptable for operation at, into, or out of, any airport.

The above statement notwithstanding, the noise level stated above has been verified by and approved by the Federal Aviation Administration in noise level test flights conducted in accordance with F.A.R. 36, Noise Standards - Aircraft Type and Airworthiness Certification. This aircraft model is in compliance with all F.A.R. 36 noise standards applicable to this type.

The corrected noise level for this aircraft as measured per ICAO Annex 16, chapter 10 is 83.1 dB(A) for the three blade propeller installation.

FOR REFERENCE ONLY
NOT FOR FLIGHT

4.50 ICING INFORMATION**"THE FOLLOWING WEATHER CONDITIONS MAY BE
CONDUCTIVE TO SEVERE IN-FLIGHT ICING"**

Visible rain at temperatures below 0 degrees Celsius ambient air temperature.

Droplets that splash or splatter on impact at temperature below 0 degrees Celsius ambient air temperature.

**"PROCEDURES FOR EXITING THE SEVERE ICING
ENVIRONMENT"**

These procedures are applicable to all flight phases from takeoff to landing. Monitor the ambient air temperature. While severe icing may form at temperatures as cold as -18 degrees Celsius, increased vigilance is warranted at temperatures around freezing with visible moisture present. If the visual cues specified in the Limitations Section of the AFM for identifying severe icing conditions are observed, accomplish the following:

- Immediately request priority handling from Air Traffic Control to facilitate a route or an altitude change to exit the severe icing conditions in order to avoid extended exposure to flight conditions more severe than those for which the airplane has been certificated.
- Avoid abrupt and excessive maneuvering that may exacerbate control difficulties.
- Do not engage the autopilot.
- If the autopilot is engaged, hold the control wheel firmly and disengage the autopilot.
- If an unusual roll response or uncommanded roll control movement is observed, reduce the angle-of-attack.
- Do not extend flaps when holding in icing conditions. Operation with flaps extended can result in a reduced wing angle-of-attack, with the possibility of ice forming on the upper surface further aft on the wing than normal, possibly aft of the protected area.
- If the flaps are extended, do not retract them until the airframe is clear of ice.
- Report these weather conditions to Air Traffic Control.

TABLE OF CONTENTS

SECTION 5

PERFORMANCE

Paragraph No.		Page No.
5.1	General	5-1
5.2	Aircraft Configuration	5-1
5.3	Introduction - Performance and Flight Planning	5-1
5.5	Flight Planning Example	5-3
5.7	Performance Graphs	5-9
	List of Figures.....	5-9

FOR REFERENCE ONLY
NOT FOR FLIGHT

SECTION 5 PERFORMANCE

5.1 GENERAL

All of the required (FAA regulations) and complementary performance information is provided by this section.

Performance information associated with those optional systems and equipment which require handbook supplements is provided by Section 9 (Supplements).

5.2 AIRCRAFT CONFIGURATION

Performance depicted in Section 5 is applicable to aircraft equipped with ice protection system and weather radar pod.

For the effect of ice protection system on performance, refer to Section 9 Supplement 3. For the effect of weather radar pod on performance, refer to Section 9 Supplement 9.

5.3 INTRODUCTION - PERFORMANCE AND FLIGHT PLANNING

The performance information presented in this section is based on measured Flight Test Data corrected to I.C.A.O. standard day conditions and analytically expanded for the various parameters of weight, altitude, temperature, etc.

The performance charts are unfactored and do not make any allowance for varying degrees of pilot proficiency or mechanical deterioration of the aircraft. This performance, however, can be duplicated by following the stated procedures in a properly maintained airplane.

Effects of conditions not considered on the charts must be evaluated by the pilot, such as the effect of soft or grass runway surface on takeoff and landing performance, or the effect of winds aloft on cruise and range performance. Endurance can be grossly affected by improper leaning procedures, and inflight fuel flow and quantity checks are recommended.

REMEMBER! To get chart performance, follow the chart procedures.

**5.3 INTRODUCTION - PERFORMANCE AND FLIGHT PLANNING
(CONT.)**

The information provided by paragraph 5.5 (Flight Planning Example) outlines a detailed flight plan using performance charts in this section. Each chart includes its own example to show how it is used.

WARNING

Performance information derived by extrapolation beyond the limits shown on the charts should not be used for flight planning purposes.

**FOR REFERENCE ONLY
NOT FOR FLIGHT**

5.5 FLIGHT PLANNING EXAMPLE**(a) Aircraft Loading**

The first step in planning the flight is to calculate the airplane weight and center of gravity by utilizing the information provided by Section 6 (Weight and Balance) of this handbook.

The basic empty weight for the airplane as licensed at the factory has been entered in Figure 6-5. If any alterations to the airplane have been made affecting weight and balance, reference to the aircraft logbook and Weight and Balance Record (Figure 6-7) should be made to determine the current basic empty weight of the airplane.

Make use of the Weight and Balance Loading Form (Figure 6-11) and the C.G. Range and Weight graph (Figure 6-15) to determine the total weight of the airplane and the center of gravity position.

After proper utilization of the information provided, the following weights have been determined for consideration in the flight planning example.

The landing weight cannot be determined until the weight of the fuel to be used has been established (refer to item (g) (1).

(1) Basic Empty Weight	3156.5 lb
(2) Occupants (See Section 6.9)	800.0 lb
(3) Baggage and Cargo	80.0 lb
(4) Fuel (6 lb/gal. x 53.58 gal.)	321.5 lb
(5) Ramp Weight	4358.0 lb
(6) Start, Taxi, Weight & Takeoff Fuel	-18.0 lb
(7) Takeoff Weight	4340.0 lb
(8) Landing Weight	
(a)(7) minus (g)(1), (4340.0 lb minus 258.5 lb)	4081.5 lb

The takeoff weight is at or below the maximum allowable weight of 4340 lbs and the weight and balance calculations have determined the C.G. position within the approved limits. The landing weight is at or below the maximum landing weight of 4123 lb.

5.5 FLIGHT PLANNING EXAMPLE (CONT)

(b) Takeoff and Landing

Now that the aircraft loading has been determined, all aspects of the takeoff and landing must be considered.

All of the existing conditions at the departure and destination airport must be acquired, evaluated and maintained throughout the flight.

Apply the departure airport conditions and takeoff weight to the appropriate Takeoff Ground Roll and Takeoff Distance (Figures 5-13, 5-15, 5-17 and 5-19) to determine the length of runway necessary for the takeoff and/or obstacle clearance.

The landing distance calculations are performed in the same manner using the existing conditions at the destination airport and, when established, the landing weight.

The conditions and calculations for the example flight are listed below. The takeoff and landing distances required for the flight have fallen well below the available runway lengths.

	Departure Airport	Destination Airport
(1) Pressure Altitude	5000 ft	1000 ft
(2) Temperature	20°C	25°C
(3) Wind Component (Headwind)	10 KTS	10 KTS
(4) Runway Length Available	3400 ft	5000 ft
(5) Takeoff and Landing Distance Required	2647 ft*	1870 ft**

*reference Figure 5-19

**reference Figure 5-39

5.5 FLIGHT PLANNING EXAMPLE (CONT)

NOTE

The remainder of the performance charts used in this flight plan example assume a no wind condition. The effect of winds aloft must be considered by the pilot when computing climb, cruise and descent performance.

(c) Climb

The next step in the flight plan is to determine the necessary climb segment components.

The desired cruise pressure altitude and corresponding cruise outside air temperature values are the first variables to be considered in determining the climb components from the Fuel, Time, and Distance to Climb graph (Figure 5-24). After the fuel, time, and distance for the cruise pressure altitude and outside air temperature values have been established, apply the existing conditions at the departure field to graph (Figure 5-24). Now, subtract the values obtained from the graph for the field of departure conditions from those for the cruise pressure altitude.

The remaining values are the true fuel, time, and distance components for the climb segment of the flight plan corrected for field pressure altitude and temperature.

The following values were determined from the above instructions in the flight planning example.

(1) Cruise Pressure Altitude	20000 ft
(2) Cruise OAT	-19° C
(3) Fuel to Climb (13.5 gal. minus 5.7 gal.)	7.8 gal.*
(4) Time to Climb (18.8min. minus 4.7 min.)	14.1 min.*
(5) Distance to Climb (47.6 nautical miles minus 10.1 nautical miles)	37.5 nautical miles*

*reference Figure 5-24

5.5 FLIGHT PLANNING EXAMPLE (cont)

(d) Descent

The descent data will be determined prior to the cruise data to provide the descent distance for establishing the total cruise distance.

Utilizing the cruise pressure altitude and OAT, determine the basic fuel, time, and distance for descent (Figure 5-33). These figures must be adjusted for the field pressure altitude and temperature at the destination airport. To find the necessary adjustment values, use the existing pressure altitude and temperature conditions at the destination airport as variables to find the fuel, time, and distance values from the graph (Figure 5-33). Now, subtract the values obtained from the field conditions from the values obtained from the cruise conditions to find the true fuel, time and distance values needed for the descent segment of the flight plan.

The values obtained by proper utilization of the graphs for the descent segment of the example are shown below.

- | | |
|--|----------------------|
| (1) Fuel to Descend
(8.9 gal. minus 0.5 gal.) | 8.4 gal.* |
| (2) Time to Descend
(25.1 min. minus 1.4 min.) | 23.7 min.* |
| (3) Distance to Descend
(82.4 nautical miles minus 3.6
nautical miles) | 78.8 nautical miles* |

(e) Cruise

Using the total distance to be traveled during the flight, subtract the previously calculated distance to climb and distance to descend to establish the total cruise distance. Refer to the appropriate Textron Lycoming Manual and the Cruise Performance Table (refer to page 5-26) when selecting the cruise power setting. The established pressure altitude and temperature values and the selected cruise power should now be used to determine the true airspeed from the Cruise Speed Vs. Altitude graph (Figure 5-27).

*reference Figure 5-33

5.5 FLIGHT PLANNING EXAMPLE (cont)

Calculate the cruise fuel consumption for the cruise power setting from the information provided by the Textron Lycoming Manual and the Cruise Performance Table (refer to page 5-26).

The cruise time is found by dividing the cruise distance by the cruise speed and the cruise fuel is found by multiplying the cruise fuel consumption by the cruise time.

The cruise calculations established for the cruise segment of the flight planning example are as follows:

(1) Total Distance	375 nautical miles
(2) Cruise Distance	
(e)(1) minus (c)(5) minus	
(d)(3), (375 nautical miles	
minus 37.5 nautical miles	
minus 78.8 nautical miles)	258.7 nautical miles
(3) Cruise Power	
(lean to peak T.I.T.)	Normal cruise power
(4) Cruise Speed	195 KTS TAS*
(5) Cruise Fuel Consumption	18 gph*
(6) Cruise Time	
(e)(2) divided by (e)(4),	
(258.7 nautical miles	
divided by 195 KTS)	1.33 hrs
	79.6 min.
(7) Cruise Fuel	
(e)(5) multiplied by (e)(6)	
(18 gph multiplied by 1.33 hrs)	23.88 gal.
(f) Total Flight Time	

The total flight time is determined by adding the time to climb, the time to descend and the cruise time. Remember! The time values taken from the climb and descent graphs are in minutes and must be converted to hours before adding them to the cruise time.

*reference Figure 5-27 and Page 5-26

5.5 FLIGHT PLANNING EXAMPLE (cont)

The flight time required for the flight planning example is shown below:

- (1) Total Flight Time
(c)(4) plus (d)(2) plus (e)(6),
(0.235 hrs plus 0.395 hrs plus 1.33 hrs)
(14.1 min. plus 23.7 min. plus 79.6 min.) 1.96 hrs/117.4 min.

(g) Total Fuel Required

Determine the total fuel required by adding the fuel for start, taxi, and runup (3.0 gal., calculated by allowing 5 minutes of fuel flow at takeoff power), the fuel to climb, the fuel to descend, and the cruise fuel. When the total fuel (in gallons) is determined, multiply this value by 6 lb/gal. to determine the total fuel weight used for the flight.

The total fuel calculations for the example flight plan are shown below.

- (1) Total Fuel Required
Fuel for Start, Taxi, and Runup plus
(c)(3) plus (d)(1) plus (e)(7), (3 gal.
plus 7.8 gal. plus 8.4 gal. plus 23.88 gal.) 43.08 gal
(43.1 gal. multiplied by 6 lb/gal.) 258.5 lb

5.7 PERFORMANCE GRAPHS

LIST OF FIGURES

Figure No.		Page No.
5-1	Airspeed Calibration	5-11
5-3	Angle of Bank Vs. Stall Speed.....	5-12
5-5	Temperature Conversion	5-13
5-7	Pressure Altitude Vs Outside Air Temperature.....	5-14
5-9	Temperature Rise Due To Ram Recovery	5-15
5-11	Wind Components	5-16
5-13	Takeoff Ground Roll, 0° Flaps	5-17
5-15	Takeoff Ground Roll, 20° Flaps	5-18
5-17	Takeoff Distance Over 50 Ft. Obstacle, 0° Flaps	5-19
5-19	Takeoff Distance Over 50 Ft. Obstacle, 20° Flaps	5-20
5-21	Rate of Climb	5-21
5-23	Maximum Continuous Power Time, Fuel, and Distance to Climb (110 KIAS).....	5-22
5-24	Maximum Continuous Power Time, Fuel, and Distance to Climb (125 KIAS).....	5-23
5-25	Cruise Climb Time, Fuel, and Distance to Climb.....	5-24
5-26	Maximum Manifold Pressure Vs. Pressure Altitude	5-25
	Power Setting Table.....	5-26
5-27	Cruise Speed Vs. Altitude	5-27
5-29	Range.....	5-28
5-31	Endurance.....	5-29
5-33	Fuel, Time, and Distance to Descend.....	5-30
5-35	Glide Time and Distance	5-31
5-37	Balked Landing Climb	5-32
5-39	Landing Distance Over 50 Ft. Obstacle	5-33
5-41	Landing Ground Roll	5-34

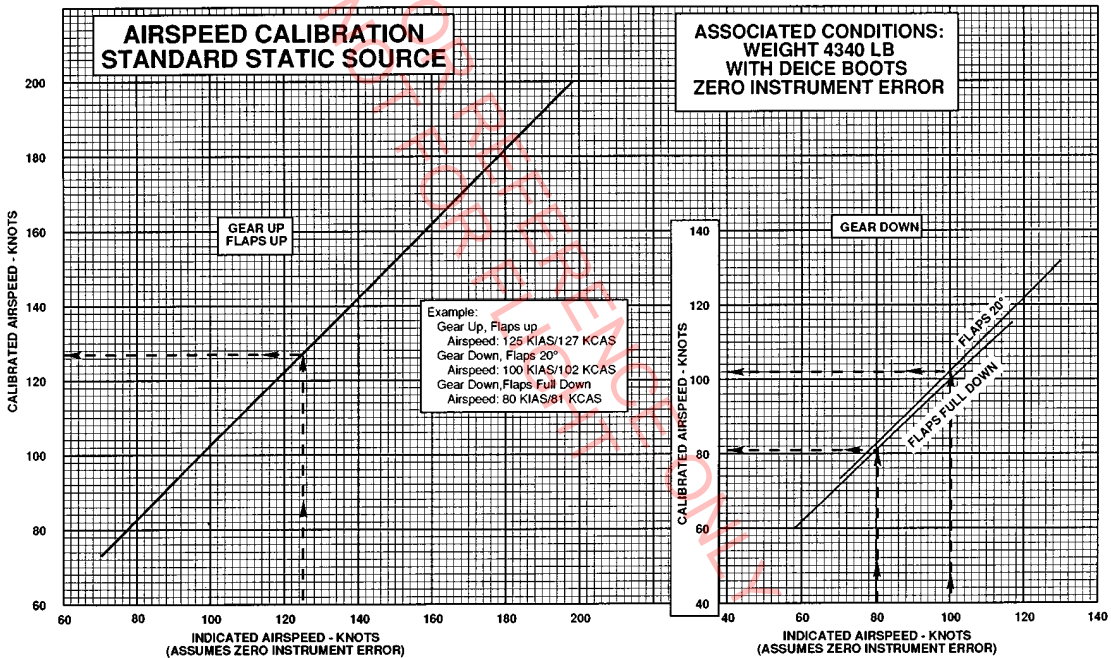

AIRSPEED CALIBRATION
Figure 5-1

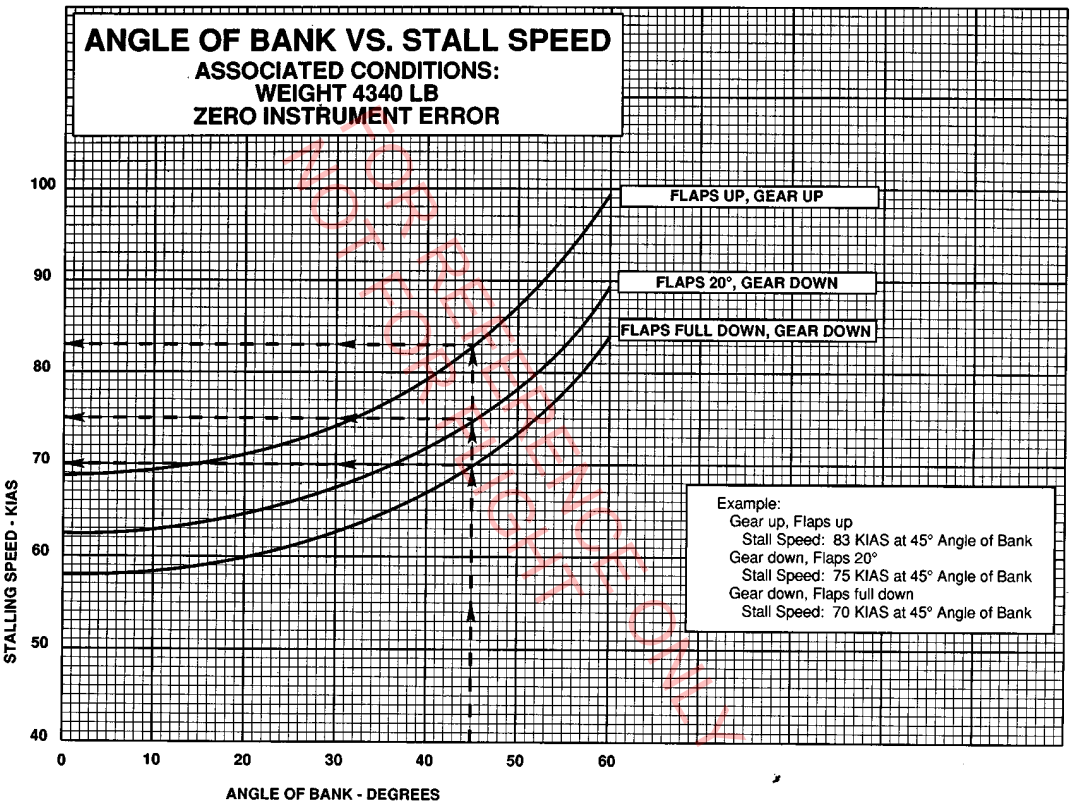

ANGLE OF BANK VS. STALL SPEED

Figure 5-3

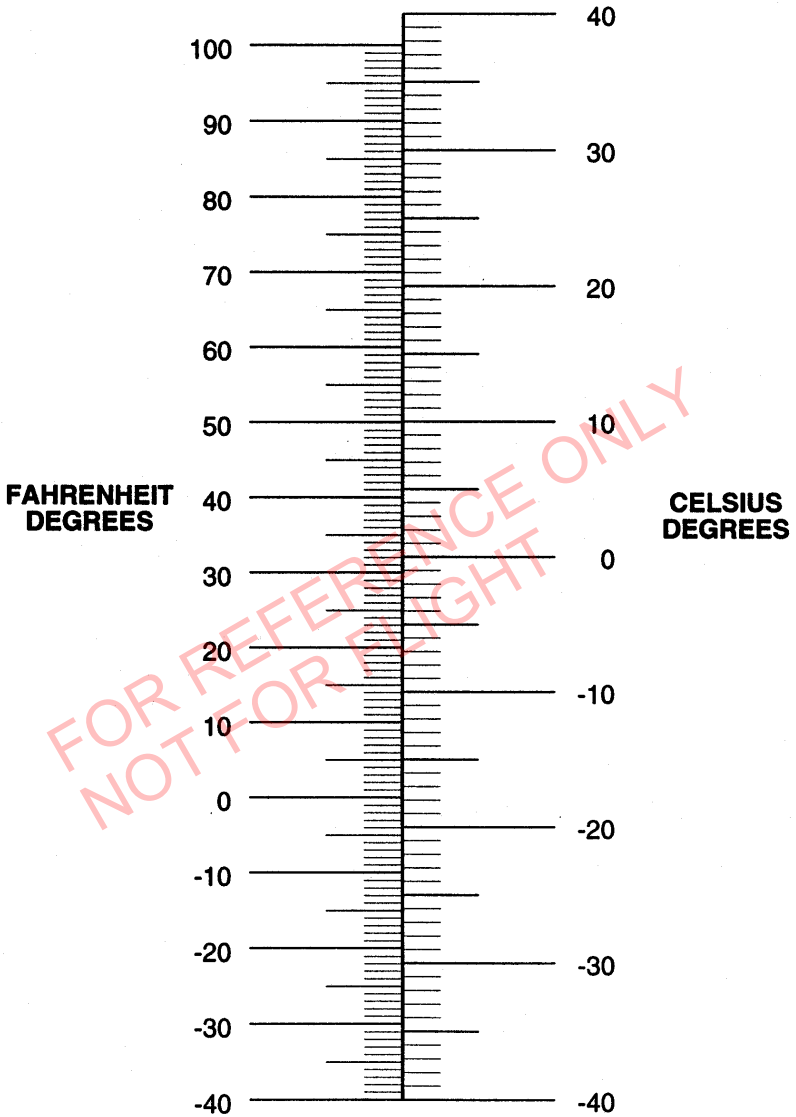

TEMPERATURE CONVERSION

Figure 5-5

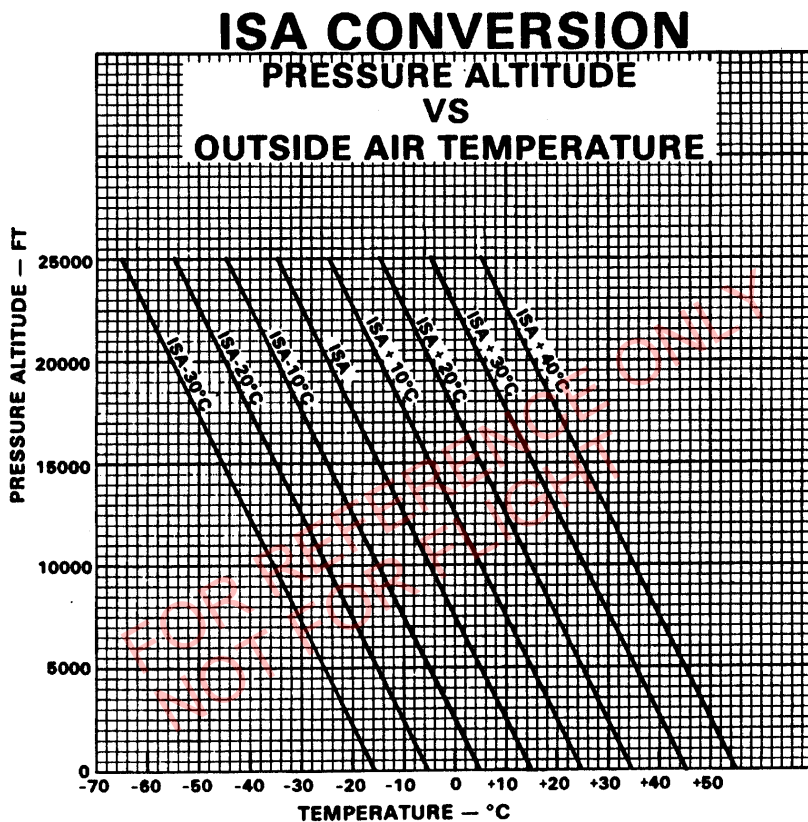

PRESSURE ALTITUDE
VS
OUTSIDE AIR TEMPERATURE

Figure 5-7

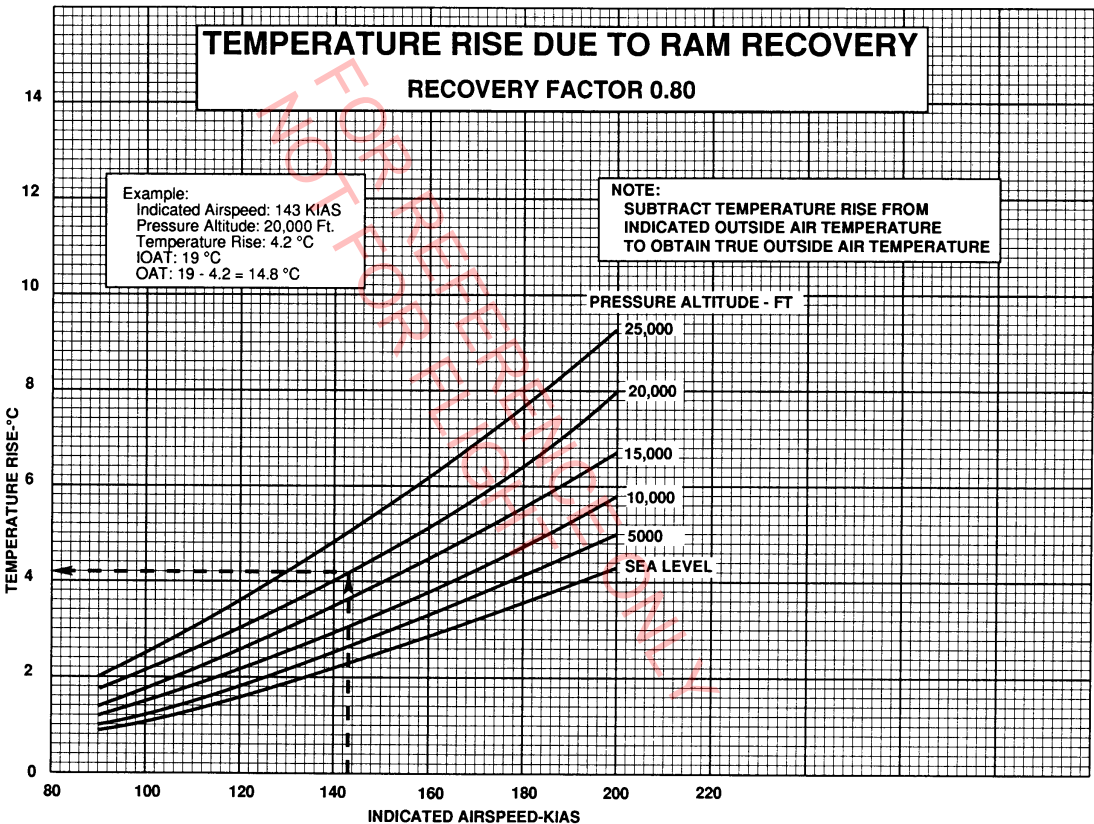

**TEMPERATURE RISE DUE TO
RAM RECOVERY**
Figure 5-9

Example:

Wind velocity: 30 knots

Angle between flight path and wind: 30°

Headwind component: 26 knots

Crosswind components: 15 knots

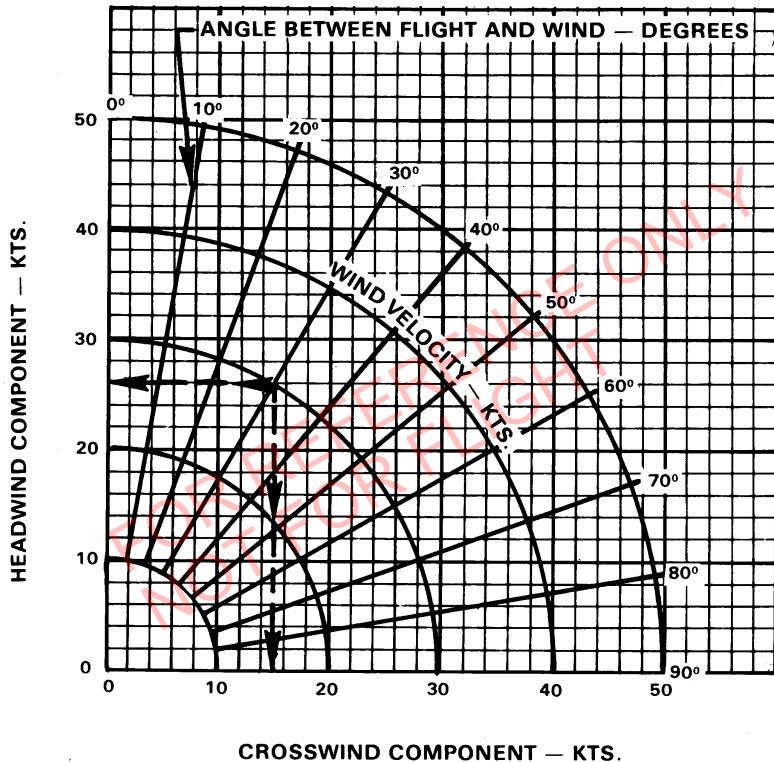

WIND COMPONENTS

Figure 5-11

TAKEOFF GROUND ROLL DISTANCE - 0° FLAPS

ASSOCIATED CONDITIONS

Wing Flaps: 0° Liftoff Speed: 78 KIAS
 Power: FULL THROTTLE Runway: PAVED, LEVEL
 2500 RPM & DRY
 BEFORE BRAKE RELEASE
 Mixture: FULL RICH

EXAMPLE

Airport Altitude: 5,000 FT Headwind Speed: 10 KNOTS
 OAT: 20° C Ground Roll Dist.: 2,070 FT.
 Takeoff Wt.: 4,340 LB.

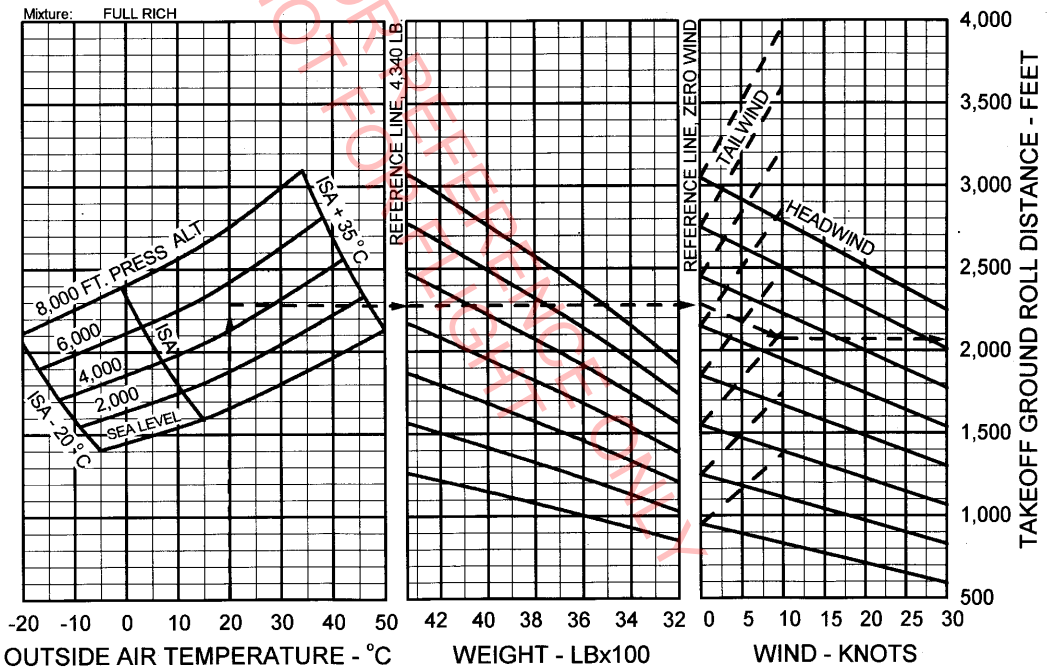

TAKEOFF GROUND ROLL, 0° FLAPS

Figure 5-13

TAKEOFF GROUND ROLL DISTANCE - 20° FLAPS

ASSOCIATED CONDITIONS

Wing Flaps: 20°
 Power: FULL THROTTLE
 2,500 RPM
 BEFORE BRAKE RELEASE
 Mixture: FULL RICH

Liftoff Speed: 69 KIAS
 Runway: PAVED, LEVEL
 & DRY

EXAMPLE

Airport Altitude: 5,000 FT
 OAT: 20° C
 Takeoff Wt.: ALL

Headwind Speed: 10 KNOTS
 Takeoff Ground Roll Dist.: 1,406 FT.

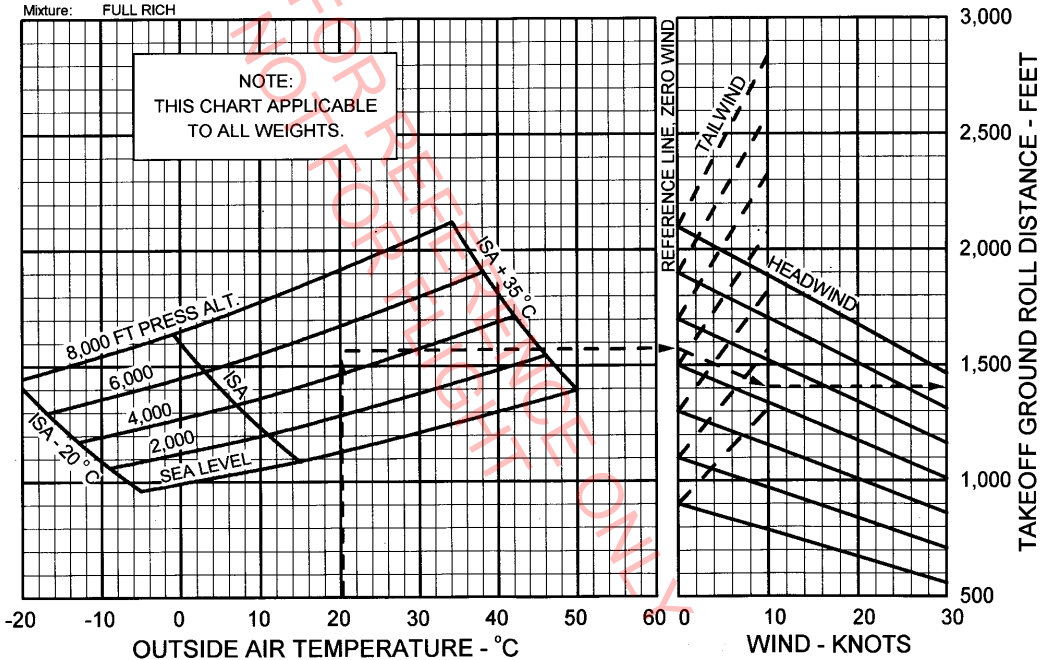

TAKEOFF GROUND ROLL, 20° FLAPS

Figure 5-15

TAKEOFF DISTANCE OVER 50 FT OBSTACLE - 0° FLAPS

ASSOCIATED CONDITIONS

Wing Flaps: 0° Liftoff Speed: 78 KIAS
 Power: FULL THROTTLE Barrier Speed: 91 KIAS
 2500 RPM Runway: PAVED, LEVEL
 BEFORE BRAKE RELEASE & DRY
 Mixture: FULL RICH

EXAMPLE

Airport Altitude: 5,000 FT Headwind Speed: 10 KNOTS
 OAT: 20° C Barrier Distance: 3,500 FT.
 Takeoff Wt.: 4,340 LB.

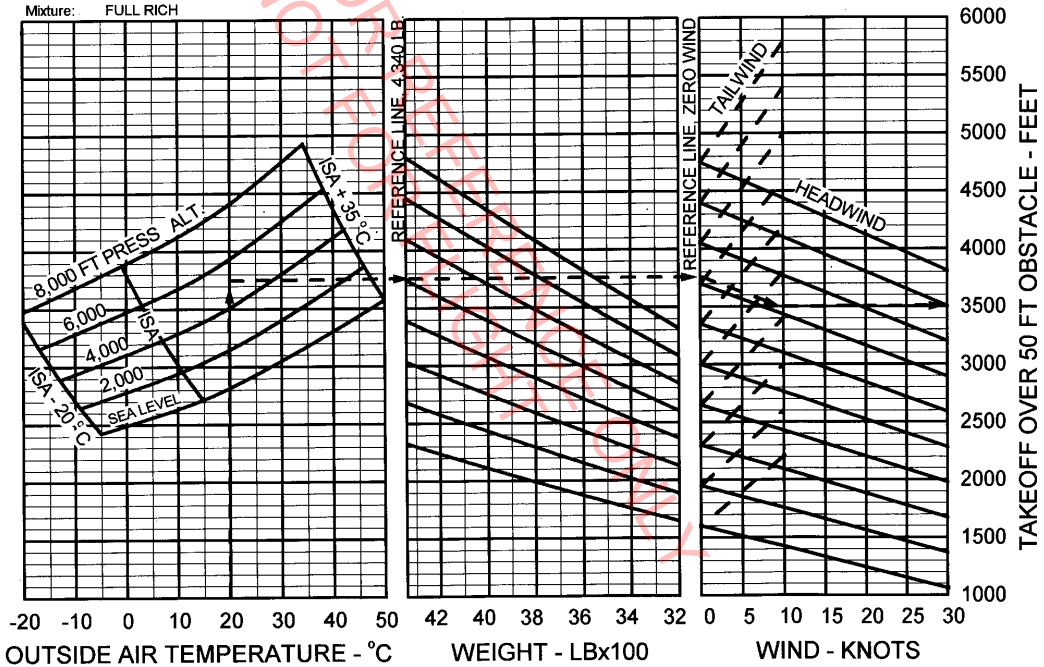

TAKEOFF DISTANCE OVER 50 FT. OBSTACLE, 0° FLAPS

Figure 5-17

TAKEOFF DISTANCE OVER 50 FT OBSTACLE - 20° FLAPS

ASSOCIATED CONDITIONS

Wing Flaps: 20° Liftoff Speed: 69 KIAS
 Power: FULL THROTTLE Barrier Speed: 80 KIAS
 2,500 RPM Runway: PAVED, LEVEL
 BEFORE BRAKE RELEASE & DRY
 Mixture: FULL RICH

EXAMPLE

Airport Altitude: 5,000 FT Headwind Speed: 10 KNOTS
 OAT: 20° C Barrier Distance: 2,647 FT.
 Takeoff Wt.: ALL

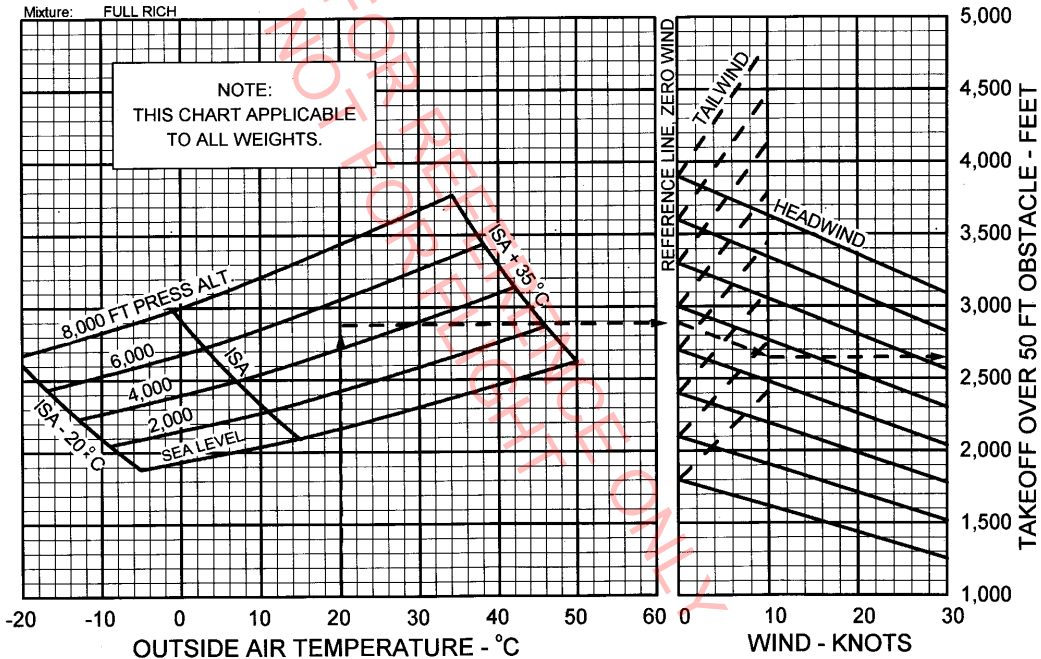

TAKEOFF DISTANCE OVER 50 FT. OBSTACLE, 20° FLAPS

Figure 5-19

MAXIMUM CLIMB PERFORMANCE

ASSOCIATED CONDITIONS

Gear: UP Power: FULL THROTTLE
 Flaps: 0° 2,500 RPM
 Climb Speed: 110 KIAS

EXAMPLE

Press. Alt.: 10,000 FT Weight: 4,100 LB
 OAT: 15° C ROC: 1,223 FPM

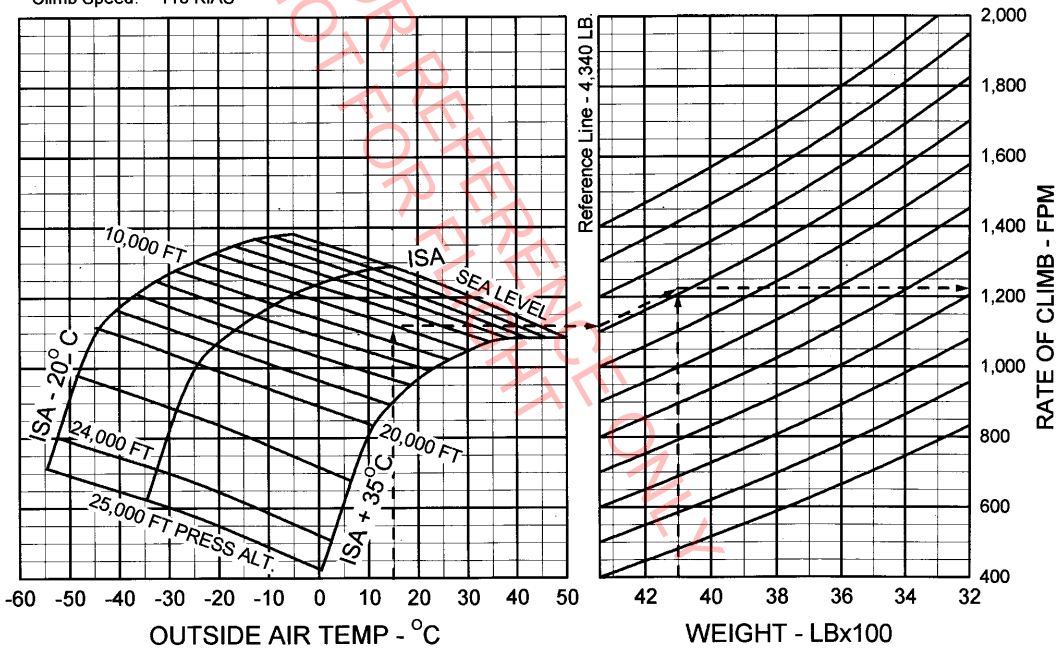

RATE OF CLIMB

Figure 5-21

TIME, FUEL, DISTANCE TO MAX CLIMB

ASSOCIATED CONDITIONS

Gross Weight: 4340 LB Power: 2,500 RPM
 Landing Gear: UP 42 IN. HG. OR
 Flaps: UP FULL THROTTLE
 Climb Speed: 110 KIAS Mixture: FULL RICH

EXAMPLE

Departure Airport O.A.T.: 20 °C Time to Climb: 16.9 - 4.2 = 12.7 MIN
 Departure Airport Altitude: 5,000 FT. Fuel to Climb: 12.4 - 5.4 = 7.0 GAL
 Cruise O.A.T.: -19 °C Distance to Climb: 37.5 - 8.4 = 29.1 N.M.
 Cruise Altitude: 20,000 FT.

MAXIMUM CONTINUOUS POWER
 TIME, FUEL, AND DISTANCE TO CLIMB (110 KIAS)

Figure 5-23

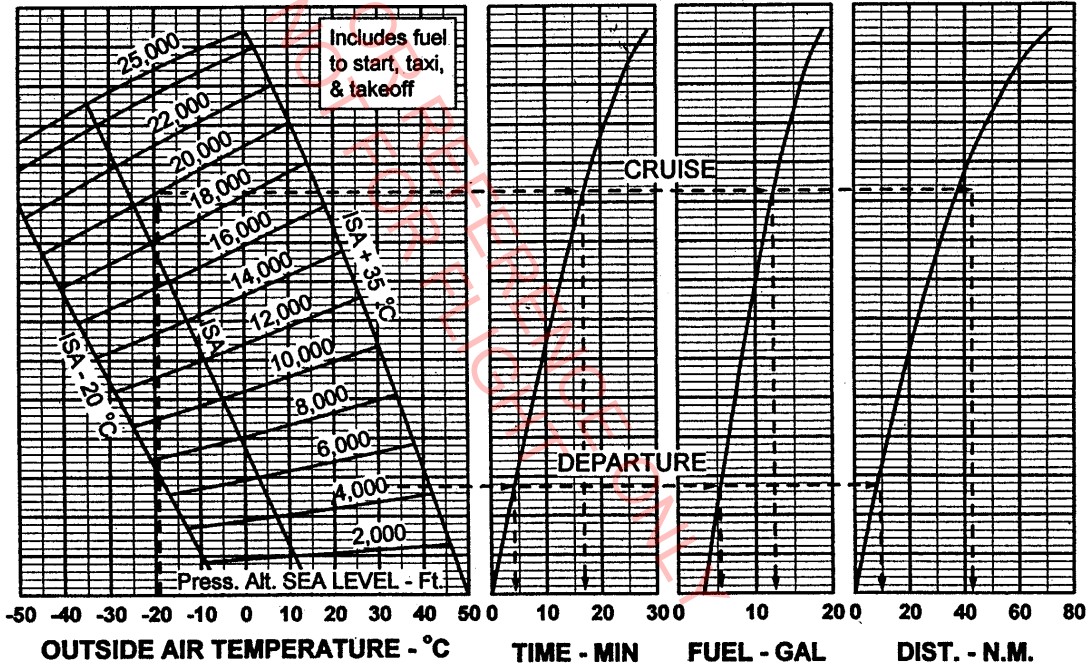

TIME, FUEL, DISTANCE TO CLIMB

ASSOCIATED CONDITIONS

Gross Weight: 4,340 LB Power: 2,500 RPM
 Landing Gear: UP 42 IN. HG. OR
 Flaps: UP FULL THROTTLE
 Climb Speed: 125 KIAS Mixture: FULL RICH

EXAMPLE

Departure Airport O.A.T.: 20 °C Time to Climb: 18.8 - 4.7 = 14.1 MIN
 Departure airport Altitude: 5,000 FT. Fuel to Climb: 13.5 - 5.7 = 7.8 GAL
 Cruise O.A.T.: -19 °C Distance to Climb: 47.6 - 10.1 = 37.5 N.M.
 Cruise Altitude: 20,000 FT.

MAXIMUM CONTINUOUS POWER TIME, FUEL, AND DISTANCE TO CLIMB (125 KIAS)

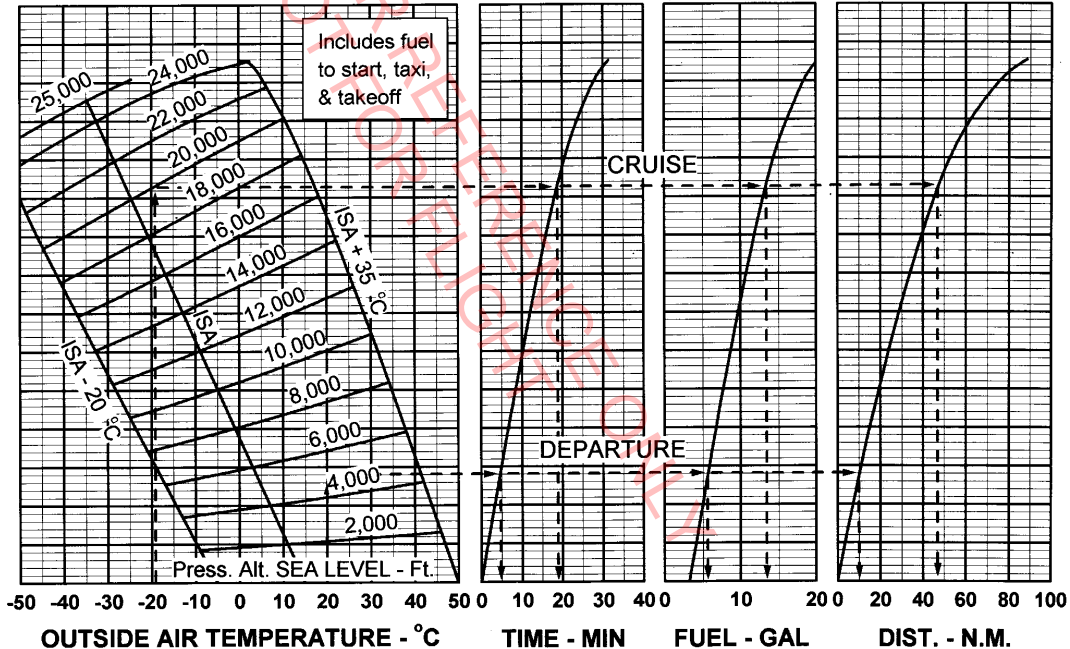

Figure 5-24

TIME, FUEL, DISTANCE TO CRUISE CLIMB

ASSOCIATED CONDITIONS

Gross Weight:	4,340 LB	Power:	2,500 RPM
Landing Gear:	UP		35 IN. HG.
Flaps:	UP	Fuel Flow:	32 GPH
Climb Speed:	125 KIAS		

EXAMPLE

Departure Airport O.A.T.:	20 °C	Time to Climb:	26.7 - 6.4 = 20.3 MIN
Departure airport Altitude:	5,000 FT.	Fuel to Climb:	17.4 - 6.9 = 10.5 GAL
Cruise O.A.T.:	-19 °C	Distance to Climb:	67.8 - 15.4 = 52.4 N.M.
Cruise Altitude:	20,000 FT.		

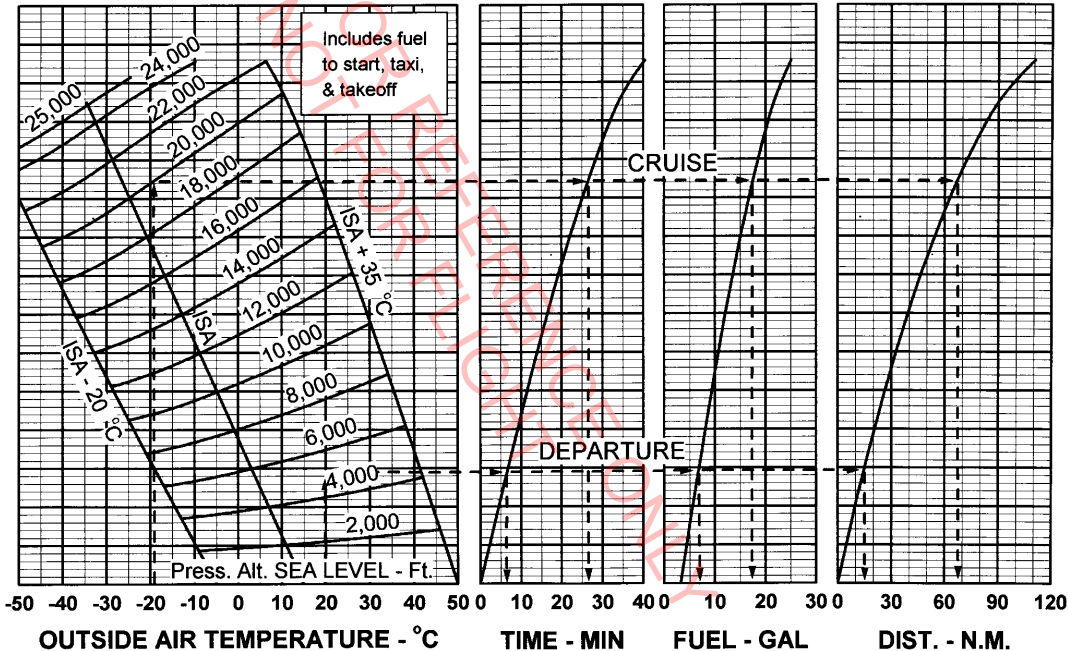

**CRUISE CLIMB
TIME, FUEL, AND DISTANCE TO CLIMB**

Figure 5-25

MAXIMUM MANIFOLD PRESSURE VS PRESSURE ALTITUDE

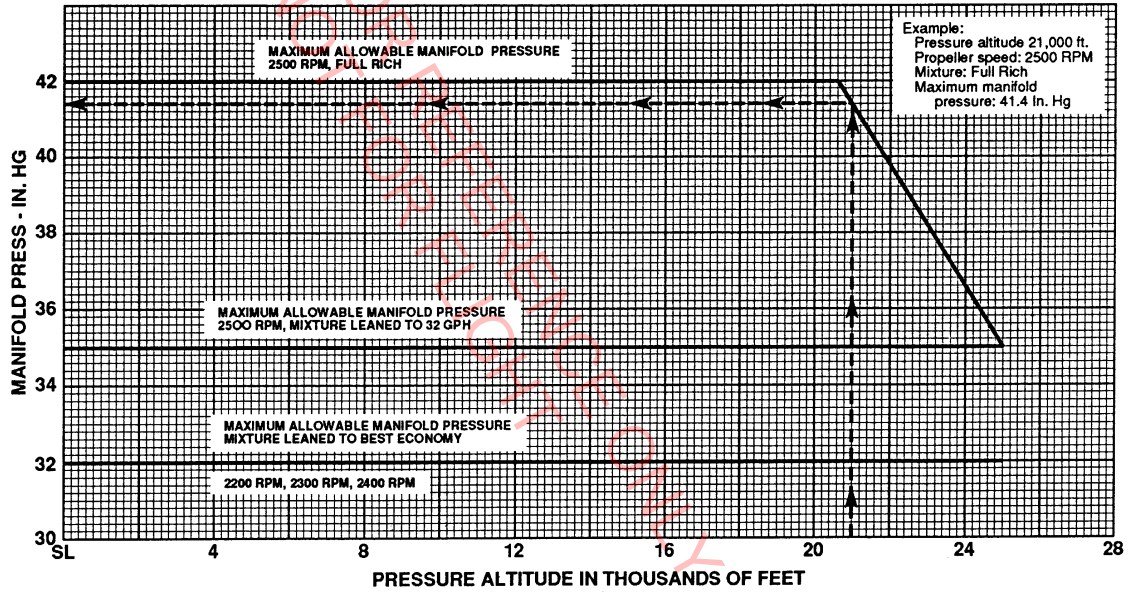

MAXIMUM MANIFOLD PRESSURE Vs. PRESSURE ALTITUDE

Figure 5-26

POWER SETTING TABLE
REFERENCE FIG. 5-27

ASSOCIATED CONDITIONS

	RPM	Man. Press.	Approx. Fuel Flow @ 20,000 ft	TIT
High Speed Cruise	2500	32" Hg	20 GPH	Lean to Peak
Normal Cruise	2500 2400	29" Hg 30" Hg	18 GPH	Lean to Peak
Economy Cruise	2400 2200	25" Hg 26" Hg	15 GPH	Lean to Peak
Long Range Cruise	2200	20" Hg	11 GPH	Lean to Peak

The higher rpm settings should be used at altitudes above 20,000 ft.

The cruise speeds are shown at mid-cruise weight, 3900 pounds. The speed differential for weight is 0.7 knots per 100 pounds, faster at lighter weights and slower at heavier weights.

The leaning procedure is to establish peak T.I.T.

***Example:**

- Cruise altitude: 20,000 ft
- Cruise OAT: -19° C
- Cruise power: Normal cruise
- Cruise weight: 3900 lb
- Cruise fuel flow: 18 gph
- Cruise speed: 195 KTAS

***Reference Figure 5-27**

CRUISE SPEED VS. ALTITUDE

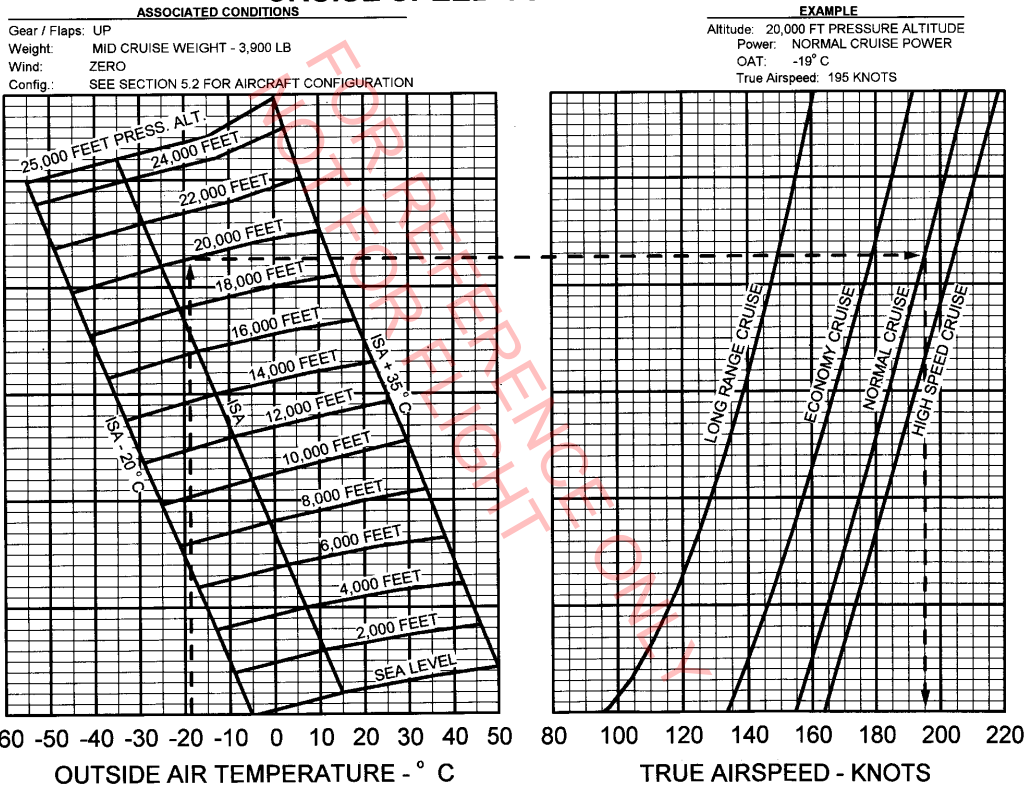

CRUISE SPEED VS. ALTITUDE

Figure 5-27

ISA RANGE

ASSOCIATED CONDITIONS:

Gear / Flaps: UP
Weight: MID CRUISE WEIGHT - 3,900 LB
Reserve: 45 MIN AT LONG RANGE CRUISE POWER
Usable Fuel: 120 GALLONS
Wind: ZERO

EXAMPLE:

Power Setting: NORMAL CRUISE
Cruise: 20,000 FT PRESSURE ALTITUDE
Range: 1,000 NAUTICAL MILES

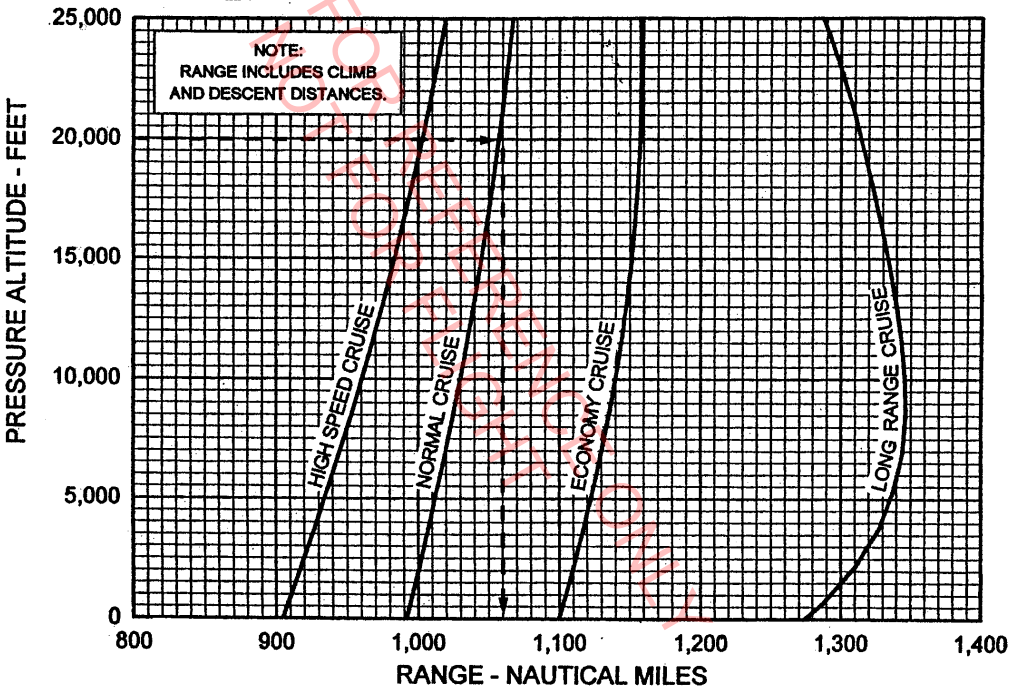

ISA RANGE
Figure 5-29

ISA ENDURANCE

ASSOCIATED CONDITIONS:

Gear / Flaps: UP
 Reserve: 45 MIN AT LONG RANGE CRUISE POWER
 Usable Fuel: 120 GALLONS

EXAMPLE:

Power Setting: NORMAL CRUISE
 Cruise: 20,000 FT PRESSURE ALTITUDE
 Endurance: 5.5 HOURS

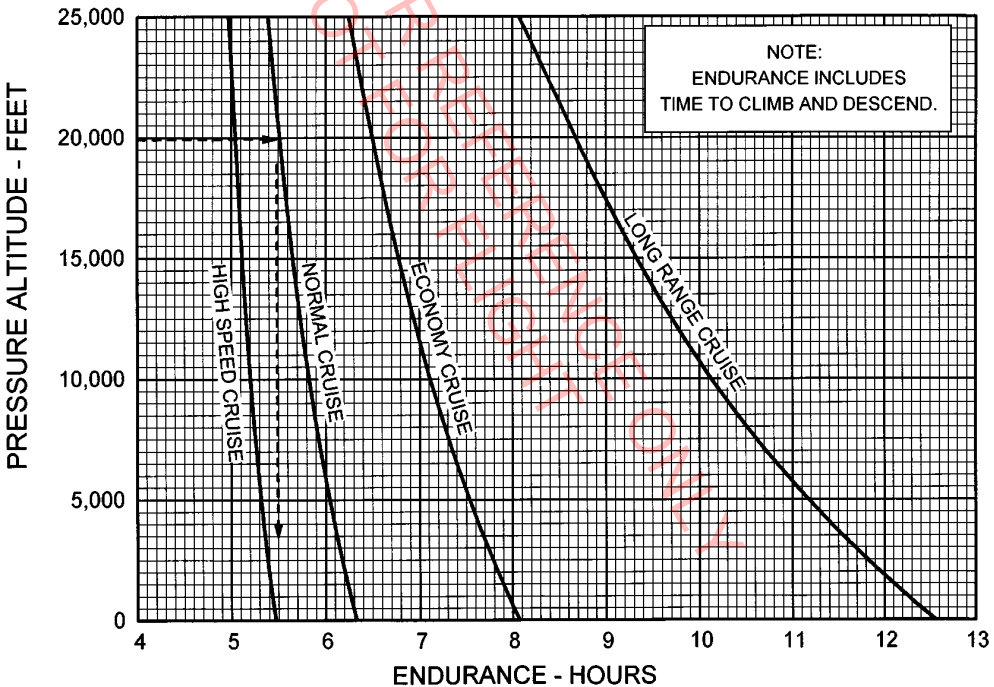

ISA ENDURANCE

Figure 5-31

TIME, FUEL, DISTANCE TO DESCEND

ASSOCIATED CONDITIONS

Landing Gear: UP Power: 2,400 RPM
 Flaps: UP 25 IN. HG.
 Descend Speed: 165 KIAS ZERO WIND

EXAMPLE

Arrival Airport O.A.T.: 25 °C Time to Descend: 25.1 - 1.4 = 23.7 MIN
 Arrival Airport Altitude: 1,000 FT. Fuel to Descend: 8.9 - 0.5 = 8.4 GAL
 Cruise O.A.T.: -19 °C Distance to Descend: 82.4 - 3.6 = 78.8 N.M.
 Cruise Altitude: 20,000 FT.

4,340 LB. Malibu Mirage

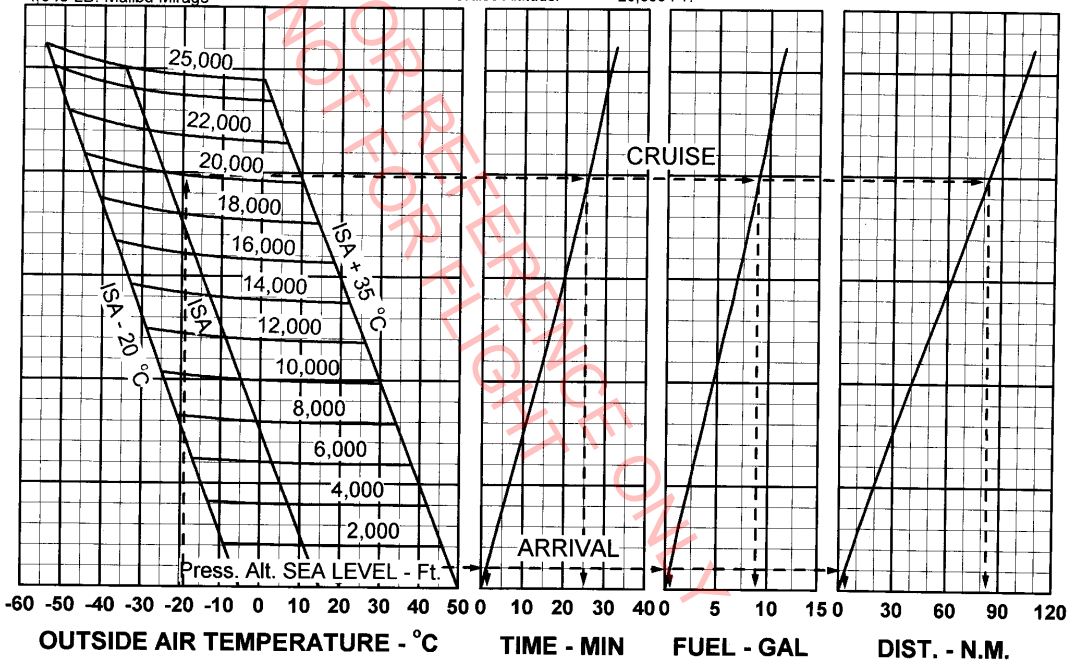

FUEL, TIME, AND DISTANCE TO DESCEND

Figure 5-33

GLIDE TIME, & DISTANCE

ASSOCIATED CONDITIONS

Landing Gear: UP Prop Control: FULL AFT
 Flaps: UP Glide Speed: 90 KIAS
 ZERO WIND

EXAMPLE

Destination OAT: 15 °C Time to Descend: 26.8 - 6.1 = 20.7 MIN
 Destination Altitude: 4,000 FT. Distance to Descend: 48.6 - 9.7 = 38.9 N.M.
 Cruise O.A.T.: -19 °C
 Cruise Altitude: 20,000 FT.

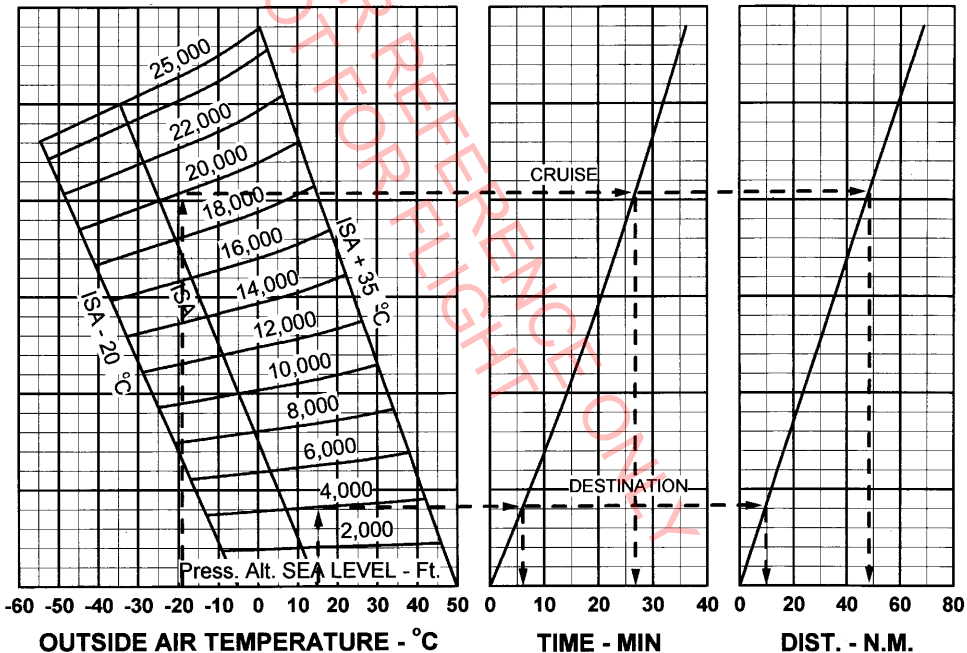

GLIDE TIME AND DISTANCE

Figure 5-35

BALKED LANDING CLIMB PERFORMANCE

ASSOCIATED CONDITIONS

Gear: DOWN Power: FULL THROTTLE
 Flaps: 36° 2,500 RPM
 Climb Speed: 80 KIAS

EXAMPLE

Press. Alt.: 4,000 FT Weight: 3,800 LB
 OAT: 15° C ROC: 811 FPM

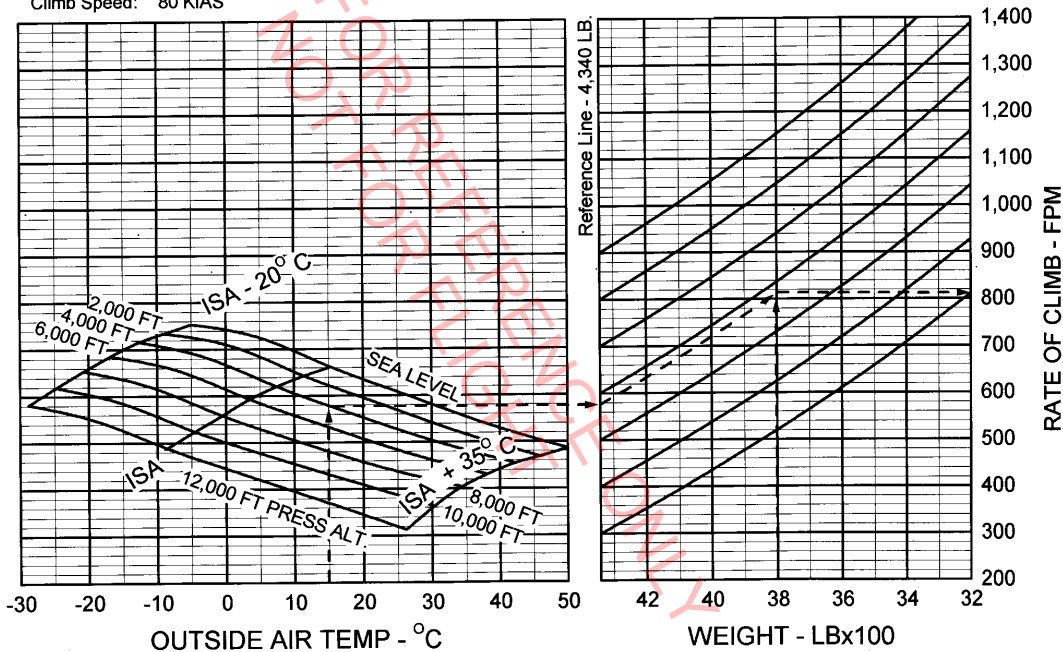

BALKED LANDING CLIMB

Figure 5-37

LANDING PERFORMANCE

ASSOCIATED CONDITIONS

Gear: DOWN Braking: HEAVY
 Flaps: 36° Approach speed: 78 KIAS
 Throttle: CLOSED Touch Down: FULL STALL
 RUNWAY PAVED, LEVEL, & DRY

EXAMPLE

Press. Alt.: 1,000 FT Headwind: 10 KT
 OAT: 25°C Weight: 4,100 LB
 Landing Distance: 1,870 FEET

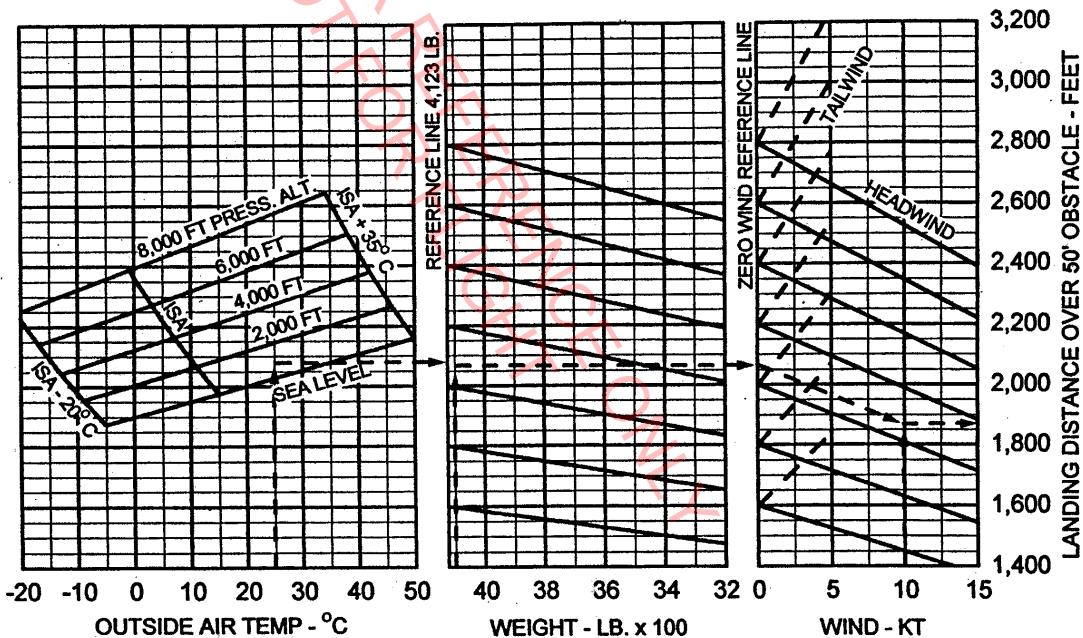

LANDING DISTANCE OVER 50 FT. OBSTACLE

Figure 5-39

LANDING GROUND ROLL DISTANCE

ASSOCIATED CONDITIONS

Gear: DOWN Throttle: CLOSED
 Flaps: 36° Braking: HEAVY
 FULL STALL TOUCH DOWN
 RUNWAY PAVED, LEVEL, & DRY

EXAMPLE

Press. Alt.: 1,000 FT Headwind: 10 KT
 OAT: 25°C Weight: 4,100 LB
 Landing Ground Roll: 955 FEET

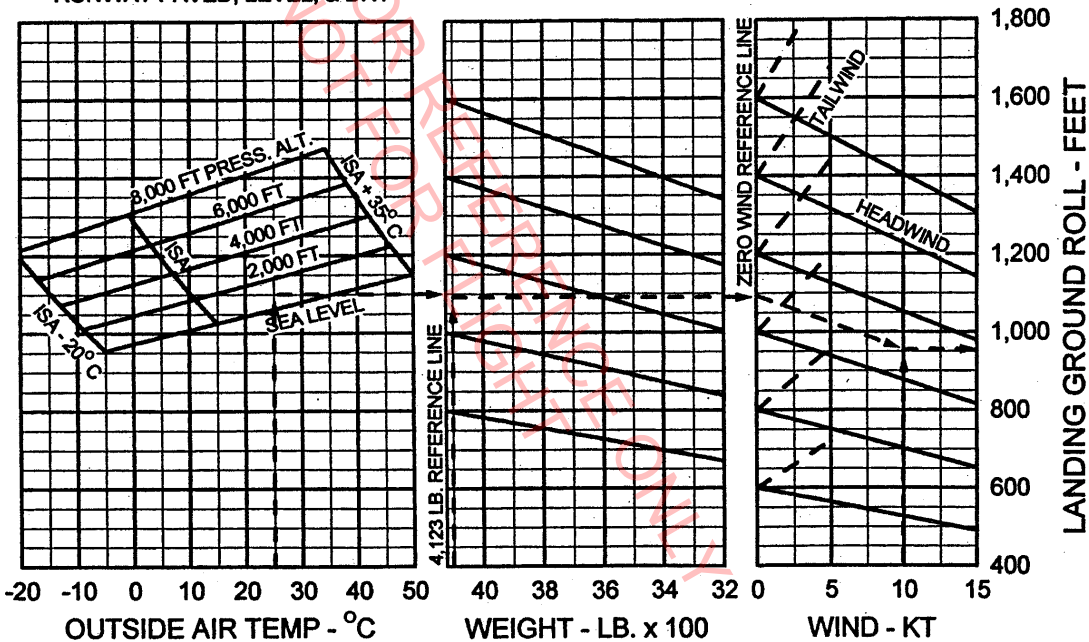

LANDING GROUND ROLL

Figure 5-41

TABLE OF CONTENTS
SECTION 6
WEIGHT AND BALANCE

Paragraph No.		Page No.
6.1	General	6-1
6.3	Airplane Weighing Procedure	6-2
6.5	Weight and Balance Data and Record	6-5
6.7	General Loading Recommendations	6-9
6.9	Weight and Balance Determination for Flight	6-10
	Equipment List (Form 240-0127)	Supplied with aircraft paperwork

FOR REFERENCE ONLY
NOT FOR FLIGHT

SECTION 6

WEIGHT AND BALANCE

6.1 GENERAL

In order to achieve the performance and flying characteristics which are designed into the airplane, it must be flown with the weight and center of gravity (C.G.) position within the approved operating range (envelope). Although the airplane offers flexibility of loading, it cannot be flown with the maximum number of adult passengers, full fuel tanks and maximum baggage. With the flexibility comes responsibility. The pilot must ensure that the airplane is loaded within the loading envelope before he makes a takeoff.

Misloading carries consequences for any aircraft. An overloaded airplane will not take off, climb or cruise as well as a properly loaded one. The heavier the airplane is loaded, the less climb performance it will have.

Center of gravity is a determining factor in flight characteristics. If the C.G. is too far forward in any airplane, it may be difficult to rotate for takeoff or landing. If the C.G. is too far aft, the airplane may rotate prematurely on takeoff or tend to pitch up during climb. Longitudinal stability will be reduced. This can lead to inadvertent stalls and even spins; and spin recovery becomes more difficult as the center of gravity moves aft of the approved limit.

A properly loaded airplane, however, will perform as intended. Before the airplane is licensed, a basic empty weight and C.G. location is computed (basic empty weight consists of the standard empty weight of the airplane plus the optional equipment). Using the basic empty weight and C.G. location, the pilot can determine the weight and C.G. position for the loaded airplane by computing the total weight and moment and then determining whether they are within the approved envelope.

6.1 GENERAL (Continued)

The basic empty weight and C.G. location are recorded in the Weight and Balance Data Form (Figure 6-5) and the Weight and Balance Record (Figure 6-7). The current values should always be used. Whenever new equipment is added or any modification work is done, the mechanic responsible for the work is required to compute a new basic empty weight and C.G. position and to write these in the Aircraft Log Book and the Weight and Balance Record. The owner should make sure that it is done.

A weight and balance calculation is necessary in determining how much fuel or baggage can be boarded so as to keep within allowable limits. Check calculations prior to adding fuel to insure against improper loading.

The following pages are forms used in weighing an airplane in production and in computing basic empty weight, C.G. position, and useful load. Note that the useful load includes usable fuel, baggage, cargo and passengers. Following this is the method for computing takeoff weight and C.G.

6.3 AIRPLANE WEIGHING PROCEDURE

At the time of licensing, Piper provides each airplane with the basic empty weight and center of gravity location. This data is supplied by Figure 6-5.

The removal or addition of equipment or airplane modifications can affect the basic empty weight and center of gravity. The following is a weighing procedure to determine this basic empty weight and center of gravity location:

(a) Preparation

- (1) Be certain that all items checked in the airplane equipment list are installed in the proper location in the airplane.
- (2) Remove excessive dirt, grease, moisture, and foreign items such as rags and tools, from the airplane before weighing.
- (3) Defuel airplane. Then open all fuel drains until all remaining fuel is drained. Operate engine on each tank until all undrainable fuel is used and engine stops. Then add the unusable fuel (2 gallons total, 1 gallon each wing).

6.3 AIRPLANE WEIGHING PROCEDURE (Continued)*CAUTION*

Whenever the fuel system is completely drained and fuel is replenished, it will be necessary to run the engine for a minimum of three minutes at 1000 rpm on each tank to ensure that no air exists in the fuel supply lines.

- (4) Fill with oil to full capacity.
 - (5) Place pilot and copilot seats in fifth (5th) notch, aft of forward position. Put flaps in the fully retracted position and all control surfaces in the neutral position. Tow bar should be in the proper location and all entrance and baggage doors closed.
 - (6) Weigh the airplane inside a closed building to prevent errors in scale readings due to wind.
- (b) Leveling
- (1) With the airplane on scales, insert a 3.4-inch spacer on each of the main gear struts and a 3.0-inch spacer on the nose gear strut.
 - (2) Level airplane (refer to Figure 6-3) deflating (or inflating as required) nose wheel tire, to center bubble on level.
- (c) Weighing - Airplane Basic Empty Weight
- (1) With the airplane level and brakes released, record the weight shown on each scale. Deduct the tare, if any, from each reading.

6.3 AIRPLANE WEIGHING PROCEDURE (Continued)

Scale Position and Symbol	Scale Reading	Tare	Net Weight
Nose Wheel (N)			
Right Main Wheel (R)			
Left Main Wheel (L)			
Basic Empty Weight, as Weighed (T)			

WEIGHING FORM

Figure 6-1

(d) Basic Empty Weight Center of Gravity

- (1) The following geometry applies to the airplane when it is level. Refer to Leveling paragraph 6.3 (b).

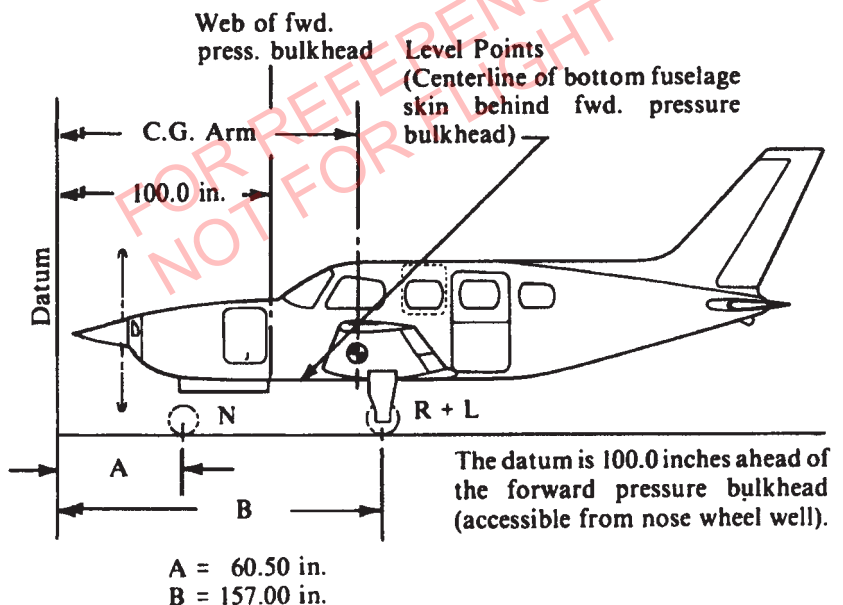

LEVELING DIAGRAM

Figure 6-3

6.3 AIRPLANE WEIGHING PROCEDURE (Continued)

- (2) The basic empty weight center of gravity (as weighed including optional equipment, full oil and unusable fuel) can be determined by the following formula:

$$\text{C.G. Arm} = \frac{N(A) + (R+L)(B)}{T} \quad \text{inches}$$

$$\text{Where: } T = N + R + L$$

6.5 WEIGHT AND BALANCE DATA AND RECORD

The Basic Empty Weight, Center of Gravity Location and Useful Load listed in Figure 6-5 are for the airplane as licensed at the factory. These figures apply only to the specific airplane serial number and registration number shown.

The basic empty weight of the airplane as licensed at the factory has been entered in the Weight and Balance Record (Figure 6-7). This form is provided to present the current status of the airplane basic empty weight and a complete history of previous modifications. Any change to the permanently installed equipment or modification which affects weight or moment must be entered in the Weight and Balance Record.

6.5 WEIGHT AND BALANCE DATA AND RECORD (Continued)

MODEL PA-46-350P MALIBU

Airplane Serial Number _____

Registration Number _____

Date _____

AIRPLANE BASIC EMPTY WEIGHT

Item	Weight x (Lbs)	C.G. Arm (Inches Aft of Datum)	= Moment (In-Lbs)
Standard Empty Weight* Actual Computed			
Optional Equipment			
Basic Empty Weight			

*The standard empty weight includes full oil capacity and 2.0 gallons of unusable fuel.

AIRPLANE USEFUL LOAD - NORMAL CATEGORY OPERATION

$(\text{Ramp Weight}) - (\text{Basic Empty Weight}) = \text{Useful Load}$

$(4358 \text{ lbs}) - (\quad \text{lbs}) = \quad \text{lbs.}$

THIS BASIC EMPTY WEIGHT, C.G. AND USEFUL LOAD ARE FOR THE AIRPLANE AS LICENSED AT THE FACTORY. REFER TO APPROPRIATE AIRCRAFT RECORD WHEN ALTERATIONS HAVE BEEN MADE.

WEIGHT AND BALANCE DATA FORM

Figure 6-5

6.5 WEIGHT AND BALANCE DATA AND RECORD (Continued)

PA-46-350P		Serial Number	Registration Number			Page Number		
Date	Item No.	Description of Article or Modification	Added (+) Removed (-)	Weight Change			Running Basic Empty Weight	
				Wt. (Lb.)	Arm (In.)	Moment /100	Wt. (Lb.)	Moment /100

WEIGHT AND BALANCE RECORD
Figure 6-7

6.5 WEIGHT AND BALANCE DATA AND RECORD (Continued)

PA-46-350P		Serial Number		Registration Number			Page Number	
Date	Item No.	Description of Article or Modification	Added (+) Removed (-)	Weight Change			Running Basic Empty Weight	
				Wt. (Lb.)	Arm (In.)	Moment /100	Wt. (Lb.)	Moment /100

WEIGHT AND BALANCE RECORD (cont)

Figure 6-7 (cont)

6.7 GENERAL LOADING RECOMMENDATIONS

For all airplane configurations, it is the responsibility of the pilot in command to make sure that the airplane always remains within the allowable weight vs. center of gravity while in flight.

The following general loading recommendation is intended only as a guide. The charts, graphs, and instructions should be checked to assure that the airplane is within the allowable weight vs. center of gravity envelope.

- (a) Pilot Only
Load rear baggage compartment first. Investigation is required to determine the amount of forward baggage and fuel.
- (b) 2 Occupants - Pilot and Passenger in Front
Load rear baggage compartment first. Fuel load may be limited by forward envelope.
- (c) 3 Occupants - 2 in front, 1 in rear
Fuel and baggage in nose may be limited by forward envelope.
- (d) 4 Occupants - 2 in front, 2 in rear
Investigation is required to determine optimum fuel and baggage load.
- (e) 5 Occupants - 2 in front, 1 in middle, 2 in rear
Investigation is required to determine optimum fuel and baggage load.
(Note: Placard if installed.)
- (f) 6 Occupants - 2 in front, 2 in middle, 2 in rear
With six occupants, aft passengers weight, fuel and baggage may be limited by envelope. Investigation is required to determine optimum fuel and baggage load. (Note: Placard if installed.)

NOTE

With takeoff loadings falling near the aft limit, it is important to check anticipated landing loadings since fuel burn could result in a final loading outside of the approved envelope.

NOTE

For all airplane configurations, it is the responsibility of the pilot in command to make sure that the airplane always remains within the allowable weight vs. center of gravity envelope while in flight.

Always load the fuel equally between the right and left tanks.

6.9 WEIGHT AND BALANCE DETERMINATION FOR FLIGHT

- (a) Add the weight of all items to be loaded, except fuel, to the basic empty weight to determine zero fuel weight.
- (b) Use the Loading Graph (Figure 6-13) to determine the moment of all items to be carried in the airplane.
- (c) Add the moment of all items to be loaded to the basic empty weight moment.
- (d) Divide the total moment by the total weight to determine the zero fuel weight C.G. location.
- (e) By using the figures of item (a) and item (d) (above), locate a point on the C.G. range and weight graph (Figure 6-15). If the point falls within the C.G. envelope, the loading meets the weight and balance requirements.
- (f) Add the weight of the fuel to be loaded to the total weight calculated for item (a) to determine ramp weight.
- (g) Use the loading graph (Figure 6-13) to determine the moment of the fuel to be loaded and add to the total moment determined for item (c).
- (h) Subtract the weight and moment of the fuel allowance for engine start, taxi, and runup.
- (i) Divide the total moment by the total weight to determine takeoff C.G.
- (j) Locate the takeoff weight center of gravity on the C.G. Range and Weight Graph (Figure 6-15). If the point falls within the C.G. envelope, the loading meets the weight and balance requirements.
- (k) Subtract the Estimated Fuel Burnoff from the Takeoff Weight to determine the Landing Weight C.G.
- (l) Locate the landing weight center of gravity on the C.G. Range and Weight Graph (Figure 6-15). If the point falls within the C.G. envelope, the loading meets the weight and balance requirements.

**6.9 WEIGHT AND BALANCE DETERMINATION FOR FLIGHT
(Continued)**

	Weight (Lb)	Arm Aft of Datum (Inches)	Moment (In.-Lb)
Basic Empty Weight	3156.5	135.33	427169
Pilot and Front Passenger	320	135.50	43360
Passengers (Center Seats)	340	177.00	60180
Passengers (Rear Seats)	140	218.75	30625
Baggage (Forward) (100 Lb Limit)	0	88.60	0
Baggage (Aft) (100 Lb Limit)	80	248.23	19858
Zero Fuel Weight (4123 Lb Max.)	4036.5	143.98	581193
Fuel (120 Gal./720 Lb Max. Usable)	321.5	150.31	48328
Ramp Weight (4358 Lb Max.)	4358	144.45	629520
Fuel Allowance for Engine Start, Taxi, & Runup (3 Gal./18 Lb Max.)	-18	150.31	-2706
Takeoff Weight (4340 Lb Max.)	4340	144.43	626815

The center of gravity (C.G.) for the takeoff weight of this sample loading problem is at 144.43 inches aft of the datum line. Locate this point (144.43) on the C.G. range and weight graph (Figure 6-15). Since this point falls within the weight - C.G. envelope, this loading meets the weight and balance requirements.

Takeoff Weight	4340	144.43	626815
Minus Estimated Fuel Burn-off (climb & cruise) @ 6.0 Lb/Gal.	-258.50	150.31	-38855
Landing Weight	4081.50	144.05	587960

Locate the center of gravity of the landing weight on the C.G. range and weight graph (Figure 6-15). Since this point falls within the weight - C.G. envelope, the loading is acceptable for landing.

IT IS THE SOLE RESPONSIBILITY OF THE PILOT IN COMMAND TO ENSURE THAT THE AIRPLANE IS LOADED PROPERLY AT ALL TIMES.

**SAMPLE LOADING PROBLEM
(NORMAL CATEGORY)**

Figure 6-9

6.9 WEIGHT AND BALANCE DETERMINATION FOR FLIGHT
(Continued)

	Weight (Lb)	Arm Aft of Datum (Inches)	Moment (In.-Lb)
Basic Empty Weight			
Pilot and Front Passenger		135.50	
Passengers (Center Seats)		177.00	
Passengers (Rear Seats)		218.75	
Baggage (Forward) (100 Lb Limit)		88.60	
Baggage (Aft) (100 Lb Limit)		248.23	
Zero Fuel Weight (4123 Lb Max.)			
Fuel (120 Gal./720 Lb Max. Usable)		150.31	
Ramp Weight (4358 Lb Max.)			
Fuel Allowance for Engine Start, Taxi, & Runup (3 Gal./18 Lb Max.)	-18	150.31	-2706
Takeoff Weight (4340 Lb Max.)			

Locate the center of gravity (C.G.) of the takeoff weight on the C.G. range and weight graph (Figure 6-15). If this point falls within the weight - C.G. envelope, the loading is acceptable for takeoff.

Takeoff Weight			
Minus Estimated Fuel Burn-off (climb & cruise) @ 6.0 Lb/Gal.		150.31	
Landing Weight			

Locate the center of gravity of the landing weight on the C.G. range and weight graph (Figure 6-15). If this point falls within the weight - C.G. envelope, the loading is acceptable for landing.

IT IS THE SOLE RESPONSIBILITY OF THE PILOT IN COMMAND TO ENSURE THAT THE AIRPLANE IS LOADED PROPERLY AT ALL TIMES.

WEIGHT AND BALANCE LOADING FORM
(NORMAL CATEGORY)

Figure 6-11

6.9 WEIGHT AND BALANCE DETERMINATION FOR FLIGHT
(Continued)

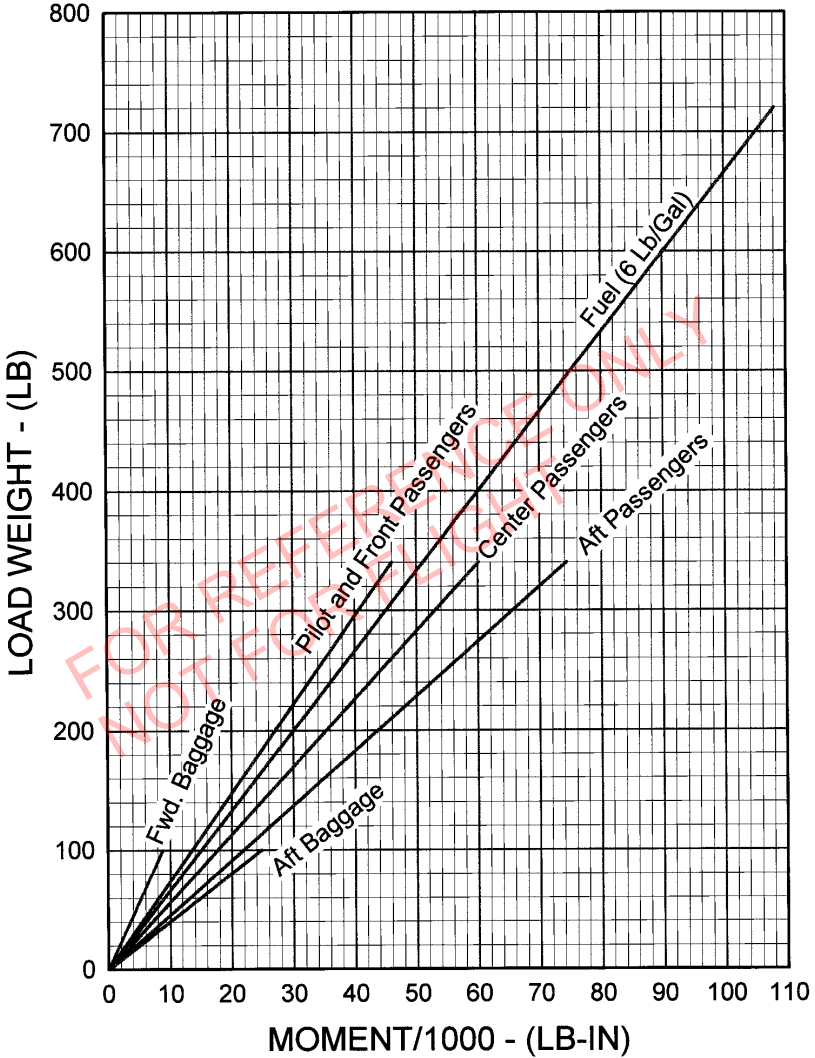

LOADING GRAPH

Figure 6-13

6.9 WEIGHT AND BALANCE DETERMINATION FOR FLIGHT
(Continued)

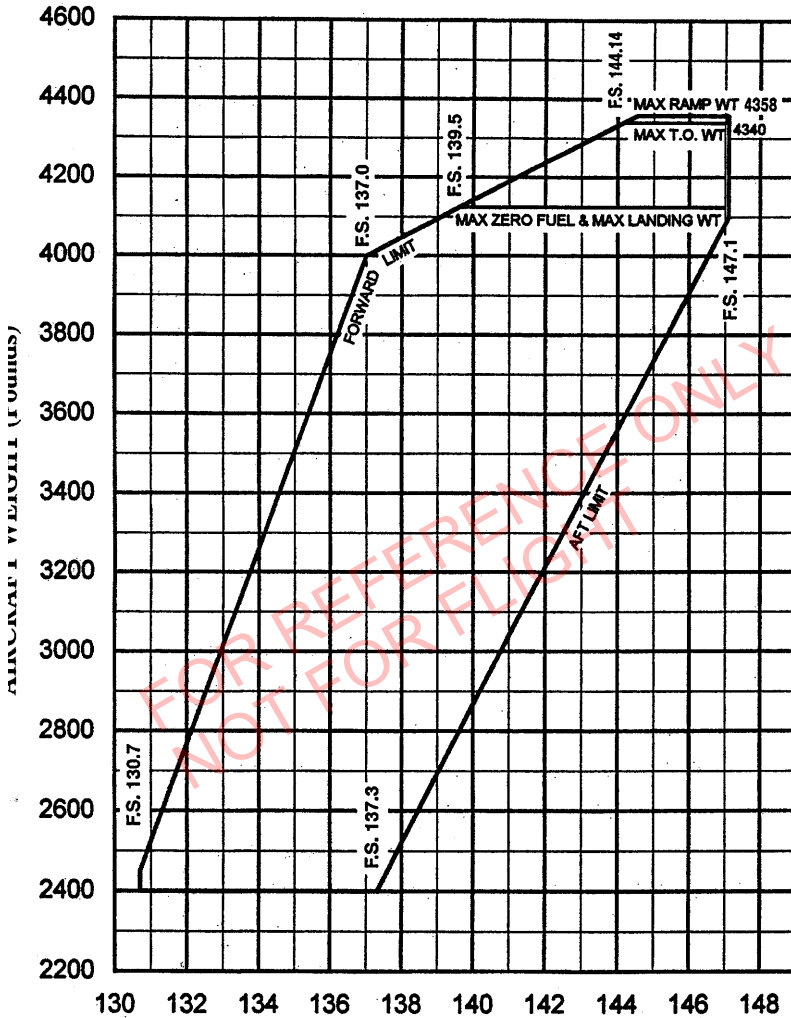

C.G. Location (Inches aft of datum)

C.G. RANGE AND WEIGHT GRAPH

Figure 6-15

TABLE OF CONTENTS

SECTION 7

DESCRIPTION AND OPERATION
OF THE AIRPLANE AND ITS SYSTEMS

Paragraph Page No.	No.	
7.1		The Airplane..... 7-1
7.3		The Airframe 7-1
7.5		Engine and Propeller 7-2
7.6		Air Induction System 7-8
7.7		Engine Controls..... 7-8
7.8		Transicoil Engine Monitoring Inst. System (EMIS) 7-10
7.9		Hydraulic System 7-24
7.11		Landing Gear 7-26
7.13		Brake System..... 7-29
7.15		Flight Control System 7-30
7.17		Fuel System 7-31
7.19		Electrical System..... 7-35
7.21		Instrument Panel..... 7-42
7.23		Pitot Static System 7-46
7.25		Environmental System..... 7-48
7.27		Bleed Air, Conditioning And Pressurization System 7-52
7.29		Vacuum System 7-55
7.31		Cabin Features..... 7-58
7.33		Baggage Area 7-60
7.35		Finish..... 7-60
7.37		Stall Warning..... 7-60
7.39		Emergency Locator Transmitter..... 7-61
7.41		External Power 7-62
7.43		Radar 7-63

SECTION 7
DESCRIPTION AND OPERATION
OF THE AIRPLANE AND ITS SYSTEMS

7.1 THE AIRPLANE

The PA-46-350P Malibu is a single engine, all metal, retractable landing gear, low wing, turbocharged airplane. It has a pressurized cabin with seating for six occupants and two separate luggage compartments.

7.3 THE AIRFRAME

The primary airframe is of aluminum alloy construction, with a steel combination engine mount - nose gear support structure. The nose cowl is also made of aluminum. The rear section of the dorsal fairing is fiberglass.

The fuselage is an all metal, semi-monocoque structure with flush riveted skin. The skin has internally bonded doublers and is butt jointed at all seams not in the airflow direction. There are three basic fuselage sections: the forward baggage section, the pressurized cabin section, and the tail cone section. The cabin section is sealed to maintain pressurization.

The seating arrangement includes two crew seats and four passenger seats. The forward passenger seats face aft, and all passenger seats have adjustable backs with built-in headrests. An inside baggage area is provided aft of the rear passenger seats.

Cabin access is through the main cabin door, located on the left side, aft of the wing. The main door is a horizontally split door with retractable steps in the lower half. The upper half is held open by a gas spring. A plug type, inward releasing, emergency egress door is located on the right side adjacent to the aft facing seat.

Windows include a two-piece windshield, pilot and copilot windows, a storm window in the pilot's window, and three passenger windows on each side.

The forward baggage compartment is unpressurized and has a locking door on the left side, forward of the wing.

7.3 THE AIRFRAME (Continued)

The wing is in effect a three section structure. The center section built-up main spar extends through the lower fuselage and outboard of each main landing gear. This section has a forward spar and a rear spar which are pin jointed at the fuselage sides. The main landing gear retracts inward into recesses located aft of the main spar. The outboard section of each wing, to within approximately 18 inches of the tip, is a sealed integral fuel cell. Portions of the wing structure are adhesively bonded, and skins are butt jointed and flush riveted for a smooth airfoil surface.

The all-metal flaps are electrically actuated through a mechanical linkage. The flaps extend aft and down on three tracks and have four preselect positions.

The all-metal ailerons are mass balanced and operated by a cable system mounted on the aft wing spar.

Tiedown rings are installed on the bottom of each wing outboard of the main landing gear. The rings, which pivot about their forward edge, are spring loaded to retract into the lower wing surface when not in use. When retracted, a small ring protuberance extends below the wing surface. Applying a slight forward pulling force to the protrusion will extend the ring.

The empennage is of conventional fin and rudder, stabilizer and elevator design with aerodynamic and mass balanced control surfaces. Surfaces are of all-metal construction and the single-piece elevator assembly carries a center-mounted trim tab. This tab operates to combine anti-servo and trim functions.

Various access panels on the fuselage, wings and empennage are removable for service or inspection purposes.

Electrical bonding is provided to ensure good electrical continuity between components. Lightning strike protection is provided in accordance with presently accepted practices. Anti-static wicks are provided on trailing edges of ailerons, elevator and rudder to discharge static electricity that might cause avionics interference.

7.5 ENGINE AND PROPELLER

ENGINE

The Malibu is powered by a Textron Lycoming TIO-540-AE2A engine. It is a direct drive, horizontally opposed, overhead valve, fuel injected, air cooled, turbocharged-intercooled engine with variable absolute pressure controller. Maximum rated power is 350 HP 2500 rpm and 42.0 in. Hg.

7.5 ENGINE AND PROPELLER (Continued)

manifold pressure. Accessories include a starter, two magnetos, a propeller governor, two belt driven alternators, two gear driven vacuum pumps, a belt driven air conditioner compressor, an oil filter, and an air/oil separator in the crankcase breather system.

Turbocharging (Figure 7-1) is accomplished by two Garrett - A.I.D. turbo-compressors, one located on each side of the engine. Turbochargers extract energy from engine cylinder exhaust gases and use this energy to compress engine induction air. This allows the engine to maintain rated manifold pressure at altitude. When engine induction air is compressed by the turbocharger, the air temperature is increased. The elevated air temperature is reduced by air intercoolers located on each side of the engine. This aids in engine cooling and improves engine power and efficiency.

Each turbocharger extracts exhaust energy from its respective bank of cylinders to pressurize the induction air. Air flows through the induction inlet louvers into the induction air box, where it is filtered and divided for distribution to the left and right turbo compressors. At the compressor, air pressure and temperature are increased. Pressure increases air density making a greater mass of air available to the engine cylinders on each intake stroke. Air then flows through an intercooler where air temperature is reduced, further increasing the density of air available to each cylinder. Downstream the intercoolers, air flow joins at the "Y" junction of intake tubes at the lower back of the engine, then passes through the fuel injector, into the intake manifold, where it is divided to individual intake pipes flowing to each cylinder. Metered fuel is injected into the cylinder head, upstream of the intake valve. After the fuel burns in the cylinder, exhaust gases flow into the exhaust manifold and then to turbocharger turbines where exhaust energy is extracted to drive the compressor.

Turbo compressed air is throttled across the throttle butterfly valve as set by the throttle lever. A control system monitors pressure and uses engine oil pressure to automatically position the waste gate valve. The waste gate bleeds excess exhaust gas from the exhaust manifold crossover pipe and out the left exhaust stack, bypassing the turbocharger. Thus the controller automatically maintains manifold pressure.

The engine is well protected against overboost damage from excessive manifold pressure. The waste gate controller senses manifold pressure and will continually adjust turbocharger output, maintaining the manifold pressure set by the throttle. The controller automatically protects the engine

7.5 ENGINE AND PROPELLER (continued)

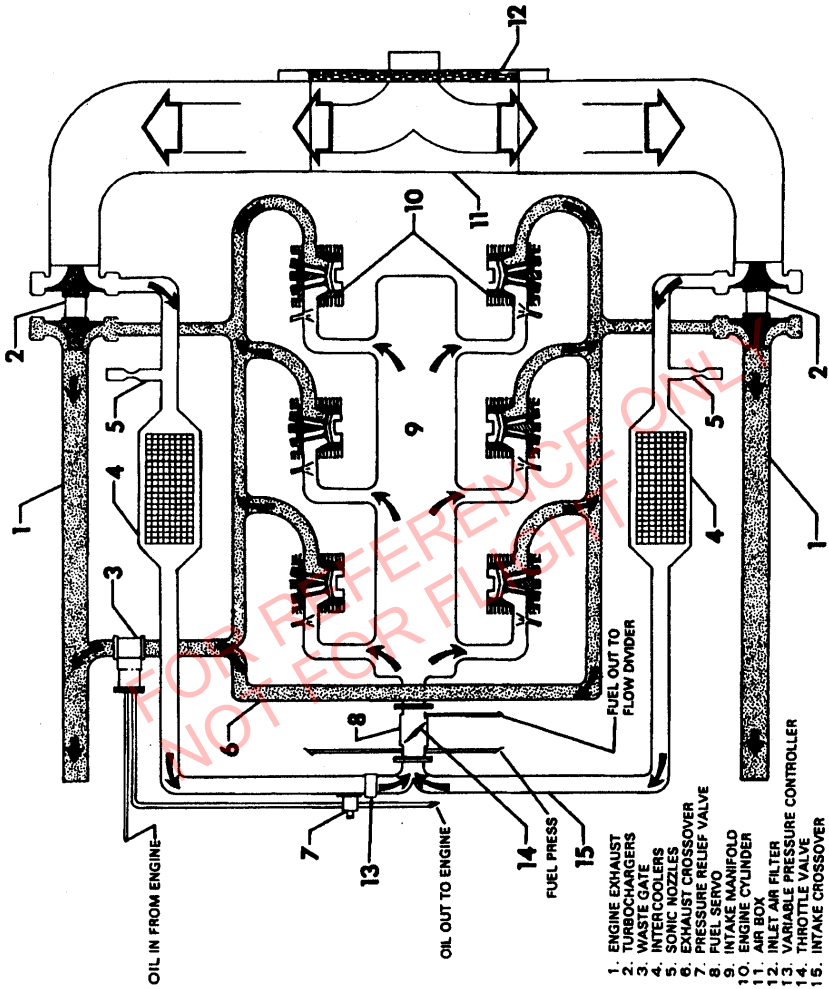

TURBO-INDUCTION SYSTEM

Figure 7-1

7.5 ENGINE AND PROPELLER (continued)

from overboost damage by limiting manifold pressure to 42.0 in. Hg. In the event of a controller malfunction, there is a pressure relief valve on the induction manifold which will relieve manifold pressure and prevent an overboost.

When descending from altitude, care should be exercised to maintain engine power and temperatures (oil, CHT). Turbocharger compressors supply air for cabin pressurization and power reduction below that recommended could cause a decrease in cabin pressure. Sudden cooling or gradual extreme cooling of engine cylinders will accelerate engine wear. Follow normal descent procedures described in Section 4.

The engine is equipped with a Bendix RSA-10ED1 fuel injection system. An engine-driven fuel pump supplies fuel under pressure to the fuel injection regulator, which measures air flow and meters the correct proportion of fuel to a flow divider. The flow divider then directs the fuel to each of the individual cylinder injector nozzles. A fuel vent system provides a common reference vent pressure to the fuel pressure switch, engine-driven fuel pump and injection nozzles. The vent source is taken downstream of the turbochargers to ensure proper vent pressure during turbocharger operation.

The engine employs a full pressure, 12 quart wet sump lubrication system (Figure 7-3). Maximum endurance flights should begin with 12 quarts of oil. The sump is filled through a combination dipstick oil filler cap. Lubricating oil is drawn through the oil sump inlet screen by the engine oil pump and directly to the oil cooler and a thermostatic bypass valve. When engine oil is cold, the thermostatic bypass valve will open allowing oil to flow directly to the full flow oil filter bypassing the cooler. As the oil warms up, the bypass valve will close thereby forcing more oil to circulate through the cooler prior to entering the oil filter. From the oil filter, the oil passes through an oil pressure relief valve which regulates system oil pressure. The regulated oil is then routed to the waste gate actuator, turbochargers, and through the main oil galleries to the various engine bearings, piston oil cooling nozzles, valve mechanisms, and moving parts. Gravity returns the oil to the sump.

The turbochargers are also lubricated by the regulated oil from the engine system. Oil circulated through the turbochargers is returned to the sump by a scavenge pump attached to the hydraulic pump accessory pad. Oil from the oil pump is also supplied directly to the waste gate control system.

7.7 ENGINE CONTROLS (Continued)

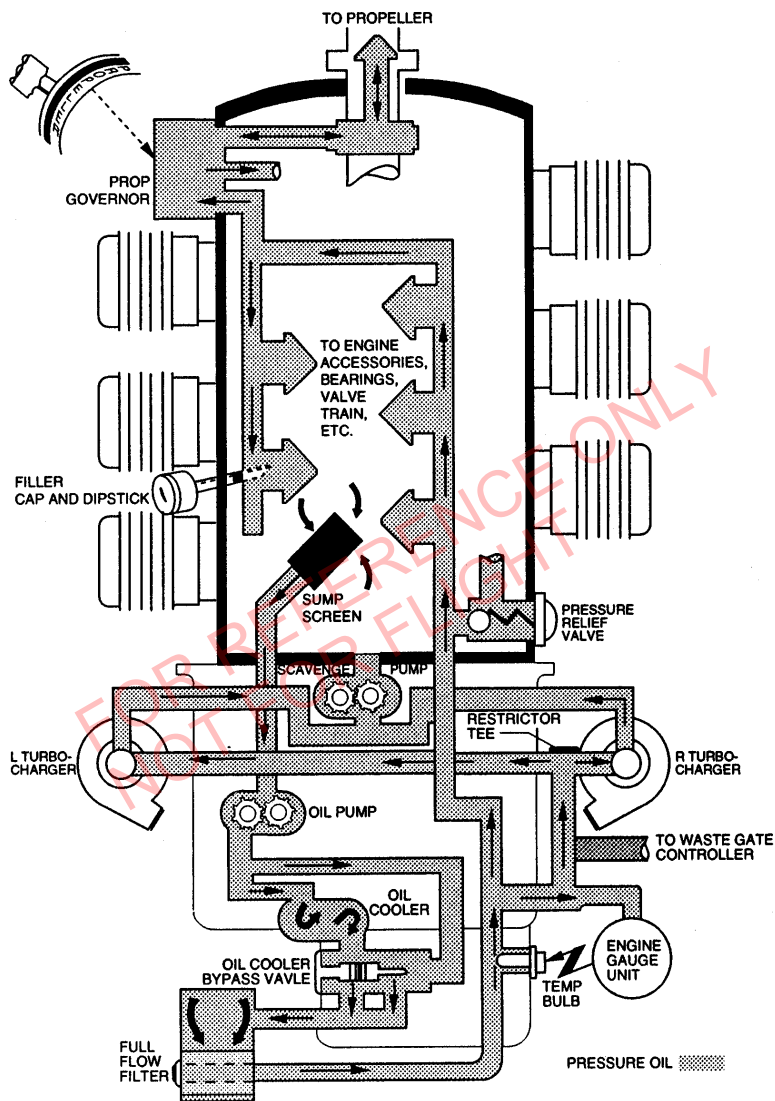

ENGINE OIL SYSTEM SCHEMATIC

Figure 7-3

7.5 ENGINE AND PROPELLER (Continued)

Oil temperature and pressure information is available from separate gauges located as part of the engine gauge stack. Engine crankcase gases are discharged to an air/oil separator behind the left rear cylinder, and then vented out the left exhaust stack.

PROPELLER

The propeller is a Hartzell composite, three blade, constant speed unit with an 80-inch diameter. Constant propeller rotational speed (rpm) is maintained by a balance of air load and engine rotational forces. The Hartzell propeller governor, mounted on the left front of the engine, pressurizes and regulates the flow of engine oil to a piston in the propeller dome. The piston is linked by a sliding rod and fork arrangement to propeller blades. Governor oil pressure against the piston works to increase propeller blade pitch, thus decreasing propeller and engine rpm. Centrifugal twisting moments on the propeller blades work to decrease propeller blade pitch and increase rpm. Simple control of the interaction of these and other forces to maintain a constant rpm is provided by the propeller control lever in the cockpit.

The propeller control lever, linked by cable to the propeller governor, determines a wide range of in-flight rpm. Governor range is more limited during ground operation. Pushing the lever forward selects increased or higher rpm. Pulling the lever aft selects decreased or lower rpm. When in flight the rpm should not fluctuate significantly from that set, regardless of throttle setting.

The propeller may be operated within the full range of rpm indicated by the tachometer, up to the red radial line. In cruise, always use the power setting charts provided. Avoid exceeding maximum rpm and excessive engine stress by moving propeller and throttle levers in smooth deliberate motions. On cold days during run-up, exercise the propeller several times to flow warm oil into the propeller hub. This assures propeller governing for takeoff.

7.6 AIR INDUCTION SYSTEM

CAUTION

Alternate air is unfiltered. Use of alternate air during ground or flight operations when dust or other contaminants are present may result in engine damage from particle ingestion.

7.6 AIR INDUCTION SYSTEM (Continued)

The engine air induction system receives ram air through forward facing ram air louvers located on the lower cowl below the propeller. Air enters these louvers and flows through a removable air filter mounted adjacent to the louvers. The filter removes dust and other foreign matter from the induction air. However, in the event the ram air louvers or the filter should become obstructed by ice or other causes, the pilot must manually select alternate air to provide air to the engine. This alternate air control is located on the center console just below engine control quadrant. When the induction air lever is up, or on primary air, the engine is operating on filtered air drawn through the forward facing ram air louvers. When the lever is down, or on alternate air, the engine is operating on unfiltered air, drawn through the aft facing louvers immediately aft of the ram air louvers. Since the alternate air bypasses the air filter, alternate air should never be used during ground operations, except for checking its operation.

Application of alternate air will result in a loss of manifold pressure when operating with a combination of high altitude and low RPM where the turbocharger wastegate is closed. Loss of manifold pressure of up to 8 inches Hg can result at maximum continuous power, with a possible greater reduction resulting at cruise power settings. Some of this manifold pressure loss may be recovered with throttle and / or RPM adjustment.

7.7 ENGINE CONTROLS

The engine is controlled by throttle, propeller and mixture control levers, located on the control quadrant on the lower central instrument panel (Figure 7-5). The controls utilize teflon-lined control cables to reduce friction and binding. The throttle lever is used to control engine power by simultaneously moving the butterfly valve in the fuel-air control unit and the variable absolute pressure controller, thus adjusting manifold pressure. The throttle lever incorporates a gear-up warning horn switch, which is activated during the last portion of travel of the throttle lever to the low power position. If the landing gear is not locked down, the horn will sound until the gear is down and locked, or until the power setting is increased. This is a safety feature to warn the pilot of an inadvertent gear-up landing. All throttle operations should be made with a smooth, deliberate movement to prevent unnecessary engine wear or damage and to allow time for the turbocharger speed to stabilize.

7.7 ENGINE CONTROLS (Continued)

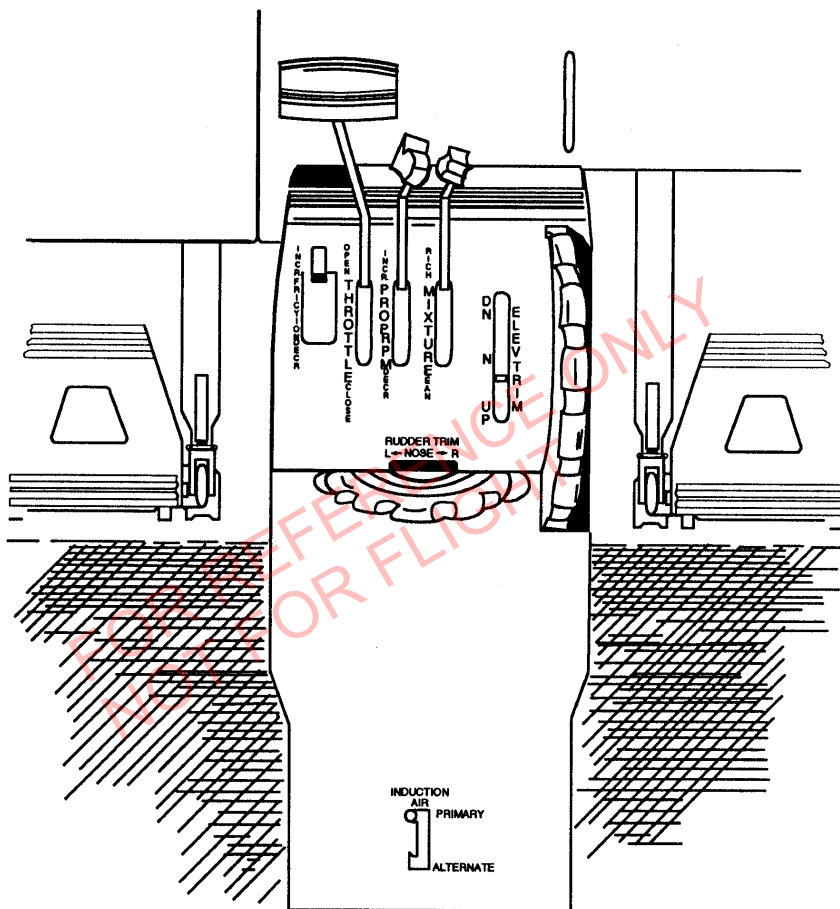

CONTROL PEDESTAL

Figure 7-5

7.7 ENGINE CONTROLS (Continued)

The friction adjustment lever, located on the far left of the control quadrant, may be adjusted to increase or decrease the friction holding the throttle, propeller and mixture controls.

The propeller control lever is used to adjust engine speed (rpm) at the propeller governor. Propeller speed controls power availability, which is increased by increasing rpm when the lever is moved forward. The lever is moved aft to reduce rpm. Propeller operations should be smooth and deliberate to avoid unnecessary wear.

The mixture control lever is used to adjust the fuel-to-air ratio at the fuel-air control unit. Full forward is rich mixture. Normal engine shutdown is accomplished by placing the mixture in the full aft position.

7.8 TRANSICOIL ELECTRONIC MODULE INSTRUMENT SYSTEM (EMIS)

The Transicoil Electronic Module Instruments System (EMIS) is a precision microprocessor based instrument with analog and digital format displays of engine related instruments (see Figure 7-7). The EMIS can be divided into two parts: 1) The enhanced digital indicator (EDI) display and 2) the dual analog instrument modules.

The EDI contains two liquid crystal displays (LCD) with three lines each for display. In the instrument mode, the top line is dedicated to engine manifold pressure and RPM, while the middle line will digitally display a selected analog indicator reading. The LCD's are backlit for use in low ambient light conditions and contain heaters for low temperature operation.

Below the EDI is a vertical stack of dual analog instrument modules, which display (going top to bottom/left to right), Manifold Pressure (MAP), Propeller (RPM), Turbine Inlet Temperature (TIT), Fuel Flow (FF), Oil Temperature (OT), Oil Pressure (OP), Cylinder Head Temperature (CHT), Vacuum System Pressure (VAC), and Left/Right Fuel Quantity (F QTY). Each indicator displays its respective engine parameter on the analog dial and provides digital data for the EDI. The face of each analog instrument consists of a parallax free dial, a select button, and two status lights. Pressing the select button of a particular analog indicator causes that parameter to be digitally displayed in the middle line of the EDI and its corresponding green status light to illuminate.

Each analog indicator also has a red status light which illuminates when a red line limitation exceedance has occurred. Each fuel quantity indicator has an amber "low fuel" status light in place of red, which illuminates with 5 gallons or less of usable fuel indicated.

The enhanced digital indicator (EDI) has the capability to display the following modes of operation.

1. Instrument Mode
2. % Power Mode
3. Fuel Posting Mode
4. Fuel Loading Mode
5. Exceeding Review Mode

During normal operation, the following sequence of events will be initiated during power up to verify proper operation. First an automatic self test sequence is initiated by the EDI. This consists of:

1. All analog indicators in each module will be driven clockwise to the 9 o'clock position for approximately 7 seconds.
2. All analog indicator status lights (red/yellow and green) will illuminate.
3. All external alarms will be activated for about 2 seconds at the end of the self-test cycle.
4. All active segments of the EDI Digital Displays will be energized. Note: The last digit of the RPM display is a fixed zero.

If the operator wants to bypass the self-test sequence on a particular indicator, the associated select button may be pressed and released as the analog pointer reaches the 9 o'clock position. The selected indicator(s) will display current sensor readings while the rest of the EMIS stack will complete the self-test cycle.

After initial system power up, an indicator self-test can be performed by pressing the adjacent select button of the indicator for two seconds. The indicator's pointer will drive to 9 o'clock and both status lights will illuminate. Continue to press the select button (approximately 5 additional seconds) and the audible alarm will sound. The audible alarm will remain activated until the select button is released. During this test the digital display will continue to display the actual indicator value.

7.8 TRANSICOIL ELECTRONIC MODULE INSTRUMENT SYSTEM (EMIS) (CONT'D)

After the self-test is complete, the EDI will automatically display the MAP, RPM, TIT, FF and OAT in the LCD windows. NOTE: Any exceedances that have previously been recorded must be called up manually by the operator.

To post the digital reading of a different analog instrument, momentarily press the select button adjacent to that analog indicator. The selected analog indicator will have its "GREEN" status light illuminated. The left and right analog indicators can only be posted in their corresponding middle left and middle right EDI digital displays. The EDI digital display can be "blanked" at the operators discretion by pressing the "BLK" button located on the EDI display unit. To exit this mode, select any analog indicator from the EMIS system stack or select any other function (fuel management, % power, etc.)

Note:

Since the push button designated for blanking the display has secondary functions during the limitation exceedance review, fuel management mode and fuel loading mode, the display blanking function is disabled during these modes of operation.

Note:

If an exceedance occurs, the blank mode will end and the exceedance will automatically be posted.

Prior to engine start, a new fuel loading can be entered into the EDI by selecting the fuel posting mode. This is done by pressing the "S" button on the left side of the display. Once in the fuel posting mode, enter the fuel loading mode by simultaneously pressing the "S" and "Up Arrow" buttons (Figure 7-15 and 7-17). The digital display will show "000" or present fuel remaining with the left most digit flashing. Pressing the "UP ARROW" button will increment the flashing digit up while the "DOWN ARROW" will increment the flashing digit down. Pressing "T" button will toggle between flashing parameter digits. This sequence is repeated until the new fuel loading is displayed in the EDI window. To enter this fuel load into memory, depress the "S" button on the left side of the display. At this point the EDI will return to the fuel posting mode automatically.

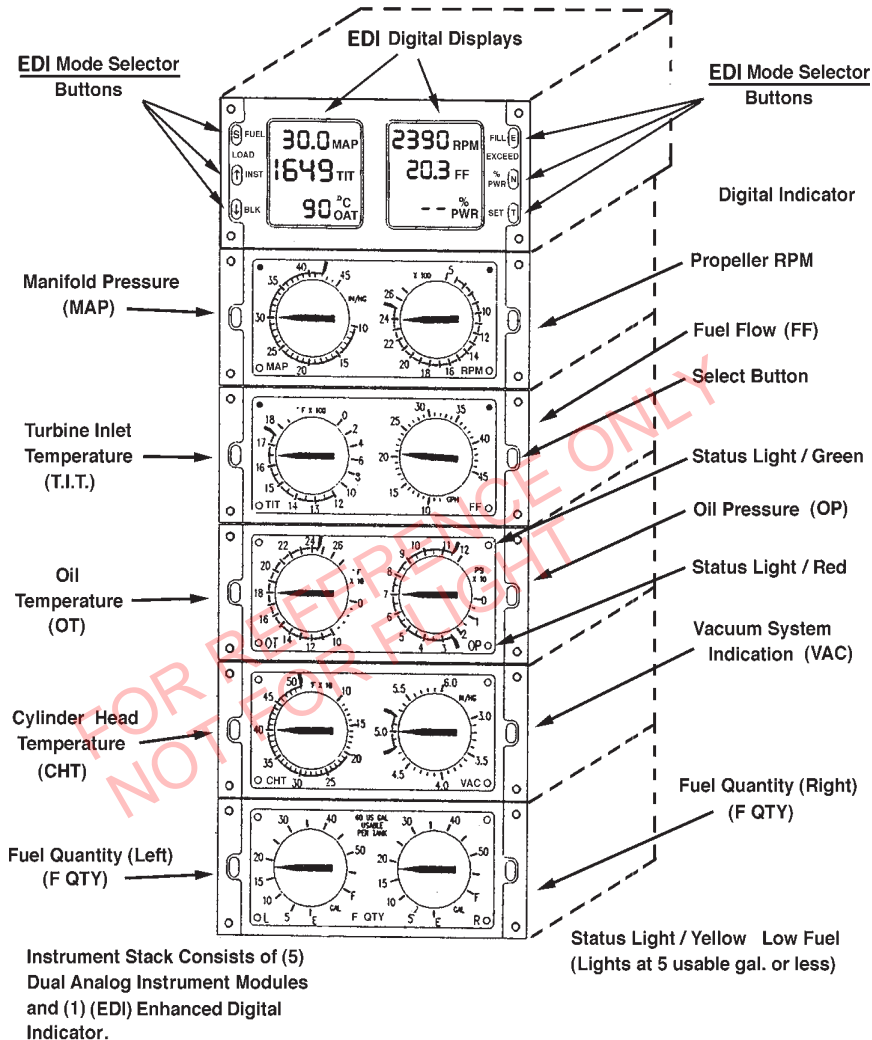

FIGURE 7-7
Transicoil Electronic Module Instrument System (EMIS)

**7.8 TRANSICOIL ELECTRONIC MODULE INSTRUMENT SYSTEM
(EMIS) (CONT'D)**

Note:

During fuel loading entry sequence, the three digits must display 120 gallons or less at all times to permit fuel load entry into the EDI.

If the fuel tanks are filled to max capacity (120 gallons usable), the pre-set full fuel value can be entered by depressing the "E" button while in the fuel entry mode (Figure 7-17).

To manually enter the fuel posting mode, momentarily depress the fuel button located at the top left position of the EDI. If a fuel quantity had been previously entered into the fuel computer, the fuel remaining will be posted in gallons (Figure 7-15). Other parameters shown on this page include, Endurance (ENDUR), Nautical Miles Per Gallon (NMPG), Total Fuel Used (USE), Gallons To Destination (GAL TO DEST) and Gallons At Destination (GAL AT DEST).

Another feature provided by the EMIS is a fuel imbalance monitor. This monitor will illuminate a fuel imbalance light (after 60 second delay) in the annunciator cluster when a difference of 10 gallons is detected between left and right fuel tanks. As soon as the fuel imbalance is corrected, the annunciator will extinguish.

Another feature of the EDI is the percent power mode (Figure 7-13). To enter this mode, momentarily depress the percent power (% PWR) button (middle button on the right side of the EDI). This will bring up the percent power page with the following parameters listed. Manifold Pressure (MAP), RPM, Approximate Fuel Flow (~FF) and Percent Power (% PWR). A desired percent power setting can be chosen by depressing the up and down arrow keys on the left side of the display. The percent power range can be selected from 45% to 80% in 5% increments.

As percent power is changed, a suggested approximate value for manifold pressure and fuel flow will be displayed. If a different RPM is desired, the set button can be depressed to toggle the active parameter to the RPM display, and the up/down arrow buttons can be used to vary the RPM in 100 RPM increments. This variation in RPM changes expected values of MAP and Fuel Flow accordingly. Once the desired percent power and RPM combination are chosen, press the set button until neither parameter is active (flashing). With neither parameter active, the unit can be returned to the instrument mode by pressing the instrument button (INST).

As part of the instrument mode, the outside air temperature (OAT) is displayed in the lower left. This temperature display can be cycled from degrees fahrenheit (°F) to degrees Celsius (°C) by momentary selection of the set button located on the lower right of the EDI display.

In addition to engine parameter, OAT, Percent Power and Fuel Management functions, the EMIS Micro Processor provides automatic exceedance warning and exceedance event recording. When a limitation exceedance is detected, the following sequence of events occur:

1. The EDI digital will automatically select that analog indicator and post the peak exceedance value in flashing digits on digital display.
2. The analog indicator "RED" or "AMBER" status light will illuminate and remain on until the unit is no longer in exceedance.
3. An audible alarm will sound and the EDI display will flash until the operator acknowledges each exceedance instrument.

For the duration of the exceedance (up to 10 minutes), the EDI will record the exceedance peak value, average value, and lapse time of the exceedance. If more than one exceedance occurs simultaneously, all will be recorded with only the last exceedance being displayed. The operator must acknowledge each exceedance to mute the audible alarm. Acknowledgement of each exceedance can be random.

Note:

Lower limit exceedance recording and alarms for the VAC vacuum and OP (oil pressure) analog indicators will be suppressed until the engine reaches a speed of 1400 RPM.

7.8 TRANSICOIL ELECTRONIC MODULE INSTRUMENT SYSTEM (EMIS) (CONT'D)

CAUTION:

When the memory for limitation exceedance recording is full, no new exceedancies will be recorded (the memory can accommodate a total of 238 exceedance events for all indicators). It will be necessary for the operator to have a qualified mechanic/technician reset the memory.

Each time a limitation exceedance occurs, the EDI memory records the peak, average, and time duration of the exceedance. The exceedance history is presented in reverse chronological order for each indicator during review.

To enter the limitation exceedance review mode, simultaneously depress both right hand buttons (with the word "EXCEED" between them) on the front of the EDI digital display (Figure 7-19). The operator may exit the limitation exceedance review mode at any time by selecting any analog indicator to display in the EDI. The EDI display will post possible messages during the limitation exceedance review operation:

1. "E Clr" - This message indicates that no exceedancies were found in the limitation exceedance memory.
2. "END ind" - This message indicates that all of the exceedance events for the indicator under examination have been posted.
3. "END ALL" - This message indicates that all of the exceedance events for all indicators have been posted.
4. "END ind" and "E FULL" - These messages indicate that all of the exceedance events for the indicator under examination have been posted and limitation exceedance memory is full.

The push button functions used to review the limitation exceedance events in the exceedance review mode "PEAK DISPLAY" are"

1. Down Arrow - This button will cause the EDI display to post all the exceedance events for the indicator under examination. Each time the down arrow button is pressed, the posted data will change to the next peak exceedance for the same indicator.
2. "N" (Next) - This button allows the operator to manually select another indicator to be reviewed. The "END ALL" message will be posted when all the indicators have been posted. Further depressions will repeat the list.
3. "E" (Exceedance) - This button allows the operator to enter the exceedance review mode average display.

The push button functions used to review the limitation exceedance events in the exceedance review mode "Average Display" are:

1. "E" (Exceedance) - This button will cause the EDI display to post all the average exceedance events for the indicator under examination. Each time "E" is pressed, the posted data will change to the next average exceedance for the same indicator..
2. "N" (Next) - This button allows the operator to manually select another indicator to be reviewed. The "END ALL" message will be posted when all the indicators have been posted. Further depressions will repeat the list.
3. Up Arrow - This button allows the operator to enter the instrument mode display.

7.8 TRANSICOIL ELECTRONIC MODULE INSTRUMENT SYSTEM (EMIS) (CONT'D)

An example of a limitation exceedance review operation would consist of depressing the "E" and "N" buttons simultaneously to enter the review mode for the Peak Display. At this time, two possible display presentations will be posted based on the status of the EDI exceedance memory. If no exceedance data is found, an "E CLR" prompt will be posted in the EDI display. If exceedance data is present, the EDI will post, in the right window, a peak exceedance for the most recent recorded exceedance in memory. The left window of the EDI will display the letter "E" and two numbers. The top number represents the exceedance event for that indicator.

The lower number represents the exceedance event for the indicator. The lower number represents the number of exceedance events that are in memory for that indicator. The analog indicator being interrogated is identified by the RED/AMBER and GREEN status lights flashing. The operation of the analog indicator is not affected during the limitation exceedance review.

Depressing the "E" button will change the display to the average exceedance review mode. In this review mode the right window will display the average exceedance for the indicator being reviewed. The left window will display the exceedance lapse time in seconds above the "SEC" prompt (Figure 7-20). Further depression of "E" will display previous average exceedance events in reverse chronological order. When all of the limitation exceedance events for that indicator have been displayed, the exceedance memory can be posted by depressing the "N" (next button). When all of the limitation exceedance events for all indicators have been posted, the "END ALL" message will appear.

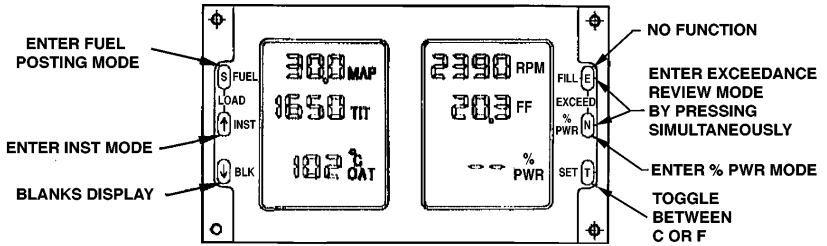

Instrument Mode - Aircraft on the Ground

Figure 7-9

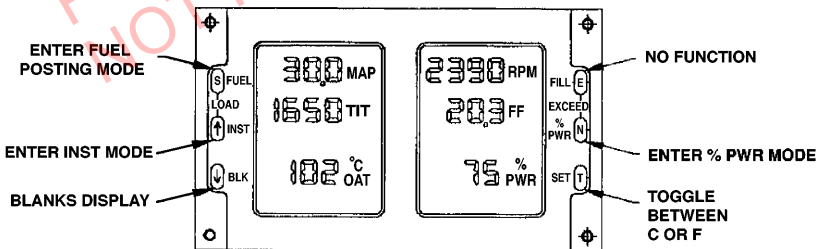

Instrument Mode - Aircraft in Flight

Figure 7-11

7.8 TRANSICOIL ELECTRONIC MODULE INSTRUMENT SYSTEM (EMIS) (CONT'D)

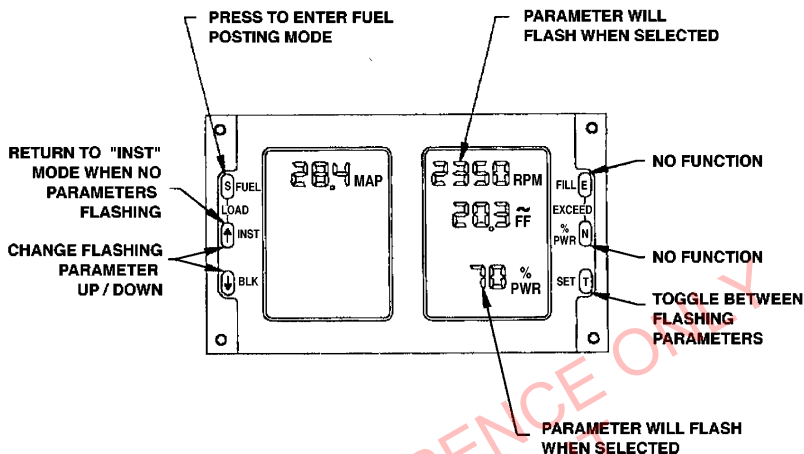

Percent (%) power Mode
Figure 7-13

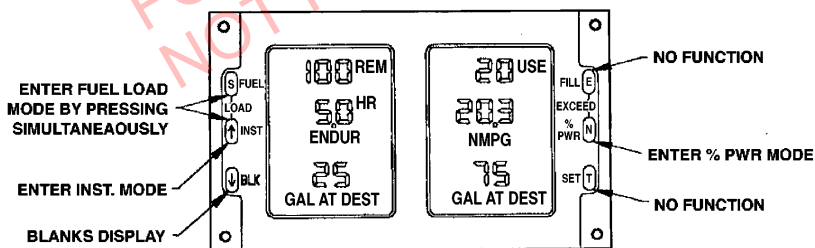

Fuel Posting Mode
Figure 7-15

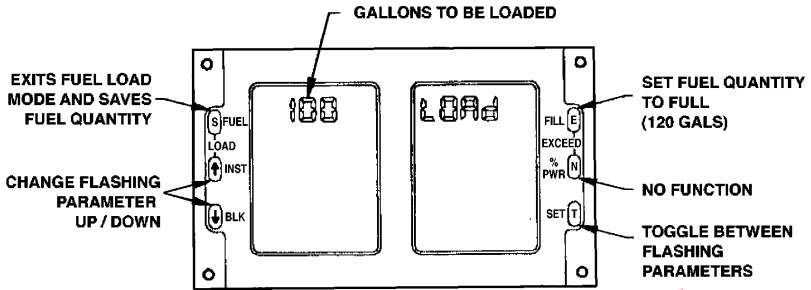

Fuel Loading Mode

Figure 7-17

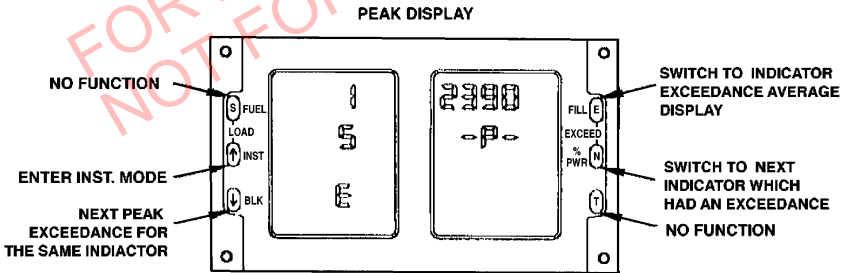

Exceedance Review Mode

Figure 7-19

7.8 TRANSCOIL ELECTRONIC MODULE INSTRUMENT SYSTEM
(EMIS) (CONT'D)

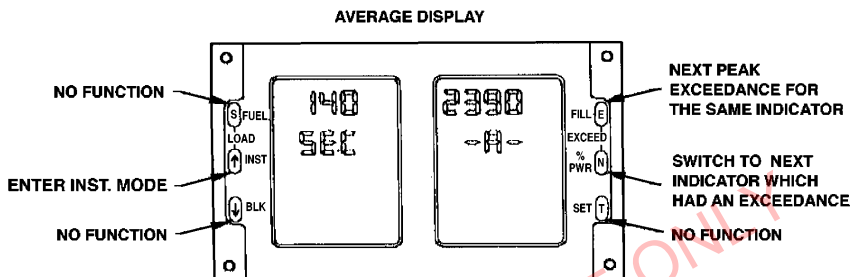

Exceedance Review Mode

Figure 7-20

FOR REFERENCE ONLY
NOT FOR FLIGHT

7.9 HYDRAULIC SYSTEM

The hydraulic system (refer to Figure 7-21) provides the power to retract and extend the landing gear.

The electric motor driven hydraulic pump assembly is located aft of the rear baggage compartment and is accessible through the baggage compartment aft closeout panel. The pump assembly has an integral reservoir with filler plug, sight gauge and vent. The pump assembly incorporates pressure switches, bypass relief valves, and thermal relief valves in both the UP and DOWN sides. A shuttle valve is also incorporated to allow for unequal volumes of hydraulic fluid displaced during UP and DOWN gear actuation. Normal system operating pressure is controlled by the pressure switches. Maximum system operating pressure is limited by the bypass relief valves, and maximum system holding or trapped pressure is limited by the thermal relief valves.

The motor which drives the hydraulic pump is reversible and runs in one direction to supply gear UP pressure and in the opposite direction to supply gear DOWN pressure. The direction in which the pump runs is controlled electrically by the position of the gear selector switch on the instrument panel.

Other major components of the hydraulic system are the three gear actuators and the emergency gear extension valve. Operation of these components is covered in the landing gear section.

7.9 HYDRAULIC SYSTEM (Continued)

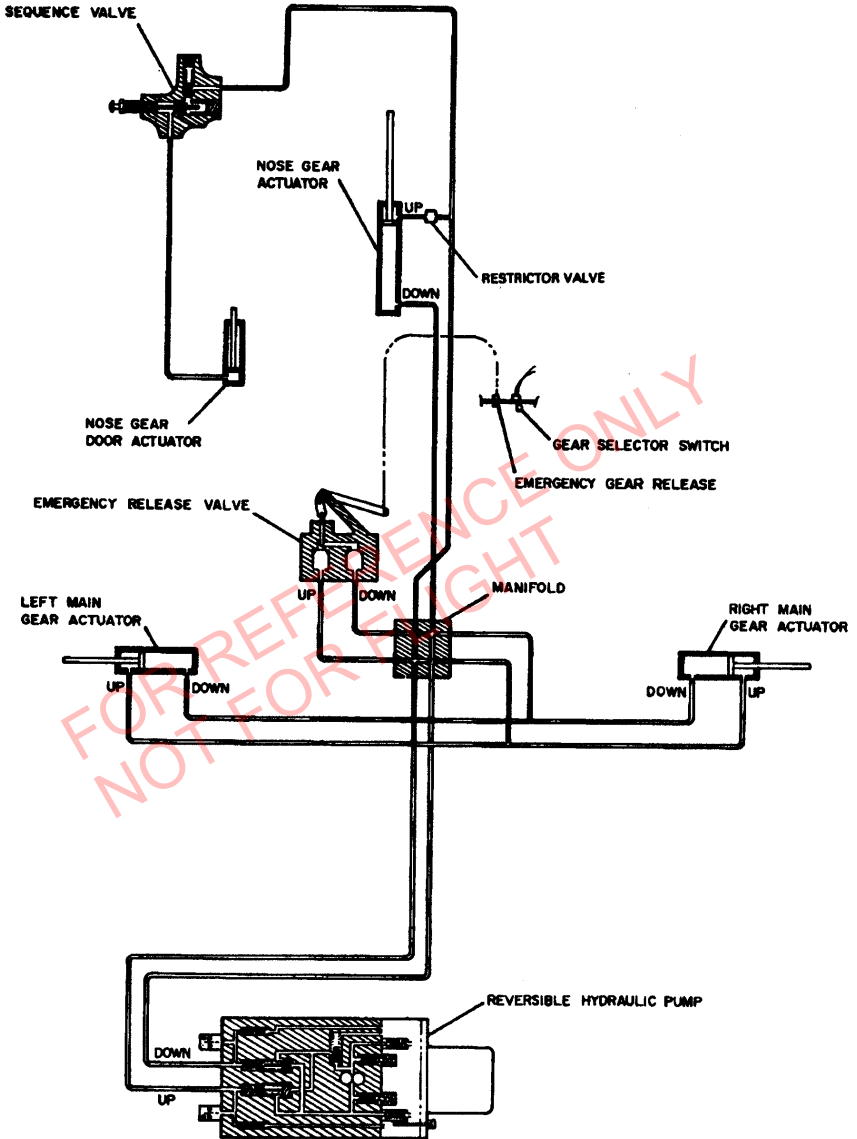

HYDRAULIC SYSTEM

Figure 7-21

7.11 LANDING GEAR

The aircraft is equipped with hydraulically operated, fully retractable, tricycle landing gear.

Locking-type actuators are used for main and nose gears. The actuator assembly provides mechanical gear-down locking at the fully extended position and is hydraulically unlocked. The actuator also acts as the gear brace in the extended position.

The main gear retracts inboard into the wing root area. A mechanically linked door covers the strut assembly.

Hydraulic pressure for gear operation is furnished by an electrically driven hydraulic pump (refer to Figures 7-21 and 7-25). Gear operation is initiated by a two position selector with a wheel shaped knob located to the left of the engine control quadrant (Figure 7-23). Three green lights, which are individually activated as each gear mechanically locks into the DOWN position are located above the landing gear selector.

NOTE

Day/night dimmer switch must be in the DAY position to obtain full intensity of the gear position indicator lights during daytime flying. When aircraft is operated at night, the switch should be in the NIGHT position to dim the gear lights.

The landing gear selector knob must be pulled outward to release it from a detent in the DOWN position prior to moving it to the UP position. In addition, there is a squat switch on the left main gear which prevents operation of the gear UP electrical circuit when the aircraft weight is on the gear. If the landing gear selector is placed in the UP position with the aircraft weight on the gear, the gear warning horn will sound, and the red GEAR WARN annunciator will illuminate.

The landing gear is held in the UP position by hydraulic pressure which is trapped in the system UP lines by a check valve in the pump assembly. When normal pump operation is stopped by the pressure switch, a check valve in the pump assembly closes to trap fluid pressure in the UP side of the system. Emergency gear extension is accomplished by a manually actuated valve which relieves the pressure in the UP side and bypasses fluid to the DOWN side of the system. The additional fluid required for DOWN operation comes directly from the reservoir.

7.11 LANDING GEAR (continued)

The landing gear is held in the DOWN position by spring loaded mechanical locking mechanisms built into each of the three actuating cylinders. The individual gear safe light switches are also mechanically operated when each mechanism is in the LOCKED position. With the hydraulic pump and system operating normally, hydraulic pressure is also trapped in the DOWN side of the system. This DOWN pressure is not required to mechanically lock the cylinders and is not available if the hydraulic pump is inoperative.

The EMERGENCY GEAR extension system allows the landing gear to free fall, with spring assist on the nose gear, into the extended position where the mechanical locks engage. Approximately 25 pounds of force is required to pull the EMERGENCY GEAR extension control. If a gear system malfunction has been indicated and the EMERGENCY GEAR extension system used, it is recommended that the EMERGENCY GEAR extension control and the HYD PUMP circuit breaker be left in the pulled position until the aircraft is safely on jacks. See the Service Manual for proper landing gear system check-out procedures. If the aircraft is being used for training purposes or a pilot check-out flight the EMERGENCY GEAR extension control and HYD PUMP circuit breaker must be reset in order for hydraulic pressure to be generated in the UP side of the system and the gear retracted.



LANDING GEAR SELECTOR

Figure 7-23

7.11 LANDING GEAR (Continued)

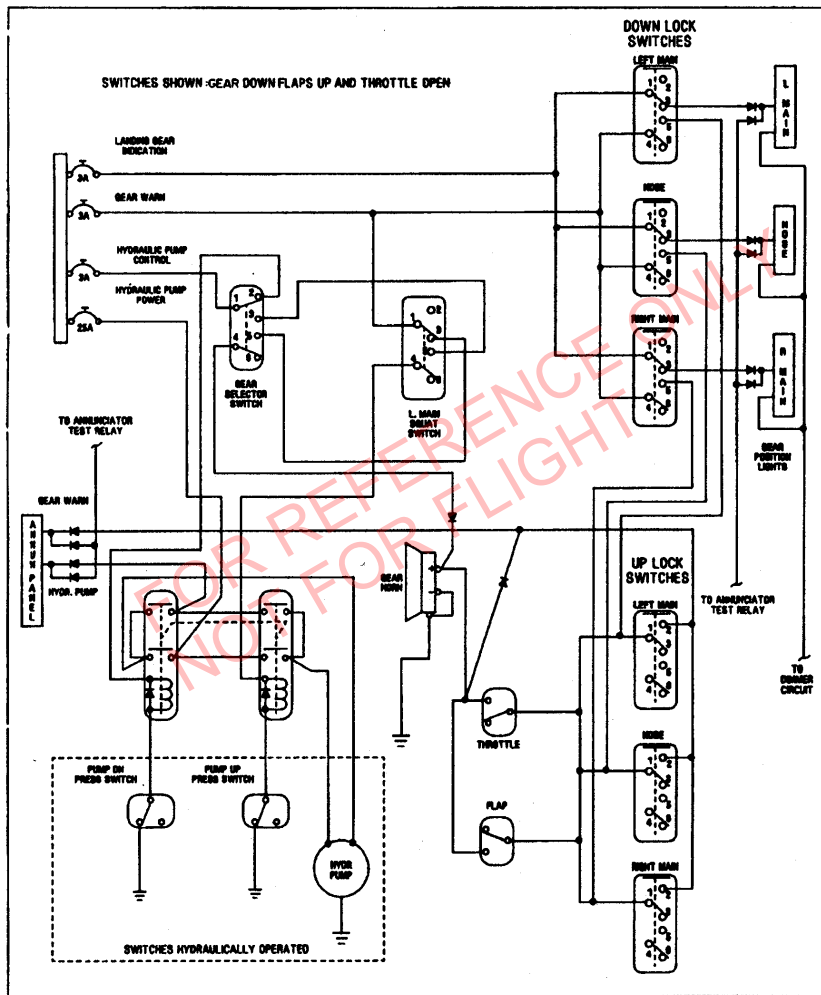

LANDING GEAR ELECTRICAL DIAGRAM

Figure 7-25

7.11 LANDING GEAR (Continued)

CAUTION:

When flying in extreme cold where the aircraft has been cold soaked for hours, the gear may not indicate down and locked for 10 to 15 seconds while aircraft temperatures are stabilizing.

The annunciator panel contains two lights pertaining to landing gear operation. A red GEAR WARN annunciator is activated whenever all three gears are not fully down and locked, or not fully up with the gear doors closed. This annunciator comes on during normal gear operation to indicate that the gear is in transit. If it does not go out within approximately 10 seconds during normal gear operation or illuminates steadily during flight with the landing gear selector in the UP position, a system malfunction is indicated. There is also an amber HYD PUMP annunciator which indicates that the hydraulic pump motor is being supplied with electrical power. The annunciator is illuminated during normal landing gear operation for approximately the same duration as the GEAR WARN annunciator. If the light remains on or begins cycling intermittently after gear operation, a system malfunction is indicated.

The red GEAR WARN annunciator and gear warning horn will operate simultaneously under the following conditions:

- (a) In flight when the throttle is reduced to the point at which manifold pressure is approximately 14 inches of mercury or below and the landing gear are not in the DOWN position.
- (b) In flight when the flaps are extended more than 10° and the landing gear are not in the DOWN position.
- (c) On the ground when the landing gear selector is in the UP position. The landing gear squat switch activates to prevent operation of the retract side of the hydraulic pump on the ground.

7.13 BRAKE SYSTEM

The brake system is designed to meet all normal braking needs. Two single-disc, double puck brake assemblies, one on each main gear, are actuated by toe brake pedals mounted on both the pilot's and copilot's rudder pedals. A brake system reservoir, independent of the hydraulic system reservoir, is located behind the aft access panel in the forward baggage compartment. Brake fluid should be maintained at the level marked on the reservoir. For further information see BRAKE SERVICE in Section 8 of this handbook.

7.13 BRAKE SYSTEM (Continued)

The parking brake knob is located just below the left control column. To set the parking brake, first depress and hold the toe brake pedals and then pull the parking brake knob. To release the parking brake, first depress and hold the toe brake pedals and then push in on the parking brake knob.

7.15 FLIGHT CONTROL SYSTEM

The primary flight controls are conventional and are operated by dual control wheels and rudder pedals. The control wheel operates the ailerons and elevator. The rudder pedals actuate the rudder and nose wheel steering. The toe brakes, which are an integral part of the pedals, operate the wheel brakes. The ailerons and rudder are interconnected through a spring system, which is activated only when controls are out of harmony. In normal coordinated flight, the system is inactive. All flight control systems are operated by closed circuit cable systems.

Secondary control is by elevator and rudder trim. The controls are located on the pedestal (Figure 7-5). Aileron trim is provided by a fixed, ground-adjustable tab. The elevator trim control wheel is located on the right side of the pedestal. The wheel is rotated forward for nose-down trim and aft for nose-up trim. The rudder trim wheel is located on the aft face of the pedestal. The wheel is rotated to the right (counterclockwise) for nose right and left (clockwise) for nose left. Trim indications for the individual systems are located on the pedestal.

The wing flaps are electrically controlled by a selector lever mounted on the instrument panel immediately to the right of the control pedestal. The flap position indicator is located to the left of the selector lever. The flaps may be set to four positions; up (0°), 10°, 20°, and full down (36°). Each position is detented on the flap selector panel. The flaps will automatically move to the selected position, which can be confirmed by referring to the position indicator. The flaps may be extended to 10 at airspeeds below 165 KIAS, 20° below 130 KIAS, and 36° flap extension is limited to airspeeds below 116 KIAS. When extending the flap with the landing gear retracted, prior to the flap reaching the 20° position, the landing gear warning horn will sound, and the GEAR WARN annunciator will illuminate. A FLAPS annunciator light is provided as part of the annunciator panel located in the upper center section of the instrument panel. If the annunciator light illuminates, it is indicative of a system malfunction in which case the flap protection circuit automatically removes power from the electric flap motor. Resetting of the FLAP WARN circuit breaker will restore normal operating power to the flap motor. If, after resetting, and operation of the flaps, the annunciator illuminates again then a system malfunction is indicated and the flap motor circuit breaker should be pulled.

7.17 FUEL SYSTEM

Fuel is stored in two main integral wing tanks (see Figure 7-27), located outboard of the mid-wing splice. Fuel quantity held by each wing tank is 60 usable gallons with one gallon of unusable fuel, for a total of 122 gallons. The minimum fuel grade is 100 or 100LL aviation grade. Each tank gravity feeds fuel through finger screens into three lines leading to collector/sump tanks located at the root of each wing, just aft of the main spar. During preflight the collector/sump tank and one of the three lines can be inspected in each main wheel well. Collector/sump tanks vent back to the main tanks by a fourth line located forward of the main spar. The main tanks vent to the atmosphere by non-icing vents installed in the most outboard forward access panels of each wing tank. Reverse fuel flow from collector tanks to main tanks is prevented by 2 flapper check valves installed in each collector tank. Collector tank sumps are the lowest points in the fuel system, and each has a drain valve for draining collector and main tanks.

WARNING

Avoid prolonged uncoordinated flight to prevent uncovering of fuel tank outlets and subsequent fuel starvation.

Each tank separately vents air in and fumes out to equalize pressure with ambient conditions. This is accomplished through combination valves in non-icing fuel tank vents located at the most outboard, forward tank access panels.

CAUTION

Do not insert objects into the wing vent as damage to the combination valve could result in fuel leakage.

CAUTION

A plugged vent could result in fuel starvation. If a restricted vent is suspected, select the opposite tank immediately. Monitor the suspect wing and land as soon as possible.

NOTE

When opening the fuel tank filler cap, a rush of air will normally be heard and felt. This is caused by the large volume of vapor space in the wing tank, which is under a slight pressure differential. This pressure is the minimum required to open the combination valve in the vent and does not represent a hazard.

7.17 FUEL SYSTEM (Continued)

CAUTION

For proper mid range accuracy, fuel quantity readings should be taken when the aircraft is in coordinated level flight at zero degrees bank angle. (Pitch, roll and yaw.) Failure to observe fuel quantity in this manner will result in erroneous readings due to wing cross section, low dihedral angle and fuel tank geometry.

If readings are taken in configurations other than coordinated level flight at zero degrees bank angle, there may be periods during flight when the accuracy of the fuel quantity gauging system will appear to be incorrect by seeming to present an unchanging quantity in spite of fuel being consumed from the tank.

Fuel quantity is indicated by gauges located at the bottom of the engine gauge stack. Each tank has two sensor sending units. Gauges are electrical and will operate when the battery switch is ON. Fuel tanks can be visually confirmed full if fuel level is up to the filler neck.

NOTE

Removal of the fuel filler cap from a wing tank that is sitting low or from an overfilled tank caused by thermal expansion could result in fuel spillage.

Quantity gauges should be monitored at regular intervals during flight. Fuel tank selection should be alternated accordingly to maintain fuel and wing balance. See fuel imbalance limitations (2.23(e)).

NOTE

Airplane should be fueled symmetrically in a wings level condition. At times, this will require alternate filling of left and right tanks until the full condition is reached.

Each collector/sump tank has a submerged, electrically operated, centrifugal fuel boost pump to suppress fuel vaporization in the fuel lines between the fuel tanks and the engine fuel pump. When the battery master switch is ON, the appropriate boost pump is turned on when the fuel selector is set to the LEFT or RIGHT position. Thus, the boost pump of the selected fuel tank operates continuously during engine start, and normal engine operations on the ground or in flight. Neither pump will operate if the fuel selector is set to OFF, or positioned between the LEFT and RIGHT detents.

7.17 FUEL SYSTEM (Continued)

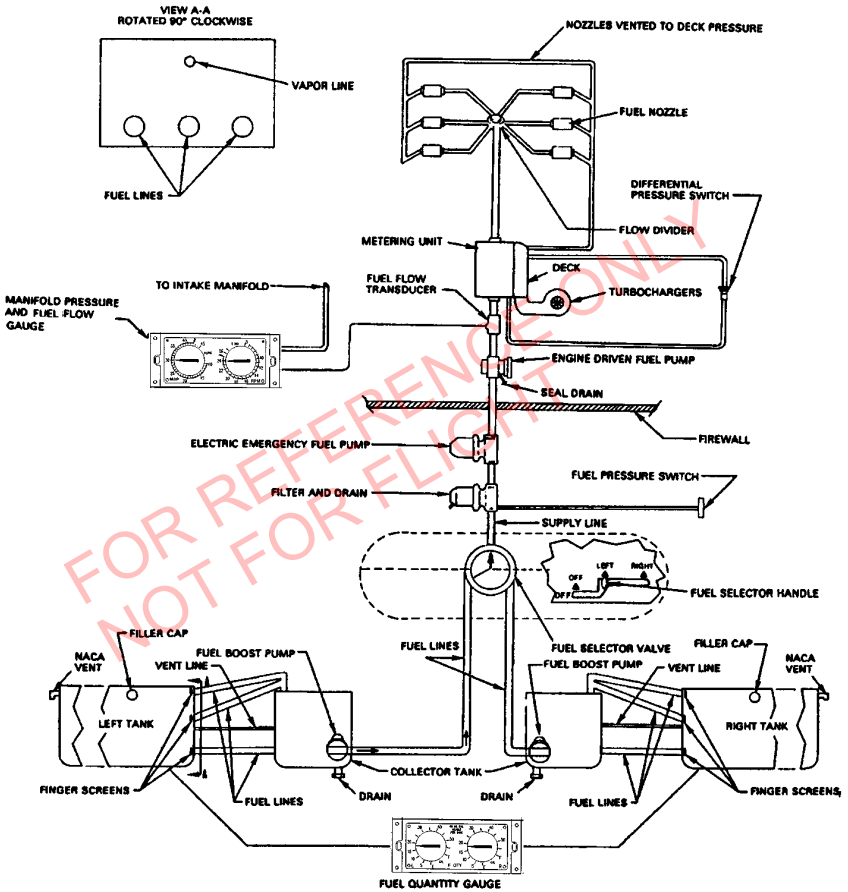

FUEL SYSTEM SCHEMATIC

Figure 7-27

7.17 FUEL SYSTEM (Continued)

Should the fuel boost pump in the fuel tank being used fail to produce sufficient pressure, the BOOST PUMP light on the annunciator panel will illuminate. In this event, confirm that the fuel selector is properly seated in the detent for the selected tank. If the selector is properly seated, and the annunciator remains lit, select the opposite tank. Since there may be difficulty in obtaining the fuel from the tank with the malfunctioning boost pump, a precautionary landing at the nearest suitable airport should be considered to identify and correct the problem.

Should the engine driven fuel pump fail to produce sufficient pressure to sustain engine performance, the FUEL PRESS light on the annunciator panel will illuminate. Immediately select the emergency fuel pump ON. The FUEL PRESS annunciator will extinguish when adequate fuel pressure is restored. The emergency fuel pump should also be turned ON during takeoff and landing.

Fuel leaving the left or right collector/sump tank flows to a selector valve which is located on the right fuselage side behind the copilot's seat in a non-pressurized compartment. All fuel lines passing through the pressurized cabin are metal tubes surrounded by plastic cushion and encased by a second metal tube. This second tube is sealed from the cabin environment to preclude fuel from entering the cabin area or pressurized cabin air from entering fuel lines in the event of a leak.

The selector valve is cable controlled by a thumbsized handle just below the triple indicator for cabin pressurization. The detented selections are OFF, LEFT, RIGHT. LEFT or RIGHT positions direct fuel flow to the engine from the tank selected. To select OFF the fuel selector must be moved to the left tank position, moved down against spring pressure, then moved to the far left, or OFF position.

Fuel flows from the fuel selector forward to the fuel filter located below the baggage floor on the right side. The filter drain is a nylon tube located on the right side of the aircraft, forward of the wing. To drain fuel simply push in the nylon tube. If contaminants clog the filter, an internal relief valve will allow fuel to bypass the filter. This will allow unfiltered fuel to reach the engine and could contaminate the fuel distribution system in the engine.

NOTE

Regular servicing of the filter and examination of fuel samples for contamination is required.

Fuel flows from the filter, forward through the emergency fuel pump and firewall, into the engine compartment, to the engine-driven pump.

7.17 FUEL SYSTEM (Continued)

When beginning flight operations with an equal amount of fuel in each tank, start, taxi, takeoff, and climb on the left tank. When beginning operations with unequal amounts of fuel in each tank, care must be taken not to exceed the fuel imbalance limitations specified in paragraph 2.23(e).

After established in the cruise configuration, the mixture should be leaned. See Section 4 for proper leaning procedure. To maintain lateral balance, it is suggested that alternate tanks be selected in 20 gallon (approximately 60 minute) increments, thus requiring minimal aileron force to keep the wings level. In any case, the fuel imbalance limitations in Section 2 must not be exceeded. The pilot must monitor the fuel gauges and switch tanks as required. Fuel cannot be used from both tanks at the same time.

7.19 ELECTRICAL SYSTEM

Power for the 28 Vdc, negative ground, dual fed split bus electrical system (Figure 7-29) is supplied by two belt driven, parallel connected, 28 Vdc 75 ampere self exciting alternators mounted on the forward section of the engine. When both alternators are operating and turned ON, a maximum continuous output of 150 amps is available. A 24 Vdc, 10 ampere hour lead acid battery, located beneath the left floor panel of the forward baggage compartment, provides power for engine starting. The battery also serves as a source of emergency electrical power in the event both alternators fail. The battery is vented to the atmosphere via an acid recovery system.

Electrical switches are located in one of three switch panels:

- (a) A main switch panel (Figure 7-31) located on the overhead switch panel.
- (b) Avionics related switches (Figure 7-33a) are located on a bezel around the pilots attitude indicator and HSI.
- (c) A switch panel located above the right radio stack contains all deice / anti-ice and environmental control related switches. (Figure 7-33b)

A battery bus, located in the battery compartment, provides a continuous source of power for the digital clock, ELT switch, ground clearance, forward baggage compartment light, and aft cabin courtesy light. Because the battery bus is connected directly to the battery, power is available for these functions even when the Battery Master switch is OFF. Fuses located on the battery bus are used to protect these circuits.

7.19 ELECTRICAL SYSTEM (Continued)

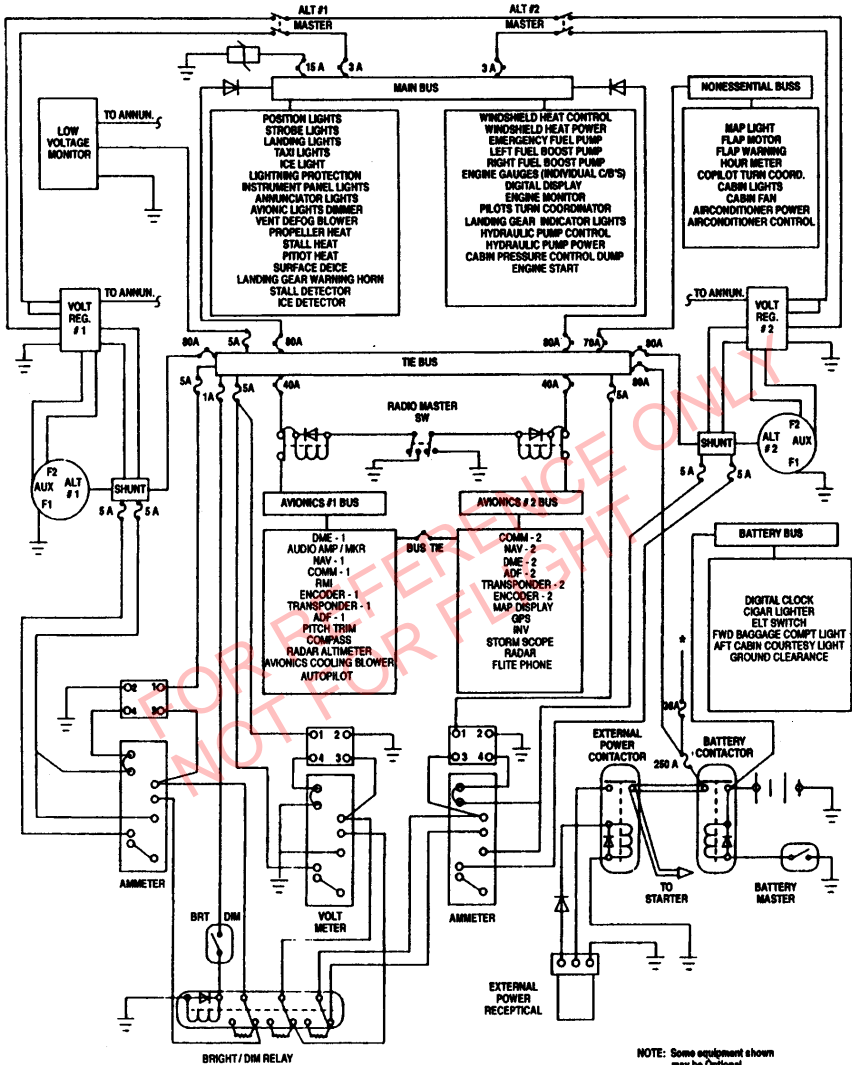

ELECTRICAL POWER DISTRIBUTION SYSTEM

Figure 7-29

7.19 ELECTRICAL SYSTEM (Continued)

When the Battery Master switch, located on the main switch panel, is turned ON, the battery solenoid contactor closes, enabling current to flow from the battery to both the starter solenoid contactor and the tie bus located on the lower left section of the pilot's instrument panel (Figures 7-37b and 7-39). Should the airplane's battery be depleted, a receptacle located inside the forward baggage compartment door permits using an external 24 Vdc power supply for engine start. With the Battery Master switch OFF, connecting an appropriate external power source completes a circuit that closes the external power solenoid contactor, permitting current to flow from the external source direct to the starter contactor and the tie bus. Whether using the airplane's battery, or external power, tie bus overcurrent protection is provided by the 80 amp tie bus BATTERY circuit breaker and a 250 amp in line current limiter fuse.

A single 0-30 Vdc voltmeter, located on the lower center section of the instrument panel (Figure 7-39), is connected to the tie bus to indicate battery voltage and system voltage. A low voltage monitor, also connected to the tie bus, will illuminate the LOW BUS VOLTAGE annunciator light when system voltage drops back below 25 +/- 0.3 Vdc. Both units are provided overload protection by independent 5 amp fuses located on the tie bus panel.

NOTE

When utilizing just the airplane's battery, or just a 24 volt external power source, the LOW BUS VOLTAGE annunciator will be illuminated.

Check the voltmeter for correct voltage.

Each alternator system is provided an independent ON-OFF switch, located on the main switch panel, and a solid state voltage regulator that automatically regulates alternator field current. When selected ON, the positive output of each alternator is fed through individual shunts to the tie bus. Overcurrent protection is provided by the 80 amp tie bus ALTR 1 and ALTR 2 circuit breakers. Two ammeters, located on the lower center section of the instrument panel (Figure 7-39), are fed from taps on each shunt resistor, and indicate the individual electrical load of each alternator. Should an overvoltage condition occur in either alternator, its voltage regulator will shut off the field winding voltage of that alternator; thus overvoltage relays are not required. Output from either alternator can be shut off manually by turning that alternator's switch OFF. When either alternator fails, or is selected OFF, the appropriate ALTERNATOR INOP annunciator light will illuminate.

7.19 ELECTRICAL SYSTEM (continued)

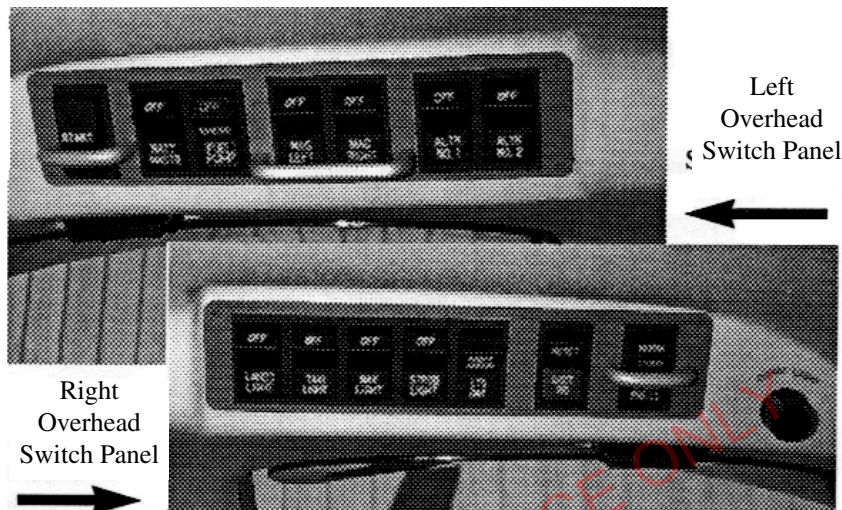

MAIN ELECTRICAL SWITCH PANEL (Overhead)

Figure 7-31

A main bus and a nonessential bus (Figure 7-35), with associated circuit breakers, are located on the pilot's left side panels. Two avionics buses, with associated circuit breakers (Figure 7-37a), are located on the copilot's right side panel. The two avionics buses are interconnected through the avionics bus 25 amp BUS TIE circuit breaker.

Current is fed from the tie bus to the main bus by two conductors. In line diodes prevent reverse current flow to the tie bus. Two tie bus 80 amp MAIN BUS circuit breakers (Figure 7-37b) protect the main bus from an overload.

Current from the tie bus is fed to each avionics bus through independent solenoid contactors. When the Radio Master switch, located on the bezel of the attitude indicator, is selected ON, both solenoid contactors close, permitting current flow to both avionics buses. Avionics bus overload protection is provided by the 40 amp tie bus AVIONICS NO. 1 and AVIONICS NO. 2 circuit breakers (Figure 7-37b). Should the need arise, either avionics bus can be isolated by pulling out the avionics bus BUS TIE circuit breaker and the appropriate tie bus avionics circuit breaker.

The nonessential bus is also fed from the tie bus. Overload Protection is provided by the tie bus 70 amp NON-ESSEN circuit breaker (Figure 7-37b).

7.19 ELECTRICAL SYSTEM (Continued)

Figure 7-33a

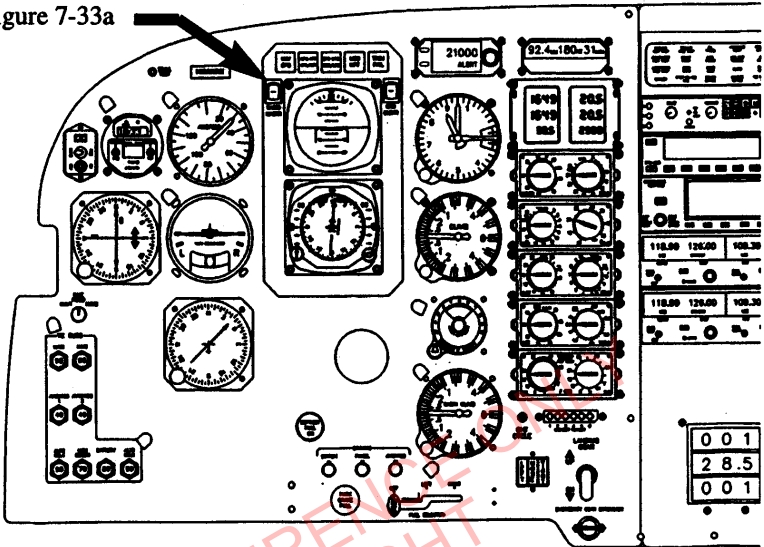
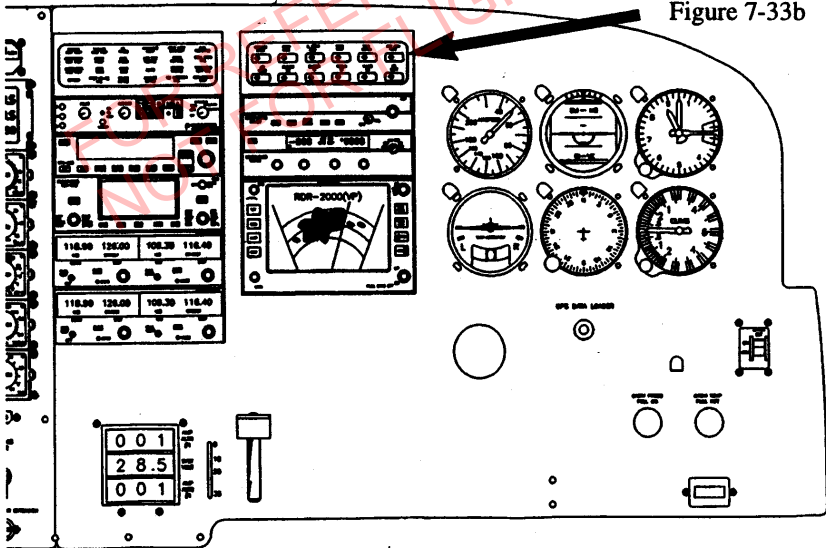
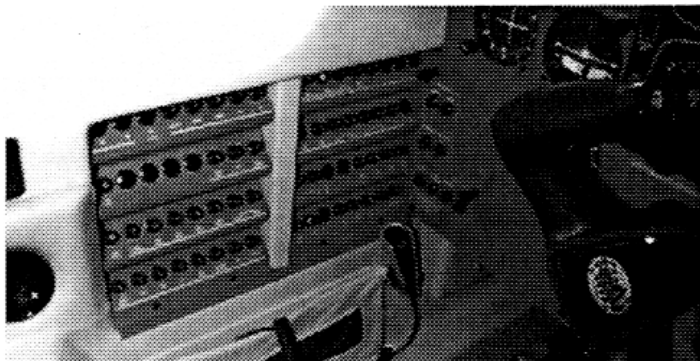

Figure 7-33b



AUXILIARY SWITCH PANELS

7.19 ELECTRICAL SYSTEM (Continued)



FWD Panel

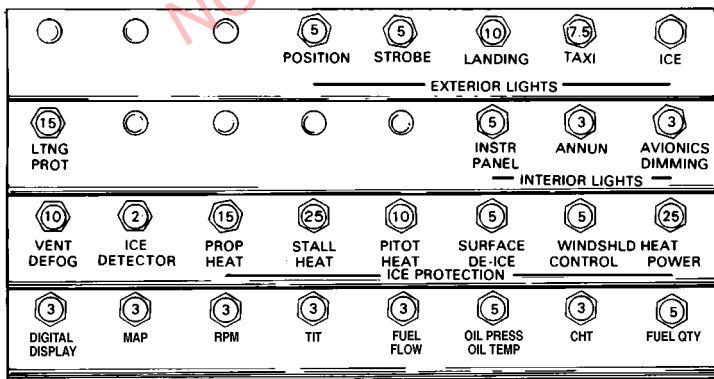
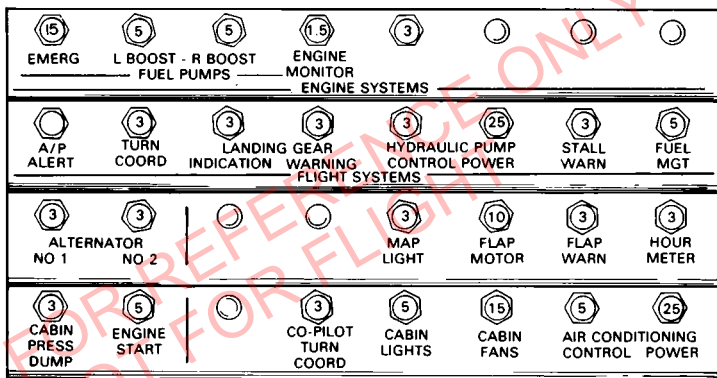

AFT Panel

MAIN AND NONESSENTIAL C/B PANELS

Figure 7-35

7.19 ELECTRICAL SYSTEM (Continued)

Avionics C/B
Figure 7-37a

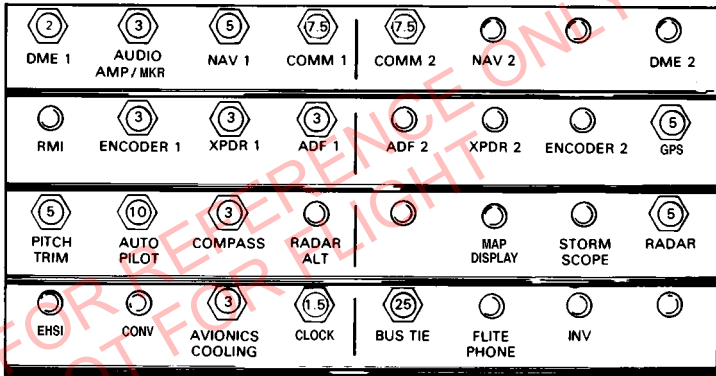
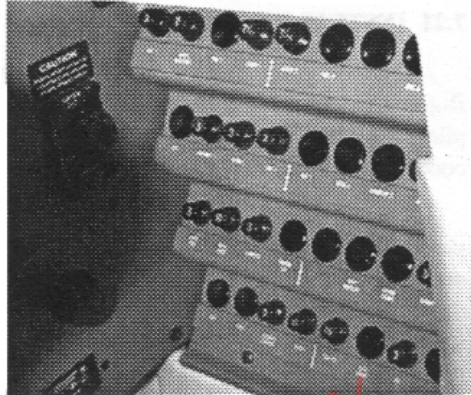

Bus Tie
Figure 7-37b

AVIONICS & TIE BUS - C/B PANELS

Figure 7-37

7.21 INSTRUMENT PANEL

The instrument panel is designed to accommodate the customary advanced flight instruments and the normally required power plant instruments. The pilots artificial horizon is vacuum operated, while the directional gyro and turn coordinator are electrically operated.

A switch panel located at the top of the right radio stack contains all switches for controlling cabin comfort and deice/anti-ice systems. These switches are of the push on, push off type with the exception of the surface deice switch, which is a momentary On switch. For example, when selecting windshield heat from low to high, you must first de-select the low heat switch. Illumination of a green light located in each switch is an indication that the switch is selected on. The pressurization system is controlled and monitored by a cabin pressurization controller and a three-in-one cabin pressure monitoring gauge. This three-in-one gauge provides the pilot with information on cabin rate of climb, cabin altitude, and cabin differential pressure. Both of these are located to the right of the pilots control wheel. The radios are contained in the center section of the panel. The main and non-essential bus circuit breakers are on the left side panels. The tie bus circuit breakers are located on the tie bus C/B panel, located on the lower left side of the pilots instrument panel. Circuit breakers for the avionics busses are located on the right side panel.

A radio master switch is located on the bezel, around the pilots ADI and HSI. In addition to the radio master switch, you can find a switch for ground clearance and optional switching for the Argus, autopilot NAV1/NAV2, radar altimeter and RMI NAV 1/2.

The ground clearance provides direct power to COM #1 and audio without turning on the battery master switch. When the ground clearance switch is engaged, direct aircraft battery power is applied to COM #1 and audio. The switch must be turned off or depletion of the battery could result.

7.21 INSTRUMENT PANEL (Continued)

An annunciator panel, located at the top of the left radio stack. Monitored system includes:

VACUUM NO. 1 INOP, VACUUM NO. 2 INOP, OIL PRESSURE, HYDRAULIC PUMP, PITOT HEAT OFF/INOP, FUEL IMBALANCE, ALTERNATOR NO. 1 INOP, BOOST PUMP, FUEL PRESSURE, LOW BUS VOLTAGE, CABIN ALTITUDE, STALL WARN FAIL, ALTERNATOR NO. 2 INOP, GEAR WARN, DOOR AJAR, FLAPS, STARTER ENGAGE, WINDSHIELD HEAT FAIL, OXYGEN, PROP DE-ICE FAIL, SELECT DE-ICE, SURFACE DE-ICE, ICE DETECT FAIL, and ANNUNCIATOR INOP.

The column of gauges on the right side of the pilot's panel are engine related instruments. This stack is the Transicoil Electronic Module Instrument System (EMIS). From top to bottom they are the EDI digital display, manifold pressure (MAP) propeller RPM, turbine inlet temperature (TIT), fuel flow (FF), oil temperature (OT), oil pressure (OP), cylinder head temperature (CHT), vacuum gauge (VAC) and left and right fuel quantity gauges (FQ). The normal operating range for ground and flight operation is indicated on the instruments by a green arc. Yellow arcs indicate either a takeoff or precautionary range. Red radial lines identify the established maximum or minimum limits. When an instrument needle point touches the edge of the red radial nearest the yellow or green arc, the limit is met. Refer to paragraph 7.8 for complete operating details for the Electronic Module Instrument System.

The EMIS cylinder head temperature gauge displays only the hottest head. All head temperatures are scanned approximately every 9 seconds and the CHT needle flicks at the end of each scan cycle. The lights below the EMIS stack indicate which CHT is currently being displayed. The adjacent push button switch allows the pilot to step through each cylinder to view its current temperature. If power is lost to the scanner the temperature of only the number 3 cylinder is displayed. An optional cylinder head temperature gauge displays all six cylinders simultaneously.

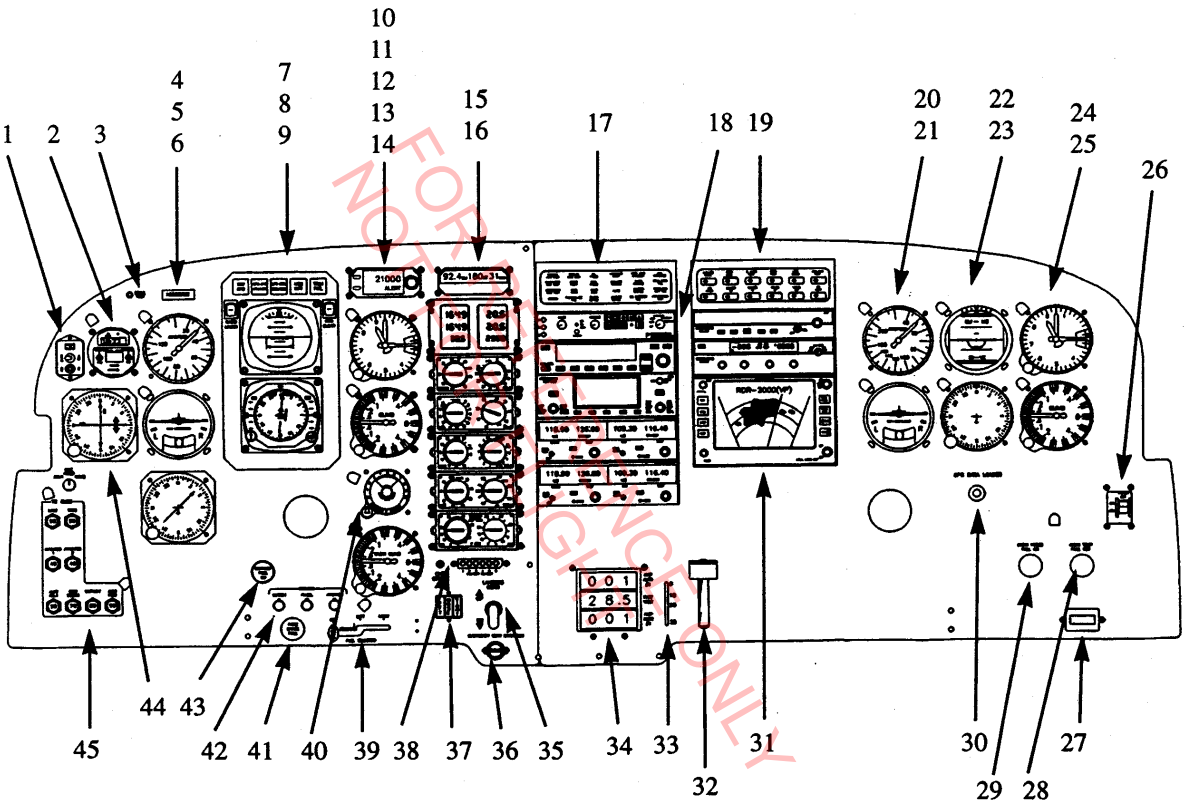

INSTRUMENT PANEL

Figure 7-39

7.21 INSTRUMENT PANEL (Continued)

1. Gyro Slaving Control
2. Digital Clock
3. Stall Test Switch
4. Airspeed Indicator
5. Turn and Bank Indicator
6. RMI/ADF Indicator
7. Avionics Switches
8. Attitude Indicator Flt Director
9. Horizontal Situation Indicator
10. Altitude Preselect
11. Pressure Altimeter (encoding)
12. Vertical Speed Indicator
13. Cabin Pressure Controller
14. Triple Indicator
 - a. Cabin Vertical Speed
 - b. Cabin Altitude
 - c. Differential Pressure
15. DME
16. EMIS Engine Instrument Stack
 - a. EDI
 - b. MAP and RPM
 - c. TIT and Fuel Flow
 - d. Oil Temp. and Oil Press.
 - e. CHT and Vacuum
 - f. Fuel Quantity
17. Annunciator Panel
18. Avionics Installation
19. Environmental Switch Panel
20. Airspeed Indicator
21. Turn and Bank Indicator
22. Attitude Indicator
23. Heading Indicator
24. Altimeter
25. Rate of Climb
26. ELT Switch
27. Hour Meter
28. Cabin Temp. Control
29. Defrost. Control
30. Data Loader
31. Weather Radar
32. Flap Selector
33. Flap Position Indicator
34. ammeter and Voltmeter
35. Gear Selector
36. Emergency Gear Extension
37. Gear Indicator Lights
38. CHT Scanner
39. Fuel Selector
40. Cabin Rate Change
41. Parking Brake Knob
42. Dimmer Controls
43. Cabin Pressure Controller
44. NAV Indicator
45. TIE BUS Circuit Breakers

INSTRUMENT PANEL (cont)

Figure 7-39 (cont)

7.23 PITOT STATIC SYSTEM

Pitot pressure for the airspeed indicator is sensed by a heated pitot head installed on the bottom of the left wing and is carried through lines within the wing and fuselage to the gauge on the instrument panel (refer to Figure 7-39). Static pressure for the altimeter, vertical speed and airspeed indicators is sensed by two static source pads, one on each side of the rear fuselage forward of the elevator. They connect to a single line leading to the instruments. The dual pickups balance out differences in static pressure caused by slight side slips or skids. Static pressure for the pressurization system outflow valve is sensed by a separate static pad located on the aft bottom of the aircraft in close proximity to the alternate static pad.

An alternate static source control valve is located below the instrument panel to the left of the pilot. For normal operation, the lever remains down. To select alternate static source, place the lever in the up position. When the alternate static source is selected the airspeed and altimeter and vertical speed indicator are vented to the alternate static pad on the bottom aft fuselage. During alternate static source operation, these instruments may give slightly different readings. The pilot can determine the effects of the alternate static source on instrument readings by switching from standard to alternate sources at different airspeeds.

If one or more of the pitot static instruments malfunction, the system should be checked for dirt, leaks or moisture. The static lines may be drained by a valve located on the side panel next to the pilot's seat. The pitot system drains through the pitot mast.

WARNING

Do not attempt to drain static system during pressurized flight.

The holes in the sensors for pitot and static pressure must be fully open and free from blockage. Blocked sensor holes will give erratic or zero readings on the instruments.

The heated pitot head, which alleviates problems with icing and heavy rain, is standard equipment and the switch for pitot heat is located on the environmental switch panel. Static source pads have been demonstrated to be non-icing; however, in the event icing does occur, selecting the alternate static source will alleviate the problem.

7.23 PITOT STATIC SYSTEM (Continued)

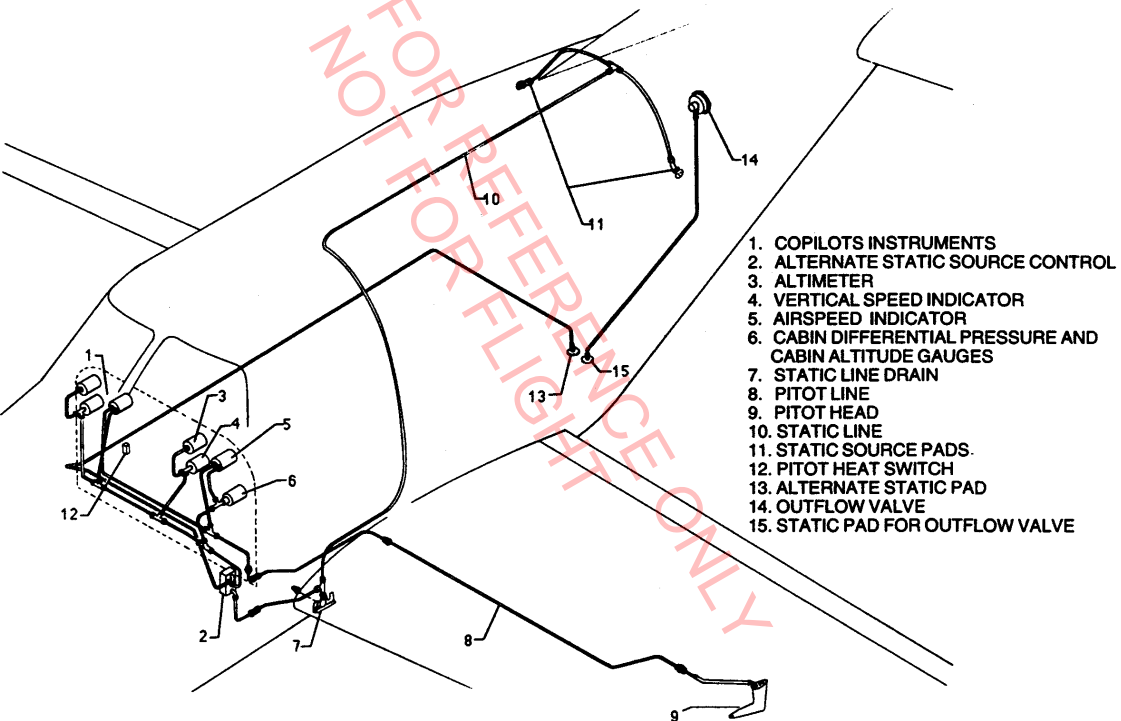

PITOT AND STATIC PRESSURE SYSTEMS

Figure 7-41

7.25 ENVIRONMENTAL SYSTEM (Refer to Figure 7-43)

The environmental system consists of:

- (a) A compressor bleed air and conditioning system.
- (b) The ventilating air system.
- (c) A supplemental electric cabin heater.
- (d) An air conditioning system.
- (e) The cabin air distribution system.
- (f) The pressurization and control system.

Switches and push-pull knobs used to control and regulate the various systems except the pressurization system are located on the right switch panel above the right radio stack.

Compressor bleed air from the engine turbochargers supplies air for heating the cabin during flight and ground operations and for pressurization. The bleed air is first routed through an air-to-air heat exchanger, and then into the cabin through the lower left and right cabin side panel ducts. The heat exchanger utilizes ambient ram air to cool the bleed air, or hot air from an exhaust shroud to heat the bleed air. Desired cabin comfort is maintained by using the CABIN TEMP push-pull knob to manually adjust a flapper type control valve located forward of the firewall. The position of this valve will allow ambient air, or hot air, or a mixture of both, to enter the heat exchanger.

The cabin pressurization system isobaric outflow valve provides the means by which smoke and impurities are vented from the cabin.

Cabin ventilating air during ground or unpressurized low altitude flight operations is provided by the ambient ram air source to the bleed air heat exchanger. An electric vane-axial ventilation/defog blower, located in the left cabin air inlet duct below the forward baggage compartment floor, is used to produce an air flow to the windshield defogger, and to supplement the inflow of ventilating air during ground operations. The blower is activated by selecting the VENT/DEFOG switch ON. Incoming ventilating air can be heated by mixing it with hot air from the exhaust shroud.

NOTE

If electric supplemental heat is not used, maximum cabin heat for ground operations and unpressurized low altitude flight will be obtained with the CABIN PRESS control full out.

The supplemental electric heater consists of a resistance type heat element, a dual hermetically sealed bimetallic type overtemperature protection, a power relay, and a 35 amp in line current limiter fuse. Its function is to provide additional heat for maintaining desired cabin comfort during ground or flight operations under temperature conditions when fully heated bleed air or ventilating air is inadequate. When an external power source is used, the supplemental heater can also be used to preheat the cabin prior to engine start. See Section 2 for limitations on use of the supplemental heater.

The supplemental heater heat element is installed forward of the pressure bulkhead in the left bleed air duct immediately downstream of the ventilation/defog blower. Because the ventilation/defog blower must be operating whenever supplemental heat is used, both the VENT/DEFOG and AUX CBN HEAT switches must be ON to supply power to the heating element.

Both the heater control circuit and the vent/defog fan circuit utilize the 10 amp VENT DEFOG circuit breaker located on the ICE PROTECTION circuit breaker panel. Heater element power is supplied from the battery master solenoid through the 35 amp heater fuse and the heater power relay. The 35 amp heater fuse is not accessible to the pilot. The electrical load imposed by the heater and the vent/defog fan is 40.35 amps. Operation is limited to airplanes with both alternators functioning.

Cabin air conditioning is provided by a vapor cycle system. The freon compressor is belt driven by the engine. Condenser cooling airflow is provided by a continuous duty motor driven fan. Cabin air is recirculated across the evaporators to provide cool air at each seat outlet.

The condenser and its cooling air fan are located in the tailcone immediately aft of the rear pressure bulkhead. Cooling air from outside the tailcone is drawn into the cooling air duct through a flush opening in the skin, routed across the condenser coil, and discharged overboard through the tailcone exit opening.

Two recirculation blowers and evaporator assemblies are located aft of each rear seat below the rear baggage compartment floor. The recirculation blowers draw air into each evaporator coil through grills in the floor structure behind the rear seats and discharges it into the upper left and right cabin side panel ducts. Adjustable eyeball outlets are located at each seat in the airplane.

7.25 ENVIRONMENTAL SYSTEM (Continued)

The AIR COND and BLOWER HI & LO switches, located as part of the environmental switch panel in the center of the instrument panel, are used to control the air conditioning system.

When the AIR COND switch is selected ON, the compressor belt drive is electrically clutched, the condenser blower motor relay is closed, and both recirculation blowers are activated. The recirculation blowers can be operated independently of the air conditioner by selecting the BLOWER HI or LO on. In either situation, the BLOWER switches are used only to select a HI or LO recirculation blower motor speed. When selecting between BLOWER HI and BLOWER LO the switch currently "on" should be deselected to "off" before selecting the other "on". Overcurrent protection is provided by the 10 amp CABIN BLOWERS, 5 amp AIR CONDITIONER CONTROL, and 25 amp AIR CONDITIONER POWER circuit breakers in the nonessential bus section of the pilot's forward circuit breaker panel.

The freon portion of the system incorporates a receiver dryer, a sight gauge, suction and discharge service valves, and 265 psi high pressure and 40 psi low pressure switches. Should the compressor discharge pressure increase above 265 psi, or decrease below 40 psi, the applicable pressure switch will open, disengaging the freon compressor clutch.

The cabin pressurization and control system consists of an isobaric outflow valve, a safety outflow valve, cabin altitude and rate selector, electronically operated vacuum solenoid valve, surge tank, and associated interconnecting plumbing and wiring. Cabin altitude, differential pressure, and rate of change are displayed on a single three inch diameter indicator. Should cabin pressure altitude exceed 10,000 feet, the CABIN ALTITUDE annunciator will illuminate to warn the pilot.

Refer to paragraph 7.27, BLEED AIR, CONDITIONING AND PRESSURIZATION SYSTEM, for a more complete description of the pressurization system and use of related controls and switches.

7.25 ENVIRONMENTAL SYSTEM (Continued)

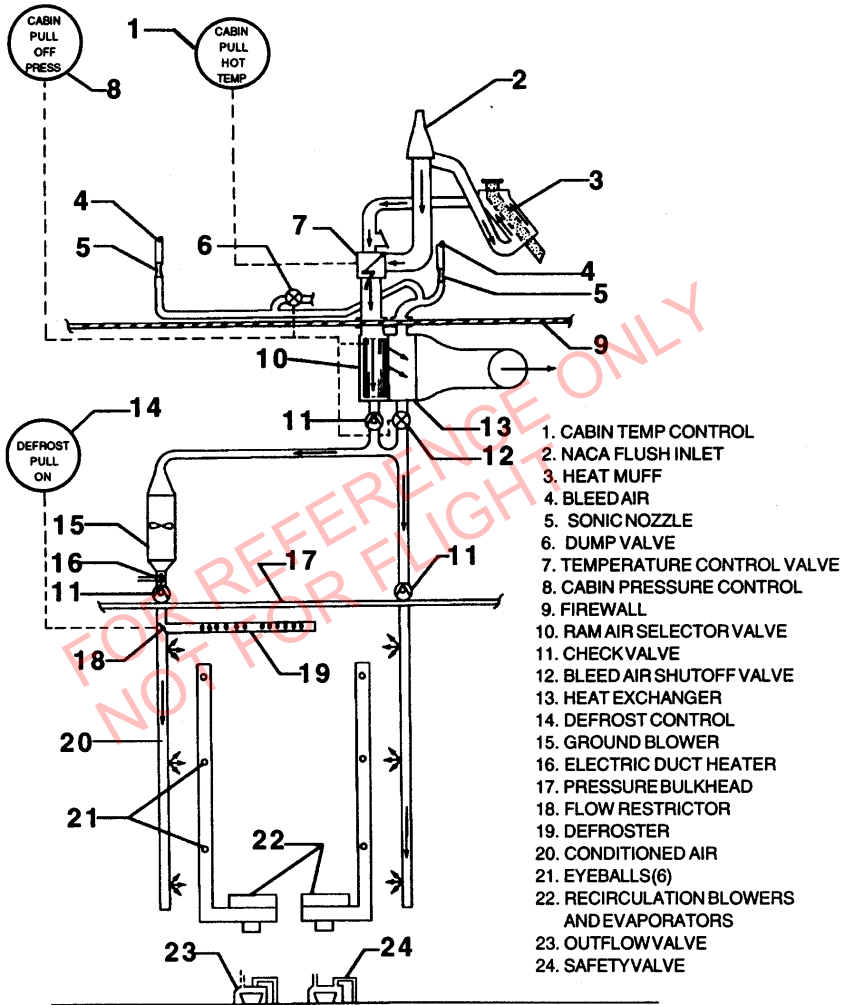

ENVIRONMENTAL SYSTEM

Figure 7-43

7.27 BLEED AIR, CONDITIONING AND PRESSURIZATION SYSTEM

Air for cabin pressure is obtained from the engine turbocharger induction air system through two sonic venturi tubes. Bleed air is routed through the bleed air heat exchanger for the temperature conditioning to provide the desired cabin comfort level. Ram ambient air is routed across the heat exchanger to cool the bleed air, and hot ambient air from the heat muff is routed across the heat exchanger to heat the bleed air. Mixtures of ram ambient and heated ambient air may also be selected.

Cabin air is controlled by a push-pull knob labeled CABIN PRESS located beneath the control wheel on the pilot's instrument panel. Bleed air for pressurizing the cabin is provided when the control is fully in. Unpressurized ambient air is provided for ventilating the cabin when the control is fully out. This control operates three valves: the bleed air shutoff valve, the bleed air dump valve, and the ram air selector valve. When pushed fully in, the bleed air shutoff valve is open, the bleed air dump valve is closed, and the ram air selector valve is positioned to route ambient air across the bleed air heat exchanger. When the control is pulled completely out, the bleed air shutoff valve is closed, the bleed air dump valve is open, and the ram air selector valve is positioned to route ambient air into the conditioned air ducts through the check valve and into the cabin.

Controls and switches needed to operate the cabin pressurization system are located on the lower section of the pilot's instrument panel to the right of and beneath the control wheel, and on the lower right side of the copilot's instrument panel. In addition to the CABIN PRESS and CABIN TEMP controls, they include the cabin pressure and rate controller located just above the fuel selector control on the pilot's instrument panel, and the CABIN PRESS DUMP/NORM switch located on the right overhead switch panel.

For pressurized flight, set the cabin pressure controller at 500 feet above the airport pressure altitude, CABIN PRESS control knob full in and the CABIN PRESS DUMP/NORM switch to NORM. The rate of cabin ascent and descent change is controlled with the rate knob (left lower corner of the cabin pressure controller), and may be adjusted between approximately 200 and 2000 feet per minute, as desired. Setting the rate knob arrow to the 9 o'clock position provides a cabin rate of change of approximately 500 feet per minute. This position gives a comfortable rate for normal operations.

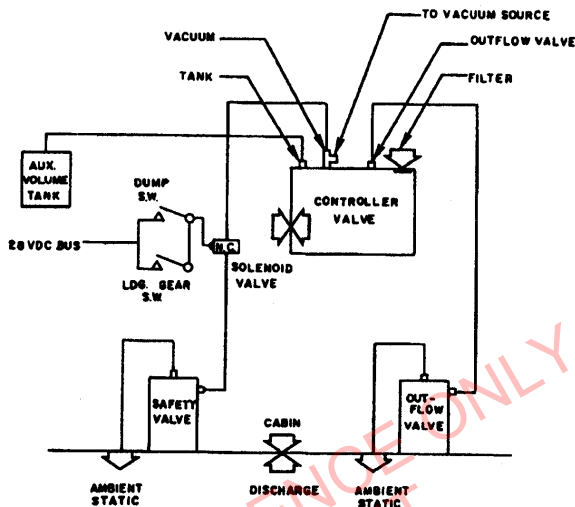
7.27 BLEED AIR, CONDITIONING AND PRESSURIZATION SYSTEM
(Continued)

PRESSURIZATION CONTROL SCHEMATIC

Figure 7-45

Below the cabin pressure controller, a triple indicator simplifies monitoring the system's operation. The triple indicator displays the cabin altitude, cabin rate of change and the differential pressure between the cabin and the outside atmosphere. Maximum cabin differential pressure is 5.5 psi.

A CABIN ALTITUDE warning light on the annunciator display warns the pilot when the cabin altitude is above 10,000 feet. Cabin pressure is automatically regulated to a maximum of 5.5 psi pressure differential. Should the cabin outflow valve malfunction, the cabin safety valve will maintain a maximum of 5.6 cabin differential pressure. The landing gear squat switch, on the left main landing gear, prevents the cabin from being pressurized while the airplane is on the ground.

For complete instructions on the operation of the cabin pressurization system, refer to Section 4, Normal Procedures.

The CABIN PRESS DUMP/NORM switch, when set to DUMP, electrically opens a solenoid valve allowing vacuum suction pressure to open the safety valve and rapidly dump cabin pressure to ambient pressure.

7.27 BLEED AIR, CONDITIONING AND PRESSURIZATION SYSTEM
(Continued)

CABIN ALTITUDE VS. AIRPLANE ALTITUDE

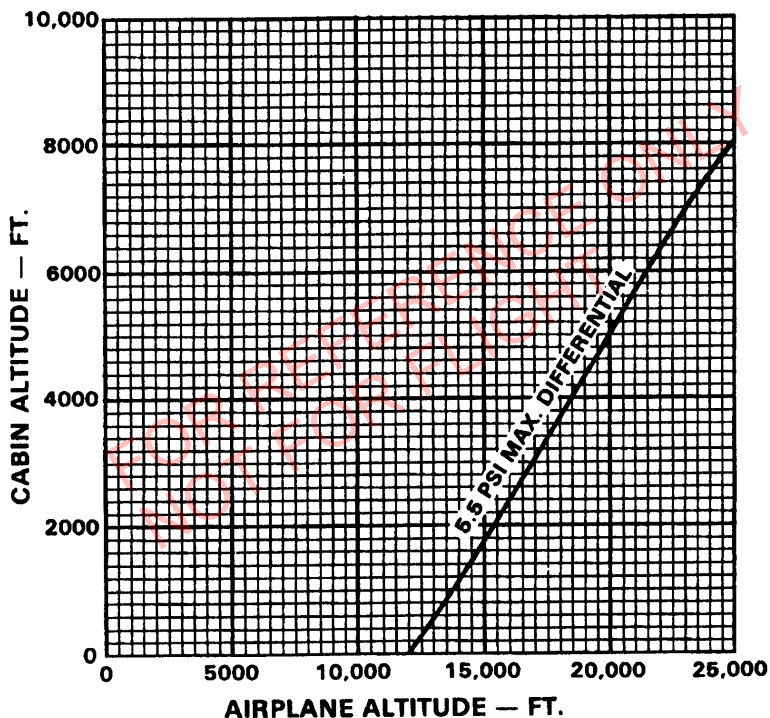

CABIN ALTITUDE VS. AIRPLANE ALTITUDE

Figure 7-47

**7.27 BLEED AIR, CONDITIONING AND PRESSURIZATION SYSTEM
(Continued)**

For unpressurized flight the CABIN PRESS control should be pulled fully out. Setting the CABIN PRESS/DUMP/NORM switch to DUMP will provide maximum airflow through the cabin. Cabin temperature will continue to be controlled by the CABIN TEMP control.

For complete instructions on pressurization malfunctions, refer to Section 3 - Emergency Procedures.

7.29 VACUUM SYSTEM

Vacuum for the system is provided by two continuously operating engine driven dry air vacuum pumps; one rotating clockwise and one rotating counterclockwise. Either pump can independently support the system. Also included are two regulators, a low vacuum switch, an inlet air filter, and a manifold that connects the autopilot, attitude indicator, cabin pressure controller, and vacuum solenoid valve. The latter two components are part of the cabin pressurization system.

The two vacuum regulators are mounted on the forward pressure bulkhead in the forward baggage compartment

A vacuum gauge and two vacuum failure annunciators (Figure 7-49), provides information to the pilot regarding the operation of both pumps. When both pumps are operating, neither annunciator is illuminated. The No. 1 vacuum failure annunciator will illuminate should the clockwise rotating pump fail, while the No. 2 vacuum failure annunciator will illuminate should the counterclockwise rotating pump fail.

Any decrease in system vacuum may indicate a dirty filter, dirty screens, sticking vacuum regulator, or a leak in the system.

7.29 VACUUM SYSTEM (Continued)

Upon completion of the flight, all system abnormalities or malfunctions should be checked by a mechanic, and necessary repairs made, prior to further pressurized flight or flight under IFR.

Operators of airplanes equipped with wing and tail deicers should refer to Section 9, Supplement 3, for additional information concerning the vacuum system.

FOR REFERENCE ONLY
NOT FOR FLIGHT

7.29 VACUUM SYSTEM (Continued)

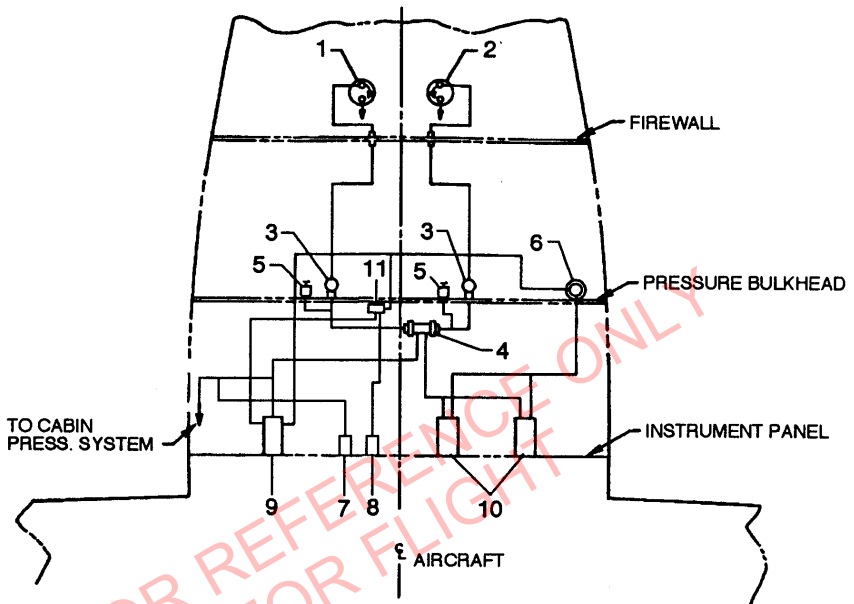

1. CLOCKWISE ROTATING VACUUM PUMP
2. COUNTERCLOCKWISE ROTATING VACUUM PUMP
3. VACUUM REGULATOR
4. VACUUM MANIFOLD/CHECK VALVE
5. VACUUM PRESSURE SWITCH
6. INLINE FILTER
7. CABIN PRESSURE CONTROLLER
8. VACUUM GAUGE (Located in EMIS stack)
9. PILOT'S ATTITUDE GYRO
10. COPILOT'S AIR DRIVEN GYROS (OPTIONAL)
11. VACUUM TRANSDUCER

VACUUM SYSTEM

Figure 7-49

7.31 CABIN FEATURES

The front seats are adjustable fore and aft and vertically. Pivoting armrests are provided on the inboard side of each seat.

Shoulder harnesses with inertia reels are standard equipment for all seats. The inertia reel should be checked by tugging sharply on the strap. The reel will lock in place under this test and prevent the strap from extending. Under normal movement the strap will extend and retract as required.

The shoulder harness is routed over the shoulder adjacent to the windows and attached to the lap belt buckle.

Shoulder harnesses shall be worn during takeoff, landing and during an emergency situation.

Standard cabin features include a pilot's storm window, map pockets, cup holders, sun visors, stowage drawers under the aft facing seats and a baggage restraint net behind the rear seats.

Two combination instrument panel flood/map lights are provided forward, and four passenger reading lights are provided aft. A cabin entrance flood light is located above the door.

The four passenger seats with folding armrests and headrests are positioned in a club seating arrangement. The center seats face aft. The seat backs recline by pushing a button mounted in the outboard armrest.

An optional conference table located between the right passenger seats is available. The table is extended by pulling in on the upper edge of the leaf and then upward. The leaf is then rotated down into position and unfolded. Reverse this procedure for stowage.

Optional cabinets located behind the pilot seats are available. The right cabinet is designed for Jeppesen manual stowage in the bottom and contains a drawer for general use.

The left cabinet contains a removable ice chest, a tray, space for six canned drinks, and a fold down cup holder in the lower drawer. The upper drawer has space for thermos containers, cups and miscellaneous items.

7.31 CABIN FEATURES (Continued)

**EMERGENCY EXIT**

Figure 7-51

Optional passenger oxygen generators and masks are available and, if installed, are located in a drawer under the right aft facing seat.

Crew oxygen is located under the copilot's seat, readily available to either crew member. An annunciator light illuminates when any of the three generators have been activated. The light remains illuminated with the battery switch ON, until the system is serviced.

An optional fire extinguisher is available and, if installed, is located either behind the spar or on top of the right cabinet.

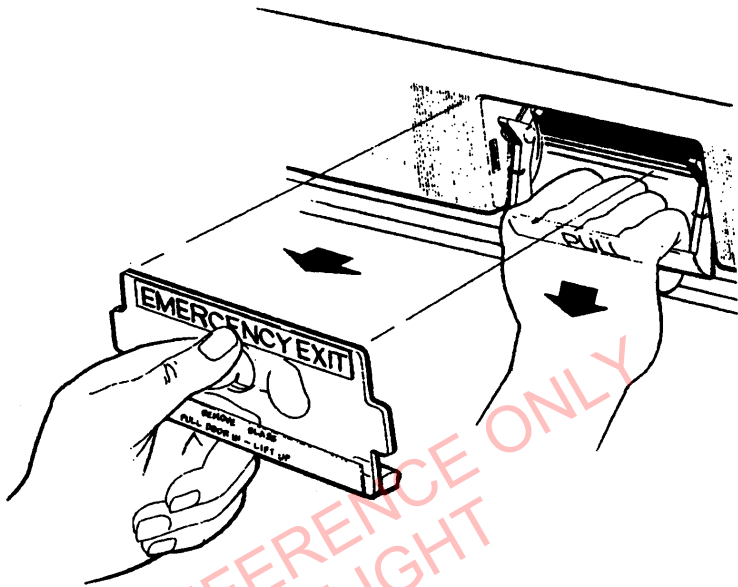
The emergency exit is located on the right side of the fuselage, adjacent to the aft facing seat. Instructions for opening the emergency exit are placarded on the cover over the handle. To open, remove the cover and pull the handle. The window releases inward. The cabin must be unpressurized to open the exit.

7.33 BAGGAGE AREA

The airplane has two separate baggage areas each with a 100-pound capacity. A 13-cubic-foot forward baggage compartment, located just aft of the firewall, is accessible through a 19 x 23 inch door on the left side of the fuselage. An aft baggage compartment, which is accessible from inside the cabin, is located behind the back seats.

A forward baggage door annunciation system senses the baggage door latch position. If the baggage door is not closed and latched, the DOOR AJAR annunciator light will illuminate on the annunciator panel.

NOTE

It is the pilot's responsibility to be sure when the baggage is loaded that the airplane's C.G. falls within the allowable C.G. range (refer to Section 6, Weight and Balance).

7.35 FINISH

All exterior surfaces are primed and finished with polyurethane. To keep the finish attractive looking, polyurethane touch-up paint is available from Piper Factory Authorized Service Centers.

7.37 STALL WARNING

An approaching stall is indicated by a stall warning horn sounding a continuous tone, as opposed to the landing gear horn's beeping tone. Mild airframe buffeting may also precede a stall.

The stall warning is activated by a lift transducer installed in the leading edge of the left wing. An onboard computer will distinguish between power on, power off, and flap position conditions during normal stalls, causing the horn to sound five to ten knots above the stall speed.

A graph showing stall speeds at various angles of bank is contained in Section 5.

7.39 EMERGENCY LOCATOR TRANSMITTER

The Emergency Locator Transmitter (ELT) meets the requirements of FAR 91.52. It operates on self-contained batteries and is located in the aft fuselage section. It is accessible through a cover on the bottom right side.

A battery replacement date is marked on the transmitter. To comply with FAA regulations, the battery must be replaced on or before this date. The battery must also be replaced if the transmitter has been used in an emergency situation, if the accumulated test time exceeds one hour, or if the unit has been inadvertently activated for an undetermined time period.

NOTE

If for any reason a test transmission is necessary, the test transmission should be conducted only in the first five minutes of any hour and limited to three audio sweeps. If a test must be made at any other time, the test should be coordinated with the nearest FAA tower or flight service station.

ARTEX ELT OPERATION

On the ELT unit itself is a two position switch placarded ON and OFF. The OFF position is selected when the transmitter is installed at the factory and the switch should remain in that position whenever the unit is installed in the airplane.

A pilots remote switch, placarded ON and ARM is located on the copilots instrument panel to allow the transmitter to be armed or turned on from inside the cabin. The switch is normally in ARM position. Moving the switch to ON will activate the transmitter. A warning light located above the remote switch will alert you when ever the ELT is activated.

Should the ELT be activated inadvertently it can be reset by either positioning the remote switch to the ON then immediately relocating it to the ARM position, or by setting the switch on the ELT to ON and then back to OFF.

In the event the transmitter is activated by an impact, it can be turned off by moving the ELT switch OFF. Normal operation can then be restored by resetting the switch to ARM. It may also be turned off and reset by positioning the remote switch to the ON and then immediately to the ARM position.

7.39 EMERGENCY LOCATOR TRANSMITTER (Continued)

ARTEX ELT OPERATION (Cont'd)

The transmitter can be activated manually at any time by placing either the remote switch or the ELT switch to the ON position.

NOTE:

Three sweeps of the emergency tone and an illuminated warning light indicates a normally functioning unit. The warning light must illuminate during the first 3 second test period. If it does not illuminate, a problem is indicated such as a "G" switch failure.

The ELT should be checked during postflight to make certain the unit has not been activated. Check by selecting 121.50 MHz on an operating receiver. If a downward sweeping audio tone is heard the ELT may have been activated. Set the remote switch to ON. If there is no change in the volume of the signal, your airplane's ELT is probably transmitting. Setting the remote switch back to OFF will automatically reset the ELT and should stop the signal being received on 121.50 MHz.

7.41 EXTERNAL POWER

The external power receptacle allows the airplane engine to be started from an external power source without the necessity of gaining access to the airplane battery. The cable from the external power source can be attached to a receptacle, located on the aft side of the forward baggage compartment. Instructions on a placard located on the cover of the receptacle should be followed when starting with external power. For instructions on the use of starting with external power, refer to Starting Engines in Section 4.

7.43 RADAR*

A weather radar system can be installed in the airplane. The basic components of this installation are a Receiver-Transmitter Antenna and a cockpit indicator. The function of the weather radar system is to detect weather conditions along the flight path and to visually display a continuous weather outline on the cockpit indicator. Through interpretation of the advance warning given on the display, the pilot can make an early decision on the most desirable weather avoidance course.

NOTE

When operating weather avoidance radar systems inside of moderate to heavy precipitation, it is advisable to set the range scale of the radar to its lowest scale.

For detailed information on the weather avoidance radar system and for procedures to follow in operating and adjusting the system to its optimum efficiency, refer to Section 9, Supplements, or the appropriate operating and service manuals provided by the radar system manufacturer.

WARNING

Heating and radiation effects of radar can cause serious damage to the eyes and tender organs of the body. Personnel should not be allowed within fifteen feet of the area being scanned by the antenna while the system is transmitting. Do not operate the radar during refueling or in the vicinity of trucks or containers accommodating explosives or flammables. Flashbulbs can be exploded by radar energy. Before operating the radar, direct the nose of the airplane so that the forward 120 degree sector is free of any metal objects such as other aircraft or hangars for a distance of at least 100 yards, and tilt the antenna upward 12 degrees. Do not operate the radar while the airplane is in a hangar or other enclosure.

*Optional Equipment

TABLE OF CONTENTS

SECTION 8

AIRPLANE HANDLING, SERVICING, AND MAINTNEANCE

Paragraph No.		Page No.
8.1	General	8-1
8.3	Airplane Inspection Periods	8-2
8.5	Preventive Maintenance	8-3
8.7	Airplane Alterations	8-3
8.9	Ground Handling	8-4
8.11	Engine Induction Air Filter	8-7
8.13	Brake Service	8-7
8.15	Hydraulic System Service	8-9
8.17	Landing Gear Service	8-9
8.19	Propeller Service	8-10
8.21	Oil Requirements	8-11
8.23	Fuel System	8-12
8.25	Tire Inflation	8-16
8.27	Battery Service	8-16
8.29	Emergency Oxygen System (Optional)	8-16
8.31	Pressurization System	8-16
8.33	Lubrication	8-17
8.35	Cleaning	8-17
8.36	Cleaning of the Relief Tube System	8-22

SECTION 8

AIRPLANE HANDLING, SERVICING, AND MAINTENANCE

8.1 GENERAL

This section provides guidelines relating to the handling, servicing, and maintenance of the Malibu Mirage. For complete maintenance instructions, refer to the PA-46-350P Maintenance Manual.

WARNING

Inspection, maintenance and parts requirements for all non-PIPER approved STC installations are not included in this handbook. When a non-PIPER approved STC installation is incorporated on the airplane, those portions of the airplane affected by the installation must be inspected in accordance with the inspection program published by the owner of the STC. Since non-PIPER approved STC installations may change systems interface, operating characteristics and component loads or stresses on adjacent structures, PIPER provided inspection criteria may not be valid for airplanes with non-PIPER approved STC installations.

WARNING

Modifications must be approved in writing by PIPER prior to installation. Any and all other installations, whatsoever, of any kind will void this warranty in it's entirety.

8.1 GENERAL (CONTINUED)

WARNING

Use only genuine PIPER parts or PIPER approved parts obtained from PIPER approved sources, in connection with the maintenance and repair of PIPER airplanes.

Genuine PIPER parts are produced and inspected under rigorous procedures to insure airworthiness and suitability for use in PIPER airplane applications. Parts purchased from sources other than PIPER, even though identical in appearance, may not have had the required tests and inspections performed, may be different in fabrication techniques and materials, and may be dangerous when installed in an airplane.

Additionally, reworked or salvaged parts or those parts obtained from non-PIPER approved sources, may have service histories which are unknown or cannot be authenticated, may have been subjected to unacceptable stresses or temperatures or may have other hidden damage not discernible through routine visual or nondestructive testing. This may render the part, component or structural assembly, even though originally manufactured by PIPER, unsuitable and unsafe for airplane use.

PIPER expressly disclaims any responsibility for malfunctions, failures, damage or injury caused by use of non-PIPER approved parts.

8.1 GENERAL (CONTINUED)

Every owner should stay in close contact with an authorized Piper Service Center or Piper's Customer Services Department to obtain the latest information pertaining to their airplane, and to avail themselves of Piper's support systems.

Piper takes a continuing interest in having owners get the most efficient use from their airplane and keeping it in the best mechanical condition. Consequently, Piper, from time to time, issues service releases including Service Bulletins, Service Letters, Service Spares Letters, and others relating to the airplane.

Piper Service Bulletins are of special importance and Piper considers compliance mandatory. These are sent directly to the latest FAA-registered owners in the United States (U.S.) and Piper Service Centers worldwide. Depending on the nature of the release, material and labor allowances may apply. This information is provided to all authorized Piper Service Centers.

Service Letters deal with product improvements and servicing techniques pertaining to the airplane. They are sent to Piper Service Centers and, if necessary, to the latest FAA-registered owners in the U.S. Owners should give careful attention to Service Letter information.

Service Spares Letters offer improved parts, kits, and optional equipment which were not available originally, and which may be of interest to the owner.

Piper offers a subscription service for Service Bulletins, Service Letters, and Service Spares Letters. This service is available to interested persons such as owners, pilots, and mechanics at a nominal fee, and may be obtained through an authorized Piper Service Center or Piper's Customer Services Department.

Maintenance manuals, parts catalogs, and revisions to both, are available from Piper Service Centers or Piper's Customer Services Department.

Any correspondence regarding the airplane should include the airplane model and serial number to ensure proper response.

8.3 AIRPLANE INSPECTION PERIODS

WARNING

All inspection intervals, replacement time limits, overhaul time limits, the method of inspection, life limits, cycle limits, etc., recommended by PIPER are solely based on the use of new, remanufactured or overhauled PIPER approved parts. If parts are designed, manufactured, remanufactured, overhauled and/or approved by entities other than PIPER, then the data in PIPER'S maintenance/service manuals and parts catalogs are no longer applicable and the purchaser is warned not to rely on such data for non-PIPER parts. All inspection intervals, replacement time limits, overhaul time limits, the method of inspection, life limits, cycle limits, etc., for such non-PIPER parts must be obtained from the manufacturer and/or seller of such non-PIPER parts.

Piper has developed inspection items and required inspection intervals for the PA-46-350P (see PA-46-310/350P Maintenance and Inspection Manuals). The PA-46-310/350P Inspection Manual contains appropriate forms, and all inspection procedures should be complied with by a properly trained, knowledgeable, and qualified mechanic at an authorized Piper Service Center or a reputable repair shop. Piper cannot accept responsibility for the continued airworthiness of any aircraft not maintained to these standards, and/or not brought into compliance with applicable Service Bulletins issued by Piper, instructions issued by the engine, propeller, or accessory manufacturers, or Airworthiness Directives issued by the FAA.

A programmed Inspection, approved by the Federal Aviation Administration (FAA), is also available to the owner. This involves routine and detailed inspections to allow maximum utilization of the airplane. Maintenance inspection costs are reduced, and the maximum standard of continued airworthiness is maintained. Complete details are available from Piper.

In addition, but in conjunction with the above, the FAA requires periodic inspections on all aircraft to keep the Airworthiness Certificate in effect. The owner is responsible for assuring compliance with these inspection requirements and for maintaining proper documentation in logbooks and/or maintenance records.

8.3 AIRPLANE INSPECTION PERIODS (CONTINUED)

A spectrographic analysis of the engine oil is available from several sources. This inspection, if performed properly, provides a good check of the internal condition of the engine. To be accurate, induction air filters must be cleaned or changed regularly, and oil samples must be taken and sent in at regular intervals.

8.5 PREVENTIVE MAINTENANCE

The holder of a pilot certificate issued under Federal Aviation Regulations (FAR) Part 61 may perform certain preventive maintenance as defined in the FARs. This maintenance may be performed only on an aircraft which the pilot owns and operates, and which is not used in air carrier or air taxi/commercial operations service.

All other aircraft maintenance must be accomplished by a person or facility appropriately certificated by the Federal Aviation Administration (FAA) to perform that work.

Anytime maintenance is accomplished, an entry must be made in the appropriate aircraft maintenance records. The entry shall include:

- (a) The date the work was accomplished.
- (b) Description of the work.
- (c) Number of hours on the aircraft.
- (d) The certificate number of pilot performing the work.
- (e) Signature of the individual doing the work.

8.7 AIRPLANE ALTERATIONS

If the owner desires to have his aircraft modified, he must obtain FAA approval for the alteration. Major alterations accomplished in accordance with advisory Circular 43.13-2, when performed by an A & P mechanic, may be approved by the local FAA office. Major alterations to the basic airframe or systems not covered by AC 43.13-2 require a Supplemental Type Certificate.

8.7 AIRPLANE ALTERATIONS (CONTINUED)

The owner or pilot is required to ascertain that the following aircraft papers are in order and in the aircraft.

- (a) To be displayed in the aircraft at all times:
 - (1) Aircraft Airworthiness Certificate Form FAA-8100-2.
 - (2) Aircraft Registration Certificate Form FAA-8050-3.
 - (3) Aircraft Radio Station License if transmitters are installed.

- (b) To be carried in the aircraft at all times:
 - (1) Pilot's Operating Handbook.
 - (2) Weight and Balance data plus a copy of the latest Repair and Alteration Form FAA-337, if applicable.
 - (3) Aircraft equipment list.

Although the aircraft and engine logbooks are not required to be in the aircraft, they should be made available upon request. Logbooks should be complete and up to date. Good records will reduce maintenance cost by giving the mechanic information about what has or has not been accomplished.

8.9 GROUND HANDLING

- (a) Towing

The airplane may be moved on the ground by the use of the nose wheel steering bar that is stowed in the forward baggage compartment or by power equipment that will not damage or excessively strain the nose gear steering assembly.

CAUTION

When towing with power equipment, do not turn the nose gear beyond its steering limit in either direction, as this will result in damage to the nose gear and steering mechanism.

CAUTION

Do not tow the airplane when the controls are secured.

In the event towing lines are necessary, ropes should be attached to both main gear struts as high up on the tubes as possible. Lines should be long enough to clear the nose and/or tail

8.9 GROUND HANDLING (CONTINUED)

by not less than fifteen feet, and a qualified person should ride in the pilot's seat to maintain control by use of the brakes.

(b) Taxiing*CAUTION*

Do not operate engine above 1200 rpm with cabin doors open.

Before attempting to taxi the airplane, ground personnel should be instructed and approved by a qualified person authorized by the owner. Engine starting and shut-down procedures as well as taxi techniques should be covered. When it is ascertained that the propeller back blast and taxi areas are clear, power should be applied to start the taxi roll, and the following checks should be performed:

- (1) Taxi a few feet forward and apply the brakes to determine their effectiveness.
- (2) Taxi with the propeller set in low pitch, high rpm setting.
- (3) While taxiing, make slight turns to ascertain the effectiveness of the steering.
- (4) Observe wing clearance when taxiing near buildings or other stationary objects. If possible, station an observer outside the airplane.
- (5) When taxiing over uneven ground, avoid holes and ruts.
- (6) Do not operate the engine at high rpm when running up or taxiing over ground containing loose stones, gravel, or any loose material that may cause damage to the propeller blades.

(c) Parking

When parking the airplane, be sure that it is sufficiently protected from adverse weather conditions and that it presents no danger to other aircraft. When parking the airplane for any length of time or overnight, it is suggested that it be moored securely.

- (1) To park the airplane, head it into the wind if possible.
- (2) The parking brake knob is located just below the left control column. To set the parking brake, first depress and hold the toe brakes and then pull out on the parking brake knob. To release the parking brake, first depress the brake pedals and then push in on the parking brake knob.

8.9 GROUND HANDLING (CONTINUED)

CAUTION

Care should be taken when setting brakes that are overheated or during cold weather when accumulated moisture may freeze a brake.

- (3) Aileron and elevator controls should be secured with the front seat belt and chocks used to properly block the wheels.

(d) Mooring

The airplane should be moored for immovability, security and protection. The following procedures should be used for the proper mooring of the airplane:

- (1) Head the airplane into the wind if possible.
- (2) Retract the flaps.
- (3) Immobilize the ailerons and elevator by looping the seat belt through the control wheel and pulling it snug.
- (4) Block the wheels.
- (5) Secure tiedown ropes to wing and tail tiedown rings at approximately 45 degree angles to the ground. When using rope of non-synthetic material, leave sufficient slack to avoid damage to the airplane should the ropes contract.

CAUTION

Use bowline knots, square knots or locked slip knots. Do not use plain slip knots.

NOTE

Additional preparations for high winds include using tiedown ropes from the nose landing gear and securing the rudder.

8.9 GROUND HANDLING (CONTINUED)

- (6) Install a pitot head cover if available. Be sure to remove the pitot head cover before flight.
- (7) Cabin and baggage door should be locked when the air- plane is unattended.

8.11 ENGINE INDUCTION AIR FILTER

(a) Removing Induction Air Filter

- (1) Remove louvered induction air panel assembly at nose of aircraft by removing screws.
- (2) Remove screws around perimeter of filter on induction air inlet to withdraw inlet and filter.

(b) Cleaning Induction Air Filter

The induction air filter must be cleaned at least once every 50 hours, and more often, even daily, when operating in dusty conditions. Extra filters are inexpensive, and a spare should be kept on hand for use as a rapid replacement.

To clean the filter:

- (1) Tap filter gently to remove dirt particles. Do not use compressed air or cleaning solvents.
- (2) Inspect filter. If paper element is torn or ruptured or gasket is damaged, the filter should be replaced. The usable life of the filter should be restricted to one year or 500 hours, whichever comes first.
- (3) After cleaning check all components for dirt and damage. Wipe the filter and inlet clean. Do not oil the filter.

(c) Installation of Induction Air Filter

Replace filter, inlet and screws. Reinstall induction air panel assembly.

8.13 BRAKE SERVICE

The brake system is filled with MIL-H-5606 (petroleum base) hydraulic fluid. The fluid level should be checked periodically or at every 100 hour inspection and replenished when necessary. The brake fluid reservoir is

8.13 BRAKE SERVICE (CONTINUED)

1. DISC BRAKE ASSEMBLY
2. BRAKE FLUID RESERVOIR
3. PARKING BRAKE CONTROL
4. PARKING BRAKE VALVE
5. BRAKE LINES
6. BRAKE CYLINDER

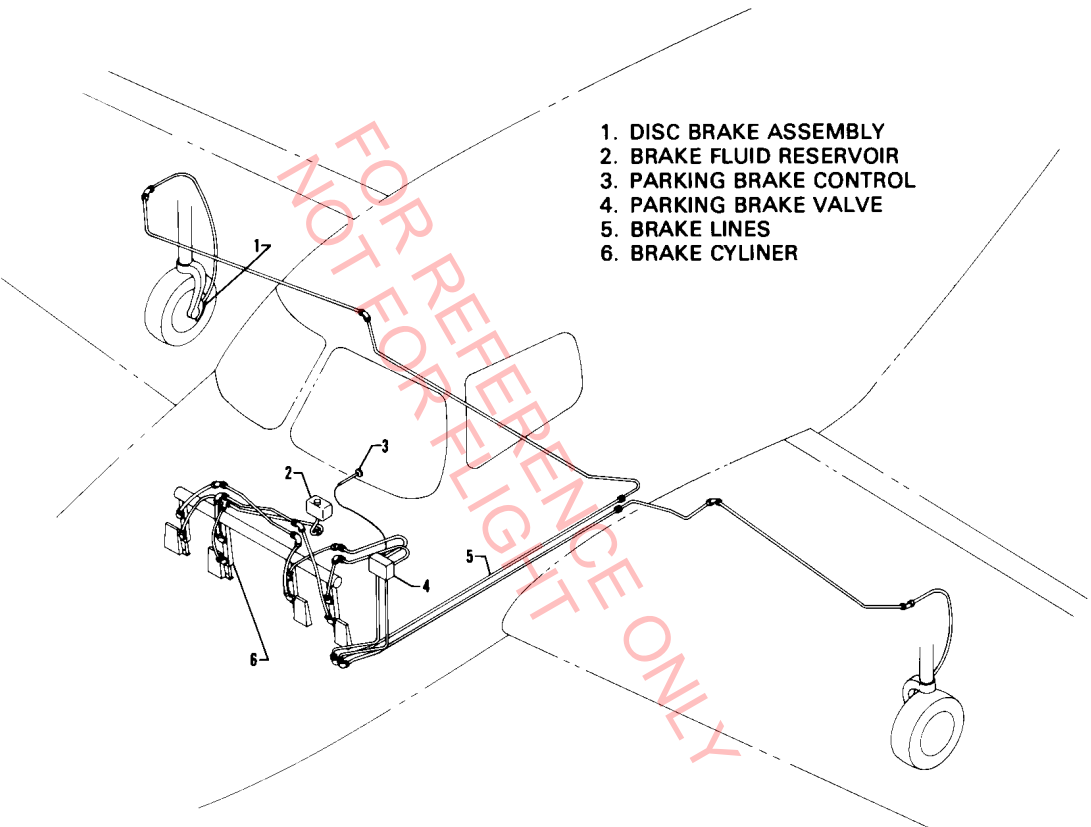

BRAKE SYSTEM
Figure 8-1

8.13 BRAKE SERVICE (CONTINUED)

located behind the aft access panel in the forward baggage compartment. If the entire system must be refilled, fill with fluid under pressure from the brake end of the system. This will eliminate air from the system.

No adjustment of the brake clearances is necessary. If, after extended service, brake blocks become excessively worn they should be replaced with new segments.

8.15 HYDRAULIC SYSTEM SERVICE

The hydraulic system reservoir is an integral part of the electric hydraulic pump assembly. It is located aft of the aft cabin baggage compartment and is accessible through the baggage compartment aft closeout panel. Fill the reservoir with MIL-H-5606 hydraulic fluid. The fluid level should be checked periodically or every 100 hour inspection and replenished when necessary. With the landing gear down and the system up to pressure, fill to the FULL line on the sight gauge.

8.17 LANDING GEAR SERVICE

The main landing gear uses Cleveland Aircraft Products 6.00 x 6 wheels with 6.00 x 6, eight-ply rating tires and tubes. The nose wheel uses a McCauley or a Cleveland Aircraft Products 5.00 x 5 wheel with a 5.00 x 5 six-ply rating, type III tire and tube. (Refer to paragraph 8.25.)

Wheels are removed by taking off the hub cap, cotter pin, axle nut, and the two bolts holding the brake segment in place. Mark tire and wheel for reinstallation; then dismount by deflating the tire, removing the three through-bolts from the wheel and separating the wheel halves.

Landing gear oleos should be serviced according to the instructions on the units. The main oleos should be extended under normal static load until 3.44 +/- 0.25 inches of oleo piston tube is exposed, and the nose gear should show 1.65 +/- 0.25 inches. To add air to the oleo struts, attach a strut pump to the valve assembly near the top of the oleo strut housing and pump the oleo to the desired position. To add oil, jack the aircraft, release the air pressure in the strut, remove the valve core and add oil through this opening with the strut extended. After the strut is full, compress it slowly and fully to allow excess air and oil to escape. With the strut still compressed reinsert the valve core and pump up the strut as above.

8.17 LANDING GEAR SERVICE (CONTINUED)

In jacking the aircraft for landing gear or other service, two hydraulic jacks and a tail stand should be used. At least 400 pounds of ballast should be placed on the base of the tail stand before the airplane is jacked up. The hydraulic jacks should be placed under the jack points on the bottom of the wing and the airplane jacked up until the tail skid is at the right height to attach the tail stand. After the tail stand is attached and the ballast added, jacking may be continued until the airplane is at the height desired.

The steering rods from the rudder pedals to the transverse bellcrank in the nose wheel tunnel are factory adjusted and should be readjusted only in accordance with the applicable rigging specification. Nose wheel alignment is accomplished by adjusting the rod end(s) on the steering bungee assembly in such a way that the nose wheel is in line with the fore and aft axis of the plane when the rudder pedals are centered. Alignment of the nose wheel can be checked by pushing the airplane back and forth with the rudder two degrees to the right to determine that the plane follows a straight line. The turning arc of the nose wheel is 30 +/- 1 in either direction and is limited by stops at the trunnion forging or the forward steering contact arm mounted on the engine mount.

NOTE

The rudder is set to 2 right with the rudder pedals neutralized and the nose wheel centered.

8.19 PROPELLER SERVICE

The spinner and backing plate should be cleaned and inspected for cracks frequently. Before each flight the propeller should be inspected for nicks, scratches, and corrosion. Significant damage must be repaired by a qualified mechanic prior to flight. Nicks or scratches cause an area of increased stress which can lead to serious cracks or the loss of a propeller tip. The back face of the blades should be painted when necessary with flat black paint to retard glare. To prevent corrosion, the surface should be cleaned and waxed periodically.

8.21 OIL REQUIREMENTS

The oil capacity of the Textron Lycoming TI0-540-AE2A engine is 12 quarts with an inflight minimum quantity of approximately 2.75 quarts. Maximum endurance flights should begin with 12 quarts of oil. For all shorter flights, it is recommended that oil be added if the quantity falls to 10 quarts. It is recommended that engine oil be drained and renewed every 50 hours, or sooner under unfavorable conditions. Full flow cartridge type oil filters should be replaced each 50 hours of operation. The following grades are required for temperatures:

Average Ambient Temperature	MIL-L-6082B SAE Grade	MIL-L-22851 Ashless Dispersant SAE Grades
All Temperatures	MINERAL OIL NOT APPROVED	15W-50 or 20W-50
Above 80°F		60
Above 60°F		40 or 50
30°F to 90°F		40
0°F to 70°F		30, 40 or 20W-40
Below 10°F		30 or 20W-30

When operating temperatures overlap indicated ranges, use the lighter grade oil.

NOTE

Refer to the latest issued of Lycoming Service Instruction 1014 (Lubricating Oil Recommendations) for further information.

8.23 FUEL SYSTEM

(a) Servicing Fuel System

At every 100 hour inspection or after an extended downtime, the fuel filter strainer must be cleaned. The fuel filter strainer is located below the floor on the lower right side of the forward baggage compartment.

(b) Fuel Requirements (AVGAS ONLY)

The minimum aviation grade fuel is 100. Since the use of lower grades can cause serious engine damage in a short period of time, the engine warranty is invalidated by the use of lower octanes.

Whenever 100 or 100LL grade fuel is not available, commercial grade 100/130 should be used. (See Fuel Grade Comparison Chart.) Refer to the latest issue of Lycoming Service Instruction No. 1070 (Textron Lycoming Specified Fuels).

A summary of the current grades as well as the previous fuel designation is shown in the following chart:

FUEL GRADE COMPARISON CHART

Previous Commercial Fuel Grades (ASTM-D910)			Current Commercial Fuel Grades (ASTM-D910-75)			Current Military Fuel Grades (MIL-G-5572E) Amendment No. 3		
Grade	Color	Max. TEL ml/U.S. Gal.	Grade	Color	Max. TEL ml/U.S. Gal.	Grade	Color	Max. TEL ml/U.S. Gal.
80/87	red	0.5	80	red	0.5	80/87	red	0.5
91/98	blue	2.0	*100LL	blue	2.0	none	none	none
100/130	green	3.0	100	green	**3.0	100/130	green	**3.0
115/145	purple	4.6	none	none	none	115/145	purple	4.6

* -Grade 100LL fuel in some overseas countries is currently colored green and designated as "100L."

** -Commercial fuel grade 100 and grade 100/130 (both of which are colored green) having TEL content of up to 4 ml/U.S. gallon are approved for use in all engines certificated for use with grade 100/130 fuel.

8.23 FUEL SYSTEM (CONTINUED)

The operation of the aircraft is approved with an anti-icing additive in the fuel. When an anti-icing additive is used it must meet the specification MIL-1-27686, must be uniformly blended with the fuel while refueling, must not exceed .15% by volume of the refueled quantity, and to ensure its effectiveness should be blended at not less than .10% by volume. One and one half liquid ounces per ten gallons of fuel would fall within this range. A blender supplied by the additive manufacturer should be used. Except for the information contained in this section, the manufacturer's mixing or blending instructions should be carefully followed.

CAUTIONS

Assure that the additive is directed into the flowing fuel stream. The additive flow should start after and stop before the fuel flow. Do not permit the concentrated additive to come in contact with the aircraft painted surfaces or the interior surfaces of the fuel tanks.

Some fuels have anti-icing additives pre-blended in the fuel at the refinery, so no further blending should be performed.

Fuel additive can not be used as a substitute for preflight draining of the fuel system drains.

(c) Filling Fuel Tanks**WARNINGS**

Do not operate any avionics or electrical equipment on the airplane during refueling. Do not allow open flame or smoking in the vicinity of the airplane while refueling.

During all refueling operations, fire fighting equipment must be available. Two ground wires from different points on the airplane to separate approved grounding stakes shall be used.

8.23 FUEL SYSTEM (CONTINUED)

Observe all safety precautions required when handling gasoline. Fill the fuel tanks through the filler located on the forward slope of the wing. Each wing holds a maximum of 60 U.S. gallons. When using less than the standard 120 gallon capacity, fuel should be distributed equally between each side.

NOTE

Aircraft should be refueled in a wing level condition. At times this will require alternate filling of left and right tanks until the full condition is reached.

(d) Draining Fuel Strainer, Sumps and Lines

The fuel tank sumps and filter should be drained before the first flight of the day and after refueling. Set fuel selector on left or right tank before draining. The fuel collector/sump tanks, located at the root of each wing, are the lowest points in the system. Each tank drain is accessible through a hole in the bottom wing skin adjacent to the wheel well. The fuel filter drain is located on the right hand side of the fuselage several feet forward of the wing. Sumps and filter should be drained until sufficient fuel has flowed to ensure the removal of any contaminants. When draining sumps, use the end on sampler cup to push in valve, catching fuel in the cup. (Refer to Figure 8-3) To drain filter, hold sampler cup under nylon tube and push in tube. Always inspect fuel for contaminants, water and fuel grade (color). Assure that valves have sealed after draining.

NOTE

Sump drains will lock open if valve is pushed in and turned. Continue turning to release lock.

8.23 FUEL SYSTEM (CONTINUED)

**FUEL TANK DRAIN**

Figure 8-3

(e) Emptying Fuel System

Drain the bulk of fuel at sump tanks. Set fuel selector on left or right tank. Push in sump drain valves and twist turn to lock open. Remaining fuel may be drained through the filter drain. Close sump drain valves before refueling.

CAUTION

Whenever the fuel system is completely drained and fuel is replenished it will be necessary to run the engine for a minimum of three minutes at 1000 rpm on each tank to insure that no air exists in the fuel supply lines.

8.25 TIRE INFLATION

For maximum service, keep tires inflated to the proper pressure: 50 psi for the nose tire and 55 psi for the main tires. All wheels and tires are balanced before original installation, and the relationship of tire, tube, and wheel should be maintained upon reinstallation. Unbalanced wheels can cause extreme vibration in the landing gear; therefore, in the installation of new components, it may be necessary to rebalance the wheels with the tires mounted. When checking tire pressure, examine the tires for wear, cuts, bruises, and slippage.

8.27 BATTERY SERVICE

Access to the 24-volt battery is gained by opening the forward baggage door and removing the left floor of the forward baggage compartment. The battery should be checked for proper fluid level. **DO NOT** fill the battery above the baffle plates. **DO NOT** fill the battery with acid - use water only. A hydrometer check will determine the percent of charge in the battery.

Inspect overflow sump for presence of battery fluid. Fluid in the sump is not a normal condition and indicates either a battery or charging system problem. If fluid is present, the electrical system must be serviced to eliminate cause and the neutralizer media in the sump jar replaced.

If the battery is not up to charge, recharge starting at a 3 amp rate and finishing with a 1.5 amp rate. Quick charges are not recommended.

8.29 EMERGENCY OXYGEN SYSTEM (OPTIONAL)

The optional emergency oxygen system must be serviced if used. The canister generators must be replaced with new units to restore the emergency system to a useable condition.

8.31 PRESSURIZATION SYSTEM

The system should be given an operational check before each flight. Should the operational check show any malfunction of the pressurization system, refer to the Malibu Service Manual.

8.33 LUBRICATION

For lubricating instructions, a chart showing lubrication points and types of lubricants to be used, and lubrication methods, refer to the PA-46-350P Maintenance Manual.

8.35 CLEANING

(a) Cleaning Engine Compartment

- (1) Place a large pan under the engine to catch waste.
- (2) With the engine cowling removed, spray or brush the engine with solvent or a mixture of solvent and degreaser. In order to remove especially heavy dirt and grease deposits, it may be necessary to brush areas that were sprayed.

CAUTION

Do not spray solvent into the alternators, vacuum pumps, starter, or air intakes.

- (3) Allow the solvent to remain on the engine from five to ten minutes. Then rinse the engine clean with additional solvent and allow it to dry.

CAUTION

Do not operate the engine until excess solvent has evaporated or otherwise been removed.

- (4) Lubricate the controls, bearing surfaces, etc., in accordance with the Lubrication Chart in the PA-46-350P Maintenance Manual.
- (5) Assure that all engine exhaust deposits and stains are removed frequently from bottom of aircraft around exhaust outlets. *Accumulation of exhaust deposits left even over short periods of time will cause corrosion.*

8.35 CLEANING (CONTINUED)

(b) Cleaning Landing Gear

Before cleaning the landing gear, place a plastic cover or similar material over the wheel and brake assembly.

CAUTION

Do not brush the micro switches.

- (1) Place a pan under the gear to catch waste.
- (2) Spray or brush the gear area with solvent or a mixture of solvent and degreaser, as desired. Where heavy grease and dirt deposits have collected, it may be necessary to brush areas that were sprayed, in order to clean them.
- (3) Allow the solvent to remain on the gear from five to ten minutes. Then rinse the gear with additional solvent and allow to dry.
- (4) Remove the cover from the wheel and remove the catch pan.
- (5) Lubricate the gear in accordance with the Lubrication Chart.

(c) Cleaning Exterior Surfaces

The airplane should be washed with a mild soap and water. Harsh abrasives or alkaline soaps or detergents could make scratches on painted or plastic surfaces or could cause corrosion of metal. Cover areas where cleaning solutions could cause damage. To wash the airplane, use the following procedure:

CAUTION

Do not direct any stream of water or cleaning solutions at the openings in the pitot head, static ports, alternate static ports or fuselage belly drains.

- (1) Flush away loose dirt with water.
- (2) Apply cleaning solution with a soft cloth, a sponge or a soft bristle brush.
- (3) To remove exhaust stains, allow the solution to remain on the surface longer.
- (4) To remove stubborn oil and grease, use a cloth dampened with naphtha.
- (5) Rinse all surfaces thoroughly.
- (6) Any good automotive wax may be used to preserve painted surfaces. Soft cleaning cloths or a chamois should be used to prevent scratches when cleaning or polishing. A heavier coating of wax on the leading surfaces will reduce the abrasion problems in these areas.

8.35 CLEANING (CONTINUED)

(d) Cleaning Windshield and Windows

CAUTION

Use only mild soap and water when cleaning the heated windshield. Use of ANY other cleaning agent or material may cause distortion or damage to windshield coatings.

- (1) Remove dirt, mud and other loose particles from exterior surfaces with clean water.
- (2) Wash with mild soap and warm water or with aircraft plastic cleaner. Use a soft cloth or sponge in a straight back and forth motion. Do not rub harshly.
- (3) Remove oil and grease with a cloth moistened with kerosene.

CAUTION

Do not use gasoline, alcohol, benzene, carbon tetrachloride, thinner, acetone, or window cleaning sprays.

- (4) After cleaning plastic surfaces, apply a thin coat of hard polishing wax. Rub lightly with a soft cloth. Do not use a circular motion.
- (5) A minor scratch or mar in plastic can be removed by rubbing out the scratch with jeweler's rouge. Smooth both sides and apply wax. Deep scratches may lead to failure when pressurized.
- (6) If a deep scratch or crack is found in any of the windshields or windows, do not pressurize cabin until serviced at authorized repair station.

(e) Cleaning Headliner, Side Panels and Seats

- (1) For normal soiling and smudges, simply use the dry cleaning pad provided. This pad contains an exclusive grit- free powder with unusual power to absorb dirt.

Squeeze and twist the pad so the powder sifts through the meshes and adheres to the cloth. Then rub the soiled part in any direction, as hard as necessary to clean.

Even though the pad eventually becomes soiled, this soil will not transfer back to the headliner.

8.35 CLEANING (CONTINUED)

- (2) For simple stains (e.g. coffee, cola) clean headliner with a sponge and a common household suds detergent (e.g. Tide). Dirty grease stains should be first spot cleaned with a lighter fluid containing Naphtha to remove the solvent soluble matter. Any stain residue should then be shampooed with a household upholstery cleaner (e.g. Carbona upholstery and rug shampoo).

With proper care, your Malibu headliner will provide years of excellent appearance and durability.

CAUTION

Solvent cleaners require adequate ventilation.

- (3) Leather should be cleaned with saddle soap or a mild hand soap and water.
- (f) Cleaning Carpets

To clean carpets, first remove loose dirt with a whisk broom or vacuum. For soiled spots and stubborn stains use a nonflammable dry cleaning fluid. Floor carpets may be cleaned like any household carpet.

- (g) Cleaning Oxygen Equipment

- (1) Clean the mask assemblies with a suitable oil-free disinfectant.
- (2) Wipe dirt and foreign particles from the unit with a clean, dry, lint-free cloth.

- (h) Cleaning Surface Deicing Equipment

The deicers should be cleaned when the aircraft is washed using a mild soap and water solution.

In cold weather, wash the boots with the airplane inside a warm hangar if possible. If the cleaning is to be done outdoors, heat the soap and water solution before taking it out to the

8.35 CLEANING (CONTINUED)

airplane. If difficulty is encountered with the water freezing on boots, direct a blast of warm air along the region being cleaned using a portable ground heater.

Petroleum products are injurious to rubber and their use as cleaning agents should be avoided. Limited use of Mineral Spirits or non-leaded (NOT LOW LEAD) gasoline is not harmful in cleaning the deicers, if the cloth is dampened (not dripping) with solvent, and a dry cloth is used to wipe the deicer before the solvent has time to soak into the rubber.

With the deicer boots properly cleaned, a coating of Agemaster No. 1 should be applied to the LH and RH wing and LH horizontal stabilizer boots only, as described in the PA-46-350P Maintenance Manual. AGEMASTER NO. 1 IS NOT TO BE USED AS A SURFACE PREPARATION ON THE RH HORIZONTAL AND VERTICAL FIN PNEUMATIC BOOTS. This treatment helps protect the neoprene deice boots from ozone attack, aging and weathering.

Icex may be applied to all of the boots if icing conditions are anticipated. Any boots treated with Agemaster should be allowed to dry before application of Icex. For specific instructions refer to the PA-46-350P Maintenance Manual.

8.36 CLEANING AND MAINTENANCE OF RELIEF TUBE SYSTEM

When the aircraft is equipped with a relief tube system, the corrosive effects of urine or other liquids poured through the system are extreme and require much attention to the cleanliness of this system both inside and outside of the aircraft. From the interior standpoint, the funnel tube assembly, rubber hose and surrounding sheet metal should be cleaned at termination of flight when the system has been used. Likewise, attention to the exterior of the aircraft is equally as important and must be cleaned as described below.

The corrosive affects of urine on painted and unpainted surfaces cannot be understated. Corrosion may appear in surrounding areas if allowed to go uncleaned for one day!

(a) Interior

After each use of the relief tube, the area surrounding the relief tube should be examined for spillage and cleaned according to the cleaning procedures listed in paragraphs 8.35(e) and (f) above. Clean area inside the box and access door, funnel and tube using mild soap and water. After cleaning, assure that no soapy residue remains by flushing with clean water. Dry system thoroughly.

CAUTION

Should spillage extending into the fuselage be evident, maintenance actions must occur which include removing panels to access the floor structure to neutralize urine spillage in the aircraft structure.

Prepare to flush the relief tube assembly by placing a container underneath the relief tube outlet. Flush tube by pouring a solution of baking soda (10%) and water through the tube, flushing out the entire system. Flush again with at least 1/2 gallon of clear water. (Shop air, at low pressure, may be blown through the relief tube system to dry the system.)

(b) Exterior

Exterior bottom painted surfaces of the aircraft must be cleaned from the firewall to the tip of the tail including the bottom of the tail surfaces, at termination of each flight when the relief tube system has been used. Cleaning should occur in accordance with paragraph 8.35(c) with the following exception: After completion of washing, a solution of baking soda (10%) and water should be applied to the entire area and allowed to remain for a few minutes. The area then must be thoroughly rinsed with clean water. The area should be thoroughly dried and observed for paint chips and corrosion, with touch up as necessary.

FOR REFERENCE ONLY
NOT FOR FLIGHT

TABLE OF CONTENTS

SECTION 9

SUPPLEMENTS

Paragraph/Supplement No.		Page No.
9.1	General	9-1
1	Emergency Oxygen System(6 Pages)	9-3
2	Propeller Heat, Heated Windshield, and Wing Ice Detection Light(6 Pages)	9-9
3	Ice Protection System(16 Pages)	9-15
4	B.F. Goodrich Integrated Ice Detection System(4 Pages)	9-31
5	Bendix/King 150 Series Flight Control System(1 Page)	9-35
6	Bendix/King KAS 297B Vertical Speed and Altitude Selector(1 Page)	9-37
7	3M (Series II) Stormscope, WX-1000/1000+(4 Pages)	9-39
8	Bendix/King EHI 40 Electronic Horizontal Situation Indicator(26 Pages)	9-43
9	Bendix/King RDR 2000 Vertical Profile Weather Radar System.....(10 Pages)	9-69
10	ARGUS 7000CE Moving Map Display(8 Pages)	9-79
11	Bendix/King KLN 90B GPS Navigation System with KAP/KFC 150/225 Autopilot System(12 Pages)	9-87
12	Bendix/King KX 155A Comm / Nav System.....(12 Pages)	9-99
13	Precise Flight SPEEDBRAKE 2000 System.....(1 Page)	9-111
14	Bendix/King KFC 225 Series Flight Control System(1 Page)	9-113

TABLE OF CONTENTS

SECTION 9

SUPPLEMENTS

(continued)

Paragraph/Supplement No.		Page No.
15	Garmin GNS 430 VHF Comm/ Nav/GPS(8 Pages)	9-115
16	S-TEC System 55 Autopilot.....	9-123
17	Garmin GNS 530 VHF Comm/ Nav/GPS(8 Pages)	9-125
18	Garmin GTX 327 Transponder.....(10 pages)	9-133
19	Avidyne 5RR-MFC Series FlightMax Flight Situation Display(8 pages)	9-143
20	B.F. Goodrich Skywatch Traffic Advisory System Model SKY497.....(6 pages)	9-151
21	B.F. Goodrich Aerospace WX-500 Stormscope Series II Weather Mapping Sensor(4 pages)	9-157
22	Meggitt Electronic Flight Display System (EFIS) (Pilot Side Only).....	9-161
23	Bendix/King KMH 880 Multi-Hazard Awareness System	9-163
24	Garmin GTX 330 Transponder.....(4 pages)	9-165

**SECTION 9
SUPPLEMENTS**

9.1 GENERAL

This section provides information in the form of supplements which are necessary for efficient operation of the airplane when it is equipped with one or more of the various optional systems and equipment not approved with the standard airplane.

All of the supplements provided in this section are FAA Approved and consecutively numbered as a permanent part of this handbook. The information contained in each supplement applies only when the related equipment is installed in the airplane.

FOR REFERENCE ONLY
NOT FOR FLIGHT

**PILOT'S OPERATING HANDBOOK
AND
FAA APPROVED AIRPLANE FLIGHT MANUAL
SUPPLEMENT NO. 1
FOR
EMERGENCY OXYGEN SYSTEM**

This supplement must be attached to the Pilot's Operating Handbook and FAA Approved Airplane Flight Manual when the Emergency Oxygen System is installed per Piper Drawing No. 83985-2. The information contained herein supplements or supersedes the information in the basic Pilot's Operating Handbook and FAA Approved Airplane Flight Manual only in those areas listed herein. For limitations, procedures and performance information not contained in this supplement, consult the basic Pilot's Operating Handbook and FAA Approved Airplane Flight Manual.

FAA APPROVED

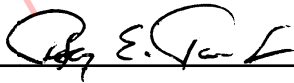

PETER E. PECK
D.O.A. NO. SO.-1
THE NEW PIPER AIRCRAFT, INC.
VERO BEACH, FLORIDA

DATE OF APPROVAL FEBRUARY 23, 1999

SECTION 1 - GENERAL

This supplement supplies information necessary for the operation of the airplane when the optional Emergency Oxygen System is installed in accordance with FAA Approved Piper Data.

SECTION 2 - LIMITATIONS

The following placard is installed on the right cabin side panel, immediately forward of the copilot's air vent, and the right aft facing seat, aft of the air vent.

EMERGENCY OXYGEN

**IN DRAWER UNDER SEAT PULL MASK
OUT OF DRAWER FULLY AT FULL
EXTENSION GIVE CORD A TUG
MAXIMUM DURATION = 15 MINS
SEE POH
NO SMOKING WHILE IN USE**

**FOR REFERENCE ONLY
NOT FOR FLIGHT**

SECTION 3 - EMERGENCY PROCEDURES

In the event that the emergency oxygen system is needed, proceed as follows:

- Mask compartment(s)OPEN
- MaskREMOVE and extend lanyard to full length; tug to activate generator. Unfold and don mask(s).
- Flow Indicator(s)green area in bottom of accumulator INFLATES, indicating oxygen flow.
- Cabin Altitude.....REDUCE to a safe altitude consistent with terrain before the 15 minute oxygen supply is fully depleted.

NOTE

Descent should be started as soon as possible in order to assure that flow rate remains adequate throughout the descent. Refer to SECTION 3 of the basic POH and FAA Approved AFM for emergency descent procedures. This system, once activated, cannot be turned off.

WARNING

No smoking while oxygen is in use. Remove oil and grease (including lipstick, chapstick, makeup, etc.) before using oxygen.

SECTION 4 - NORMAL PROCEDURES

Prior to each flight, turn on the master switch and check that the amber OXYGEN annunciator light is not illuminated. If the annunciator is illuminated, one or more of the oxygen generators should be replaced. In addition, check the oxygen masks and hoses for accessibility and condition.

SECTION 5 - PERFORMANCE

No change.

SECTION 6 - WEIGHT AND BALANCE

Factory installed optional equipment is included in the licensed weight and balance data in Section 6 of the Airplane Flight Manual.

**SECTION 7 - DESCRIPTION AND OPERATION OF THE
EMERGENCY OXYGEN SYSTEM**

The optional emergency oxygen system consists of three "two-man" chemical oxygen generators, which provide sufficient oxygen flow for six people, during a descent from 25,000 feet to 12,000 feet or below, for a 15 minute time period. Once an oxygen generator is activated, it will continue to produce oxygen until depleted; no shut-off provisions are provided. Each generator has two oxygen masks connected, either of which is capable of activating the generator. The masks are accessible from each crew/passenger seat.

The system consists of two major assemblies, the crew assembly and the passenger assembly.

The crew assembly is located under the copilot's seat and contains one two-man oxygen generator and two masks mounted on a sliding tray. The tray is accessible from the aisle between the pilot's and copilot's seats and is pulled out from under the seat to expose the two masks. Each mask is connected to the generator with a clear plastic tube and lanyard. The tube delivers oxygen to the mask when the lanyard is pulled out, releasing the firing mechanism, which activates a chemical reaction within the oxygen generator. Each generator has two over-pressure relief valves to prevent excessive pressure in the generator, in the event of a malfunction or delivery tube restriction. When activated, the generator delivers oxygen to both attached masks simultaneously.

The passenger assembly is located in the drawer in the right aft facing passenger seat base. The drawer is accessible from the aft side of the base, under the seat bottom and is pulled aft to expose the four masks. The two inboard masks are attached to one generator, while the two outboard masks are attached to the second generator. Either of the four masks will reach any of the four passenger seat locations. Activation of the generators is the same as the crew installation; pulling out the lanyard attached to the mask. Operation of the passenger provisions are identical to that of the crew.

Placards are provided on the side panel outboard of the copilot's seat and the right aft facing seat, stating the location and operation of the oxygen system, and that smoking is prohibited while oxygen is in use.

An amber OXYGEN annunciator is provided to inform the crew whenever either of the three oxygen generators has been activated. The annunciator light is operated by a micro switch adjacent to each generator firing mechanism. The light will continue to be illuminated until the generator is replaced with a full one with an untripped firing mechanism.

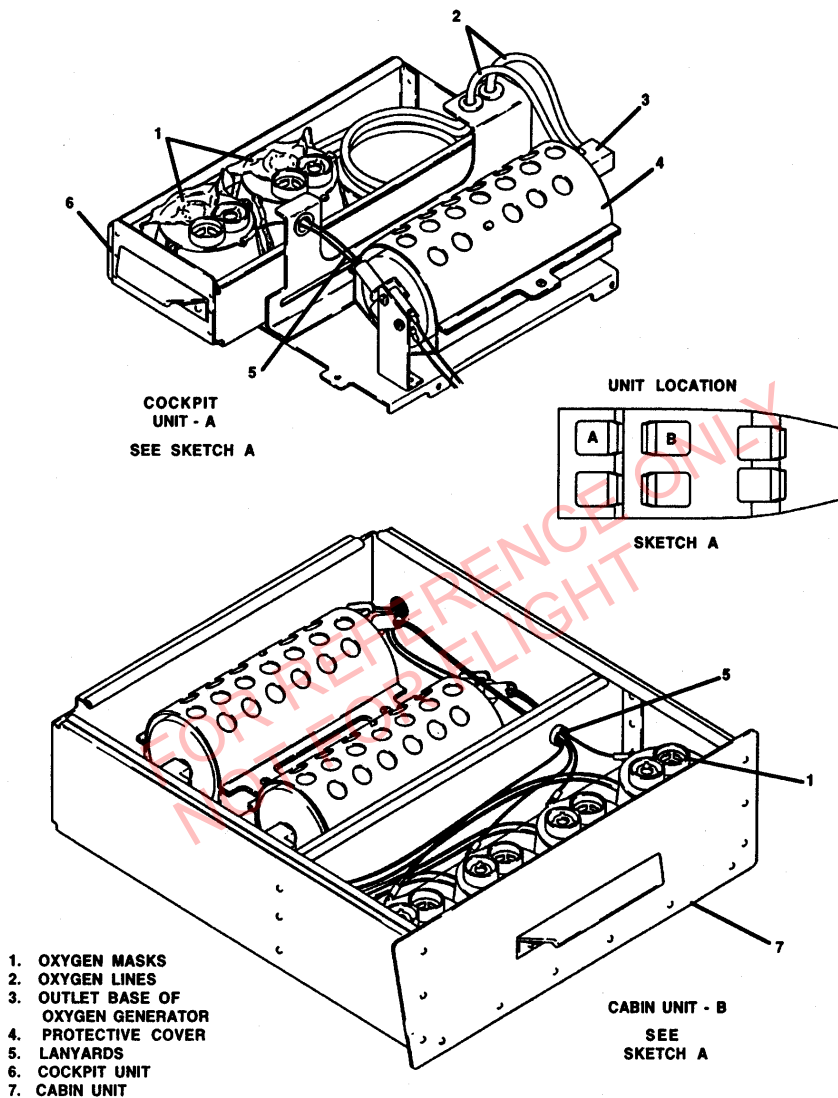

OXYGEN SYSTEM INSTALLATION

Figure 7-1.

**PILOT'S OPERATING HANDBOOK
AND
FAA APPROVED AIRPLANE FLIGHT MANUAL**

**SUPPLEMENT NO. 2
FOR
PROPELLER HEAT, HEATED WINDSHIELD AND
WING ICE DETECTION LIGHT**

This supplement must be attached to the Pilot's Operating Handbook and FAA Approved Airplane Flight Manual when any or all of the following equipment is installed per the appropriate Piper Drawing: Prop Heat - Dwg. No. 89664, Heated Windshield - Dwg. No. 82288 and Wing Ice Detection Light - Dwg. No. 83978.

The information contained herein supplements or supersedes the information in the basic Pilot's Operating Handbook and FAA Approved Airplane Flight Manual only in those areas listed herein. For limitations, procedures and performance information not contained in this supplement, consult the basic Pilot's Operating Handbook and FAA Approved Airplane Flight Manual.

FAA APPROVED _____

PETER E. PECK
D.O.A. NO. SO.-1
THE NEW PIPER AIRCRAFT, INC.
VERO BEACH, FLORIDA

DATE OF APPROVAL FEBRUARY 23, 1999

SECTION 1 - GENERAL

This supplement supplies information necessary for the operation of the airplane when the optional propeller heat, heated windshield, and wing ice detection light are installed in accordance with FAA Approved Piper data.

SECTION 2 - LIMITATIONS

- (a) This aircraft is not approved for flight in icing conditions. (See Supplement 3, Section 2 (a) Limitations.)
- (b) Under no circumstances should the heated windshield be turned on for a period exceeding 20 seconds unless the aircraft is in flight.

SECTION 3 - EMERGENCY PROCEDURES

No change.

SECTION 4 - NORMAL PROCEDURES

The equipment should be functionally checked for proper operation prior to flight.

CAUTION

Do not operate propeller deice in ambient temperatures above 50° F to avoid damage to prop deicers..

A check of the heated propeller can be performed by turning the PROP HEAT switch ON and feeling the deice pads. The pads should become warm to the touch.

CAUTION

To avoid possible windshield damage during ground operations, or during testing, do not turn the WSHLD HI switch ON for more than 20 seconds.

An operational check of the heated windshield may be done only if the ambient temperature of the windshield is less than 115°F (46°C), and the engine is running. To accomplish the check, turn one alternator OFF. Then, while observing the operating alternator's ammeter, select "WSHLD LO" switch to on by pressing once, then press again to turn off. Press the "WSHLD HI" switch to turn on, then press again to turn off. A load increase of approximately 13 amps when set to LOW, with an approximate 10 amp *additional* increase when set to HIGH, indicates normal operation.

When in visible moisture at temperatures at or below +5°C and icing conditions are anticipated, turn on the windshield heat LO switch. If low windshield heat is inadequate or if icing is encountered at temperatures at or below -15°C, turn on the windshield heat HI switch.

NOTE

Depending on ambient temperatures, when switching from HIGH to LOW windshield heat, a WINDSHIELD HEAT FAIL annunciation may occur until the windshield surface temperature cools to the low heat temperature range.

CAUTION

The "Windshield Heat Fail" annunciator light will illuminate when a failure in the temperature sensor has occurred. As a result of this failure a possible over temp. of the windshield may result with windshield heat switch HI or LO turned on. In the event of the illumination of this annunciator the windshield heat switches should IMMEDIATELY be placed in the OFF position. Failure to select windshield heat OFF could result in severe damage to the windshield.

Windshield heat may be used to help clear the windshield during descent from high altitude.

SECTION 5 - PERFORMANCE

No change.

SECTION 6 - WEIGHT AND BALANCE

Factory installed optional equipment is included in the licensed weight and balance data in Section 6 of the Pilot's Operating Handbook.

SECTION 7 - DESCRIPTION AND OPERATION OF PROPELLER HEAT, HEATED WINDSHIELD, AND WING ICE DETECTION LIGHT

The presence of one or more items of deicing equipment does not imply the capability to fly into forecast or known icing. The equipment is provided to enlarge the options available to the pilot as he takes appropriate action to avoid icing that is inadvertently encountered.

Controls for the components are situated in the switch panel located above the right radio stack. (Figure 2-1).

WING ICE DETECTION LIGHT

Wing icing conditions may be detected during night flight by use of an ice detection light installed on the left side of the forward fuselage. The light is controlled by an ICE LIGHT switch (Figure 2-1) situated in the switch panel located above the right radio stack. Circuit protection is provided by an ICE circuit breaker located in the EXTERIOR LIGHTS section of the pilot's aft circuit breaker panel.

PROPELLER HEAT

Electrothermal propeller heat pads are bonded to a portion of the leading edges of the propeller blades. The system is controlled by an ON-OFF type PROP HEAT switch (Figure 2-1) situated in the switch panel located above the right radio stack. Power for the propeller heat is supplied by the aircraft electrical system through a PROP HEAT circuit breaker on the pilot's aft circuit breaker panel. When the PROP HEAT switch is actuated, power is applied to a timer which monitors the current through the propeller heat system.

Power from the timer is cycled to brush assemblies which distribute power to slip rings. The current is then supplied from the slip rings directly to the electrothermal propeller heat pads.

The Hartzell propeller is heated in a cycle which applies power to the heat pads for approximately 90 seconds and then shuts off for approximately 90 seconds. Once begun, cycling will proceed in the above sequence and will continue until the system is turned off. The steady illumination of the PROP HEAT switch green LED indicates the portion of the cycle when power is being applied to the heat pads. A flashing annunciator indicates the 90 second cycle in which power has been removed from the heat pads.

A ground test of the prop heat can be accomplished by depressing the prop heat switch to "on" prior to takeoff. During this ground test when heat is being applied to the propeller the green LED in the prop heat switch will flash rapidly for approximately 30 seconds, indicating the heater is in the "on" cycle. After approximately 30 seconds, the flash rate is reduced, indicating the prop heat is in the "off" cycle. The green LED will continue to flash at the slower rate as long as the aircraft is on the ground "on" until the pilot de-selects the prop heat switch.

The propeller designation is: HC-13YR-1E/7890K (3 Blade)

ELECTRIC HEATED WINDSHIELD

WARNING

Flight into known or forecast icing is not approved. If icing is encountered, take avoidance action immediately.

The electrically heated left windshield is controlled by two switches in the switch panel. One switch controls low windshield heat and the other high heat, and are labeled accordingly. To switch from LOW HEAT to HIGH HEAT, you must first de-select the LOW HEAT prior to selecting HIGH WSHLD HEAT. Circuit protection is provided by the windshield CONTROL and POWER breakers in the ICE PROTECTION section of the pilot's aft circuit breaker panel.

CAUTION

To avoid possible windshield distortion during ground operations, or during testing, do not turn on the WSHLD HI switch for more than 20 seconds.

**DEICE SWITCH PANEL**

Figure 2-1

A pre-takeoff operational check of the heated windshield may be done only if the ambient temperature of the windshield is less than 115°F (46°C), and the engine is running. To accomplish the check, turn one alternator OFF. Then, while observing the operating alternator's ammeter, select, first LOW WSHLD HEAT, and then to HIGH WSHLD HEAT. A load increase of approximately 13 amps when set to LOW, with an approximate 10 amp *additional* increase when set to HIGH, indicates normal operation.

**PILOT'S OPERATING HANDBOOK
AND
FAA APPROVED AIRPLANE FLIGHT MANUAL
SUPPLEMENT NO. 3
FOR
ICE PROTECTION SYSTEM
(APPROVED FOR FLIGHT INTO KNOWN ICING CONDITIONS)**

This supplement must be attached to the Pilot's Operating Handbook and FAA Approved Airplane Flight Manual when Ice Protection System, per Piper Drawing No. 89695-2, is installed. The information contained herein supplements or supersedes the information in the basic Pilot's Operating Handbook and FAA Approved Airplane Flight Manual only in those areas listed herein. For limitations, procedures and performance information not contained in this supplement, consult the basic Pilot's Operating Handbook and FAA Approved Airplane Flight Manual.

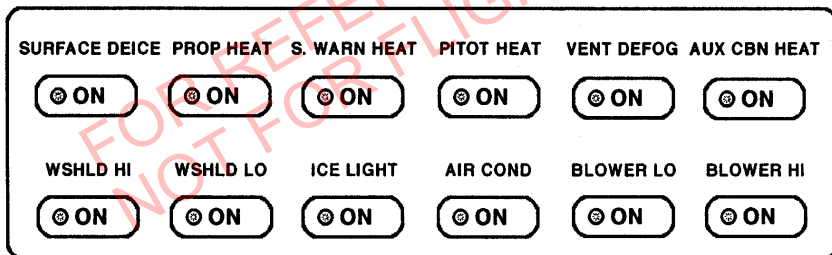
FAA APPROVED

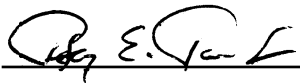

PETER E. PECK
D.O.A. NO. SO.-1
THE NEW PIPER AIRCRAFT, INC.
VERO BEACH, FLORIDA

DATE OF APPROVAL FEBRUARY 23, 1999

SECTION 1 - GENERAL

This supplement supplies information necessary for the operation of the airplane when the optional Ice Protection System is installed in accordance with FAA Approved Piper data.

SECTION 2 - LIMITATIONS

- (a) The ice protection system was designed and tested for operation in the meteorological conditions of FAR 25, Appendix C, for continuous maximum and intermittent maximum icing conditions. **The ice protection system was not designed or tested for flight in freezing rain and/or mixed conditions or for icing conditions more severe than those of FAR 25, Appendix C. Therefore, flight in those conditions may exceed the capabilities of the ice protection system.**
- (b) Equipment required for flight into known or forecast icing:
- (1) Pneumatic wing and empennage boots and SURF DEICE annunciation.
 - (2) Wing ice detection light.
 - (3) Electrothermal propeller deice pads on the propeller blades.
 - (4) Electrically heated windshield and WSHLD HEAT annunciation.
 - (5) Heated lift detector.
 - (6) Heated pitot head.
 - (7) Dual alternators.
 - (8) Dual vacuum pumps.
 - (9) Alternate static source.
 - (10) All equipment required for night IFR flight.
- (c) If all the equipment listed is not installed and operative, the following placard must be installed in full view of the pilot.

WARNING

**THIS AIRCRAFT IS NOT APPROVED FOR
FLIGHT IN ICING CONDITIONS.**

SECTION 3 - EMERGENCY PROCEDURES

WARNING

The malfunction of any required deice equipment requires immediate action to exit icing conditions. Depending on the severity of the icing encounter, failure to take immediate positive action can lead to performance losses severe enough to make level flight impossible. Therefore, upon verification of a system malfunction or failure, climb or descend out of icing conditions if this provides the shortest route. If exit must be made in level flight, consider the use of maximum power and exit by the most direct route. The effect of the additional fuel burned at higher power settings on aircraft range must be considered and an alternate airport chosen if necessary.

ALTERNATOR FAILURE IN ICING CONDITIONS (ALTERNATOR #1 INOP or ALTERNATOR #2 INOP annunciator light illuminated)

NOTE

Anytime total tie bus voltage is below 25 Vdc, the LOW BUS VOLTAGE annunciator will illuminate.

- Verify failure.....CHECK AMMETER
- Electrical load (if Low Bus Voltage annunciator illuminated)Reduce until load is less than 75 amps & LOW BUS VOLTAGE annunciator extinguished.
- Failed ALTR switchOFF
- Failed ALTR circuit breakerCHECK and RESET as required
- Failed ALTR switch (after OFF at least one second)ON
- If power not restored:
- Failed ALTR switchOFF
- Ammeter.....Monitor and maintain below 75 amps

While one alternator will supply sufficient current for minimum required avionics and cockpit lighting, use of deicing equipment, particularly windshield or propeller heat, may be limited. Immediate action should be taken to avoid or exit icing conditions. Under no circumstances may the total electrical load exceed 75 amps. The electric cabin heater, cabin recirculation blowers, and position, strobe, and landing lights should not be used unless absolutely necessary.

SINGLE VACUUM PUMP FAILURE IN ICING CONDITIONS (Reduced suction pressure and left or right vacuum inoperative annunciator illuminate)

Gyro Suction Gauge.....Check (within normal operating range)
Operative Pump vacuum inoperative annunciator.....extinguished

Although either vacuum pump has sufficient capacity to operate the deice boots and flight instruments in a normal manner, immediate action should be taken to exit icing conditions.

PROPELLER HEAT SYSTEM MALFUNCTION

Excessive vibration may be an indication that the propeller heat is not functioning properly.

Propeller controlexercise
Propeller heat annunciatorcheck for proper indications:
(a) ON for approx. 90 seconds
(b) OFF (flashing)
for approx. 90 seconds

Illumination of the prop heat deice fail annunciator is an indication that the propeller blades may not be deicing properly.

PROP HEAT switchOFF if failure is indicated

NOTE:

A flashing Prop Heat selector switch LED is an indication that the 90 second off cycle is activated.

WARNING

It is imperative that the PROP HEAT switch be turned OFF if vibration persists. This can be a symptom of uneven blade deicing which can lead to propeller unbalance and engine failure.

Immediate action should be taken to exit icing conditions.

SURFACE DEICE MALFUNCTION

If SURFACE DE-ICE annunciator light remains illuminated more than 30 seconds, pull the surface deice circuit breaker. Immediate action should be taken to exit icing conditions.

WINDSHIELD ANTI-ICE HEAT MALFUNCTION

If WINDSHIELD HEAT FAIL annunciator illuminates, immediately select WSHLD HI or WSHLD LO switch to OFF. Take immediate action to exit icing conditions.

SECTION 4 - NORMAL PROCEDURES

The Piper Malibu is approved for flight into known icing conditions when equipped with the complete Piper Ice Protection System. Operating in icing conditions of Continuous Maximum and Intermittent Maximum as defined in FAR 25, Appendix C has been substantiated; however, there is no correlation between these conditions and forecasts of reported "Light, Moderate and Severe" conditions. **Flight into severe icing is not approved.**

Icing conditions can exist in any clouds when the temperature is below freezing; therefore it is necessary to closely monitor outside air temperature when flying in clouds or precipitation. Clouds which are dark and have sharply defined edges usually have high water content and should be avoided whenever possible. **Freezing rain must always be avoided.**

Pneumatic boots must be cleaned regularly for proper operation in icing. The exterior surfaces of the aircraft should be checked prior to flight. **Do not attempt flight with frost, ice or snow adhering to the exterior surfaces of the aircraft or landing gear.**

Prior to dispatch into forecast icing conditions all ice protection equipment should be functionally checked for proper operation.

PREFLIGHT*CAUTION*

To avoid possible windshield distortion during ground operations, or during testing, do not position the WSHLD HEAT switch to HIGH for more than 20 seconds.

- (a) A check of the heated propeller should be performed by pressing "prop heat" button on switch panel. The green lamp in the "prop heat" button will start to flash rapidly for 30 seconds indicating the heater is in the "on" cycle.

After 30 seconds, the flash rate is reduced, indicating the heater is in the “off” cycle. The green lamp will continue to flash at the slower flash rate as long as the aircraft is on the ground or until the pilot de-selects “prop heat” on the switch panel.

CAUTION

Care should be taken when an operational check of the heated pitot head and heated lift detector is being performed. The units become very hot.

- (b) A check of the heated pitot head and lift detector should be performed by turning the S. WRN HEAT and PITOT HEAT switches ON and touching the units.
- (c) The surface boots should be checked prior to flight for damage and cleanliness. If necessary, damage should be repaired and boots cleaned prior to flight. An operational check of the boot system should be performed during engine run-up at 2000 RPM as follows:
 - (1) Actuate the momentary SURFACE DE-ICE switch - the boots will inflate through three phases: empennage, lower wing and upper wing with a duration of approximately six seconds per phase. The surface boot system then remains off until the switch is activated again. A green SURFACE DE-ICE annunciator light will remain on for approximately eighteen seconds.
 - (2) Visually check to insure that the boots have fully deflated to indicate proper operation of the vacuum portion of the pneumatic boot pump system.
- (d) An operational check of the heated windshield may be done only if the ambient temperature of the windshield is *less* than 115°F (46°C), and the engine is running. To accomplish the check, turn one alternator OFF. Then, while observing the operating alternator’s ammeter, press WSHLD LO to ON, a load increase of approximately 13 amps will be seen on aircraft ammeter. Press WSHLD HI to ON, a load increase of 10 additional amps indicates normal operation. Press WSHLD HI and WSHLD LO switches to the OFF position.
- (e) Check the operation of both alternators by observing that both ammeters indicate an output.
- (f) During engine run-up, check that both vacuum pumps are operating by observing that both the left and right vacuum inop. annunciators are extinguished.

IN FLIGHT

Icing conditions of any kind should be avoided whenever possible, since any minor malfunction which may occur is potentially more serious in icing conditions. Continuous attention of the pilot is required to monitor the rate of ice build-up in order to effect the boot cycle at the optimum time. Boots should be cycled when ice has built to between 1/4 and 1/2 inch thickness on the leading edge to assure proper ice removal. Repeated boot cycles at less than 1/4 inch can cause a cavity to form under the ice and prevent removal; boot cycles at thicknesses greater than 1/2 inch may also fail to remove ice.

Before entering probable icing conditions use the following procedures:

- (a) INDUCTION AIRALTERNATE
- (b) PITOT HEAT switchON
- (c) S. WRN HEAT switchON
- (d) WSHLD LO switchON (WSHLD HI in actual ice)
- (e) PROP HEAT switchON
- (f) DEFROST knobOUT
- (g) VENT/DEFOG BLWR switchON, if additional
defrost is desired
- (h) SURFACE DEICE switchactivate after 1/4 to 1/2
inch accumulation
- (i) Relieve propeller unbalance (if required) by exercising propeller control briefly. Repeat as required.

NOTE

For accurate magnetic compass readings, turn the WSHLD LO and HI, PROP HEAT and PITOT HEAT switches OFF momentarily.

WARNING

Do not cycle surface boots with less than 1/4 inch of ice accumulation. Operation of boots with less than 1/4 inch of ice accumulation can result in failure to remove ice. Do not hold the momentary SURFACE DEICE switch on.

WARNING

Elevator movement should be periodically checked prior to the first surface boot inflation in order to prevent an ice cap from forming between the elevator and stabilizer.

CAUTION

Operation of the pneumatic deice system is not recommended in temperatures below -40°C. Such operation may result in damage to the deicer boots.

Both alternator ammeters should be monitored whenever the deice equipment is in use. An excessive indication shows an excessive electrical load, which may cause a battery discharging condition that could eventually lead to battery depletion. Nonessential electrical equipment should be turned off to correct or prevent this condition.

NOTE

Anytime total tie bus voltage is below 25 Vdc, the LOW BUS VOLTAGE annunciator will illuminate.

When ice has accumulated on the unprotected surfaces of the airplane, aerodynamic buffet commences 5 to 19 knots before the stall. A substantial margin of airspeed should be maintained above the normal stall speed, since the stall speed will increase in prolonged icing encounters. For the same reason, stall warning devices are not accurate and should not be relied upon.

If ice is remaining on the unprotected surfaces of the airplane at the termination of the flight, the landing can be made using full flaps and carrying a slight amount of power whenever practical. If ice removal from the protected surfaces cannot be accomplished (ie. due to a failure of the surface deice system) prior to the approach, the flaps must be left in the full up position. Approach speeds should be increased by 10 to 15 knots. Allow for increased landing distance due to the higher approach speeds.

CAUTION

If cruise airspeed drops below 130 knots in icing conditions, increase power to maintain 130 knots. If maximum continuous power is required to maintain 130 knots, immediate action should be taken to exit icing conditions.

NOTE

An icing encounter can render the aircraft radar unreliable due to beam reflection off of the ice layer on the radome. Also, there may be a degradation of communication and navigation equipment due to ice accumulation on antennas.

SECTION 5 - PERFORMANCE

Climb speed should be increased to 130 knots when icing conditions are encountered during climb.

Cruise speeds are reduced approximately 5 knots when the surface boots are installed.

CAUTION

Ice accumulation on the unprotected surfaces can result in significant performance loss. During cruise, loss of airspeed can be as much as 30 knots or more.

NOTE

When icing conditions are encountered, loss of cruise airspeed and increased fuel flow resulting from higher than normal power settings to maintain altitude will reduce the aircraft range significantly. The use of an alternate airport should be considered if fuel quantity appears marginal.

CAUTION

If cruise airspeed drops below 130 knots in icing conditions increase power to maintain 130 knots. If maximum continuous power is required to maintain 130 knots immediate action should be taken to exit icing conditions.

NOTE

For additional general information on inflight icing refer to FAA Advisory Circular 91-51, Airplane Deice and Anti-ice Systems.

SECTION 6 - WEIGHT AND BALANCE

Factory installed optional equipment is included in the licensed weight and balance data in Section 6 of the Airplane Flight Manual.

SECTION 7 - DESCRIPTION AND OPERATION OF THE ICE PROTECTION SYSTEM AND EQUIPMENT

For flight into known icing conditions (FIKI), a complete ice protection system is required on the Malibu.

The complete ice protection system consists of the following components: Pneumatic wing and empennage boots, wing ice detection light, electrothermal propeller deice pads, electrically heated windshield, heated lift detector, heated pitot head, two operating alternators, two operating vacuum pumps and the alternate static source. Alternator controls are located on the left overhead switch panel. Controls for the ice protection components are located above the right radio stack (Figure 7-1).

A single component or a combination of components may be installed. However, the warning placard specified in Section 2 of this supplement is required when the complete system is not installed. Such a placard is also required if any component is inoperative.

The aircraft is designed to allow operation in the meteorological conditions of the FAR 25 envelopes for continuous maximum and intermittent maximum icing. **The airplane is not designed to operate for an indefinite period of time in every icing condition encountered in nature.** Activation of the ice protection system prior to entering icing conditions and attempting to minimize the length of the icing encounter will contribute significantly to the ice flying capabilities of the airplane.

WING AND EMPENNAGE BOOTS

Pneumatic deice boots are installed on the leading edges of the wing, the vertical stabilizer and the horizontal stabilizer. During normal operation, when the surface deice system is turned off, the engine driven vacuum pumps applies a constant suction to the boots to provide smooth, streamlined leading edges. The boots are inflated by a momentary ON type SURF DE-ICE switch (Figure 7-1) located on the deice switch panel. Actuation of the SURF DE-ICE switch activates two pressure regulator valves (one for each vacuum pump) which energizes three (tail, lower wing & upper wing)

deice flow valves for approximately six seconds. The boot solenoid valves are activated and air pressure is released to the boots, sequentially inflating the surface deicers. A SURFACE DE-ICE indicator light, located on the annunciator panel illuminates when the boots inflate. When the cycle is complete, the deicer solenoid valves permit automatic overboard exhaustion of pressurized air. Suction is then reapplied to the boots.

Circuit protection for the surface deice system is provided by a SURF DEICE circuit breaker located on the pilot's aft circuit breaker panel.

WING ICE DETECTION LIGHT

Wing icing conditions may be detected during night flight by use of an ice detection light installed on the left side of the forward fuselage. The light is controlled by an ICE LIGHT switch (Figure 7-1) located on the switch panel. Circuit protection is provided by an ICE circuit breaker located in the EXTERIOR LIGHTS section of the pilot's aft circuit breaker panel.

ELECTRIC PROPELLER DEICE

Electrothermal propeller deice pads are bonded to a portion of the leading edges of the propeller blades. The system is controlled by an ON-OFF type PROP HEAT switch (Figure 7-1) located on the deice switch panel. Power for the propeller deicers is supplied by the aircraft electrical system through a PROP HEAT circuit breaker on the pilot's aft circuit breaker panel. When the PROP HEAT switch is actuated, power is applied to a timer which monitors the current through the propeller deice system.

Power from the timer is cycled to brush assemblies which distribute power to slip rings. The current is then supplied from the slip rings directly to the electrothermal propeller deice pads.

The Hartzell propeller is deiced in a cycle which applies power to the deice pads for approximately 90 seconds and then shuts off for approximately 90 seconds. Once begun, cycling will proceed in the above sequence and will continue until the system is turned off. The PROP HEAT switch green LED should indicate green during the portion of the cycle when power is being applied and flashes during the off cycle.

The propeller designation is: HC-I3YR-1E/7890K. (3 blade)

The heat provided by the deice pads reduces the adhesion between the ice and the propeller so that centrifugal force and the blast of the airstream cause the ice to be thrown off the propeller blades in small pieces.

ELECTRICALLY HEATED WINDSHIELD

The electrically heated left windshield is heated by current from the aircraft electrical system. It is controlled by WSHLD HI and WSHLD LO switches located on the switch panel. Circuit protection is provided by the windshield CONTROL and POWER circuit breakers in the ICE PROTECTION section of pilot's aft circuit breaker panel.

CAUTION

To avoid possible windshield distortion during ground operations, or during testing, do not turn the WSHLD HI switch to ON for more than 20 seconds.

Windshield heat is an anti-ice device, which must be activated prior to entering suspected icing. Sudden penetration into icing conditions, with the heat OFF, will greatly reduce its effectiveness to prevent or eliminate windshield ice. Windshield heat can also be used to prevent windshield fog.

An overtemperature sensor is included as an integral part of the heated windshield. A system failure causing an overtemperature condition will illuminate the WINDSHIELD HEAT FAIL light located in the annunciator panel. In this eventuality the heated windshield should immediately be selected OFF.

HEATED LIFT DETECTOR

A heated lift detector is installed on the left wing. It is controlled by a S. WRN HEAT switch located on the switch panel and is protected by a STALL HEAT circuit breaker located in the ICE PROTECTION section of the pilot's aft circuit breaker panel. The lift detector has an in-line resistor activated by the main gear squat switch which limits the ground electrical load to approximately 33 percent of the inflight load. This allows the lift detector to be ground checked and activated prior to flight without damaging the unit.

CAUTION

Care should be taken when an operational check of the heated lift detector is being performed on the ground. The unit becomes very hot.

HEATED PITOT HEAD

A heated AN type head is installed under the the wing. It is controlled by an ON-OFF type PITOT HEAT switch located on the switch panel and is protected by a PITOT HEAT circuit breaker located in the ICE PROTECTION section of the pilot's aft circuit breaker panel.

CAUTION

Care should be taken when an operational check of the heated pitot head is being performed on the ground. The unit becomes very hot.

DUAL ALTERNATORS

Dual 28 volt, 75 amp alternators are installed as standard equipment. Both alternators must be operational for flight in icing conditions. They are controlled by ON-OFF type switches labeled ALTR NO 1 and ALTR NO 2 located in the overhead switch panel (Figure 7-2). Circuit protection is provided by similarly labeled circuit breakers located on the TIE BUS circuit breaker panel. During normal operation both alternators must be turned ON. The system is designed so that the alternators will share the total load equally. If either ALTR switch is turned OFF the appropriate annunciator light (ALTERNATOR 1 INOP or ALTERNATOR 2 INOP) will illuminate and remain lit.

DUAL VACUUM PUMPS

Dual engine driven vacuum pumps are installed as standard equipment. Both pumps operate continuously when the engine is running. While either pump independently is capable of operating the surface deice system, intentional or continued operations in icing conditions with only one operating vacuum pump is not recommended.

ALTERNATE STATIC SOURCE

An alternate static source control valve is located below the instrument panel to the left of the pilot. For normal operation, the lever remains down. To select alternate static source, place the lever in the up position. When the alternate static source is selected the airspeed and altimeter and vertical speed indicator are vented to the alternate static pad on the bottom aft fuselage. During alternate static source operation, these instruments may give slightly different readings. The pilot can determine the effects of the alternate sources at different airspeeds. Static source pads have been demonstrated to be non-icing; however, in the event icing does occur, selecting the alternate static source will alleviate the problem.

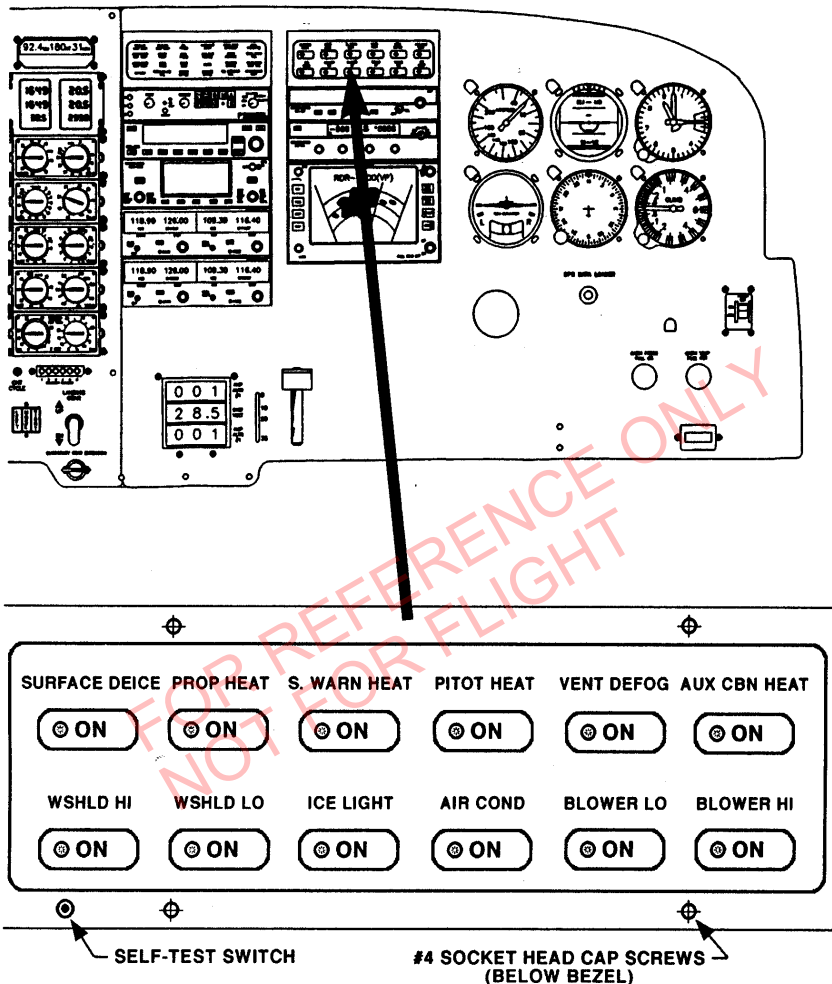

DEICE SWITCH PANEL

Figure 7-1

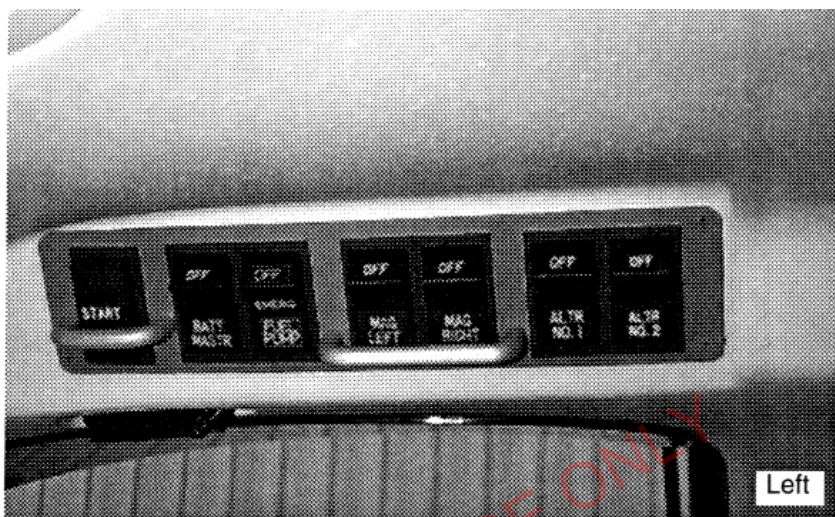

MAIN SWITCH PANEL
(OVERHEAD LEFT & RIGHT)

Figure 7-2

**PILOT'S OPERATING HANDBOOK
AND
FAA APPROVED AIRPLANE FLIGHT MANUAL
SUPPLEMENT NO. 4
FOR
B.F. GOODRICH
INTEGRATED ICE DETECTION SYSTEM**

This supplement must be attached to the Pilot's Operating Handbook and FAA Approved Airplane Flight Manual when the B.F. Goodrich Integrated Ice Detection System is installed. The information contained herein supplements or supersedes the information in the basic Pilot's Operating Handbook and FAA Approved Airplane Flight Manual only in those areas listed herein. For limitations, procedures and performance information not contained in this supplement, consult the basic Pilot's Operating Handbook and FAA Approved Airplane Flight Manual.

FAA APPROVED



PETER E. PECK
D.O.A. NO. SO.-1
THE NEW PIPER AIRCRAFT, INC.
VERO BEACH, FLORIDA

DATE OF APPROVAL FEBRUARY 23, 1999

SECTION 1 - GENERAL

This supplement supplies information necessary for the operation of the airplane when the B.F. Goodrich Integrated Ice Detection System is installed in accordance with FAA Approved Piper Data.

SECTION 2 - LIMITATIONS

The B.F. Goodrich Smartboot Ice Detection is an advisory system only.

It is the pilots responsibility to monitor visually the leading edge surfaces and determine proper ice thickness to perform boot inflation.

SECTION 3 - EMERGENCY PROCEDURES

No Change:

SECTION 4 - NORMAL PROCEDURES

PREFLIGHT

During the preflight walk around, verify that the ice sensors are clear of ice.

To conduct a self test of the system turn the battery master switch on. This will supply power to the system for a complete system self test. During the self test, the prop deice fail, select deice, and the ice detector fail annunciators will flash momentarily in sequence, activate all at once, and then extinguish.

IN FLIGHT

The amber "Select Deice" annunciator is activated when the ice thickness reaches 1/4 inch or greater over the surface of the sensor in the vertical fin deicer.

When the amber "Select Deice" annunciator illuminates, indicating approximately 1/4 inch or more of ice on the tailplane, the pilot may choose to inflate the deice boots by pressing the "surface deice" switch or choose to wait until more ice forms on the wings.

IN FLIGHT (Cont'd)

If the ice is removed from the empennage following inflation, the "deice" annunciator will extinguish. If less than 90% of the ice cap located over the sensor within the right horizontal deicer has been removed, the select deice annunciator will remain illuminated. If a fault should develop with either the sensor or controller, the amber "ice detector fail" annunciator will illuminate.

CAUTION:

In the light to moderate icing conditions a smaller radius surface accretes ice faster than a larger radius surface. Therefore, the horizontal and vertical stabilizers will accrete ice faster than the main wing. This phenomenon is known as tailplane icing which can significantly reduce pitch control of the aircraft, particularly during flap extension for the approach and landing phases of flight.

In some cases the deice annunciator will illuminate before the main wing has accumulated 1/4 to 1/2 inch thickness of ice. Because the select deice light is illuminated when the ice thickness reaches 1/4 inch on the vertical fin deicer, the main wing may only have an ice thickness of 1/8 inch or slightly less. However, it may be prudent to inflate the deicer boots when the deice annunciator illuminates to ensure the tailplane is properly deiced especially prior to flap extension.

CAUTION:

It has been shown in icing wind tunnel tests at temperatures below -18°C (0°F), that after multiple deicer sheds, an ice cap may form which cannot be detected by the system sensors. Caution should be exercised when flying in icing conditions at cold temperatures, i.e. below -10°C ($+14^{\circ}\text{F}$).

In all cases, the most prudent course of action is to attempt to immediately exit the icing conditions as well as to use good pilot judgement.

SECTION 5 - PERFORMANCE

No change.

SECTION 6 - WEIGHT AND BALANCE

Factory installed optional equipment is included in the licensed weight and balance data in Section 6 of the Pilots Operating Handbook and Airplane Flight Manual.

**SECTION 7 - DESCRIPTION AND OPERATION OF THE
B.F. GOODRICH INTEGRATED ICE DETECTION SYSTEM**

The B.F. Goodrich Smartboot Ice Detection advises the pilot of the status of icing conditions on the empennage deicers of the aircraft. Electrical sensors are integrated directly into the surface of the vertical fin and right horizontal stabilizer deicers, which advise the presence / appropriate time to deice. The presence of ice and appropriate time to deice are measured by the sensor installed within the vertical fin deicer only. The sensor within the right horizontal stabilizer deicer advises the status of the detection system (ice detector fail annunciator).

These annunciators located within the annunciator panel make up the visual cues of the deice detector / deicer system. The "select deice" annunciator illuminates when 1/4 inch of ice has accumulated on the sensor located on the vertical fin. The "surface deice" annunciator will illuminate to advise the pilot of proper boot inflation. The "ice - detector fail" annunciator will illuminate when a fault is detected in ice detection system.

PILOT'S OPERATING HANDBOOK
SUPPLEMENT NO. 5
FOR
KING 150 SERIES FLIGHT CONTROL SYSTEM

This supplement has been DELETED as the FAA Approved Operational Supplement to the Bendix/King 150 Series Flight Control System as installed per STC SA1778CE-D. Bendix/King is responsible to supply and revise the operational supplement. It is permitted to include the Bendix/King supplement in this location of the Pilots Operating Handbook unless otherwise stated by Bendix/King.

**PILOT'S OPERATING HANDBOOK
AND
FAA APPROVED AIRPLANE FLIGHT MANUAL
SUPPLEMENT NO. 6
FOR
KING KAS 297B VERTICAL SPEED AND ALTITUDE SELECTOR**

This supplement has been DELETED as the FAA Approved Operational Supplement to the Bendix/King KAS 297B Vertical Speed And Altitude Selector is installed per STC SA1778CE-D. Bendix/King is responsible to supply and revise the operational supplement. It is permitted to include the Bendix/King supplement in this location of the Pilots Operating Handbook unless otherwise stated by Bendix/King.

**PILOT'S OPERATING HANDBOOK
AND
FAA APPROVED AIRPLANE FLIGHT MANUAL
SUPPLEMENT 7
FOR
3M (SERIES II) STORMSCOPE, WX-1000/WX-1000+**

This supplement must be attached to the Pilot's Operating Handbook and FAA Approved Airplane Flight Manual when the optional WX-1000/WX-1000+ Stormscope System is installed per Piper Dwg. CA-46-2-046. The information contained herein supplements or supersedes the information in the basic Pilot's Operating Handbook and FAA Approved Airplane Flight Manual only in those areas listed herein. For limitations, procedures, and performance information not contained in this supplement, consult the basic Pilot's Operating Handbook and FAA Approved Airplane Flight Manual.

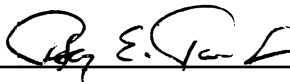
FOR REFERENCE ONLY
NOT FOR FLIGHT ONLY
FAA APPROVED

PETER E. PECK
D.O.A. NO. SO-1
THE NEW PIPER AIRCRAFT, INC.
VERO BEACH, FLORIDA

DATE OF APPROVAL FEBRUARY 23, 1999

SECTION 1 - GENERAL

This supplement supplies information necessary for the operation of the airplane when the optional WX-1000 or WX-1000+ Stormscope system is installed in accordance with FAA Approved Piper data.

SECTION 2 - LIMITATIONS

- (a) The WX-1000/WX-1000+ Stormscope system signal displays are not intended for the purpose of penetrating thunderstorm areas or areas of severe turbulence; such intentional use is not approved.

NOTE

Range selector determines receiver sensitivity and therefore relative range. Displayed range is based on signal strength and is not to be used for accurate determination of thunderstorm location.

- (b) The WX-1000 checklist functions are for reference only.
- (c) Placards

Located on the top of the throttle quadrant:

**STORMSCOPE NOT TO BE USED FOR
THUNDERSTORM AREA PENETRATION**

SECTION 3 - EMERGENCY PROCEDURES

No change.

SECTION 4 - NORMAL PROCEDURES

Normal operating procedures are outlined in the 3M Model, Series II, Stormscope Pilot's Handbook, P/N 75-0299-7690-1 (1191), latest revision.

SECTION 5 - PERFORMANCE

No change.

SECTION 6 - WEIGHT AND BALANCE

Factory installed optional equipment is included in the licensed weight and balance data in the Equipment List attached to the Pilot's Operating Handbook.

SECTION 7 - DESCRIPTION AND OPERATION

The 3M (Series II) Stormscope, WX-1000, weather mapping system provides a visual screen readout of the electrical discharges associated with thunderstorms. This information with proper interpretation, will allow the pilot to detect severe thunderstorm activity. A series of green dots will be displayed on the screen to indicate the electrical discharge areas. The display scope provides full scale selectable ranges of 200, 100, 50, and 25 nautical miles along with 30° azimuth sectors.

The WX-1000 has a heading stabilized display which automatically repositions thunderstorm information relative to the aircraft heading, eliminating the need to clear the display after each heading change. The "CLEAR" function remains useful for verifying thunderstorm information and for determining whether storm cells are building or dissipating. Heading information is displayed when operating in the weather modes and a "FLAG" advisory will appear in the event of heading source malfunction.

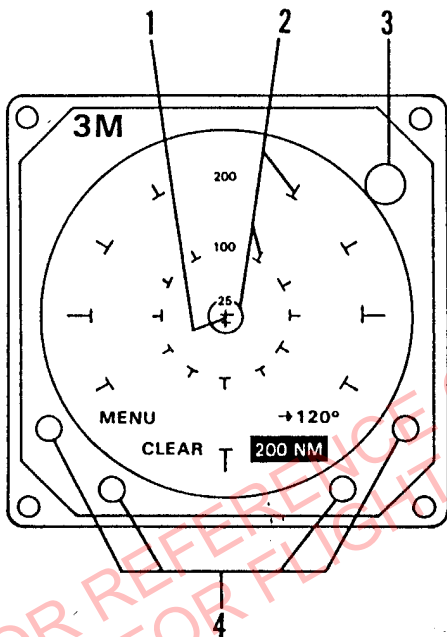

FOR REFERENCE ONLY
NOT FOR FLIGHT

1. MAPPING DIRECTION INDICATOR
2. RANGE REFERENCE
3. POWER/BRIGHTNESS
4. MOMENTARY CONTACT FUNCTION BUTTONS

WX-1000 STORMSCOPE

Figure 7-1

**PILOT'S OPERATING HANDBOOK
AND
FAA APPROVED AIRPLANE FLIGHT MANUAL
SUPPLEMENT NO. 8
FOR
BENDIX/KING EHI 40**

This supplement must be attached to the Pilot's Operating Handbook and FAA Approved Airplane Flight Manual when the optional Bendix/King EHI 40 EHSI system is installed per approved Piper drawings. The information contained herein supplements or supersedes the information in the basic Pilot's Operating Handbook and FAA Approved Airplane Flight Manual only in those areas listed herein. For limitations, procedures, and performance information not contained in this supplement, consult the basic Pilot's Operating Handbook and FAA Approved Airplane Flight Manual.

FAA APPROVED



PETER E. PECK
D.O.A. NO. SO-1
THE NEW PIPER AIRCRAFT, INC.
VERO BEACH, FLORIDA

DATE OF APPROVAL FEBRUARY 23, 1999

SECTION 1 - GENERAL

This supplement describes the components and operation of, and operational procedures for the Bendix/King EHI 40 Electronic Horizontal Situation Indicator (EHSI). The EHI 40 system utilizes the ED 461 display unit for display and control of navigation data and sensor selection. The SG 465 remote symbol generator interfaces with the navigation sensors to compute the EHSI display and data required by other systems on board the aircraft.

References throughout this supplement in regard to *on side* and *cross side* is as follows:

- Pilot on side - NAV 1
- Copilot on side - NAV 2
- Pilot cross side - NAV 2
- Copilot cross side - NAV 1

A. Abbreviations

ADF	Automatic Direction Finder
BRT	Bright
CRS	Course
CDU	Control Display Unit
DME	Distance Measuring Equipment
DTK	Desired Track
DU	Display Unit
EFIS	Electronic Flight Instrument System
EHSI	Electronic Horizontal Situation Indicator
GPS	Global Positioning System
GS	Glideslope
HSI	Horizontal Situation Indicator
ILS	Instrument Landing System
LOC	Localizer
MAG	Magnetic
MN	Minutes

SECTION 1 - GENERAL (Continued)

NAV	Navigation
NM	Nautical Miles
RNAV	Area Navigation
STBY	Standby
TST	Test
VAR	Variation
VOR	Very High Frequency Omni Range

SECTION 2 - LIMITATIONS

When installed in conjunction with navigation receivers (VOR, RNAV, GPS, ADF, compass systems, etc), display presentations and operations are subject to the identical limitations as identified for that same equipment if installed on aircraft.

Use of ARC COMPASS ROSE WITH NAV DISPLAY mode during instrument approaches is limited to inbound course only.

No yellow FAN or DU Flag may be visible prior to departure. (Exception: A 30 minute ferry flight to a repair facility in VFR conditions is permissible.)

Autopilot operations in HDG, NAV, or APR coupled modes with a failed EHI 40 display unit are not approved.

Flight Director coupled ADF tracking is not approved.

Autopilot coupled ADF tracking is not approved.

When ADF is selected as the primary navigation sensor the corresponding bearing pointer must also be set to ADF.

Maximum baggage aft compartment: 100 lbs.

Placards

Located on aft baggage closeout:

MAXIMUM BAGGAGE THIS COMPARTMENT 100 LBS.

SECTION 3 - EMERGENCY PROCEDURES

CAUTION

Following failure of a red gun in a display tube, red warning flags will not be visible.

SMALL RED SG ANNUNCIATION

Small red SG annunciation indicates an internal self-test failure. Automatic built-in test and monitoring functions integral to the EHI 40 software detect component failures and present failure annunciations on the face of the EHSI display. Continue operation with caution, verifying the validity of displayed data by reference to alternate instruments.

LARGE RED SG ANNUNCIATION

Large red SG annunciation indicates a catastrophic failure of the symbol generator. The EHI 40 display is not valid and further flight operations must be made by reference to alternate instruments.

RED CP ANNUNCIATION

Red CP annunciation indicates a control panel failure but could be as simple as a stuck key. Continue operation with caution, verifying the validity of displayed data by reference to alternate instruments.

NAV FAILURE DURING COUPLED AUTOPILOT OPERATION

WARNING

Autopilot is still coupled to lateral mode after failure. If the autopilot is not disengaged, invalid navigation information may cause the airplane to drift from the desired course.

SECTION 3 - EMERGENCY PROCEDURES (continued)**RED HDG ANNUNCIATION**

Red HDG annunciation indicates a failure in the compass system by removing the lubber line and replacing it with a red HDG flag. Simultaneously, the course pointer head and tail will declutter leaving the d-bar. (The d-bar will reorient on the face of the instrument providing horizontal deviation in the manner of a CDI.) The autopilot will disengage, if engaged.

CAUTION

If the compass card position is wrong, ADF bearing relative to the compass card, and RMI and MAP presentations relative to the nose of the aircraft will be in error. These presentations should be used with caution at the discretion of the pilot, or declutter. Reslave the compass card or slew the compass card to match magnetic compass if possible.

During a heading failure, the automatic Back Course function normally provided by the EHI 40 system is inhibited.

Pull and reset the DG and EFIS circuit breakers. If compass information is not restored, continued flight must be conducted by reference to the copilot DG or magnetic compass. Without heading information, the autopilot will not couple HDG, NAV, or APR, but can be used for attitude or altitude hold. If valid compass information is restored, the HDG flag will be replaced by the lubber line and normal operation of the EHI 40 may continue.

NOTE

Some avionics equipment other than the EHI 40, because of their internal circuit logic, will not restore heading information if a failure occurred in the compass reference voltage (EFIS circuit breaker) circuit. Consult component manufacturer's operating manual for procedure to restore heading information.

SECTION 3 - EMERGENCY PROCEDURES (continued)

HEADING OR COURSE KNOB FAILURE

Red flags will appear on the heading bug, or on the head and tail of the course pointer as appropriate. Autopilot will not couple HDG, NAV, or APR, but can be used for attitude or altitude hold.

EHI 40 DISPLAY UNIT FAILURE

A blank display indicates a power failure to the display unit. Pull and reset the EHSI circuit breaker. If display does not return, continue flight by reference to alternate instruments. Autopilot will not couple HDG, NAV, or APR, but can be used for attitude or altitude hold. If display returns, verify displayed data and continue flight.

YELLOW FAN ANNUNCIATION

Yellow fan annunciation indicates a failure of the symbol generator cooling fan. If a fan failure occurs in flight, continue operation with caution, verifying the validity of displayed data by reference to alternate instruments. Although a symbol generator failure is unlikely, consideration should be given to securing power to the symbol generator 30 minutes after failure and flying by reference to alternate instruments. The symbol generator can be disabled by pulling the EHSI circuit breaker.

SECTION 3 - EMERGENCY PROCEDURES (continued)

YELLOW DU ANNUNCIATION

Yellow DU annunciation indicates a failure of the EHSI cooling fan. If a fan failure occurs in flight, monitor the display presentation for an abnormal appearance which will indicate impending failure. System heating can be reduced by lowering the brightness of the presentation. Although an EHSI failure is unlikely, consideration should be given to securing power to the EHSI 30 minutes after failure and flying by reference to alternate instruments. The EHSI can be disabled by pulling the EHSI circuit breaker.

EHSI MISSING OR ABNORMAL DATA DISPLAY

If the data on the EHSI is missing or appears abnormal in flight, refer to alternate instruments for usable data for the remainder of the flight.

SECTION 4 - NORMAL PROCEDURES

PREFLIGHT CHECK

After engine start and radio master switch is ON, adjust the BRT knob to obtain a desirable brightness level of the EHSI display. After a two minute warm-up, press the TST/REF button for 3 seconds and release to activate the system self test and view all the fault presentations. A SELF TEST PASS or SELF TEST FAIL message will be annunciated. If the system is operating properly, SELF TEST PASS will be annunciated. If a malfunction exists, SELF TEST FAIL will be annunciated and the system should be serviced. To clear, press TST/REF button again. Additionally, the pilot should ensure that the compass scale is white, which indicates that all three colors are operational in the display unit.

SECTION 4 - NORMAL PROCEDURES (continued)

INFLIGHT OPERATION

CAUTION

Make transition from HSI presentations to conventional CDI presentations (MAP format) with caution. CDI left-right deviation may appear reversed when traveling outbound on a TO indication or inbound on a FROM indication. (Localizer CDI left-right deviation is automatically corrected by the EHI 40 to eliminate the need to fly reverse sensing on the back course. BC is annunciated and the CDI is corrected for proper steering commands when the airplane heading deviates more than 105° from the course pointer. The course pointer should be set to the localizer front course inbound heading.)

It is recommended that the autopilot be switched to HDG mode prior to switching nav sources when autopilot is coupled to NAV or APR modes.

CAUTION

Due to turn dynamics effect to ADF antenna (bank angle deviation from horizontal), CDI will cross over course line in opposite direction upon course intercept until aircraft is returned to level flight attitude.

SECTION 5 - PERFORMANCE

No changes.

SECTION 6 - WEIGHT AND BALANCE

Factory installed optional equipment is included in the licensed weight and balance data in Section 6 of the Pilot's Operating Handbook.

SECTION 7 - DESCRIPTION AND OPERATION

SYSTEM CONFIGURATION

- (1) Various configurations of the EHI 40 system are currently available to fulfill the particular needs of the user. These configurations are based on the number of symbol generators, and interfacing equipment.
- (2) The basic EHI 40 system consists of one ED 461 Display Unit (figure 7-1), one SG 465 Symbol Generator, and the associated navigation sensors .
- (3) The ED 461 Control Display Unit incorporates the EHSI mode controller in the bezel of the display. The mode controller offers a simple means for the pilot to select the desired display format, such as standard compass rose or sectored compass rose, 360 degree map or a sectored map. Also incorporated on the mode controller is the course and heading select knobs with auto sync. The auto sync feature will slew the heading bug to the lubber line or the course pointer direct to the selected nav sensor providing a centered course deviation bar.

SECTION 7 - DESCRIPTION AND OPERATION (Continued)

OPERATING CONTROLS

Figure 7-1 illustrates all operating controls for the EHI 40 systems. This figure may be referred to as the controls are in the following paragraphs.

1. 1-2 SYSTEM SELECT - The 1-2 button is used to cycle between primary navigation sensor system #1 and #2 for display. The primary NAV system selected is annunciated as sensor, sensor 1, or sensor 2 on the EHSI. Example, if the VOR 1 is being displayed and the 1-2 button is pressed, VOR 2 will become the displayed sensor. If only one sensor is installed, the display will not cycle and the sensor annunciation will not show a system number.
2. NAV SENSOR SELECT - During installation, the EHI 40 system was programmed with the type and quantity of each piece of interfacing equipment. Of all the equipment interfaced to the EHI 40, only a few sensors are usable for navigation. The EHI 40 creates and maintains in permanent memory a list of the usable navigation sensors.

The NAV push button is used to select the primary nav sensor which is annunciated on the left side of the display. A press of the NAV sensor select button sequentially selects the next available sensor from the list of those installed. DME information in the upper right corner, selected course, course pointer, and deviation bar are referenced to the selected primary nav sensor.

The following is a list, in order, of the possible primary navigation sensors that may be interfaced with the EHI 40:

VOR (VOR, LOC, VOR PAR, RNV, and RNV APR)
GPS, ADF

Only those sensors interfaced to the EHI-40 will be selectable for use and display.

SECTION 7 - DESCRIPTION AND OPERATION (Continued)

3. NUMBER 1 SYSTEM BEARING POINTER SELECT - The bearing pointer select button works similar to the NAV sensor select button. A press of the bearing pointer button sequentially selects the next available sensor for display. The bearing pointer select list contains only those sensors which are associated with the bearing. If the selected sensor has distance information paired with it, that distance will also be displayed in the lower left-hand corner along with the sensor annunciation.

The following is a list, in order, of the bearing pointer sensors that may be interfaced with the EHI 40:

DECLUTTER (no number one bearing pointer information is displayed)
VOR 1 (RNV 1)
GPS
ADF 1

Only those sensors installed in the airplane and interfaced to the EHI 40 will be selectable for use and display.

Only ADF bearing information will be available when LOC 1 is annunciated as the primary nav receiver.

4. HSI 360 DEGREE MODE SELECTION - The EHI 40 has three different 360 degree display formats: standard HSI compass rose, HSI NAV MAP mode, and HSI NAV MAP mode with radar. Each press of the HSI button sequentially selects the next display format. The display selection list may include the following:

HSI COMPASS ROSE WITH NAV DISPLAYS
HSI NAV MAP
HSI NAV MAP WITH RADAR

SECTION 7 - DESCRIPTION AND OPERATION (Continued)

5. ARC SECTORED MODE SELECTION - The ARC mode provides the pilot a large scale view of the CDI by presenting an approximate 85 degree sector display of the compass.

The EHI 40 has three possible ARC sectored display formats: standard HSI compass rose, ARC NAV MAP mode, and ARC NAV MAP mode with radar. A press of the ARC button will sequentially select the possible display formats.

A press of the ARC button while in the 360 degree mode will result in an ARC presentation of the same format. For example, if the 360 NAV MAP mode was being displayed and the ARC button was pressed, the resulting display format would be ARC NAV MAP. A press of the HSI button while in the ARC mode will change the display to the standard HSI compass rose.

The ARC display selection list may include the following:

ARC COMPASS ROSE WITH NAV DISPLAY
ARC NAV MAP
ARC NAV MAP WITH RADAR

6. NUMBER 2 SYSTEM BEARING POINTER SELECT - The bearing pointer select button works similar to the NAV sensor select button and the Number 1 Bearing Pointer Select button. A press of the bearing pointer button sequentially selects the next available sensor. The bearing pointer sensor list contains only those sensors which have bearing associated with them. If the selected sensor has distance information paired with it, that distance will be displayed in the lower right hand corner along with the sensor annunciation.

The following is a list, in order, of the bearing pointer sensors that may be interfaced with the EHI 40:

DECLUTTER (no number two bearing pointer information
is displayed)
VOR 2

Only those sensors interfaced to the EHI 40 will be selectable for use and display.

No bearing information will be available when LOC 2 is annunciated as the primary nav sensor.

SECTION 7 - DESCRIPTION AND OPERATION (Continued)

7. RANGE SELECTION

RANGE DOWN - A press of the RANGE DOWN button selects the next lower range to be displayed while in the NAV MAP mode of operation. Once the lowest selectable range is reached, the RANGE UP button must be used for a range change.

RANGE UP - The operation of the RANGE UP button is similar to the RANGE DOWN except it selects the next higher range to be displayed while in the NAV MAP mode of operation.

8. EHI 40 SYSTEM SELF-TEST - The TST/REF button performs the function of SELF TEST display. To activate the SELF TEST, press and hold the TST/REF button for 3 seconds. The self test processing time may last up to 5 seconds depending upon the particular functions being performed by the symbol generator. Upon completion of self test, a test pattern annunciating pass or fail will be displayed until the TST button is pressed once again.

When LOR MAP display has been selected, pressing the TST/REF button for 1 second will annunciate the present map format. If the displayed format is desired, no additional action is required. If a different format is desired, sequence through the list by pressing the button for 1 second for each format until the desired annunciation (FPL ID, AIRPORT, or NAVAIDS) is displayed. In either case, approximately 10 seconds after the last button press, the map format annunciation will be removed.

9. COURSE SELECT KNOB - Rotation of the COURSE SELECT knob allows the course pointer on the EHSI to be rotated to the desired course.

The ED 461 provides a DIRECT TO feature. Pushing the center of the COURSE SELECT knob will cause the course pointer and digital course readout on the EHSI to slew to the direct course to the selected navaid or active waypoint.

SECTION 7 - DESCRIPTION AND OPERATION (Continued)

10. **HEADING SELECT KNOB** - Rotation of the **HEADING SELECT** knob allows the heading bug on the **EHSI** to be rotated to the desired heading.

The ED 461 provides a **HEADING SYNC** feature. Pushing the center of the **HEADING SELECT** knob will cause the heading bug on the **EHSI** to slew to the present aircraft heading (lubber line).

11. **DISPLAY UNIT BRIGHTNESS CONTROL** - The **BRT** knob allows control of the display brightness.

NOTE

The display brightness control provides full range dimming to allow night operation in no- or low-light situations. The lower limit of the display brightness may appear as an inoperative tube during normal daylight operation. It is therefore advisable to check the **BRT** knob setting during preflight test.

FOR REFERENCE ONLY
NOT FOR FLIGHT

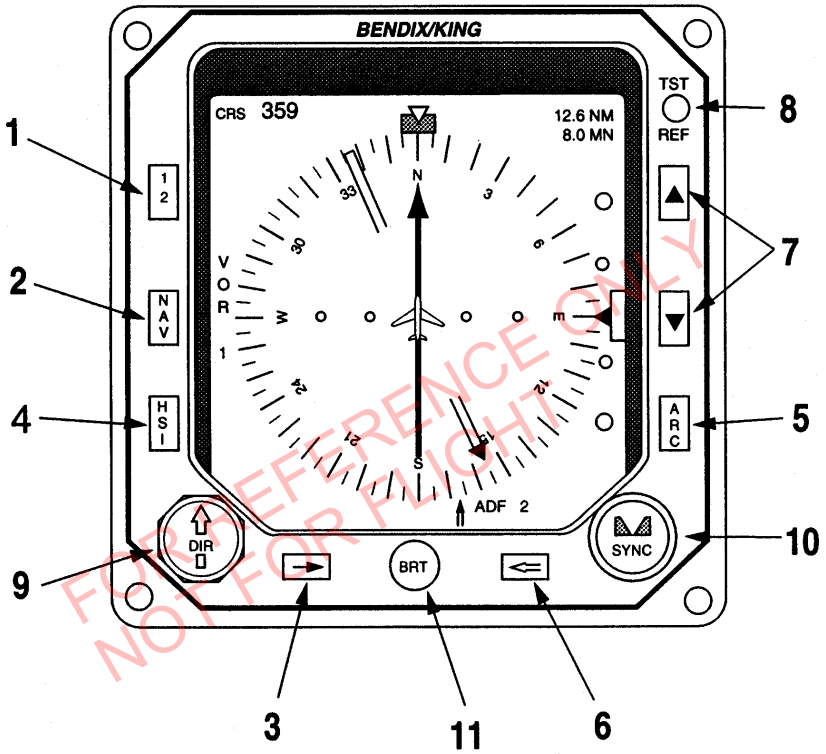

ED 461 EHI CONTROLS
Figure 7-1

SECTION 7 - DESCRIPTION AND OPERATION (Continued)

EHSI DISPLAYS

Standard EHI 40 displays, which may be referred to as key points of the display, are discussed in the following paragraphs (refer to figure 7-5):

1. Normal Compass Card Display - A 360 degree rotating white compass scale indicates the aircraft heading referenced to the white triangular heading index (lubber line). The compass scale is divided in 5 degree increments with the 10 degree divisions approximately twice as long as the 5 degree marks. Fixed 45 degree index marks are adjacent to the compass scale.
2. Symbolic Aircraft - The symbolic aircraft provides a visual reference of the aircraft position in relationship to the deviation bar.
3. Navigation Source Annunciation - A vertical three letter alphanumeric readout, located on the left side of the display, indicates the navigation selecting system selected as the primary navigation sensor.

The *cross side* navigation system may be selected for display by pressing the 1-2 push button. Example: *pilot* selecting number 2 navigation system (**LOC 2**).

Green annunciation indicates an *on side* approach approved NAV system and yellow indicates any *cross side* system has been selected, whether approach approved or not. Cyan (light blue) annunciations apply to *on side* non-approach approved NAV systems. These color codes apply to the NAV source annunciator, CRS pointer and CDI, CRS line in MAP mode, CRS readout, distance, ground speed readout, and time to station.

NOTE

A power failure to NAV 2 when LOC 2 is the primary nav sensor is indicated by the removal of the nav display and flagged with a red X. The primary nav sensor annunciator will revert to VOR 2.

SECTION 7 - DESCRIPTION AND OPERATION (Continued)

4. Heading Select Bug

A notched orange heading bug is manually rotated around the compass scale by the heading select knob on the control panel. A digital readout of the selected heading is displayed in the lower right hand corner. Once set, the heading bug rotates with the compass card. The heading bug is used to indicate desired heading and provides selected heading reference for autopilot steering.

The auto sync feature allows the heading bug to be centered under the lubber line by pushing the center of the HEADING SELECT knob.

5. Course Pointer - The course pointer is rotated about the compass scale by the course select knob. Once set, the course pointer rotates with the compass card. It is used to indicate the desired navigation course to be flown.

In the upper left corner of the display, an alphanumeric readout of course pointer annunciates the letters CRS and indicates the selected navigation course in degrees.

6. Course Deviation Bar - The course deviation bar represents the centerline of the selected navigation or localizer course.
7. Course Deviation Scale - The course deviation Scale, four white dots evenly spaced on both sides of the symbolic aircraft, provides a reference for the course deviation bar to indicate the centerline of the selected navigation or localizer course in relation to the symbolic airplane.

SECTION 7 - DESCRIPTION AND OPERATION (Continued)

7. Course Deviation Scale (continued)

The following represents the deviation scale for different navigation sources:

LATERAL DEVIATION SCALE (Continued)

MODE	AIRCRAFT DISPLACEMENT	
	ANGULAR DEV (DEGREES)	LINEAR DEV (MILES)
VOR	1 dot	5.0 deg
	2 dots	10.0 deg
ADF	1 dot	7.5 deg
	2 dots	15.0 deg
RVN (VOR PAR, RVN) GPS	1 dot	2.5 NM
	2 dots	5.0 NM
RVN (RVN APR)	1 dot	0.625 NM
	2 dots	1.25 NM

8. To/From (not illustrated in figure 7-5) - A white arrow head is displayed near the center of the EHSI with head pointing toward the course pointer (TO) or toward the tail of the course pointer (FROM). It indicates the selected course is to or from the station or waypoint. The TO/FROM indicator is not displayed during ILS operation or when an invalid navigation signal is received.
9. Distance and Ground Speed Display - The EHI 40 provides three distance displays; the upper right corner, lower left below the #1 bearing pointer sensor annunciator, and lower right below the #2 bearing pointer sensor annunciator. Aircraft equipped with a single DME have a separate DME select switch, located on the pilot's instrument panel, to channel DME to NAV 1 or NAV 2.

In the upper right corner, an alphanumeric readout annunciates distance in nautical miles from the aircraft to selected VORTAC station in VOR mode or to waypoint in RVN LOR or GPS mode. Below the distance readout is an alphanumeric readout of the aircraft ground speed in knots or time to station in minutes and is selectable by pressing the TST/REF button. VOR 2 DME is inhibited when KNS-81 is in the RVN or RVN APR mode.

SECTION 7 - DESCRIPTION AND OPERATION (Continued)

9. Distance and Ground Speed Display (continued)

When the selected bearing pointer source has DME data associated with it, the distance information will be displayed below the bearing pointer source annunciator.

In the event that the VORTAC or DME station is out of range or not operational, or if for any reason the DME receiver is operational but not providing computed data, the distance will be dashed in the original color. If the DME receiver is indicating an internal fault, is being tuned by another receiver, or is turned off, the distance will be dashed in red. When DME is flagged, the ground speed and time to station display is removed.

10. DME HOLD - When DME HOLD is selected, the DME distance and annunciator color will change to white and remains that color until the HOLD function is released. The sensor identifier (VOR, ILS, etc) shall retain the original assigned color. The HOLD function is indicated by an orange letter H which is displayed immediately below or to the right of distance information. DME ground speed and time-to-station will not be displayed when DME HOLD is active.

DME HOLD will not function when RNV is the selected primary nav sensor and will cause the nav and DME information to be removed from the display and flagged red.

CAUTION

Once the DME is placed in HOLD, its distance will continue to be displayed and will not be affected when bearing pointers are changed. If VOR is the selected primary nav sensor when DME HOLD is selected and then if the nav is tuned to another VORTAC, relative bearing and distance information will be to different VORTACs. If ADF is selected on either the primary NAV sensor or bearing pointer 1, VOR 1 or LOC 1 DME hold information will be displayed in the upper right corner and in the lower left corner.

SECTION 7 - DESCRIPTION AND OPERATION (Continued)

11. Bearing Pointer Display - The rotating blue single bar #1 RMI Pointer points in the direction of the selected sensor ground station or waypoint.

The rotating magenta double bar #2 RMI Pointer points in the direction of the selected ground station.

The compass card is in MAG and all bearing pointers may be displayed.

NOTE

If a selected bearing sensor ground station is out of range or signals are not being received properly, the RMI pointer assigned to that bearing source is not displayed. The selected bearing source annunciator displayed at the bottom left and right of the display is flagged with a red X through it. If the selected bearing sensor has DME distance associated with it and is valid, the distance data will remain valid.

12. Course Annunciation - Magnetic course is automatically displayed in VOR/LOC, GPS, RNV, and ADF.
13. Glideslope Display - If the selected primary sensor is an ILS, the vertical scale will appear on the right side when the selected inbound course is within 105 degrees of the aircraft heading.

The vertical two letter identifier in the pointer annunciates the deviation source. GS will be annunciated if the source is an ILS.

Loss of glideslope is flagged by a red X and the letters GS appearing in red.

SECTION 7 - DESCRIPTION AND OPERATION (Continued)

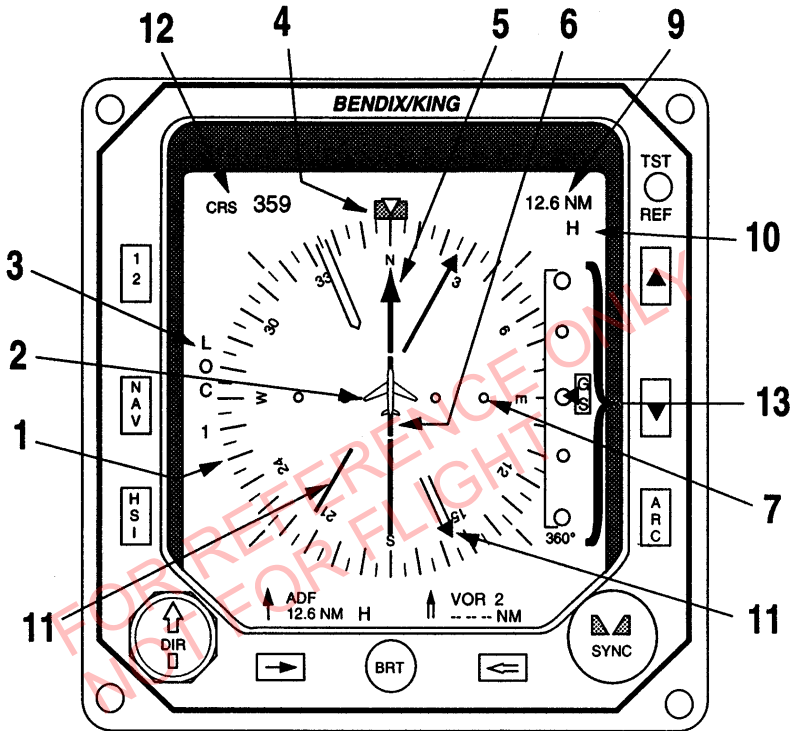

ED 461 DISPLAY UNIT

Figure 7-5

SECTION 7 - DESCRIPTION AND OPERATION (Continued)

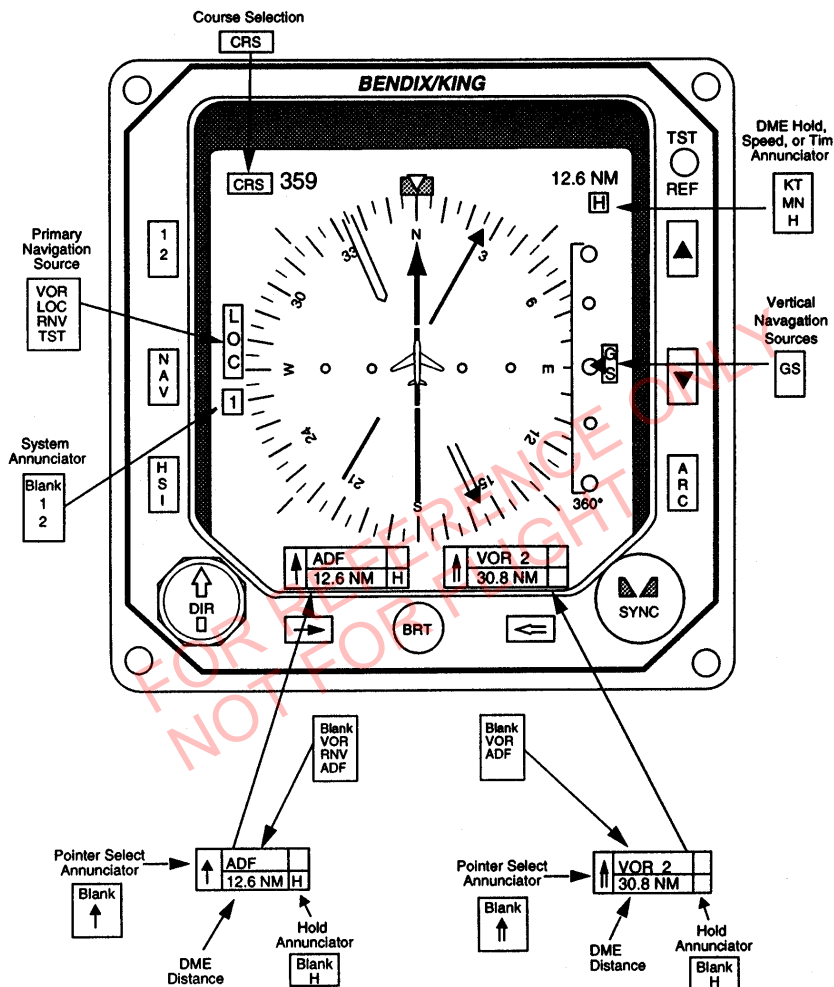

ED 461 DISPLAY UNIT

Figure 7-5 (cont)

SECTION 7 - DESCRIPTION AND OPERATION (Continued)

MAP DISPLAY (refer to figure 7-7)

The EHI 40 provides two basic types of map; a 360 degree map display about the aircraft and an approximately 85 degree sectored map display in front of the aircraft. Options to be displayed on the map include waypoints and nav aids. The type and amount of data presented on the map will depend on the interfacing equipment. When coupled with an RNAV, such as the BENDIX/KING KNS 81, waypoints referenced to the selected VORTAC may be displayed. The map data is provided by plotting VORTAC symbols referenced to the aircraft using bearing and distance from the VOR/DME.

NOTE

The following will address only those areas of the EHI 40 map mode which are different from the standard compass presentations previously described.

1. MAP 360 Compass Card Display - The operation of the compass card remains the same in the map modes as in the standard EHSI display. To provide more usable display area for map waypoints and nav aids, the 5 and 10 degree tic marks have been reduced in size. The compass card radius is unchanged.
2. Symbolic Aircraft Display - The size of the symbolic aircraft is reduced to provide a cleaner display as the map graphic data is added.
3. Selected Course Display - The alphanumeric course select readout in the upper left corner of the display functions the same in the map mode as in the standard EHSI mode. The standard EHSI selected course is removed from the center of the display. The selected course pointer is replaced with the course line. If the selected waypoint or vortac is within map range, it will be displayed with a movable course line drawn through its center. As the selected course is changed, the course line will rotate about the referenced point. If the selected primary nav sensor is an approach approved No. 1 sensor, the inbound TO course line is green and the outbound FROM course line is white. If the selected primary nav sensor is RNV, or GPS, the inbound TO course line is cyan (light blue). Any time the No. 2 sensor is selected as the primary nav sensor, the inbound TO course line is yellow.

SECTION 7 - DESCRIPTION AND OPERATION (Continued)

4. Course Deviation Display - The stationary white deviation scale along the bottom of display provides reference for the course deviation bar to indicate position of airplane in relation to selected navigation course. To provide backcourse CDI needle reversal annunciation, ILS map mode only, the deviation scale center triangle will point to the bottom of the display and annunciate a BC when the selected course is 105 degrees or more from the aircraft heading.
5. TO/FROM Display - To the right of the alphanumeric course select, a TO or FR will replace the standard EHSI TO/FROM pointer when in non ILS map modes.
6. Bearing Pointer Display - Standard EHSI bearing pointers will display when the selected bearing source does not have DME distance associated with it or when the distance is not within map range. Once the source is within map range, the associated map symbol is displayed as the bearing pointer is removed.
7. Range Ring Display - A light blue range ring located between the symbolic aircraft and the outside of the map compass scale aids in determining distance of nav aids in relation to the aircraft. Off the right wing of the symbolic aircraft adjacent to the range ring is the range ring distance. The range ring represents half the distance to the outer range ring compass scale. The available ranges are 5, 10, 20, 40, 80, 160, 240, 320, and 1000 NM.
8. MAP Weather Radar - When selected, weather information will transparently overlay the existing navigation data. Light blue dotted weather radar scan limit lines provide borders that weather information will fall within. The EHI 40 acts as a radar range controller or as a simple remote display when the EHSI has weather selected and matches the radar range. Weather radar information will not be displayed on the EHI 40 when the selected range is less than or greater than the ranges available on the compatible radar.

NOTE

Vertical profile weather information is not available on EHI 40 display when the RDR 2000VP radar is installed.

SECTION 7 - DESCRIPTION AND OPERATION (Continued)

9. MAP Weather Radar Information - Four data lines are reserved below the primary NAV sensor source annunciator to display radar information.

- First Line: Special performance features.
- Second Line: Standard Radar Modes (WX, WXA, or MAP).
- Third Line: Digital Readout of tilt angle.
- Fourth Line: Radar Faults and Warnings.

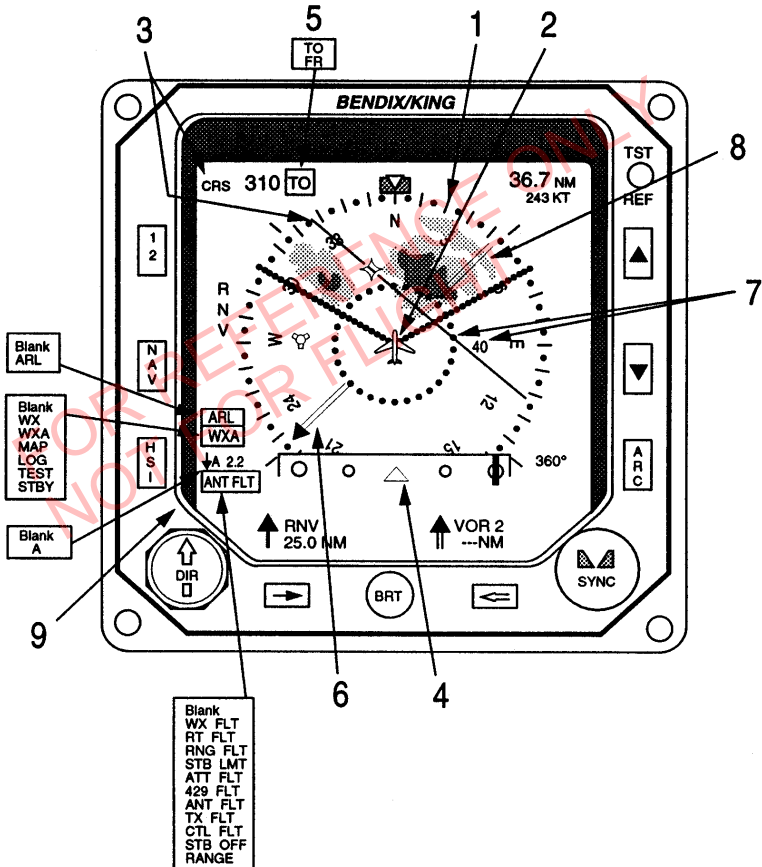

461 DISPLAY UNIT WITH MAP DISPLAY

Figure 7-7

SECTION 7 - DESCRIPTION AND OPERATION (Continued)

ARC (EXPANDED) EHSI DISPLAY (refer to figure 7-9)

The expanded (ARC) format provides an enlarged display for increased resolution to NAV data due to the enlarged compass scale presentations.

1. HDG Bug Display (ARC Format) - The heading bug operation is the same in all modes. The only difference which will be noticed in the ARC mode is the digital orange readout of selected heading. This is displayed only when the heading bug moves out of view. In this event, the heading readout appears on the right or left side of the compass scale depending on whichever is closest.
2. Course Deviation Scale (Arc Format) - The rotating white deviation scale operates the same in all modes. The difference in the ARC mode is the location and size; the scale is moved to the bottom center of display and slightly reduced in size.

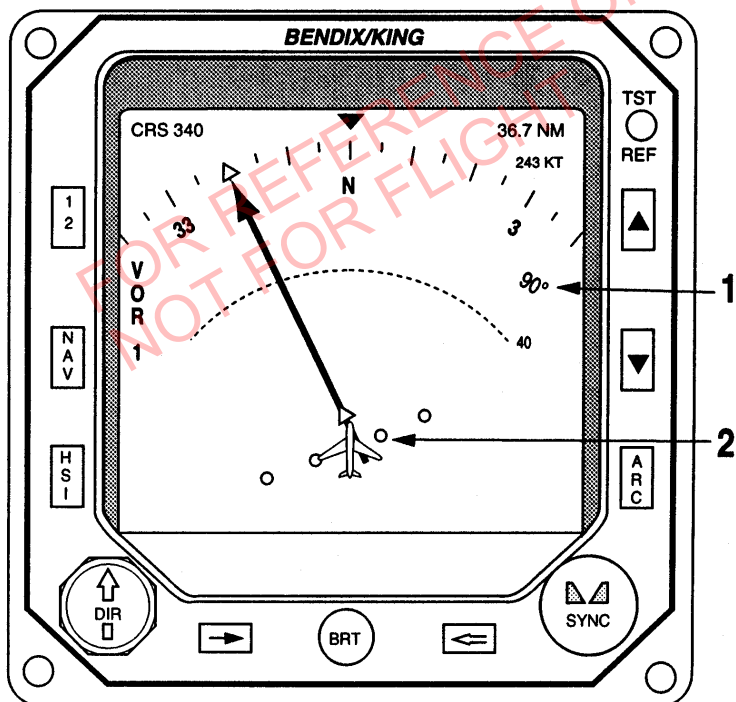

461 EHI DISPLAY UNIT WITH ARC DISPLAY

Figure 7-9

**PILOT'S OPERATING HANDBOOK
AND
FAA APPROVED AIRPLANE FLIGHT MANUAL**

**SUPPLEMENT NO. 9
FOR
BENDIX/KING RDR 2000 VERTICAL PROFILE
WEATHER RADAR SYSTEM**

This supplement must be attached to the Pilot's Operating Handbook and FAA Approved Airplane Flight Manual when the optional Bendix/King RDR 2000 Vertical Profile Weather Radar System is installed per the Equipment List. The information contained herein supplements or supersedes the information in the basic Pilot's Operating Handbook and FAA Approved Airplane Flight Manual only in those areas listed herein. For limitations, procedures, and performance information not contained in this supplement, consult the basic Pilot's Operating Handbook and FAA Approved Airplane Flight Manual.

FAA APPROVED

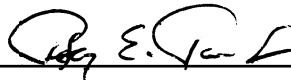

PETER E. PECK
D.O.A. NO. SO-1
THE NEW PIPER AIRCRAFT, INC.
VERO BEACH, FLORIDA

DATE OF APPROVAL _____ FEBRUARY 23, 1999 _____

SECTION 1 - GENERAL

This supplement supplies information necessary for the operation of the airplane when the optional Bendix/King RDR 2000 Vertical Profile Weather Radar System is installed in accordance with FAA Approved Piper data.

SECTION 2 - LIMITATIONS

Do not operate the radar during refueling operations or within 15 feet of trucks or containers accommodating flammables or explosives. Do not allow personnel within 15 feet of area being scanned by antenna when system is transmitting.

SECTION 3 - EMERGENCY PROCEDURES

No changes to the basic Emergency Procedures provided by Section 3 of this Pilot's Operating Handbook are necessary for this supplement.

SECTION 4 - NORMAL PROCEDURES

WARNING

Do not operate the radar during refueling operations or within 15 feet of trucks or containers accommodating flammables or explosives. Do not allow personnel within 15 feet of area being scanned by antenna when system is transmitting.

Preflight and normal operating procedures are outlined in the Bendix/King RDR 2000 Vertical Profile Weather Radar System Pilot's Guide, P/N 006-08755-0000, latest revision.

When the range is set to 10 miles a small sector of return may be observed along the left side of the display . This is the reflection of the cowling and propeller and will diminish with increasing range. This anomaly is not significant at longer ranges and does not effect the operation or display of weather radar.

SECTION 5 - PERFORMANCE

When the radar pod is installed:

- a. The rate of climb is decreased approximately 50 fpm.
- b. The cruise speed is decreased approximately 2 knots.
- c. The cruise range is decreased approximately 1% due to the decrease in cruise speed.

SECTION 6 - WEIGHT AND BALANCE

Factory installed optional equipment is included in the licensed weight and balance data in Section 6 of the basic Pilot's Operating Handbook.

SECTION 7 - DESCRIPTION AND OPERATION

The RDR 2000 Vertical Profile Weather Radar system consists of the:

- a. RS 181A sensor which combines the system components of antenna, receiver, and transmitter.
- b. The IN 182A indicator which incorporates all the operational controls.

The system's antenna is installed inside a teardrop shaped pod mounted beneath the right wing just outboard of the wing jack point.

Operation and Controls

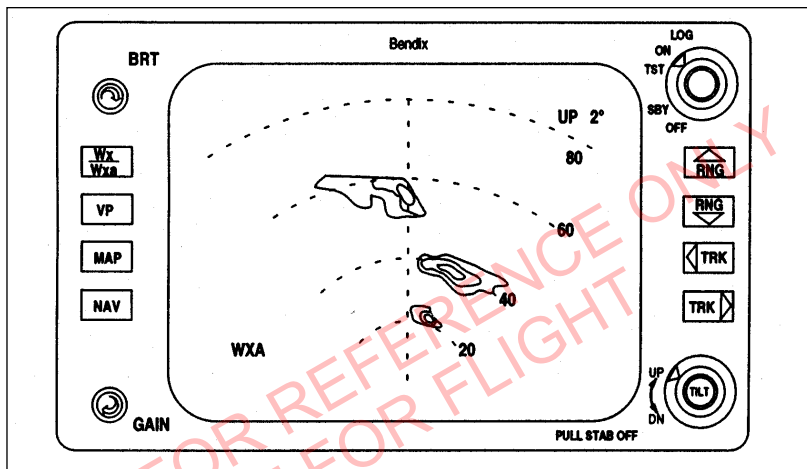

RDR 2000 CONTROLS AND INDICATOR

Figure 7-1





Operation and Controls (cont.)

CONTROL/ DISPLAY	FUNCTION
BRT Control	Adjusts brightness of the display for varying cockpit light conditions.
Wx/Wxa Button	When pressed, alternately selects between the Wx (weather) and Wxa (weather alert) modes of operation. Wx or Wxa will appear in the lower left of the display. Areas of high rainfall appear in magenta color. When the Wxa mode is selected, magenta areas of storms flash between magenta and black.
VP Button	When pressed, selects and deselects the vertical profile mode of operation. Selecting the VP mode of operation (see Figure 7-3) will not change the selected mode of operation: TST, Wx, Wxa, or MAP. Once in VP, these modes may be changed as desired. VP will engage from the MAP mode but NAV will be disabled during VP operation.
MAP Button	When pressed places indicator in ground-mapping mode. Selecting ground-mapping (MAP) will disable the weather-alert feature and will activate the gain control. The magenta color is not activated while in the ground-mapping (MAP) mode.
NAV Button	When pressed, places indicator in navigation mode so that preprogrammed waypoints may be displayed. If other modes are also selected, the NAV display will be superimposed on them. This button is effective only if an optional radar graphics unit and flight management system is installed. If actuated without these units, NO NAV will appear at lower left screen. The radar is still capable of displaying weather.

Operation and Controls (cont.)

CONTROL/ DISPLAY	FUNCTION
GAIN Control Knob	Manual gain control becomes active <i>only</i> when ground-mapping (MAP) is selected. Gain is internally set in <i>all other</i> modes.
Radar Function Selector Switch	<ol style="list-style-type: none"><li data-bbox="423 456 906 756">1. LOG position is used only when the Bendix/King IU 2023 series radar graphics unit is installed along with a compatible long range navigation system, a listing of the latitudes and longitudes of selected waypoints will be displayed. If a compatible RNAV is used, selected VOR frequencies, along with bearings and distances to waypoints, will be presented. No radar transmission occurs in this mode.<li data-bbox="423 805 906 943">2. ON position selects the condition of normal operation, allowing for weather detection or other modes of operation. Radar transmission exists in the ON position.<li data-bbox="423 959 906 1073">3. TST position will display the test pattern on the indicator (see Figure 7-5); no transmission occurs. The antenna will scan while in the test (TST) mode.<li data-bbox="423 1089 906 1325">4. SBY position places system in the standby condition during warm-up and when the system is not in use. After 30 seconds in this mode during warm-up, the system is in a state of readiness. No radar transmissions occurs; the antenna is parked in the down position. STBY is displayed in the lower left of the display.

Operation and Controls (cont.)

CONTROL/ DISPLAY	FUNCTION
<p>Radar Function Selector Switch (cont.)</p> <p> RNG Selector Button</p>	<p>5. OFF position removes primary power from the radar indicator and the sensor. The antenna is parked in the down position.</p> <hr style="border-top: 1px dashed black;"/> <p>When pressed clears the display and advances the indicator to the next higher range. Selected range is displayed in upper right corner of the last range mark (Figure 7-1) and distance to other range rings is displayed along the right edge.</p>
<p> RNG Selector Button</p>	<p>When pressed clears the display and decreases the indicator to the next lower range. Selected range is displayed in upper right corner of the last range mark (Figure 7-1) and distance to other range rings is displayed along the right edge.</p>
<p> and  TRK Buttons</p>	<p>When pressed provides a yellow azimuth line and a digital display of the azimuth line placement left or right from the nose of the aircraft. For vertical profile (VP) operations, the track button performs two functions:</p>

Operation and Controls (cont.)

CONTROL/ DISPLAY	FUNCTION
	<ol style="list-style-type: none"><li data-bbox="426 391 907 735">1. Prior to engaging VP, the appropriate button (left or right) is used to place the track line at the desired azimuth angle to be vertically scanned (sliced). When VP is engaged, the slice will be taken at the last position of the track line, whether it is visible or not. If the track line has not been selected after power has been applied to system and VP is engaged, the slice will be taken at 0 degrees (directly in front of the aircraft).<li data-bbox="426 760 907 854">2. Continuously holding the TRK button will result in the system slicing in two-degree increments.
Antenna TILT Adjustment Knob	Permits manual adjustment of antenna tilt to a maximum of 15° up or down in order to obtain the best indicator presentation. The tilt angle is displayed in the upper right corner of the display. Depending upon the MOD status of the indicator, tilt read out may display in tenth degree.

Operation and Controls (cont.)

**VERTICAL PROFILE MODE (RDR 2000)**

Figure 7-3

1. Vertical PROFILE mode annunciation
2. Left or right track annunciation.
3. Degrees of track left or right of aircraft nose.
4. Displays plus and minus thousands of feet from relative altitude. Will vary with selected range.
5. Relative altitude reference line.
6. Range rings.
7. Selected weather mode (Wx or Wxa).
8. Vertical profile scan angle of 50°.

Operation and Controls (cont.)

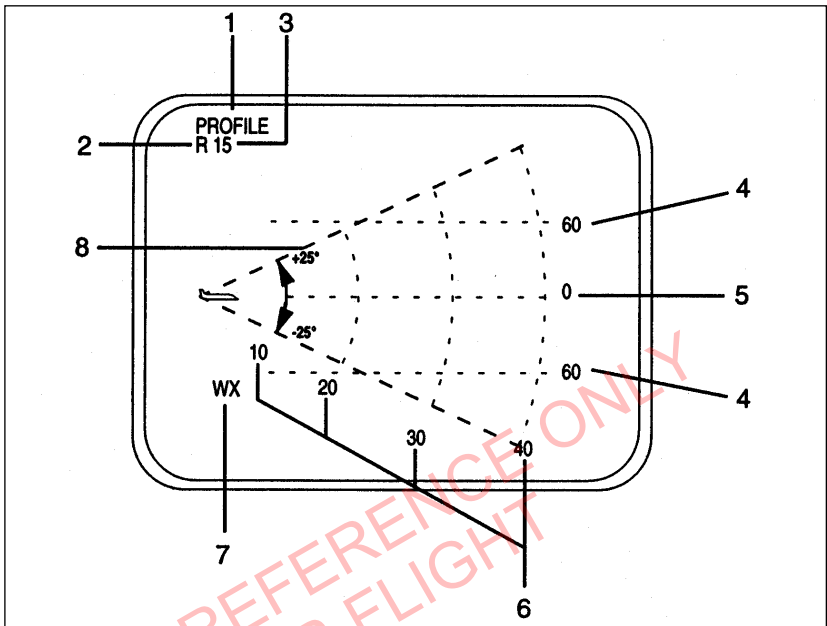
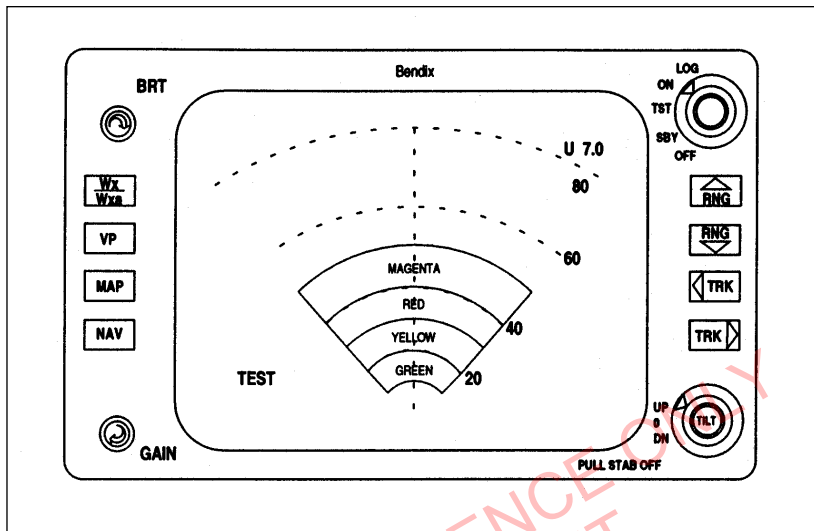

TEST PATTERN

Figure 7-5

Detail description on the function and use of the various controls and displays are outlined in the Bendix/King RDR 2000 Vertical Profile Weather Radar System Pilot's Guide, P/N 006-08755-0000, latest revision.

**PILOT'S OPERATING HANDBOOK
AND
FAA APPROVED AIRPLANE FLIGHT MANUAL**

**SUPPLEMENT 10
FOR
ARGUS 7000CE MOVING MAP DISPLAY**

This supplement must be attached to the Pilot's Operating Handbook and FAA Approved Airplane Flight Manual when the optional Argus 7000CE Moving Map Display of Eventide, Inc. is installed. The information contained herein supplements or supersedes the information in the basic Pilot's Operating Handbook and FAA Approved Airplane Flight Manual only in those areas listed herein. For limitations, procedures and performance information not contained in this supplement, consult the basic Pilot's Operating Handbook and FAA Approved Airplane Flight Manual.

FAA APPROVED: _____

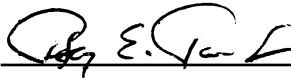

PETER E. PECK
D.O.A. NO. SO-1
THE NEW PIPER AIRCRAFT, INC.
VERO BEACH, FLORIDA

DATE OF APPROVAL: FEBRUARY 23, 1999

SECTION 1 - GENERAL

This supplement supplies information necessary for the operation of the airplane when the optional Argus 7000CE Moving Map Display is installed. The display must be operated within the limitations herein specified. The information contained within this supplement is to be used in conjunction with the complete handbook.

This supplement has been FAA approved as a permanent part of the handbook and must remain in this handbook at all times when the Argus 7000CE Moving Map Display System is installed.

SECTION 2 - LIMITATIONS

- a. Eventide Avionics, Argus 7000CE Moving Map Display Operator's Manual (P/N 141000, latest revision) must be immediately available to the flight crew whenever the system is installed.
- b. The Argus 7000CE Moving Map Display is not to be substituted for, nor does it replace, approved aeronautical charts and manuals.
- c. The Argus 7000CE Moving Map Display is approved for use under Visual Flight Rules (VFR) and Instrument Flight Rules (IFR) as a supplemental navigation display in accordance with the GPS receiver (or navigation management system) operating limitations, and/or limitations listed in this supplement.

WARNING

If an installed GPS is not approved for IFR use, then IFR use of the Argus 7000CE with GPS course/navigation guidance is prohibited.

- d. The Argus 7000CE must have software version 5.0, or latest revision, installed. The data base must be replaced with an updated data base at the expiration date displayed on the disclaimer page in order to qualify for IFR use. (However, if the data base has not been updated, the Argus 7000CE is not approved for navigational use.)
- e.) Except for ADF bearing operations, the Argus 7000CE Moving Map Display is not to be utilized as a primary flight guidance instrument, nor is it to be used in conjunction with other instruments while

conducting a *precision* approach to, or departure from, a landing facility.

- f. When using the ADF bearing pointer for navigation in the map and plan submode, the range must be limited to 40 nm or less, and the pointer must be discernible.
- g. ADF only submode is approved for IFR non-directional beacon (NDB) approaches, providing it is used in conjunction with an independent gyroscopic directional indicator or HSI.
- h. The Argus 7000CE Moving Map Display is approved in conjunction with the GPS receiver installed in the airplane. All reference to other systems in the the Argus 7000CE Moving Map Display Operator's Manual are not applicable to this installation.
- i. When the Argus 7000CE is used for IFR navigation, the graphics screen must be oriented with heading from the HSI. IFR flight is *NOT* approved using GPS track.

SECTION 3 - EMERGENCY PROCEDURES

Simultaneous depression of the **AUX**iliary and **ARR**ival push buttons will activate the emergency submode, which will cancel all GPS navigation data, and replace it with computed bearing, distance, and ETA to the nearest one of several previously qualified landing facility. The **DEP**arture push button controls the facility selection; the **ARR**ival push button controls range.

No changes to the basic emergency procedures provided by Section 3 of this Pilot's Operating Handbook are necessary for this supplement.

SECTION 4 - NORMAL PROCEDURES

Normal operating procedures are outlined in the Argus 7000CE Operator's Manual, P/N 141000, latest revision.

SECTION 5 - PERFORMANCE

No change.

SECTION 6 - WEIGHT AND BALANCE

Factory installed optional equipment is included in the licensed weight and balance data in the Equipment List attached to the Pilot's Operating Handbook.

SECTION 7 - DESCRIPTION AND OPERATION

The following functions should be observed during initial power application to the Argus 7000CE. A more comprehensive description of these function and procedures is contained in the Simplified Procedures section in the Eventide Avionics Argus 7000CE Moving Map Display Operator's Manual.

a. Predeparture and AMEND Procedures.

- (1) When power is initially applied to the Argus 7000CE, the following events occur:
 - (a) The cathode ray tube(CRT) will be tested for illumination during the *raster test*.
 - (b) A comprehensive SELF-TEST will then be conducted of the system RAM, the RS-232 Interface Hardware, the system Interrupt Handler, the system ROM, the Real-Time Clock, the Analog-to-Digital (A/D) Converter, and the Database. This process takes about one minute, depending upon the contents of the database.
 - (c) The Disclaimer Page is then displayed for review of the GPS type approval, with the reminder that the *FEATURES OF THIS SYSTEM ARE NOT TO BE SUBSTITUTED FOR FAA REQUIRED CHARTS*, the Date and Time, the Argus 7000CE Serial Number, and the Database Effective Date and EXPIration date.

SECTION 7 - DESCRIPTION AND OPERATION (Continued)

- (2) In addition, the Software Program **VER**sion will appear on the Disclaimer Page, which will remain in view until any functional push button is depressed. The current **VER**sion is 5.0.
 - (3) The intensity of the Argus 7000CE CRT and LED push buttons may be adjusted by rotating the **PUSH-ON** knob. To remove power to the Argus 7000CE, pull the **PUSH-ON** knob.
 - (4) The facilities and features desired for display on the Argus 7000CE may be selected in the unlabeled **AMEND** submode. To activate the **AMEND** submode, depress the **AUX**iliary mode push button for 5 seconds or, by three consecutive key strokes. These may be selected during Predeparture, or at anytime the Argus 7000CE is in use when airborne.
- b. **DEP**arture, **ENR**oute, and **ARR**ival Procedures.
- (1) The **DEP**arture mode may be activated to observe the stationary symbolic aircraft in the center of the Heading-up graphics screen in respect to surrounding facilities. The ranges for the **DEP**arture mode are from 1 nm to 40 nm. The navigation information displayed is with respect to GPS Great Circle calculations. Graphics screen orientation is with respect to Gyroscopic Directional heading or GPS Track.
 - (2) The **ENR**oute mode may be activated to observe the stationary symbolic aircraft at 20 percent above the bottom of the Heading-Up graphics screen. The ranges are from 1 nm to 240 nm. All other navigation information is similar to that of the **DEP**arture mode. Graphics screen orientation is with respect to Gyroscopic Directional heading or GPS track.
 - (3) The **ARR**ival mode may be activated to observe a stationary Magnetic North-up graphics screen, and a moving arrow, when the range of the aircraft is beyond the selected or maximum range; or a moving symbolic aircraft when the range of the aircraft is within the

SECTION 7 - DESCRIPTION AND OPERATION (Continued)

40 nm to 1 nm distance to the destination waypoint. All other navigation information is similar to that of the **DEPARTure** and **ENRoute** modes. Orientation and direction of flight of the moving arrow or symbolic aircraft is with respect to Gyroscopic Directional HSI heading, or GPS computed track.

c. **SElect** and **INFORmation** Procedures.

- (1) When the **ADF/ARGUS REMOTE** switch, located adjacent to the ARGUS display, is selected to the ARGUS REMOTE position, ancillary navigation data may be accessed for display on the graphics screen by activating the required remote **INFO SElect** switch, located on the control wheel, or by simultaneously depressing the **AUXiliary** and **DEPARTure** push buttons. Upon activation of the **SElect** submode, the bearing and distance to an airport, heliport, seaplane base, NDB, LOM, LMM, TACAN, or Fan Marker are displayed in a box adjacent to the selected facility. When selected, radial and distance are displayed from a VOR, VOR/DME, or VORTAC. Consecutive depressions of the remote **INFO SElect** switch, to the select position, will select subsequent facilities for display of similar navigation data, which is computed from the present position of the aircraft.
- (2) When the **ADF/ARGUS REMOTE** switch, located adjacent to the ARGUS display, is selected to the ARGUS REMOTE position, and when a facility is selected by the remote **INFO SElect** switch, or combination, specific information about that selected facility is available by activating the required **ARGUS SElect** switch, located on the control wheel, or by simultaneously depressing the **AUXiliary** and **ENRoute** push buttons. Upon activation, a directory of characteristics about that selected facility is available to assist the flight crew. Simultaneous depressions of the remote **INFO SElect** switch or the **AUXiliary** and **DEPARTure** push buttons, will enable subsequent facilities to be selected for display of similar information. A map mode can be recalled by depressing either **DEPARTure**, **ENRoute**, or **ARRival**.

SECTION 7 - DESCRIPTION AND OPERATION (Continued)

- d. ADF Bearing Pointer and Digital ADF Bearing Procedures.
- (1) In the **DE**Partment or **EN**RoutE modes, when ADF is selected, the bearing pointer and/or tail will appear on the perimeter of the Compass Rose. In the **ARR**ival mode, the bearing to the tuned and received station will emanate as a vector line from the symbolic aircraft toward the direction of the station, and will move relative to the position and direction of flight.
 - (2) The ADF bearing to a tuned and received NDB, LOM, or LMM can be displayed on the graphics screen in the form of a bearing pointer. In addition, a display of digital magnetic ADF bearing will appear in the lower window of the display. The ADF bearing can be selected for display either with or without a map or in the **PLAN** (waypoint only) or **ADF ONLY** submodes. The **ADF/ARGUS REMOTE** switch must be selected to the ADF position, and the function activated in the DISPLAY FEATURES page in the **AMEND** submode. If ADF is not selected, Track Error will be displayed.

**PILOT'S OPERATING HANDBOOK
AND
FAA APPROVED AIRPLANE FLIGHT MANUAL
SUPPLEMENT NO. 11
FOR
BENDIX/KING KLN 90B GPS
NAVIGATION SYSTEM WITH
KAP/KFC 150 or 225 AUTOPILOT SYSTEMS**

This supplement must be attached to the Pilot's Operating Handbook and FAA Approved Airplane Flight Manual when the optional Bendix/King KLN 90B GPS Navigation System is installed per Equipment List. The information contained herein supplements or supersedes the information in the basic Pilot's Operating Handbook and FAA Approved Airplane Flight Manual only in those areas listed herein. For limitations, procedures and performance information not contained in this supplement, consult the basic Pilot's Operating Handbook and FAA Approved Airplane Flight Manual.

FAA APPROVED



PETER E. PECK
D.O.A. NO. SO.-1
THE NEW PIPER AIRCRAFT, INC.
VERO BEACH, FLORIDA

DATE OF APPROVAL _____ FEBRUARY 23, 1999 _____

SECTION 1 - GENERAL

The KLN 90B GPS panel mounted unit contains the GPS sensor, the navigation computer, a CRT display, and all controls required to operate the unit. It also houses the data base cartridge which plugs directly into the back of the unit.

The data base cartridge is an electronic memory containing information on airports, nav aids, intersections, SID's, STAR's, instrument approaches, special use airspace, and other items of value to the pilot.

Every 28 days, Bendix/King receives new data base information from Jeppesen Sanderson for the North American data base region. This information is processed and downloaded onto the data base cartridges. Bendix/King makes these data base cartridge updates available to KLN 90B GPS users.

Provided the KLN 90B GPS navigation system is receiving adequate usable signals, it has been demonstrated capable of and has been shown to meet the accuracy specifications of:

VFR/IFR en route oceanic and remote, en route domestic, terminal, and instrument approach (GPS, Loran-C, VOR, VOR-DME, TACAN, NDB, NDB-DME, RNAV) operation within the U.S. National Airspace System, North Atlantic Minimum Navigation Performance Specifications (MNPS) Airspace and latitudes bounded by 74° North and 60° South using the WGS-84 (or NAD 83) coordinate reference datum in accordance with the criteria of AC 20-138, AC 91-49, and AC 120-33. Navigation data is based upon use of only the global positioning system (GPS) operated by the United States.

NOTE:

Aircraft using GPS for oceanic IFR operations may use the KLN 90B to replace one of the other approved means of long-range navigation. A single KLN 90B GPS installation may also be used on short oceanic routes which require only one means of long range navigation.

NOTE:

FAA approval of the KLN 90B does not necessarily constitute approval for use in foreign airspace.

SECTION 2 - LIMITATIONS

- A. The KLN 90B GPS Pilot's Guide, P/N 006-08773-0000, dated December, 1994 (or later applicable revision) must be immediately available to the flight crew whenever navigation is predicated on the use of the system. The Operational Revision Status (ORS) of the Pilot's Guide must match the ORS level annunciated on the Self Test page.
- B. IFR Navigation is restricted as follows:
1. The system must utilize ORS level 20 or later FAA approved revision.
 2. The data on the self test page must be verified prior to use. Verify valid altitude data is available to the KLN 90B prior to flight.
 3. IFR en route and terminal navigation is prohibited unless the pilot verifies the currency of the data base or verifies each selected waypoint for accuracy by reference to current approved data.
 4. Instrument approaches must be accomplished in accordance with approved instrument approach procedures that are retrieved from the KLN 90B data base. The KLN 90B data base must incorporate the current update cycle.
 - (a) The KLN 90B Memory Jogger, P/N 006-08785-0000, dated 12/94 (or later applicable revision) must be immediately available to the flight crew during instrument approach operations.
 - (b) Instrument approaches must be conducted in the approach mode and RAIM must be available at the Final Approach Fix.
 - (c) APR ACTV mode must be annunciated at the Final Approach Fix.
 - (d) Accomplishment of ILS, LOC, LOC-BC, LDA, SDF, and MLS approaches are not authorized.
 - (e) When an alternate airport is required by the applicable operating rules, it must be served by an approach based on other than GPS or Loran-C navigation.
 - (f) The KLN 90B can only be used for approach guidance if the reference coordinate datum system for the instrument approach is WGS-84 or NAD-83. (All approaches in the KLN 90B data base use the WGS-84 or the NAD-83 geodetic datums.)
 5. The aircraft must have other approved navigation equipment appropriate to the route of flight installed and operational.

**SECTION 3 - EMERGENCY PROCEDURES
ABNORMAL PROCEDURES**

- A. If the KLN 90B GPS information is not available or invalid, utilize remaining operational navigation equipment as required.
- B. If a "RAIM NOT AVAILABLE" message is displayed while conducting an instrument approach, terminate the approach.

Execute a missed approach if required.

- C. If a "RAIM NOT AVAILABLE" message is displayed in the en route or terminal phase of flight, continue to navigate using the KLN 90B or revert to an alternate means of navigation appropriate to the route and phase of flight. When continuing to use GPS navigation, position must be verified every 15 minutes using another IFR approved navigation system.
- D. Refer to the KLN 90B Pilot's Guide, Appendices B and C, for appropriate pilot actions to be accomplished in response to unannounced messages.

SECTION 4 - NORMAL PROCEDURES

WARNING:

Familiarity with the en route operation of the KLN 90B does not constitute proficiency in approach operations. Do not attempt approach operations in IMC prior to attaining proficiency in the use of the KLN 90B.

A. OPERATION

Normal operating procedures are outlined in the KLN 90B GPS Pilot's Guide, P/N 006-08773-0000, dated December, 1994, (or later applicable revision). A KLN 90B Memory Jogger, P/N 006-08785-0000 dated 12/94 (or later applicable revision) containing an approach sequence, operating tips and approach related messages is intended for cockpit use by the KLN 90B familiar pilot when conducting instrument approaches.

B. SYSTEM ANNUNCIATORS/SWITCHES/CONTROLS

1. HSI NAV presentation (NAV/GPS) switch annunciator - May be used to select data for presentation on the pilot's HSI; either NAV data from the number one navigation receiver or GPS data from the KLN 90B GPS. Presentation on the HSI is also required for autopilot coupling. NAV is green. GPS is blue.
2. Message (MSG) annunciator - Will flash to alert the pilot of a situation that requires attention. Press the MSG button on the KLN 90B GPS to view the message. (Appendix B of the KLN 90B Pilot's Guide contains a list of all of the message page messages and their meanings). MSG is amber.

SECTION 4 - NORMAL PROCEDURES (CONT'D)

- Waypoint (WPT) annunciator - Prior to reaching a waypoint in the active flight plan, the KLN 90B GPS will provide navigation along a curved path segment to ensure a smooth transition between two adjacent legs in the flight plan. This feature is called turn anticipation. Approximately 20 seconds prior to the beginning of turn anticipation the WPT annunciator will flash, going solid upon initialization of the turn, and extinguishing upon turn completion. WPT is amber.

WARNING:

Turn anticipation is automatically disabled for FAF waypoints and those used exclusively in SID/STARS where overflight is required. For waypoints shared between SID/STARS and published en route segments (requiring overflight in the SID/STARS), proper selection on the presented waypoint page is necessary to provide adequate route protection on the SID/STARS.

- GPS omni bearing or leg (GPS CRS OBS/LEG) course switch/annunciator - Used to select the basic modes of KLN 90B operation, either a) single waypoint with omni - bearing course (OBS) selection through that waypoint (like a VOR) or b) automatic leg sequencing (LEG) between waypoints. GPS CRS is white. OBS may either be white or amber. LEG is green.

NOTE:

Either LEG or OBS will illuminate during system self test depending upon switch position.

- HSI course control ① knob - Provides analog course input to the KLN 90B in OBS when the NAV/GPS switch/annunciator is in GPS. When the NAV/GPS switch annunciation is in NAV, GPS course selection in OBS mode is digital through the use of the controls and display at the KLN 90B. The HSI course control knob must also be set to provide proper course datum to the autopilot if coupled to the KLN 90B in LEG or OBS.

SECTION 4 - NORMAL PROCEDURES (CONT'D)

NOTE

Manual HSI course centering in OBS using the control knob can be difficult, especially at long distances. Centering the dbar can best be accomplished by pressing  and then manually setting the HSI pointer to the course value prescribed in the KLN 90B displayed message.

6. GPS approach (GPS APR ARM/ACTV) switch/annunciator - Used to a) manually select or deselect approach ARM (or deselect approach ACTV) and b) annunciate the stage of approach operation either armed (ARM) or activated (ACTV). Sequential button pushes if in ACTV would first result in approach ARM and then approach arm canceled. Subsequent button pushes will cycle between the armed state (if an approach is in the flight plan) and approach arm canceled. Approach ACTV cannot be selected manually. GPS APR and ARM are white. ACTV is green.
7. RMI NAV presentation switch - May be used to select data for presentation on the RMI; either NAV 2 data from the number two navigation receiver, or GPS data from the KLN 90B GPS.

C. PILOT'S DISPLAY

Left/right steering information is presented on the pilot's HSI as a function of the NAV/GPS switch position.

D. AUTOPILOT COUPLED OPERATION

The KLN 90B may be coupled to the autopilot by first selecting GPS on the NAV/GPS switch. Manual selection of the desired track on the pilot's HSI course pointer is required to provide course datum to the autopilot. (Frequent manual course pointer changes may be necessary, such as in the case of flying a DME arc.) The autopilot approach mode (APR) should be used when conducting a coupled GPS approach.

NOTE

Select HDG mode for DME arc intercepts. NAV or APR coupled DME arc intercepts can result in excessive overshoots (aggravated by high ground speeds and/or intercepts from inside the arc).

SECTION 4 - NORMAL PROCEDURES (CONT'D)**E. APPROACH MODE SEQUENCING AND RAIM PREDICTION****NOTE**

The special use airspace alert will automatically be disabled prior to flying an instrument approach to reduce the potential for message congestion.

1. Prior to arrival, select a STAR if appropriate from the APT 7 page. Select an approach and an initial approach fix (IAF) from the APT 8 page.

NOTES

- Using the right hand outer knob, select the ACT (Active Flight Plan Waypoints) pages. Pull the right hand inner knob out and scroll to the destination airport, then push the inner knob in and select the ACT 7 or ACT 8 page.
 - To delete or replace a SID, STAR or approach, select FPL 0 page. Place the cursor over the name of the procedure, press ENT to change it, or CLR then ENT to delete it.
2. En route, check for RAIM availability at the destination airport ETA on the STA 5 page.

NOTE

RAIM must be available at the FAF in order to fly an Instrument approach. Be prepared to terminate the approach upon loss of RAIM.

3. At 30 nm from the FAF:
 - a. Verify automatic annunciation of APR ARM.
 - b. Note automatic dbar scaling change from ± 5.0 nm to ± 1.0 nm over the next 30 seconds.
 - c. Update the KLN 90B altimeter baro setting as required.
 - d. Internally the KLN 90B will transition from en route to terminal integrity monitoring.

SECTION 4 - NORMAL PROCEDURES (CONT'D)

4. Select Super NAV 5 page to fly the approach procedure.
 - a. If receiving radar vectors, or need to fly a procedure turn or holding pattern, fly in OBS until inbound to the FAF.

NOTE:

OBS navigation is TO-FROM (like a VOR) without waypoint sequencing.

- b. NoPT routes including DME arc's are flown in LEG. LEG is mandatory from the FAF to the MAP.

NOTE:

Select HDG mode for DME arc intercepts. NAV or APR coupled DME arc intercepts can result in excessive overshoots (aggravated by high ground speeds and/or intercepts from inside the arc).

WARNING:

Flying final outbound from an off airport vortac on an overlay approach; beware of the DME distance increasing on final approach, and the GPS distance-to-waypoint decreasing, and not matching the numbers on the approach plate!

5. At or before 2 nm from the FAF inbound:
 - a. Select the FAF as the active waypoint, if not accomplished already.
 - b. Select LEG operation.
6. Approaching the FAF inbound (within 2 nm.):
 - a. Verify APR ACTV.
 - b. Note automatic dbar scaling change from ± 1.0 nm to ± 0.3 nm over the 2 nm inbound to the FAF.
 - c. Internally the KLN 90B will transition from terminal to approach integrity monitoring.
7. Crossing the FAF and APR ACTV is not annunciated:
 - a. Do not descend.
 - b. Execute missed approach.

SECTION 4 - NORMAL PROCEDURES (CONT'D)

8. Missed Approach:
- Climb
 - Navigate to the MAP (in APR ARM if APR ACTV is not available).

NOTE:

There is no automatic LEG sequencing at the MAP.

- After climbing in accordance with the published missed approach procedure, press , verify or change the desired holding fix and press ENT.

GENERAL NOTES

- The data base must be up to date for instrument approach operation.
- Only one approach can be in the flight plan at a time.
- If the destination airport is the active waypoint at the time of the instrument approach selection, the active waypoint will shift automatically to the chosen IAF.
- Checking RAIM prediction for your approach while en route using the STA 5 page is recommended. A self check occurs automatically within 2nm of the FAF. APR ACTV is inhibited without RAIM.
- Data cannot be altered, added to or deleted from the approach procedures contained in the data base. (DME arc intercepts may be relocated along the arc through the SUPER NAV 5 or the FPL 0 pages).
- Some approach waypoints do not appear on the approach plates (including in some instances the FAF)!

SECTION 4 - NORMAL PROCEDURES (CONT'D)

- Waypoint suffixes in the flight plan:
 - i - IAF
 - f - FAF
 - m - MAP
 - h - missed approach holding fix.
- The DME arc IAF (arc intercept waypoint) will be a) on your present position radial off the arc VOR when you load the IAF into the flight plan, or b) the beginning of the arc if currently on a radial beyond the arc limit. To adjust the arc intercept to be compatible with a current radar vector, bring up the arc IAF waypoint in the SUPER NAV 5 page scanning field or under the cursor on the FPL 0 page, press CLR, then ENT. Fly the arc in LEG. adjust the HSI or CDI course pointer with reference to the desired track value on the SUPER NAV5 page (it will flash to remind you). Left/right dbar information is relative to the arc. Displayed distance is not along the arc but direct to the active waypoint. If desired, select NAV 2 page for digital DME arc distance to and radial from the reference VOR. (The ARC radial is also displayed on the SUPERNAV5 page.)
- The DME arc IAF identifier may be unfamiliar. Example: D098G where 098 stands for the 098° radial off the referenced VOR, and G is the seventh letter in the alphabet indicating a 7 DME arc.

SECTION 4 - NORMAL PROCEDURES (CONT'D)

- APR ARM to APR ACTV is automatic provided:
 - a. You are in APR ARM (normally automatic).
 - b. You are in LEG model!
 - c. The FAF is the active ; waypoint
 - d. Within 2 n.m. of the FAF.
 - e. Outside of the FAF.
 - f. Inbound to the FAF.
 - g. RAIM is available.
- Direct-To operation between the FAF and MAP cancels APR ACTV. Fly the missed approach in APR ARM.
- Flagged navigation inside the FAF may usually be restored (not guaranteed) by pressing the GPS APR button changing from ACTV to ARM. Fly the missed approach.
- The instrument approach using the KLN 90B may be essentially automatic starting 30 nm out (with a manual baro setting update) or it may require judicious selection of the OBS and LEG modes.
- APR ARM may be canceled at any time by pressing the GPS APR button. (A subsequent press will reselect it.)

SECTION 5 - PERFORMANCE

No Change.

SECTION 6 - WEIGHT AND BALANCE

Factory installed optional equipment is included in the licensed weight and balance data in Section 6 of the Basic Pilot's Operating Handbook.s

**PILOT'S OPERATING HANDBOOK
AND
FAA APPROVED AIRPLANE FLIGHT MANUAL**

**SUPPLEMENT NO. 12
FOR
BENDIX/KING KX 155A
COMM/NAV SYSTEM**

This supplement must be attached to the Pilot's Operating Handbook and FAA Approved Airplane Flight Manual when the KX 155A Comm/Nav System is installed per the Piper Drawings. The information contained herein supplements or supersedes the Pilot's Operating Handbook and FAA Approved Airplane Flight Manual only in those areas listed herein. For limitations, procedures and performance information not contained in this supplement, consult the Pilot's Operating Handbook and FAA Approved Airplane Flight Manual.

FAA APPROVED: _____



PETER E. PECK
D.O.A. NO. SO-1
THE NEW PIPER AIRCRAFT, INC.
VERO BEACH, FLORIDA

DATE OF APPROVAL: December 3, 1997

SECTION 1 GENERAL

This supplement supplies information necessary for the operation of the airplane when the Bendix/King KX 155A Comm/Nav System is installed in accordance with FAA approved Piper data.

SECTION 2 LIMITATIONS

No change.

SECTION 3- EMERGENCY PROCEDURES

No change.

SECTION 4- NORMAL PROCEDURES

COMM TRANSCEIVER

- (a.) Rotate the volume (VOL) knob clockwise from the OFF position.
- (b.) Pull the VOL knob out and adjust for desired listening level.
- (c.) Push the VOL knob back in to actuate the automatic squelch.
- (d.) Select the desired operating frequency in the standby display by rotating the frequency select knobs either clockwise or counter-clockwise.
- (e.) Push the comm transfer button to transfer the frequency from the standby to the active display.

NAV RECEIVER

- (a.) The right portion of the display is allocated to NAV receiver information. The frequency channeling is similar to the Comm when operating in the frequency mode. The NAV increment/decrement knobs are located on the right hand side of the front panel.

SECTION 5- PERFORMANCE

No change.

SECTION 6- WEIGHT AND BALANCE

See Section 6 of the basic Pilots Operating Handbook.

SECTION 7 DESCRIPTION & OPERATION

GENERAL

All controls required to operate the KX 155A/165A are located on the unit front panel. (See Figure 3-1.)

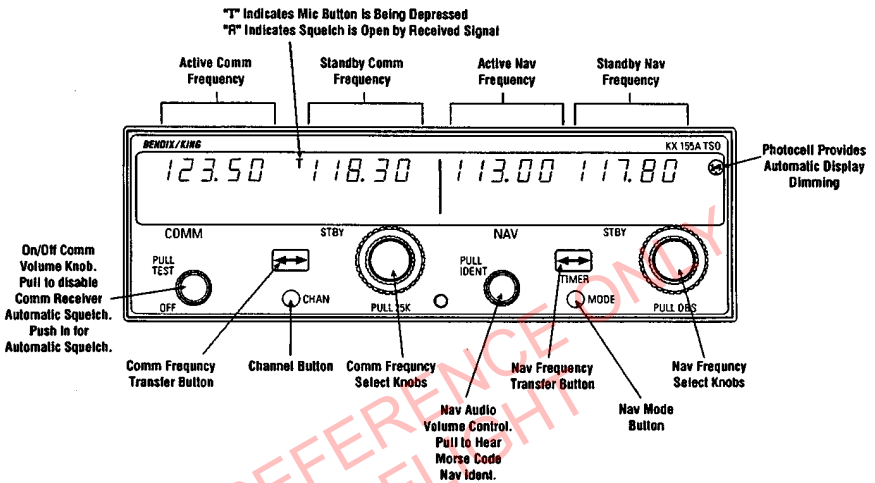

FIGURE 3-1
KX 155A CONTROL FUNCTIONS

COMM TRANSCEIVER

Rotate the VOL knob clockwise from the OFF position. Pull the VOL knob out and adjust for desired listening level. Push the VOL knob back in to actuate the automatic squelch.

The left portion of the digital display readout is allocated for COMM ACTIVE, and COMM STANDBY frequencies with a “T” between them to indicate TRANSMIT and an “R” to indicate RECEIVE modes of operation.

Select the desired operating frequency in the standby display by rotating the Frequency Select Knobs either clockwise or counter-clockwise. A clockwise rotation will increment the previous frequency while a counterclockwise rotation will decrement the previous frequency.

COMM TRANSCEIVER (CONT'D)

The outer knob will change the MHz portion of the standby display. At one band-edge (118 or 136 MHz) the following 1 MHz change will wrap around to the other band-edge. The inner knob will change the kHz portion of the standby display. It will change in steps of 50 kHz when the knob is pushed in, and 25 kHz when the knob is pulled out. For 8.33 kHz versions, channels are incremented in 25 kHz steps with the knob pushed in and 8.33 kHz with the knob pulled out. (Both 8.33 kHz and 25 kHz frequencies are channeled when the knob is pulled out). The frequency wrap around at the edge of the band is also utilized when incrementing or decrementing the kHz portion of the standby display.

To tune the radio to the desired operating frequency, the desired frequency must be entered into the standby display and then the transfer button must be pushed. This will trade the contents of the active and standby displays. The operating frequency can also be entered by accessing the ACTIVE ENTRY (direct tune) mode which is done by pushing and holding the COMM TRANSFER button for 2 or more seconds. In the direct tune mode, only the active part of the display is visible. The desired frequency can be directly entered into the display. Push the COMM TRANSFER button again to return to the active/standby display.

The transceiver is always tuned to the frequency appearing in the ACTIVE display. It is therefore possible to have two different frequencies stored in the ACTIVE and STANDBY displays and to change back and forth between them at the simple push of the transfer button.

During the transmit mode of operation, a "T" will appear between the ACTIVE and STANDBY displays. An "R" will appear between the ACTIVE and STANDBY displays if a detected signal is strong enough to open the squelch, signifying that the transceiver is in the receive mode of operation.

A non-volatile memory stores the comm ACTIVE and STANDBY frequencies on power down. When the unit is turned on again, the COMM ACTIVE and STANDBY windows will display the same ACTIVE and STANDBY frequencies that were displayed before power down.

The KX 155A also has provision to program 32 channels. Pressing the CHAN button for 2 or more seconds will cause the unit to enter the channel program mode. Upon entering the channel program mode, "PG" is displayed next to the channel number and the channel number will flash indicating that it can be programmed. The desired channel can be selected by turning the comm kHz knob. The channel frequency can be entered by pushing the COMM TRANSFER button which will cause the standby frequency to flash. The comm frequency knobs are then used to enter the desired frequency. If dashes (displayed when rotating the outer knob between 136 MHz and 118 MHz) are entered instead of a frequency, the corresponding channel is skipped in channel selection mode. Additional channels may be programmed by pressing the COMM TRANSFER and using the same procedure. To exit the program mode and save the channel information, momentarily push the CHAN button. This will cause the unit to return to the previous frequency entry mode. The unit will also exit the channel program mode if there is no button or knob activity for 20 seconds.

The channel selection mode can then be entered by momentarily pushing CHAN button. "CH" is displayed next to the last used channel number. The comm frequency knobs can be used to select the desired channel. The unit will automatically default to the previous mode if no channel is selected within 2 seconds after entering the channel selection mode.

The unit is placed in the transmit mode by depressing the MIC KEY button. The unit has a stuck microphone alert feature. If the microphone is keyed continuously for greater than 33 seconds, the transmitter stops transmitting and the active Comm frequency flashes to alert the pilot of the stuck microphone condition.

NAV RECEIVER

The right portion of the display is allocated to NAV receiver information. The frequency channeling is similar to the COMM when operating in the frequency mode (Figure 3-1). The NAV increment/decrement knobs are located on the right hand side of the front panel. The outer knob operates in 1 MHz steps and increments/decrements the STANDBY frequency display.

NAV RECEIVER (CONT'D)

The inner knob operates in 50 kHz steps. The NAV receiver's lower and upper frequency limits are 108.00 MHz and 117.95 MHz. Exceeding the upper limit of frequency band will automatically return to the lower limit and vice versa.

Depressing the NAV frequency transfer button for 2 seconds or more will cause the display to go in to the ACTIVE ENTRY mode. Only the ACTIVE frequency will be displayed and it can be directly changed by using the NAV inc/dec knobs. The display will return to the ACTIVE/STANDBY mode when the NAV frequency transfer button is pushed.

Depressing the mode button will cause the NAV display to go from the ACTIVE/STANDBY format to the ACTIVE/CDI (Course Deviation Indicator) format as shown below in Figure 3-2. In the CDI mode, the increment/decrement knob (pushed in) channels the ACTIVE frequency window and depressing the frequency transfer button will cause the ACTIVE frequency to be placed in blind storage and the STANDBY frequency (in blind storage) to be displayed in the ACTIVE window display. When the ACTIVE window is tuned to a VOR frequency, the standby frequency area is replaced by a three digit OBS (Omni Bearing Selector) display. The desired OBS course can be selected by pulling out the inner NAV frequency knob and turning it. This OBS display is independent of any OBS course selected on an external CDI or HSI. An "OBS" in the middle of the NAV display will flash while the inner NAV frequency knob is pulled out. The CDI is displayed on the line below the frequency/OBS. When the ACTIVE window is tuned to a localizer frequency, the standby frequency area is replaced by "LOC" Figure 3-3. Illustrations of the display are shown on the next page.

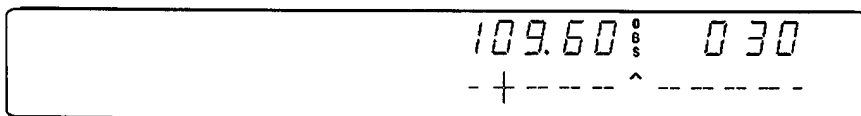

FIGURE 3-2
NAV DISPLAY; ACTIVE VOR FREQUENCY/CDI FORMAT

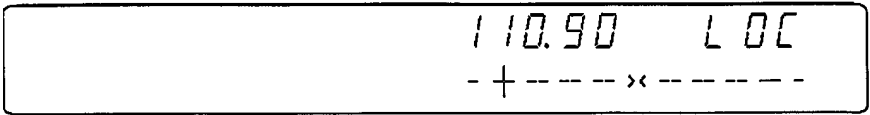

FIGURE 3-3
NAV DISPLAY; ACTIVE LOCALIZER FREQUENCY/CDI FORMAT

When the received signal is too weak to ensure accuracy the display will “flag”. See Figure 3-4.



FIGURE 3-4 VOR FLAG DISPLAY

NAV RECEIVER (CONT'D)

Depressing the mode button will cause the NAV display to go from the ACTIVE/CDI format to the ACTIVE/BEARING format. In the BEARING mode, the increment/decrement knob channels the ACTIVE frequency window and depressing the frequency transfer button will cause the ACTIVE frequency to be placed in blind storage and the STANDBY frequency (in blind storage) to be displayed in the ACTIVE window display. In bearing mode of operation, the right hand window of NAV display shows the bearing TO the station. Figure 3-5 below illustrates the NAV side of the display in this mode:

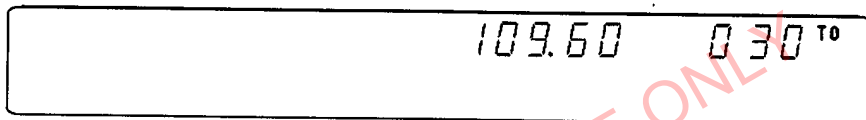

FIGURE 3-5 VOR MODE; BEARING TO FUNCTION

When a too weak or invalid VOR signal is received the display flags as shown in Figure 3-6.

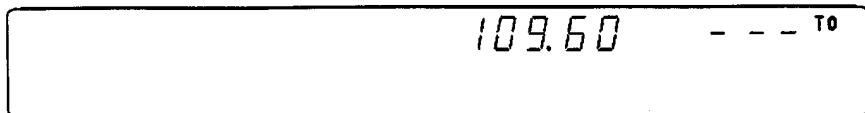

FIGURE 3-6 VOR MODE; ACTIVE/BEARING, FLAG DISPLAY

Another push of the mode button will cause the NAV display to go from the ACTIVE/BEARING format to the ACTIVE/RADIAL format as shown in Figure 3-7. In the RADIAL mode, the increment/decrement knob channels the ACTIVE frequency window and depressing the frequency transfer button will cause the ACTIVE frequency to be placed in blind storage and the STANDBY frequency (in blind storage) to be displayed in the ACTIVE window display. In radial mode of operation, the right hand window of NAV display shows the radial FROM the station. The picture below illustrates the NAV side of the display in this mode:

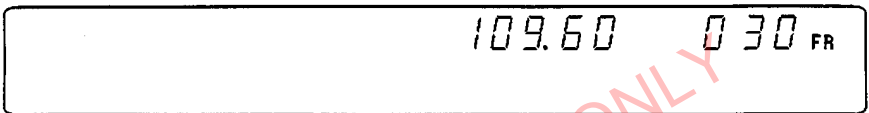

FIGURE 3-7 VOR MODE; RADIAL FROM FUNCTION

When a too weak or invalid VOR signal is received the display flags as shown in Figure 3-8.

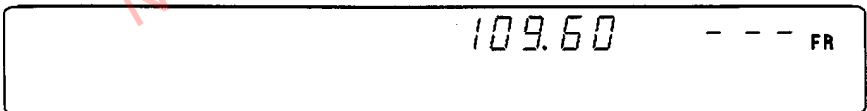

FIGURE 3-8 VOR MODE; ACTIVE/RADIAL, FLAG DISPLAY

NAV RECEIVER (CONT'D)

Another push of the mode button will cause the unit to go into the TIMER mode. See Figure 3-9. When the unit is turned on the elapsed timer begins counting upwards from zero. The timer can be stopped and reset to zero by pushing the NAV frequency transfer button for 2 seconds or more causing the ET on the display to flash. In this state the timer can be set as a countdown timer or the elapsed timer can be restarted. The countdown timer is set by using the NAV inc/dec knobs to set the desired time and then pushing the NAV frequency transfer button to start the timer. The outer knob selects minutes, the inner knob in the "in ~ position selects ten second intervals, and the inner knob in the ~out" position selects individual seconds. After the countdown timer reaches zero, the counter will begin to count upwards indefinitely while flashing for the first 15 seconds. The elapsed timer can also be reset to zero and started again after it has been stopped and reset to zero by pushing the NAV frequency transfer button.



FIGURE 3-9 TIMER MODE

The NAV ACTIVE and STANDBY frequencies are stored in the memory on power down and return on power up.

When the smaller increment/decrement knob is pushed in, depressing the NAV TRANSFER button will interchange the ACTIVE and STANDBY frequencies. The NAV IDENT knob is active in the pulled out position so that both voice and ident can be heard. When this knob is pushed in, the ident tone is attenuated. The volume of voice/ident can be adjusted by turning this knob.

PILOT CONFIGURATION

This mode can be accessed by pressing and holding the Nav Mode Button for more than 2 seconds and then pressing the Nav Frequency Transfer Button for an additional 2 seconds, while continuing to hold the Nav Mode Button. When the Pilot Config Mode is entered the unit will show the "SWRV" mnemonic which is the unit software revision level. Adjustment pages can be accessed by MODE button presses.

The pilot may adjust two parameters in the pilot configuration, the display minimum brightness and sidetone volume level. See Table 3-1.

Minimum Brightness (BRIM) will have a range of 0 - 255. The dimmest is 0 and the brightest is 255.

Sidetone volume level is adjusted when SIDE is displayed. Values from 0 - 255 may be selected with 0 being least volume, 255 being the greatest.

Adjustment	Mnemonic	Min Level	Max Level
Software Revision Number	SWRV	--	--
Minimum Display Brightness	BRIM	0	255
Sidetone Level	SIDE	0	255

Table 3-1 Pilot Configuration

Subsequent presses of the MODE button sequences through SWRV, BRIM, SIDE, and then back to SWRV.

Momentarily pressing the Nav Transfer Button exits Pilot configuration mode. The Nav returns to its pre-Pilot Config state with the new brightness and sidetone levels stored in non-volatile memory.

**PILOT'S OPERATING HANDBOOK
SUPPLEMENT NO. 13
FOR
PRECISE FLIGHT SPEEDBRAKE 2000**

This supplement has been DELETED as the FAA Approved Operational Supplement to the Precise Flight SPEEDBRAKE2000 System as installed in this aircraft per STC SA00520SE. Precise Flight Inc. is responsible to supply and revise the operational supplement. It is permitted to include the Precise Flight supplement in this location of the Pilot's Operating Handbook unless otherwise stated by Precise Flight.

PILOT'S OPERATING HANDBOOK
SUPPLEMENT NO. 14
FOR
BENDIX/KING KFC 225 FLIGHT CONTROL SYSTEM

This supplement has been DELETED as the FAA Approved Operational Supplement to the Bendix/King KFC 225 Series Flight Control System as installed per STC SA00656WI-D. Bendix/King is responsible to supply and revise the operational supplement. It is permitted to include the Bendix/King supplement in this location of the Pilot's Operating Handbook unless otherwise stated by Bendix/King.

**PILOT'S OPERATING HANDBOOK
AND
FAA APPROVED AIRPLANE FLIGHT MANUAL
SUPPLEMENT NO. 15
FOR
GARMIN GNS 430 VHF COMMUNICATION
TRANSCEIVER/VOR/ILS RECEIVER/GPS RECEIVER**

This supplement must be attached to the Pilot's Operating Handbook and FAA Approved Airplane Flight Manual when the Garmin GNS 430 VHF Communication Transceiver/VOR/ILS Receiver/Global Positioning System is installed per the Equipment List. The information contained herein supplements or supersedes the Pilot's Operating Handbook and FAA Approved Airplane Flight Manual only in those areas listed herein. For limitations, procedures and performance information not contained in this supplement, consult the Pilot's Operating Handbook and FAA Approved Airplane Flight Manual.

FAA APPROVED:



PETER E. PECK
D.O.A. NO. SO- I
THE NEW PIPER AIRCRAFT, INC.
VERO BEACH, FLORIDA

DATE OF APPROVAL: September 20, 1999

SECTION 1 - GENERAL

The GNS 430 System is a fully integrated, panel mounted instrument, which contains a VHF Communications Transceiver, a VOR/ILS receiver, and a Global Positioning System (GPS) Navigation computer. The system consists of a GPS antenna, GPS receiver, VHF VOR/LOC/GS antenna, VOR/ILS receiver, VHF COMM antenna and a VHF Communications transceiver. The primary function of the VHF Communication portion of the equipment is to facilitate communication with Air Traffic Control. The primary function of the VOR/ILS Receiver portion of the equipment is to receive and demodulate VOR, Localizer, and Glide Slope signals. The primary function of the GPS portion of the system is to acquire signals from the GPS system satellites, recover orbital data, make range and Doppler measurements, and process this information in real-time to obtain the user's position, velocity, and time.

Provided the GARMIN GNS 430's GPS receiver is receiving adequate usable signals, it has been demonstrated capable of and has been shown to meet the accuracy specifications for:

- VFR/IFR enroute, terminal, and non-precision instrument approach (GPS, Loran-C, VOR, VOR-DME, TACAN, NDB, NDB-DME, RNAV) operation within the U.S. National Airspace System in accordance with AC 20-138.
- North Atlantic Minimum Navigation Performance Specification (MNPS) Airspace in accordance with AC 91-49 and AC 120-33.
- The system meets RNP5 airspace (BRNAV) requirements of AC 90-96 and in accordance with AC 20-138, and JAA AMJ 20X2 Leaflet 2 Revision 1, provided it is receiving usable navigation information from the GPS receiver.

Navigation is accomplished using the WGS-84 (NAD-83) coordinate reference datum. Navigation data is based upon use of only the Global Positioning System (GPS) operated by the United States of America.

SECTION 2 - LIMITATIONS

- A. The GARMIN GNS 430 Pilot's Guide, p/n 190-00140-00, Rev. A, dated October 1998, or later appropriate revision, must be immediately available to the flight crew whenever navigation is predicated on the use of the system.
- B. The GNS 430 must utilize the following or later FAA approved software versions:

Sub-System	Software Version
Main	2.00
GPS	2.00
Comm	2.00
VOR/LOC	2.00
G/S	2.00

The main software version is displayed on the GNS 430 self test page immediately after turn-on for 5 seconds. The remaining system software versions can be verified on the AUX group sub-page 2, "SOFTWARE/DATABASE VER".

- C. IFR enroute and terminal navigation predicated upon the GNS 430's GPS Receiver is prohibited unless the pilot verifies the currency of the data base or verifies each selected waypoint for accuracy by reference to current approved data.
- D. Instrument approach navigation predicated upon the GNS 430's GPS Receiver must be accomplished in accordance with approved instrument approach procedures that are retrieved from the GPS equipment data base. The GPS equipment data base must incorporate the current update cycle.
1. Instrument approaches utilizing the GPS receiver must be conducted in the approach mode and Receiver Autonomous Integrity Monitoring (RAIM) must be available at the Final Approach Fix.

SECTION 2 - LIMITATIONS (continued)

2. Accomplishment of ILS, LOC, LOC-BC, LDA, SDF, MLS or any other type of approach not approved for GPS overlay with the GNS 430's GPS receiver is not authorized.
 3. Use of the GNS 430 VOR/ILS receiver to fly approaches not approved for GPS require VOR/ILS navigation data to be present on the external indicator.
 4. When an alternate airport is required by the applicable operating rules, it must be served by an approach based on other than GPS or Loran-C navigation, the aircraft must have the operational equipment capable of using that navigation aid, and the required navigation aid must be operational.
 5. VNAV information may be utilized for advisory information only. Use of VNAV information for Instrument Approach Procedures does not guarantee Step-Down Fix altitude protection, or arrival at approach minimums in normal position to land.
- E. If not previously defined, the following default settings must be made in the 'SETUP 1' menu of the GNS 430 prior to operation (refer to Pilot's Guide for procedure if necessary):
1. dis, spdnm kt (sets navigation units to "nautical miles" and "knots")
 2. alt, vsft fpm (sets altitude units to "feet" and "feet per minute")
 3. map datum...WGS 84 (sets map datum to WGS-84, see note below)
 4. posndeg-min (sets navigation grid units to decimal minutes)

NOTE

In some areas outside the United States, datums other than WGS-84 or NAD-83 may be used. If the GNS 430 is authorized for use by the appropriate Airworthiness authority, the required geodetic datum must be set in the GNS 430 prior to its use for navigation.

SECTION 3 - EMERGENCY PROCEDURES**ABNORMAL PROCEDURES**

- A. If GARMIN GNS 430 navigation information is not available or invalid, utilize remaining operational navigation equipment as required.
- B. If “RAIM POSITION WARNING” message is displayed the system will flag and no longer provide GPS based navigational guidance. The crew should revert to the GNS 430 VOR/ILS receiver or an alternate means of navigation other than the GNS 430’s GPS receiver.
- C. If “RAIM IS NOT AVAILABLE” message is displayed in the enroute, terminal, or initial approach phase of flight, continue to navigate using the GPS equipment or revert to an alternate means of navigation other than the GNS 430’s GPS receiver appropriate to the route and phase of flight. When continuing to use GPS navigation, position must be verified every 15 minutes using the GNS 430’s VOR/ILS receiver or another IFR-approved navigation system.
- D. If “RAIM IS NOT AVAILABLE” message is displayed while on the final approach segment, GPS based navigation will continue for up to 5 minutes with approach CDI sensitivity (0.3 nautical mile). After 5 minutes the system will flag and no longer provide course guidance with approach sensitivity. Missed approach course guidance may still be available with 1 nautical mile CDI sensitivity by executing the missed approach.
- E. In an in-flight emergency, depressing and holding the Comm transfer button for 2 seconds will select the emergency frequency of 121.500 Mhz into the “Active” frequency window.

SECTION 4 - NORMAL PROCEDURES

WARNING

Familiarity with the enroute operation of the GNS 430 does not constitute proficiency in approach operations. Do not attempt approach operations in IMC prior to attaining proficiency in the use of the GNS 430 approach feature.

A. DETAILED OPERATING PROCEDURES

Normal operating procedures are described in the GARMIN GNS 430 Pilot's Guide, p/n 190-00140-00, Rev. A, dated October 1998, or later appropriate revision.

B. PILOT'S DISPLAY

The GNS 430 System data will appear on the Pilot's HSI. The source of data is either GPS or VLOC as annunciated on the display above the CDI key.

C. AUTOPILOT/FLIGHT DIRECTOR OPERATION

Coupling of the GNS 430 System steering information to the autopilot/flight director can be accomplished by engaging the autopilot/flight director in the NAV or APR mode.

When the autopilot/flight director system is using course information supplied by the GNS 430 System and the course pointer is not automatically driven to the desired track, the course pointer on the HSI must be manually set to the desired track (DTK) indicated by the GNS 430. For detailed autopilot/flight director operational instructions, refer to the FAA Approved Flight Manual Supplement for the autopilot/flight director.

SECTION 5 - PERFORMANCE

No change.

SECTION 6 - WEIGHT AND BALANCE

Factory installed optional equipment is included in the licensed weight and balance data in Section 6 of the basic Pilot's Operating Handbook.

SECTION 7 - DESCRIPTION AND OPERATION

See GNS 430 Pilot's Guide for a complete description of the GNS 430 system.

**FOR REFERENCE ONLY
NOT FOR FLIGHT**

**PILOT'S OPERATING HANDBOOK
AND
FAA APPROVED AIRPLANE FLIGHT MANUAL**

**SUPPLEMENT NO. 16
FOR
S-TEC SYSTEM 55 TWO AXIS
AUTOMATIC FLIGHT GUIDANCE SYSTEM
WITH TRIM MONITOR**

(Serial numbers 4636248 and up)

The FAA approved operational supplement for the S-TEC System 55 Autopilot, installed in accordance with STC SA09402AC-D, is required for operation of this system. S-TEC will be responsible to supply and revise the operational supplement. It is permitted to include the S-TEC supplement in this location of the Pilot's Operating Handbook unless otherwise stated by S-TEC. The information contained in the S-TEC supplement may supersede or supplement the information in the basic Pilot's Operating Handbook and FAA Approved Airplane Flight Manual with respect to the operation of the S-TEC System 55 Autopilot. For limitations, procedures and performance information not contained in the S-TEC supplement, consult the basic Pilot's Operating Handbook and FAA Approved Airplane Flight Manual.

**PILOT'S OPERATING HANDBOOK
AND
FAA APPROVED AIRPLANE FLIGHT MANUAL**

**SUPPLEMENT NO. 17
FOR
GARMIN GNS 530 VHF COMMUNICATION
TRANSCIVER/VOR/ILS RECEIVER/GPS RECEIVER**

This supplement must be attached to the Pilot's Operating Handbook and FAA Approved Airplane Flight Manual when the Garmin GNS 530 VHF Communication Transceiver/VOR/ILS Receiver/Global Positioning System is installed per the Equipment List. The information contained herein supplements or supersedes the Pilot's Operating Handbook and FAA Approved Airplane Flight Manual only in those areas listed herein. For limitations, procedures and performance information not contained in this supplement, consult the Pilot's Operating Handbook and FAA Approved Airplane Flight Manual.

FAA APPROVED:



PETER E. PECK
D.O.A. NO. SO- 1
THE NEW PIPER AIRCRAFT, INC.
VERO BEACH, FLORIDA

DATE OF APPROVAL: September 10, 2001

SECTION 1 - GENERAL

The GNS 530 System is a fully integrated, panel mounted instrument, which contains a VHF Communications Transceiver, a VOR/ILS Receiver, and a Global Positioning System (GPS) Navigation computer. The system consists of a GPS Antenna, GPS Receiver, VHF VOR/LOC/GS Antenna, VOR/ILS Receiver, VHF COMM Antenna and a VHF Communications Transceiver. The primary function of the VHF Communication portion of the equipment is to facilitate communication with Air Traffic Control. The primary function of the VOR/ILS Receiver portion of the equipment is to receive and demodulate VOR, Localizer, and Glide Slope signals. The primary function of the GPS portion of the system is to acquire signals from the GPS system satellites, recover orbital data, make range and Doppler measurements, and process this information in real-time to obtain the user's position, velocity, and time.

Provided the GARMIN GNS 530's GPS receiver is receiving adequate usable signals, it has been demonstrated capable of and has been shown to meet the accuracy specifications for:

- VFR/IFR enroute, terminal, and non-precision instrument approach (GPS, Loran-C, VOR, VOR-DME, TACAN, NDB, NDB-DME, RNAV) operation within the U.S. National Airspace System in accordance with AC 20-138.
- One of the approved sensors, for a single or dual GNS 530 installation, for North Atlantic Minimum Navigation Performance Specification (MNPS) Airspace in accordance with AC 91-49 and AC 120-33.
- The system meets RNP5 airspace (BRNAV) requirements of AC 90-96 and in accordance with AC 20-138, and JAA AMJ 20X2 Leaflet 2 Revision 1, provided it is receiving usable navigation information from the GPS receiver.

Navigation is accomplished using the WGS-84 (NAD-83) coordinate reference datum. Navigation data is based upon use of only the Global Positioning System (GPS) operated by the United States of America.

SECTION 2 - LIMITATIONS

- A. The GARMIN GNS 530 Pilot's Guide, p/n 190-00181-00, Rev. A, dated November 1999, or later appropriate revision, must be immediately available to the flight crew whenever navigation is predicated on the use of the system.
- B. The Garmin 500 Series Pilot's Guide Addendum, Display Interface for Traffic and Weather Data, must be immediately available to the flight crew if the B.F. Goodrich WX-500 Stormscope® or the B.F. Goodrich SKYWATCH™ Traffic Advisory System (TAS) is installed.
- C. The GNS 530 must utilize the following or later FAA approved software versions:

Sub-System	Software Version
Main	2.00
GPS	2.00
Comm	1.22
VOR/LOC	1.25
G/S	2.00

The main software version is displayed on the GNS 530 self test page immediately after turn-on for 5 seconds. The remaining system software versions can be verified on the AUX group sub-page 2, "SOFTWARE/DATABASE VER".

- D. IFR enroute and terminal navigation predicated upon the GNS 530's GPS Receiver is prohibited unless the pilot verifies the currency of the data base or verifies each selected waypoint for accuracy by reference to current approved data.
- E. Instrument approach navigation predicated upon the GNS 530's GPS Receiver must be accomplished in accordance with approved instrument approach procedures that are retrieved from the GPS equipment data base. The GPS equipment data base must incorporate the current update cycle.
1. Instrument approaches utilizing the GPS receiver must be conducted in the approach mode and Receiver Autonomous Integrity Monitoring (RAIM) must be available at the Final Approach Fix.

SECTION 2 - LIMITATIONS (continued)

2. Accomplishment of ILS, LOC, LOC-BC, LDA, SDF, MLS or any other type of approach not approved for GPS overlay with the GNS 530's GPS receiver is not authorized.
 3. Use of the GNS 530 VOR/ILS receiver to fly approaches not approved for GPS require VOR/ILS navigation data to be present on the external indicator.
 4. When an alternate airport is required by the applicable operating rules, it must be served by an approach based on other than GPS or Loran-C navigation, the aircraft must have the operational equipment capable of using that navigation aid, and the required navigation aid must be operational.
 5. VNAV information may be utilized for advisory information only. Use of VNAV information for Instrument Approach Procedures does not guarantee Step-Down Fix altitude protection, or arrival at approach minimums in normal position to land.
- F. If not previously defined, the following default settings must be made in the 'SETUP 1' menu of the GNS 530 prior to operation (refer to Pilot's Guide for procedure if necessary):
1. dis, spd n k
 m t (sets navigation units to 'nautical miles' and 'knots')
 2. alt, vs . ft fpm (sets altitude units to 'feet' and 'feet per minute')
 3. map datum.. WGS 84 (sets map datum to WGS-84, see not below)
 4. posn ... deg-min (sets navigation grid units to decimal minutes)

NOTE

In some areas outside the United States, datums other than WGS-84 or NAD-83 may be used. If the GNS 530 is authorized for use by the appropriate Airworthiness authority, the required geodetic datum must be set in the GNS 530 prior to its use for navigation.

SECTION 3 - EMERGENCY PROCEDURES**ABNORMAL PROCEDURES**

- A. If GARMIN GNS 530 navigation information is not available or invalid, utilize remaining operational navigation equipment as required.
- B. If "RAIM POSITION WARNING" message is displayed the system will flag and no longer provide GPS based navigational guidance. The crew should revert to the GNS 530 VOR/ILS receiver or an alternate means of navigation other than the GNS 530's GPS receiver.
- C. If "RAIM IS NOT AVAILABLE" message is displayed in the enroute, terminal, or initial approach phase of flight, continue to navigate using the GPS equipment or revert to an alternate means of navigation other than the GNS 530's GPS receiver appropriate to the route and phase of flight. When continuing to use GPS navigation, position must be verified every 15 minutes using the GNS 530's VOR/ILS receiver or another IFR-approved navigation system.
- D. If "RAIM IS NOT AVAILABLE" message is displayed while on the final approach segment, GPS based navigation will continue for up to 5 minutes with approach CDI sensitivity (0.3 nautical mile). After 5 minutes the system will flag and no longer provide course guidance with approach sensitivity. Missed approach course guidance may still be available with 1 nautical mile CDI sensitivity by executing the missed approach.
- E. In an in-flight emergency, depressing and holding the Comm transfer button for 2 seconds will select the emergency frequency of 121.500 Mhz into the "Active" frequency window.

SECTION 4 - NORMAL PROCEDURES

WARNING

Familiarity with the enroute operation of the GNS 530 does not constitute proficiency in approach operations. Do not attempt approach operations in IMC prior to attaining proficiency in the use of the GNS 530 approach features.

A. DETAILED OPERATING PROCEDURES

Normal operating procedures are described in the GARMIN GNS 530 Pilot's Guide, p/n 190-00181-00, Rev. A, dated November 1999, or later appropriate revision.

B. PILOT'S DISPLAY

The GNS 530 System data will appear on the Pilot's HSI. The source of data is either GPS or VLOC as annunciated on the display above the CDI key.

C. AUTOPILOT/FLIGHT DIRECTOR OPERATION

Coupling of the GNS 530 System steering information to the autopilot/flight director can be accomplished by engaging the autopilot/flight director in the NAV or APR mode.

When the autopilot/flight director system is using course information supplied by the GNS 530 System and the course pointer is not automatically driven to the desired track, the course pointer on the HSI must be manually set to the desired track (DTK) indicated by the GNS 530. For detailed autopilot/flight director operational instructions, refer to the FAA Approved Flight Manual Supplement for the autopilot/flight director.

D. CROSSFILL OPERATIONS

Crossfill capabilities exist between GNS 530 systems. Refer to the Garmin GNS 530 Pilot's Guide for detailed crossfill operating instructions.

SECTION 4 - NORMAL PROCEDURES (continued)

E. AUTOMATIC LOCALIZER COURSE CAPTURE

By default, the GNS 530 automatic localizer course capture feature is enabled. This feature provides a method for system navigation data present on the external indicators to be switched automatically from GPS guidance to localizer/glide slope guidance at the point of course intercept on a localizer at which GPS derived course deviation equals localizer derived course deviation. If an offset from the final approach course is being flown, it is possible that the automatic switch from GPS course guidance to localizer/glide slope course guidance will not occur. It is the pilot's responsibility to ensure correct system navigation data is present on the external indicator before continuing a localizer based approach beyond the final approach fix.

SECTION 5 - PERFORMANCE

No change.

SECTION 6 - WEIGHT AND BALANCE

Factory installed optional equipment is included in the licensed weight and balance data in Section 6 of the basic Pilot's Operating Handbook.

SECTION 7 - DESCRIPTION AND OPERATION

See GNS 530 Pilot's Guide for a complete description of the GNS 530 system.

**PILOT'S OPERATING HANDBOOK
AND
FAA APPROVED AIRPLANE FLIGHT MANUAL**

**SUPPLEMENT NO. 18
FOR
GARMIN GTX 327 TRANSPONDER**

This supplement must be attached to the Pilot's Operating Handbook and FAA Approved Airplane Flight Manual when the Garmin GTX 327 Transponder is installed per the Equipment List. The information contained herein supplements or supersedes the Pilot's Operating Handbook and FAA Approved Airplane Flight Manual only in those areas listed herein. For limitations, procedures and performance information not contained in this supplement, consult the Pilot's Operating Handbook and FAA Approved Airplane Flight Manual.

FAA APPROVED:



PETER E. PECK
D.O.A. NO. SO- 1
THE NEW PIPER AIRCRAFT, INC.
VERO BEACH, FLORIDA

DATE OF APPROVAL: September 10, 2001

SECTION 1 - GENERAL

This supplement supplies information necessary for the operation of the airplane when the Garmin GTX 327 Transponder is installed in accordance with FAA approved Piper data.

SECTION 2 - LIMITATIONS

No change.

SECTION 3 - EMERGENCY PROCEDURES

To transmit an emergency signal:

- Mode Selection Key - ALT
- Code Selection - SELECT 7700

To transmit a signal representing loss of all communications:

- Mode Selection Key - ALT
- Code Selection - SELECT 7600

SECTION 4 - NORMAL PROCEDURES

BEFORE TAKEOFF:

- To transmit Mode C (Altitude Reporting) code in flight:
- Mode Selection Key - ALT
- Code Selector Keys - SELECT assigned code.

To transmit Mode A (Aircraft Identification) code in flight:

- Mode Selector Key - ON
- Code Selector Keys - SELECT assigned code.

NOTE

During normal operation with the ON mode selected, the reply indicator 'R' flashes, indicating transponder replies to interrogations.

NOTE

Mode A reply codes are transmitted in ALT also; however, Mode C codes only are suppressed when the Function Selector ON key is selected.

SECTION 5 - PERFORMANCE

No change.

SECTION 6 - WEIGHT AND BALANCE

Factory installed optional equipment is included in the licensed weight and balance data in section 6 of the Airplane Flight Manual.

SECTION 7 - DESCRIPTION AND OPERATION





The GTX 327 transponder is powered on by pressing the **STBY**, **ALT** or **ON** keys, or by a remote avionics master switch (if applicable). After power on, a start-up page will be displayed while the unit performs a self test.

Mode Selection Keys

OFF - Powers off the GTX 327.

STBY - Powers on the transponder in standby mode. At power on the last active identification code will be selected. When in standby mode, the transponder will not reply to any interrogations.

ON - Powers on the transponder in Mode A. At power on the last active identification code will be selected. In this mode, the transponder replies to interrogations, as indicated by the Reply Symbol . Replies do not include altitude information.

ALT - Powers on the transponder in Mode A and Mode C. At power on the last active identification code will be selected. In ALT mode, the transponder replies to identification and altitude interrogations, as indicated by the Reply Symbol . Replies to altitude interrogations include the standard pressure altitude received from an external altitude source, which is not adjusted for barometric pressure. The ALT mode may be used in aircraft not equipped with the optional altitude encoder; however, the reply signal will not include altitude information.



GTX 327 Configuration Mode

The GTX 327's configuration, which is normally done at time of installation, influences many of the unit's functions described in this manual. If you wish to view or change any of the GTX 327 configuration parameters, you may access the GTX 327 Configuration Mode. Use caution when changing configuration. When in doubt, contact your authorized GARMIN Aviation Service Center. The Configuration Mode should not be used while the aircraft is airborne.

SECTION 7 - DESCRIPTION AND OPERATION (continued)

GTX 327 Configuration Mode (continued)

To use the GTX 327 Configuration Mode:

1. Press and hold the FUNC key while powering on the unit using the **STBY, ON, or ALT** key (or using an avionics master switch).
2. Press the **FUNC** key to sequence through the configuration pages.
3. Use the **CRSR** key to highlight selectable fields on each page.
4. When a field is highlighted, enter numeric data using the **0 - 9** keys, and select items from a list using the **8** or **9** keys.
5. Press the **CRSR** key to confirm list selections.

Code Selection

Code selection is done with eight keys (0 - 7) that provide 4,096 active identification codes. Pushing one of these keys begins the code selection sequence. The new code will not be activated until the fourth digit is entered. Pressing the **CLR** key will move the cursor back to the previous digit. Pressing the **CLR** key when the cursor is on the first digit of the code, or pressing the **CRSR** key during code entry, will remove the cursor and cancel data entry, restoring the previous code. The numbers 8 and 9 are not used for code entry, only for entering a Count Down time, and in the Configuration Mode.



SECTION 7 - DESCRIPTION AND OPERATION (continued)

Code Selection (continued)

Important Codes:

- 1200** - The VFR code for any altitude in the US (Refer to ICAO standards elsewhere)
- 7000** - The VFR code commonly used in Europe (Refer to ICAO standards)
- 7500** - Hijack code (Aircraft is subject to unlawful interference)
- 7600** - Loss of communications
- 7700** - Emergency
- 7777** - Military interceptor operations (Never squawk this code)
- 0000** - Military use (Not enterable)

Care should be taken not to select the code 7500 and all codes in the 7600 - 7777 range, which trigger special indicators in automated facilities. Only the code 7500 will be decoded as the hijack code. An aircraft's transponder code (when available) is utilized to enhance the tracking capabilities of the ATC facility, therefore care should be taken when making routine code changes.

Keys for Other GTX 327 Functions



IDENT - Pressing the IDENT key activates the Special Position Identification (SPI) Pulse for 18 seconds, identifying your transponder return from others on the air traffic controller's screen. The word "IDENT" will appear in the upper left corner of the display while the IDENT mode is active.



VFR - Sets the transponder code to the pre-programmed VFR code selected in Configuration Mode (this is set to 1200 at the factory). Pressing the VFR key again will restore the previous identification code.



FUNC - Changes the page shown on the right side of the display. Displayed data includes Pressure Altitude, Flight Time, Count Up timer, Count Down timer, and may include Contrast and Display Brightness, depending on configuration (as shown in the screens below):

SECTION 7 - DESCRIPTION AND OPERATION (continued)

Keys for Other GTX 327 Functions (continued)

 **PRESSURE ALT:** Displays the altitude data supplied to the GTX 327 in feet, hundreds of feet (i.e., flight level), or meters, depending on configuration.

 **FLIGHT TIME:** Displays the Flight Time, which is controlled by the **START/STOP** key or by a squat switch as configured during installation. With squat switch control, the timer begins when lift off is sensed and pauses when landing is sensed.

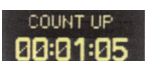
 **COUNT UP TIMER:** Controlled by **START/STOP** and **CLR** keys.

 **COUNT DOWN TIMER:** Controlled by **START/STOP**, **CLR**, and **CRSR** keys. The initial Count Down time is entered with the **0 - 9** keys.

 **CONTRAST:** This page is only displayed if manual contrast mode is selected in Configuration Mode. Contrast is controlled by the **8** and **9** keys.

 **DISPLAY:** This page is only displayed if manual backlighting mode is selected in Configuration Mode. Backlighting is controlled by the **8** and **9** keys.



START/STOP - Starts and stops the Count Up and Count Down timers.



CRSR - Initiates entry of the starting time for the Count Down timer and cancels transponder code entry.



CLR - Resets the Count Up and Count Down timers and cancels the previous keypress during code selection.



8 - Reduces Contrast and Display Brightness when the respective pages are displayed. Also enters the number 8 into the Count Down timer.



9 - Increases Contrast and Display Brightness when the respective pages are displayed. Also enters the number 9 into the Count Down timer.

SECTION 7 - DESCRIPTION AND OPERATION (continued)

Altitude Trend Indicator

When the 'PRESSURE ALT' page is displayed, an arrow may be displayed to the right of the altitude, indicating that the altitude is increasing or decreasing. One of two sizes of arrows may be displayed depending on the rate of climb/descent. The sensitivity of these arrows is set using the GTX Configuration Mode.

Timer Operation

To operate the Flight Timer:

1. Press the FUNC key until 'FLIGHT TIME' is displayed.
2. If the GTX 327 is configured as having a squat switch installed, the timer will begin counting automatically when the squat switch senses that the aircraft has become airborne.
3. If desired, you may press **START/STOP** to pause or restart the timer.
4. Press **CLR** to reset the timer to zero.
5. If the GTX 327 is configured as having a squat switch installed, the timer will pause automatically when the squat switch senses that the aircraft has touched down.

To operate the Count Up timer:

1. Press the FUNC key until 'COUNT UP' is displayed.
2. If necessary, press **CLR** to reset the Count Up timer to zero.
3. Press **START/STOP** to count up.
4. Press **START/STOP** again to pause the timer.
5. Press **CLR** to reset the timer to zero.

To operate the Count Down timer:

1. Press the FUNC key until 'COUNT DOWN' is displayed.
2. Press **CRSR** and use the **0 - 9** keys to set the initial time. All digits must be entered (use the 0 key to enter leading zeros).
3. Press **START/STOP** to count down.
4. Press **START/STOP** again to pause the timer.
5. When the Count Down timer expires, the words 'COUNT DOWN' are replaced with 'EXPIRED', and the time begins counting up and flashing.
6. Press **CLR** to reset the timer to the initial time value.

SECTION 7 - DESCRIPTION AND OPERATION (continued)

Automatic ALT/STBY Mode Switching

If the GTX 327 is configured for automatic standby switching, the mode will automatically change to ALT when a squat switch senses that the aircraft has become airborne. Also, the mode will change to STBY automatically when a squat switch senses that the aircraft has touched down. Additionally, a delay time can be set in the Configuration Mode, causing the GTX 327 to wait a specified length of time after landing before automatically changing to STBY mode.

FOR REFERENCE ONLY
NOT FOR FLIGHT

**PILOT'S OPERATING HANDBOOK
AND
FAA APPROVED AIRPLANE FLIGHT MANUAL

SUPPLEMENT NO. 19
FOR
AVIDYNE 5RR-MFC-SERIES
FLIGHTMAX FLIGHT SITUATION DISPLAY**

This supplement must be attached to the Pilot's Operating Handbook and FAA Approved Airplane Flight Manual when the Avidyne FlightMax 700/750, 5RR-MFC-XXX-(), is installed in accordance with Avidyne Installation Manual 600-0067 Rev. 0 or later per the Equipment List. The information contained herein supplements or supersedes the Pilot's Operating Handbook and FAA Approved Airplane Flight Manual only in those areas listed herein. For limitations, procedures and performance information not contained in this supplement, consult the Pilot's Operating Handbook and FAA Approved Airplane Flight Manual.

FAA APPROVED:



PETER E. PECK
D.O.A. NO. SO- 1
THE NEW PIPER AIRCRAFT, INC.
VERO BEACH, FLORIDA

DATE OF APPROVAL: September 10, 2001

SECTION 1 - GENERAL

NOTE

FlightMax 700 FSD is a radar indicator only and does not have functionality for Navigator, Lightning, Charts, or Traffic. The FlightMax 700 FSD is a radar indicator only for the RDR-2000 Vertical Profile Weather Radar System.

This supplement provides information necessary for the operation of the aircraft with the Avidyne FlightMax 700/750 FSD installed (5RR-MFC Series FlightMax Flight Situation Display installed in accordance with FAA approved Piper data).

SECTION 2 - LIMITATIONS

1. Use of Avidyne charts during IFR flight requires an IFR approved GPS receiver and installation, operated in accordance with its applicable limitations. (FlightMax 750 FSD only)
2. Use of Avidyne Navigator during IFR flight requires an IFR approved GPS receiver and installation, operated in accordance with its applicable limitations. (FlightMax 750 FSD only)
3. Navigation during IFR flight is not to be predicated on the use of Avidyne Navigator while in internal navigation mode. (FlightMax 750 FSD only)
4. Navigation during IFR flight is not to be predicated on the use of Avidyne Navigator unless: (FlightMax 750 FSD only)
 - a. The navigational data base is current; or
 - b. The pilot manually verifies the location of each waypoint used for navigational guidance
5. Navigation is not to be predicated on the use of Avidyne charts. (FlightMax 750 FSD only)
6. Loading or updating charts and navigation data with the CD-ROM is not to be accomplished while in flight. (FlightMax 750 FSD only)
7. The user's manual for the 5RR-MFC Series Avidyne FlightMax 700/750 must be available to the pilot during all flight operations.

SECTION 3 - EMERGENCY PROCEDURES

There is no change to the aircraft emergency procedures with this equipment installed.

SECTION 4 - NORMAL PROCEDURES

Normal operating procedures for all FSD functions are shown in the FlightMax 700/750 Series User's Manual, 600-0032.

The system is protected by a circuit breaker labeled RADAR.

The Avidyne unit controls the operating mode (Standby or Operate) for the SKYWATCH TAS. Normally the unit is in Standby on the ground and Operate when airborne. If the Avidyne unit is inoperative, the SKYWATCH TAS cannot be selected to operate on the ground. (FlightMax 750 FSD only)

SECTION 5 - PERFORMANCE

There is no change to aircraft performance with this equipment installed.

SECTION 6 - WEIGHT AND BALANCE

Factory installed optional equipment is included in the licensed weight and balance data in Section 6 of the Pilot's Operating Handbook.

SECTION 7 - DESCRIPTION AND OPERATION

AVIDYNE NAVIGATOR (FlightMax 750 FSD only)

Avidyne Navigator is a vector graphic, moving map navigation management and display program. Navigator uses a database of airports, nav aids, airways and airspace fixes which allows the pilot to view a detailed map of the navigational environment and follow the progress of a flight plan. Flight plans can be constructed and saved using items in the database.

SECTION 7 - DESCRIPTION AND OPERATION (CONTINUED)

AVIDYNE NAVIGATOR (FlightMax 750 FSD only) (continued)

Navigator displays real-time navigation data such as distance and bearing to waypoints and nearby airports, cross-track error against a planned route of flight, and estimated time of arrival at a destination. This information is displayed in data blocks overlaid onto the moving map. Avidyne has provided several default nav pages that contain commonly used data blocks. Custom display pages can be designed by selecting and arranging data blocks in a manner appropriate to each phase of flight.

Avidyne Navigator obtains position data such as latitude/longitude, ground track and speed from a separately installed and approved Global Positioning System (GPS) receiver. The characteristics and approved uses of the GPS receiver from which it gets its data determine, in part, the ways that Navigator may be used in flight. In addition to basic position data, most GPS receivers also send flight plan information, navigation data, and supplemental data such as satellite status.

NOTE

No Avidyne heading information is available when Skywatch is in Standby mode during ground operation.

Navigator may be used as either a navigation management system or simply as a navigation display. The operating mode of the GPS receiver constrains how Navigator may be used. If a direct-to-waypoint or a flight plan is selected in the GPS receiver, Navigator disables its waypoint and flight plan selection features and uses the waypoints sent by the GPS receiver. In this mode, Navigator functions as a navigation display, showing only the navigation data sent by the GPS receiver. This mode is referred to as "external navigation."

If no flight plan or other navigational mode is engaged on the GPS receiver, it will provide continuous position data to Avidyne Navigator. In this case, Navigator enables its navigational features. Navigation to waypoints and via flight plans may be selected. Navigation data such as range, bearing and cross-track error will be calculated internally by Navigator and displayed as before. In this mode, Avidyne Navigator works as a complete navigation management system. This mode is referred to as "internal navigation."

SECTION 7 - DESCRIPTION AND OPERATION (CONTINUED)

AVIDYNE LIGHTNING (FlightMax 750 FSD only)

Avidyne Lightning displays weather avoidance data gathered by an airborne thunderstorm sensor, the BF Goodrich Avionics Systems Stormscope®WX-500 Weather Mapping System. Proper use of Avidyne Lightning and the WX-500 can improve the pilot's ability to maintain a safe distance from thunderstorms. Before operating Avidyne Lightning, the Stormscope WX-500 Users Guide should be read and understood. It contains information essential to the proper use and interpretation of the displays presented by Avidyne Lightning.

Airborne thunderstorm sensors detect the electrical discharge associated with lightning. By means of their specialized antennas and electronics and sophisticated processing software, they are able to determine the approximate range and relative bearing of each lightning strike. This information is then sent to the FSD for display.

NOTE

Stormscope WX-500 strike/cell bearings may not be accurately depicted during and after turns in large crosswind correction conditions. This inaccuracy in the strike/cell bearings is due to GPS ground track being used as the stormscope heading reference instead of actual aircraft heading.

Strike rates may be different between Avidyne and other Stormscope information displays due to differences in software calculation methods.

Avidyne Lightning gives access to all of the functions of the thunderstorm sensor. It provides display functions that will show the reported locations of thunderstorms with respect to the aircraft. If a GPS navigator is reporting aircraft position to the FSD or a remote compass is reporting aircraft heading to the thunderstorm sensor, Lightning will adjust the displayed position of recorded lightning strikes.

Since lightning and thunderstorms are always associated with hazardous weather conditions, including extreme turbulence, heavy precipitation and damaging hail, avoidance of areas where lightning is present will increase the likelihood of avoiding these hazards.

SECTION 7 - DESCRIPTION AND OPERATION (CONTINUED)**AVIDYNE CHARTS (FlightMax 750 FSD only)**

Avidyne Charts is a moving map display. Interfacing with an onboard, external GPS, Avidyne Charts shows aircraft position on the 3 by 4 inch display. Avidyne Charts gives access to digitized versions of VFR and IFR ENROUTE charts. Depending on what digital charts the user has loaded, the digitized VFR charts consist of the Sectional, WAC, and TAC charts. The three layers of charts smoothly transition from one scale to another as the display is zoomed in and out. The IFR charts are digitized versions of NOAA IFR LOW AND HIGH ALTITUDE ENROUTE charts.

Avidyne Charts does not have the functionality of a navigation system. It supplements the selected mode of navigation to improve situational awareness. The position displayed on Avidyne Charts should be correlated with the navigation information from conventional radio navigation instruments, GPS or pilotage.

AVIDYNE RADAR (FlightMax 700/750 FSD)

Avidyne Radar is an interface, control and display system for airborne weather radar systems. It duplicates the weather display functions of the original equipment indicator supplied with the Bendix/King RDR 2000 Vertical Profile Weather Radar System.

Consult the User's Manual for more information on Avidyne Radar.

AVIDYNE TRAFFIC (FlightMax 750 FSD only)

Avidyne Traffic displays traffic awareness data gathered by an airborne traffic sensor. Before operating Avidyne Traffic, consult the User's Guide of the specific traffic or TCAS sensor which is used. It contains information essential to the proper use and interpretation of the displays presented by Avidyne Traffic.

SECTION 7 - DESCRIPTION AND OPERATION (CONTINUED)

DATABASE UPDATES

Avidyne Navigator is intended for use as an enhanced human interface to a variety of certified GPS receivers. As with certified receivers, the database of Avidyne Navigator is a critical component and must be kept current.

It is the pilot's responsibility to insure that current navigation and chart data is loaded in the system. Avidyne Navigator and Avidyne Charts will continuously display an **Expired** warning whenever operations are conducted with an expired navigation database or digital chart. The Expired warning will also be displayed upon Navigator startup. The warning can only be removed by updating the data. Subscription and data loading instructions are given in the User's Manual.

SYSTEM CONFIGURATION

The Avidyne Flight Situation Display (FSD) system consists of the following items:

- A. A Flight Situation Display (FSD) (FlightMax 700/750 FSD)
- B. Optional CD / Data Loader Unit (FlightMax 750 FSD only)
- C. 5RR-MFC Series User's Manual (FlightMax 700/750 FSD)

**PILOT'S OPERATING HANDBOOK
AND
FAA APPROVED AIRPLANE FLIGHT MANUAL**

**SUPPLEMENT NO. 20
FOR
B.F. GOODRICH
SKYWATCH TRAFFIC ADVISORY SYSTEM
MODEL SKY497**

This supplement must be attached to the Pilot's Operating Handbook and FAA Approved Airplane Flight Manual when the optional BF Goodrich Skywatch Traffic Advisory System, Model SKY497 is installed per the Equipment List. The information contained herein supplements or supersedes the Pilot's Operating Handbook and FAA Approved Airplane Flight Manual only in those areas listed herein. For limitations, procedures and performance information not contained in this supplement, consult the Pilot's Operating Handbook and FAA Approved Airplane Flight Manual.

FAA APPROVED:



PETER E. PECK
D.O.A. NO. SO- I
THE NEW PIPER AIRCRAFT, INC.
VERO BEACH, FLORIDA

DATE OF APPROVAL: September 10, 2001

SECTION 1 - GENERAL

The SKYWATCH system is an on-board traffic advisory system which monitors a radius of nominally 6 nautical miles about the aircraft by interrogating any "intruding" aircraft transponder, and determines if a potential conflict exists with other aircraft. This is done by computing the range, altitude, bearing, and closure rate of other transponder equipped aircraft, with respect to the SKYWATCH equipped aircraft.

SKYWATCH requires the following additional equipment to be functional and operating:

Encoding Altimeter

Aircraft Compass (Directional Gyro)

Aircraft Suppression Bus

Squat Switch (both fixed and retractable gear aircraft)

The SKYWATCH system provides a single level of threat advisory known as a Traffic Advisory (TA). The TA display indicates the relative position of an intruder when it is approximately 30 seconds from Closest Point of Approach (CPA). In addition, all aircraft detected less than 0.55 nm and +/- 800 feet from own aircraft will cause a TA to be generated. In airport approach/departure areas, these criteria are reduced to approximately 15 to 20 seconds from CPA.

The TA calls attention to a possible collision threat using the voice message "TRAFFIC, TRAFFIC". The TA is intended to assist the pilot in achieving visual acquisition of the threat aircraft.

SKYWATCH is considered a backup system to the "SEE AND AVOID" concept and the ATC radar environment.

Skywatch data may be projected on the Garmin 530, the Garmin 430 and the Avidyne FlightMax 740. See the POH supplements for operating instructions for those items of equipment. The Avidyne FlightMax 740 controls operation of the unit in Standby or Operate on the ground.

SECTION 2 - LIMITATIONS

Information shown on the display is provided to the pilot as an aid to visually acquiring traffic. Pilot's should maneuver their aircraft based only on ATC guidance or positive visual acquisition of the conflicting traffic. Maneuver should be consistent with ATC instructions. No maneuvers should be made based only on a Traffic Advisory. ATC should be contacted for resolution of the Traffic conflict.

If the pilot is advised by ATC to disable transponder altitude reporting, SKYWATCH must be turned OFF.

Operation of the SKYWATCH system requires that the SKYWATCH Pilot's Guide (p/n 009-10801-001, latest revision) be kept on the aircraft and available to the pilot at all times.

SKYWATCH can only detect aircraft which are transponder equipped.

SECTION 3 - EMERGENCY PROCEDURES

No change.

SECTION 4 - NORMAL PROCEDURES**SELF TEST**

The SKYWATCH system should be tested prior to flight.

After completion of self test, the "TRAFFIC ADVISORY SYSTEM TEST PASSED" audio annunciation will be heard and the display will revert to the standby screen.

SECTION 4 - NORMAL PROCEDURES (continued)**SELF TEST (continued)**

If "TRAFFIC ADVISORY SYSTEM TEST FAILED" is heard or the SKY497 FAILED screen appears, the SKYWATCH system should be turned OFF.

NOTE

The SELF TEST is inhibited when the aircraft is airborne.

STANDBY CHARACTERISTICS

The SKYWATCH system will display SKY497 STANDBY when the aircraft is on the ground and not tracking or processing traffic information. Standby gives the system the ability to track targets while on the ground. Pressing the OPR button activates the system and changes the display from the Standby screen to the Above (ABV) mode and 6 nm range. The ranges available are 6 nm and 2 nm and are selected by pressing the Display Range Button.

To go back into Standby, press the STB button. The system will go to the SKY497 STANDBY screen and will not track targets again until the system is either manually switched out of Standby, while on the ground or automatically switched out of Standby 8 seconds after the aircraft has become airborne.

The SELF TEST works by pressing the test button while in the SKY 497 SKYWATCH screen.

The SKYWATCH system, while in flight or operating on the ground, will display 3 altitude display modes. These are: Above (ABV), Normal (NRM), and Below (BLW). These modes are activated by pressing the Altitude display mode button.

SECTION 4 - NORMAL PROCEDURES (continued)**ABNORMAL PROCEDURES**

If "TRAFFIC ADVISORY SYSTEM TEST FAILED" is heard or the SKY497 FAILED screen appears, the SKYWATCH system should be turned OFF.

If the barometric altimeter fails in flight and is the altitude source for the transponder, turn SKYWATCH OFF.

RESPOND TO TRAFFIC ADVISORIES

When the SKY497 issues a TA, scan outside for the intruder aircraft. Call ATC for guidance and if you visually acquire the traffic, use normal right of way procedures to maintain separation.

Do not attempt maneuvers based solely on traffic information shown on the SKY497 display. Information on the display is provided to the flight crew as an aid in visually acquiring traffic; it is not a replacement for ATC and SEE and AVOID techniques.

SECTION 5 - PERFORMANCE

No change.

SECTION 6 - WEIGHT AND BALANCE

Factory installed optional equipment is included in the licensed weight and balance data in the Equipment List attached to the Pilot's Operating Handbook.

SECTION 7 - DESCRIPTION AND OPERATION

See the BF Goodrich SKYWATCH Traffic Advisory System Model SKY 497 Pilot's Guide for a complete description of this system.

**PILOT'S OPERATING HANDBOOK
AND
FAA APPROVED AIRPLANE FLIGHT MANUAL**

**SUPPLEMENT NO. 21
FOR
BF GOODRICH AEROSPACE
WX-500 STORMSCOPE - SERIES II WEATHER MAPPING SENSOR**

This supplement must be attached to the Pilot's Operating Handbook and FAA Approved Airplane Flight Manual when the BF Goodrich Aerospace WX-500 Stormscope is installed. The information contained herein supplements or supersedes the Pilot's Operating Handbook and FAA Approved Airplane Flight Manual only in those areas listed herein. For limitations, procedures and performance information not contained in this supplement, consult the Pilot's Operating Handbook and FAA Approved Airplane Flight Manual.

FAA APPROVED:



PETER E. PECK
D.O.A. NO. SO- I
THE NEW PIPER AIRCRAFT, INC.
VERO BEACH, FLORIDA

DATE OF APPROVAL: September 10, 2001

SECTION 1 - GENERAL

This supplement provides information necessary for the operation of the aircraft with the BF Goodrich WX-500 Stormscope.

WARNING

Never use your Stormscope system to attempt to penetrate a thunderstorm. The FAA Advisory Circular, Subject: Thunderstorms, and the Airman's Information Manual (AIM) recommend that a pilot "avoid by at least 20 miles any thunderstorm identified as severe or giving an intense radar echo."

CAUTION

There are several atmospheric phenomena other than nearby thunderstorms that can cause isolated discharge points in the strike display mode. Clusters of two or more discharge points in the strike display mode, however, do indicate thunderstorm activity when they reappear after clearing the screen. Avoid the clusters and you'll avoid the thunderstorms. In the cell display mode, even a single discharge point may represent thunderstorm activity and should be avoided.

SECTION 2 - LIMITATIONS

The BF Goodrich Aerospace WX-500 Stormscope Users Guide, p/n 009-11501-001, Rev. A, dated September 10, 1997, or later appropriate revision, must be immediately available to the flight crew whenever weather avoidance is predicated on the use of this system.

SECTION 3 - EMERGENCY PROCEDURES

No change.

SECTION 4 - NORMAL PROCEDURES

Normal operating procedures are described in the BF Goodrich Aerospace WX-500 Stormscope Users Guide, p/n 009-11501-001, Rev. A, dated September 10, 1997, or later appropriate revision.

SECTION 5 - PERFORMANCE

No change.

SECTION 6 - WEIGHT AND BALANCE

Factory installed optional equipment is included in the licensed empty weight and balance data in Section 6 of the Pilot's Operating Handbook.

SECTION 7 - DESCRIPTION AND OPERATION**A. OPERATING PROCEDURES**

See the BF Goodrich Aerospace WX-500 Stormscope Users Guide for a complete description of the WX-500 system.

B. PILOT'S DISPLAY (Airplane Dependent)

The BF Goodrich Aerospace WX-500 Stormscope's data will appear on either the Avidyne FlightMax 740, the Garmin GNS 530, or the Garmin GNS 430.

**PILOT'S OPERATING HANDBOOK
AND
FAA APPROVED AIRPLANE FLIGHT MANUAL**

**SUPPLEMENT NO. 22
FOR
MEGGITT ELECTRONIC FLIGHT DISPLAY SYSTEM (EFIS)
INSTALLED ON A PIPER PA-46-350P
(PILOT SIDE ONLY)**

The FAA approved operational supplement for the Meggitt Electronic Flight Display System (Pilot Side Only), installed in accordance with STC SA09557AC, is required for operation of this system. Meggitt/S-TEC will be responsible to supply and revise the operational supplement. It is permitted to include the Meggitt supplement in this location of the Pilot's Operating Handbook unless otherwise stated by Meggitt/S-TEC. The information contained in the Meggitt supplement may supersede or supplement the information in the basic Pilot's Operating Handbook and FAA Approved Airplane Flight Manual with respect to the operation of the Meggitt Electronic Flight Display System (Pilot Side Only). For limitations, procedures and performance information not contained in the Meggitt supplement, consult the basic Pilot's Operating Handbook and FAA Approved Airplane Flight Manual.

**PILOT'S OPERATING HANDBOOK
AND
FAA APPROVED AIRPLANE FLIGHT MANUAL**

**SUPPLEMENT NO. 23
FOR
BENDIX/KING KMH 880
MULTI-HAZARD AWARENESS SYSTEM**

The FAA approved operational supplement for the Bendix/King KMH 880 Multi-Hazard Awareness System, installed in accordance with STC SA01006WI-D, is required for operation of this system. Bendix/King will be responsible to supply and revise the operational supplement. It is permitted to include the Bendix/King supplement in this location of the Pilot's Operating Handbook unless otherwise stated by Bendix/King. The information contained in the Bendix/King supplement may supersede or supplement the information in the basic Pilot's Operating Handbook and FAA Approved Airplane Flight Manual with respect to the operation of the Bendix/King KMH 880 Multi-Hazard Awareness System. For limitations, procedures and performance information not contained in the Bendix/King supplement, consult the basic Pilot's Operating Handbook and FAA Approved Airplane Flight Manual.

**PILOT'S OPERATING HANDBOOK
AND
FAA APPROVED AIRPLANE FLIGHT MANUAL**

**SUPPLEMENT NO. 24
FOR
GARMIN GTX 330 TRANSPONDER**

This supplement must be attached to the Pilot's Operating Handbook and FAA Approved Airplane Flight Manual when the Garmin GTX 330 Transponder is installed per the Equipment List. The information contained herein supplements or supersedes the Pilot's Operating Handbook and FAA Approved Airplane Flight Manual only in those areas listed herein. For limitations, procedures and performance information not contained in this supplement, consult the Pilot's Operating Handbook and FAA Approved Airplane Flight Manual.

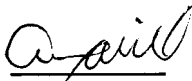
FOR REFERENCE ONLY!
NOT FOR FLIGHT
FAA APPROVED:

ALBERT J. MILL
D.O.A. NO. SO - 1
THE NEW PIPER AIRCRAFT, INC.
VERO BEACH, FLORIDA

DATE OF APPROVAL: January 20, 2004

SECTION 1 - GENERAL

This supplement supplies information necessary for the operation of the airplane when the Garmin GTX 330 Transponder is installed in accordance with FAA approved Piper data.

SECTION 2 - LIMITATIONS

- A. Display of TIS traffic information is advisory only and does not relieve the pilot responsibility to “see and avoid” other aircraft. Aircraft maneuvers shall not be predicated on the TIS displayed information.
- B. Display of TIS traffic information does not constitute a TCAS I or TCAS II collision avoidance system as required by 14 CFR Part 121 or Part 135.
- C. Title 14 of the Code of Federal Regulations (14 CFR) states that “When an Air Traffic Control (ATC) clearance has been obtained, no pilot-in-command (PIC) may deviate from that clearance, except in an emergency, unless he obtains an amended clearance.” Traffic information provided by the TIS up-link does not relieve the PIC of this responsibility.
- D. The 400/500 Series Garmin Display Interfaces (Pilot’s Guide Addendum) P/N 190-00140-13 Rev. A or later revision must be accessible to the flight crew during flight.
- E. 400/500 Series Main Software 4.00 or later FAA approved software is required to operate the TIS interface and provide TIS functionality.

SECTION 3 - EMERGENCY PROCEDURES

To transmit an emergency signal:

- Mode Selection Key - ALT
- Code Selection - SELECT 7700

To transmit a signal representing loss of all communications:

- Mode Selection Key - ALT
- Code Selection - SELECT 7600

SECTION 4 - NORMAL PROCEDURES

BEFORE TAKEOFF:

To transmit Mode C (Altitude Reporting) code in flight:

- Mode Selection Key - ALT
- Code Selector Keys - SELECT assigned code.

To transmit Mode A (Aircraft Identification) code in flight:

- Mode Selector Key - ON
- Code Selector Keys - SELECT assigned code.

NOTE

During normal operation with the ON mode selected, the reply indicator 'R' flashes, indicating transponder replies to interrogations.

NOTE

Mode A reply codes are transmitted in ALT also; however, Mode C codes only are suppressed when the Function Selector ON key is selected.

1. DETAILED TRANSPONDER OPERATING PROCEDURES

Normal transponder operating procedures are described in the GARMIN GTX 330 Pilot's Guide, P/N 190-00207-00, Rev. A, or later appropriate revision.

2. DISPLAY OF TRAFFIC INFORMATION SERVICE (TIS) DATA

TIS surveillance data uplinked by Air Traffic Control (ATC) radar through the GTX 330 Mode S Transponder will appear on the interfaced display device (Garmin 400 or 500 series products). For detailed operating instructions and information regarding the TIS interface, refer to the 400/500 Series Garmin Display Interfaces (Pilot's Guide Addendum) P/N 190-00140-13 Rev. A or later appropriate revision.

SECTION 5 - PERFORMANCE

No change.

SECTION 6 - WEIGHT AND BALANCE

Factory installed optional equipment is included in the licensed weight and balance data in section 6 of the Airplane Flight Manual.

SECTION 7 - DESCRIPTION AND OPERATION

See the 400/500 Series Garmin Display Interfaces (Pilot's Guide Addendum), P/N 190-00140-13, and GTX 330 Pilot's Guide, P/N 190-00207-00, for a complete description of the GTX 330 system.

FOR REFERENCE ONLY
NOT FOR FLIGHT

TABLE OF CONTENTS
SECTION 10
OPERATING TIPS

Paragraph No.		Page No.
10.1	General	10-1
10.3	Operating Tips	10-1

FOR REFERENCE ONLY
NOT FOR FLIGHT

SECTION 10
OPERATING TIPS

10.1 GENERAL

This section provides operating tips of particular value in the operation of the Malibu.

10.3 OPERATING TIPS

- (a) Learn to trim for takeoff so that only a very light back pressure on the control wheel is required to lift the airplane off the ground
- (b) The best speed for takeoff is 80 to 85 KIAS under normal conditions. Trying to pull the airplane off the ground at too low an airspeed decreases the controllability of the airplane in the event of engine failure.
- (c) 10° of flaps may be lowered at airspeeds up to 165 KIAS and full flaps up to 116 KIAS, but to reduce flap operating loads, it is desirable to have the airplane at a slower speed before extending the flaps.
- (d) Before attempting to reset any circuit breaker, allow a two to five minute cooling off period.
- (e) Before starting the engine, check that all radio switches, light switches and the pitot heat switch are in the off position so as not to create an overloaded condition when the starter is engaged.
- (f) Anti-collision lights should not be operating when flying through cloud, fog or haze, since reflected light can produce spatial disorientation. Strobe lights should not be used in close proximity to the ground, such as during taxiing, takeoff or landing.

10.3 OPERATING TIPS (continued)

- (g) In an effort to avoid accidents, pilots should obtain and study the safety related information made available in FAA publications, such as regulations, advisory circulars, Aviation News, AIM and safety aids.
- (h) Prolonged slips or skids which result in excess of 2000 feet of altitude loss or other radical or extreme maneuvers which could cause uncovering of the fuel outlet must be avoided as fuel flow interruption may occur when the tank being used is not full.
- (i) Pilots who fly above 10,000 feet should be aware of the need for special physiological training. Appropriate training is available for a small fee at approximately twenty-three Air Force Bases throughout the United States. The training is free at the NASA Center in Houston and at the FAA Aeronautical Center in Oklahoma.

Forms to be completed (Physiological Training Application and Agreement) for application for the training course may be obtained by writing to the following address:

Chief of Physiological Training, AAC-143
FAA Aeronautical Center
P.O. Box 25082
Oklahoma City, Oklahoma 73125

It is recommended that all pilots who plan to fly above 10,000 feet take this training before flying this high and then take refresher training every two or three years.