

**ROYAL  
ENFIELD  
OWNER'S  
MANUAL**

---

---

**HIMALAYAN**

**USA / CALIFORNIA**



---

---

## **FOREWORD**

Thank you for choosing the Royal Enfield Himalayan.

Your new motorcycle is the product born from Royal Enfield's vast experience of riding in the Himalayas since decades, from exhaustive testing in all conditions, and our continuous striving for superior reliability and performance.

Please read this Owner's Manual carefully before riding so that you will be thoroughly familiar with the proper operation of the Himalayan's controls, its features and capabilities.

To ensure a long and trouble-free life for your motorcycle, give it the proper care and maintenance described in this manual. This Owner's Manual should be considered a permanent part of your motorcycle and should remain with it even if your motorcycle is subsequently sold.

The Himalayan features the Tripper™ - a Turn-by-turn navigation pod, powered by Google Maps and the Royal Enfield App. You can use it to connect your smartphone with the motorcycle through Bluetooth. To use the Tripper™ and to explore the many rides around you, install the Royal Enfield App and follow the steps to register your Himalayan

**— Team Royal Enfield**

---

---

---

## NOTICE

---

All information in this manual is based on the latest product information available at the time of publication. Due to continuous improvements, there may be discrepancies between the information in this manual and your motorcycle. Royal Enfield reserves the right to make production changes at any time without prior notice and without incurring any obligation to make the same or similar changes to motorcycles previously built or sold.

All images shown are for reference to explain and need not to be exactly the same on the model you own. Technical specifications are subject to change without prior notice.

"© Copyright 2021 Royal Enfield (A unit of Eicher Motors Ltd.). All Rights Reserved. No part of this manual shall be copied, distributed or otherwise dealt without the express permission in writing of Royal Enfield".

### Disclaimer

1. Wash the motorcycle only with plain water. Do not use any cleaning agents or detergents, especially on painted surfaces, as it will cause discoloration and damage to the paint.
2. Do not polish your motorcycle as it will increase the gloss level and damage the paint.
3. Scratches or marks on painted / plastic surfaces cannot be removed OR touched up.
4. Warranty is not applicable for discoloration of the Silencer & Exhaust pipe, as it is a natural process that will happen during usage.

Toll Free No : 1-866-600-1122

Email ID : U.Scustomerservice@royalenfield.com

Part No. RAM00372/A / Qty 1000 / June 2021 / 500158

---

## **IMPORTANT**

---

**United States Environment Protection laws, Federal Motor Vehicle Safety Standards and California Air Resources Board (Applicable only for motorcycles sold within the state of California.) strictly prohibits tampering with the Exhaust Emission Control, Noise Control and Evaporative Emission Control systems:**

We would like to emphasize that any repairs to the induction, emission, exhaust and evaporative systems must be performed only by a Royal Enfield Authorised Dealer so that the motorcycle confirms to the United States Environment Protection laws, Federal Motor Vehicle Safety Standards and California Air Resources Board regulation (Applicable only for motorcycles sold within the state of California.)

It is the responsibility of the Owner / User of the motorcycle to read this manual carefully and to comply with the safety guidelines, operating instructions, and periodical maintenance instructions given here. Keep this manual in a convenient place for easy reference. DO NOT use the motorcycle until you have become familiar with this motorcycle and after reading and understanding this manual completely. In case you need any further clarifications, please contact a Royal Enfield Authorised Dealer, nearest to you, for assistance.

If your motorcycle is being used by a friend, relative, or any other person, it is your responsibility to make certain that they have completely understood the operating procedures of the motorcycle, and the contents in this manual with particular reference to the safety aspects, before riding your motorcycle.

The motorcycle is designed for NORMAL ON ROAD USE ONLY. Operation in off-road usage in some areas may be illegal and could be dangerous. Please obey local laws and regulations.

In the event of your motorcycle being sold to another person, it is your responsibility to handover this manual along with the motorcycle to the new owner.

---

## **REPORTING SAFETY DEFECTS**

---

If you believe your motorcycle has a defect which could cause a crash and result in serious injury or loss of life, you should immediately contact the National Highway Traffic Safety Administration (NHTSA) in addition to notifying Royal Enfield North America Limited, 226 N Water St., Milwaukee WI 53202 US.

If NHTSA receives similar complaints, it may open an investigation and if it finds that a safety defect exists in a group of vehicles, it may order a recall and remedy campaign. However, NHTSA cannot become involved in any individual problems between you, and your dealer or Royal Enfield North America Limited.

To contact NHTSA you may call the Auto Safety Hotline toll-free within the United States on 1-800-424-9393 or write to: NHTSA, 400 Seventh Street SW, Washington, DC 20590. You can also obtain other information about motor vehicle safety from the hotline.

---

# CONTENTS

---

Personal and Motorcycle Information .....	07	Periodical Maintenance Chart .....	82
Safe Operating Rules .....	08	Tools kits .....	89
Accessories and Cargo .....	20	Minor Maintenance Tips .....	90
Technical Specifications.....	22	Long Trip Precautions .....	112
Recommended Lubricants .....	28	Shock Absorber .....	113
Motorcycle Identification Numbers .....	29	Off Roothing .....	114
Engine Number Details .....	31	Washing Procedure .....	115
Location of Key Parts .....	32	Storage Precautions .....	120
Operation of Controls .....	35	Wiring Diagram .....	121
Pre-Operational Checks .....	63	Trouble Shooting .....	122
Safe & Happy Riding .....	64	Warranty Terms & Conditions .....	126
Cargo & Accessories.....	68	Emission Control System Warranty .....	130
Rules of the Road .....	70	Noise Control System Warranty .....	132
Running in Period .....	73	Evaporative Emission Control System Warranty .....	134
Warning Indications & Safety Systems .....	74	Environment Care .....	136
Starting.....	78	Radio Type Approval .....	138
Gear Shifting, Ridings Stopping .....	80	Service Maintenance Record .....	140
Parking .....	81	Notes .....	141

---

## **SAFETY DEFINITIONS**

---

Statements in this manual preceded by the following words are of special significance :

---

### **WARNING**

---

Indicates a potentially hazardous situation, which if not avoided, could result in an accident causing serious injury or loss of life.

---

### **CAUTION**

---

Caution with the safety alert symbol, indicates a potentially hazardous situation, which if not avoided, may result in minor or moderate injury leading to disability.

---

### **CAUTION**

---

Caution without the safety alert symbol indicates a potentially hazardous situation, which if not avoided, may result in damage to the motorcycle and its rider, property etc.

All images in this manual are only for reference and to explain the relevance. They may not be exactly the same in the motorcycle you own. Technical specifications are subject to change without prior notice.



---

## PERSONAL & MOTORCYCLE INFORMATION

---

Name																					
Door No./Street																					
Locality																					
City											Country										
Contact	Res :										Off :										
	Mobile :										Email :										
Licence No.											Valid till :										
Model											Color :										
Engine No.																					
VIN. No.																					
Tire Make	Front :										Rear :										
Tire Nos.	Front :										Rear :										
Battery Make											Battery No.										
Sold by																					
Date of Sale																					

---

## SAFE OPERATING RULES

---

Royal Enfield motorcycle are designed to serve as a means of personal transport, and for on-road use only. It is not meant to be used as an off-road motorcycle.

---

### **WARNING**

---

Using the motorcycle for Off-road purpose could lead to loss of control which could result in an accident causing serious injury or loss of life.

- Before operating your new motorcycle, it is your responsibility to carefully read and follow the operation and maintenance instructions detailed in this manual for your own safety, your motorcycle and that of others.
- Know and respect the rules of the road. Be a safe rider for your own safety and for other road users.

- Before starting the motorcycle, check for proper operation of brakes, clutch, gear shifter, handle bar controls, tire pressure, fuel and oil levels.

### **FUEL/REFUELING**

Royal Enfield motorcycles are designed to perform best with unleaded gasoline only. Use a good quality unleaded gasoline of 87 RON or higher/ If 'knocking' or 'pinging' occurs at a steady engine speed under normal load, use a different brand of gasoline or gasoline which has a higher octane rating.

---

### **WARNING**

---

Royal Enfield cautions you against the use of certain nonstandard parts such as aftermarket and custom made extended front forks or suspensions, which may adversely affect performance and handling. Removing or altering

---

## SAFE OPERATING RULES

---

original parts may adversely affect performance and could result in an accident causing serious injury.

- Use only genuine Royal Enfield spare parts and approved accessories. Use of other manufacturer's performance parts may affect the performance of your motorcycle and render the motorcycle void of warranty. See "your Royal Enfield Authorised Dealer for details.

---

### WARNING

---

Do not use leaded gasoline in this motorcycle. It will cause serious damage to the internals of the engine, exhaust emission system and the motorcycle will not meet the emission norms. Using leaded gasoline will also render the warranty void.

It is illegal to use leaded gasoline as it is known to cause serious health problems.

Fuels containing methanol should not be used as it can cause damage to the fuel system components.

- Whenever refueling your motorcycle, please exercise utmost caution and carefully observe the following rules:
  - ★ Turn the ignition switch to the 'OFF' position.
  - ★ Open the fuel filler cap slowly. This will help to release any pressure that may have built up in the fuel tank.
  - ★ DO NOT smoke and please ensure that there are no open flames or sparks near the motorcycle, when refuelling OR servicing the fuel system.
  - ★ Switch OFF mobile phones and other hand held electronic devices.

---

## SAFE OPERATING RULES

---

- ★ Open the fuel filler cap slowly.
- ★ Refuel in a well ventilated area with the engine turned off.
- ★ DO NOT use a mobile telephone. Switch OFF mobile telephones and any other electrical and electronic devices including any appliances with a pilot light.
- ★ DO NOT fill the tank to its brim. Please fill fuel only till the bottom of the filler neck insert, so as to leave air space in the fuel tank to allow for fuel expansion.
- ★ Avoid filling the tank in rainy or dusty conditions where airborne material can contaminate the fuel contaminated fuel may cause damage to fuel system components.
- ★ After refueling, please ensure the fuel filler cap is closed firmly and correctly.



---

### WARNING

---

Gasoline is extremely flammable and highly explosive. Use care when handling gasoline. Always stop the engine when refueling or servicing the fuel system. Do not smoke or allow open flames or sparks near gasoline. Do not store motor cycle with gasoline in the tank, within the home or garage where open flames, pilot lights, sparks or electric motors are present. Inadequate safety precautions could cause an explosion or fire which could result in damage or property, serious injury..



---

### WARNING

---

Fuel spilled on the floor or on motorcycle tires will reduce the tire's ability to grip the road. This can result in dangerous riding condition, potentially causing loss of control and could result in an accident if fuel is spilled, thoroughly clean up the spillage immediately, Take care not to spill any fuel on the engine,

---

## SAFE OPERATING RULES

---

exhaust pipes, rubber parts or any other part of the motorcycle.

Do not store motorcycle with gasoline in the tank, within your home or garage where open flames, pilot lights, spark or any appliance with a pilot light, electric motors are present. Inadequate safety precautions could cause an explosion or fire and could result in damage to property, serious injury or loss of life.

### TIRES & SUSPENSION

Please inspect and ensure tires are seated evenly & properly in the rims, maintain the recommended tire pressures it is very important for riding stability. Pay strict attention to loose and / or broken spokes ensure the front and rear wheels are correctly aligned. Check spokes for correct tightness in the rims and free movement of steering system.

Inspect the tires thread condition periodically and replace worn out tires with approved make only. Failure to do so can lead to improper balance, poor stability, poor handling, and abnormal tread wear.

Please replace tires which are punctured or damaged. Small punctures in the tread area may be repaired from within the tire. The motorcycle should not be driven over 40 mph (60 kmph) for the first 24 hours and over 55 MPH (90 Kmph) thereafter with a repaired tire.



### WARNING

---

In emergency situations, please ride slowly with least possible load until the tire is permanently repaired or replaced. Failure to heed to this warning could result in serious injury or loss of life.

---

## SAFE OPERATING RULES

---

Regularly inspect front forks, rear shock absorbers and rear suspensions, for any war, looseness / side play, oil leaks etc. Replace worn parts. Worn parts can adversely affect stability and handling.

---

### **WARNING**

---

DO NOT operate motorcycle with a loose, worn or damaged steering system, including the front and rear suspension system. Contact your Royal Enfield Authorised Dealer for repair of steering or suspensions system. Damaged steering or suspension components may adversely affect handling which could result in serious injury or loss of life.

- A new motorcycle must be operated according to the special break-in-procedure. See break-in-the first 300 miles (500 km) section.

- Operate motorcycle only at moderate speeds and out of traffic until you have become thoroughly familiar with its operation and handling characteristics under all conditions.
- Do not exceed the legal speed limit or drive too fast for existing conditions. Always reduce speed when poor driving conditions exist. High Speed increase the influence of any other condition affecting stability and increases the possibility of loss of control.

---

### **NOTE**

---

If you are an inexperienced rider we recommended that you obtain formal training on correct motorcycle riding techniques and become thoroughly familiar with the operation of your particular motorcycle. New Riders should gain experience under various condition while driving at moderate speeds.

---

## SAFE OPERATING RULES

---

### WARNING

---

Avoid overspeeding and never travel over the speed limit. Excessive speed may cause loss of control and could result in an accident causing serious injury.

- DO NOT exceed 70 MPH (110 km/h) riding solo.
- DO NOT exceed 55 MPH (90 Km/h) when carrying a passenger or cargo.

Pay strict attention to road surfaces and wind conditions. Any two wheeled motorcycle may be subject to the following upsetting forces:

- ★ Wind blasts from passing trucks.
- ★ Rough uneven road surfaces.
- ★ Slippery road surfaces.

These forces may affect the handling characteristics of your motorcycle. If this happens, reduce speed and guide the motorcycle with a relaxed grip to a controlled condition. Do not brake abruptly or force the handlebar.

- Operate your motorcycle defensively. Remember, a motorcycle does not afford the same protection as an automobile in an accident. One of the most common accident situations occurs when the driver of the other motorcycle fails to see or recognize a motorcycle and turns into the oncoming motorcyclist.
- Safe motorcycle operation requires alert mental judgment combined with a defensive driving attitude. DO NOT allow fatigue, alcohol or drugs to endanger your safety OR that of others.

---

## SAFE OPERATING RULES

---

- Wear an approved helmet, clothing, and foot gear suited for riding a motorcycle. Bright OR light colors are best for greater visibility in traffic, especially at night. Avoid loose, flowing garments and scarves.
- When carrying a pillion rider, it is your responsibility to instruct them on proper riding procedures.
- Do NOT allow other individuals, under any circumstances, to operate your motorcycle unless you know they are experienced, licensed riders and are thoroughly familiar with the operating conditions of your motorcycle.
- Additional electrical accessories and equipments may overload the motorcycle's electrical system and will result in system and/or component failure.
- Maintain your motorcycle in proper operating condition in accordance with the Maintenance intervals chart in this Owner's Manual.
- Use only genuine Royal Enfield spare parts and approved accessories. Use of other manufacturer's performance parts may affect the performance of your motorcycle void of warranty. Contact your Royal Enfield Authorised Dealer for further details.



### **WARNING**

Maintain the recommended tire pressure ensure the front and rear wheels are correctly aligned and the tires are seated evenly & properly in the rims. Check for correct tightness of the spokes in the rims. Inspect your tires periodically and replace tires with approved tires only. Failure to do so can lead



---

## SAFE OPERATING RULES

---

to improper balance, abnormal tread wear, poor handling and could result in serious injury.

### **WARNING**

Royal Enfield recommends replacement of any tire punctured or damaged. In some cases small punctures in the tread area may be repaired from within the demounted tire by your royal Enfield Authorised Dealer. Speed should not exceed 60 Km/h (40 MPH) for the first 24 hours after repair and the repaired tire should Never be used over 90 Km/h (55 MPH).

In emergency situations, if a temporary repair is made ride slowly with as light a load as possible until the tire is permanently repaired or replaced.

Failure to heed this warning could result in serious injury.

- Safe motorcycle operation required alert mental judgement combined with a defensive driving attitude. DO NOT allow fatigue, alcohol or drugs to endanger your safety or that of others.
- Maintain your motorcycle in proper operating condition in accordance with the Maintenance intervals chart in this Owner' Manual. Particularly important to motorcycle stability is proper tire inflation pressure, tread condition. Pay strict attention to loose and / or broken spokes, free movement of steering system.

### **WARNING**

DO NOT operate motorcycle with a loose, worn or damaged steering system, including the front and rear suspension system.

---

## SAFE OPERATING RULES

---

Contact your Royal Enfield Authorised Dealer for repair of steering or suspension system. Damaged steering or suspension components may adversely affect handling which could result in serious injury.

---

### **WARNING**

Regularly inspect rear shock absorbers and front forks for any defective suspension can adversely affect stability and handling which could result in serious injury.

---

### **WARNING**

For your personal welfare, all the listed service and maintenance recommendations should be performed. Lack of regular maintenance at the suggested intervals may affect the safe operation of your motorcycle, which could result in serious injury.

---

### **WARNING**

Avoid any contact with the exhaust system. Wear clothing that will completely cover the legs while riding. The exhaust system gets very hot when the engine is running and remains too hot, even after the engine is turned off. Failure to wear proper or protective clothing could result in serious injury.

---

### **WARNING**

Exhaust gases contains poisonous carbon monoxide and chemicals, known to cause Cancer, Birth Defects or other reproductive defects.

DO NOT INHALE exhaust gases. Never stand close to the exhaust system of the motorcycle when the engine is running.

Do not stay inside a closed garage after parking the motorcycle as the residual fumes from the exhaust can contain harmful

---

## SAFE OPERATING RULES

---

gases. Failure to heed to these warnings can result in loss of life.

---

### **WARNING**

---

Motorcycle batteries contain lead and lead components, acids and chemicals known to cause cancer, birth defects or other reproductive harm. Exercise extreme caution while handling a battery. Wash hands thoroughly whenever a battery is handled.

This motorcycle is not designed to tow a trailer or be used with a side car. It is designed to be used as a two wheeler, for carrying a rider and a pillion.

---

### **WARNING**

---

Towing a trailer may cause loss of control of the motorcycle in the front, reduced braking efficiency, tire overloading and

unstable handling, leading to an accident resulting in serious injury or loss of life. Using the motorcycle with a side car could cause loss of control, resulting in an accident which may cause serious injury or loss of life.

---

### **WARNING**

---

Consult your Royal Enfield Authorised Dealer regarding any questions or problems that occur in the operation of your motorcycle. Failure to do so may aggravate an initial problem, cause costly repairs, jeopardize your personal safety and could result in serious injury.

---

### **WARNING**

---

Exceeding GVWR may lead to instability of the motorcycle, leading to an accident and result in serious injury or loss of life.

---

## SAFE OPERATING RULES

---

### **WARNING**

Royal Enfield cautions you against the use of certain nonstandard parts such as aftermarket and custom made extended front forks or suspensions, which may adversely affect performance and handling. Removing or altering original parts may adversely affect performance and could result in an accident causing serious injury or loss of life.

### **WARNING**

Use only genuine Royal Enfield replacement fasteners tightened to the proper torque (See your Royal Enfield Work Shop Manual). We caution you against the use of certain nonstandard parts such as aftermarket and custom made fasteners which may not have specific strength, finish and type requirements to perform properly in the assembly and its

environment. The use of any nonstandard parts, including fasteners, could result in serious injury.

### **WARNING**

DO NOT exceed the Gross Motorcycle Weight Rating of your motorcycle. The Gross motorcycle Weight Rating (GVWR) is shown on the information plate, located on the frame Down tube. (GVWR is the sum of the weight of the motorcycle, accessories, and the maximum weight of the rider, passenger and cargo that may be safely carried.) Exceeding GVWR may lead to instability of the motorcycle, which could cause an accident and result in serious injury.

### **WARNING**

DO NOT Tow a disabled motorcycle. The steering and handling for the disabled motorcycle will be impaired due to the force of

---

## SAFE OPERATING RULES

---

the towline. If a disabled motorcycle must be transported, use a truck or a trailer. Towing a motorcycle may cause loss of control of the motorcycle in the front, leading to an accident resulting in serious injury.

---

 **WARNING**

---

Do not pull a trailer behind a motorcycle. Towing a trailer may cause reduced braking efficiency, tire overloading and unstable handling. Towing a trailer may cause loss of control of the motorcycle in the front, leading to an accident resulting in serious injury.

---

## ACCESSORIES AND CARGO

---

Royal Enfield cannot test and make specific recommendations concerning specific or a combination of accessories sold. Therefore, the rider must be responsible for safe operation of the motorcycle when installing accessories or carrying additional weight.

The following guidelines should be used when equipping a motorcycle, carrying cargo and/or passengers.

---

### **WARNING**

---

DO NOT load weight or install accessories improperly on the motorcycle. Doing so may affect the motorcycle's stability handling characteristics, and safe operating speed which could result in serious accident causing serious injury.

- DO NOT exceed 70 MPH (110 Km/h) riding solo.
- DO NOT exceed 55 MPH (90 Km/h) when carrying a passenger or cargo.
- Keep cargo weight concentrated close to the motorcycle and as low as possible; this minimizes the change in the motorcycle's center of gravity.
  - ★ Distribute weight evenly on both sides of the motorcycle.
  - ★ DO NOT load bulky items too far behind the rider or add weight to the handlebars or front forks.
  - ★ DO NOT exceed 5 pounds (2.3 kgs) maximum load in each saddlebag.
  - ★ Recheck the cargo periodically.

---

## ACCESSORIES AND CARGO

---

- Be sure cargo is secured and will not shift while riding. Accessories secured loosely may affect the riding of the motorcycle and affect the stability of the motorcycle.
- Additional electrical accessories and equipments may overload the motorcycle's electrical system and will result in system and/or component failure.
- Large surfaces such as fairings, windshields, backrests and luggage racks can adversely affect handling of the motorcycle. Only genuine Royal Enfield accessories, designed specifically for the motorcycle model should be used with proper installation.

---

### **WARNING**

---

Royal Enfield motorcycles have been carefully designed and engineered for riding in their original configuration. DO NOT alter the handling characteristics of these motorcycles. Doing

so may affect its stability and could cause an accident resulting in serious injury.

---

### **WARNING**

---

Royal Enfield cautions you against use of nonstandard parts such as aftermarket and custom made extended front forks which may adversely affect the performance and handling of the motorcycle. Removing or altering original parts may adversely affect the performance of the motorcycle, causing an accident, which could result in serious injury.

---

### **WARNING**

---

DO NOT ignore model/design specifications. Doing so constitutes to motorcycle misuse which may adversely affect the handling and performance of the motorcycle causing an accident, which could result in serious injury.

---

## TECHNICAL SPECIFICATIONS

---

### ENGINE

---

Engine Type .....	Single Cylinder, 4 Stroke, SOHC, Air cooled, Fuel Injection
Bore .....	78 mm
Stroke .....	86 mm
Displacement .....	411 cc
Compression ratio .....	9.5:1
Max Power .....	24.3bhp (17.88 KW) @ 6500 rpm
Max Torque .....	32 Nm @ 4250 rpm $\pm$ 250 rpm
Idle rpm .....	1350 $\pm$ 200 rpm
Starting System .....	Electric Start
Air filter element .....	Paper element

Lubrication .....	Forced Lubrication, Wet sump
Engine oil capacity .....	2.3 L (Initial fill only), 1.6 – 1.8 L (Subsequent Refills)
Engine oil grade .....	SAE 15W 50 API SL Grade JASO MA 2 Semi Synthetic
Cooling .....	Air cooled with Oil cooler

---

### IGNITION SYSTEM

---

Ignition system .....	Electronic ECU / Variable
Spark plug .....	Bosch – UR5CC
Spark plug gap .....	0.7 to 0.8 mm



---

# TECHNICAL SPECIFICATIONS

---

## TRANSMISSION

---

Clutch ..... Wet Multi Plates

Primary drive ..... Gear

Primary ratio ..... 2.312:1

Gear box ..... 5 Speed, Constant Mesh

### Gear Ratios

1st Gear ..... 1<sup>st</sup> 2.916:1

2nd Gear ..... 2<sup>nd</sup> 1.833:1

3rd Gear ..... 3<sup>rd</sup> 1.428:1

4th Gear ..... 4<sup>th</sup> 1.173:1

5th Gear ..... 5<sup>th</sup> 1.000:1

Secondary Drive ..... 5/8" Chain & Sprocket

Secondary Ratio ..... 2.533:1

Drive Chain links ..... 110 links

# TECHNICAL SPECIFICATIONS

## CHASSIS

Frame .....	Half duplex split cradle
Suspension Front.....	Telescopic, Hydraulic Damping, Front wheel travel: 200 mm
Rear.....	Swing arm with Linkage type Hydraulic damping Mono shock, Rear wheel travel: 180 mm
Brakes Brake system.	Dual Channel ABS (Switchable to Single channel ABS - Rear Wheel ABS control deactivation)
Front Disc.....	300mm Dia disc.
Rear Disc.....	240mm Dia disc.

Tubed and Steel Rim	Standard Tire	Replacement Tire : Replace with Standard tire or below mentioned Tire
Front	Make, Tire : CEAT Size : 90/90-21 54S	Make, Tire : Pirelli Size : 90/90-21 54H
Rear	Make, Tire : CEAT Size : 120/90-17 64S	Make, Tire : Pirelli Size : 120/90-17 64S

---

## TECHNICAL SPECIFICATIONS

---

### Tire Pressures

Solo	Front.....	25 PSI / 1.75 Kg/cm <sup>2</sup>
	Rear.....	32 PSI / 2.25 Kg/cm <sup>2</sup>

### With Pillion

	Front.....	27 PSI / 1.89 Kg/cm <sup>2</sup>
	Rear.....	34 PSI / 2.39 Kg/cm <sup>2</sup>

Steering lock .....	In built
Fuel Type .....	Unleaded Gasoline
Ethanol Content .....	E10 or less
Minimum Octane rating.....	91 RON (Research Octane Number) or Higher
Fuel tank capacity* .....	15 ± 0.5 litres approx*

Low fuel warning.....	Fuel Gauge (Red zone) 5.5 ± 0.5 litres approx.*
Dead stock (unusable fuel)...	0.5 litre approx..*

\* The above values are approximate and the actual capacity may vary with each fuel tank.

---

### CAUTION

---

- The use of petrol containing more than the specified ethanol may cause the fuel tank corrosion & paint damage and may also damage the rubber tubes in the fuel lines as well.
- It is recommended to use only unleaded petrol, as leaded petrol may cause damage to the catalytic converter.

---

## TECHNICAL SPECIFICATIONS

---

### ELECTRICALS

---

Flywheel magneto.....	221W @ 1500 rpm
Generation .....	Alternator, III Phase
System.....	12V - DC
Battery.....	12V - 8 AH Maintenance free
Head lamp.....	12V, H4-60/55W - BULB
Brake lamp / Tail lamp.....	12V - 4/1W LED
Licence Plate illuminator.....	12V - LED
Front position lamp.....	12V - LED
Speedometer lamp.....	12V - LED
Hi beam indicator .....	12V - LED
Neutral lamp telltale.....	12V - LED
Turn signal telltale.....	12V - LED
Turn signal.....	12V, 10W*4Nos.

Horn.....	12V, 2.5 Amp.
Starter Motor.....	12V, 0.7 kW
Instrument Cluster.....	Digital cluster with main and compass LCD
Side Stand indicator.....	LCD Indication
Malfunction Indicator.....	12V - LED
ABS Indicator.....	12V - LED



### WARNING

---

Using bulbs / electrical gadgets other than specified rating may lead to overloading / erratic behaviour / premature failure of electrical system.

Modifications or fitments which are not approved by Royal Enfield, will seriously affect the performance of the vehicle and will render the warranty void.

---

## TECHNICAL SPECIFICATIONS

---

### DIMENSIONS

---

Length.....	2190 mm
Width.....	840 mm
Height.....	1370 mm
Wheel base.....	1465 mm
Ground clearance.....	220 mm
Saddle Height.....	800 mm

---

### WEIGHTS

---

Kerb weight (90% fuel & oil).....	195 kgs.
Gross Vehicle Weight.....	375 kgs.

- Values / Dimensions mentioned above are for reference only.
- In view of continuous improvements being done on our motorcycles, the specifications are subject to change without prior notice.

---

## RECOMMENDED LUBRICANTS

---

ENGINE OIL	
Grade	SAE 15W 50 API SL Grade JASO MA 2 Semi Synthetic
Capacity	2.3 Ltrs. (First Fill only) 1.6 – 1.8 Ltrs. Approx. (during oil & filter element replacement in periodical maintenance)

FRONT FORK OIL	
Grade	10 W / Fork Oil (Viscosity range 35)
Capacity	455 ml/leg

BRAKE FLUID	
Grade	DOT 4
Capacity	Front / Rear 100 ml

---

### CAUTION

Using Non Recommended / In-Correct oils, can cause serious damage to the moving parts, affect performance of the motor cycle AND void the warranty.

---

### NOTE

Oil level should be up to "MAX" level. Do not overfill as it will affect the clutch functioning. Recommendation subject to change without notice.

---

## MOTORCYCLE IDENTIFICATION NUMBER - DETAILS

---

The VIN is a 17 digit number punched on the right side steering head tube and in the information plate rivetted to the frame down tube.

### Sample VIN:

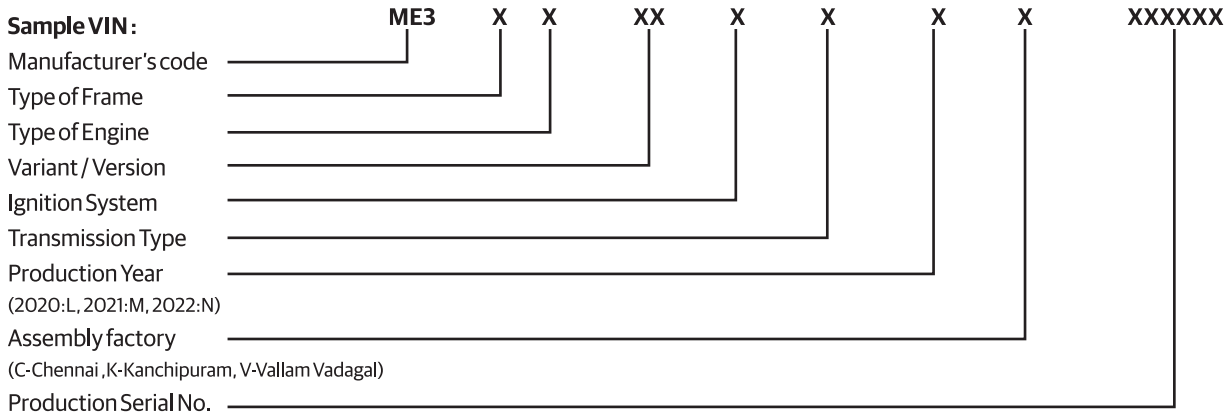

---

## MOTORCYCLE IDENTIFICATION NUMBER - DETAILS

---

### FRAME NUMBER

Punched on steering head tube right side.

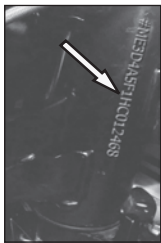

### VIN INFORMATION PLATE

Riveted on the frame down tube right side.



### EMISSION LABEL

Emission label on Shocks mounting tube

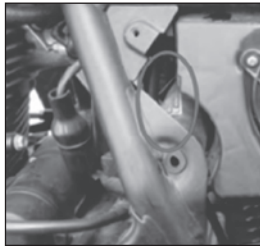

### NOISE LABEL

Noise Label on head tube



---

### CAUTION

It is illegal to tamper with OR alter the VIN / Engine numbers of the motorcycle as it will only against the law BUT will render the vehicle registration AND warranty VOID.



## ENGINE NUMBER - DETAILS

The engine number is punched on the left hand side Crankcase. It is the means of identification of the Engine and its production details. Please do not tamper with the engine number as its is prohibited by law.

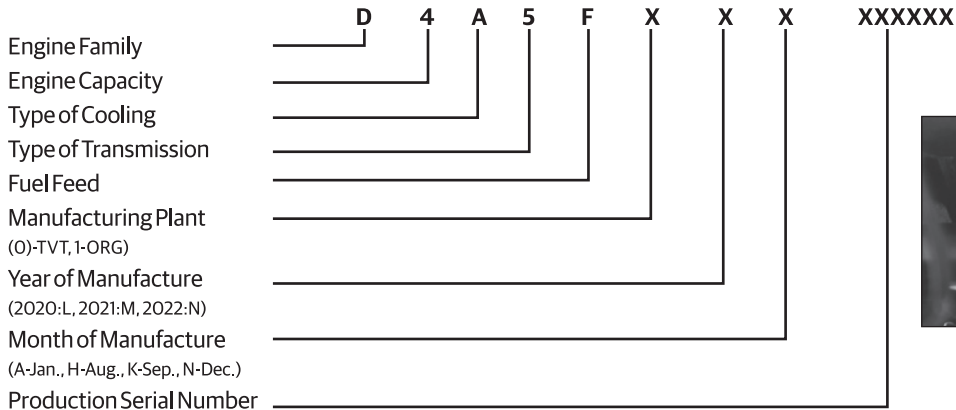

---

## LOCATION OF KEY PARTS

---

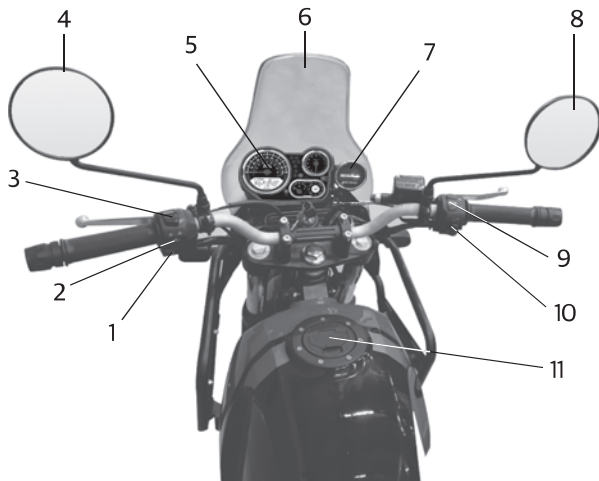

1. Horn Button
2. Turn Signal Switch
3. Head Lamp Dip Switch
4. Rear View Mirror Left Side
5. Instrument Cluster
6. Wind Shield
7. Tripper
8. Rear View Mirror Right Side
9. Engine Stop Switch
10. Electric Starts Switch
11. Fuel Tank Cap

---

## LOCATION OF KEY PARTS

---



1. Front Trafficator Right Side
2. Horn
3. Oil Level Window
4. Rear Brake Pedal
5. Rider Foot rest Right Side
6. ABS Module
7. Pillion Foot rest Right Side
8. Rear Trafficator Right Side

---

## LOCATION OF KEY PARTS

---



1. Front Trafficator Left Side
2. Head Lamp
3. Tail lamp
4. Rear Trafficator Left Side
5. Licence plate illuminator
6. Pillion Foot rest Left Side
7. Side Stand
8. Center Stand
9. Rider Foot rest Left Side
10. Gear Change Lever
11. ABS Module
12. Canister

---

## OPERATION OF CONTROLS

---

### STEERING LOCK

---

Locking:

- Turn handle bar to extreme left or right position
- Switch "OFF" ignition, gently depress key and turn anticlockwise further till steering is locked and remove key.



Unlocking:

- Insert key, turn clockwise to ignition "OFF" position. If required, gently shake handle bar to help unlock steering easily.

### CAUTION

---

Do not force or attempt to lock / unlock steering if the handle bar is not in extreme left or right side. Failure to adhere to this caution will damage the lock and also cause the key to bend or break.



### WARNING

---

After unlocking steering AND before starting engine, check the handle bar free movement by turning to both left and right sides, several times.

Failure to do so may cause unstable riding, leading to a potential accident, resulting in serious injury to both rider and other road users, besides causing severe damage to the motorcycle.

---

## OPERATION OF CONTROLS

---

### FUEL TANK CAP

---

#### OPENING:

- Lift flap and insert key.
- Turn key clockwise to enable cap to unlock and spring up.



#### NOTE

---

Key CANNOT be removed when fuel tank cap is open.

#### CLOSING:

- Gently depress cap till it is firmly locked in place and key can be removed.
- Remove key and close flap.



#### WARNING

---

DO NOT overfill the fuel tank, stop filling when the fuel reaches bottom of anti-splash plate. Because fuel expands when it heats up, heat from engine or the sun can cause fuel spill out of fuel tank.

Petrol is highly explosive. Please ensure there are no open flames or sparks nearby while refueling and fill fuel tank only in a well ventilated area.

## OPERATION OF CONTROLS

Please ensure petrol does not spill on painted surfaces. Wipe immediately in case fuel spills over as otherwise it will leave a permanent stain on the painted surfaces.

### Anti splash plate

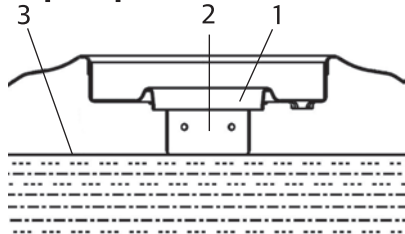

1. Fuel Filler Collar
2. Anti-Splash Plate
3. Maximum Fuel Level

### IGNITION SWITCH

-  OFF
-  ON



### NOTE

- Key can be removed only if ignition is in OFF or steering is locked.

## OPERATION OF CONTROLS

- Key can be removed only if ignition is in OFF or steering is locked.

### **WARNING**

DO NOT switch "OFF" ignition while riding the motorcycle. Doing so can cause a potential accident, resulting in serious injury to both rider and other road users, besides causing severe damage to the motorcycle.

### **ENGINE STOP SWITCH**

 Engine OFF



 Engine ON



### **E-START SWITCH**

-  Depress & hold till engine starts.

### **HAZARD LIGHT SWITCH**

-  Hazard Light ON
-  OFF

### **WARNING**

- Turn signals do not work when the hazard light switch is on.
- All the trafficator lamps will flash simultaneously.





---

## OPERATION OF CONTROLS

---

### CAUTION

Hazard flashing will create a strain on battery. Do not use hazard warning for longer period unless necessary.

Methods to Activate Hazard flasher :

Ignition switch ON, slide the hazard control to ON position. Hazard will work unless manual deactivation (OFF).

Ignition switch ON, slide the hazard control to ON position- Hazard will start working - Ignition switch OFF - Hazard will keep working for a duration of 30 mins - Unless manual deactivation (OFF).

---

### NOTE

Hazard flasher cannot be activated in Ignition switch OFF condition.

---

### HORN

 Press



---

### DIMMER SWITCH

 High beam  Low beam



---

### DAY FLASH

Press For Head Light Flash.



---

## OPERATION OF CONTROLS

---

### TURN SIGNAL SWITCH

- ← Left turn signal ON
- ↑ OFF (Push to Cancel)
- Right turn signal ON



### MANUAL BI STARTER (CHOKE)

Depress and hold to stabilise idling RPM in cold condition / first time starting in cold mornings.

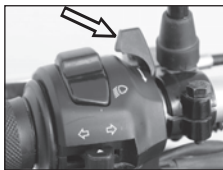

### RIDER & PILLION SEAT

- Locate key on left side & turn clockwise to remove the pillion seat.
- Lift front seat from rear & remove.
- Useful for storing motorcycle documents and owners manual.
- Remove the pillion seat.
- Gently press on top to release the tabs from the frame and open slightly.
- To completely remove, release the bottom tabs from the frame by pulling out gently.
- When washing the motorcycle, be careful not to floor this area with water.



# OPERATION OF CONTROLS

## INSTRUMENT CLUSTER

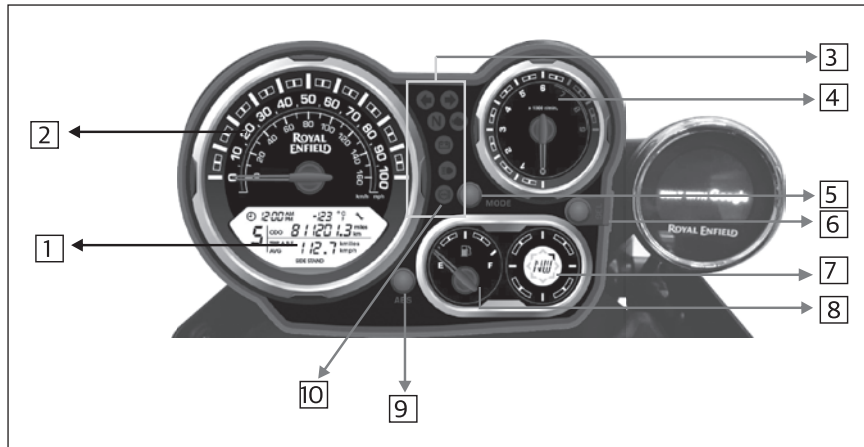

- |     |                           |
|-----|---------------------------|
| 1.  | Main LCD                  |
| 2.  | Speedometer (Miles Major) |
| 3.  | Tells Tales               |
| 4.  | Tachometer                |
| 5.  | Mode Button               |
| 6.  | Select Button             |
| 7.  | Compass display           |
| 8.  | Fuel Gauge                |
| 9.  | ABS Switch                |
| 10. | ABS Indicator Lamp        |

# OPERATION OF CONTROLS

## A. MAIN LCD

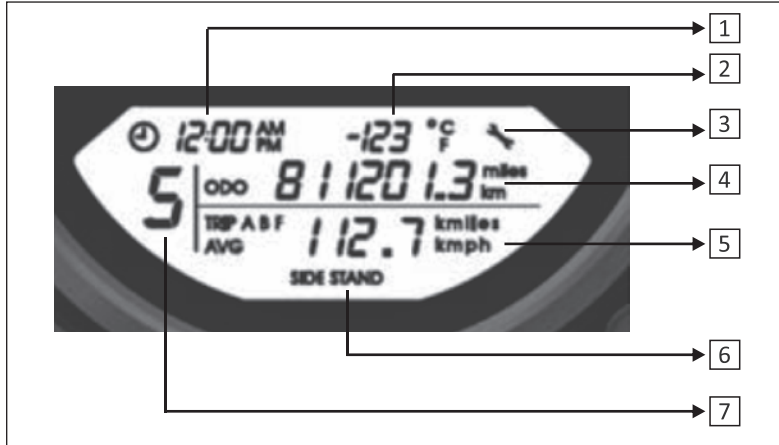

- |    |                                     |
|----|-------------------------------------|
| 1. | Clock                               |
| 2. | Ambient Temperature                 |
| 3. | Service reminder                    |
| 4. | Odometer                            |
| 5. | Trip value (A/B & F), AVG speed A/B |
| 6. | Side Stand indication               |
| 7. | Gear Position indication            |

---

## OPERATION OF CONTROLS

---

### CLOCK

---

- Display in 12 hour format with AM / PM indication
- Will reset to 12:00 am when battery is disconnected.



# OPERATION OF CONTROLS

## CLOCK SETTING

Function	Switch	Pressure time (sec)	Action
CLOCK SETTING MODE	Select & Mode pressed with No speed input	$\geq 3$ sec	In ignition key 'ON' position (when vehicle not running) Enters into clock setting mode and hour digits starts to blink
	Select	$< 1$ sec	Hours value shall increase by 1 accordingly for no of press
	Select	$\geq 3$ sec	Hour value saved and minute digits starts to blink
	Select	$< 1$ sec	Minutes value will increase by 1 by each press of the "Select" button
	Select	$\geq 3$ sec	Minute value save and PM / AM digits starts to blink
	Select	$< 1$ sec	PM / AM is interchangeable by each press of the "Select" button
	Select	$\geq 3$ sec	PM/AM save and exit from clock set mode
	No action	20 sec	Auto exit without saving changes and continue with previous setting



### WARNING

Never Attempt to operate the select or reset buttons while riding the motorcycle. Failure to do so may cause loss of concentration and unstable riding, leading to a potential accident, resulting in serious injury to both rider and other road users, besides causing severe damage to the motorcycle

---

## OPERATION OF CONTROLS

---

### AMBIENT TEMPERATURE INDICATION

---

- Ambient temperature display can be changed from Celsius to Fahrenheit and vice versa.

The temperature indication may increase during vehicle riding / engine "ON" condition due to increase of engine temperature.

Ambient temperature indication tolerance is  $\pm 2^{\circ}\text{C}$ .



---

### NOTE

---

The ambient temperature value should be referred to only when the engine is switched "OFF" and the engine is cold condition. The Temperature displayed will be higher if the engine is running or immediately after it is switched "OFF" since the sensor will only pick up the higher temperature surrounding it.

---

## OPERATION OF CONTROLS

---

### TEMPERATURE UNIT CHANGEOVER

---

Temperature sensor push button management.

Required Button

- Mode



Function	Button	Pressure time (sec)	Action
TEMPERATURE UNIT CHANGE OVER	MODE	$\geq 10$ secs	In ignition key 'ON' position, long press and hold "MODE" button for period $\geq 10$ secs to reset temperature units from degree Celsius to Fahrenheit and vice versa.



---

## OPERATION OF CONTROLS

---

### I. ABS SWITCH - ACTIVATION PROCEDURE

---

1. Ignition switch "ON" condition
2. Vehicle stationary
3. Press ABS switch for (3-5 secs)

Single channel ABS mode is activated (if, enabled) : Rear ABS function will not work, Front wheel ABS will only work.

**Procedure to reset to Dual channel :** Ignition switch reset\*, vehicle will return to default dual channel ABS mode.

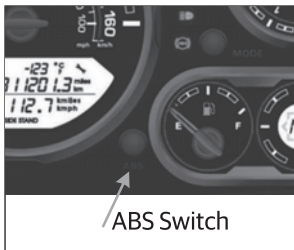

Dual Channel ABS mode (Default) : ABS will work on both wheels.

**\*Ignition key Reset :** Turning ignition switch from "OFF" to "ON".

---

### CAUTION

---

If Single channel ABS mode enabled, ABS only controls the front wheel. The rear wheel is not controlled by ABS and may lock during braking maneuvers.

---

## OPERATION OF CONTROLS

---

### J. ABS INDICATOR LAMP

---

- ABS indicator lamp continuously "ON" during initial check up (until or after vehicle running for a particular distance / speed) and will turn "OFF" if system is ok, then will light up again in case of any ABS system malfunction.



ABS Indicator lamp lights up to indicate status or error messages relating to ABS

- **Single channel mode indication**

Single channel Activation with ignition key reset": ABS tell tale will blink thrice to indicate activation, followed by ABS tell tale continuous ON, once the vehicle is ride more than 5kmph, ABS tell tale will blink continuously.

Single channel Activation  
Without ignition key reset":  
ABS tell tale will blink  
continuously.

**\* Ignition key Reset :**  
Turning ignition switch  
from "OFF" to "ON".

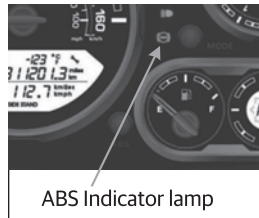

---

### CAUTION

---

- DO NOT run motorcycle in case the ABS Indicator lamp continuously "ON",
- The ABS indicator blink continuously to indicate Single channel ABS mode is enabled.

---

## OPERATION OF CONTROLS

---

### SERVICE REMINDER

---

- Service reminder is provided to remind about service due.
- Spanner symbol will flash till vehicle is serviced at service center.

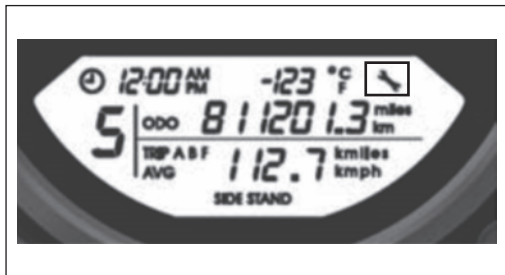

- Service reminder can be reset ONLY by authorised personnel at service center after service is completed.
- Service reminder symbol will flash on as per below distance input from odometer.
  - i) 1st service - 450 kms or 279.6 mile.
  - ii) 2nd service - 4900 kms or 3044.7 mile.
  - iii) from there on for every 5000 kms or 3106.85 mile from previous value (ex: 9900 kms or 6151.5 mile, 14900 kms or 9258.4 mile etc.)



### WARNING

---

DO NOT use high pressure water jet directly on instrument cluster for cleaning. Use only water spray cleaning and wipe it with soft dry cloth.

---

## OPERATION OF CONTROLS

---

### 4. ODOMETER

---

- Displays the cumulative kilometers the vehicle has covered.



### TRIP A/B & AVG SPEED A/B

---

- Trip A/B indicates distance travelled in particular trip.
- Avg A/B indicates average speed of vehicle in particular trip mode.



---

## OPERATION OF CONTROLS

---

Function	Switch	Pressure time (sec)	Action
TRIP A	SELECT	$\leq 1$ sec	In ignition key "ON" position, <b>Move to:</b> AVA A
	SELECT	$\geq 2.5$ sec	TRIP A/AVG A RESET
AVG A	SELECT	$< 1$ sec	<b>Move to :</b> TRIP B
	SELECT	$> 2.5$ sec	TRIP A/AVG A RESET
TRIP B	SELECT	$< 1$ sec	<b>Move to :</b> AVG B
	SELECT	$> 2.5$ sec	TRIP B/AVG B RESET
AVG B	SELECT	$< 1$ sec	<b>Move to :</b> TRIP A
	SELECT	$> 2.5$ sec	TRIP B/AVG B RESET

---

## OPERATION OF CONTROLS

---

### TRIP "F" MODE

---

- The word, Trip "F" will flash when the Trip "F" mode is active.
- Trip "F" is provided to measure distance travelled by the vehicle when fuel level in the vehicle is  $5.5 \pm 0.5$  lts. in the fuel tank so that the rider can plan fuel filling accordingly based on his trip requirements, Trip "F" will get activated



when needle on fuel gauge enters the red zone.

- Trip "F" mode would come into function automatically.
- Trip "F" mode would de-activate automatically if fuel is filled above  $5.5 \pm 0.5$  lts.
- During Trip "F" mode rider can toggle between Trip A/B but mode will return automatically to Trip "F" after  $25 \pm 5$  secs.

---

### NOTE

---

- Trip "F" will stop displaying at approximately  $90 \pm 5$  seconds AFTER fuel level in tank is above  $5.5 \pm 0.5$  litres. side stand is fully retracted. AND Ignition is switched "ON".

## OPERATION OF CONTROLS

### WARNING

- NEVER attempt to operate the select or rest buttons while riding the motorcycle. Doing so may cause loss of concentration and unstable riding, leading to a potential accident, resulting in serious injury to both rider and other road users, besides causing severe damage to the motorcycle.

### 6. SIDE STAND INDICATOR

- Indicates when side stand is extended.



### GEAR POSITION INDICATION

- Displays the gear position in which the vehicle is traveling.
- When in neutral the indication will be "O".
- When in gear the appropriate number between 1 to 5 will be displayed.



### C. TELL TALES

1. **Turn Left** : Left turn signal "ON".
2. **Turn right** : Right turn signal "ON".
3. **Neutral** : Transmission is in Neutral.

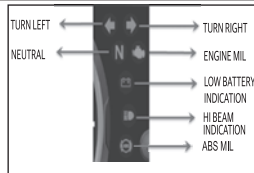

---

## OPERATION OF CONTROLS

---

4. **Low Battery Indication** : Indicator will glow continuously if ignition switch is "ON" & engine is not running, Indication will switch off as soon as engine is started. If battery voltage is below 12 V, indicator will glow continuously indicating a low battery.
5. **High Beam Indication** : Head lamp high beam "ON".
6. **EMS Malfunction Indication**:
  - Will be illuminated as soon as ignition & stop switch are "ON" and will go "OFF" after the engine is started.
  - Will remain continuously "ON" incase of any malfunction of the EMS.
7. **ABS MIL** : Will be continuously "ON" during initial check up (until or after vehicle running for a particular distance / speed) and will turn "OFF" if system is ok, then will light up again in case of any ABS System malfunction.

---

### CAUTION

---

DO NOT run motorcycle incase the malfunction remains "ON" continuously as it can cause severe damage to the ECU & Sensors. Please visit the nearest authorised Royal Enfield dealer to diagnose & rectify the defect in the EMS.

---

### D. TACHO METER

---

1. Indicates the RPM at which engine is working.
2. Useful for right section of gear with respect to engine RPM.





---

## OPERATION OF CONTROLS

---

### WARNING

- Do not run engine with gears in neutral as RPM will go beyond red zone.
- Do not ride motorcycle in lower gears with high acceleration as it will cause RPM to start to red zone & affect the mainparts inside engine.

---

### G. COMPASS LCD

---

- Useful for Navigation during riding.
- Text indicates heading direction of vehicle. (N, S, E, W, NE, NW, SE, SW)
- Arrow will always point to North.
- Eg. if heading Northwest, text will display NW and arrow will be in top right corner to indicate North.

### CAUTION

1. Avoid using magnetic key chains, magnetic / ferrous materials or electronic components with interference around cockpit area to avoid malfunctioning of digital compass.
2. If compass LCD enters into calibration mode ("CA" flashing) ride vehicle in "8" direction slowly to calibrate the compass or approach nearest authorised service center for assistance and proper calibration.
3. Indication fluctuation during riding is normal operation due to impact of road irregularities.
4. Compass indication tolerance is  $\pm 45^\circ$ .



---

## OPERATION OF CONTROLS

---

### WARNING

---

- DO NOT focus on the compass while riding. Doing so may cause loss of concentration and unstable riding, leading to a potential accident, resulting in serious injury to both riders & other road users besides causing severe damage to the motorcycle.

---

### H. FUEL GAUGE

---

- Indicates fuel level in tank.
- The fuel pointer enters red zone, if the fuel level in the fuel tank is approximately  $5.5 \pm 0.5$  litres.



### WARNING

---

Do not use the motorcycle for long duration with the fuel indication in red zone. Refuel at the earliest.

Failure to do so may cause the motorcycle to run out of fuel and get stranded, in addition to causing serious damage to the fuel pump.

---

### CAUTION

---

- DO NOT run motorcycle in case the ABS Indicator lamp continuously "ON".
- The ABS indicator blink continuously to indicate Single channel ABS mode is enabled.

---

## OPERATION OF CONTROLS - TRIPPER

---

### TRIPPER

---



Tripper is being provided to have turn by turn Navigation on motorcycle to help riders to have a hassle free riding without handling the smartphones. This device works based on Bluetooth connectivity with navigation search based on Royal Enfield Mobile App with the support of Google Maps.

Device is capable of showing turn by turn navigation on a custom designed round colour TFT with uniquely designed arrow font designed intuitively for ease of riding.

Background display can be switched between day mode and night mode which can be selected by riders from Royal Enfield Mobile app.

---

## OPERATION OF CONTROLS - TRIPPER

---

Features:

- Turn by turn navigation with primary turn, secondary turn.
- Distance to next turn, distance to destination or Estimated Time of Arrival (ETA).
- Clock display (in case of no connectivity, no navigation input or after destination is reached).
- User can select day and night mode (through Royal Enfield mobile app only).
- Low battery indication.

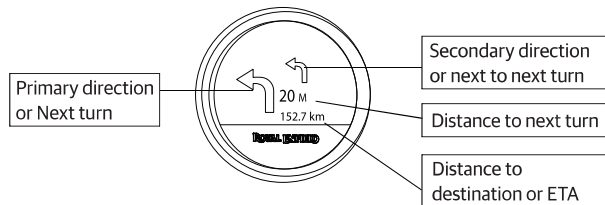

---

## OPERATION OF CONTROLS - TRIPPER

---

- Primary direction or next turn : Indicates the next turn to be taken along with the distance.

- Distance to next turn : Shows the distance to next turn.

Secondary direction or next to next turn : Indicates the next turn to be taken after the primary direction, will be shown only when primary turn is less than 100 mts, if there is no turn the display will be blank in this region.

Distance to destination or ETA : Shows the total distance to destination or estimated time of arrival (based on user selection from Royal Enfield Mobile app).

### Smartphones compatible version to the Royal Enfield Mobile app:

- Compatible with Android and iOS.

- Android support : Current version - 2.

- iOS support : Current version -1.

- Connectivity control only through Royal Enfield Mobile App.

# OPERATION OF CONTROLS - TRIPPER

## TRIPPER - DISPLAY FLOW SEQUENCE

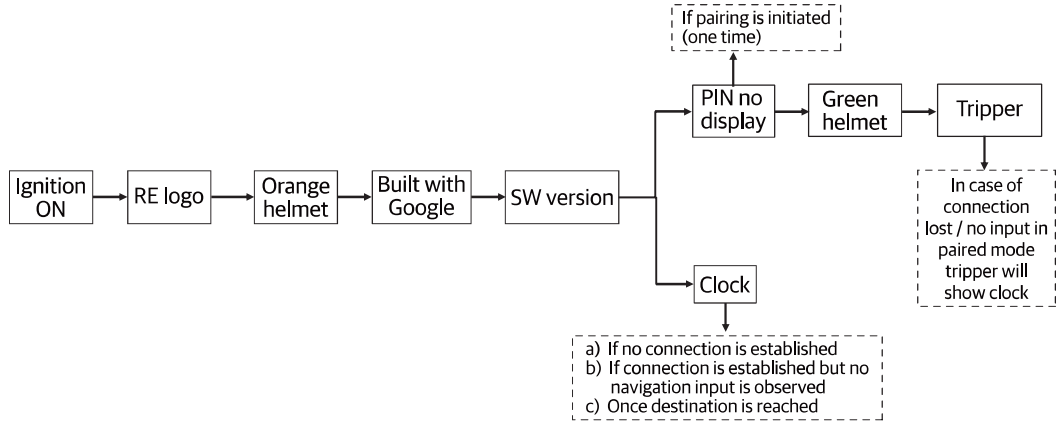

---

## OPERATION OF CONTROLS - TRIPPER

---

### NOTE

- After every Ignition "ON" cycle tripper will be in discoverable mode for 120 secs.
- In case there is no connection established within 120 secs. display will enter into clock mode, to re-initiate connection Ignition "OFF-ON" cycle to be repeated.
- During Navigation mode if there is no input from smartphone for 5 secs. Bluetooth connection will be terminated to avoid power draw and will display clock. Bluetooth connection can be terminated by end user also by closing the mobile application.
- For first time pairing user needs to enter the secured pin shown on tripper through Royal Enfield Mobile app to setup the device, after that auto-pairing will happen if same device is connected.
- Everytime the tripper is paired the clock time will sync with mobile time after which it will continue to run with internal clock even in case of disconnection, there will be time difference between time shown on instrument cluster and tripper - customer needs to update cluster clock inline with time shown on tripper as and when required as mentioned in push button management of cluster.
- Do not apply or use gasoline / petrol related fluids for cleaning or wiping on instrument cluster or Tripper, as it may result in permanent damage to the same.

---

## OPERATION OF CONTROLS - TRIPPER

---

### CAUTION

---

- Ensure ignition is "ON" and display is in powered while establishing connection.
- Ensure first time pairing is done in isolated environment to avoid cross connections (one time).
- Day and night mode is used selectable only, will not change over automatically to be selected during night driving to avoid rider distraction.
- Bluetooth connection can be established only through Royal Enfield Mobile App.
- Ensure bluetooth and location settings are turned always "ON" before usage.
- Disable battery optimisation settings / low battery cut-off setting of smartphone for Navigation to work in low battery mode.
- Royal Enfield Mobile app works only with Android (Current version - 2) and iOS (Current Version - 1) versions, for other lower versions performance lag can be expected.
- Tripper Bluetooth version is V4.2.
- Tripper time display may have a mismatch with actual time displayed in mobile device once the bluetooth connectivity is lost.
- Royal Enfield mobile app works with bluetooth version 4.2 and N+0.1, for other lower versions performance lag can be expected.  
Check for network signal strength in case of navigation lag.
- Check for data speed in case of navigation lag. Navigation system performance is better in 4G band compared to other lower versions.
- Calibrate mobile phones frequently for more GPS accuracy & location accuracy is dependent on.



---

## PRE OPERATIONAL CHECKS

---

1. Adequate fuel in fuel tank for the journey planned.
2. Tires inflated to correct pressure.
3. No side wall cracks, cuts or abrasions in the front and rear tires.
4. Rear chain for proper tension and sufficiently lubricated.
5. Engine Oil level.
6. Control cables, inner, not damaged, frayed or broken. Clutch and accelerator controls working smoothly.
7. Front and rear brakes efficiency and free play in Front and Rear Brake levers.
8. Hydraulic oil level correct in both front and rear master cylinders.
9. Free movement of handle bar to left and right sides.
10. All electrical controls, horn working correctly.
11. Head lamp, tail ramps, brake lamps and indicator lamps working correctly.
12. Front and rear wheel axle nuts tightened properly to torque.
13. Front and rear wheel spokes having proper tightness, no loose or broken spokes.
14. All fasteners are tight to required torque.
15. Engine idling correctly and smooth.
16. No abnormal noise/leak from engine.



### **WARNING**

---

For your personal welfare and safety, these pre-operational checks should be performed periodically. Failure to do so may affect safe operation, damage your motorcycle and could result in an accident causing serious injury.

---

## SAFE & HAPPY RIDING

---

- Please read this manual carefully to get to know the motorcycle and its maintenance schedules.
- Please exercise utmost caution while refueling. Open the lid carefully and slowly. Refuel only in a well ventilated area with the ignition switched "OFF".
- Gasoline is highly explosive and inflammable. DO NOT smoke or refuel if there are any naked flames or sparks nearby. Switch "OFF" mobile phones and other hand held electronic devices.
- Know and respect the rules of the road. Please be a safe rider for your own safety and for other road users.
- Please ride your motorcycle defensively. Remember a motorcycle does not afford the same protection as an automobile.
- Ride only at moderate speeds and out of traffic until you have become familiar with the handling characteristics of your motorcycle under all conditions.
- DO NOT exceed the legal speed limit. Always reduce speed when poor driving conditions exist. Use extra caution when approaching and passing through intersections, since intersections are the most likely places where accidents happen.
- Ride where other motorists can easily spot you. Please do not ride in another motorist's "blind spot".
- Always signal well in advance before turning or changing lanes. Make sure that other motorists can see your signaling and slow down.

---

## SAFE & HAPPY RIDING

---

- Never ride under the influence of alcohol or other drugs that might affect your riding skills reflex.
- When carrying a pillion rider, it is your responsibility to instruct them on proper riding procedures and riding gear.
- If you are an inexperienced rider we recommend that you obtain formal training on correct motorcycle riding techniques. New riders should gain experience under various conditions while driving at moderate speeds. Pay strict attention to road surfaces and wind conditions.
- DO NOT allow other individuals, under any circumstances, to operate your motorcycle unless you know they are experienced, licensed riders and are thoroughly familiar with the operating conditions of your motorcycle.

---

## RIDING GEAR

---

- Motorcycle riding pants and jacket fitted with certified Armour
- Motorcycle riding boots.
- Motorcycle riding gloves.
- ISI, DOT or SNELL certified helmet as applicable for rider and pillion.
- Wear a brightly colored jacket.
- Never wear loose-fitting clothes; otherwise they could catch on the control levers, footrests, or wheels and cause injury or an accident.
- Always wear protective clothing that covers your legs, ankles, and feet. The engine or exhaust system become very hot during or after operation and can cause burns.

---

## **SAFE & HAPPY RIDING**

---

### **CAUTION**

---

Avoid any contact with the exhaust system. The exhaust system gets very hot and remains hot for a long time after parking the motorcycle. Wear clothing that will completely cover the legs while riding. Failure to do so may result in serious burn injuries.

### **SITTING POSTURE**

---

Correct sitting posture is a must for stable and safe riding.

- Sit with your shoulders completely relaxed.
- Do not lock your elbows and retain them at a slight bend to enable maneuvering.
- Hold the handle grip close to its inner end.
- Lightly grip the fuel tank with your knees.
- Keep your toes in "straight ahead" direction.
- Before turning, look extensively in the rear view mirror, without turning your head.

---

## SAFE & HAPPY RIDING

---

### BRAKING

---

- Apply front and rear brakes gently and simultaneously for maximum braking efficiency.
- Please use utmost caution while applying brakes, especially while riding under wet or bad road conditions.

### WARNING

---

The hydraulic disc brakes fitted on your motorcycle requires very less effort. Applying anyone of the brakes suddenly may lock the wheels. Failure to adhere to this warning may cause loss of control on the motorcycle, leading to a potential accident resulting in serious injury to both rider and other road users, besides causing severe damage to the motorcycle.

### WARNING

---

Brake pad wear will be increased if the motorcycle is used frequently off road. Always inspect the brake pads more frequently if the motorcycle is used off-road & replace the brake pads before they become worn to or beyond the minimum service thickness. Riding the worn brake pads may reduce braking efficiency, leading to loss of motorcycle control and an accident..

DO NOT place the foot on the brake pedal while riding unless braking is required. Because this will lead to premature wear of brake pad.

---

## CARGO & ACCESSORIES

---

### LOADING

---

- Please do not fit Non OE or Non genuine accessories as they may cause damage to the motorcycle and also affect the riding and handling of the motorcycle.



- Please ensure cargo is securely strapped to the rear and sides of the motorcycle and do not become loose or shift while riding.
- Ensure the weight is distributed evenly on both sides of the motorcycle.
- Do not carry excessively heavy or huge cargo on the motorcycle.

- The maximum permissible weight of the Pannier box is 5kg each side.
- Do not hang any items on the handle bar and luggage carrier while riding which will lead to damage for the parts nearby.



### WARNING

---

Please exercise utmost caution while carrying cargo or luggage on the motorcycle. Failure to adhere to the above precautions can cause loss of control on the motorcycle, leading to a potential accident, resulting in serious injury to both rider and other road users, besides causing severe damage to the motorcycle.

Total weight of the rider and any passenger, accessories and luggage must not exceed the maximum load limit.

---

## CARGO & ACCESSORIES

---

### CAUTION

---

Exhaust gases contains poisonous carbon monoxide and chemicals, known to cause Cancer. Birth defects or other reproductive defects. Please park the motorcycle only in a well ventilated area and do not stay in the same place where the motorcycle is parked, especially when the engine and exhaust system are hot.

### WARNING

---

DO NOT tow a disabled motorcycle. The steering and handling of the motorcycle will be impaired due to the force of the towline. Towing a motorcycle can cause loss of control on the motorcycle, leading to a potential accident, resulting in serious injury to both rider and other road users, besides causing severe damage to the motorcycle.

### WARNING

---

DO NOT attach a trailer to the motorcycle. Attaching a trailer can cause loss of control on the motorcycle, leading to a potential accident, resulting in serious injury to both rider and other road users, besides causing severe damage to the motorcycle.

### WARNING

---

Max load on grab rail not to exceed 7 kg.



---

## RULES OF THE ROAD

---

- Be sure your number plate is installed in the position specified by law and is clearly visible at all times.
- Ride at a safe speed that is consistent with the type of road surface you are on. Pay strict attention to whether the surface is:
  - Dry
  - Oily
  - Icy
  - Wet
- Watch for loose debris, such as leaves, slippery substances or loose gravel that can hamper the stability of your vehicle.
- DO NOT exceed the legal speed limit or drive too fast for existing conditions. Always reduce speed when poor driving conditions exist. High speed increases the influence of any other condition affecting stability and increases the possibility of loss of control.
- Keep to the correct side of the road center line when meeting oncoming vehicle.
- All traffic signs, including manual controls at intersections, should be obeyed promptly. SLOW DOWN at traffic signs near schools and CAUTION signs at rail road crossings.
- When intending to turn, signal at least 100 feet (30.5 meters) before reaching the turning. Be close to the center line (unless local rules require otherwise), slow



---

## RULES OF THE ROAD

---

down and then turn carefully.

- Never jump a traffic light. When a change is imminent from GO to STOP (or vice versa) at intersections, slow down and wait for the light to change to green. Never run through a yellow or red traffic light.
- DO NOT leave the curb or parking area without signaling. Be sure your way is clear to enter moving traffic. A moving line of traffic always has the right-of-way.
- When parking the motorcycle,

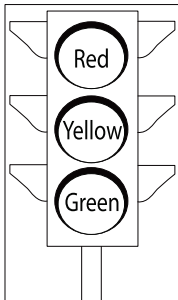

park on a firm and flat surface to prevent it from falling over.

- Protect your motorcycle against theft. After parking your

---

## RULES OF THE ROAD

---

### SIDE VIEW MIRRORS

---

motorcycle, ensure that the steering head is locked and then remove the ignition key.

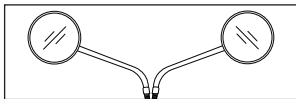

Your motorcycle is equipped with convex mirrors and have a curved surface. This type of mirror is designed to give a much wider view to the rear than a flat mirror. However, vehicles and other objects seen in this type of mirror will look smaller and farther away than when seen in a flat mirror.

### NOTE

---

Use care when judging the size or distance of objects seen in these mirrors.

To establish the relative distance of vehicles / objects behind your motorcycle through the mirrors, adjust each mirror in such a way, that a small portion of your shoulder is visible and a large portion behind your motorcycle is seen clearly with reference to your riding posture.

---

## RUNNING IN PERIOD

---

The Himalayan Motorcycle is capable of consistent high speeds. However as with any new motorcycle, a "RUNNING-IN PERIOD" procedure is essential to help in proper "Bedding-In" of the various moving parts in your motorcycle and to achieve optimum performance subsequently.

1. During the first 2000 Kms / 1243 miles of run, do not exceed the speed limits as shown in the table below.
2. Do not exceed maximum specified payload.
3. Warm up the engine for a few minutes as idling speed to allow engine oil to lubricate all the moving parts in the engine before riding the motorcycle.
4. Avoid full throttle operation and do not ride at constant throttle continuously. Vary the speed by 10% while riding.

5. Avoid sudden accelerations and racing starts.
6. Avoid prolonged full-throttle operation. Vary speed occasionally.

Motorcycle Speed Gear	First 500 kms / 310 miles	501-2000 kms / 310 - 1243 miles
1	15 KMPH / 9.35 MPH	20 KMPH / 12.42 MPH
2	25 KMPH / 15.53 MPH	30 KMPH / 18.64 MPH
3	30 KMPH / 18.64 MPH	40 KMPH / 24.85 MPH
4	45 KMPH / 27.96 MPH	55 KMPH / 34.17 MPH
5	60 KMPH / 37.28 MPH	80 KMPH / 49.70 MPH

---

## WARNING INDICATIONS & SAFETY SYSTEMS

---

### 1. ENGINE MALFUNCTION INDICATOR LAMP

A Malfunctioning Indicator Lamp (MIL) is provided in the small meter.

When both the Ignition & Engine kill switch is 'ON' and after vehicle is started, the MIL will glow for few seconds and switch 'OFF', this indicates that all the functions of Electronic fuel injection (EFI) system is functioning normally.

In the event of any malfunction in the EFI System the MIL will glow continuously. It is recommended to take the motorcycle to a nearest Royal Enfield Authorised service station for a detailed inspection and correction of the EFI system.



### 2. ANTI-LOCK BRAKING SYSTEM (ABS)

Anti-Lock Braking System (ABS) will help prevent the brakes from locking the wheels, during sudden application of the brakes at high speeds. This will help the rider to have better traction and control over the motorcycle and prevent the motorcycle from skidding which can cause an accident.

In the event of sudden and hard application of the brakes by the rider, the sensors in the braking system will signal the ABS moderator to momentarily and continuously reduce the hydraulic pressure and thereby prevent the brakes from locking the wheels while the hydraulic pressure and thereby prevent the brakes from locking the wheels while reducing the speed of the vehicle. This will help the rider to control the motorcycle.

---

## WARNING INDICATIONS & SAFETY SYSTEMS

---

An ABS indicator lamp is provided in the console (as shown in adjacent image) to warn the rider in the event of any malfunction of the ABS.

When the ignition and kill switch are switched 'ON' the ABS sign light up and remain 'ON' till the motorcycle attains a speed of 5 kmph (3MPH) and switch 'OFF'. This indicates the ABS is working properly. In the event the lamp does not switch 'OFF' and remains continuously 'ON' at higher speeds, it is recommended not to drive the motorcycle and get the brake system inspected and corrected through a nearest authorized Royal Enfield Distributor. Failure to do so can result in a serious injuries and loss of life.



---

### 3. ROLL OVER SENSOR

---

In the event of motorcycle falling over on either of its sides with the engine running and the gears engaged the Roll over sensor will "disable" both the ignition and fuel systems and switch "OFF" the engine. This is to prevent any damage to the motorcycle and its rider. To reset the Roll over sensor and reactivate the ignition and fuel systems.

- Ensure the motorcycle is made upright and is on its center stand.
- Ensure gears are in correct neutral and the neutral lamp is glowing in the instrument console.
- Switch "OFF" both ignition & stop switches, wait for a few seconds and switch "ON" the Ignition and stop switch again, to start the engine.

---

## **WARNING INDICATIONS & SAFETY SYSTEMS**

---

### **CAUTION (ABS)**

---

ABS is a safety feature to help prevent locking of wheels during sudden application of brakes. It is by no means a substitute for good riding practices and anticipatory braking.

Please ride carefully and apply brakes cautiously, especially while cornering. ABS cannot estimate the "weight shifts" and momentum of the motorcycle while negotiating a corner and therefore prevent skidding due to loss of traction.

Please anticipate the stopping distance required for the speed of travel and apply brakes well in advance so as to bring the motorcycle to a safe stop.

Please apply both brakes to stop - front brake momentarily earlier, followed by rear brake, to have better traction and control of the motorcycle.

Always ensure that you ride well within the legal speed limits.

Failure to adhere to the above can cause an accident resulting in serious injuries and loss of life.

The control function causes a slight pulsing of the hand and foot brake levers.

---

## WARNING INDICATIONS & SAFETY SYSTEMS

---

### DO'S & DON'TS : (ABS)

---

Do's	Don'ts
<ul style="list-style-type: none"><li>While starting the engine do check the ABS indicator comes "ON" and switches "OFF" when the vehicle speed exceeds 5 km/h (3.1 mph).</li></ul>	<ul style="list-style-type: none"><li>DO NOT RELEASE the brake lever / pedal when pulsations are felt during hard application of the brakes in an emergency situation. The pulsations only indicate that the ABS is activated.</li></ul>
<ul style="list-style-type: none"><li>Please check the brake fluid "MAX" level in the front and rear brake master cylinders and there is no leak in the brake systems.</li></ul>	
<ul style="list-style-type: none"><li>Apply both the brakes simultaneously for better efficiency while braking.</li></ul>	<ul style="list-style-type: none"><li>DO NOT APPLY only the front or rear brake as it can lead to inefficient braking.</li></ul>
<ul style="list-style-type: none"><li>In the event of the ABS indicator remaining continuously "ON" please take the motorcycle to a nearest authorized Royal Enfield service station to inspect the brake system control of the vehicle.</li></ul>	
<ul style="list-style-type: none"><li>ABS Switch need to activate only on vehicle static condition.</li></ul>	<ul style="list-style-type: none"><li>Don't try to activate switchable ABS on vehicle running condition.</li></ul>

---

## STARTING

---

- Ensure Gear is in Neutral position and Neutral lamp is glowing in the Instrument Cluster. To shift into neutral, move the motorcycle back and forth gently, while simultaneously shifting the gear

---

### CAUTION

Do not attempt to shift gears when engine is "OFF" and rear wheel is stationary as it will cause damage to gear shift mechanism. Please move motorcycle back and forth while simultaneously shifting gears



- Switch "ON" ignition and the stop switch to "RUN" position.

- Depress Clutch Lever fully.



- Press starter button and hold till engine starts

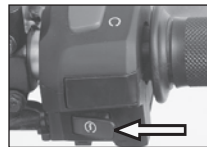

---

### CAUTION

In case engine does not start, do not keep starter button pressed continuously as it will drain the battery. Release button and restart after a few minutes to allow battery to recoup.



---

# STARTING

---

## CAUTION

Never accelerate the engine immediately after a cold start. The engines should be allowed to run slowly for 15 to 30 seconds. This will allow the engine to warm up and let oil reach all surfaces needing lubrication. Failure to adhere in damage to the engine.

- Manual Bi Starter



## NOTE

It is mandatory, necessary to depress and hold the Manual Bi-starter for a minimum of one minute when



starting the engine for the first time in cold morning, every time when the temperature are below 10 deg C, and at higher altitudes to keep the engine idling RPM steady.

As soon as the engine sufficiently warms up then Manual Bi-starter should be released.

## NOTE

- It is recommended to switch off the engine when the engine is in idling condition for long time.
- it is recommended not to accelerate by giving excessive throttle for more than 5 minutes when the engine is in idle condition, which may cause damage to the engine internal parts and exhaust system as well.

---

## GEAR SHIFTING, RIDING & STOPPING

---

- Warm up engine for 2 minutes- until idling is consistent.

### GEAR SHIFT PATTERN

1—N—2—3—4—5

- Press clutch lever towards the handgrip.
- Press gear pedal with toe to engage 1st gear.
- Gently open throttle and release clutch simultaneously, if clutch is released suddenly, the engine may stall and cause a jerky start.
- Lift gear lever with toe to engage 2nd and subsequent gears

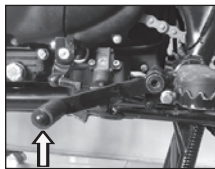
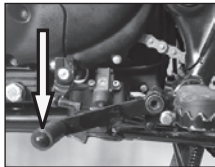

---

### CAUTION

The clutch must be fully disengaged before attempting a gear shift. Failure to fully disengage the clutch may cause a jerky start OR stalling the engine besides causing damage to transmission parts.

---

### NOTE

Always start the engine with gear in neutral position.  
Always move the motorcycle in first gear position only.  
The Motorcycle may begin to slow down and show lack of power while climbing steep hills. In that case, you should shift to a lower gear so that engine will be operating in normal power range which will prevent the motorcycle from losing momentum. The engine may be used for braking by shifting to a lower gear while riding down to steep hill.

---

# PARKING

---

## PARKING MOTORCYCLE ON SIDE STAND

---

- Select a firm, flat surface.
- Extend side stand. Tilt the motorcycle to the left, till it is supported firmly.



---

### CAUTION

When side stand is in extended position

- a) Engine will start if vehicle in neutral, but will cut-off (ignition and fuel) when gear is engaged
- b) Engine will not start if gear is engaged already.



---

### WARNING

- Ensure side stand is retracted fully before riding the motorcycle.

- Please exercise extreme care while parking and ensure it is parked firmly to avoid the motorcycle from falling over and causing injury to you or to others and damage to the motorcycle parts.
- Do not ride motorcycle with the side stand extended. Doing so can cause the side stand to touch the ground while cornering and result in instability & loss of control on the motorcycle leading to a potential accident result in serious injury to both sides and other road users besides causing severe damage to the motorcycle.

---

### NOTE

The side stand is only designed for the weight of the motorcycle. Do not sit on the motorcycle when it is resting on the side stand. The side stand of frame may become damaged and the motorcycle may fall over.

## PERIODICAL MAINTENANCE

The periodical maintenance schedule detailed below is based upon average riding conditions and indicates the intervals at which regular inspection, adjustments, replacements and lubrications must be carried out to help maintain your Himalayan Motorcycle meticulously.

If in case the motorcycle is used frequently in very dusty environment / severe climatic conditions / Poor Roads / stagnant water etc., the maintenance will need to be done earlier as may be required.

Contact a nearest Royal Enfield Authorized Dealer/ Service Center to carry out the periodical maintenance and for any expert advice.

Sl. No.	DESCRIPTION	PERIODICAL MAINTENANCE										
		Kms (x 1000)	5	10	15	20	25	30	35	40	45	50
	Miles (x 1000)	0.3	3	6	9	12	15	18	21	25	28	31
1	Engine Oil (Level check / Replace)	R	I	R	I	R	I	R	I	R	I	R
		Check level at every 1000 Kms or earlier as required										
2	Engine Oil Filter Element	R		R		R		R		R		R
3	Engine oil strainer on crankcase LH	C		C		C		C		C		C
4	Inlet / Exhaust Tappet setting	I&A	I&A	I&A	I&A	I&A	I&A	I&A	I&A	I&A	I&A	I&A
5	Rubber hose, Inlet manifold *	I	I	I	I	I	I	I	I	R	I	I

## PERIODICAL MAINTENANCE

Sl. No.	DESCRIPTION	PERIODICAL MAINTENANCE										
	Kms (x 1000)	0.5	5	10	15	20	25	30	35	40	45	50
	Miles (x 1000)	0.3	3	6	9	12	15	18	21	25	28	31
6	Oil cooler inlet & outlet pipes *	I	I	I	I	I	I	I	I	I	I	I
7	Spark plug	C&A	C&A	C&A	R	C&A	C&A	R	C&A	C&A	R	C&A
8	HT leads for crack	I	I	I	I	I	I	I	I	I	I	I
9	Fuel Hose & Clip	I	I	I	I	I	I	I	I	R	I	I
10	Fuel Pump (under tank) Mounting	Check for screw tightness in all services										
11	Air filter element	C	C	R	C	R	C	R	C	R	C	R
		Clean / Replace more frequently if motorcycle always used in dusty / off Road conditions.										
12	Accelerator Cable	I&A	I&A	I&A	I&A	I/A/R	I/A/R	I/A/R	I/A/R	I/A/R	I/A/R	I/A/R

## PERIODICAL MAINTENANCE

Sl. No.	DESCRIPTION	PERIODICAL MAINTENANCE										
		Kms (x 1000)	5	10	15	20	25	30	35	40	45	50
	Miles (x 1000)	0.3	3	6	9	12	15	18	21	25	28	31
13	Rubber Hose, Air fitler to Throttle body	I	I	I	I	I	I	I	I	R	I	I
14	PAV pipes & Hose clip	I	I	I	I	I	I	I	I	R	I	I
15	Evaporative Emission Equipment rubber hoses*	I	I	I	I	I	I	I	I	R	I	I
16	Throttle body - Cleaning spray*	Carbo cleaner / carb click / or Fuel line cleaner spray every 5000 Km or 6 months whichever is earlier										
17	Clutch Cable	I&A	I&A	I&A	I&A	I/A/R	I/A/R	I/A/R	I/A/R	I/A/R	I/A/R	I/A/R

## PERIODICAL MAINTENANCE

Sl. No.	DESCRIPTION	PERIODICAL MAINTENANCE										
	Kms (x 1000)	0.5	5	10	15	20	25	30	35	40	45	50
	Miles (x 1000)	0.3	3	6	9	12	15	18	21	25	28	31
18	Clutch free play	Adjust every 1000 Kms or earlier as required										
19	Clutch no slippage	I	I	I	I	I	I	I	I	I	I	I
20	Steering head bearings #	I & A	Inspect, adjust & lubricate for every 5000 km or earlier as required. Replace if necessary									
21	Front Fork oil / leak	I	I	I	I	R	I	I	I	R	I	I
22	Rear Wheel Drive Chain #	I & A	Clean, Lubricate & Adjust every 1000 Kms or earlier as required									
23	Battery terminals (apply petroleum jelly)	C	C	C	C	C	C	C	C	C	C	C
24	Earth wire eyelet Tightness			I		I		I		I		I
25	Hydraulic Brake Fluid - Front & Rear #	I	I	I	I	R	I	I	I	R	I	I

## PERIODICAL MAINTENANCE

Sl. No.	DESCRIPTION	PERIODICAL MAINTENANCE										
		Kms (x 1000)	5	10	15	20	25	30	35	40	45	50
	Miles (x 1000)	0.3	3	6	9	12	15	18	21	25	28	31
26	Hydraulic brake hose & Washers - Front & Rear #											
27	Brake Pads - Front & Rear #											
28	Tire wear pattern (Front & Rear) # (1)											
29	Spokes tightness / Wheel rim run out front & rear #											
30	Front & Rear wheel bearings for play #						I&R					I&R
31	Swingarm Pivot Bearings #		Inspect & If required lubricate for every 5000 km or earlier as required. Replace if necessary									



## PERIODICAL MAINTENANCE

Sl. No.	DESCRIPTION	PERIODICAL MAINTENANCE										
	Kms (x 1000)	0.5	5	10	15	20	25	30	35	40	45	50
	Miles (x 1000)	0.3	3	6	9	12	15	18	21	25	28	31
32	Rear Suspension Linkages #	I	Inspect & If required lubricate for every 5000 km or earlier as required. Replace if necessary									
33	Rear Brake Pedal Pivot	L	L	L	L	L	L	L	L	L	L	L
34	Rear Brake Pedal free play	Adjust every 1000 Kms or earlier as required										
35	Rear wheel cush rubbers #	I	I	I	I	I&R	I&R	I&R	I&R	I&R	I&R	I&R
36	All Mounting Fasteners in vehicle for tightness #	I&T	I&T	I&T	I&T	I&T	I&T	I&T	I&T	I&T	I&T	I&T
37	Hand levers, Center stand, Side stand, Rider & Pillion foot rest pivots & Gear shift levers #	Lubricate every 1000 Kms or earlier as required										
38	Cam Chain / Chain Pads / Auto chain Tensioner	I	I	I	I	I	I	I	I	I	I	I&R

## PERIODICAL MAINTENANCE

Sl. No.	DESCRIPTION	PERIODICAL MAINTENANCE										
		Kms (x 1000)	5	10	15	20	25	30	35	40	45	50
	Miles (x 1000)	0.3	3	6	9	12	15	18	21	25	28	31
39	Starter motor & Starter relay connections	I	I	I	I	I	I	I	I	I	I	I
40	Side stand switch operation	I	I	I	I	I	I	I	I	I	I	I

A : Adjust

C : Clean

I : Inspect (Clean, Adjust, Lubricate or Replace if necessary)

T : Re-tighten (2)

L : Lubricate

R : Replace

\* Refer Service Manual.

# Service more frequently when ridden in unusually wet or dusty areas.

# Service more frequently when riding in rain or at full throttle.

(1) Tire to be replaced if the tire wear identification mark reached (2) To be done at authorised Royal Enfield Dealer / Service Center

For maintenance after 50,000 Kms., please repeat same frequency specified above, in consultation with a Royal Enfield Authorised Dealer / Service Centre.

## TOOLS KIT

The tool kit is strapped underneath the Pillion seat.

S.No.	Tool Description	Purpose	Qty.
1	Allen Key 4 mm	To remove side panels LH & RH	1
2	Allen Key 6 mm	To Loosen / tighten pinch bolt on fork end	1
3	Tool Spark Plug	To Loosen / tighten Spark plug	1
4	Screw Driver	To loosen / tighten screws of housing	1
5	Extension Tube	Additional leverage for loosening tightening wheel axle nuts	1
6	Combination Spanner Open end 17 * 13 mm	To loosen / tighten hex nuts	1
7	Combination Ring Spanner 24 * 14 mm	To Loosen / tighten wheel axle nuts	1
8	D.E. Spanner 10 * 12 mm	To loosen / tighten hex nuts	1
9	Tool wallet	For storing tools	1

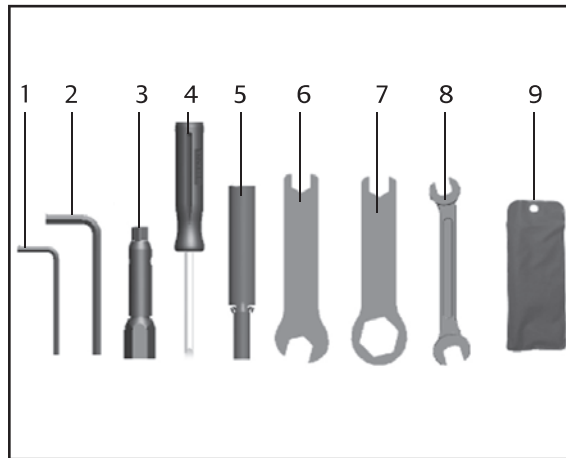

---

## MINOR MAINTENANCE TIPS

---

The following simple maintenance activities will help in maintaining your motorcycle. However if you are in experienced or feel it is best done by an experienced person, we recommend you to get in touch with a Royal Enfield Authorized Dealer/Service center.

---

### HAND LEVER PIVOTS

Wipe the area free of dirt/grease

Apply a few drops of oil on the pivots



---

### SIDE STAND PIVOTS

Apply a few drops of oil on the pivots after cleaning the area of dirt

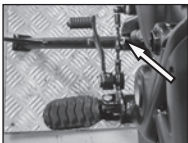

---

### PERIODICAL MAINTENANCE

Lubricate the centre stand pivot periodically for smoother operation of centre stand.

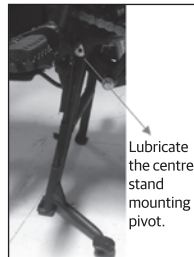

---

### DRIVE CHAIN

Clean the drive chain carefully. Apply chain lubricant while simultaneously rotating the rear wheel. Wipe off the excess lubricant

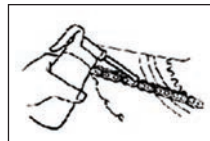

---

## MINOR MAINTENANCE TIPS

---

### OIL LEVEL INSPECTION

- Place motorcycle on its center stand on a firm surface.
- Warm up engine for a few minutes & switch off before checking oil level.
- The level is correct if the oil level is in the middle of the oil level window.
- Top up only recommended Engine oil.

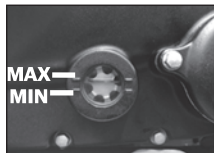

---

### CAUTION

Using Non recommended/ In- Correct oils, can cause serious damage to the moving parts, affect performance of the motorcycle AND void the warranty.

---

### SPARK PLUG

#### CLEANING AND ADJUSTING PLUG GAP

- Remove the spark plug cap from the spark plug.
- Remove spark plug using the plug spanner and tommy bar.
- Clean the insulator tip and electrodes of the plug carefully.
- Clean & adjust electrode gap every 500 km if required and replace every 15,000 kms.
- Refit the spark plug on the cylinder head.
- Refit the spark plug cap on the spark plug.
- Make sure the spark plug, spark plug cap and HT cable are proper fitment

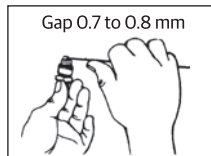

---

## MINOR MAINTENANCE TIPS

---

### BRAKE FLUID

- Check fluid level is between "MIN & MAX".
- Top up with DOT 4, if required.
- Do not overfill.
- DO NOT mix DOT 4 with other brake fluids.



FRONT BRAKE



REAR BRAKE

---

### CAUTION

---

Brake fluid is highly corrosive and can cause damage to painted parts. Please ensure brake fluid does not spill on any part of the motorcycle. In the event of a spill, please clean the area immediately with a soft cloth (preferably a wet cloth) to avoid damage.

### INSPECTION OF TIRES AND RIMS

- Periodically inspect:
  - Rims for spokes breakage wheel rim and run-out.
  - Tires for proper seating of the beading on the rims.
- Check and remove stone, splinters, nails or other sharp particles embedded in the tire.
- Replace tires if
  - Side wall cracks, cuts or damages, uneven lugs wear etc.
  - Tire lugs work out upto the "wear indicator" symbol on the side wall.

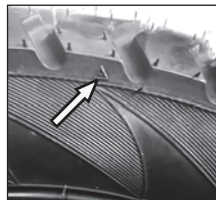

## MINOR MAINTENANCE TIPS

- Use only recommended tires & tubes, inflated to correct air pressure.

	Front	Rear
Solo	1.75 kg/cm <sup>2</sup> (25 PSI)	2.25 kg/cm <sup>2</sup> (32 PSI)
With Pillion	1.89 kg/cm <sup>2</sup> (27 PSI)	2.39 kg/cm <sup>2</sup> (34 PSI)

### **WARNING**

Dismantling and reassembly of the wheel should be done ONLY by an experienced technician.

Failure to do so may cause loss of control on the motorcycle, leading to a potential accident, resulting in serious injury to both rider and other road users, besides causing severe damage to the motorcycle.

## FRONT WHEEL REMOVAL

- Support front end of engine suitably such that the front wheel is off the ground.
- Loosen pinch bolt on right fork end with 6 mm Allen key.
- Hold spindle on right side and remove spindle nut and washer from left side.
- Support wheel and pull out spindle from right side.
- Remove the wheel along with RN Side spacer & Disc side spacer OR

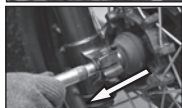

---

## MINOR MAINTENANCE TIPS

---

(Follow below procedure if vehicle have a wheel speed sensor assembly).

- Remove wheel along with wheel speed sensor and spacer.

---

### CAUTION

---

Do not press the brake lever when wheel is removed as this will result in the brake pads coming out too far from the brake caliper.

- Place a suitable spacer of 4 mm thickness, between the brake pads to avoid accidental compression of the brake lever.

---

## FRONT WHEEL REASSEMBLY

---

- Remove the spacer placed between the brake pads.
- Locate wheel speed sensor lugs on the hub slot carefully.
- Position wheel along with RH side Spacer & Disc side spacer on left side between the front fork legs, ensuring the brake disc is located between the brake pads.

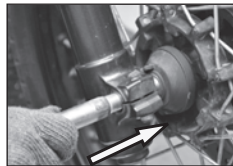

OR

(Follow below procedure if vehicle have a wheel speed sensor assembly)



---

## MINOR MAINTENANCE TIPS

---

Position wheel along with wheel speed sensor and spacer on left side between the front fork legs, ensuring the brake disc is located between the brake pads.



- Insert wheel spindle from right fork end.

Ensure the position of RH side Spacer & Disc side spacer aligned properly.



OR

(Follow below procedure if vehicle have a wheel speed sensor assembly).

Position wheel speed sensor such that it is parallel to ground.

- Hold spindle on right side, locate washer and nut on spindle on left side and tighten firmly.
- Tighten pinch bolt on right fork end.
- Rotate wheel and check for smooth rotation.
- Press brake lever and check front brake for efficiency.

---

## MINOR MAINTENANCE TIPS

---

### REAR WHEEL REMOVAL

---

- Ensure the motorcycle is on a firm, flat surface and the rear wheel is off the ground.
- Gently remove the brake hose along with its rubber grommets from the locating clips on the swing arm.
- Loosen rear axle nut on the right side and remove along with washer.
- Pull out the wheel axle from the left side, taking care not to drop the wheel spacers.

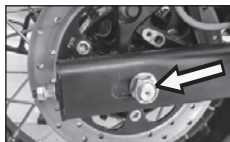
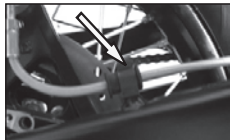

- Remove the brake caliper assembly from the slot in the swing arm along with ABS wheel speed sensor and support it suitably to avoid damage to the brake hose and ABS wheel speed sensor.
- Slide out the rear wheel from the swing arm, taking care not to drop the spacers on the wheel hub.

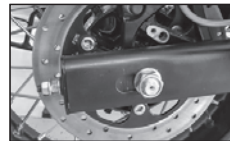

---

### CAUTION

Do not press the brake pedal when wheel is removed as this will result in the brake pads coming out too far from the brake caliper.

\* Place a suitable spacer of 4 mm thickness, between the brake pads to avoid pads compression in the event the brake pedal is pressed accidentally.

---

## MINOR MAINTENANCE TIPS

---

### REAR WHEEL REASSEMBLY

---

- Ensure the cush rubbers are in place in the wheel hub.
- Insert the wheel assembly between the swing arms and position the cush rubbers on the rear sprocket lugs correctly.
- Remove the spacer between the brake pads and locate the caliper such that the brake disc is between the brake pads.
- Locate the caliper bracket slot on the lug in the swing arm.
- Position the respective spacers on the left and right side of the wheel hub.

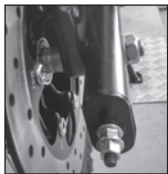

- Ensure the axle mounting hole in the swing arm, wheel hub and caliper bracket are aligned.
- Insert the wheel axle from the left side of the swing arm and gently tap it in.

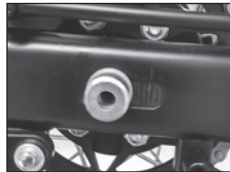

---

### CAUTION

---

- Do not force the spindle through as it will cause damage to the threaded end.
- Ensure correct chain tension and rear wheel alignment with front wheel by adjusting the adjusters on both left and right side of swing arm.



---

## MINOR MAINTENANCE TIPS

---

- Assemble washer and wheel axle nut on right side and tighten to correct torque.
- Fix the brake hose pipe in swing arm clips properly.

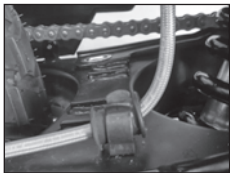

---

### CAUTION

---

- Please ensure the brake hose is correctly positioned on the clips, without any twist, sharp kinks or damage as it will seriously affect the performance of the rear brake.
- Check rear brake for effectiveness and correct functioning before using the motorcycle.

---

## DRIVE CHAIN TENSION (FREE PLAY 20-30 MM)

---

- Measure the drive chain free play on the top of the run chain.
- The recommended free play is 20 to 30 mm.



To adjust the chain tension and free play:

- Loose rear wheel spindle nut.
- Loosen lock nuts of the chain adjuster on both sides of the swing arm.
- Tighten / loosen the adjuster nut on the left swing arm end, to reduce / increase chain tension.

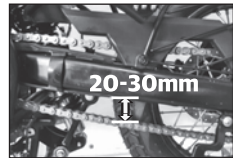

---

## MINOR MAINTENANCE TIPS

---

- Ensure the ground is level & firm and place the motorcycle in its centrestand.
- Rotate wheel slowly and check chain free play at the top run to be between 20 – 30 mm.
- Tighten / loosen adjuster nut on right side to align the front and rear wheels and also to align the reference marks on both left and right side of the swing arm.
- Tighten the lock nuts against the adjuster nuts, taking care not to disturb the adjuster nut settings.  
Tighten rear wheel spindle nut to a specified torque.



### **WARNING**

Please follow instructions as per periodical maintenance.

Chain slackness beyond 30mm will lead to chain slippage.

Maintain drive chain slackness within the specified limits at every 1000 kms interval.

Please check the front and rear wheels are correctly aligned, after the chain adjustment.

If the Engine / Rear sprocket are worn, replace the Engine / Rear sprocket & Rear chain as a kit.

---

### **ADJUSTMENTS - CLUTCH LEVER FREE PLAY**

---

Clutch Lever (free play 2 – 3 mm)

- Loosen the cable outer lock nut (A).



---

## MINOR MAINTENANCE TIPS

---

- Turn the Nut (B) Clockwise to reduce the play or Anti-clockwise to increase the free play.
- Check free play 2 to 3 mm at Clutch lever pivot on handle bar end.
- Tighten lock nut (A) after adjustment is done.

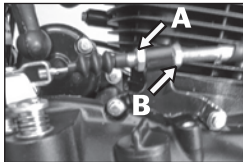

---

### ADJUSTMENT - REAR BRAKE PEDAL FREE PLAY

---

Rear brake pedal free play 7 to 11 mm.

- Loosen the lock nut in master cylinder push rod assembly.

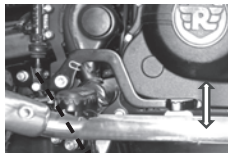

Lock nut

- Rotate the master cylinder push rod anticlockwise to reduce the rear brake pedal free play.
- Rotate the master cylinder push rod clockwise to increase the rear brake pedal free play.
- After adjustment tighten the lock nut in master Cylinder push rod assembly.

---

### BATTERY & MAINTENANCE

---

- The Motorcycle is provided with 12V - 8 AH MF battery.
- The battery must be periodically checked for corrosion free terminals.



---

## MINOR MAINTENANCE TIPS

---

### REMOVAL OF BATTERY FROM THE MOTORCYCLE

---

- Remove the side panel on the right side by unscrewing the hex socket button head screws.
- Ensure motorcycle is parked on its center stand, in a well ventilated area.
- Ensure the ignition switch and engine stop switch are in OFF position.
- Disconnect the Harness connectors around the battery located area.



- Unlock (turn the key clockwise) and remove the pillion seat.
- Remove front seat.
- Remove the Battery carrier bracket by loosening the hex bolt.
- Disconnect both the Battery terminals wires (negative first and positive next respectively).
- Take out the battery.

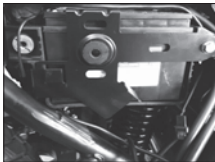

---

## MINOR MAINTENANCE TIPS

---

### BRAKE PAD WEAR

---

- Brake pad wear depends upon the severity of usage, the type of riding and road condition.

Front Brake



Wear Indicator mark



Rear Brake



Wear Indicator mark



Check the wear indicator mark on each pad. If either pad is worn to the wear indicator mark. Replace both pads as set. Visit Royal Enfield dealer for this service.

Check the wear indicator mark on each pad. If either pad is worn to the wear indicator mark. Replace both pads as set. Visit Royal Enfield dealer for this service.



---

## MINOR MAINTENANCE TIPS

---

### WARNING

Always disconnect the Black negative (-) battery cable first and then Red positive (+) cable while removing the battery connections.

---

### REASSEMBLY OF BATTERY ON MOTORCYCLE

---

- Position the battery in the battery carrier such that the terminals are facing inside.
- Ensure ignition switch is in 'OFF' condition.
- Connect the red wire to the positive terminal of the battery first.
- Next, connect the black wire to the negative terminal of the battery.
- Smear the terminals with petroleum jelly. (Do not use grease in the battery terminals).
- Place the terminal boot / cap properly.
- Refit the battery bracket.



---

## MINOR MAINTENANCE TIPS

---

- Reconnect the harness connector to the respective couplers on the battery located area.
- Refit the right side panel.
- Reassemble rider seat & Pillion seat.

---

### NOTE

- Clean the wire terminals free of corrosion and keep the terminals coated with petroleum jelly.
- It is not necessary to check the battery electrolyte level or add distilled water as the battery is a maintenance free (Sealed type).
- Your Battery is a maintenance free type and can be permanently damaged if the cap strip is removed.

---

### CAUTION

Keep the +ve and - ve cables firmly connected to the respective battery terminals. Failure to do so may result in damage to the motorcycle electrical system.



### WARNING

Always disconnect the negative (-) battery cable first and then the positive (+) cable while removing the battery connections. If the positive (+ve) battery cable should contact terminal with the negative (-ve) cable installed, the resulting sparks may cause a battery explosion which could result in serious injury.

---

## MINOR MAINTENANCE TIPS

---

### WARNING

---

Battery terminals and internals contain lead and lead components, known to cause cancer and birth defects or other reproductive harm. Always wear approved protective face shield, rubberized gloves, and protective clothing when working with batteries. KEEP BATTERIES AND ACID OUT OF REACH OF CHILDREN.

### NOTE

---

Usage of frequency for motorcycle is very important for battery to be in good performance condition. If the motorcycle is being used very rarely or sparingly and the terminals are not disconnected the battery is bound to lose its charge and result in a dead battery.

---

## CHANGING ELECTRICAL COMPONENTS

---

### HEADLAMP BULB DISMANTLING

---

- Remove the 2 screws holding the head lamp rim to the housing.
- Gently pull out the head lamp rim along with reflector assembly.
- Disconnect head lamp coupler.



---

## MINOR MAINTENANCE TIPS

---

- Remove the protective rubber cap over the bulb.
- Gently press the bulb holding clip and release it from the slot in the reflector.
- Remove the bulb from the reflector.

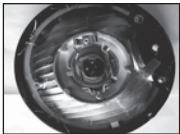
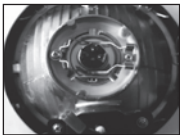

---

### NOTE

---

Never touch the bulb with your fingers. Finger prints will etch the glass and decrease bulb life.

Always hold the bulb with clean dry cloth during handling.

Don't disturb the vent cap provided in the inner body mould.



---

## HEAD LAMP BULB REPLACEMENT

---

- Locate the 3 lugs in the bulb correctly in the reflector.
- Locate the bulb holding clip over the bulb and lock it in the slot in the reflector.
- Put the protective rubber cap over the bulb correctly such that the vent pipe is facing downwards.
- Connect head lamp coupler on the bulb terminals correctly.
- Locate the head lamp rim in the housing correctly such that it locks in place and the 2 mounting holes of the

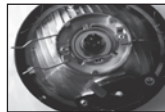

---

## MINOR MAINTENANCE TIPS

---

rim are aligned with the holes in the hosing.

- Assemble the 2 screws and tighten firmly.



---

### TAIL LAMP BULB

---

- Locate key on left side & turn clock wise lift pillion seat and remove.
- Loosen the tail light assembly mounting bolts.
- Remove the tail lamp cover by loosen the nuts.

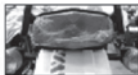

- Remove the outer lens and reflector safely by unscrewing its mounting screw.
- Hold the bulb, press inside and rotate anticlockwise to remove the tail light bulb from its holder.
- Replace the bulb 12V 21/5W.
- Assemble back the tail light in the reverse order of dismantling process.
- Assemble the tail lamp cover and refit the tail lamp assembly.

---

### LICENSE PLATE ILLUMINATOR

---

The license plate illuminator has a LED lighting system. In the event of failure, the entire license plate illuminator assembly should be replaced.

Contact Authorised Royal Enfield Dealer / Service center to replace the same.

---

## MINOR MAINTENANCE TIPS

---

### TRAFFICATOR BULB REPLACEMENT

---

- Remove the screw from the trafficator hosing backside.
- Remove outer lens safety by slightly rotate the housing and outer lens.
- Remove the bulb holder by turning in anticlockwise direction.
- Remove the fused bulb by pushing and turning in anticlockwise direction.
- Position the new bulb inside the holder, ensuring that the pins in the bulb, match with slots in the holder



- Push the bulb and turn clockwise direction to lock the bulb in the holder.  
Refit the bulb holder by turning to clockwise direction.
- Refit the trafficator cover with reflector and tighten the screw.

---

### NOTE

---

Do not over tighten the screw.

Make sure the Ignition switch is in "OFF" position when replacing the Bulbs, Fuses and Electrical parts.

---

## MINOR MAINTENANCE TIPS

---

### FUSE & CARRIER

---

- The fuse carrier is located under the rider seat.
- Remove Pillion seat & rider seat.
- Open the fuse carrier lid & replace fuse as indicated inside the lid.
- Replace the required fuse with the spare fuse available in the fuse carrier.

---

#### NOTE

Please ensure to replace a spare fuse in the holder at the earliest opportunity.

---

#### CAUTION

Switch the ignition key to OFF before replacing the fuse to avoid possible short - circuits.

When replacing a blown fuse, it is important to use only a fuse having the correct amperage rating. The use of a fuse with a rating other than indicated may result in a dangerous electrical system overload. If a properly rated fuse continues to blow, it indicates a problem in the circuit that must be corrected.

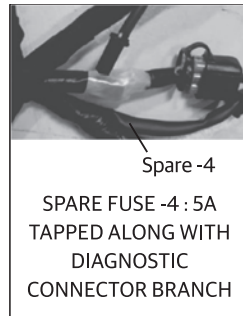
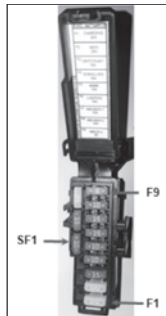

---

## MINOR MAINTENANCE TIPS

---

### BLADE FUSE USAGE LIST

---

ID No.	Function	Ration
F 1	CHARGING FUSE	25 A
F2	MAIN FUSE	25 A
F3	IGNITION FUSE (EFI)	15 A
F4	SIGNALLING FUSE	15 A
F5	HAZARD FUSE	10 A
F6	LIGHTING FUSE	15 A
F7	ABS MAIN 1 FUSE	15 A

ID No.	Function	Ration
F 8	ABS MAIN 2 FUSE	10 A
F 9	ABS ECU	5 A
SPARE - 1	SPARE FUSE 1	10 A
SPARE- 2	SPARE FUSE 2	15 A
SPARE - 3	SPARE FUSE 3	25 A
SPARE - 4	SPARE FUSE 4	5 A

### WARNING

Please get the electrical system of your Motorcycle checked thoroughly and get the faults corrected immediately after experiencing any fuse failure. Not doing this can result in to repeated fuse failures.

Usage of fuses other than specified rating will damage the complete electrical system.



---

## MINOR MAINTENANCE TIPS

---

### WIND SHIELD CLEANING

---

Wipe the windshield with a soft cloth. Do not wipe vigorously as it will cause scratches on the windshield.

Use a mild detergent and lukewarm water to remove any hard coating, insect hits etc from the windshield.

Rinse well with water and use a soft dry and lint free cloth to wipe off the water.

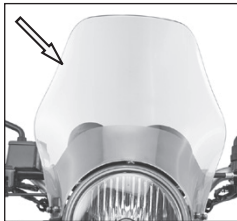

### CAUTION

---

Use of any hard cleaning substances such as stain removers, water repellent compounds, petroleum products, solvents and alcohol based material will seriously affect the windshield transparency.

Scratches, cloudiness, cuts and abrasions on the windshield cannot be polished or removed. The windshield must only be replaced if damaged.



### WARNING

---

Never attempt to clean the windshield while riding. Failure to do so may cause loss of control on the motorcycle, leading to a potential accident, resulting in serious injury to both rider and other road users, besides causing severe damage to the motorcycle.

---

## **LONG TRIP PRECAUTIONS**

---

### **CHECK PRIOR TO THE COMMENCEMENT OF LONG JOURNEY**

---

- Service the motorcycle at a Royal Enfield Authorised Dealer / Service Center.
- Ensure sufficient quantity of petrol in the fuel tank for the journey planned.
- Check and correct tire pressure if necessary.

### **CHECK AFTER EVERY 1500 KMS / 932 MILES OF RUN**

---

- Any loose fasteners.
- Condition of the tires.
- Correct oil level in engine.
- Working of all lights and horn.

- Proper drive chain tension.

---

### **ITEMS TO BE CARRIER**

---

- Toolkit
- Bulbs for Head light, Trafficator light & Taillight, fuse
- Accelerator, Clutch cables.
- Rear chain master link lock assembly.
- Insulation tape.
- Spark plug, Spark plug cap.

---

# SHOCK ABSORBER

---

## SPRING PRELOAD & SHOCK ABSORBER SETTINGS

---

### INCREASING THE PRELOAD

---

- To increase spring preload, turn preload adjuster in the clockwise direction.

### REDUCING THE PRELOAD

---

- To decrease the spring preload, turn preload adjuster in the anticlockwise direction

### CAUTION

---

It is recommended to visit Authorised Dealer for adjusting spring preload and shock absorber settings.

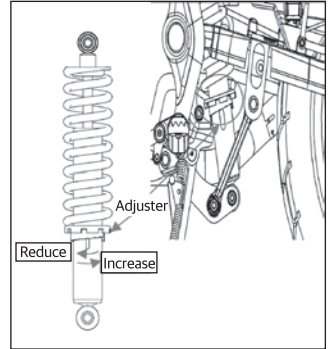

---

# OFF ROADING

---

## AFTER OFF ROADING

---

It is recommended to check the following after off roading :

### TIRE PRESSURE

- Tire pressure needs to be optimal for effective riding on surfaced roads.
- Always check the tire pressures are correct.

### BRAKES

- Riding on dirty & muddy roads brakes may not be effective immediately because of dirt & moisture on the disc pads.
- Apply the brakes in good time until the brakes have been cleaned.

### RIMS

- It is recommended to check the rims & wheels for damage after off roading.

## SPRING PRELOAD & SHOCK ABSORBER SETTINGS

---

- The off road settings of spring & shock absorber settings will impair the motorcycle's handling characteristics on surfaced roads.
- Remember to correct the spring & shock absorber settings before returning to surfaced roads.

## AIR FILTER ELEMENT

---

- Cleaning of air filter element is recommended for effective utilisation of air filter element in returning to surfaced roads.
- Check for any damages or clog in air filter and replace if required.

---

# WASHING PROCEDURE

---

## PRECAUTIONS

---

- Wash motorcycle when the engine is cold.
- Cover the silencer, tail pipe, horn, Control switches, Instrument cluster & Tripper with suitable plastic bags and tie it firmly to prevent water entry.
- Remove ignition key and seal key hole using adhesive tape.
- Brush engine area with a solvent to remove dirt or grease.
- Use low pressure jet of water to clean.
- DO NOT spray water directly on the steering stem area as it will damage the bearings and cause the handle bar movement to become sticky.
- Never spray water with great force on headlamp, speedometer, Tripper, Flasher lights, front and rear wheel hubs, electrical connections and wires, control cables, cables, sparkplug, battery, ABS ECU, EMS ECU, side mirrors, steering stem etc.
- Do not apply any corrosive solvent on painted surfaces or rubber parts.
- Use luke warm water and mild detergent on the painted components to remove dirt, etc.
- Rinse motorcycle thoroughly with plain water to remove the detergent.
- If possible, use compressed air and blow off water particles from the hard to reach areas of the motorcycle, electrical connections etc.
- No direct jet at the edges of decal, electrical parts, coupler joints, silencer tail pipe, radiator lubrication

---

## WASHING PROCEDURE

---

points like steering cone kit, brake pedal, wheel bearings, chain, brake cam & swing arm bushes to be washed in spray mode only (not in jet mode).

- Once the motorcycle has been ridden in salty conditions or near coastal areas it is recommended to wash your motorcycle with cold water. Please do not use warm water for washing as it may damage the motorcycle due to chemical reaction with the salt. After washing process once the motorcycle is completely dry it is recommended to apply anti corrosion spray on all the metal and chrome plated areas to protect the parts from corrosion.
- It is recommended not to apply the anti-corrosion spray on the brake discs.

---

## AFTER WASHING

---

- Ensure, the motorcycle is thoroughly dry by wiping with a clean soft absorbent cloth or chamois leather.
- Remove all plastic bags and adhesive tapes.
- Lubricate control cables, pivot and rear chain with lube oil.
- Polish the painted (except Stone Black Colour / Matt paint finish) and plated surfaces using polishing wax.
- Start engine and allow to run at idling speed for a few minutes to warm up engine.
- Drive the motorcycle slowly, applying both brakes intermittently to dry up the water in the brake shoes.



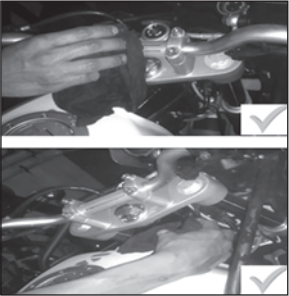
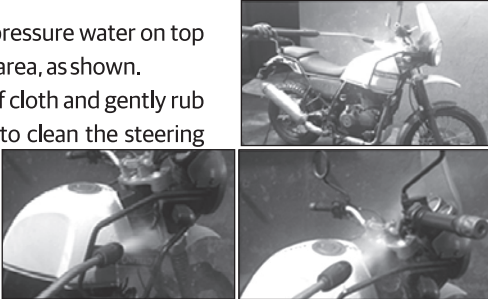

## WASHING PROCEDURE

Location	Do's	Don'ts
Steering T Stem Mounting area	<p data-bbox="311 296 832 329">Wipe Steering area with Cotton Cloth</p> 	<p data-bbox="871 298 1122 342"><b>⚠ WARNING</b></p> <p data-bbox="871 379 1431 601">Do not spray high pressure water on top &amp; bottom dust seal area, as shown. Wet a small piece of cloth and gently rub on required areas, to clean the steering tube area.</p> 

### NOTE

High Pressure water Jet should not directly Shown on the above mentioned Locations.

## WASHING PROCEDURE







Location	Do's	Don'ts
<p>Oil Cooler Fins Damage</p>	<p>Use protector to cover the fins Location</p> 	<p>Don't use High pressure water jet on Oil Cooler</p> 
<p>Instrument Cluster</p>	<p>Wipe Head lamp glass with Cotton Cloth</p> 	<p>Don't use High pressure Water on Head lamp Front &amp; back</p> 

### NOTE

High Pressure water Jet should not directly Shown on the above mentioned Locations.

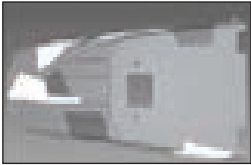
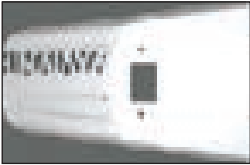
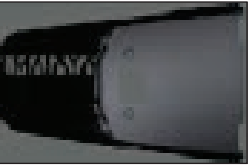

# WASHING PROCEDURE

Location	Note
Stickers on Front Mudguard, Rear Mudguard & Side Panel	<p data-bbox="334 367 479 792">High pressure water Jet should not directly Shown on these Locations.</p>        

---

## STORAGE PRECAUTIONS

---

In case your Motorcycle is not going to be used for a month or more, the following precautions should be taken.

- Get the motorcycle serviced through a Royal Enfield Authorised Dealer / Service Center.
- Drain fuel tank and fuel line.
- Spray engine oil inside the fuel tank to prevent rusting.
- Remove spark plug. Pour in about 25ml of clean engine oil through spark plug hole. Close the hole and crank engine several times and refit spark plug.
- Clean rear chain thoroughly and apply a chain lube.
- Remove battery from the motorcycle. Clean the terminals free of corrosion and apply petroleum jelly to terminals.
- Store the battery in a cool, dry and well ventilated place.
- Cover the silencer with plastic bags to prevent moisture entry. Set the motorcycle on its center stand.
- Apply anti rust solutions on all plated parts. Take care not to apply this solution on rubber or painted parts.
- Store motorcycle in a clean covered area free of moisture and dust.
- For re use after storage, it is preferable to get the motorcycle prepared through a Royal Enfield Authorised Dealer / Service Center to ensure the motorcycle is restored to its peak operating conditions.
- If the motorcycle is not used for a month or longer, It is advised to disconnect battery terminals and remove the battery. Before refitting the battery in the motorcycle, check the battery voltage is within specification, if not, recharge it from authorized service workshop / battery dealer.

---

## WIRING DIAGRAM

---

### DISCLAIMER

---

It is recommended that the wiring circuit repair and any other electrical rework should be performed only by an authorized Royal Enfield service centre, failure to adhere this may cause damage to electrical systems and render the warranty of the products as void.



---

## TROUBLE SHOOTING

---

We have listed below a few basic checks in case your mc is not functioning. If in case the problem is not rectified after these checks, it is necessary to get the mc checked by Reauthorised Dealer / Service Center to rectify the problem and to ensure trouble free performance.

Symptom	Observations	Check for / Remedy
Engine Does not start	1. Ignition / Engine stop switch is in 'OFF' position	Switch 'ON' Ignition / Engine stop switch.
	2. Very low / No fuel in the fuel tank.	Fill fuel.
	3. Lights / horn very dim (Horn Poor / Low Sound)	Weak / Discharged battery, Contact Authorised Service Centre.
	4. Electricals not working	1. Battery completely dead. Replace battery. 2. Fuse Blown. Replace appropriate fuse. Note: If fuse blows again, contact Authorised Service Centre.

---

## TROUBLE SHOOTING

---

Symptom	Observations	Check for / Remedy
Engine Does not start	5. Engine Cranking but not starting	Spark plug Cap / wire disconnected. Reconnect. Check if SIDE STAND is ON / SIDE STAND SWITCH MALFUNCTION.  Check if gear is engaged and the side stand is down.  If the ambient Temperature is low use Manual Bi-starter.
Engine Starts BUT shuts off immediately	Engine shuts off as soon as throttle is closed.	Idling RPM set too low / setting disturbed. Contact Authorised Service Centre for resetting the Idling RPM.  Check if the MIL Lamp is glowing; If yes, Contact Authorised Service Centre.

---

## TROUBLE SHOOTING

---

Symptom	Observations	Check for / Remedy
Engine Misfires & Runs Erratically / Stops	1. Typically happens after a Refill / Adulterated / Water in Fuel.	Drain out entire fuel and Refill with fresh fuel from a reputed filling station.
	2. Motorcycle driven in Low gear / High RPM / Crowded places for long time.	Excessive Engine temperature. Switch 'OFF' Engine and allow to cool down.  Check if the MIL Lamp is glowing; If yes, Contact Authorized Service Centre.

---

## TROUBLE SHOOTING

---

Symptom	Observations	Check for / Remedy
Poor Pickup	Engine RPM raises disproportionately to motorcycle speed.	Clutch is Slipping. Check for sticky clutch / clutch not having any free play.
	Rear Chain excessively loose causing chain to slip on Sprocket.	Adjust Rear chain to correct tension.  Check if the MIL Lamp is glowing; If yes, Contact Authorized Service Centre.
ABS (Anti lock Braking system)	ABS lamp continuously "ON".	Take the vehicle to service centre for diagnosis.

---

## WARRANTY TERMS & CONDITIONS

---

Royal Enfield Motorcycles are manufactured by following best Quality practices in respect of the material and workmanship.

Royal Enfield (RE) warrants its motorcycle to be free from manufacturing and material defect under normal use subject to following conditions.

1. Warranty shall be in force until the expiry of a period of 24 months from the date of sale. The Warranty period begins from the date of retail sales invoice of the Motorcycle to the first owner and subsequent owners. The retail invoice date is considered as start date for the warranty period. Once the warranty period has begun, it cannot be stopped or interrupted.
2. In order to effect Warranty, it is a prerequisite that the maintenance schedule prescribed by Royal Enfield in this

Owner's manual and warranty repairs if any, has been carried out at the Authorised Distributor's service facility OR at their Authorised dealership's service facility.

3. Record of all the regular services and periodical maintenance that have been carried out, along with proof of service history will be required to be verified by the Authorised Distributor's service facility OR their Authorised dealership's service facility, prior to carrying out a warranty service.
4. Proof of Ownership, in the form of Sales Registration OR Proof of Purchase documentation of the motorcycle, clearly mentioning the Engine & VIN numbers, must be provided to the Distributor's service facility OR their Authorised dealership's service facility.



---

## WARRANTY TERMS & CONDITIONS

---

5. During the warranty period, RE's obligations shall be limited to repairing/replacing part(s) of the motorcycle for free, only if the part is on examination is deemed to have a manufacturing defect. Defective part(s) which have been replaced will become the sole property of RE.
6. Consumables like Oil. Oil Filter. Fuel etc used during warranty repair / replacement are not covered and chargeable to the customer.
7. Claims on proprietary items like tires. tubes. spark plug, battery etc. should be taken up with the respective manufacturer or their authorised agents in the area directly by the customer. RE shall not be liable in any manner to replace them through their dealers. RE will, however, provide assistance in referring such claims on the respective manufacturer.
8. Warranty shall not apply to:
  - (a) Normal ageing. deterioration or rusting of plated parts, paints coat, rubber parts, soft items, glass items, plastic parts etc.
  - (b) Components like fuel filter. oil filter, air filter paper element, control cables, brake shoes / brake pads, clutch plates, drive chain & sprocket kit, steering ball races, electrical equipment. wiring harness etc., which are subjected to normal wear and tear.
  - (c) Failures occurred due to use of non recommended grade lubricants, fuel or improper level.
  - (d) Damages due to use of non-genuine parts, lack of proper maintenance, incorrect riding habits.

---

## WARRANTY TERMS & CONDITIONS

---

- (e) Damages to engine management system parts (like ECU, Throttle body, Sensors, etc.) due to tampering which affects the performance of the motorcycle.
- (f) Parts damaged due to accidents, collision, abuse etc.
- (g) Irregularities not recognised as affecting the quality or function of the motorcycle such as slight vibration. oil leakage. blue discoloration of exhaust bent pipe / silencer / soft or hard shock absorber etc.
- (h) Defects arising from fitment of unauthorised or additional electrical loads.
- (I) Motorcycle serviced or repaired at unauthorised service centers.
- (j) Motorcycle used for competitions / racing / Stage Rallying etc.
- (k) Electrical component like bulbs. fuses etc. and electronic components failure due to repairs by arc welding.
- (l) Normal maintenance operations like adjustment of brakes. cleaning fuel system. engine tune-up and other such adjustments.
- (m) Oxidization of buffed / painted / powder coated items etc.
- (n) Motorcycles fitted with sidecars and trailer hitches.

---

## WARRANTY TERMS & CONDITIONS

---

9. Use only Royal Enfield approved parts and accessories. Use of certain other manufacturer's performance parts will void your new motorcycle warranty.
10. RE reserves the right to finally decide on all warranty claims.
11. RE reserves the right to make changes in design of the motorcycle without any obligation to install these changes on previously supplied motorcycles.

---

## **EMISSION CONTROL SYSTEM WARRANTY**

---

The following warranty applies to the emission control system and is in addition to the LIMITED WARRANTY, NOISE CONTROL SYSTEM WARRANTY & CALIFORNIA AIR RESOURCES BOARD REGULATIONS. EVAPORATIVE EMISSION CONTROL SYSTEM WARRANTY. (Applicable only for motorcycles sold within the state of California.)

Royal Enfield Motors warrants the first owner and each subsequent owner, that this motorcycle is designed and built so as to conform, at the time of sale, with applicable regulations specified by the U.S. Federal Environmental Protection Agency and California Air Resources Board Regulations, that the Emission control system related parts fitted to this motorcycle are free from defects in materials and workmanship which may cause this motorcycle not to meet the U.S. Federal Environmental Protection Agency standards

for a period of 5 years OR 18,641 Miles (30,000 Kms.), whichever occurs first, from the date of first use of the motorcycle.

The Warranty period shall begin, on the date the motorcycle is delivered to the first retail purchaser OR from the first date the motorcycle is used as a demonstrator OR as a display and/or trial motorcycle.

THE FOLLOWING ITEMS ARE NOT COVERED BY THE EMISSION CONTROL SYSTEM WARRANTY:

1. Failures which may arise as a result of misuse, alterations, accidents OR non performance of routine maintenance, as specified in the Owner's Manual.
2. Replacement of parts such as Spark plugs, Air filter, fuel filter, Oil filter, fuel injector, lubricating oils etc. that are

---

## **EMISSION CONTROL SYSTEM WARRANTY**

---

required to be replaced during routine maintenance at specified intervals as mentioned in this Owner's Manual.

3. Loss of time, inconvenience, loss of motorcycle use or any other consequential loss or damages.
4. Any motorcycle in which the Odometer has been tampered with, OR the speedo cable has been disconnected for any reason Or is broken and not replaced immediately, due to which the exact distance covered cannot be determined.

### **RECOMMENDATIONS FOR REQUIRED MAINTENANCE:**

It is recommended that the routine maintenance of the motorcycle be carried out at specified intervals and any maintenance to the emission control systems should be

performed only by an authorised Royal Enfield service dealer and using only genuine Royal Enfield spare parts.

Repairs to the emission control system may be performed by any other qualified service outlet or individual and use of parts other than genuine Royal Enfield supplied parts is permissible, only if such agency or individuals and the non genuine parts used, are certified to comply with the U.S. Environmental protection agency standards.

---

## **NOISE CONTROL SYSTEM WARRANTY**

---

The following warranty applies to the noise control system and is in addition to the LIMITED WARRANTY, EMISSION CONTROL SYSTEM WARRANTY & CALIFORNIA AIR RESOURCES BOARD REGULATIONS. EVAPORATIVE EMISSION CONTROL SYSTEM WARRANTY. (Applicable only for motorcycles sold within the state of California.)

Royal Enfield Motors warrants the first owner and each subsequent owner, that this motorcycle is designed and built so as to conform, at the time of sale, with applicable regulations specified by the U.S. Federal Environmental Protection Agency and California Air Resources Board Regulations, that the Noise control system emission related parts fitted to this motorcycle are free from defects in materials and workmanship which may cause this motorcycle

not to meet the U.S. Federal Environmental Protection Agency standards for a period of 5 years OR 18,641 Miles (30,000 kms.), whichever occurs first, from the date of first use of the motorcycle.

The Warranty period shall begin, on the date the motorcycle is delivered to the first retail purchaser OR from the first date the motorcycle is used as a demonstrator OR as a display and/or trial motorcycle.

THE FOLLOWING ITEMS ARE NOT COVERED BY THE NOISE CONTROL SYSTEM WARRANTY:

1. Failures which may arise as a result of misuse, alterations, accidents OR non performance of routine maintenance, as specified in the Owner's Manual.

---

## **NOISE CONTROL SYSTEM WARRANTY**

---

2. Replacing OR removing OR modifying any portion of the NOISE CONTROL SYSTEM (consisting of Exhaust. Air intake/ cleaner assembly) with parts not certified to be genuine and noise legal in the USA for street use.
3. Loss of time. inconvenience. loss of motorcycle use or any other consequential loss or damages.
4. Any motorcycle in which the Odometer has been tampered with. OR the Speedo cable has been disconnected for any reason or is broken and not replaced immediately. due to which the exact distance covered cannot be determined.

### RECOMMENDATIONS FOR REQUIRED MAINTENANCE :

IT IS RECOMMENDED THAT THE ROUTINE MAINTENANCE OF THE MOTORCYCLE BE CARRIED OUT AT SPECIFIED INTERVALS AND ANY MAINTENANCE TO THE NOISE CONTROL SYSTEMS SHOULD BE PERFORMED ONLY BY AN AUTHORISED ROYAL ENFIELD SERVICE DEALER AND USING ONLY GENUINE ROYAL ENFIELD SPARE PARTS.

REPAIRS TO THE NOISE CONTROL SYSTEM MAY BE PERFORMED BY ANY OTHER QUALIFIED SERVICE OUTLET OR INDIVIDUAL AND USE OF PARTS OTHER THAN GENUINE ROYAL ENFIELD SUPPLIED PARTS IS PERMISSIBLE, ONLY IF SUCH AGENCY OR INDIVIDUALS AND THE NON GENUINE PARTS USED. ARE CERTIFIED TO COMPLY WITH THE U.S. ENVIRONMENTAL PROTECTION AGENCY STANDARDS.

---

## **EVAPORATIVE EMISSION CONTROL SYSTEM WARRANTY**

---

(Applicable only for the state of California)

The following warranty applies to the evaporative emission control system and is in addition to the LIMITED WARRANTY.

**EMISSION CONTROL SYSTEM WARRANTY & NOISE CONTROL SYSTEM WARRANTY.**

Royal Enfield Motors warrants the first owner and each subsequent owner, that this motorcycle is designed and built so as to conform, at the time of sale, with applicable regulations specified by the California Air Resources Board AND that the evaporative emission control system related parts fitted to this motorcycle are free from defects in materials and workmanship which may cause this motorcycle not to meet applicable regulations of the California Air Resources "Board standards, for a period of 5 years OR 18,641

Miles (30,000 Kms.), whichever occurs first, from the date of first use of the motorcycle.

The Warranty period shall begin either on the date the motorcycle is delivered to the first retail purchaser OR from the first date the motorcycle is used as a demonstrator OR as a display and/or trial motorcycle.

**THE FOLLOWING ITEMS ARE NOT COVERED BY THE EVAPORATIVE EMISSION CONTROL SYSTEM WARRANTY:**

1. Failures which may arise as a result of misuse, alterations, accidents OR non performance of routine maintenance, as specified in the Owner's Manual.
2. Replacing OR removing OR modifying any portion of the EVAPORATIVE EMISSION CONTROL SYSTEM (consisting of Fuel tank, fuel tank cap, Canister, purge



---

## EVAPORATIVE EMISSION CONTROL SYSTEM WARRANTY

---

valve, throttle body, vapor hoses, fuel hoses and hose connectors) with parts not certified to be genuine and approved by California Air Resources Board.

3. Loss of time, inconvenience, loss of motorcycle use or any other consequential loss or damages.
4. Any motorcycle in which the Odometer has been tampered with, OR the Speedo cable has been disconnected for any reason OR is broken and not replaced immediately, due to which the exact distance covered cannot be determined.
5. Normal ageing of parts such as fuel hoses, vapor hoses, gaskets & rubber components.

### RECOMMENDATIONS FOR REQUIRED MAINTENANCE :

It is recommended that the routine maintenance of the motorcycle be carried out at specified.

Intervals and any maintenance to the evaporative emission control systems should be performed.

Only by an authorised Royal Enfield service dealer and using only genuine Royal Enfield spare parts.

Repairs to the evaporative emission control system may be performed by any other qualified service outlet or individual and use of parts other than genuine Royal Enfield supplied parts is permissible, only if such agency or individuals and the non genuine parts used. Are certified to comply with the California Air Resources Board.

---

## **ENVIRONMENT CARE**

---

### **BE AN ENVIRONMENTALLY CONSCIOUS RIDER**

You've ridden through some beautiful places on your Royal Enfield. Won't you like to keep them that way? Here are some tips to help you keep those places unspoilt so that others can enjoy them too:

---

#### **ENGINE OIL**

While your liquid waste like engine oil, gasoline, coolant and other cleaning solvents need to be regularly replaced, what happens to them? Make sure they are not dumped in the soil, down the sewers, drains, lakes or rivers around you. The simplest way to do it is to have them drained into a container which you can hand over to your local recycling agent or at your nearest Royal Enfield service centre. They will follow the guidelines laid down by the local authorities to get rid of it.

---

#### **BATTERY**

If your Royal Enfield's battery needs to be replaced, hand it over to an authorised recycling agent or Royal Enfield service centre. They will follow the guidelines laid down by the local authorities to get rid of it. This will ensure the dangerous substances from which the battery has been manufactured do not pollute the environment.

---

#### **TIRE(S)/PLASTIC/ELECTRICAL/ELECTRONIC PARTS/OIL FILTER**

If your Royal Enfield's tire(s)/plastic/electrical/electronic part(s)/oil filter need to be replaced make sure you hand them over to an authorised recycling agent or a Royal Enfield service centre. They will follow the local authority's guidelines to get rid of them in an environmentally friendly manner.

---

## **ENVIRONMENT CARE**

---

### **CLEANING YOUR ROYAL ENFIELD**

---

Avoid aerosol sprays; instead, use a biodegradable detergent or dry wash to wash your Royal Enfield. Also, be cautious while discarding the cleaning solvents. Hand them over to an authorised recycling agent or a Royal Enfield service centre.

They will follow the local authority's guidelines to get rid of them in an environmentally friendly manner.

-----  
This note does not constitute legal advice; please contact your local authorities or your nearest Royal Enfield Service Centre for further guidance.

---

# RADIO TYPE APPROVAL

---

## TRIPPER / NAVIGATION DISPLAY UNIT - USA

---

### FCC ID: NT8-JDCP

FCC §15.19 Labelling requirements

This device complies with part 15 of the FCC Rules and Innovation, Science and Economic Development Canada (ISED) license-exempt RSS standard(s). Operation is subject to the following two conditions:

- (1) This device may not cause harmful interference, and
- (2) This device must accept any interference received, including interference that may cause undesired operation.

FCC §15.21 Information to user



Changes or modifications not expressly approved by the party responsible for compliance could void the user's authority to operate the equipment.

FCC §15.105 statement

This equipment has been tested and found to comply with the limits for a Class B digital device, pursuant to part 15 of the FCC Rules. These limits are designed to provide reasonable protection against harmful interference in a residential installation. This equipment generates, uses and can radiate radio frequency energy and, if not installed and used in accordance with the instructions, may cause harmful interference to radio communications. However, there is no guarantee that interference will not occur in a particular installation. If this equipment does cause harmful interference

---

## **RADIO TYPE APPROVAL**

---

to radio or television reception, which can be determined by turning the equipment off and on, the user is encouraged to try to correct the interference by one or more of the following measures:

- Reorient or relocate the receiving antenna.
- Increase the separation between the equipment and receiver.
- Connect the equipment into an outlet on a circuit different from that to which the receiver is connected.
- Consult the dealer or an experienced radio/TV technician for help.

### RF Exposure Requirements

To comply with FCC RF exposure compliance requirements, the device must be installed to provide a separation distance of at least 20 cm from all persons.

---

## SERVICE MAINTENANCE RECORD

---

S.No.	Date	Job Card No.	KMS/Miles	Brief details of work / service	Royal Enfield Authorised Dealer
1.					
2.					
3.					
4.					
5.					
6.					
7.					
8.					

---

## **NOTES**

---

---

## **NOTES**

---



---

## **NOTES**

---

---

## **NOTES**

---





**ROYAL ENFIELD**

Part No. RAM00372/A

[ROYALENFIELD.COM](http://ROYALENFIELD.COM)

Edition : June 2021