

Part Number:

1990204

Models:

Himalayan

WARNING: Royal Enfield genuine accessories are designed to fit only the specific Royal Enfield motorcycle(s) that are specified above. They should not be fitted to any other type of motorcycle. Pay particular attention to the warnings and cautions contained in this instruction, failure to do so may result in an incorrect installation of the accessory which could result in an unsafe riding condition and possible accident. If in any doubt always seek the help from your authorised Royal Enfield dealer.

WARNING: Before starting any accessory kit installation ensure the motorcycle is supported in a stable condition. Failure to support the motorcycle correctly could lead to motorcycle damage or personal injury.

WARNING: All fixings must be tightened to the torque values specified in this instruction. Failure to tighten fixings to the correct torque could result in an unsafe riding condition and possible accident.

CAUTION: Care should be taken when fitting any accessory kit. Incorrect handling kit components or the use of incorrect tools could lead to component or motorcycle damage.

NOTE: The content of this instruction is subject to change at any time without notice or liability. Royal Enfield reserves the right to revise the information presented at any time.

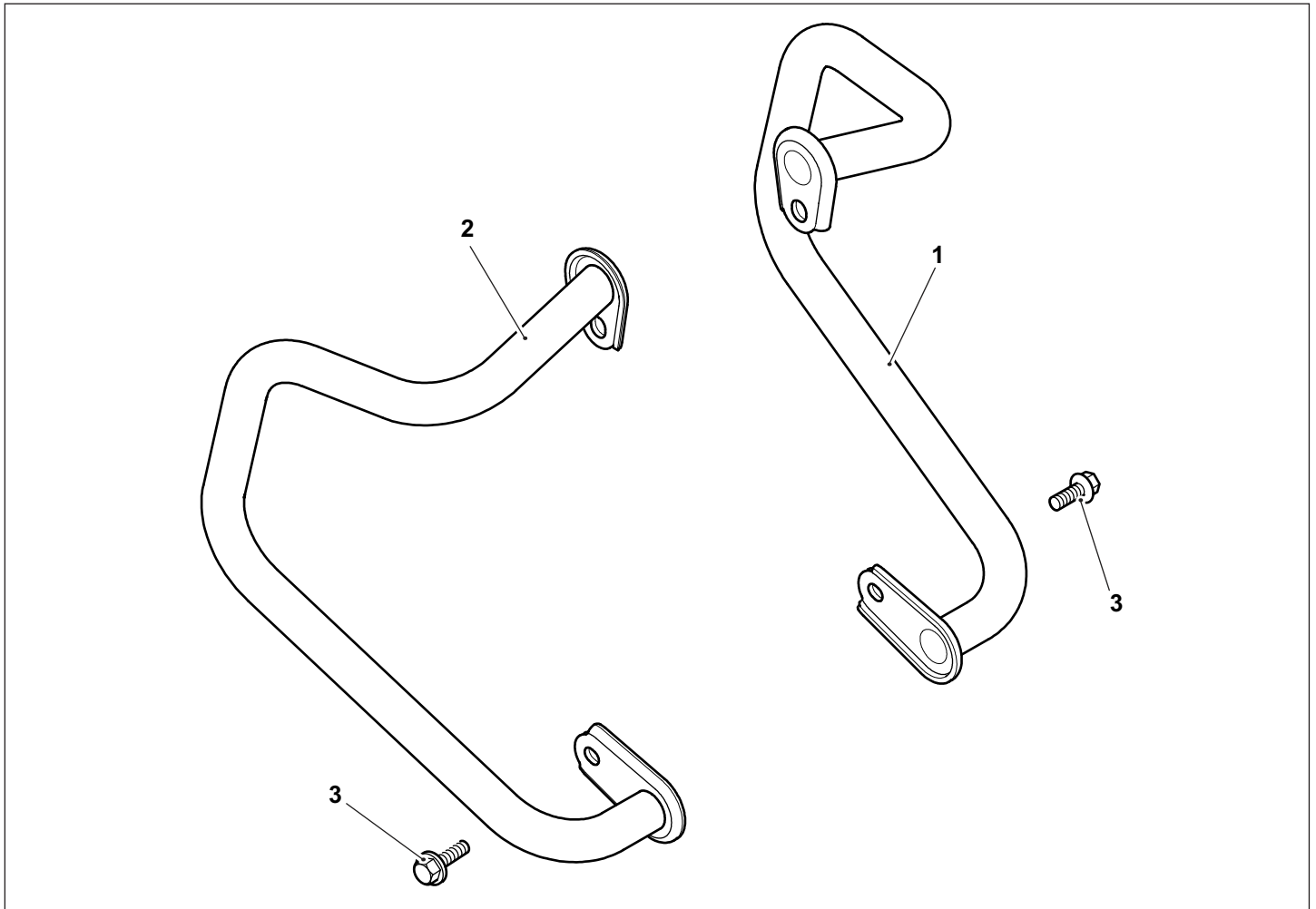

Item	Description	Qty
1	Engine guard assembly, right hand	1
2	Engine guard assembly, left hand	1
3	Fixing, M8 x 12mm	2



WARNING: If the engine has recently been running the exhaust system will be hot. Before working near to the exhaust system always allow time for the exhaust system to cool. Touching any part of a hot exhaust system will cause burn injuries.

1 Remove the top engine mounting fixing nut (1). Retain the nut for reuse.



13mm Bi-hexagonal socket with ratchet
17mm Spanner

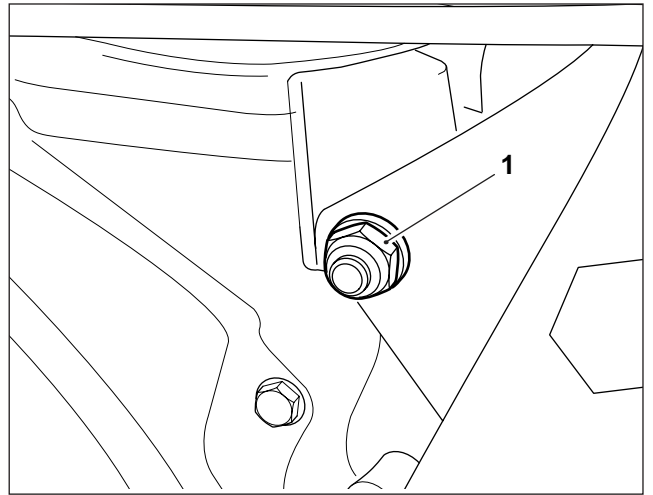

2 Remove the top engine mounting fixing (1). Retain the fixing for reuse.

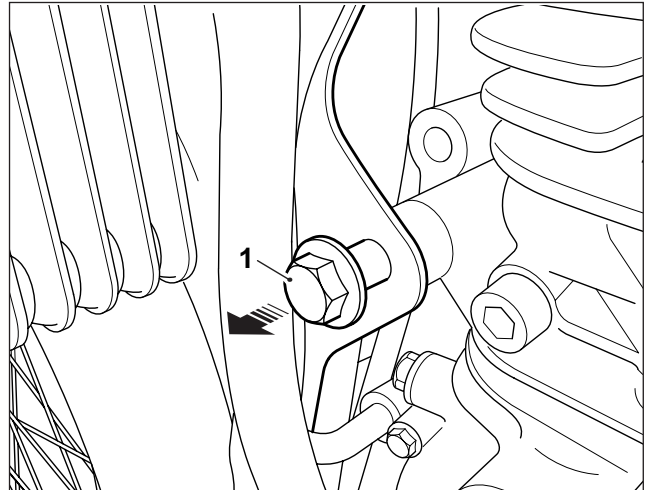

3 Align the top mounting of the left hand engine guard (1) with the top engine mounting location and refit the original fixing (2), as shown.

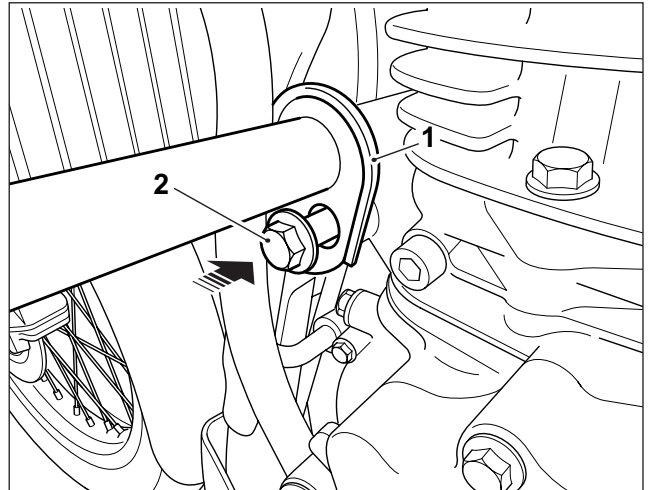

4 Align the bottom mounting of the engine guard (1) with the mounting point on the motorcycle frame (2), as shown. Fit an M8 x 12mm fixing (3) from the kit. Tighten the fixing to **16Nm**.



12mm Bi-hexagonal socket with torque wrench

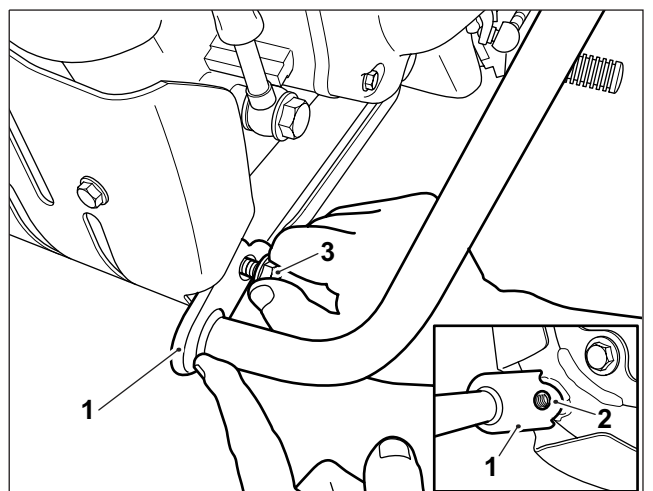

5 Fit the top mounting of the right hand engine guard (1) on to the engine mounting fixing and refit the original nut (2) as shown. Do not tighten the engine mounting fixing at this stage.

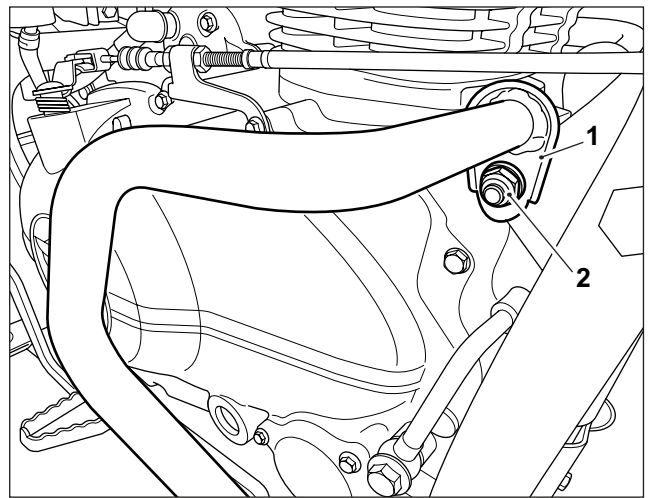

6 Align the bottom mounting of the engine bar (1) with the with the mounting point on the motorcycle frame (2). Fit an M8 x 12mm fixing (3) from the kit. Tighten the fixing to **16Nm**.

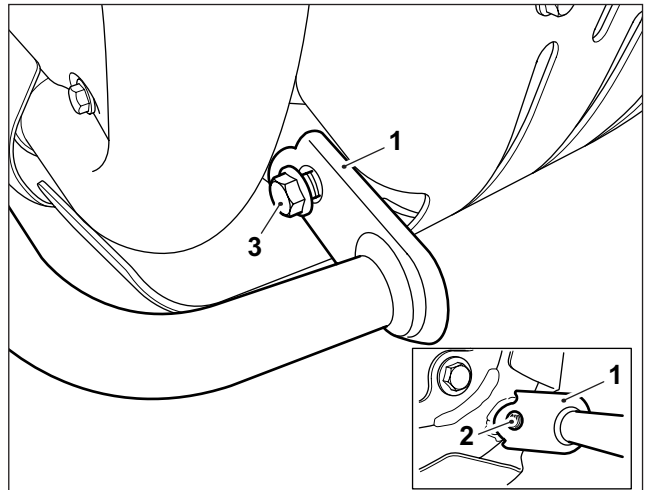

12mm Bi-hexagonal socket with torque wrench

7 While holding the the top engine mounting fixing nut on the right hand side of the motorcycle, tighten the top engine mounting fixing to **50Nm**.



13mm Bi-hexagonal socket with torque wrench
17mm Spanner

⚠ WARNING: After fitting any genuine Royal Enfield accessory always ride the motorcycle with caution and allow time to become familiar with any change in the motorcycle handling characteristics. Failure to become familiar with any change in the motorcycle handling characteristics may cause the motorcycle to become unstable and result in an accident.