

SETCON[®]

Driven by efficiency.

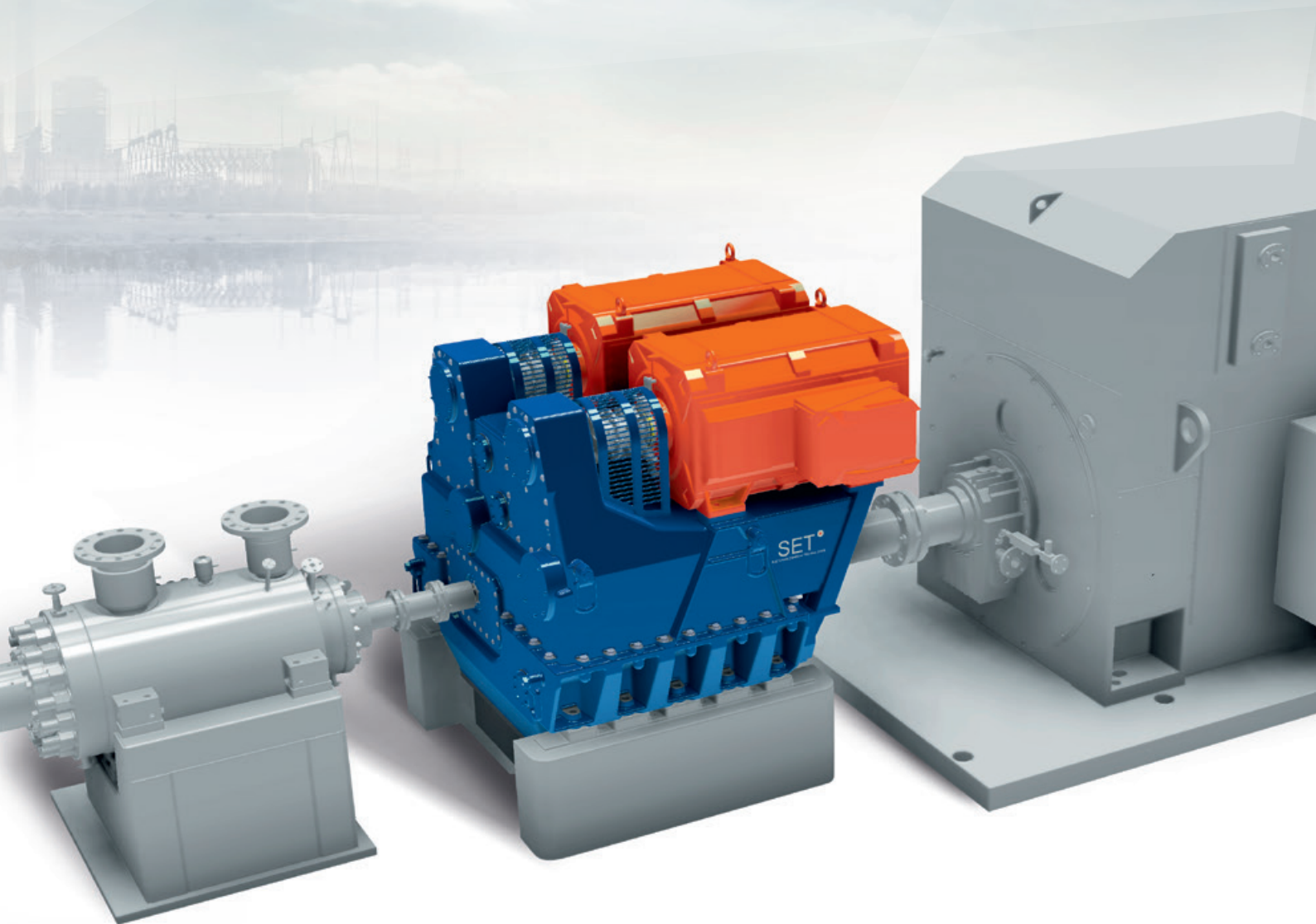

Variable-Speed Gearbox
for Industrial Applications.

SET[®]
SUSTAINABLE ENERGY TECHNOLOGIES



CONTENT

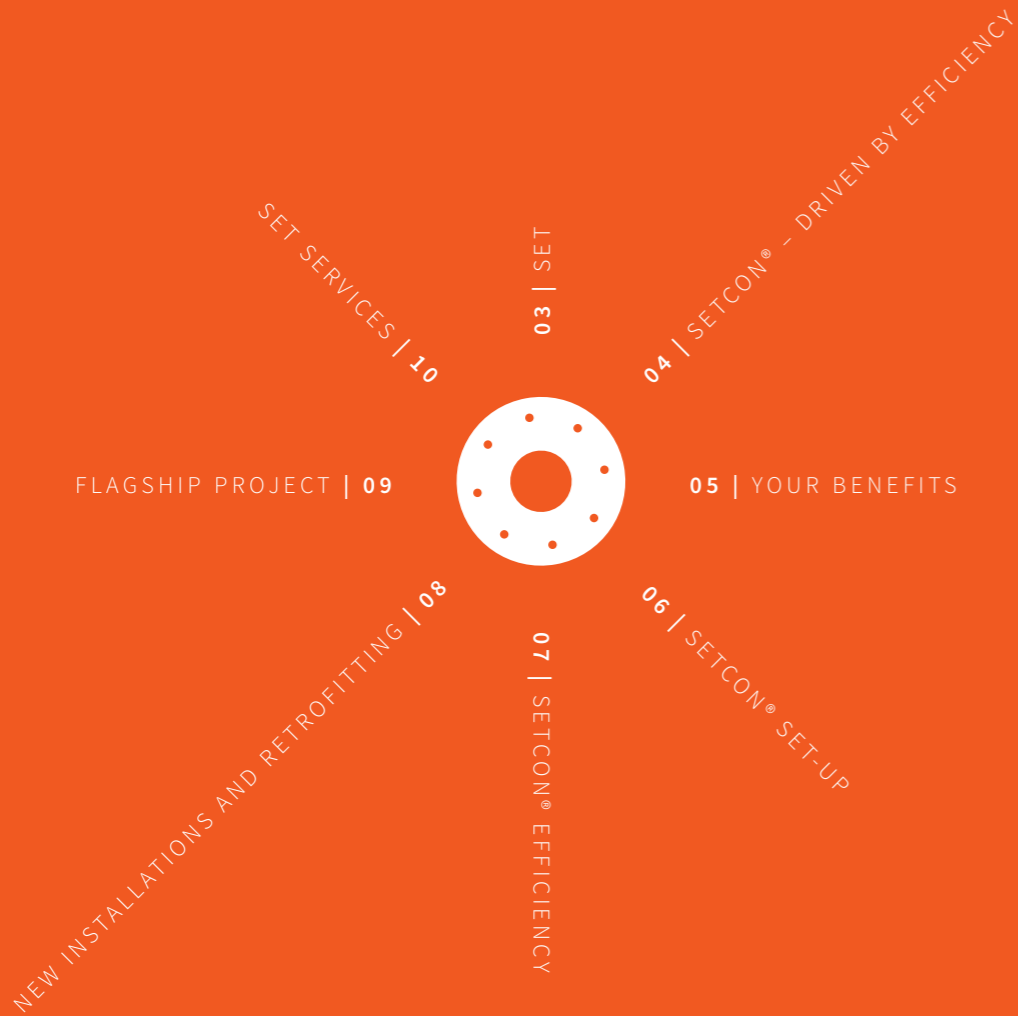

WWW.SET-SOLUTIONS.NET



SET^o

SMART SOLUTIONS FOR OUR ENVIRONMENT AND YOUR BENEFIT.

About SET – Based in Klagenfurt (Austria), SET is a global technology company which supplies innovative drive concepts to international customers in a wide range of industrial sectors, including Energy, Oil & Gas and Wind.

SET products are electro-mechanical differential systems designed to control speed in pumps, compressors, fans, blowers and WECs.

SET also provides professional and specialized engineering services for many business sectors around the world. The core competence of SET is the symbiosis of comprehensive technical expertise, from electrical engineering to analytical calculation and from concept to manufacturing.

Driven by efficiency.

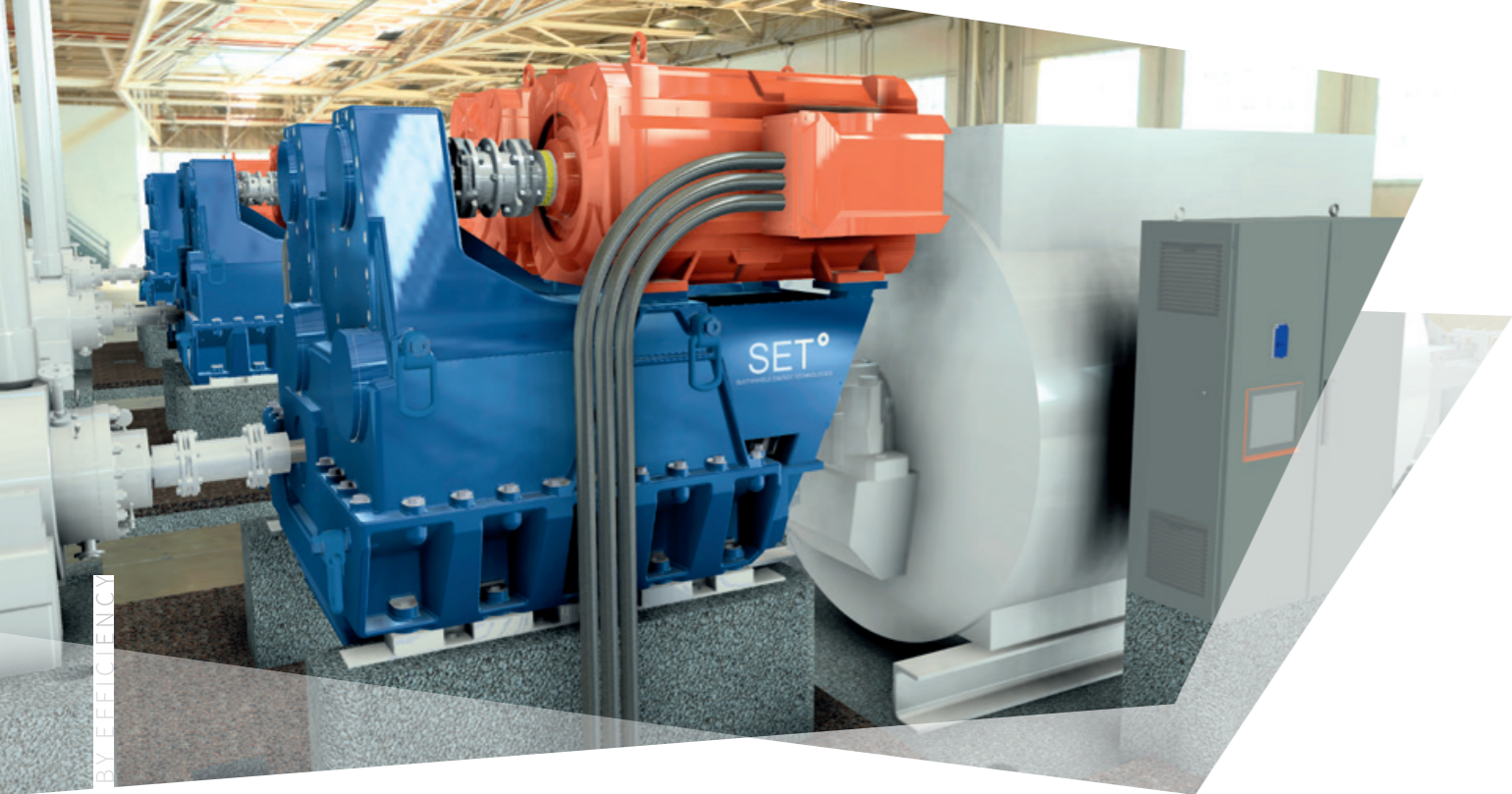

SETCON® - DRIVEN BY EFFICIENCY

04

SETCON® – THE ALL-IN-ONE SOLUTION



SETCON® – DRIVEN BY EFFICIENCY

SETCON® is an **electro-mechanical variable-speed gearbox** designed to control speed in pumps, compressors, fans and blowers. With up to 97% overall efficiency, SETCON® is the most efficient variable-speed drive technology for your application and pioneering in terms of reliability.

SETCON® combines all the benefits of conventional drive technologies, delivering high efficiency, minimal footprint and maximum reliability as a result.

YOUR BENEFITS

97%

SYSTEM EFFICIENCY

The most efficient **variable-speed** system with low investment costs.

100%

OUTSTANDING PERFORMANCE

Our patented technology solutions can **reduce downtime** to an absolute minimum.

100%

EASY INTEGRATION

A unique platform means SETCON® can be **easily integrated** into existing drive trains for retrofits. Due to the small frame and package size, modification or replacement of the Main Drive and Driven Machine is usually not necessary.

100%

FLEXIBILITY

A “Soft Start” mode **reduces the inrush currents** of the Main Drive and provides a continuous working speed range from 20 to 100%.

YOUR BENEFITS

05

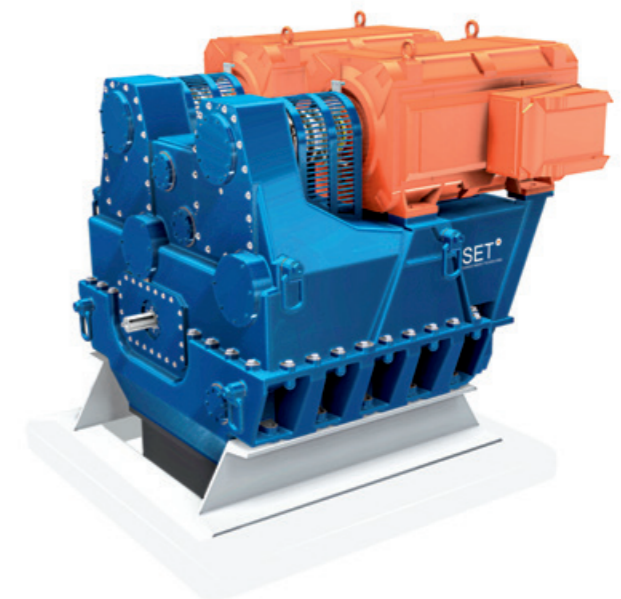

SETCON® CONTROL CHARACTERISTICS

OPERATING POWER LIMITS

Output shaft Main Drive

Input shaft Driven Machine

Control range (incl. optional “Soft Start”)

4,000 KW TO 15,000 KW*

Constant Speed

Variable Speed up to 15,000 rpm

20% – 100% of Rated Speed

(*higher power optional)

SETCON® SET-UP

The heart of the system is a **Gearbox (1)** using a planetary gear, which superimposes the constant speed of the **Main Drive (5)** to a variable speed at the **Driven Machine (6)**. The speed and power regulation are done by the frequency-controlled **Servos (2+3)** controlled by the **Control Cabinet incl. PLC (4)**.

In other words, the **Servos (2)** perform as both a motor (providing additional speed and power to the **Main Drive (5)**) and a generator (feeding excess energy from the Main Drive back into the grid). This means around 80% of the total power of the **Driven Machine (6)** comes from the **Main Drive (5)** and 20% from the Servos (2).

ENTIRE DRIVE TRAIN INCLUDING SETCON®

1. Gearbox incl. internal lubrication
2. Servos (ASM)
3. Low-voltage 4Q Frequency Converter (e.g. 690 V)
4. Control Cabinet incl. PLC
5. Medium-voltage Main Drive (e.g. 10 kV)
6. Driven Machine

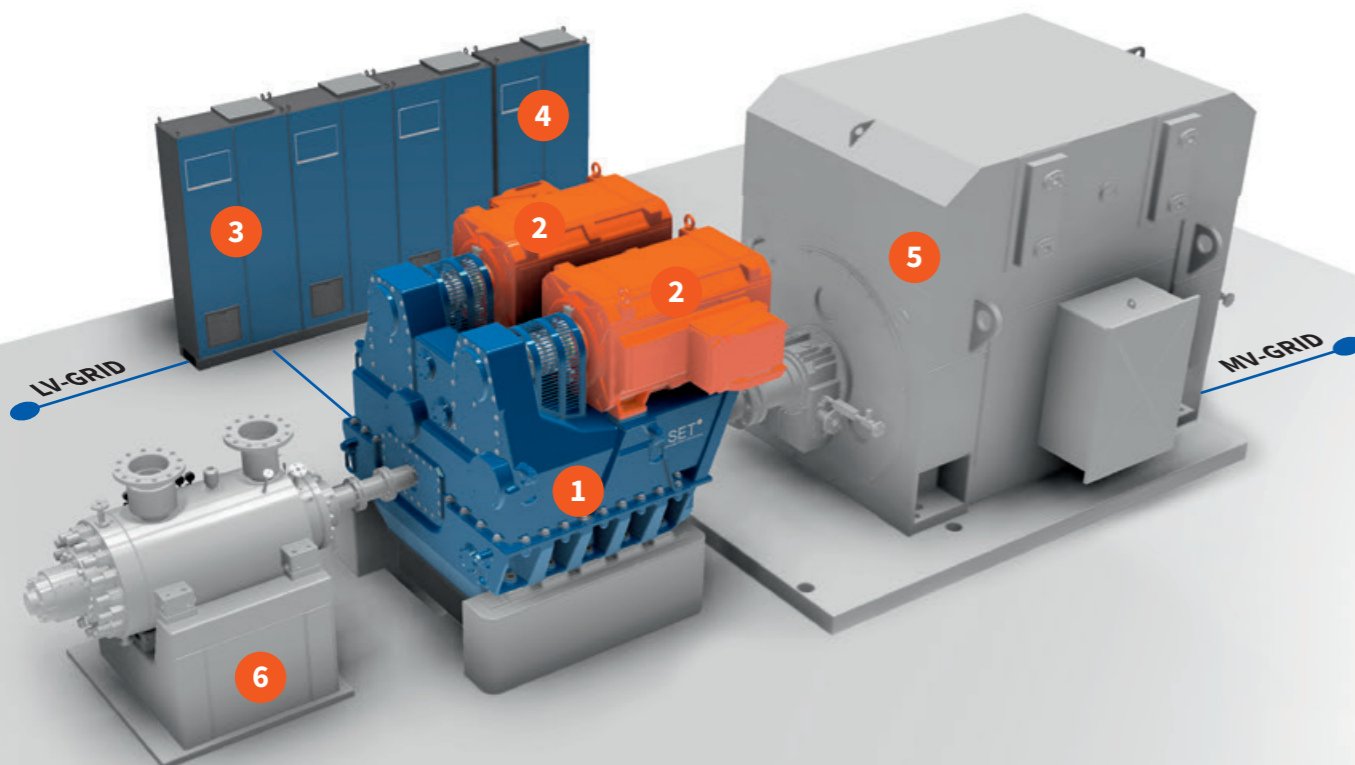

SETCON® EFFICIENCY

Compared to conventional solutions like Variable Frequency Drive (VFD), Hydro-dynamic Coupling (HDC) or Hydro-dynamic Variable-Speed Drive (HDVSD), **SETCON® produces energy efficiency which has never achieved before.** With an energy efficiency rate of up to 97%, SETCON® is the most efficient drive train concept currently on the market.

The combination of mainly mechanical power transmission and small, low-voltage electronic components results in **great performance and reliability.**

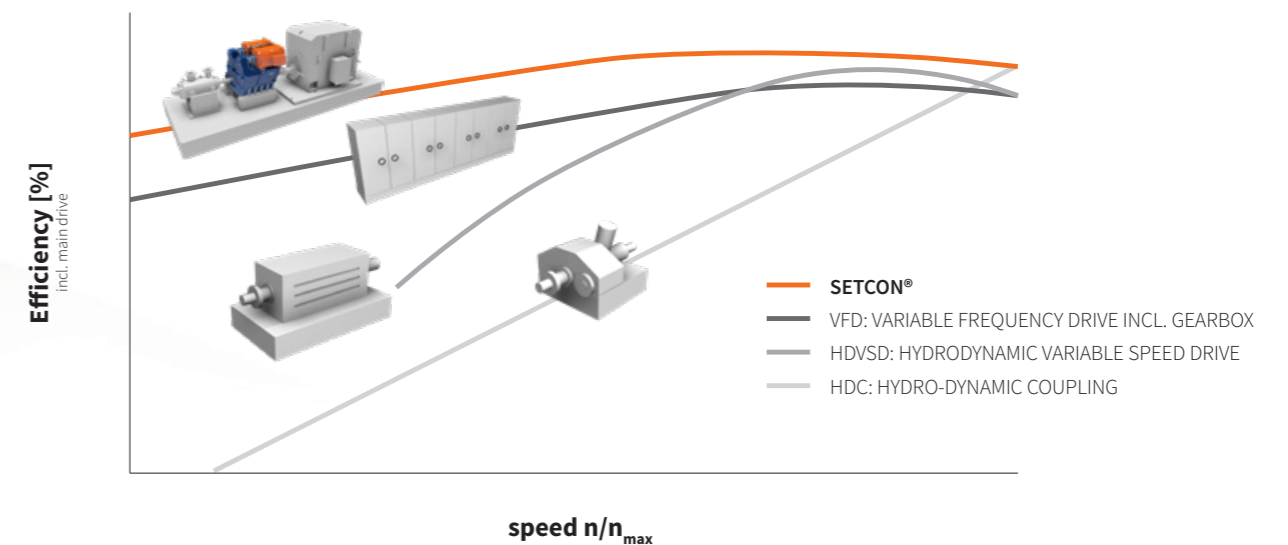

„SETCON® emerged as the best technology ahead of the competition thanks to its speed variability range, efficiency and robustness.“

NEW INSTALLATIONS

For constructing new drive systems, SETCON® represents **the best solution for high energy and cost savings**. The smaller package size, lower oil volume/oil cooling, reduced heat generation/air conditioning and simpler pipework result in lower investment costs.

The Main Drive can also be downsized by up to 20% of the total power rating, further reducing total project costs.

„Are you looking to replace existing drive systems directly without having to modify the main components?
No problem with SETCON®!“

TYPICAL AREAS OF APPLICATION

HYDRO-ELECTRIC POWER STATIONS
STEEL MILLS
POWER STATIONS
REFINERIES
OIL & GAS INDUSTRY

| | | | | | | |
|---------------------|--------------------|-------|-------|-------------|--------------------|--------------------|
| LOW SPEED | < 1,000 rpm | Pumps | Pumps | | | |
| MEDIUM SPEED | 1,000 – 4,000 rpm | Pumps | Pumps | Pumps, Fans | Pumps | Pumps |
| TURBO | 4,000 – 15,000 rpm | | Fans | Pumps, Fans | Pumps, Compressors | Pumps, Compressors |

RETROFITTING

For retrofits, in most cases SETCON® can be implemented into existing drive systems without repositioning the main components. By replacing a hydro-dynamic coupling, for instance, the Main Drive and the Driven Machine both remain in their original position. All mechatronic interfaces are ideally suited to replace existing drives.

SETCON® has the potential to **boost performance and ensure sustainable** and future-oriented operation.

SETCON® FLAGSHIP PROJECT IN GERMANY

SETCON®, a variable-speed gearbox, **points the way ahead for the entire industry sector**. SET has been awarded to install its electro-mechanical differential gear system (SETCON®) at a **power plant in Germany**. SETCON® replaces the existing Voith hydro dynamic coupling (HDC) in order to **meet future challenges** in terms of sustainability and life cycle costs. SETCON® emerged as the best technology ahead of the competition thanks to its matching footprint, high efficiency and robustness.

The installed system must provide a max. power of 6,500 kW for a boiler feed-water pump, which is **essential for the on-site processes**. In this flagship project the operating companies expect SETCON® to deliver **high cost savings, maximum reliability and increased efficiency**.

The **ROI** (return on investment) is assumed to be within a time period of up to 3 years.



6.5 MW SETCON® for a BFP (Power Plant in Germany)



Get in touch with us.

WE EVALUATE YOUR OPTIMIZATION NEEDS AND OFFER YOU A SETCON[®] SYSTEM TO MEET YOUR REQUIREMENTS.

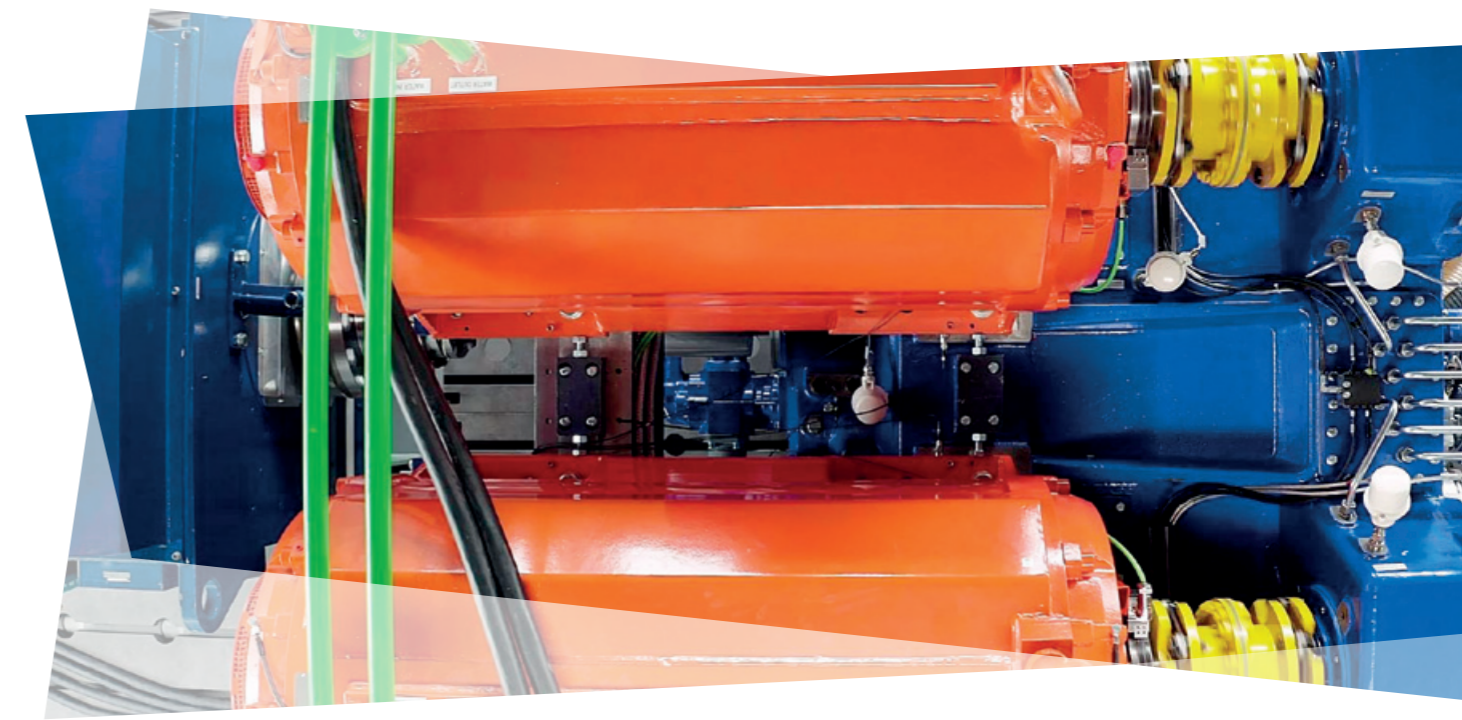

SETCON[®] – Variable-Speed Gearbox for Industrial Applications

SET SERVICES

SET offers a wide range of services to its customers around the world:

- **ANALYSIS AND CONSULTANCY**
 - Assessment of current situation and improvement analysis
 - Detailed calculation of economic efficiency
 - Detailing of complete SETCON[®] implementation process
 - Optimization of customized SETCON[®] concept
 - Validation of mechatronic interfaces at site
 - Automation customized to existing process control systems
- **INSTALLATION AND IMPLEMENTATION**
- **MAINTENANCE • ON-SITE SERVICE**
- **TECHNICAL TRAINING**

SET GmbH specializes in all kinds of electro-mechanical systems and provides services to the following industries:

Automotive *Cement* Chemicals & Petrochemicals *Construction*
Electronics *Hydropower* Metal *Mining* Oil & Gas *Paper* Power Plants
Rail Vehicles Recycling *Steel* and many more...





SET^o

SUSTAINABLE ENERGY TECHNOLOGIES

SET IS A TECHNOLOGY COMPANY DEDICATED TO PRODUCING VARIABLE-SPEED DRIVE SYSTEMS.

BASED ON INNOVATIVE ENGINEERING METHODS AND OVER 30 YEARS OF EXPERTISE IN DRIVE TECHNOLOGY, SET DEVELOPS AND MANUFACTURES ELECTRO-MECHANICAL DIFFERENTIAL DRIVES



SET GmbH
Sterneckstraße 19
9020 Klagenfurt am Wörthersee
AUSTRIA

P: +43 (0)5 089 88
E: sales@set-solutions.net
www.set-solutions.net



SMART SOLUTIONS
FOR OUR ENVIRONMENT
AND YOUR BENEFIT.