



2024 FRASER COAST AGRICULTURE SHOW

Show Theme:
Mary Meets Migaloo

SECTION 36:

LAPIDARY

Thursday & Friday 23rd & 24th May 2024

Section Sponsors:

Maryborough Gem & Mineral Society Inc.

Hart of Hair



MEETING TIMES:

Tuesdays 9:00am to 11:30am.
Wednesdays 7:00pm to 10:00pm.

We gratefully acknowledge the continuing sponsorship by Businesses and Individuals.

We are here:



MARYBOROUGH GEM & MINERAL SOC. INC.

P.O. BOX 860
MARYBOROUGH QLD 4650

Visitors are most welcome.
No experience needed.
Lapidary equipment on site.
Experienced tutors available.
Create your own beautiful Cabachons, Faceted Jewels or Silver Jewellery.

**For more information
Call 0408 061 724**

MEETING TIMES:

Tuesdays 9:00am to 11:30am.
Wednesdays 7:00pm to 10:00pm.

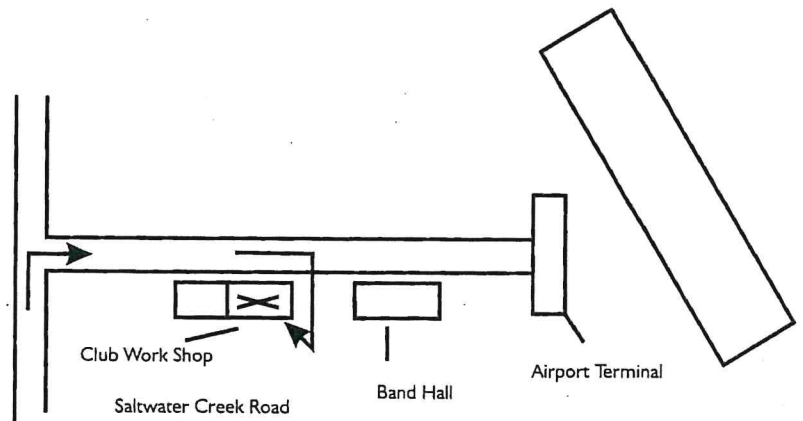

Queensland
Government
Department of
Infrastructure Local
Government and
Planning

GENERAL REGULATIONS

(For the conduct of competitions at Queensland Ag Shows affiliated Queensland Agricultural Shows)

Subject to the Rules, By-Laws and Regulations of the Queensland Chamber of Agricultural Society's Inc. (Queensland Ag Shows) and the society relevant to this schedule (Fraser Coast Agriculture Show Society Inc.), the following regulations shall apply. Where there is a conflict between these regulations and the regulations and the rules of the local Agricultural Society, (Fraser Coast Agriculture Show Society Inc.), the rules of the Affiliated Agricultural Society prevail.

GENERAL REGULATIONS AND ACCEPTANCE OF ENTRIES

1. The attention of Exhibitors is drawn to the fact that entries are accepted subject to the Rules, By-Laws and Regulations of the Queensland Ag Shows and the Fraser Coast Agriculture Show Society Inc. in addition to any Special Regulations which appear in this schedule. Copies of the Rules and By-Laws may be obtained the Queensland Ag Shows website www.queenslandshows.com.au/competitions or the show society relevant to this schedule (Fraser Coast Agriculture Show Society Inc.)
2. These By-Laws and Regulations, together with Special Regulations and notes as set forth in the respective sections of the Competition Schedules or Catalogues, are to be the conditions of competition. In these By-Laws, the Regulations, the Special Regulations and notes the words "entry form" shall, unless the context otherwise indicates or requires mean the form supplied by the Show to persons desiring to apply to enter an Exhibit in any of the Show's competitions or to compete in any event which those persons are required to complete and lodge with the Show in order to apply to do so.
3. Subject to this by-Law and to any Regulation, Special Regulation or condition of Entry in any section or class (a) An Exhibit must be the bona fide property of the person who enters the Exhibit or class.
4. In any class in which entries are accepted from a club or other groups of Owners, the name of the club or particulars sufficient to identify the group shall be stated on the Entry Form together with a statement of the name and address of a person who is authorised to act on behalf of the club or group in relations to all matters relating to the entry. The Show shall be entitled to deal with the person so authorised as if he were the sole Owner of the Exhibit and delivery or payment to that person or the club or group by whom such person is authorised to act of any trophy prize or moneys won by or payable in respect of the Exhibit shall be a complete discharge to the Show.
5. Entries entered in the wrong class by the Exhibitor/Competitor may be transferred to the proper class by the Chief Stewards.
6. In the case of insufficient numbers being nominated or shown in any class, the society retains the right suspend classes at any time. The section Chief Steward retains the right to reduce prize money where classes are not sufficiently patronised.
7. **The Fraser Coast Agriculture Show Society Inc. is operating under the Queensland Ag Shows and the Maryborough Showgrounds & Equestrian Park covid safe plan. You must adhere to COVID safe key principles that apply to Maryborough Showgrounds & Equestrian Park and the Fraser Coast Agriculture Show Society Inc.**

JUDGING

8. Judging will be performed by a Judge or panel of Judges appointed by the Fraser Coast Agriculture Show Society Inc.
9. In all affiliated Agricultural Show Sections, Judges should not judge the same section within a two (2) year period of the same show.
10. An exhibitor shall not compete in a section if the Exhibitor is a member of the Judge's immediate family.
11. Any person causing a nuisance by loud comments, or the decision of the judge or otherwise unseemly behaviour will, after being cautioned, be expelled from the judging area and in the case of exhibitors, be liable for disqualification.
12. All Judges and Stewards who accept engagements with Queensland Ag Shows and Show Societies must follow the rules set in the Code of Practice and Conduct – Show Judges and Stewards document obtained from the Qld Ag Shows website www.queenslandshows/competitions or the show society relevant to this schedule (Fraser Coast Agriculture Show Society Inc.)

NOTICE TO INTENDING EXHIBITORS

13. Entries for the upcoming Fraser Coast Agriculture Show can be made as described for each section in this schedule. Entries submitted other than on the correct form or online will be returned to the Exhibitor and, unless all requirements are complied with, and the forms returned to the Fraser Coast Agriculture Show office by completion of business on the closing date, as shown in this Schedule, they will not be considered.
14. Notwithstanding the provisions of General Regulation 6, late entries may be accepted at the discretion of the Section Chief Steward.
15. Entries are accepted subject to the Rules, By-Laws and Regulations of the Society, in addition to any Special Regulations, which appear in the Schedule. All completed Entry Forms remain the property of the Fraser Coast Agriculture Show Society Inc. and are to be returned to the Fraser Coast Agriculture Show Society Inc. office after the Show for further office procedures as required.
16. Exhibitors whose entries have not been accepted shall be advised accordingly and entry fees refunded.
17. The Exhibitor must complete the Exhibitor's Declaration on the Application for Entry. Queensland Ag Shows recommends that the Exhibitor seeks professional advice before completing the Exhibitor Declaration.
18. The exhibitor irrevocably consents to the Society publishing or reproducing in any manner whatsoever any particulars or information in relation to their exhibits; the publication or reproduction may be in a printed form or visual image through electronic means and/or on the internet. **See Over**

PRIVACY STATEMENT

19 The information provided by Exhibitors is used by the Queensland Ag Shows and the Fraser Coast Agriculture Show Society Inc. to organise, process and conduct competitions at the relevant agricultural show (Fraser Coast Agriculture Show), sub chamber and state finals. By entering such competitions, you consent to your personal information being used for this purpose including this information being made available to sponsors, breed Associations, the media, the public, promotional purposes, archival purposes, published in publications and could be made available to other third parties for the purpose of promoting the Queensland Agricultural Show movement, or as otherwise required by law. Queensland Ag Shows and the Fraser Coast Agriculture Show Society Inc. have the right to take or use photographs of exhibits or exhibitors (and or property) and use photos in any or all marketing and media worldwide including online, now and in the future. Exhibitors have a right of access to and alteration of personal information concerning themselves in terms of the Privacy Act. This may be done by contacting Queensland Ag Shows.

WORKPLACE HEALTH AND SAFETY

- 20 All Queensland Ag Shows affiliated Society's Showground's are designated workplaces within the meaning of the Workplace Health and Safety Act 2011 and exhibitors / competitors are required to ensure that they and all persons under their direction or control, including their contractors or subcontractors, comply with all requirements of the Act and Queensland Ag Shows holds each exhibitor responsible to discharge its obligations to provide and maintain a safe place and system of work during occupation by the exhibitor/competitor of any area of the affiliated Agricultural Society's Showground's.
- 21 Each exhibitor/competitor will assess the risk to themselves, staff, volunteers, family, other exhibitors, Agricultural Society staff, show visitors, children and any person foreseeably affected by the presentation of their exhibit.
- 22 Risks identified by exhibitors/competitors will be eliminated or controlled by the exhibitor/competitor and particular attention will be paid to ensuring public safety and safety of other exhibitors/competitors.
- 23 Exhibits will only be held and handled by competent persons whose experience is known to the Exhibitor/Competitor.
- 24 A "No Smoking Policy" will be strictly adhered to by exhibitors/competitors. Smoking areas are marked in "ORANGE MARKINGS/FLAGS" which are located near the Cane & Cattleman's Bar & far end of Working Heritage display.. No food or drink is allowed in the smoking area. The exhibitors/competitors are advised that the use of Primus stoves, any heating or lighting appliances of a like character, or any naked light, is strictly prohibited in pavilions.
- 25 Any exhibitors/competitors intending to bring electrical equipment to the Showground's will be required to ensure that such equipment is fitted with earth leakage circuit breakers/residual current protection and that all electrical leads, tools and appliances have been inspected by a licensed electrical contractor and currently tagged. The use of double adaptors is prohibited as well as all power boards must also be tested and tagged. This is essential for the safety of all exhibitors and the general public and is a requirement of the current Electrical Safety Regulations.
- 26 All exhibitors/competitors will comply with the requirements of the Act and its Regulations and Standards in every other respect. This is essential for the safety of all exhibitors/competitors and the general public. The Act imposes very severe penalties in the event of noncompliance with its provisions. Any exhibitors/competitors who do not comply will not be allowed to exhibit at QCAS affiliated Shows.

DISCLAIMER

27 The information contained in the Competitions Schedule is gathered for the purpose of providing information to Exhibitors and show patrons. The information is a compilation of information provided by third parties and the QCAS. and affiliated Agricultural Society's does not warrant its accuracy and advises that any such information may be subject to change or amendment occurring at any time and thereby making the information incorrect. Subject to the QCAS legal obligations and responsibilities if you require confirmation of any information, please contact the QCAS Office.

PRIZES AND GST

- 28 The Australian Taxation Office has deemed that GST is payable on prizes if an Exhibitor is registered for GST and enters an Exhibit as part of a business enterprise.
- 29 The information an Exhibitor provides on the Application for Entry determines whether GST is applicable.
- 30 Any prize stated in this Schedule does not include GST.
- 31 GST will not apply:
- (a) If an Exhibitor enters an Exhibit as a hobby or private recreational pursuit; or
 - (b) If an Exhibitor enters an Exhibit as part of a business enterprise, the Exhibitor has an ABN, but the Exhibitor is NOT REGISTERED for GST.
 - (c) If an Exhibitor enters an Exhibit as part of a business enterprise, the Exhibitor is not entitled to an ABN as the business or enterprise is not operating in Australia.
- 32 GST will apply if an Exhibitor enters an Exhibit as part of a business enterprise, the Exhibitor has an ABN, and the Exhibitor is REGISTERED for GST.
- 33 Where GST applies, the Society will pay the prize money quoted in this Schedule plus 10% GST. The Society will issue a recipient created tax invoice.
34. All cash prizes, sashes, cards and trophies etc. must be claimed within 4 weeks from the closing date of the show. Prizes not claimed will become a donation to the Fraser Coast Agriculture Show Society.

SECTION 36: LAPIDARY

Thursday & Friday 23rd & 24th May 2024

THANKS TO OUR SPONSORS:

Maryborough Gem & Mineral Society Inc.
Hart of Hair

Chief Steward – Carmel House
0448061737

Stewards:

Barry House - 0408061724
Selina House

Judges: Members affiliated with the Australian Federation of Lapidary and Allied Craft Association Inc. and judged according to the AFLACA Rule Book No. 8.

Section Conditions:

- **Entries close 3:30 pm on the 24th April 2024.** All entries to be submitted to Maryborough Gem Club – Frank Lawrence Circuit (Airport Drive) or sent to PO Box 860 before the 24th April 2024.
- **No late entries accepted at Show Office.**
- The Lapidary diagrams are 36008B, 36008B1, 36009A2, 36009B1, 36010A1, 36010A2 and 36011 and are attached for reference.
- Schedules are available on FCASS website www.frasercoastagshow or Show Office - 84 Gympie Road Tinana. 9am - 3pm Tuesday & Thursday only.
- All faceted stones must be submitted in a suitable box for display (circumference or square 28mm).
- Judging will be according to the rules and regulations as set down in the Judging Manual No.8, and will be carried out on **Saturday 11th May 2024**. Judges decision is final.

Exhibitors have the right to make 3 entries in any class.

- Exhibits are to remain on display in Pavilion 3 until 8.00pm Friday 24th May 2024

- Entries will be returned by prepaid post or prior arrangement/s made with Chief Steward.

Entry Fees:

\$1.00 per entry (incl. GST)
Prizes, Cards and Cash

Prizes:	1st	2nd	3rd
	\$8	\$5	\$3

CHAMPIONSHIPS:

Champion Open: \$25 and Sash

Champion Novice: \$10 and Sash

Most Points Lapidary:

Ron and Jean Woodhouse Perpetual Memorial Trophy plus personal trophy donated by the Maryborough Gem & Mineral Society Inc and Sash.

PRESIDENT'S ENCOURAGEMENT AWARD:

Chosen from all classes by the Fraser Coast Agriculture Show President or nominated representative.

Each faceted stone must be submitted in a suitable box for display. Both sides of the entry sheet needs to be filled out and placed in with entries.

NOVICE:

CLASS 36001AN STANDARD CABOCHON – CRAFTMANSHIP

Minimum size 15mm on short axis

OPEN:

CLASS 36001A – STANDARD CABOCHON – CRAFTMANSHIP

Minimum size 15mm on short axis

CLASS 36002 – FANCY CABOCHON – CRAFTMANSHIP

(Minimum size 15mm on short axis)

CLASS 36003 – FREEFORM – CRAFTMANSHIP

Minimum size 10mm hole, maximum 50mm long axis

NOVICE:

CLASS 36008B1 – FACETING – STANDARD ROUND BRILLIANT FACETED GIRDLE

Exactly 8mm (See diagram) cut in coloured Cubic Zirconia.

CLASS 36009A2 – FACETING – OBLONG STEP CUT

(Cut corners minimum 6mm short axis) Cut in coloured Cubic Zirconia.

CLASS 36010A2 – FACETING MODIFIED STANDARD

Minimum 6mm (see diagram) novimmx cut in quartz.

OPEN:

CLASS 36008B – FACETING – STANDARD ROUND BRILLIANT FACETED GIRDLE

Specified 8mm (See diagram) cut in coloured quartz.

CLASS 36009B1 – STANDARD SQUARE STEP CUT WITH CORNERS

Cut in quartz (See diagram)

CLASS 36010A1 – FACETED MODIFIED STAND

Cut minimum 6mm (See diagram) Feline Amulet cut in quartz

CLASS 36011 – FACET – FANCY CUT

Minimum 6mm Four Star Cut (See diagram) cut in quartz

CLASS 36012 – FLATFACE – POLISHED SPECIMEN

Three different varieties. Minimum size 30mm not to pass 15mm hole

CLASS 36013 – FLATFACE – POLISHED SPECIMEN

Minimum 50mm maximum 150mm

CLASS 36017 – NOVELTY GEM CRAFT

Minimum 50mm excluding base – 300mm including base

CLASS 36018A – HAND FABRICATED JEWELLERY

NOT intended to include fossil, lapidary or mineral items

CLASS 36018B – HAND FABRICATED JEWELLERY

To include fossils, lapidary or mineral items

CLASS 36018C – HAND FABRICATED JEWELLERY

With commercial items

CLASS 36018D – HAND FABRICATED JEWELLERY

With item cut and set by entrant

CLASS 36019ASC – CAST ITEM – NOT DROP

Any mould **NOT** to include fossil, lapidary or mineral items

CLASS 36020ASC – CAST ITEM – NOT DROP

Any mould **TO INCLUDE** fossil, lapidary or mineral items

CLASS 36032A1 – NATURAL AUSTRALIAN FOSSIL

As per page 101 Judging Manual No. 8

CLASS 36034 – AUSTRALIAN MINERAL

Labelled in accordance with Fleischer's Glossary of Minerals

FRASER COAST SHOW 2024

Section 36 – Lapidary Standard Round Brilliant Faceted Girdle – Novice 36008B1

To be cut in Cubic Zirconia

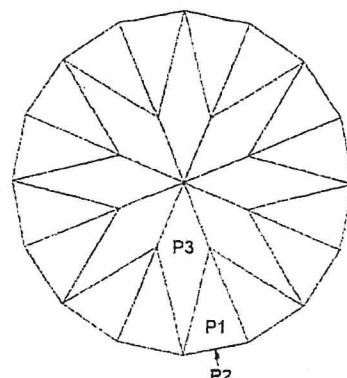
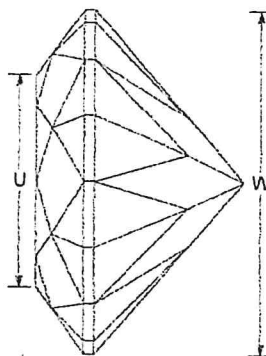
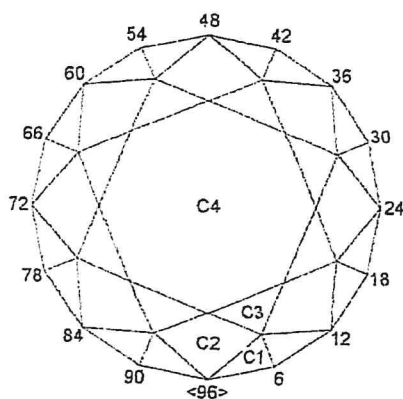

Standard Round Brilliant - Faceted Girdle

for Cubic Zirconia

Angles for R.I. = 2.160

57 + 16 girdles = 73 facets

8-fold, mirror-image symmetry

96 index

L/W = 1.000 T/W = 0.618 U/W = 0.618

P/W = 0.435 C/W = 0.139

Vol./W³ = 0.211

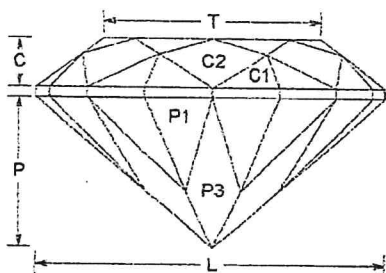

PAVILION

P1	43.00°	03-09-15-21-27-33-39-45-51-57-63-69-75-81-87-93	Cut to T.C.P.
P2	90.00°	03-09-15-21-27-33-39-45-51-57-63-69-75-81-87-93	Establish Stone Width.
P3	41.00°	96-12-24-36-48-60-72-84	Meet P1, P1 at Girdle

CROWN

C1	44.00°	03-09-15-21-27-33-39-45-51-57-63-69-75-81-87-93	Establish Girdle Width
C2	36.00°	96-12-24-36-48-60-72-84	Meet C1, C1 at Girdle.
C3	21.00°	06-18-30-42-54-66-78-90	Meet C1, C2, C1.
C4	0.00°	Table	Meet C3, C2, C3.

FRASER COAST SHOW 2024

Section 36 – Lapidary Standard Oblong Step cut with Cut Corners – Novice 36009A2

To be cut in Cubic Zirconia

60 48 36

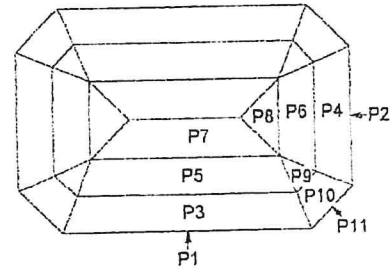
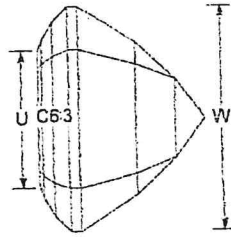
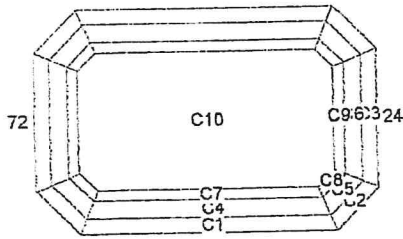

84 <96> 12

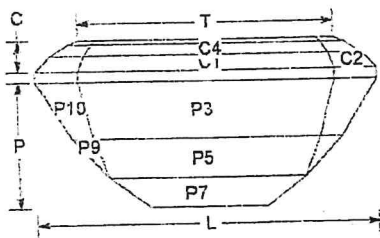

Standard Oblong Step Cut with Cut Corners

for Cubic Zirconia.

Angles for R.I. = 2.160

45 + 8 girdles = 53 facets

2-fold, mirror-image symmetry

96 index

$L/W = 1.500$ $T/W = 1.112$ $U/W = 0.612$

$P/W = 0.562$ $C/W = 0.135$

$Vol./W^3 = 0.600$

PAVILION

P1	90.00°	96-48	Set Width
P2	90.00°	24-72	Set Length
P3	57.45°	96-48	Locate girdle
P4	57.45°	24-72	Level girdle
P5	47.00°	96-48	Judge depth by eye one third
P6	47.00°	24-72	
P7	37.05°	96-48	Judge depth by eye one third.
P8	37.05°	24-72	
P9	47.00°	12-36-60-84	Cut corner to meet P5 & P6
P10	57.45°	12-36-60-84	Cut corner
P11	90.00°	12-36-60-84	Level girdle

CROWN

C1	45.00°	96-48	Set girdle width
C2	45.00°	12-36-60-84	Level girdle.
C3	45.00°	24-72	Level girdle.
C4	32.00°	96-48	judge height by eye
C5	32.00°	12-36-60-84	
C6	32.00°	24-72	
C7	19.84°	96-48	Cut as required
C8	19.84°	12-36-60-84	
C9	19.84°	24-72	
C10	0.00°	Table	Judge table height by eye.

FRASER COAST SHOW 2024

Section 36 – Lapidary Modified Standard – Novice 36010A2

To be cut in Quartz

Facets: 41 + 16 Girdle = 57 (Crown = 17 Pavilion = 24)

Meets: 41 (Crown = 24 Pavilion = 17)

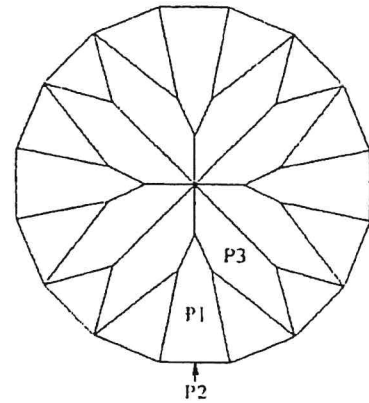
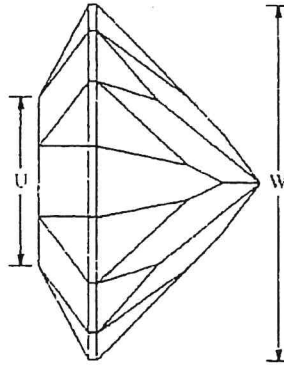
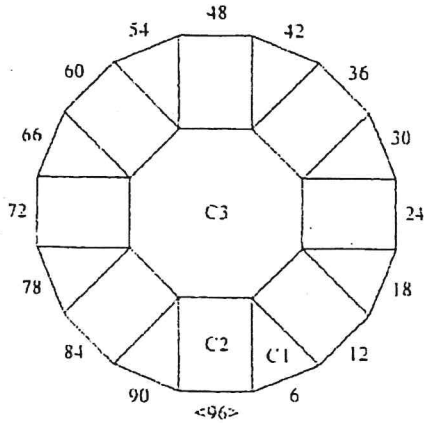

NOVIMMX

Author Jeff Ford

Angles for R.I. = 1.540

41 ÷ 16 girdles = 57 facets

8-fold, mirror-image symmetry

96 index

L/W = 1.000 T/W = 0.474 U/W = 0.474

P/W = 0.459 C/W = 0.140

Vol./W³ = 0.209

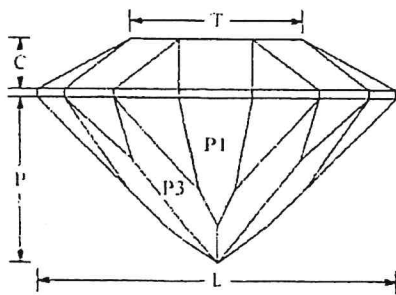

PAVILION

P1	44.50°	96-06-12-18-24-30-36-42-48-54-60-66-72-78-84-90	Cut to TCP
P2	90.00°	96-06-12-18-24-30-36-42-48-54-60-66-72-78-84-90	Size and shape stone
P3	42.00°	09-15-33-39-57-63-81-87	Meet P1 and Form PCP

CROWN

C1	30.00°	06-18-30-42-54-66-78-90	Set girdle thickness
C2	28.12°	96-12-24-36-48-60-72-84	Level girdle
C3	0.00°	Table	Meet C1-C2

FRASER COAST SHOW 2024

Section 36 – Lapidary Standard Round Brilliant Faceted Girdle – Open 36008B

To be cut in Coloured Quartz (8mm)

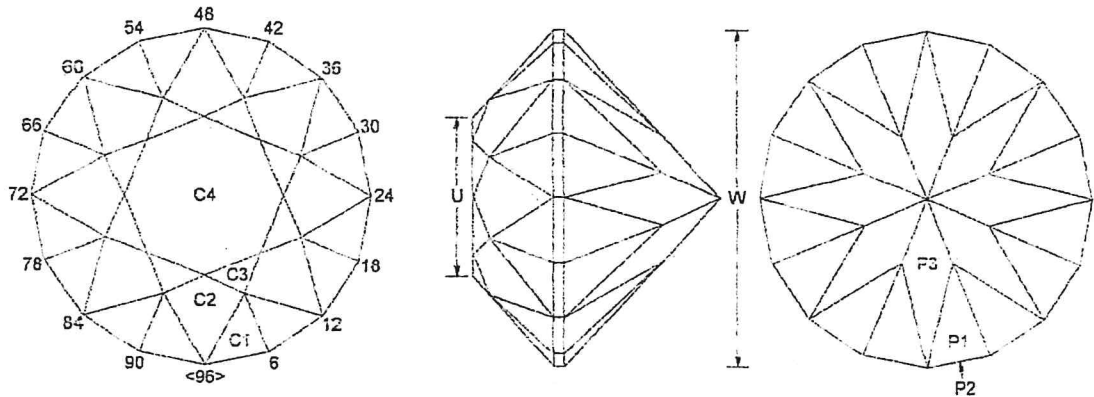

Standard Round Brilliant - Faceted Girdle

for Coloured Quartz

Angles for R.I. = 1.540

57 + 16 girdles = 73 facets

8-fold, mirror-image symmetry

96 index

L/W = 1.000 T/W = 0.470 U/W = 0.470

P/W = 0.466 C/W = 0.238

Vol./W³ = 0.253

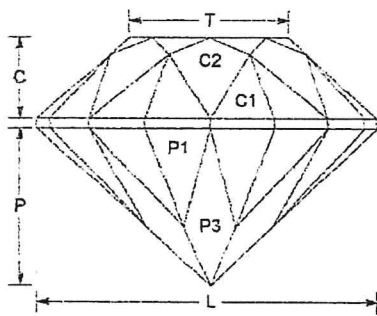

PAVILION

P1	45.00°	03-09-15-21-27-33-39-45-51-57-63-69-75-81-87-93	Cut to T.C.P.
P2	90.00°	03-09-15-21-27-33-39-45-51-57-63-69-75-81-87-93	Establish Stone Width.
P3	43.00°	96-12-24-36-48-60-72-84	Meet P1, P1 at Girdle.

CROWN

C1	46.00°	03-09-15-21-27-33-39-45-51-57-63-69-75-81-87-93	Establish Girdle Width.
C2	42.00°	96-12-24-36-48-60-72-84	Meet C1, C1 at Girdle.
C3	27.00°	06-18-30-42-54-66-78-90	Meet C1, C2, C1.
C4	0.00°	Table	Meet C3, C2, C3.

FRASER COAST SHOW 2024

Section 36 – Lapidary Standard Square Step cut with Cut Corners – Open 36009B1

To be cut in Quartz

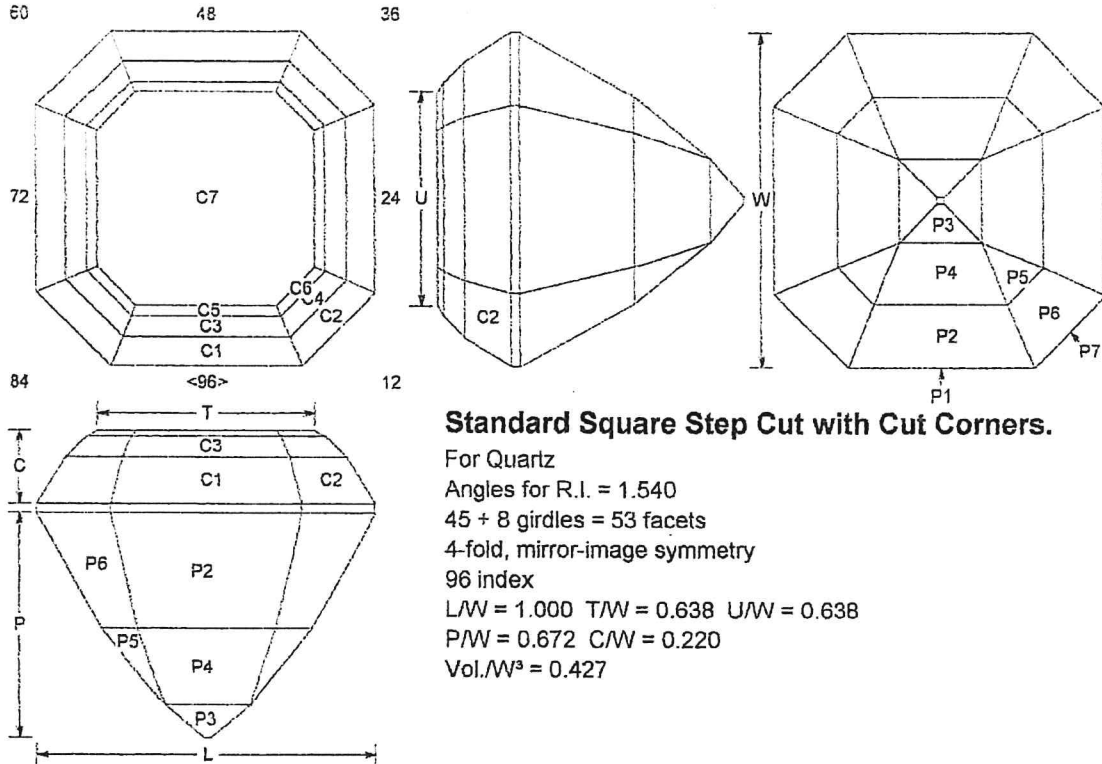

Standard Square Step Cut with Cut Corners.

For Quartz
 Angles for R.I. = 1.540
 45 + 8 girdles = 53 facets
 4-fold, mirror-image symmetry
 96 index
 $L/W = 1.000$ $T/W = 0.638$ $U/W = 0.638$
 $P/W = 0.672$ $C/W = 0.220$
 $Vol./W^3 = 0.427$

PAVILION

P1	90.00°	96-24-48-72
P2	61.00°	96-24-48-72
P3	41.00°	96-24-48-72
P4	51.00°	96-24-48-72
P5	51.00°	12-36-60-84
P6	61.00°	12-36-60-84
P7	90.00°	12-36-60-84

CROWN

C1	58.00°	96-24-48-72
C2	58.00°	12-36-60-84
C3	45.00°	96-24-48-72
C4	45.00°	12-36-60-84
C5	30.00°	96-24-48-72
C6	30.00°	12-36-60-84
C7	0.00°	Table

FRASER COAST SHOW 2024

Section 36 – Lapidary Modified Standard – Open 36010A1

To be cut in Quartz

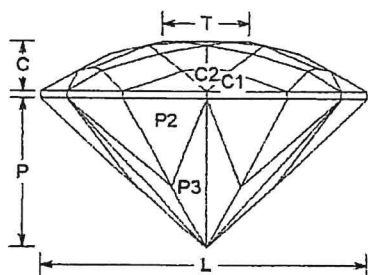
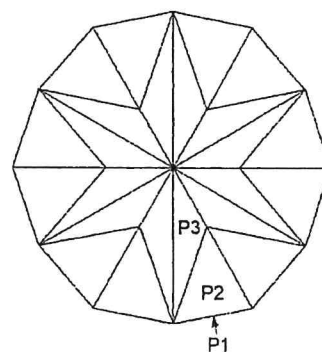
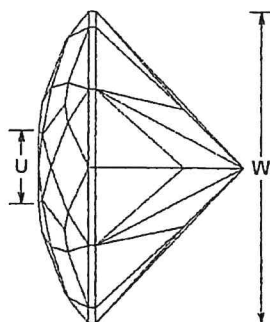
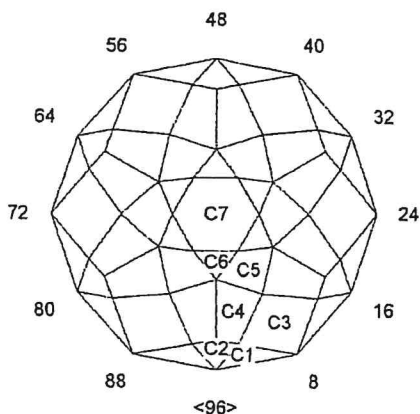

Feline Amulet

for Quartz

Angles for R.I. = 1.540

73 + 12 girdles = 85 facets

6-fold, mirror-image symmetry

96 index

$L/W = 1.036$ $T/W = 0.275$ $U/W = 0.238$

$P/W = 0.478$ $C/W = 0.159$

$Vol./W^3 = 0.214$

PAVILION

P1	90.00°	03-13-19-29-35-45- 51-61-67-77-83-93
P2	45.00°	03-13-19-29-35-45- 51-61-67-77-83-93
P3	43.98°	02-14-18-30-34-46- 50-62-66-78-82-94

CROWN

C1	43.76°	03-13-19-29-35-45- 51-61-67-77-83-93
C2	37.83°	96-16-32-48-64-80
C3	28.32°	08-24-40-56-72-88
C4	21.00°	03-13-19-29-35-45- 51-61-67-77-83-93
C5	14.00°	08-24-40-56-72-88
C6	6.91°	96-16-32-48-64-80
C7	0.00°	Table

FRASER COAST SHOW 2024

Section 36 – Lapidary Fancy Cut – Open 36011

To be cut in Quartz

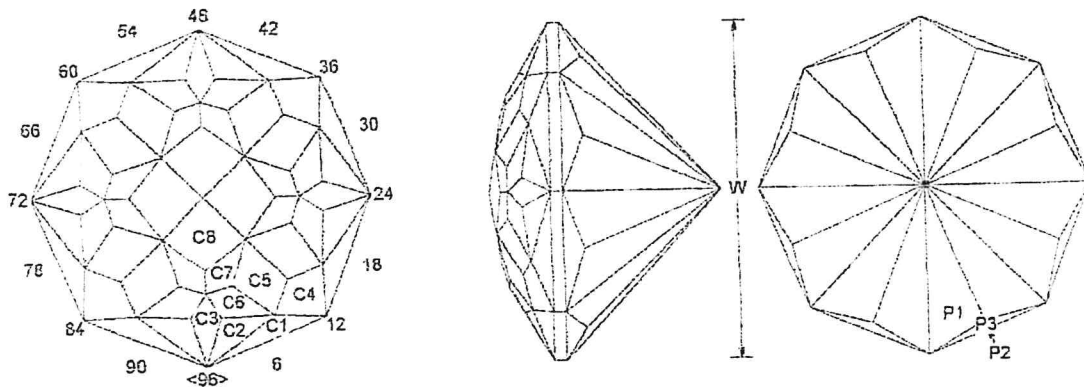

Four Star Cut

for Quartz

Angles for R.I. = 1.540

76 + 8 girdles = 84 facets

4-fold, mirror-image symmetry

96 index

L/W = 1.000

P/W = 0.474 C/W = 0.182

Vol./W³ = 0.211

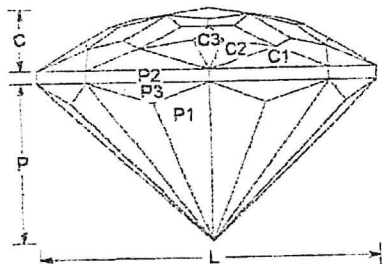

PAVILION

P1	44.00°	03-09-15-21- 27-33-39-45- 51-57-63-69- 75-81-87-93	Cut to P.C.P.
P2	90.00°	06-18-30-42- 54-66-78-90	Establish outline.
P3	66.13°	06-18-30-42- 54-66-78-90	Meet P2, P1, P1 & P2 (level Girdle)

CROWN

C1	44.80°	06-18-30-42- 54-66-78-90	Establish Girdle width.
C2	33.65°	04-20-28-44- 52-68-76-92	Meet P2, C1, C1 & P2.
C3	30.63°	96-24-48-72	Meet C1, C2, C2 & C1.
C4	29.57°	12-36-60-84	Meet P2, C1, C1 & P2.
C5	23.67°	10-14-34-38- 58-62-82-86	Meet C1, C2 & C4.
C6	27.33°	05-19-29-43- 53-67-77-91	Meet C1, C2, C5 & C4.
C7	17.08°	05-19-29-43- 53-67-77-91	Meet C3, C6 & C6.
C8	9.00°	96-24-48-72	Meet C5, C7, C7 & C5.

PAGE LEFT BLANK FOR DOUBLE SIDED PRINTING

2024 FRASER COAST AGRICULTURE SHOW

Maryborough Showgrounds & Equestrian Park
Thursday 23 & Friday 24 MAY 2024
This Entry Form remains the property of the Fraser Coast Agriculture Show Society Inc.

Entrant No:

APPLICATION FOR SECTION ENTRY

Section No: 36	Section Name: LAPIDARY
----------------	------------------------

Collecting Entries: (please circle):	YES	NO
--------------------------------------	-----	----

Mr / Mrs / Miss / Ms	First Name:	Surname:
----------------------	-------------	----------

School Student: Prep to Grade 12, please state:	Grade:
---	--------

Company or Body Corporate/Partnership Name (Provide the ABN where applicable):	ABN:
--	------

Postal Address:	Postcode:
-----------------	-----------

Phone - Work:	Home:	Mobile:
Fax:	Email:	

DECLARATION BY EXHIBITOR

This declaration has serious implications for taxation. The Fraser Coast Agriculture Show Society Inc strongly recommends you seek professional advice before completing.

Are you undertaking this activity as a hobby?	Yes	<input type="checkbox"/>	No	<input type="checkbox"/>
Is this activity part of a Business Enterprise?	Yes	<input type="checkbox"/>	No	<input type="checkbox"/>
If Yes, do you have an ABN?	Yes	<input type="checkbox"/>	No	<input type="checkbox"/>
Are you registered for GST?	Yes	<input type="checkbox"/>	No	<input type="checkbox"/>

If Yes, what is your ABN?

CONDITIONS OF ENTRY:

- I hereby apply to enter the following Exhibit(s) subject to the terms and conditions set out in the Queensland Ag Shows and the Fraser Coast Agriculture Show Society Rules and Section Conditions (collectively called the "Regulations") for the Fraser Coast Agriculture Show. I agree to be bound by these Regulations. All cash prizes, sashes, cards and trophies etc. must be claimed within 4 weeks from closing date of the show, if not they will become a donation to the Fraser Coast Agriculture Show Society.
- Application for Entry and the Regulations shall constitute the whole agreement upon which entries are submitted and I agree that all representations and statements not appearing herein or in the Regulations are hereby excluded.
- The Society is at liberty to consider or to refuse this application, in its absolute and unfettered discretion.
- I hereby certify that all particulars relative to entries set out on this form are correct in all details.
- I agree to abide by the Regulations set down by the Fraser Coast Agriculture Show Society Inc. and the COVID Safe Regulations set down by Qld Health.

..... / / 2024
Signature of Exhibitor	Date

Please refer to the Show Section Schedule for entry dates and other details.
Please complete both pages of this form.

2024 FRASER COAST AGRICULTURE SHOW

Maryborough Showgrounds & Equestrian Park

Thursday 23 & Friday 24 MAY 2024

This Entry Form remains the property of the Fraser Coast Agriculture Show Society Inc.

Entrant No:

ENTRY FEES ARE GST INCLUSIVE AND MUST BE PAID BY CASH (correct change please)

Section No: 36		Section Name: <i>LAPIDARY</i>			
Mr / Mrs / Miss / Ms		First Name:		Surname:	
Collecting Entries: (please circle): YES NO					
School Student: Prep to Grade 12, please state:					Grade:
Class No.	Exhibitor Entry No. <small>(Stewards use only)</small>	No. of Entries per Class	Class Title / Description	Exhibit Selling Price	Entry Fee (\$)
Total Entry Fees \$					