

FINISHES/NOTES

- VARIOUS FINISHES AVAILABLE
- VARIOUS FINISHES AVAILABLE
- GALVANIZED
- GRADE 6063T6 MILL FINISH
- GRADE 6063T6 MILL FINISH
- VARIOUS FINISHES
- MASTIC SEALANT WITH AEROFIL OR SIMILAR FILLER
- METAL STUD SECTIONS MIN 16 GAUGE 50ksi L/360 RATED AT 32" MAX CENTRES

KEY COMPONENT LEGEND

- (A) CORIUM BRICK SYSTEM SIZE 2 1/4" (57mm) x 7 5/8" (194mm)
- (B) MODIFIED HYDRATED LIME POINTING MORTAR
- (C) CORIUM INTERLOCKING STEEL TRAYS
- (D) VERTICAL ALUMINIUM T SECTION SUPPORT
- (E) ALUMINIUM BRACKET WITH THERMAL ISOLATION PAD
- (F) CORNER CORIUM BRICK SLIP UNITS WITH BONDED CLIP
- (BO) INDICATIVE FINISHES NOT BY TELLING Eg :
 - JOINT SEALANTS/ BACKING ROD
 - INSULATION
 - BREATHER MEMBRANE
 - GYPSUM BOARD SHEATHING
 - STEEL FRAMING SYSTEM (LSF)
 - CMU STRUCTURE
 - INTERNAL FINISHES
 - GLAZING SYSTEMS AND SEALS
 - SUBSTRATE FIXINGS
 - COPING, SILLS OR FLASHINGS

| Rev. | Date | Comments |
|------|------|----------|
|------|------|----------|



Telling Architectural Systems LLC
 10 Worthington Road
 Suite K
 Cranston RI 02920
 Tel : (401) 632-4577
 Fax : (401) 632-4801

© Telling Architectural Systems LLC
 Do not scale from this drawing. If in doubt ask

Material :
CORIUM BRICK SYTEM

Series :
**BU SERIES
 VERTICAL T TO SFS**

Drawing Title :
SYSTEM COMPONENTS AND NOTES

| | |
|------------------|----------------|
| Scale : 1 : 5 | Drawn : PSK |
| Date : SEP 16 | |

| Size | Drawing No. | Rev. |
|------|--------------|------|
| A3 | COR-BU-INDEX | |



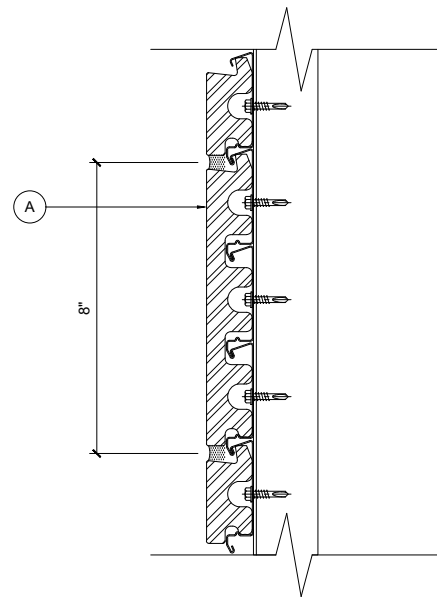

SOLDIER COURSE OPTION

(SUBJECT TO DIE AVAILABILITY)

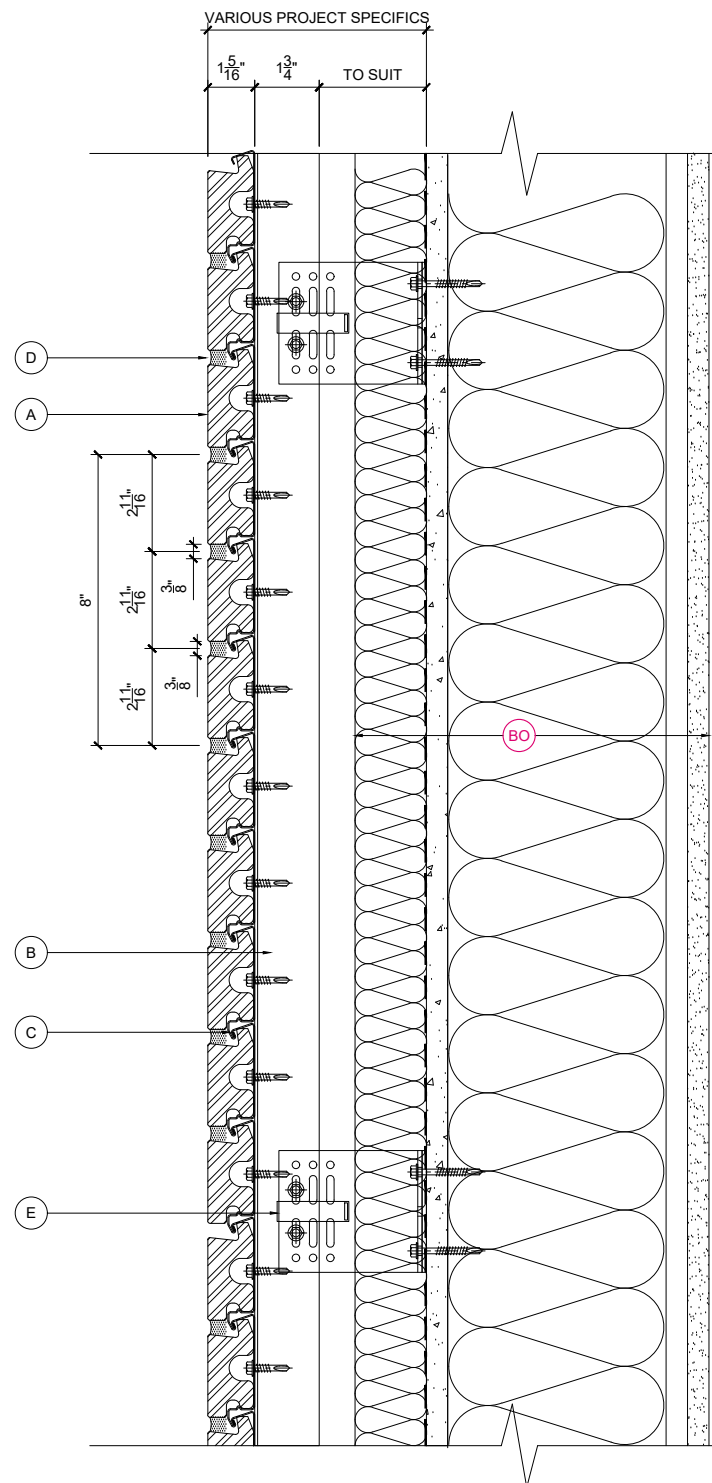

VERTICAL SECTION

KEY COMPONENT LEGEND

- (A) CORIUM BRICK SYSTEM
SIZE 2 1/4" (57mm) x 7 5/8" (194mm)
- (B) MODIFIED HYDRATED LIME
POINTING MORTAR
- (C) CORIUM INTERLOCKING STEEL
TRAYS
- (D) VERTICAL ALUMINIUM T
SECTION SUPPORT
- (E) ALUMINIUM BRACKET WITH
THERMAL ISOLATION PAD
- (F) CORNER CORIUM BRICK SLIP
UNITS WITH BONDED CLIP

- (BO) INDICATIVE FINISHES NOT BY
TELLING Eg :
JOINT SEALANTS/ BACKING ROD
INSULATION
BREATHER MEMBRANE
GYPSUM BOARD SHEATHING
STEEL FRAMING SYSTEM (LSF)
CMU STRUCTURE
INTERNAL FINISHES
GLAZING SYSTEMS AND SEALS
SUBSTRATE FIXINGS
COPING, SILLS OR FLASHINGS

| Rev. | Date | Comments |
|------|------|----------|
| | | |



Telling Architectural Systems LLC
10 Worthington Road
Suite K
Cranston
RI 02920
Tel : (401) 632-4577
Fax : (401) 632-4801

© Telling Architectural Systems LLC
Do not scale from this drawing. If in doubt ask

Material :
CORIUM BRICK SYSTEM

Series :
**BU SERIES
VERTICAL T TO SFS**

Drawing Title :
VERTICAL SECTION

Scale :
1 : 5

Drawn : PSK
Date : SEP 16

| Size | Drawing No. | Rev. |
|------|-------------|------|
| A3 | COR-BUD01 | |

NOTE:
INDICATIVE STANDARD DETAILS
SHOWN
ACTUAL CONSTRUCTION
DRAWINGS SUBJECT TO CHANGE

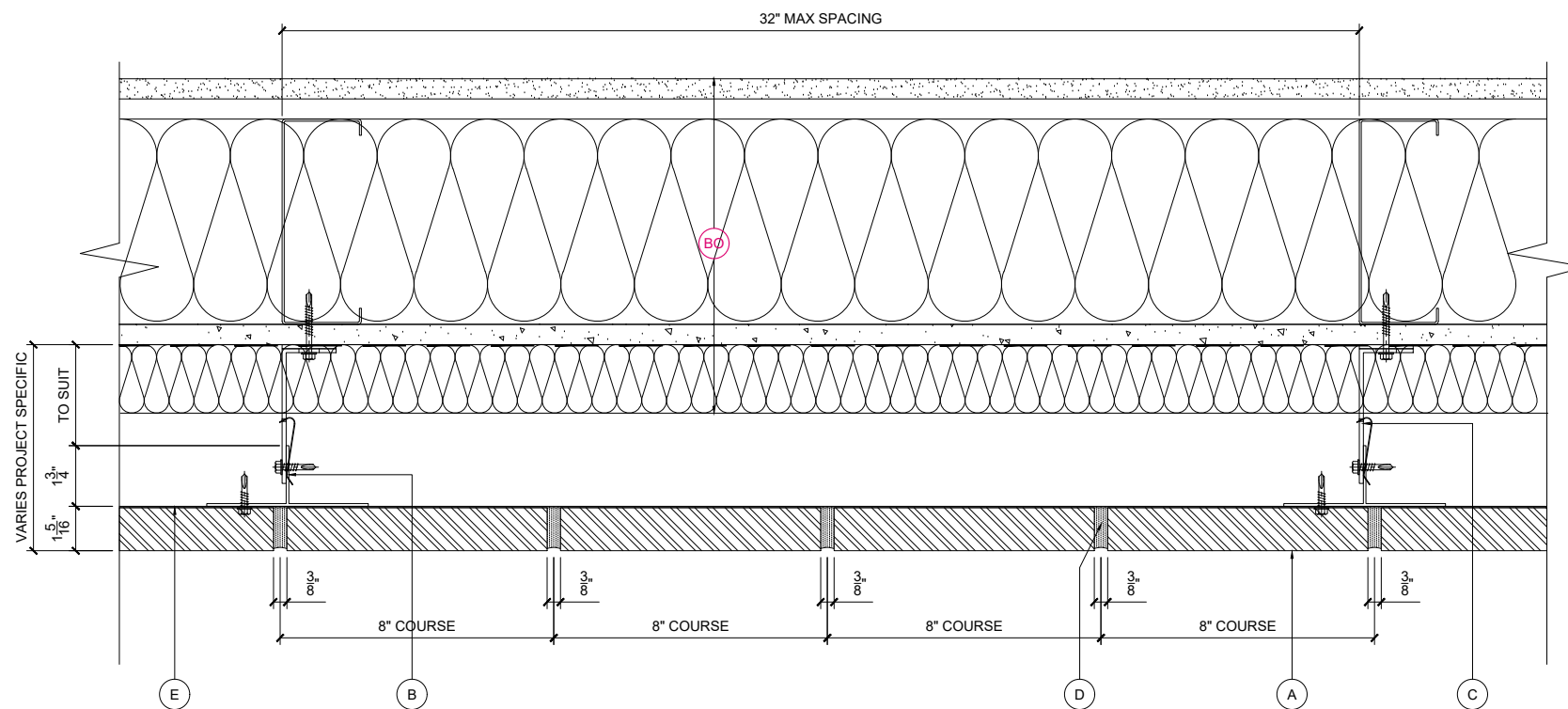

KEY COMPONENT LEGEND

- (A) CORIUM BRICK SYSTEM
SIZE 2 1/4" (57mm) x 7 5/8" (194mm)
- (B) MODIFIED HYDRATED LIME
POINTING MORTAR
- (C) CORIUM INTERLOCKING STEEL
TRAYS
- (D) VERTICAL ALUMINIUM T
SECTION SUPPORT
- (E) ALUMINIUM BRACKET WITH
THERMAL ISOLATION PAD
- (F) CORNER CORIUM BRICK SLIP
UNITS WITH BONDED CLIP

- (BO) INDICATIVE FINISHES NOT BY
TELLING Eg :
JOINT SEALANTS/ BACKING ROD
INSULATION
BREATHER MEMBRANE
GYPSUM BOARD SHEATHING
STEEL FRAMING SYSTEM (LSF)
CMU STRUCTURE
INTERNAL FINISHES
GLAZING SYSTEMS AND SEALS
SUBSTRATE FIXINGS
COPING, SILLS OR FLASHINGS

| Rev. | Date | Comments |
|------|------|----------|
| | | |



Telling Architectural Systems LLC
 10 Worthington Road
 Suite K
 Cranston
 RI 02920
 Tel : (401) 632-4577
 Fax : (401) 632-4801

© Telling Architectural Systems LLC
 Do not scale from this drawing. If in doubt ask

Material :
CORIUM BRICK SYSTEM

Series :
**BU SERIES
 VERTICAL T TO SFS**

Drawing Title :
HORIZONTAL SECTION

Scale :
1 : 5

Drawn : PSK
 Date : SEP 16

| Size | Drawing No. | Rev. |
|------|-------------|------|
| A3 | COR-BUD02 | |

HORIZONTAL SECTION

NOTE:
 INDICATIVE STANDARD DETAILS
 SHOWN
 ACTUAL CONSTRUCTION
 DRAWINGS SUBJECT TO CHANGE

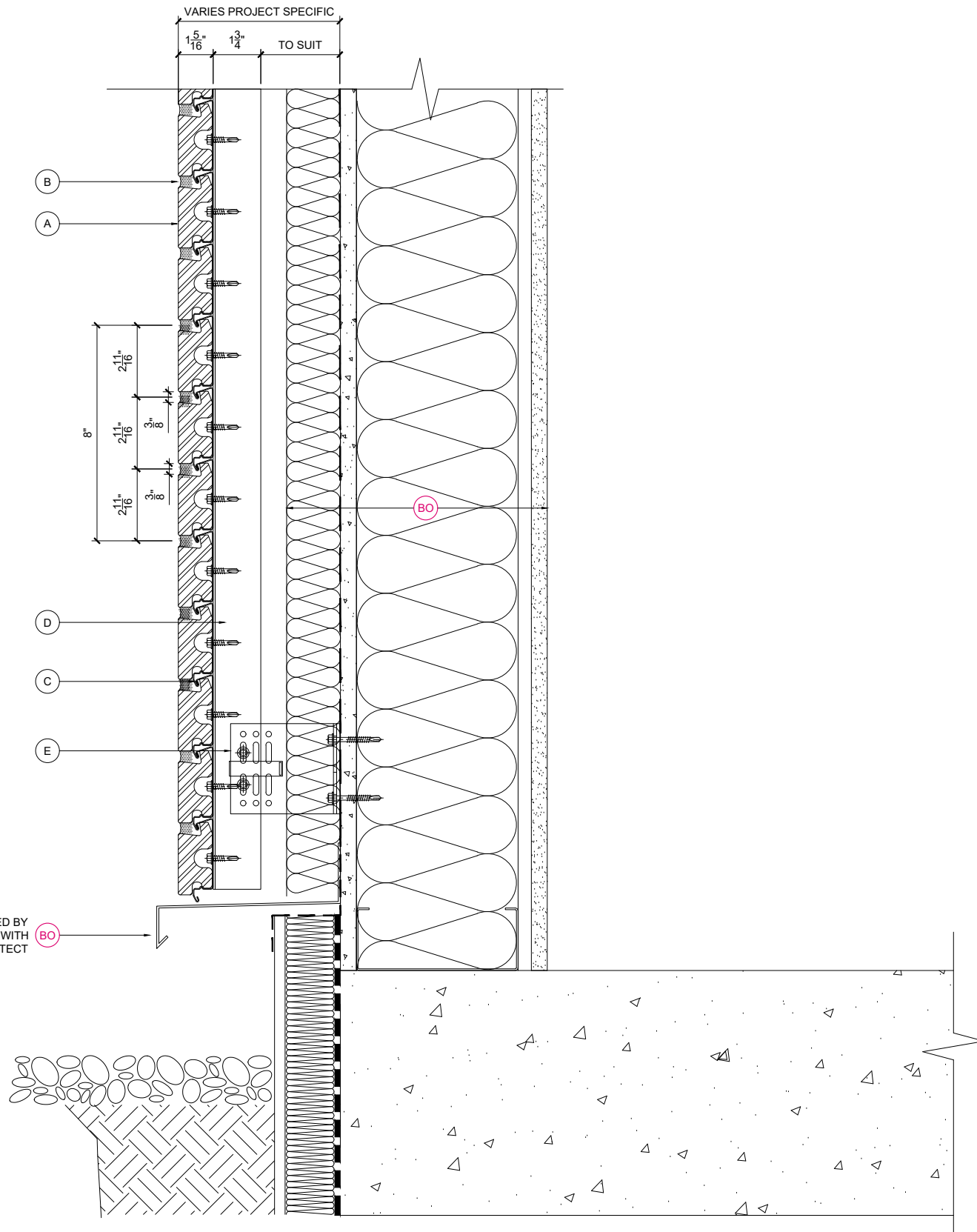

BASE FLASHING PROVIDED BY OTHERS. COORDINATE WITH PROJECT ARCHITECT

BASE DETAIL

KEY COMPONENT LEGEND

- (A) CORIUM BRICK SYSTEM
SIZE 2 1/4" (57mm) x 7 5/8" (194mm)
- (B) MODIFIED HYDRATED LIME POINTING MORTAR
- (C) CORIUM INTERLOCKING STEEL TRAYS
- (D) VERTICAL ALUMINIUM T SECTION SUPPORT
- (E) ALUMINIUM BRACKET WITH THERMAL ISOLATION PAD
- (F) CORNER CORIUM BRICK SLIP UNITS WITH BONDED CLIP

- (BO) INDICATIVE FINISHES NOT BY TELLING Eg :
JOINT SEALANTS/ BACKING ROD
INSULATION
BREATHER MEMBRANE
GYPSUM BOARD SHEATHING
STEEL FRAMING SYSTEM (LSF)
CMU STRUCTURE
INTERNAL FINISHES
GLAZING SYSTEMS AND SEALS
SUBSTRATE FIXINGS
COPING, SILLS OR FLASHINGS

| Rev. | Date | Comments |
|------|------|----------|
| | | |

Telling Architectural

Telling Architectural Systems LLC
 10 Worthington Road
 Suite K
 Cranston
 RI 02920
 Tel : (401) 632-4577
 Fax : (401) 632-4801

© Telling Architectural Systems LLC
Do not scale from this drawing. If in doubt ask

Material :
CORIUM BRICK SYSTEM

Series :
**BU SERIES
VERTICAL T TO SFS**

Drawing Title :
BASE DETAIL

Scale : 1 : 5
 Drawn : PSK
 Date : SEP 16

| Size | Drawing No. | Rev. |
|------|-------------|------|
| A3 | COR-BUD03 | |

NOTE:
INDICATIVE STANDARD DETAILS SHOWN
ACTUAL CONSTRUCTION DRAWINGS SUBJECT TO CHANGE

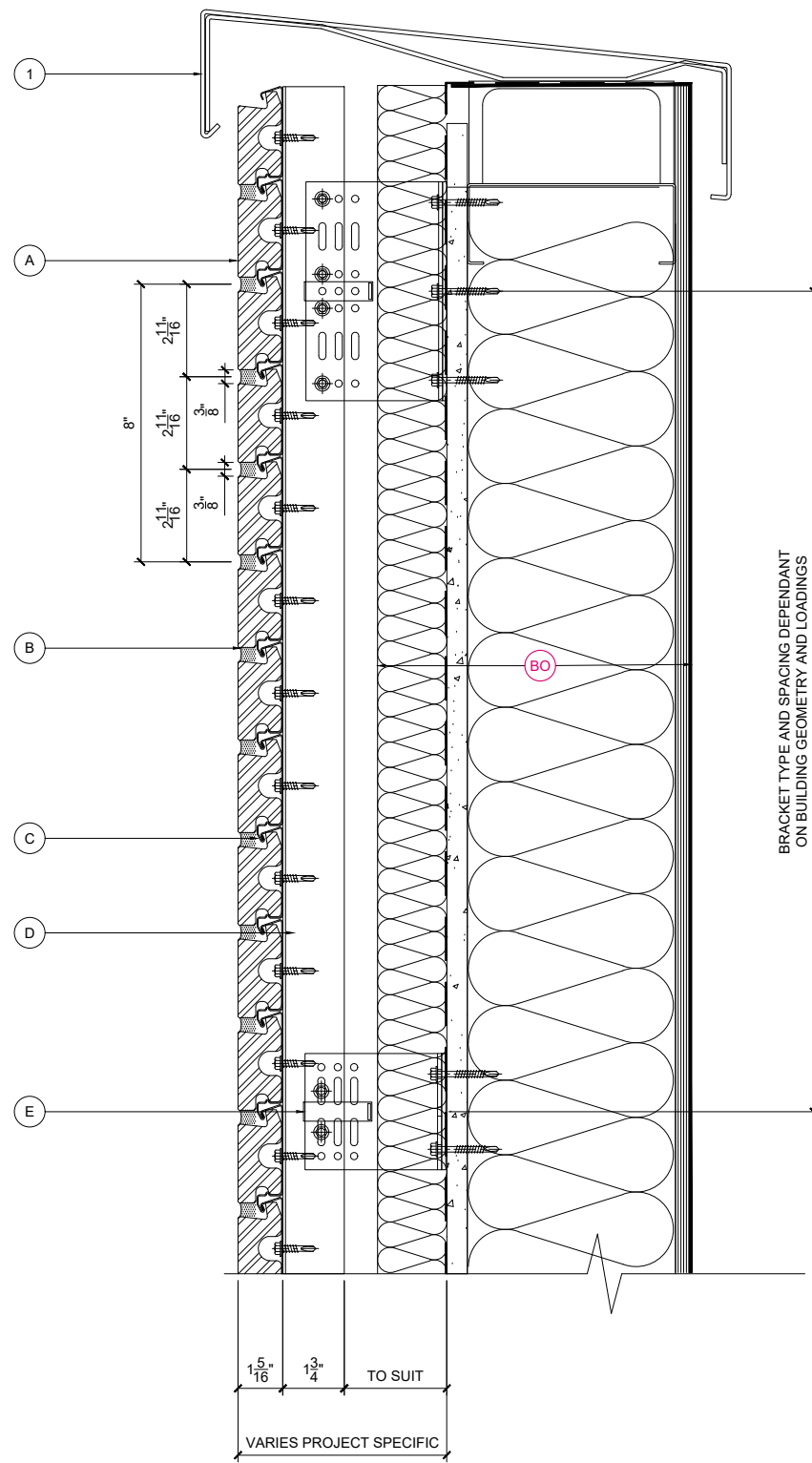

PARAPET DETAIL

KEY COMPONENT LEGEND

- (A) CORIUM BRICK SYSTEM
SIZE 2 1/4" (57mm) x 7 5/8" (194mm)
- (B) MODIFIED HYDRATED LIME
POINTING MORTAR
- (C) CORIUM INTERLOCKING STEEL
TRAYS
- (D) VERTICAL ALUMINIUM T
SECTION SUPPORT
- (E) ALUMINIUM BRACKET WITH
THERMAL ISOLATION PAD
- (F) CORNER CORIUM BRICK SLIP
UNITS WITH BONDED CLIP

(BO) INDICATIVE FINISHES NOT BY
TELLING Eg :

JOINT SEALANTS/ BACKING ROD

INSULATION
BREATHER MEMBRANE
GYPSUM BOARD SHEATHING

STEEL FRAMING SYSTEM (LSF)

CMU STRUCTURE
INTERNAL FINISHES
GLAZING SYSTEMS AND SEALS
SUBSTRATE FIXINGS
COPING, SILLS OR FLASHINGS

| Rev. | Date | Comments |
|------|------|----------|
| | | |



Telling Architectural Systems LLC
10 Worthington Road
Suite K
Cranston
RI 02920
Tel : (401) 632-4577
Fax : (401) 632-4801

© Telling Architectural Systems LLC
Do not scale from this drawing. If in doubt ask

Material :
CORIUM BRICK SYSTEM

Series :
**BU SERIES
VERTICAL T TO SFS**

Drawing Title :
PARAPET DETAIL

Scale :
1 : 5

Drawn : PSK
Date : SEP 16

| Size | Drawing No. | Rev. |
|------|-------------|------|
| A3 | COR-BUD04 | |

NOTE:
INDICATIVE STANDARD DETAILS
SHOWN
ACTUAL CONSTRUCTION
DRAWINGS SUBJECT TO CHANGE

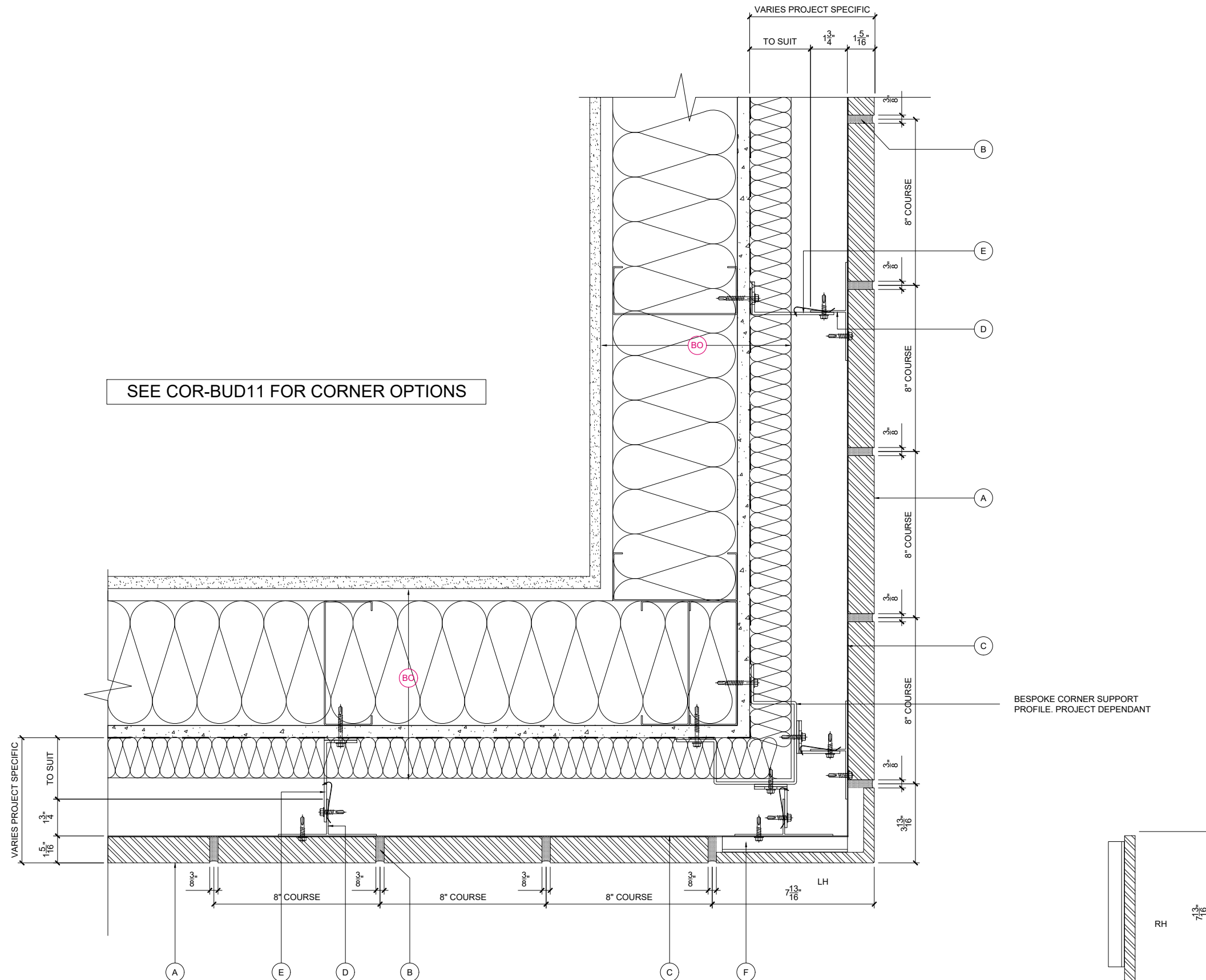

SEE COR-BUD11 FOR CORNER OPTIONS

BESPOKE CORNER SUPPORT PROFILE. PROJECT DEPENDANT

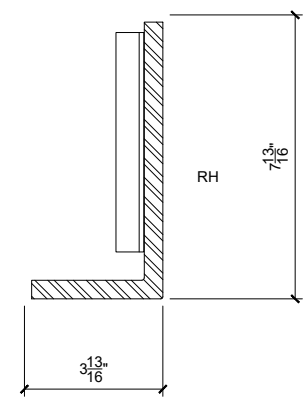

RIGHT HAND ORIENTATION

EXTERNAL CORNER BRICK UNITS

NOTE:
INDICATIVE STANDARD DETAILS SHOWN
ACTUAL CONSTRUCTION DRAWINGS SUBJECT TO CHANGE

KEY COMPONENT LEGEND

- (A) CORIUM BRICK SYSTEM
SIZE 2 1/4" (57mm) x 7 5/8" (194mm)
 - (B) MODIFIED HYDRATED LIME POINTING MORTAR
 - (C) CORIUM INTERLOCKING STEEL TRAYS
 - (D) VERTICAL ALUMINIUM T SECTION SUPPORT
 - (E) ALUMINIUM BRACKET WITH THERMAL ISOLATION PAD
 - (F) CORNER CORIUM BRICK SLIP UNITS WITH BONDED CLIP
- (BC) INDICATIVE FINISHES NOT BY TELLING Eg :
JOINT SEALANTS/ BACKING ROD
INSULATION
BREATHER MEMBRANE
GYPSUM BOARD SHEATHING
STEEL FRAMING SYSTEM (LSF)
CMU STRUCTURE
INTERNAL FINISHES
GLAZING SYSTEMS AND SEALS
SUBSTRATE FIXINGS
COPING, SILLS OR FLASHINGS

| Rev. | Date | Comments |
|------|------|----------|
| | | |

Telling Architectural
Telling Architectural Systems LLC
10 Worthington Road
Suite K
Cranston
RI 02920
Tel : (401) 632-4577
Fax : (401) 632-4801

© Telling Architectural Systems LLC
Do not scale from this drawing. If in doubt ask

Material :
CORIUM BRICK SYSTEM

Series :
**BU SERIES
VERTICAL T TO SFS**

Drawing Title :
EXTERNAL CORNER BRICK UNITS

Scale :
1 : 5

Drawn : PSK
Date : SEP 16

| Size | Drawing No. | Rev. |
|------|-------------|------|
| A3 | COR-BUD05 | |

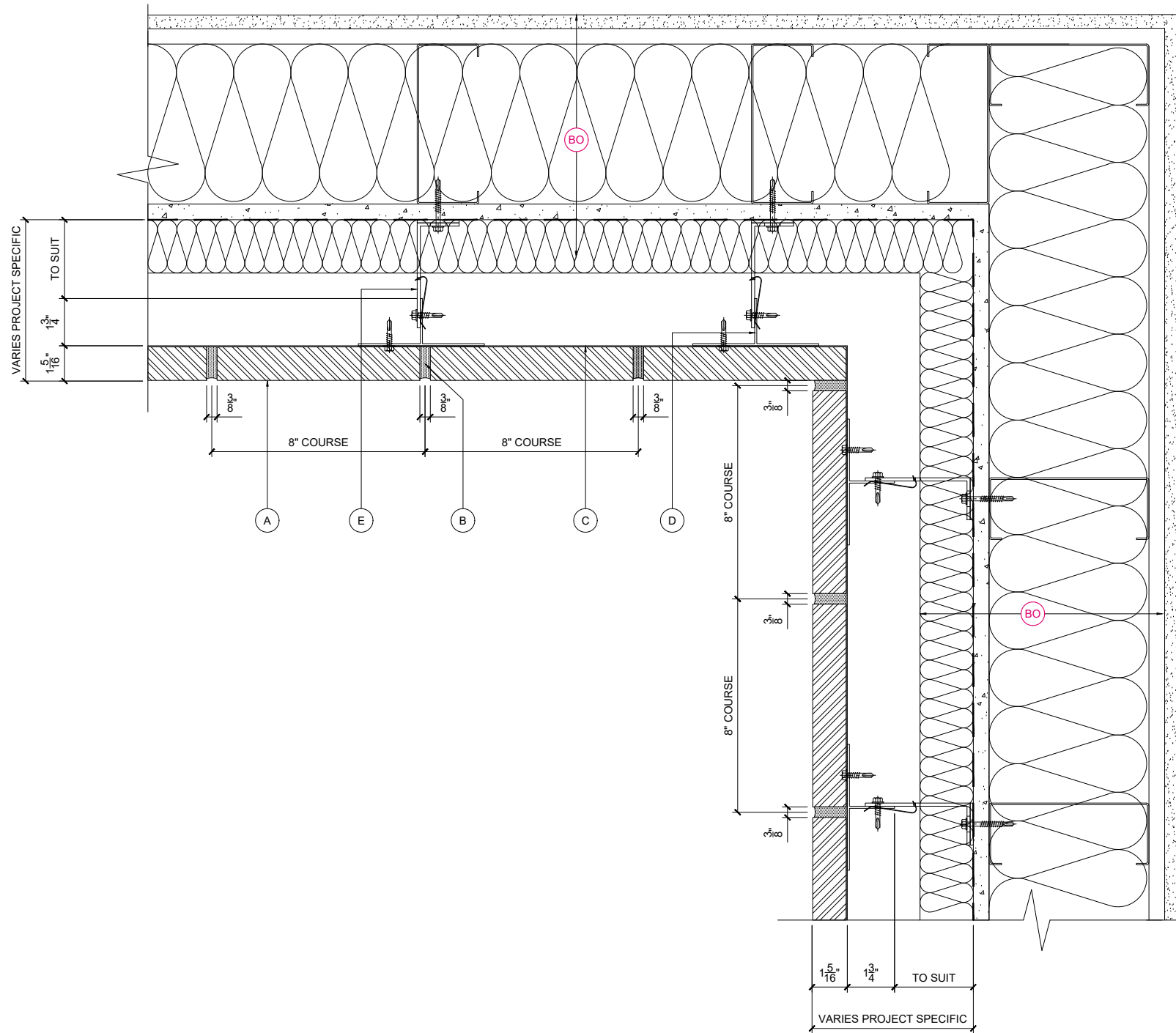

INTERNAL CORNER DETAIL

KEY COMPONENT LEGEND

- (A) CORIUM BRICK SYSTEM
SIZE 2 1/4" (57mm) x 7 5/8" (194mm)
- (B) MODIFIED HYDRATED LIME
POINTING MORTAR
- (C) CORIUM INTERLOCKING STEEL
TRAYS
- (D) VERTICAL ALUMINIUM T
SECTION SUPPORT
- (E) ALUMINIUM BRACKET WITH
THERMAL ISOLATION PAD
- (F) CORNER CORIUM BRICK SLIP
UNITS WITH BONDED CLIP

- (BO) INDICATIVE FINISHES NOT BY
TELLING Eg :
JOINT SEALANTS/ BACKING ROD
INSULATION
BREATHER MEMBRANE
GYPSUM BOARD SHEATHING
STEEL FRAMING SYSTEM (LSF)
CMU STRUCTURE
INTERNAL FINISHES
GLAZING SYSTEMS AND SEALS
SUBSTRATE FIXINGS
COPING, SILLS OR FLASHINGS

| Rev. | Date | Comments |
|------|------|----------|
| | | |



Telling Architectural Systems LLC
 10 Worthington Road
 Suite K
 Cranston
 RI 02920
 Tel : (401) 632-4577
 Fax : (401) 632-4801

© Telling Architectural Systems LLC
 Do not scale from this drawing. If in doubt ask

Material :
CORIUM BRICK SYSTEM

Series :
**BU SERIES
 VERTICAL T TO SFS**

Drawing Title :
INTERNAL CORNER DETAIL

Scale :
1 : 5
 Drawn : PSK
 Date : SEP 16

| Size | Drawing No. | Rev. |
|------|-------------|------|
| A3 | COR-BUD06 | |

NOTE:
 INDICATIVE STANDARD DETAILS
 SHOWN
 ACTUAL CONSTRUCTION
 DRAWINGS SUBJECT TO CHANGE

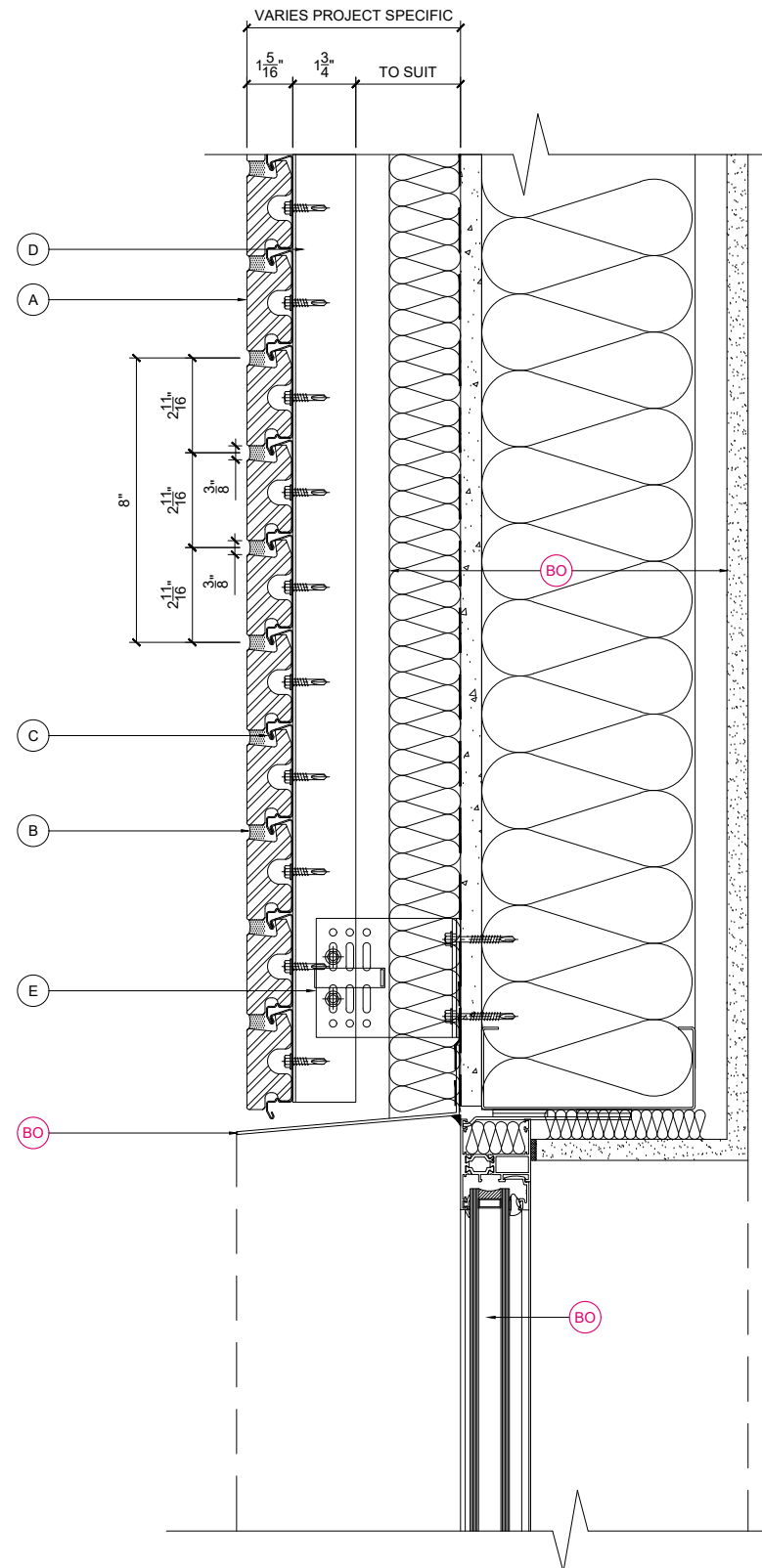

SEE COR-BUD15 FOR BRICK OPTION

WINDOW HEAD DETAIL

NOTE:
INDICATIVE STANDARD DETAILS SHOWN
ACTUAL CONSTRUCTION DRAWINGS SUBJECT TO CHANGE

KEY COMPONENT LEGEND

- (A) CORIUM BRICK SYSTEM
SIZE 2 1/4" (57mm) x 7 5/8" (194mm)
- (B) MODIFIED HYDRATED LIME POINTING MORTAR
- (C) CORIUM INTERLOCKING STEEL TRAYS
- (D) VERTICAL ALUMINIUM T SECTION SUPPORT
- (E) ALUMINIUM BRACKET WITH THERMAL ISOLATION PAD
- (F) CORNER CORIUM BRICK SLIP UNITS WITH BONDED CLIP

- (BO) INDICATIVE FINISHES NOT BY TELLING Eg :
JOINT SEALANTS/ BACKING ROD
INSULATION
BREATHER MEMBRANE
GYPSUM BOARD SHEATHING
STEEL FRAMING SYSTEM (LSF)
CMU STRUCTURE
INTERNAL FINISHES
GLAZING SYSTEMS AND SEALS
SUBSTRATE FIXINGS
COPING, SILLS OR FLASHINGS

| Rev. | Date | Comments |
|------|------|----------|
| | | |



Telling Architectural Systems LLC
10 Worthington Road
Suite K
Cranston
RI 02920
Tel : (401) 632-4577
Fax : (401) 632-4801

© Telling Architectural Systems LLC
Do not scale from this drawing. If in doubt ask

Material :
CORIUM BRICK SYSTEM

Series :
**BU SERIES
VERTICAL T TO SFS**

Drawing Title :
WINDOW HEAD DETAIL

Scale :
1 : 5

Drawn : PSK
Date : SEP 16

| Size | Drawing No. | Rev. |
|------|-------------|------|
| A3 | COR-BUD07 | |

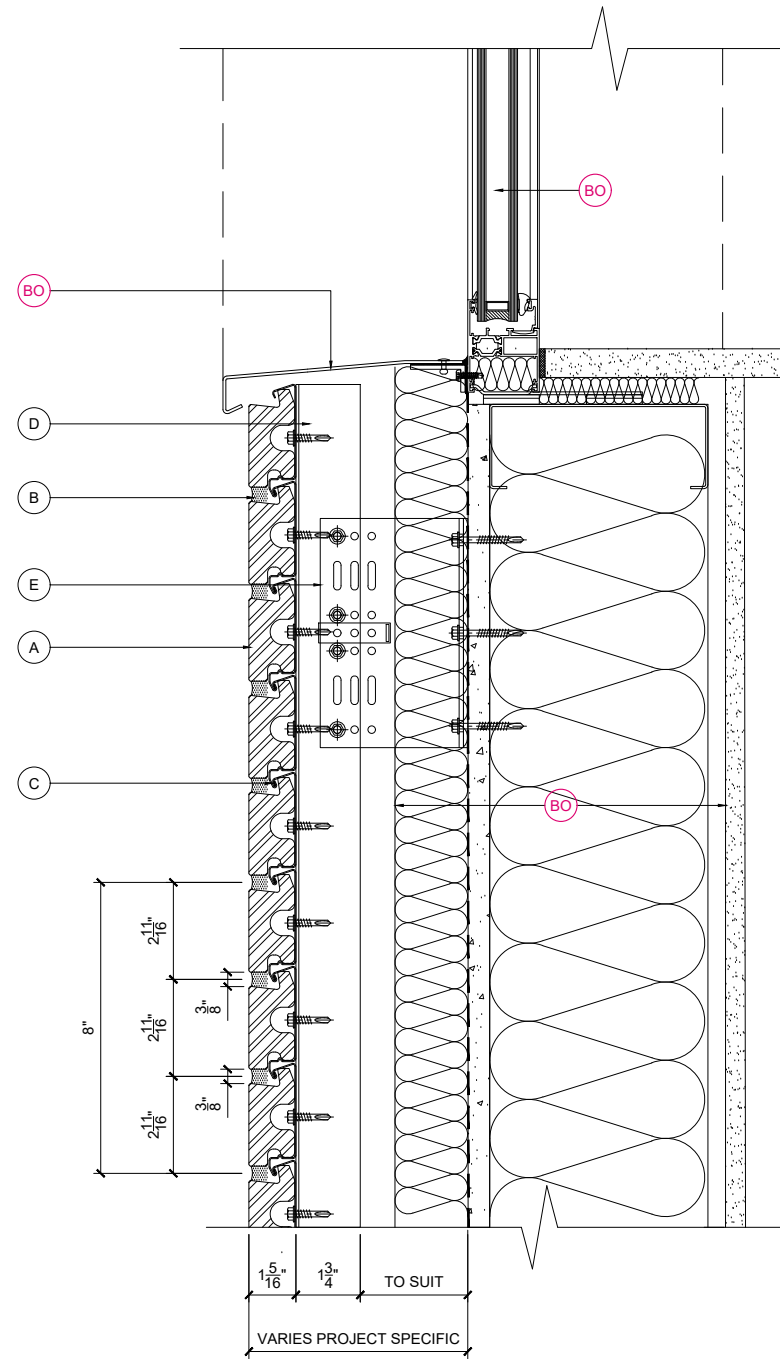

WINDOW CILL DETAIL

KEY COMPONENT LEGEND

- (A) CORIUM BRICK SYSTEM
SIZE 2 1/4" (57mm) x 7 5/8" (194mm)
- (B) MODIFIED HYDRATED LIME
POINTING MORTAR
- (C) CORIUM INTERLOCKING STEEL
TRAYS
- (D) VERTICAL ALUMINIUM T
SECTION SUPPORT
- (E) ALUMINIUM BRACKET WITH
THERMAL ISOLATION PAD
- (F) CORNER CORIUM BRICK SLIP
UNITS WITH BONDED CLIP

- (BO) INDICATIVE FINISHES NOT BY
TELLING Eg :
JOINT SEALANTS/ BACKING ROD
INSULATION
BREATHER MEMBRANE
GYPSUM BOARD SHEATHING
STEEL FRAMING SYSTEM (LSF)
CMU STRUCTURE
INTERNAL FINISHES
GLAZING SYSTEMS AND SEALS
SUBSTRATE FIXINGS
COPING, SILLS OR FLASHINGS

| Rev. | Date | Comments |
|------|------|----------|
| | | |



Telling Architectural Systems LLC
10 Worthington Road
Suite K
Cranston
RI 02920
Tel : (401) 632-4577
Fax : (401) 632-4801

© Telling Architectural Systems LLC
Do not scale from this drawing. If in doubt ask

Material :
CORIUM BRICK SYSTEM

Series :
**BU SERIES
VERTICAL T TO SFS**

Drawing Title :
WINDOW CILL DETAIL

| | |
|-------------------------|------------------|
| Scale : 1 : 5 | Drawn : PSK |
| | Date : SEP 16 |

| Size | Drawing No. | Rev. |
|-----------|------------------|------|
| A3 | COR-BUD08 | |

NOTE:
INDICATIVE STANDARD DETAILS
SHOWN
ACTUAL CONSTRUCTION
DRAWINGS SUBJECT TO CHANGE

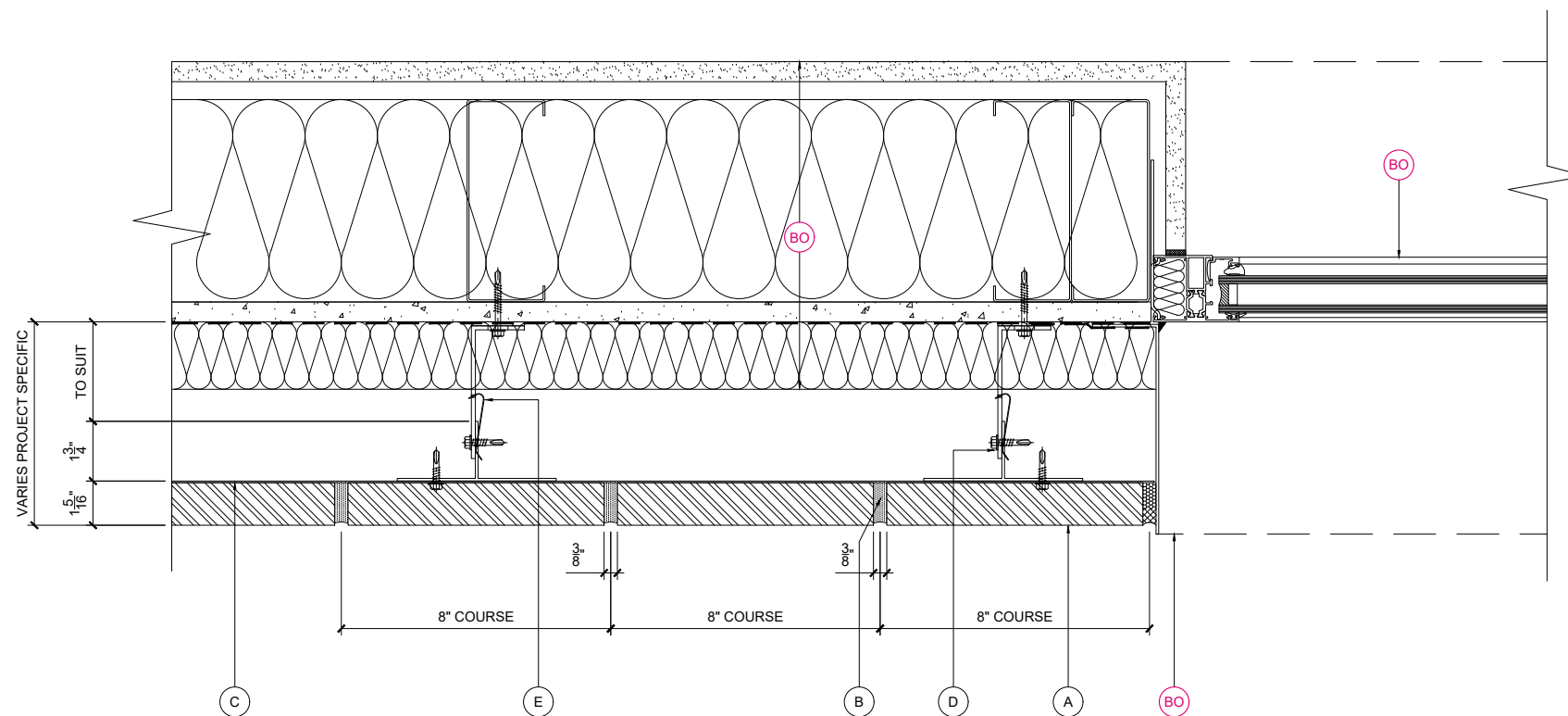

SEE COR-BUD16 FOR BRICK OPTION

WINDOW JAMB DETAIL

KEY COMPONENT LEGEND

- (A) CORIUM BRICK SYSTEM
SIZE 2 1/4" (57mm) x 7 5/8" (194mm)
- (B) MODIFIED HYDRATED LIME
POINTING MORTAR
- (C) CORIUM INTERLOCKING STEEL
TRAYS
- (D) VERTICAL ALUMINIUM T
SECTION SUPPORT
- (E) ALUMINIUM BRACKET WITH
THERMAL ISOLATION PAD
- (F) CORNER CORIUM BRICK SLIP
UNITS WITH BONDED CLIP

- (BO) INDICATIVE FINISHES NOT BY
TELLING Eg :
JOINT SEALANTS/ BACKING ROD
INSULATION
BREATHER MEMBRANE
GYPSUM BOARD SHEATHING
STEEL FRAMING SYSTEM (LSF)
CMU STRUCTURE
INTERNAL FINISHES
GLAZING SYSTEMS AND SEALS
SUBSTRATE FIXINGS
COPING, SILLS OR FLASHINGS

| Rev. | Date | Comments |
|------|------|----------|
| | | |



Telling Architectural Systems LLC
 10 Worthington Road
 Suite K
 Cranston
 RI 02920
 Tel : (401) 632-4577
 Fax : (401) 632-4801

© Telling Architectural Systems LLC
 Do not scale from this drawing. If in doubt ask

Material :
CORIUM BRICK SYSTEM

Series :
**BU SERIES
 VERTICAL T TO SFS**

Drawing Title :
WINDOW JAMB DETAIL

Scale :
1 : 5
 Drawn : PSK
 Date : SEP 16

| Size | Drawing No. | Rev. |
|------|-------------|------|
| A3 | COR-BUD09 | |

NOTE:
 INDICATIVE STANDARD DETAILS
 SHOWN
 ACTUAL CONSTRUCTION
 DRAWINGS SUBJECT TO CHANGE

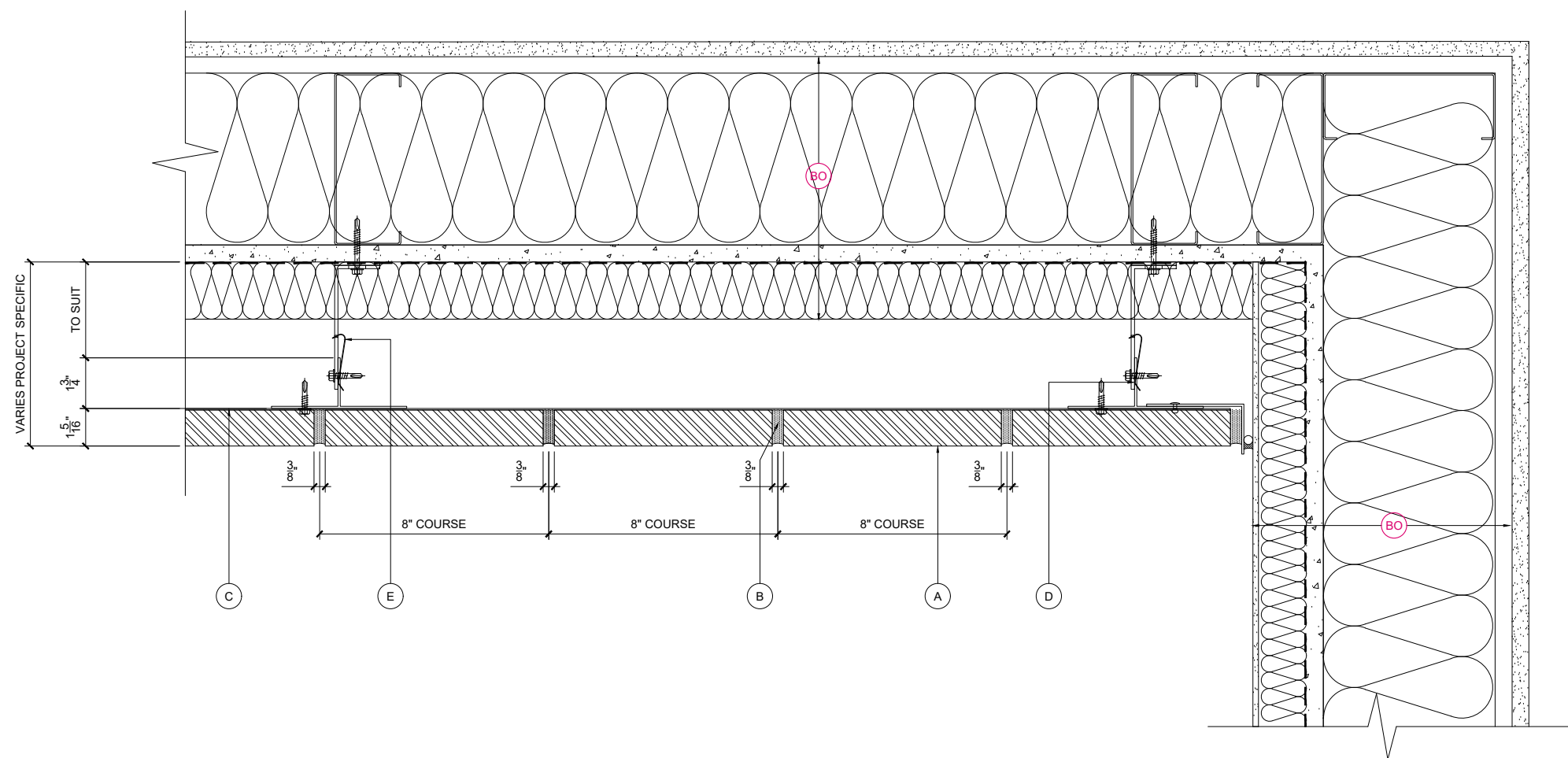

KEY COMPONENT LEGEND

- (A) CORIUM BRICK SYSTEM
SIZE 2 1/4" (57mm) x 7 5/8" (194mm)
- (B) MODIFIED HYDRATED LIME
POINTING MORTAR
- (C) CORIUM INTERLOCKING STEEL
TRAYS
- (D) VERTICAL ALUMINIUM T
SECTION SUPPORT
- (E) ALUMINIUM BRACKET WITH
THERMAL ISOLATION PAD
- (F) CORNER CORIUM BRICK SLIP
UNITS WITH BONDED CLIP

- (BO) INDICATIVE FINISHES NOT BY
TELLING Eg :
JOINT SEALANTS/ BACKING ROD
INSULATION
BREATHER MEMBRANE
GYPSUM BOARD SHEATHING
STEEL FRAMING SYSTEM (LSF)
CMU STRUCTURE
INTERNAL FINISHES
GLAZING SYSTEMS AND SEALS
SUBSTRATE FIXINGS
COPING, SILLS OR FLASHINGS

| Rev. | Date | Comments |
|------|------|----------|
| | | |

Telling Architectural

Telling Architectural Systems LLC
 10 Worthington Road
 Suite K
 Cranston
 RI 02920
 Tel : (401) 632-4577
 Fax : (401) 632-4801

© Telling Architectural Systems LLC
 Do not scale from this drawing. If in doubt ask

Material :
CORIUM BRICK SYSTEM

Series :
**BU SERIES
 VERTICAL T TO SFS**

Drawing Title :
**CLADDING ABUTMENT
 DETAIL**

Scale :
1 : 5

Drawn : PSK
 Date : SEP 16

| Size | Drawing No. | Rev. |
|------|-------------|------|
| A3 | COR-BUD10 | |

CLADDING ABUTMENT DETAIL

NOTE:
 INDICATIVE STANDARD DETAILS
 SHOWN
 ACTUAL CONSTRUCTION
 DRAWINGS SUBJECT TO CHANGE

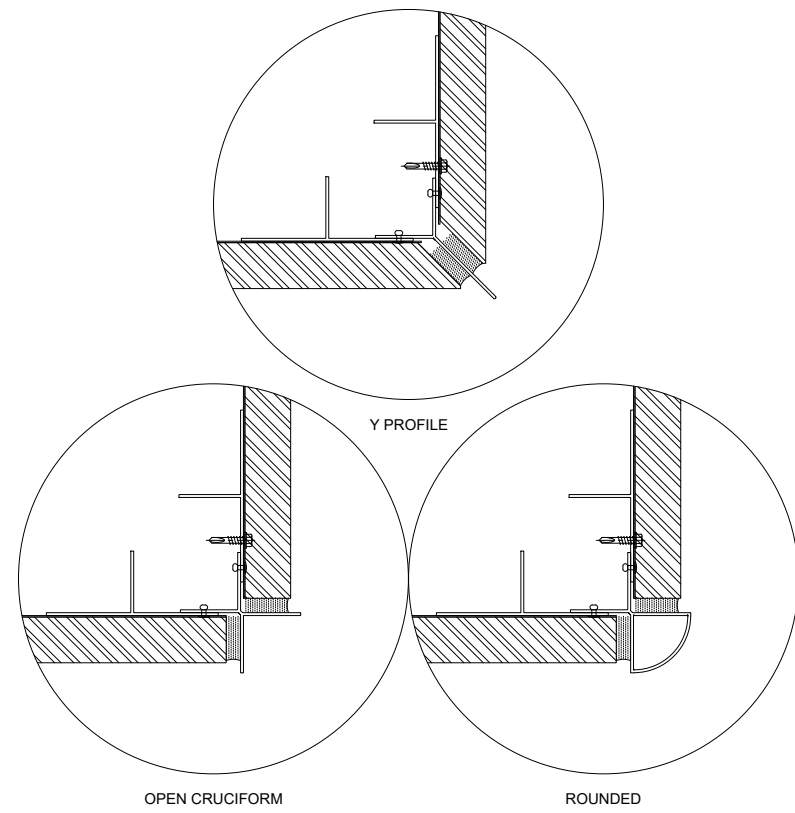

PROFILE OPTIONS

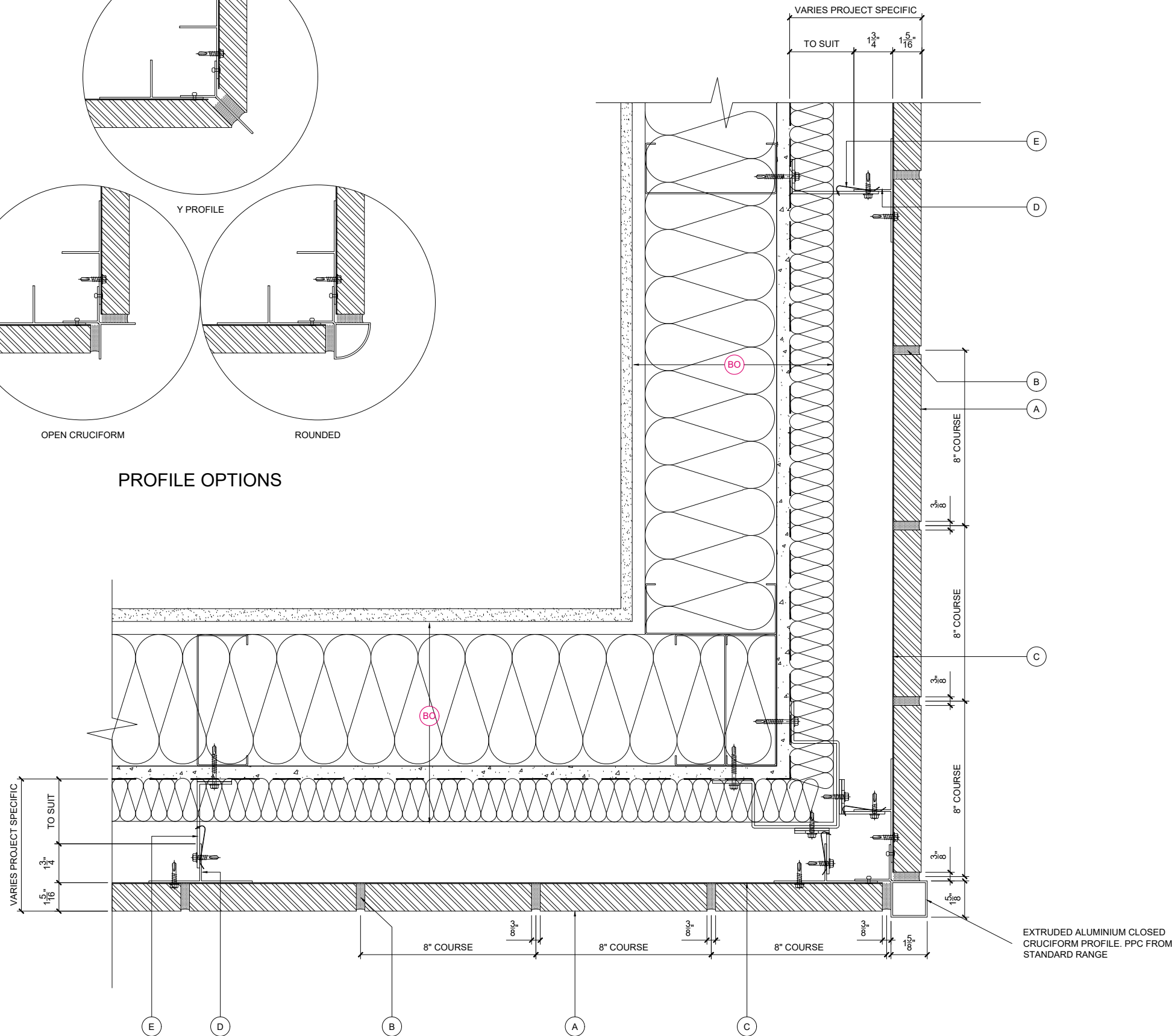

EXTERNAL CORNER ALUMINIUM OPTION

KEY COMPONENT LEGEND

- (A) CORIUM BRICK SYSTEM
SIZE 2 1/4" (57mm) x 7 5/8" (194mm)
- (B) MODIFIED HYDRATED LIME
POINTING MORTAR
- (C) CORIUM INTERLOCKING STEEL
TRAYS
- (D) VERTICAL ALUMINIUM T
SECTION SUPPORT
- (E) ALUMINIUM BRACKET WITH
THERMAL ISOLATION PAD
- (F) CORNER CORIUM BRICK SLIP
UNITS WITH BONDED CLIP

- (BC) INDICATIVE FINISHES NOT BY
TELLING Eg :
JOINT SEALANTS/ BACKING ROD
INSULATION
BREATHER MEMBRANE
GYPSUM BOARD SHEATHING
STEEL FRAMING SYSTEM (LSF)
CMU STRUCTURE
INTERNAL FINISHES
GLAZING SYSTEMS AND SEALS
SUBSTRATE FIXINGS
COPING, SILLS OR FLASHINGS

| Rev. | Date | Comments |
|------|------|----------|
| | | |



Telling Architectural Systems LLC
 10 Worthington Road
 Suite K
 Cranston
 RI 02920
 Tel : (401) 632-4577
 Fax : (401) 632-4801

© Telling Architectural Systems LLC
 Do not scale from this drawing. If in doubt ask

Material :
CORIUM BRICK SYSTEM

Series :
**BU SERIES
 VERTICAL T TO SFS**

Drawing Title :
**EXTERNAL CORNER
 ALUMINIUM OPTIONS**

Scale :
1 : 5
 Drawn : PSK
 Date : SEP 16

| Size | Drawing No. | Rev. |
|------|-------------|------|
| A3 | COR-BUD11 | |

NOTE:
 INDICATIVE STANDARD DETAILS
 SHOWN
 ACTUAL CONSTRUCTION
 DRAWINGS SUBJECT TO CHANGE

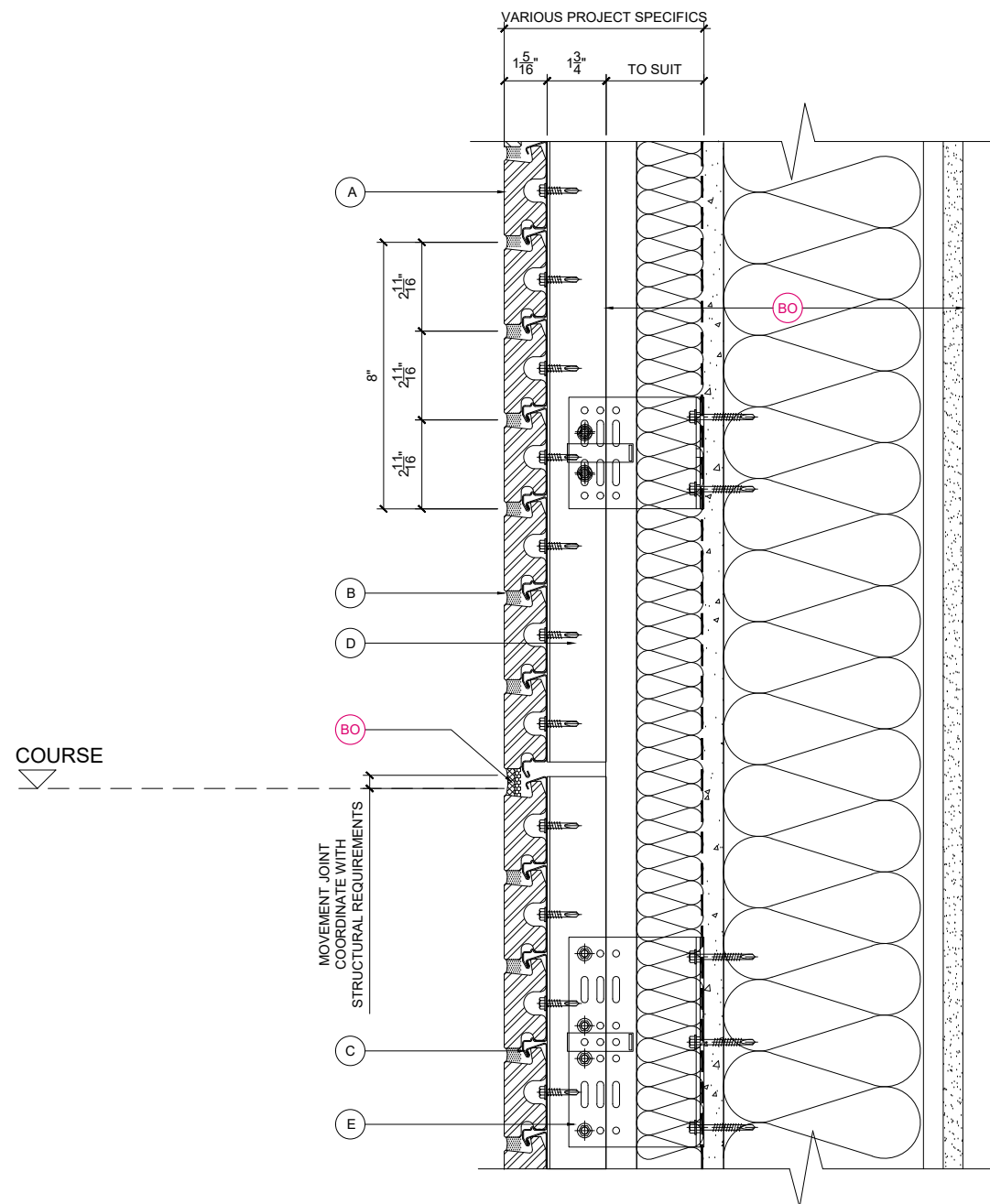

HORIZONTAL MOVEMENT JOINT DETAIL

KEY COMPONENT LEGEND

- (A) CORIUM BRICK SYSTEM
SIZE 2 1/4" (57mm) x 7 5/8" (194mm)
- (B) MODIFIED HYDRATED LIME
POINTING MORTAR
- (C) CORIUM INTERLOCKING STEEL
TRAYS
- (D) VERTICAL ALUMINIUM T
SECTION SUPPORT
- (E) ALUMINIUM BRACKET WITH
THERMAL ISOLATION PAD
- (F) CORNER CORIUM BRICK SLIP
UNITS WITH BONDED CLIP

- (BO) INDICATIVE FINISHES NOT BY
TELLING Eg :
JOINT SEALANTS/ BACKING ROD
INSULATION
BREATHER MEMBRANE
GYPSUM BOARD SHEATHING
STEEL FRAMING SYSTEM (LSF)
CMU STRUCTURE
INTERNAL FINISHES
GLAZING SYSTEMS AND SEALS
SUBSTRATE FIXINGS
COPING, SILLS OR FLASHINGS

| Rev. | Date | Comments |
|------|------|----------|
| | | |

 **Telling Architectural**

Telling Architectural Systems LLC
 10 Worthington Road
 Suite K
 Cranston
 RI 02920
 Tel : (401) 632-4577
 Fax : (401) 632-4801

© Telling Architectural Systems LLC
 Do not scale from this drawing. If in doubt ask

Material :
CORIUM BRICK SYSTEM

Series :
**BU SERIES
 VERTICAL T TO SFS**

Drawing Title :
**HORIZONTAL MOVEMENT
 JOINT**

Scale :
1 : 5

Drawn : PSK
 Date : SEP 16

| Size | Drawing No. | Rev. |
|------|-------------|------|
| A3 | COR-BUD12 | |

NOTE:
 INDICATIVE STANDARD DETAILS
 SHOWN
 ACTUAL CONSTRUCTION
 DRAWINGS SUBJECT TO CHANGE

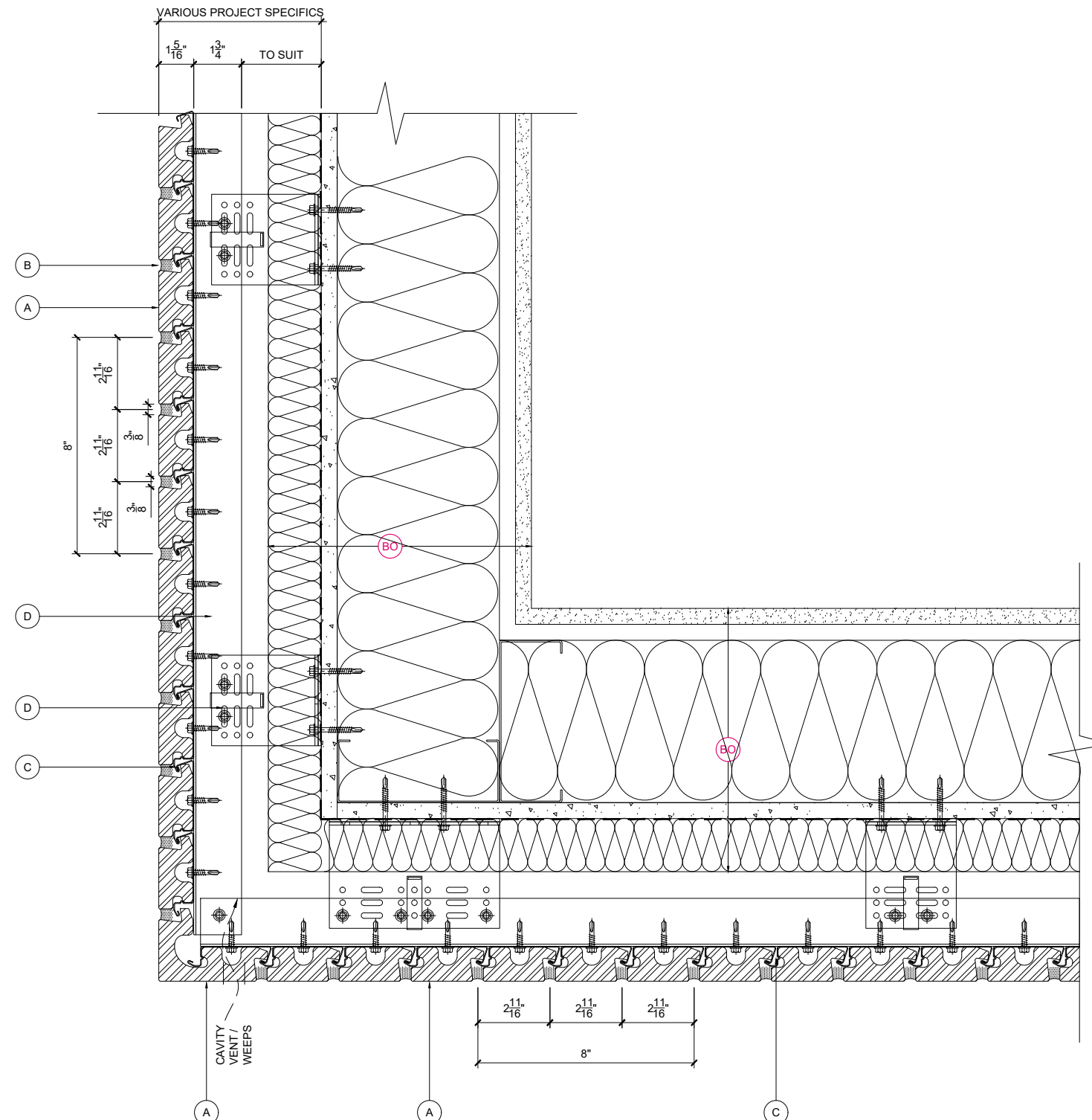

- KEY COMPONENT LEGEND**
- (A) CORIUM BRICK SYSTEM
SIZE 2 1/4" (57mm) x 7 5/8" (194mm)
 - (B) MODIFIED HYDRATED LIME
POINTING MORTAR
 - (C) CORIUM INTERLOCKING STEEL
TRAYS
 - (D) VERTICAL ALUMINIUM T
SECTION SUPPORT
 - (E) ALUMINIUM BRACKET WITH
THERMAL ISOLATION PAD
 - (F) CORNER CORIUM BRICK SLIP
UNITS WITH BONDED CLIP
- (BO) INDICATIVE FINISHES NOT BY
TELLING Eg :
JOINT SEALANTS/ BACKING ROD
INSULATION
BREATHER MEMBRANE
GYPSUM BOARD SHEATHING
STEEL FRAMING SYSTEM (LSF)
CMU STRUCTURE
INTERNAL FINISHES
GLAZING SYSTEMS AND SEALS
SUBSTRATE FIXINGS
COPING, SILLS OR FLASHINGS

| Rev. | Date | Comments |
|------|------|----------|
| | | |

Telling Architectural

Telling Architectural Systems LLC
 10 Worthington Road
 Suite K
 Cranston
 RI 02920
 Tel: (401) 632-4577
 Fax: (401) 632-4801

© Telling Architectural Systems LLC
Do not scale from this drawing. If in doubt ask

Material :
CORIUM BRICK SYSTEM

Series :
**BU SERIES
VERTICAL T TO SFS**

Drawing Title :
SOFFIT SECTION

Scale :
1 : 5

Drawn : PSK
Date : SEP 16

| Size | Drawing No. | Rev. |
|------|-------------|------|
| A3 | COR-BUD14 | |

NOTE:
INDICATIVE STANDARD DETAILS
SHOWN
ACTUAL CONSTRUCTION
DRAWINGS SUBJECT TO CHANGE

SOFFIT SECTION

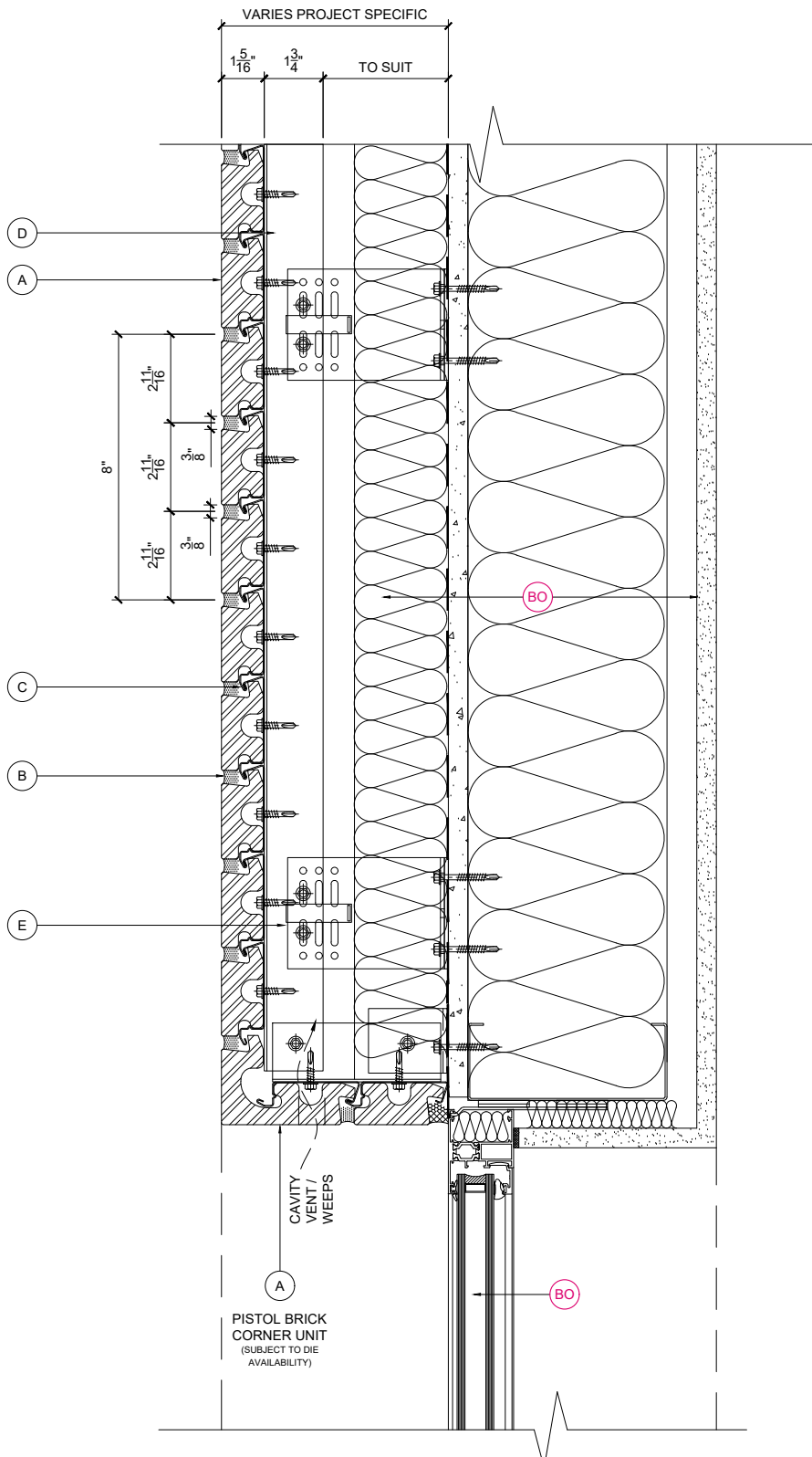

- KEY COMPONENT LEGEND**
- (A) CORIUM BRICK SYSTEM
SIZE 2 1/4" (57mm) x 7 5/8" (194mm)
 - (B) MODIFIED HYDRATED LIME
POINTING MORTAR
 - (C) CORIUM INTERLOCKING STEEL
TRAYS
 - (D) VERTICAL ALUMINIUM T
SECTION SUPPORT
 - (E) ALUMINIUM BRACKET WITH
THERMAL ISOLATION PAD
 - (F) CORNER CORIUM BRICK SLIP
UNITS WITH BONDED CLIP
- (BO) INDICATIVE FINISHES NOT BY
TELLING Eg :
JOINT SEALANTS/ BACKING ROD
INSULATION
BREATHER MEMBRANE
GYPSUM BOARD SHEATHING
STEEL FRAMING SYSTEM (LSF)
CMU STRUCTURE
INTERNAL FINISHES
GLAZING SYSTEMS AND SEALS
SUBSTRATE FIXINGS
COPING, SILLS OR FLASHINGS

| Rev. | Date | Comments |
|------|------|----------|
|------|------|----------|



Telling Architectural Systems LLC
 10 Worthington Road
 Suite K
 Cranston
 RI 02920
 Tel : (401) 632-4577
 Fax : (401) 632-4801

© Telling Architectural Systems LLC
 Do not scale from this drawing. If in doubt ask

Material :
CORIUM BRICK SYSTEM

Series :
**BU SERIES
 VERTICAL T TO SFS**

Drawing Title :
**WINDOW HEAD DETAIL
 CORNER BRICK**

Scale :
1 : 5

Drawn : PSK
 Date : SEP 16

| Size | Drawing No. | Rev. |
|------|-------------|------|
| A3 | COR-BUD15 | |

NOTE:
 INDICATIVE STANDARD DETAILS
 SHOWN
 ACTUAL CONSTRUCTION
 DRAWINGS SUBJECT TO CHANGE

WINDOW HEAD CORNER BRICK

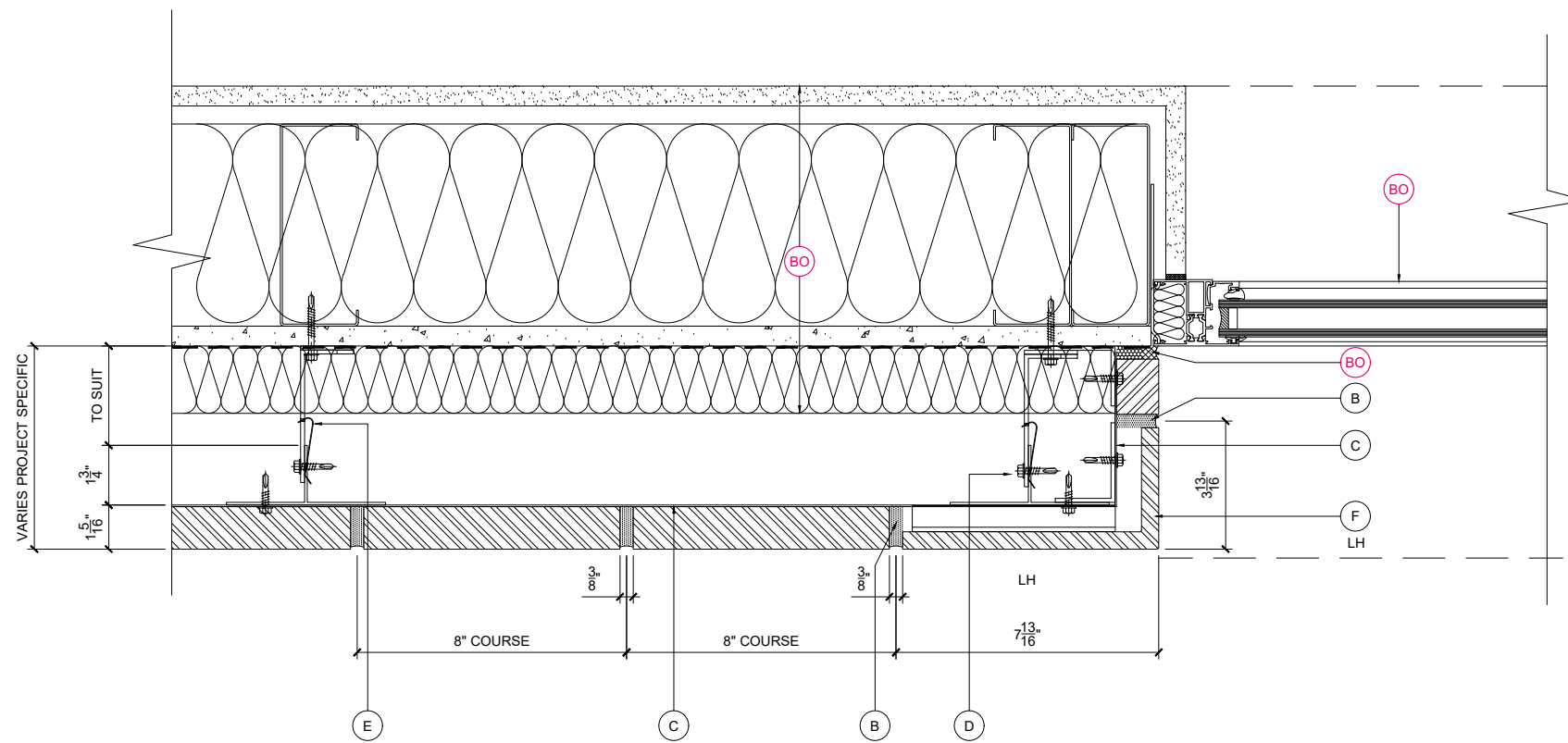
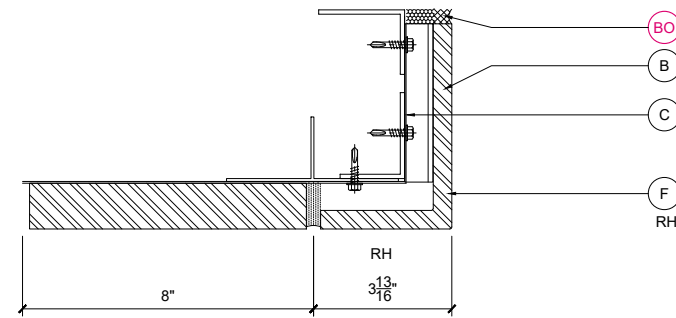

KEY COMPONENT LEGEND

- (A) CORIUM BRICK SYSTEM
SIZE 2 1/4" (57mm) x 7 5/8" (194mm)
- (B) MODIFIED HYDRATED LIME
POINTING MORTAR
- (C) CORIUM INTERLOCKING STEEL
TRAYS
- (D) VERTICAL ALUMINIUM T
SECTION SUPPORT
- (E) ALUMINIUM BRACKET WITH
THERMAL ISOLATION PAD
- (F) CORNER CORIUM BRICK SLIP
UNITS WITH BONDED CLIP

- (BO) INDICATIVE FINISHES NOT BY
TELLING Eg :
JOINT SEALANTS/ BACKING ROD
INSULATION
BREATHER MEMBRANE
GYPSUM BOARD SHEATHING
STEEL FRAMING SYSTEM (LSF)
CMU STRUCTURE
INTERNAL FINISHES
GLAZING SYSTEMS AND SEALS
SUBSTRATE FIXINGS
COPING, SILLS OR FLASHINGS

| Rev. | Date | Comments |
|------|------|----------|
| | | |



Telling Architectural Systems LLC
 10 Worthington Road
 Suite K
 Cranston
 RI 02920
 Tel: (401) 632-4577
 Fax: (401) 632-4801

© Telling Architectural Systems LLC
 Do not scale from this drawing. If in doubt ask

Material :
CORIUM BRICK SYSTEM

Series :
**BU SERIES
 VERTICAL T TO SFS**

Drawing Title :
**WINDOW JAMB DETAIL
 CORNER BRICK**

Scale :
1 : 5
 Drawn : PSK
 Date : SEP 16

| Size | Drawing No. | Rev. |
|------|-------------|------|
| A3 | COR-BUD16 | |

NOTE:
 INDICATIVE STANDARD DETAILS
 SHOWN
 ACTUAL CONSTRUCTION
 DRAWINGS SUBJECT TO CHANGE

WINDOW JAMB CORNER BRICK