

# Technique Exterior

EDITION APRIL 2018

**exterior**

for  
people  
who  
create

## CONTENT

<b>4</b>	Products
<b>8</b>	Sustainability and Environment
<b>10</b>	Processing Recommendations
<b>20</b>	Facades
<b>70</b>	Soffits
<b>74</b>	Outdoor-furniture
<b>76</b>	Balconies and Railings
<b>90</b>	Balcony Floor Panel
<b>96</b>	Roof Claddings
<b>100</b>	Sunblinds
<b>104</b>	Lattice Blinds
<b>105</b>	Cleaning Max Exterior
<b>106</b>	Suppliers/Accessories

### NOTE

PLEASE CHECK ADDITIONAL AT [WWW.FUNDERMAX.AT](http://WWW.FUNDERMAX.AT) FOR THE LATEST VERSION OF THIS BROCHURE.

THE DIAGRAMS IN THIS TECHNICAL INFORMATION ARE SCHEMATICAL REPRESENTATIONS AND ARE NOT TRUE TO SCALE.  
THIS ISSUE REPLACES ALL OTHER ISSUES OF EXTERIOR TECHNIQUES BROCHURES OF FUNDERMAX WHICH WERE PUBLISHED BEFORE.





## Create New Worlds

Shape, colour and material all convey emotions, tell stories and inspire new ideas. And they all lend our buildings character. Therefore, with this brochure we want provide you an overview of the creative and technical components of the Max Exterior panels for outdoor use.

If you have any questions that are not answered in this brochure, please contact our sales department or application engineering department at [support@fundermax.biz](mailto:support@fundermax.biz). We are happy to help!

## What Max Exterior Can Do

Max Exterior panels are duromer high-pressure laminates (HPL) in accordance with EN 438-6 Type EDF that are produced in lamination presses under great pressure and high temperature. Double-hardened acrylic PUR resins provide extremely effective weather protection that is particularly suitable for longlasting balconies and facade claddings.

### PROPERTIES\*:

- Weather resistant to EN ISO 4892-2
- lightfast acc. to EN ISO 4892-3
- Double hardened
- Scratch resistant
- Solvent resistant
- Hail resistant
- Easy to clean
- Impact resistant EN ISO 178
- Suitable for all exterior applications
- Decorative
- Self-supporting
- Bending resistant EN ISO 178
- Frost resistant -80°C to 180°C
- Heat resistant -80°C to 180°C
- Easy to install

\*STANDARD- AND ACTUAL-VALUES YOU WILL FIND ON OUR WEBSITE [WWW.FUNDERMAX.AT](http://WWW.FUNDERMAX.AT).

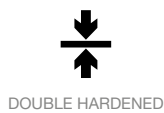



### Max Exterior F-Quality

As a standard, Max Exterior panels come printed on both sides. The core is flame-retardant and the surface is lightfast. Thanks to the double-hardened resin, it is also extremely weather resistant. (Fire Test EN 13501-1, B-s2,d0)

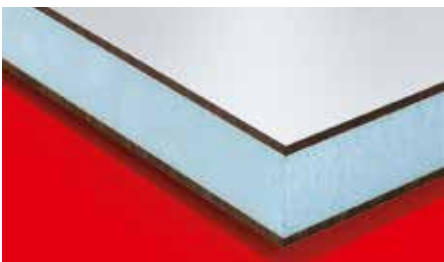

### Sandwich-Elements

The Max Exterior panels in F-Quality also come polished on just one side for use in sandwich elements.



### Processing (Compact Elements)

FunderMax offers CNC controlled processing and panel cutting. With state-of-the-art devices, it is possible to produce everything: from simple cutouts for mounting the facade panels, to intricate milling for balcony elements. We can make just about anything you can dream up.



## Professional Consulting

With our services you can use our products even more effectively. For example, take advantage of our free architect consulting and comprehensive system solutions. The same is of course also true if you have any questions about the content of this brochure or the designs and technology.

# Max Exterior F-Quality

Max Exterior is a high-quality construction product which is used especially for long-lasting balcony and facade claddings. Max Exterior panels are duromer high-pressure laminates (HPL) in accordance with EN 438-6 Type EDF with extremely effective weather protection. This weather protection consists of double-hardened acrylic polyurethane resins. They are produced in lamination presses under great pressure and at high temperatures. Max Exterior panels are, of course, labelled with the CE-Mark necessary for their use in building applications.

## SURFACES

- NT
- NH (Hexa)/NT (format 4100 x 1854 mm only)
- NG\* (Gloss)/NG (Gloss) (format 4100 x 1300 mm only)
- NY (Sky)/NT (format 4100 x 1300 mm only thicknesses 6 and 8 mm; limited decor range)

## FORMATS (aprox)

- 9'2 1/4" x 4' 3" = 39.25 sf (2800 x 1300 mm)
- 13' 5 1/8" x 4' 3" = 57.44 sf (4100 x 1300 mm)
- 9'2 1/4" x 6' 5/8" = 55.79 sf (2800 x 1854 mm)
- 13' 5 1/8" x 6' 5/8" = 81.65 sf (4100 x 1854 mm)

## CORE

F-Quality, flame-retardant, colour brown

## THICKNESSES

Panels with double-sided decor:  
 Thicknesses Tolerances (EN 438-6, 5.3)  
 4.0 - 4.9 mm ± 0.3 mm  
 5.0 - 7.9 mm ± 0.4 mm  
 8.0 - 11.9 mm ± 0.5 mm  
 12.0 - 13.0 mm ± 0.6 mm

Higher thicknesses on request in standard quality, Format XL.

Panels with sanded-reverse side:  
 For symmetrically structured sandwich elements.

Thicknesses Tolerances (EN 438-6, 5.3)  
 2.0 - 2.9 mm ± 0.2 mm  
 3.0 - 4.0 mm ± 0.3 mm

In order to be able to design the inner sides of balconies with a uniformly light look, it is also possible to produce Max Exterior panels with a white (rear) side using decor 0890 NT – Balcony white. As a result of the differing decor structure, the fastening spacings given in our Technical Information brochures should be reduced by about 15 %.

\* TO GET A PERFECT DESIGN OF THE FACADE CLADDING WITH NG SURFACE IT IS RECOMMENDED TO GLUE THE PANELS ON AN ALUMINIUM-SUBCONSTRUCTION. SUBCONSTRUCTION LIKE WOOD DO NOT HAVE THE RIGHT PROPERTIES TO AVOID A WAVY APPEARANCE OF THE CLADDING.

## Formats (production-sizes)

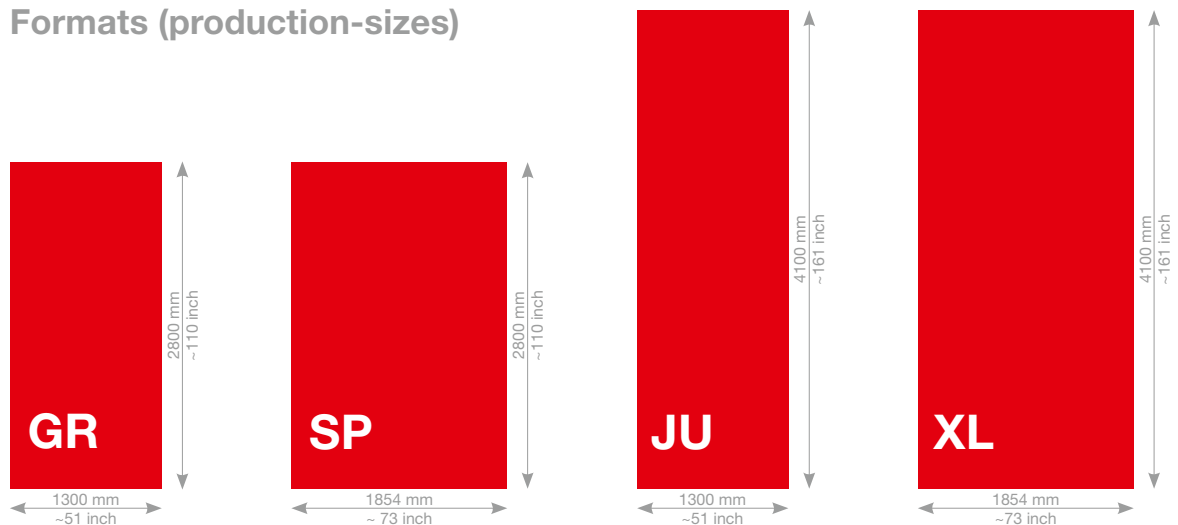

TOLERANCES +10 - 0 mm (EN 438-6, 5.3)  
 PANEL FORMATS ARE PRODUCTION FORMATS. IF EXACT DIMENSIONS AND ANGLES ARE NECESSARY, WE RECOMMEND AN ALL-SIDED BLANK. DEPENDING ON THE METHOD OF TRIMMING, NET SIZE IS REDUCED BY CA. 10 mm.

**STRUCTURE MAX EXTERIOR PANEL**

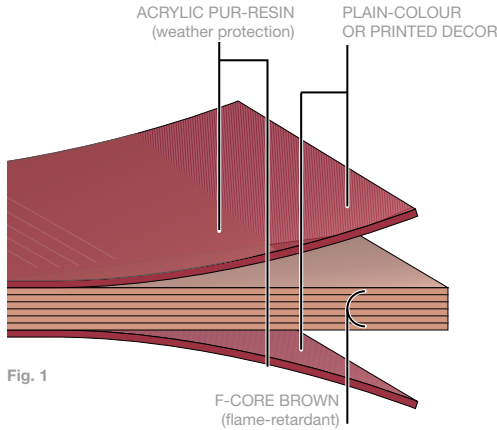

Fig. 1

**PHYSICAL DATA**

PROPERTIES	TEST METHOD	ASSESSMENT	STANDARD VALUE	ACTUAL VALUE
<b>LIGHT-FASTNESS AND WEATHER RESISTANCE (SURFACE NT)</b>				
Artificial weathering*	EN ISO 4892-2 3000 h	EN 20105-A02 greyscale	≥ 3	4-5
<b>MECHANICAL PROPERTIES</b>				
Apparent density	EN ISO 1183-1	g/cm³	≥ 1.35	≥ 1.35
Flexural strength	EN ISO 178	MPa	≥ 80	≥ 80
Modulus of elasticity	EN ISO 178	MPa	≥ 9.000	≥ 9.000
Coefficient of thermal expansion	DIN 52328	1/K		18 x 10 <sup>-6</sup>
Thermal conductivity		W/mK		0.3
Water vapour diffusion resistance				ca. 17.200 μ
<b>FIRE BEHAVIOUR</b>				
Europe	EN 13501-1	MA39-VFA Vienna	Euroclass B-s2, d0 for 6 - 13 mm**	
Switzerland		EMPA Dübendorf	Fire classification 5.3 for 6 - 13 mm	
France	NFP 92501	LNE	M1 for 2 - 10 mm	
Spain	UNE 23727-90	LICOF	M1 for 6 - 10 mm	
<b>PERMITS</b>				
Facade permit Germany		Institut für Bautechnik Berlin	6, 8, 10 mm, Approval-No. Z-10.3-712	
ETB guidelines for building components which safeguard against falls, June 1985. Balcony railings.		TU Hannover	Passed (depending on building regulation and railing construction 6, 8 or 10 mm panel thickness)	
Avis technique Frankreich		CSTB	6, 8, 10 and 13 mm, wood- and metal subconstruction Avis Technique n° 2/14-1623 Avis Technique n° 2/16-1753 Avis Technique n° 2/12-1505* V1 Avis Technique n° 2/16-1749 Avis Technique n° 2/13-1565* V1 Avis Technique n° 2/16-1716	
BBA		British Board of Agreement	12/4927	

Table 1

FOR THE SURFACE NT APPLIES A GLOSS DEGREE TOLERANCE OF +/- 5 GE MEASURED AT 60°

\*DECOR AUTN: ARTIFICIAL WEATHERING EN ISO 4892-2: 1500H; ASSESSMENT ACCORDING GREYSCALE EN 20105-A02: 2  
 \*DECOR INDIVIDUALDECOR: ARTIFICIAL WEATHERING EN ISO 4892-2: 3000H; ASSESSMENT ACCORDING GREYSCALE EN 20105-A02: 3  
 ALL THE RESPECTIVE CURRENT CERTIFICATES AND APPROVALS ARE AVAILABLE IN THE DOWNLOAD SECTION AT WWW.FUNDERMAX.AT.  
 PLEASE OBSERVE ALL VALID BUILDING REGULATIONS. WE WILL ASSUME NO RESPONSIBILITY IN THIS REGARD.

\*\*EXCEPTION IS PODIO-BALCONY FLOOR PANEL; EUROCLASS B-s2,d0 FOR 6 - 20 MM

## Resource and Environmentally Friendly Facade Panels

We are specialists in the processing of renewable raw materials – and have been for over 100 years. Our production cycles are closed, production waste is either recycled back into the production process or used to generate energy in our green energy district heating plants. This works so well, that today as a private company we provide district heating to over 3,000 households.



### QUALITY MANAGEMENT SYSTEMS

FunderMax has oriented its production facilities and processes on internationally recognized standards such as ISO 9001, ISO 14001, OHSAS 18001 and EN 16001. This fact gives all customers the assurance that they have in their hands a high-quality construction product. And in its procurement of raw materials and intermediate products, FunderMax orients itself on up-to-date standards such as FSC® and PEFC\*.

### SUSTAINABLE PRODUCTION

Max Exterior is made from natural fibre panels — around 65%, by weight — consisting largely of wood that has been processed into “kraft papers”. This wood is a by-product of sawn lumber production or of sawmills. We source these raw materials from vendors certified according to the standards FSC® or PEFC. These standards ensure that the wood is produced in compliance with internationally applicable rules for sustainable forestry.

The kraft papers are impregnated with synthetic resins in impregnation facilities, dried, and pressed into durable, moisture-resistant panels under high pressure and heat. These panels do not contain organic halogen (or chlorine, fluorine, bromine, etc.) compounds such as are found in greenhouse gases or PVC. They contain neither asbestos nor wood protection agents (fungicides, pesticides, etc.) and are free of sulphur, mercury and cadmium.

The exhaust air removed from the drying process is treated using a process of regenerative thermal oxidation, with the resulting heat being fed back into said drying process. For its installation of this efficient exhaust air treatment, FunderMax was awarded the “Klima:aktiv” award for best practices by the Austrian Energy Agency and the Austrian Federal Ministry of the Environment. This avoids CO<sub>2</sub> emissions of ca. 10,000 tons annually at the production site.

\*PLEASE FIND FURTHER INFORMATION AT [WWW.FUNDERMAX.AT](http://WWW.FUNDERMAX.AT).





### WASTE DISPOSAL

Chips and shavings produced by processing (cutting and milling) are not hazardous to human health. This also means that waste can even be disposed of thermally without the emission of environmental toxins such as hydrochloric acid, organic chlorine compounds or dioxins, assuming modern heating systems. At appropriately high temperatures, and assuming both sufficiently long retention of the combustion gas in the combustion space and a sufficient oxygen supply, Max Exterior decomposes into carbon dioxide, nitrogen, water and ash. The energy emitted via this process can be put to use. Disposal in properly managed commercial waste disposal sites is unproblematic. As a matter of principle, country-specific laws and regulations with regard to disposal must be adhered to.

# Guidelines for handling Max Exterior panels

## TRANSPORT AND HANDLING

Handle Max Exterior panels with care in order not to damage the edges and surfaces of the high-quality material. In spite of the excellent surface hardness and the installation protection film, the stack weight of Max Exterior panels is a possible cause of damage. Therefore, any form of dirt or dust between the panels must definitely be avoided.

Max Exterior panels must be secured against slippage during transport. When loading or unloading, the panels must be lifted. Do not push or pull them over the edge.

**Transport protection films must always be removed from both sides at the same time.**

Maybe there is a stronger adhesion of the foils on the surface because of the storage. Therefore there might be a higher effort to remove the foil. That does not have any effect to the quality of the product and does not result into a complaint. The transport protection film must not be exposed to heat or direct sunshine.

## MOUNTING

During the handling and installation of the Max Exterior panels you have to use your individual protection equipment - especially gloves and helmet - adapted to the working process.

Please always use clean gloves with a non-abrasive, non-slip coating to prevent soiling or damaging of the panel surface.

## STORAGE AND AIR CONDITIONING

Max Exterior panels must be stacked horizontally on flat, stable supports and supporting panels. The goods must lie completely flat.

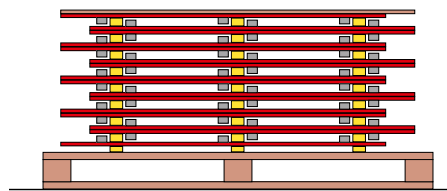

Fig. 1

Cover plates must always be left on the stack. The top cover should be weighted down. After removal of panels, PE films must again be closed over the stack.

The same applies, in principle, for cut-panel stacks. Incorrect storage can lead to permanent deformation of the panels.

Max Exterior panels should to be stored in closed rooms under normal climatic conditions, temperature about 15°C - 25°C and relative humidity at about 50% - 65%. Climate differences on the two surfaces of a panel are to be avoided.

With pre-installed fastening elements, therefore, care is to be taken that the climatic effect is uniform on all sides. Use intermediate layers of wood or plastic.

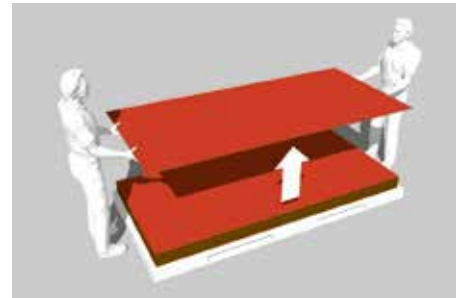

Fig. 2



Fig. 3

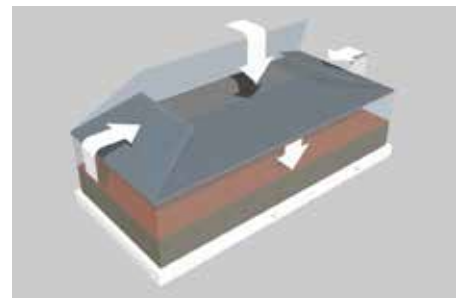

Fig. 4

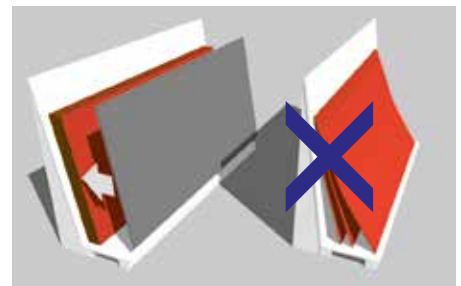

Fig. 5

## Hint for final cleaning

Please ensure that foreign substances (e.g. drilling and machine oils, greases, adhesive residues, etc.) that soil the surface of the Max Exterior panels during storage, installation and use are removed immediately without leaving any residue.

We recommend using non-greasy sunscreens (e.g. Physioderm Physio UV 50 Spray), as soiling with conventional sunscreens is often impossible to remove completely even when cleaned immediately.

No responsibility will be accepted for any complaints regarding color, gloss and surface of the panels should these recommendations fail to be observed.

For details on how to properly clean Max Exterior panels, see page 105.



Fig. 6

# The processing of Max Exterior panels

## General

The surface area of Max Exterior panels is highly resistant. The processing properties of the Max Exterior panels are similar to those for the processing of hard-wood. Hard metal cutting tools have been tested and are indispensable when working with Max Exterior panels. If a long tool life is required, diamond-tipped (DP) tools should be used. Sharp blades and smooth functioning are both necessary elements to ensure a faultless processing of the material. Breaking-off, splintering and chipping of the decorative side is a result of incorrect handling or unsuitable tools. Machine tables should be as flat and smooth as possible, so that no chips collect - which can damage the surface area. The same also applies for work surfaces and the controlling of hand-held machines.



Fig. 1

## Safety measures

This is simply a list of the recommended personal protective equipment. The standard required protective equipment for the given field of work should be used (work clothes, safety boots, hairnets,...).

EN 388		Mechanical risks	
The higher the digit, the better the test result.			
Test resistance	Digit	Test resistance	Digit
Abrasion	0 - 4		
Blade cut	0 - 5		
Tear	0 - 4		
Puncture	0 - 4		



### GLOVES

Non-bevelled cut edges are sharp and pose a risk of injury. To protect against the handling of freshly cut Max Exterior panels, gloves of protection category II with a minimum cut resistance of 2 should be used.



### DUST PROTECTION

As with the manufacturing of any other wood, the processing of Max Exterior panels can create dust. For sufficient respiratory protection, dust mask filters for e.g. should work.



### PROTECTIVE GOGGLES

As with the manufacturing of any other wood, tightly sealed eye protectors must be worn when working with Max Exterior panels.



### HEARING PROTECTION

During the mechanical treatment of Max Exterior panels the sound level can rise to above 80dBA. Please ensure that you have adequate ear protection at all times when working with these materials.

# General processing guidelines

When working with Max Exterior panels the ratio between the number of teeth (z), the cutting speed (v<sub>C</sub>) and the feed rate (v<sub>f</sub>) must be observed.

	v <sub>C</sub>	f <sub>z</sub>
	m/s	mm
Saw	40 – 60	0.02 – 0.1
Mill	30 – 50	0.3 – 0.5
Drill	0.5 – 2.0	0.1 – 0.6

### CALCULATION OF CUTTING SPEED

$$v_C = D \cdot \pi \cdot n / 60$$

v<sub>C</sub> – cutting speed

D – tool diameter [m]

n – tool rotational speed [min<sup>-1</sup>]

### CALCULATION OF FEED SPEED

$$v_f = f_z \cdot n \cdot z / 1000$$

v<sub>f</sub> – feed rate [m/min]

f<sub>z</sub> – tooth feed

n – tool rotational speed [min<sup>-1</sup>]

z – number of teeth

### CUTTING MATERIAL

Tools with hard blades (e.g. HW-Leitz) can be used. In order to extend tool life, the use of DP-tipped tools (DP polycrystalline diamond) is recommended.

### GENERAL ADVICE

If chip removal is not carried out regularly, this can quickly lead to damage of the blade. As a result the required engine power is increased and the tool life will be shortened. If the shavings are too small they will then scrape and eventually blunt the tool, therefore leading to a short tool life.

For single cuts, it is imperative that the vibration of the panels is prevented using used panels. Stack height is in compliance with machine capacity.

## Tooth forms



Fig. 2

### TR/TR

**(Trapezoid tooth/Trapezoid tooth)**

Preferred tooth forms for the cutting of hard abrasive laminates.



Fig. 3

### FZ/TR

**(Flat tooth/Trapezoid tooth)**

Tooth form for the processing of laminates and Max Exterior panels.



Fig. 5

### HZ/DZ

**(Pendulum tooth/Concave tooth)**

Tooth forms for excellent and below on machines without scoring units.

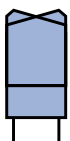

Fig. 4

### WZ/FA

**(variable tooth with bevel)**

An alternative to FZ/TR tooth.



Fig. 6

### HZ/FA

**(Concave tooth with bevel)**

Similar use to HZ/DZ only with longer machine life without scoring units.

# Cutting

## Vertical panel splitting, table and sliding table saws without scoring unit

For circular saw blades with a positive rake angle and saw shaft under the work piece. Due to the positive rake angle, the cutting pressure takes effect using the stable table support.

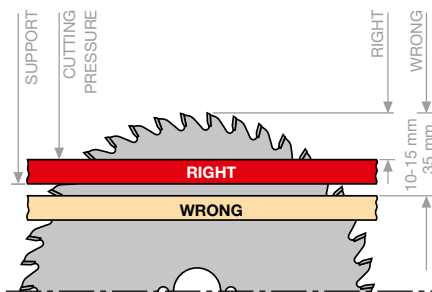

Fig. 1

For circular saw blades with a negative rake angle and saw shaft above the work piece. Through the negative rake angle, the cutting pressure takes effect using the stable table support.

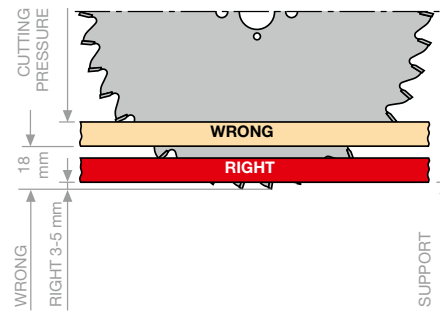

Fig. 2

### ADJUSTMENT

- Visible side upwards;
- very narrow saw guide;
- smooth alignment of the Max Exterior panels on the workbench with the saw blade;
- correct blade protrusion.

Depending on the blade protrusion, the entrance and exit angles and therefore the quality of the cutting edges will change. If the upper cutting edges are unclear, the saw blade will need to be adjusted to a higher level. The saw blade must be adjusted to a lower level for an unclear cut of the underside. This is how the best height adjustment is determined.

## Sliding table saws and panel splitting machines with scoring unit and pressure beams.

### SCORING CIRCULAR SAW BLADE

In order to achieve a good cutting edge quality on the saw exit side, the use of a scoring unit is recommended. The cutting width of the scoring circular saw blade is slightly bigger than that of the main circular saw blade so that the exiting teeth of the main saw no longer touch the cutting edge. As a secure and smooth circulation of the work pieces can only be guaranteed using a pressure device, divided scoring circular saw blades are used on the table and sliding table machines.

Panel splitting unit with scoring aggregate and pressure device.

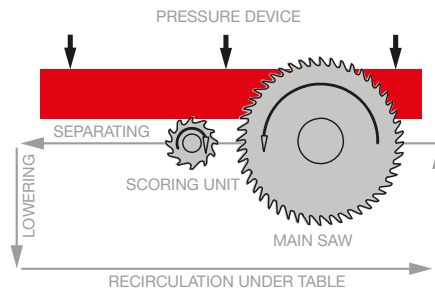

Fig. 3

Operating diagram of the conical scoring circular saw. For the maintenance of tools (always step-by-step), the cutting widths must be aligned with one another.

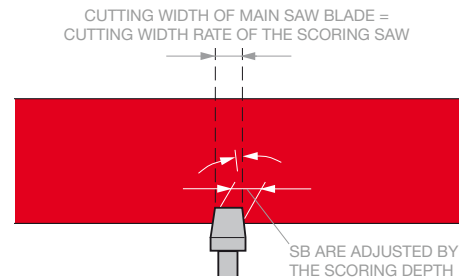

Fig. 4

## Cutting with handheld tools

Finely toothed handheld saws are suitable for single cuts. Low set teeth are preferable. The sawing should be done from the panel surface area, where the saw is at an angle of approximately 30° relative to the surface area.

For straight cuts with handheld circular saws, a stop bar or guide rail should be used. Saw blades suitable for hard metal use should be used. The sawing takes place from the panel underside using the following tooth forms: Variable tooth for coarse cuttings, flat tooth/trapezoid tooth for clean cuts of Max Exterior panels and panels which are bonded on both sides.

## Milling machines – edge processing

### EDGE PROCESSING BY HAND

For the finishing of edges, files are suitable. The file direction moves from the decorative side to the core. For broken edges, fine files, plane files, sand paper (100-150 grain) or scrapers can successfully be used.

### EDGE PROCESSING WITH HANDHELD MACHINES

To mill bevels electric hand planes with bevel or bevel grooves can be used. Hand routers are used along with hard metal tools for special tasks (e.g. wash basin recess, Trax-coupling etc.). In order to protect the Max Exterior panel surface areas, the supporting surface of the hand routers should be covered with for e.g. panel parts, no felt! Milling shavings should be carefully removed.

Milling cutter diameter 10-25 mm  
Cutting speed  $v_c$  1 30-50 m/sec.

We recommend hard metal tipped milling cutters, which are also available with indexable inserts. For a better functioning of your tools, height-adjustable milling cutters are preferable. The sharp edges will be broken down afterwards.

# Drilling

Solid hard metal twist or dowel drills are used for drilling. In machining centres, the use of the main spindle instead of the drilling beams for a rpm of 2000 – 4000 min<sup>-1</sup> and a feed rate of 1.5 – 3 m/min, is recommended. The exit speed of the drill must be carefully selected so that the melamine surfaces of the Max Exterior panels are not damaged. Shortly before the drill exits the work piece in full diameter, the feed rate must be reduced by 50%. When drilling through-holes, the counter-pressure should be built up using hardwood or equivalent material to prevent break-offs of the melamine surface.



Fig. 1

**For the screwing of blind holes perpendicular to the panel levels, please ensure:**

- Tap drill diameter (D) = screw diameter minus approx. 1 screw channel depth.
- Drilling depth (a) = Panel thickness minus 1-1.5 mm
- Screw-in depth = Drilling depth minus 1 mm

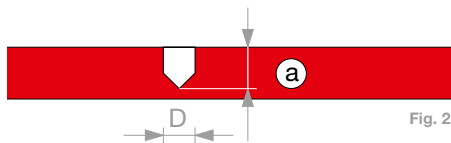

Fig. 2

**For screw fittings parallel to the panel level, please ensure:**

- The residual thickness (b) of the Max Exterior panels must be at least 3 mm.
- The hole diameter of the drillings parallel to the panel surface must be selected in such a way to avoid any splitting of the compact panels when tightening the screws.
- For screw fittings parallel to the panel surface, metal sheet and chip board screws are suitable.
- In order to ensure respective stability, a minimum depth of engagement of 25 mm is necessary.



Fig. 3

For the drilling of Max Exterior panels, drills for plastics are best suited. This means twist drills with a point angle of  $\leq 90^\circ$ . They have a large gradient and chip space. The sharp drill bits mean that these drills are also very suitable for the drilling of through-holes as they cut cleanly through the underside of the material.

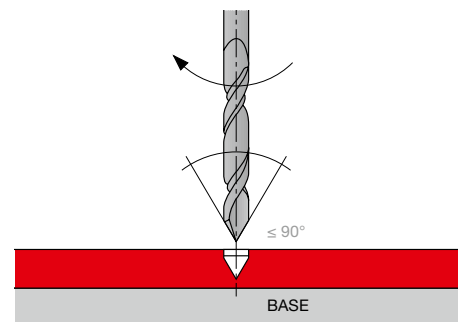

Fig. 4





LEITZ-DRILL SHAFT 10 mm

Fig. 5



LEITZ-DRILL HW-SOLID, Z2

Fig. 6



MBE VHM FACADE DRILL

Fig. 7

**UNIVERSAL DRILLING OF BLIND AND THROUGH-HOLES.**

**The following machines are used:**

Point-to-Point drilling machines, through feed drilling machines, CNC machining centres, box column drill, inlet-fitting drilling machine, drilling units, hand drills.

**Information on the drills:**

Flat roof drill bits. Shaft diameter identical to blade diameter. Adaptable for shaft-D 10 mm with reducing bush TB 110-0 or PM 320-0-25.

**DRILLING OF BLIND HOLES**

In particular dowel holes in cabinetry. Particularly suitable for the tear-free drilling of blind holes in visible quality as well as the processing of panel materials. Not suitable for through-holes!

**The following machines are used:**

Point-to-Point drilling machines, through feed drilling machines, inlet fitting drilling machines, drilling units, CNC machining centres.

**Information on the drill:**

Roughing geometry with extremely clean cut. Model HW-solid with highly wear-resistant HW varieties. High stability and long service life. Polished chip space for minimal friction and feed force.

Pre-punching ensures better control for hand drilling.

**Diamond-tipped drills are not suitable for Max Exterior panels.**

**MBE VHM FACADE DRILL**

MBE-ARTICLE NO.: 1360702 – 8 mm  
 MBE-ARTICLE NO.: 1360703 – 8.5 mm  
 MBE-ARTICLE NO.: 1360704 – 10 mm

**HELP FOR CENTRING DRILL**

Helps at primary drilling in the substructure  
 SFS Article No.: 1320658



HELP FOR CENTRING DRILL

Fig. 8

# Cutting and Milling of Compact Panels - Recommendations for Processing Problems

## FIXING PANELS ON A MACHINE TABLE

There are basically two ways to fix or tension Max Exterior panels on machine tables depending on the type of processing to be performed:

### a.) Fixing by means of suction cups

When milling to size or edging both sides of a panel section, it is recommended to fix the panel in place using suction cups at specific points.

NOTICE: The proper distance between the suction cups must be observed!

### b.) Fixing by means of MDF protective boards

When milling to size, edging one side, making perforations or free-form milling a panel section, it is recommended to fix the panel in place using MDF protective boards (protective boards can be used several times).

The following applies for both options: It must be ensured that the suction cups provide sufficient holding power for the work to be performed. If the suction cups do not provide sufficient fixing or tensioning power, the suction cup seals (e.g. the sealing rings) must be checked.

## SPACING OF THE SUCTION CUPS

As a rule, the material being processed should not be subjected to any vibrations. Therefore, it is important that the suction cups are placed at an appropriate distance from the freely protruding panel edge based on the thickness of the panel.

The following applies: the more suction cups and the smaller the distance from the free protruding edge of the panel, the cleaner the milling pattern. As a rule of thumb, suction cups should be placed in the area to be processed in a

grid of max. 300 mm with a maximum distance from the free protruding edge of the panel of no more than 30 mm. The best results are achieved by using an MDF protective board (e.g. 19 mm thick), as this enables a full-surface fixing of the Max Exterior panel on the machine table with suction cups.

## CHOICE OF MACHINING TOOL

Generally speaking, Max Exterior panels can be machined with solid carbide (VHM) and diamond (PCD) milling tools. The basic prerequisites for a clean milling pattern and a long service life are vibration-free tool holders and spindles. NOTE: The ball bearings must be properly maintained!

Diamond tools have proven particularly suitable for processing a large amount of panels or a high number of running meters. Smooth-running milling cutters with a shank diameter of min. 10 mm in combination with straight continuous DIA cutting edges (2+1 knife) are especially suitable for format milling.

It is essential that the feed rate and the cutting speed be adjusted for the specific job and cutter based on the material being processed. We recommend always consulting the tool supplier first.

## CLAMPING SYSTEM OF THE MILLING TOOL

It is essential that the spindle be centered in the chuck to ensure the smooth running of the milling cutter. The more centered and play-free the milling cutter can be clamped in place, the better the result. Most machines are equipped with common tool holders such as collets, hydro grips or shrink chucks.

For the professional CNC machining of larger jobs, a Hydro Grip tool holder or shrink chuck is recommended as they guarantee the best tool clamping. It is important to ensure the proper maintenance

of all moving parts such as plain or ball bearings in order to avoid vibrations in every direction!

## EXTRACTION

The extraction or the extraction power must be adjusted accordingly for the material being processed to ensure that all the shavings are optimally removed.

If the extraction is not strong enough, there is a risk of heat development. This is due to shavings that remain between the cutter and the panel edge. High friction occurs at this point because the cutter can not eject the material any further. This can lead to burn marks on the panel edge.

## CNC MACHINING BY FUNDERMAX

FunderMax has their own machining center - Compact Elements. We are happy to machine Max Compact Interior, Max Compact Exterior, Max HPL and m.look panels to your specifications. Simply contact our customer service center for more information.

**FunderMax also offers trimming and processing services on its modern CNC-controlled equipment. We would be happy to receive your request.**



- 21 Qualifications
- 22 Function and advantages of a nonbearing, rear-ventilated facade
- 23 Material Characteristics
- 24 Mounting of Max Exterior panels with rivets on an aluminium-substructure
- 32 Secret mechanical fastening with undercut anchor
- 36 Secret glued fastening with gluing systems
- 42 The ME 01 system for the concealed mounting of Max Exterior facade panels
- 46 Important information on rear-ventilated facades supported by wooden substructures.
- 48 Error avoidance in wooden substructures
- 50 Standards for Building with Wood
- 51 Design possibilities with Max Exterior panels
- 52 Mounting of Max Exterior panels with screws on a wooden substructure
- 56 Facade System Scaleo
- 62 Facade System Modulo

**NOTE**

PLEASE CHECK ADDITIONAL AT [WWW.FUNDERMAX.AT](http://WWW.FUNDERMAX.AT) FOR THE LATEST VERSION OF THIS BROCHURE.

THE DIAGRAMS IN THIS TECHNICAL INFORMATION ARE SCHEMATICAL REPRESENTATIONS AND ARE NOT TRUE TO SCALE. THIS ISSUE REPLACES ALL OTHER ISSUES OF EXTERIOR TECHNIQUES BROCHURES OF FUNDERMAX WHICH WERE PUBLISHED BEFORE.



## Qualifications

**FunderMax GmbH**  
A-2355 Wiener Neudorf

**Z-10.3-712**



**A**

Max Exterior panels in thicknesses of 6–13 mm are EUROCLASS B–s2, d0 in accordance with EN 13501–1.

**CH**

Fire Classifications 5 (200°C). 3 for 6–13 mm Max Exterior Type CGF–VKF Permit. No. 9683

**D**

Max Exterior panels in thicknesses of 6–10 mm are B–s2,d0 in accordance with EN 13501–1 and have the General Building Construction Supervision Permit of the „Institut für Bautechnik“, Berlin. Permit Number: Z–10.3-712

**F**

Max Exterior panels in thicknesses 2–10 mm are M1 in accordance with NFP 92501. The Avis technique for wooden substructures and metal substructures can be found on page 7.

Actual and more extensive documentation to all test methods and permits according Max Exterior panels you will find at our website:

[www.fundermax.at/downloads/](http://www.fundermax.at/downloads/)

# Function and advantages of a nonbearing, rear-ventilated facade

## INSULATION

The non-bearing, rear-ventilated facade (VHF) system can be designed for different energy requirements with an individually calculated insulation. Insulation material of any desired thickness can be used. This means insulation values can easily be achieved that are typical of low-energy houses and comply with the current energy savings regulations. Based on the energy needs, the insulation maximizes the heat retention of the building. High summer temperatures in the interior of the building are regulated. By reducing the amount of energy needed for heating, the non-bearing facade minimizes the carbon dioxide emissions of the heating system.

## PROTECTION AGAINST CONDENSATION WATER

The construction of the non-bearing, rear-ventilated facade (VHF) decreases the vapor diffusion resistance from the interior to the exterior of the building; Moisture from the construction or use of the building is removed through the rear-ventilation space. Thus the lasting function of the insulation can be ensured and makes a significant contribution to a pleasant and healthy indoor climate.

## PROTECTION AGAINST RAIN

The VHF meets the standards for stress group III according to DIN 4108-3 and is driving-rain proof. The rear-ventilation space between insulation and panel (weather protection) quickly dissipates moisture.

## PROTECTION AGAINST NOISE

Depending on the thickness of the insulation layer, measurements of the panels and the proportion of open joints, noise protection can be increased by up to 14 dB.

## ECOLOGY

Minimization of CO<sub>2</sub> emissions. Environmental objectives are fulfilled both for new buildings, as well as for renovation of existing buildings, through the use of rear-ventilated facades: The measurable reduction in energy required for heating minimizes the carbon dioxide emissions, one of the greatest causes of environmental pollution. State and regional subsidy programs are still available for energy-saving facade renovations.

## ECONOMY

The economic aspects can also be found again in the requirements of sustainable construction: Long service life, long maintenance intervals and the subsequent return of the components to their resource cycle are the essential points.

## COST CERTAINTY

The cost estimation for a non-bearing, rear-ventilated facade, even in the case of renovations, is basically an exact cost planning.

## ADVANTAGES OF THE NON-BEARING, REAR-VENTILATED FACADE

- Exact cost estimation of the facade
- Installation under any weather conditions
- Savings through the shorter scaffolding times
- No disposal costs during the installation phase
- Long maintenance intervals and low follow-up costs
- Long-term value retention and appreciation of the building

## BASICS OF CONSTRUCTION

During construction and installation, care is to be taken that the material is not exposed to standing water. This means that the panels must always be able to dry out. Connections of Max Exterior panels to one another always have to be made in the same panel direction. Max Exterior can show deviations from being flat (see EN 438-6, 5.3), and this is to be compensated for by the subconstruction being executed so that it is stable and flat. All connections to other components or to the background must be executed firmly. Elastic intermediate spacers to the subconstruction elements and also between subconstruction elements which permit a greater tolerance than ±0.5 mm must definitely be avoided.

Please observe always all valid building regulations.

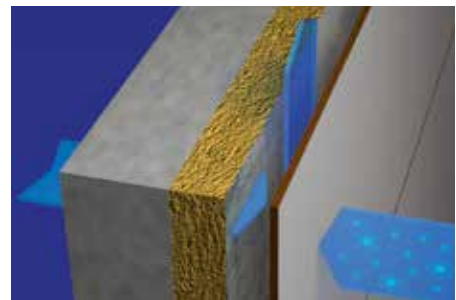

DIFFUSION PERMEABLE

Fig. 1

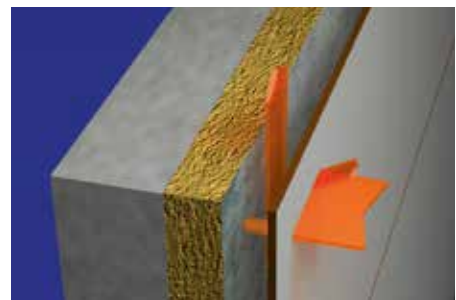

HEAT INSULATING

Fig. 2

# Material Characteristics

Max Exterior shrinks when it loses moisture! Max Exterior expands when it absorbs moisture! When working and constructing with the panels, thought must be given to this possible dimensional change.

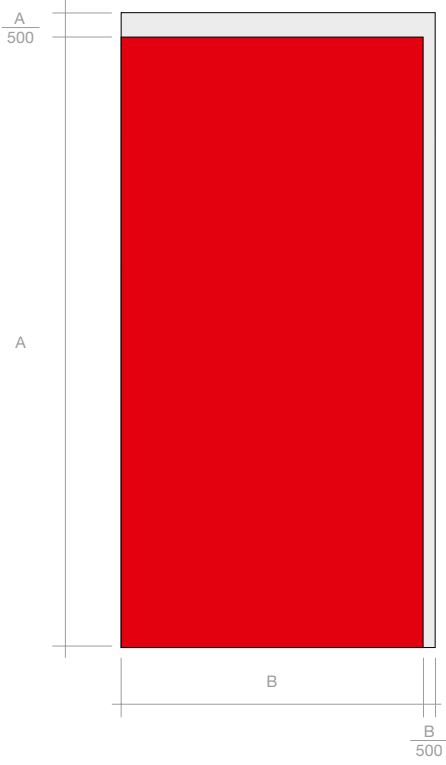

FOR MAX EXTERIOR IT IS BASICALLY HALF AS MUCH LENGTHWAYS AS WIDTHWAYS (SEE PROPERTIES ON PAGE 7; LENGTHWAYS IS RELATIVE TO THE NOMINAL PANEL FORMAT)

ELEMENT LENGTH = A  
ELEMENT WIDTH = B

$\frac{A \text{ OR } B \text{ (IN mm)}}{500} = \text{EXPANSION CLEARANCE}$

Fig. 3

# Mounting of Max Exterior panels with rivets on an aluminium-substructure



Fig. 1

## FASTENINGS

Alu-Blind rivet with big head colour lacquered on aluminium-substructures.  
 Rivet sleeve: material-no. EN AW-5019 acc. DIN EN 755-2  
 Rivet pin: steel material-no. 1.4541  
 Pull-off strength of rivet pin:  $\leq 5.6$  KN  
 Diameter of drill hole in Max Exterior panels: Sliding points: 8.5 mm or as required  
 Fixed points: 5.1 mm  
 Diameter of drill hole in the aluminium substructure: 5.1 mm

SUPPLIERS OF FASTENING AND SUBSTRUCTURES YOU WILL FIND ON PAGE 106/107 OR AT „WWW.FUNDERMAX.AT“.

## SUBSTRUCTURE

The aluminum substructure has to observe the requirements of the national standards and has to be installed in accordance with the manufacturer specifications for the substructure. The aluminum substructure basically consists of vertical support profiles which are mounted on the wall using angle brackets. Due to the material properties of Max Exterior panels, fixed points and sliding points need to be made to fix the panels (page 26/27, Fig. 1/2). Metal subconstructions change their dimensions with differences in temperature. The dimensions of Max Exterior, however, alter under the influence of changing relative humidity. These changes in size of subconstruction and cladding material can be opposite to each other. When installing, attention must be paid to the expansion clearance.

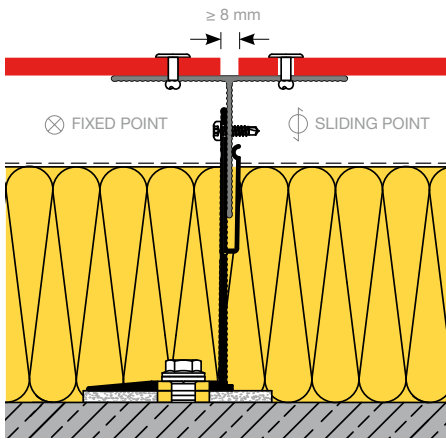

Fig. 2

## FIXED POINTS

Fixed points are used for uniform distribution (halving) of the expansion and shrinkage movements. The diameter of the drill hole in Max Exterior has to be made with 5.1 mm. Instead of the fix point drill you can use also a fix point socket.

MBE ART. NO. 1240201  $\varnothing$  8.5 mm  
 MBE ART. NO. 1240205  $\varnothing$  10 mm  
 SFS ART. NO. 1343279  $\varnothing$  8.5 mm



Fig. 3

## LOOSE POINT

The loose point is in addition to the fixed point able to hold the weight of the panel. And is placed in the same level. Expansion and shrinking are not constrained (page 26/27, Fig. 1/2).

MBE FIXED-POINT SLEEVE SET PLUS ART.NR. 1240405 INCLUDING  
 100 PCS. FIXED-POINT SLEEVE  $\varnothing$  10MM  
 100 PCS. FLOATING-POINT SLEEVE  $\varnothing$  10 MM, SLOTTED HOLE 5.2 X 7.7 MM  
 (DRILL HOLE TOLERANCE: 10.0 - 10.03 MM)



Fig. 4

## NOTE

PLEASE NOTE, WHEN USING A FIXED-POINT SLEEVE WITH A DIAMETER OF 10 MM FOR FLOATING-POINT FIXING, THE RIVET HEAD MUST HAVE A DIAMETER OF AT LEAST 16 MM.



**SLIDING POINT**

The diameter of the drill hole in Max Exterior must be drilled larger than the diameter of the fastening, depending on the required expansion clearance. This is the shaft diameter of the fastening plus 2 mm for every meter of cladding material starting from the fixed point. The head of the fastening must be big enough so that the drill hole in Max Exterior is always covered. The fastening is placed in such a way that the panel can move. Rivets are put in place with flexible mouthpieces. The defined clearance of the rivet head to the surface of the panel (0.3 mm) allows movement of the element in the drill hole (Fig. 7). The centre point of the drill hole in the subconstruction must coincide with the centre point of the drill hole in the Max Exterior panels. Drill with a centring piece. The fastenings should be put in place starting from the middle of panel outwards.

**The rivets must be put in place with a flexible mouthpiece, clearance 0.3 mm.**

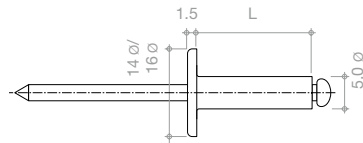

Fig. 6

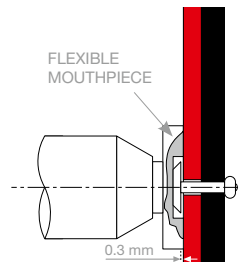

Fig. 7



Fig. 5

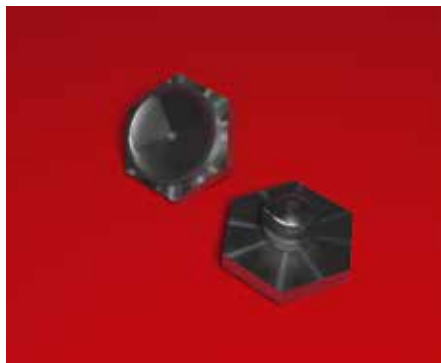

Fig. 8

**CURVED FORMS**

Curved forms are a special challenge for material and installer and require an accurate installation. Max Exterior panels can be formed “cold” with application of force.

Possible bending radius are depending directly on the thickness of panels. The thinner the panel, the minor the radii are possible.

**Fastening:**

In general the fastening has to be made mechanical. The fastening spacings have to be chosen according to the needs of the structural analysis. The panels have to be born on the curved substructure exactly. An accurate processing is mandatory. The regional building regulations and our brochure Technique Exterior must be observed. To achieve a perfect final result you need a sufficient amount of fastenings!

**MINIMUM POSSIBLE BEND RADII WITHOUT WINDLOAD**

PANEL THICKNESSES	RADIUS
6 mm	2500 mm
8 mm	3500 mm
10 mm	4500 mm

Table 1

**TABLE FOR LOAD ON SINGLE SPAN/WIND LOAD\***  
MAX EXTERIOR PANELS RIVETED ON ALUMINIUM SUBSTRUCTURE

PANEL THICKNESS LOAD q (kN/m²)	6 mm		8 mm		10 mm	
	max b (mm)	max a (mm)	max b (mm)	max a (mm)	max b (mm)	max a (mm)
<b>GERMANY</b>						
0.50	600	600	700	700	800	800
1.00	600	431	700	539	800	551
1.50	600	311	700	373	800	455
2.00	537	261	700	280	800	337

Values acc. to DIN 1055-T4 or DIN 18516 and permit Z-10.3-712

<b>AUSTRIA*</b>						
0.50	781	662	970	649	1146	769
1.00	657	394	815	463	964	457
1.50	594	314	737	354	871	417
2.00	537	261	686	286	811	332

Values acc. to ÖNORM B 4014-1,2 or EN 1991-1-4 and permit Z-10.3-712

<b>SWITZERLAND*</b>						
0.50	781	662	970	649	1146	769
1.00	657	394	815	463	964	457
1.50	594	314	737	354	871	417
2.00	537	261	686	286	811	332

Values acc. to SIA-Standard 261 or Z-10.3-712

**FASTENING SPACINGS  
FOR AUSTRIA AND SWITZERLAND**

If the specified axis dimension „b“ is not fully utilized, then the allowable mounting distance „a“ can be calculated as follows (source: Typenstatik Max Exterior Fassadenplatten Dipl.-Ing. Gerald Segeth, Dobel 18. 04. 11):

When installing a 8 mm single span panel with a wind load of 0.5 kN, the following applies: max b = 970 mm and max. a = 649.

If a value of 900 mm is used for „b“ for example, then the maximum allowable „a“ is calculated as follows:

$$\text{allow a} = \frac{\text{max b}}{\text{for given b}} * \text{max a}$$

Example:

$$\text{allow a} = \frac{970 \text{ mm}}{900 \text{ mm}} * 649 \text{ mm} = 699 \text{ mm}$$

Table 1

\*AN INTERPOLATION IS POSSIBLE ON BASE OF THIS VALUES.  
EXAMPLE: IF YOU DONT USE MAX B IN TOTAL IT APPLIES: PERMITTED A = (MAX B/EXISTING B) \* MAX A  
NOTE: PERMITTED A < MAX B

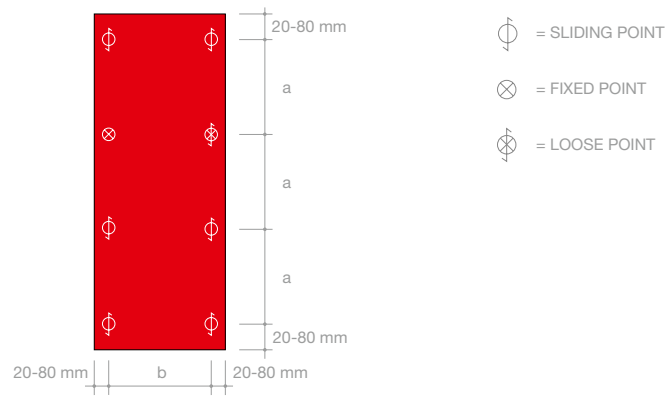

Fig. 1

\* DIMENSION TABLES FOR THE WIND LOAD RANGE FROM 0.3 KN/M² TO 2.6 KN/M² ARE AVAILABLE UPON REQUEST FROM THE FUNDERMAX SUPPORT TEAM.

**TABLE FOR LOAD ON DOUBLE SPAN/WIND LOAD\***  
MAX EXTERIOR PANELS RIVETED ON ALUMINIUM SUBSTRUCTURE

PANEL THICKNESS	6 mm		8 mm		10 mm		
	LOAD q (kN/m²)	max b (mm)	max a (mm)	max b (mm)	max a (mm)	max b (mm)	max a (mm)
<b>GERMANY</b>							
0.50	600	600	700	700	800	800	
1.00	600	373	700	400	800	420	
1.50	600	249	700	320	800	280	
2.00	537	208	700	240	800	210	

Values acc. to DIN 1055-T4 or DIN 18516 and permit Z-10.3-712

**AUSTRIA\***

0.50	974	425	1209	417	974	689	
1.00	759	295	1012	276	819	410	
1.50	620	241	826	271	740	302	
2.00	537	208	716	235	689	244	

Values acc. to ÖNORM B 4014-1,2 or EN 1991-1-4 and permit Z-10.3-712

**SWITZERLAND\***

0.50	974	425	1209	417	974	689	
1.00	759	295	1012	276	819	410	
1.50	620	241	826	271	740	302	
2.00	537	208	716	235	689	244	

Values acc. to SIA-Norm 261 or Z-10.3-712

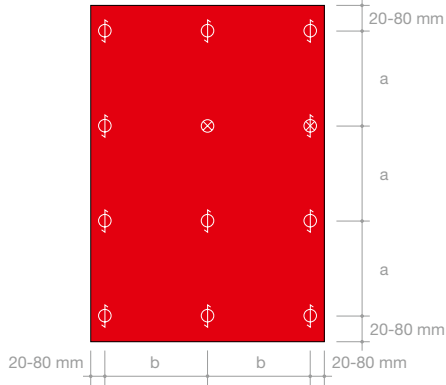

DOUBLE SPAN PANEL

Fig. 2

- = SLIDING POINT
- = FIXED POINT
- = LOOSE POINT

Table 2

\*AN INTERPOLATION IS POSSIBLE ON BASE OF THIS VALUES.  
EXAMPLE: IF YOU DONT USE MAX B IN TOTAL IT APPLIES: PERMITTED A = (MAX B/EXISTING B) \* MAX A  
NOTE: PERMITTED A < MAX B

**EDGE SPACINGS**

For reasons of stability and flatness, the edge spacings must be kept to without fail. The joints must be made at least 8 mm wide so that changes in size can take place without hindrance (page 24, Fig. 2).

**FASTENING SPACINGS**

These are to be chosen in accordance with the structural engineering requirements (calculations) or, if this is not necessary due to the local regulations, according to table no. 1 or 2. In the edge region of the construction, the spacings of the fastenings are to be chosen smaller than in the central region (pressure, suction).

\* DIMENSION TABLES FOR THE WIND LOAD RANGE FROM 0.3 KN/M² TO 2.6 KN/M² ARE AVAILABLE UPON REQUEST FROM THE FUNDERMAX SUPPORT TEAM.

# Construction-details horizontal sections Alu-substructure riveted

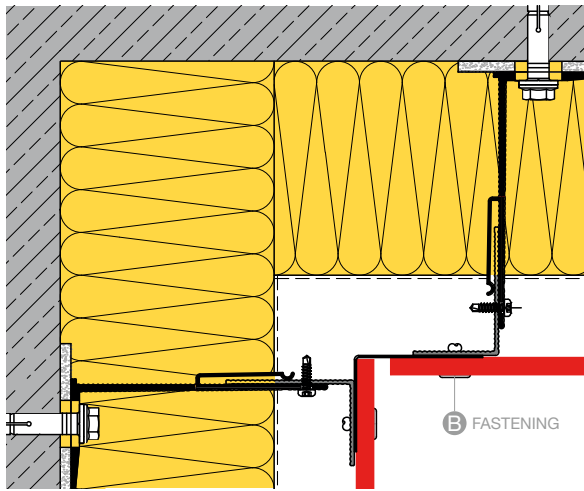

INTERNAL CORNER A106

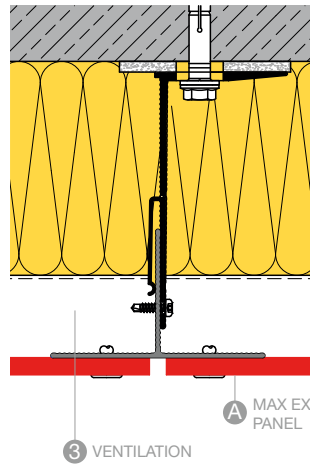

VERTICAL JOINT A107

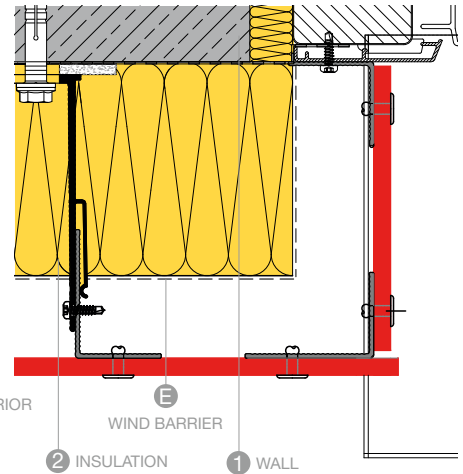

WINDOW REVEAL A104

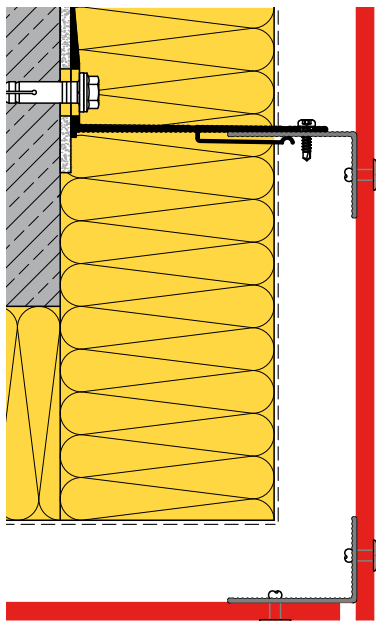

EXTERNAL CORNER A105

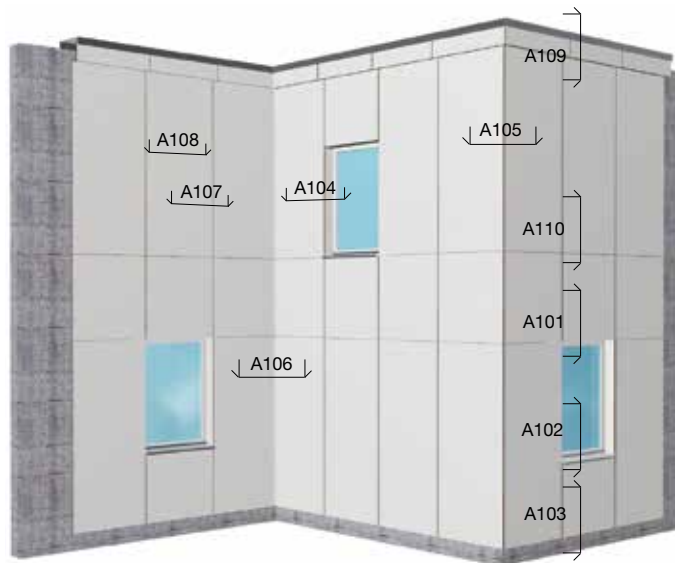

**NOTE**  
SUPPLIERS:  
SEE PAGES 106/107 AT THE  
END OF THE BROCHURE.

ALL PROFILES AND FASTENINGS ARE SHOWN IN THIS BROCHURE ARE PLANNING-  
SUGGESTIONS AND NOT PART OF THE FUNDERMAX DELIVERY PROGRAMME!  
ALL DRAWINGS IN THIS BROCHURE ARE NOT TRUE TO SCALE!

# Construction-details vertical sections Alu-substructure riveted

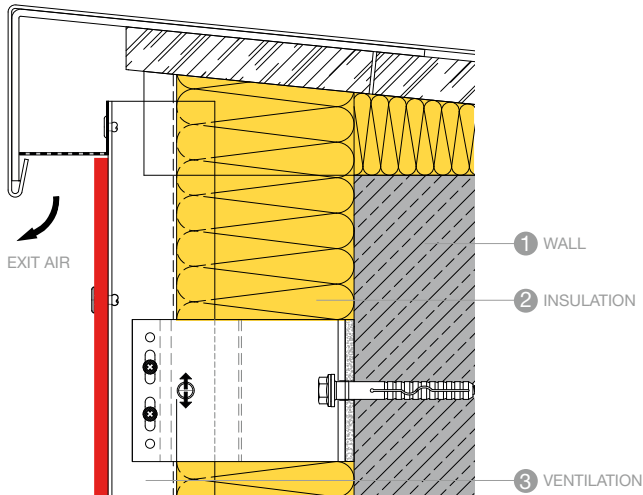

ATTIC CONNECTION A109

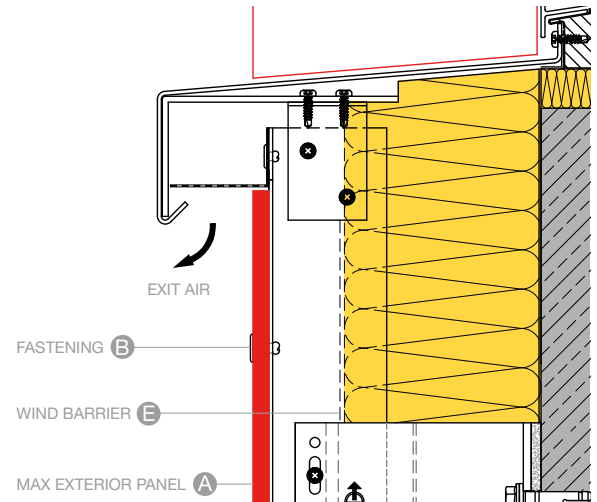

WINDOW SILL CONNECTION A102

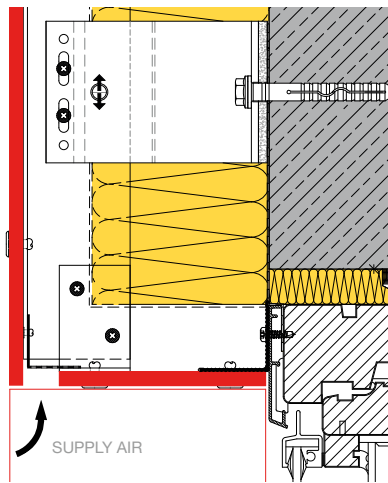

WINDOW LINTEL A101

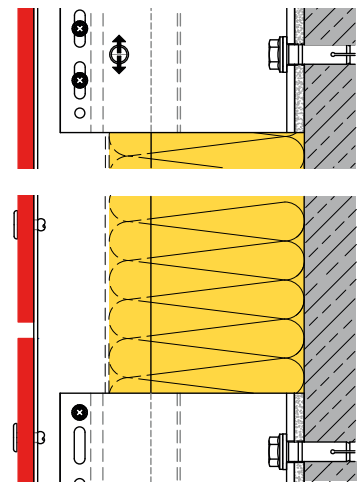

HORIZONTAL JOINT A110

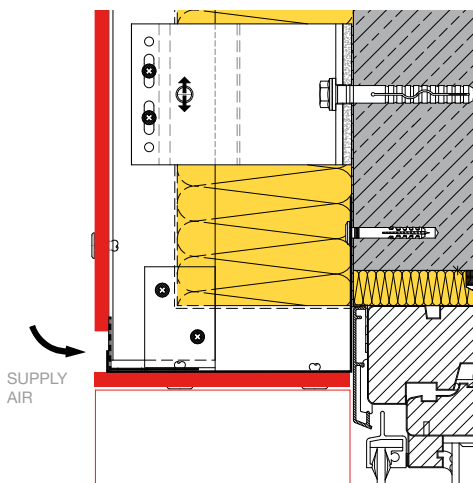

WINDOW LINTEL A101.2\*

\* THE WINDOW LINTEL A101.2 WAS PROVED ACC. ÖNORM B3800-5 AND CONFORMS TO THE OIB RL2 GUIDELINES OF BUILDING CLASSIFICATIONS 4 AND 5.

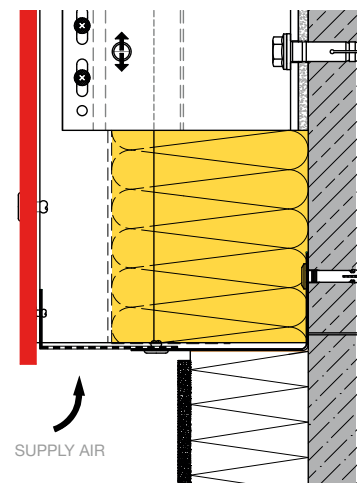

BASE CONNECTION A103

# Construction-details horizontal sections Alu-substructure with Z-/Omega-profiles riveted

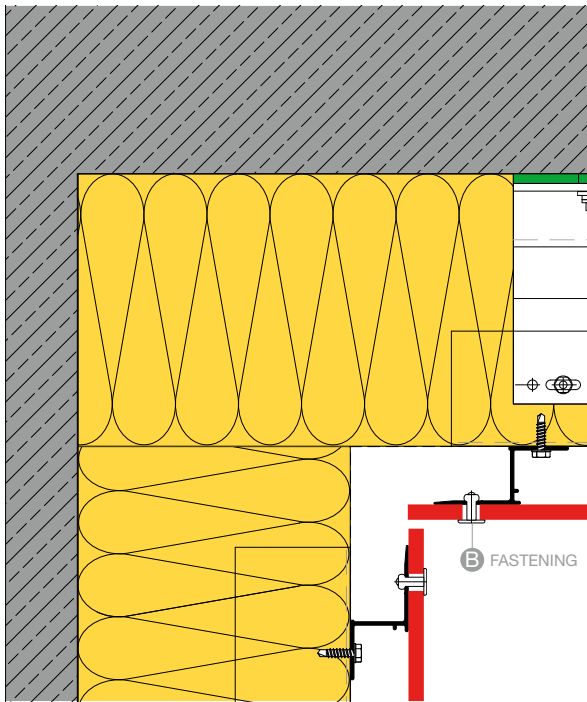

INTERNAL CORNER A106

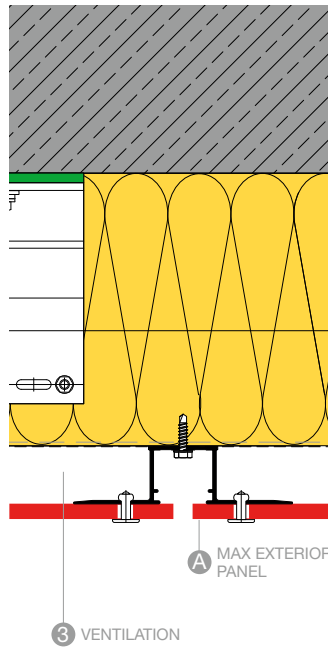

VERTICAL JOINT A107

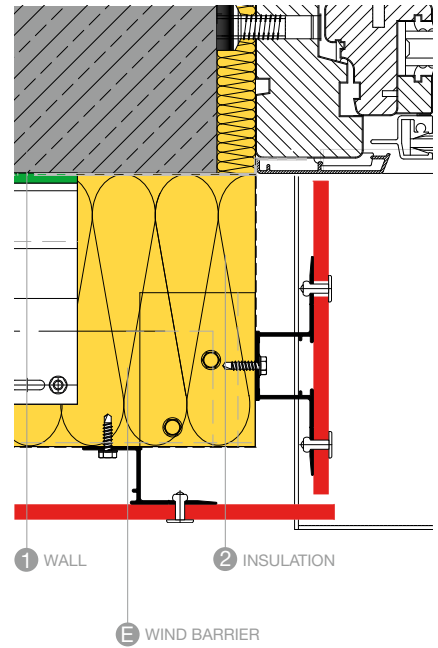

WINDOW REVEAL A104

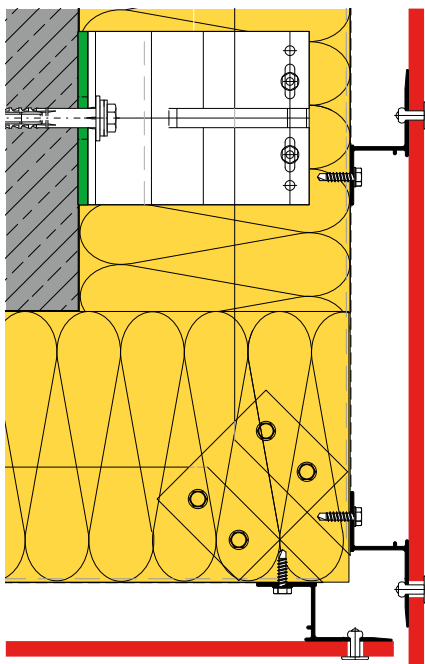

EXTERNAL CORNER A105



**NOTE**  
 SUPPLIERS:  
 SEE PAGES 106/107 AT  
 THE END OF THE BRO-  
 CHURE.

ALL PROFILES AND FAS-  
 TENINGS ARE SHOWN  
 IN THIS BROCHURE ARE  
 PLANNING-SUGGESTIONS  
 AND NOT PART OF THE  
 FUNDERMAX DELIVERY  
 PROGRAMME!  
 ALL DRAWINGS IN THIS  
 BROCHURE ARE NOT  
 TRUE TO SCALE!

# Construction-details vertical sections Alu-substructure with Z-/Omega-profiles riveted

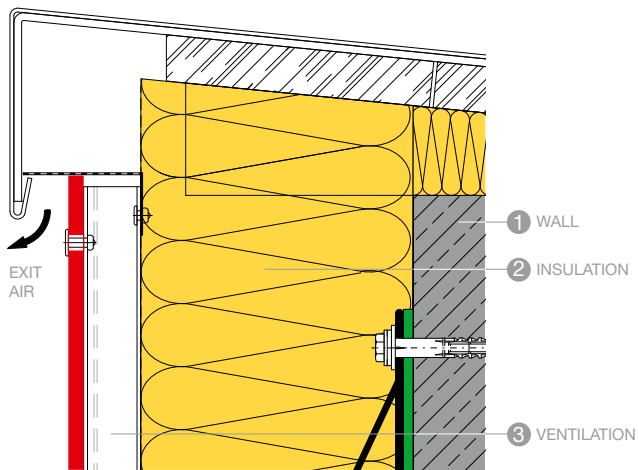

ATTIC CONNECTION A109

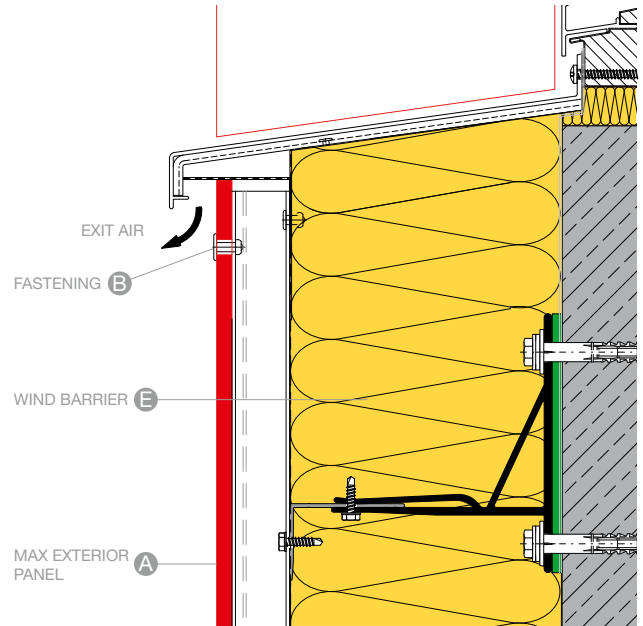

WINDOW SILL CONNECTION A102

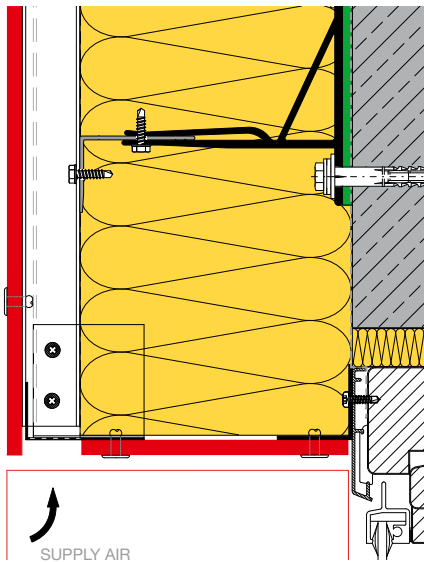

WINDOW LINTEL A101

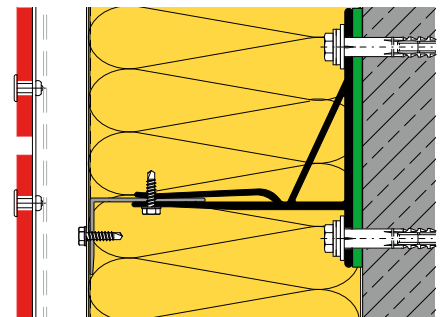

HORIZONTAL JOINT A110

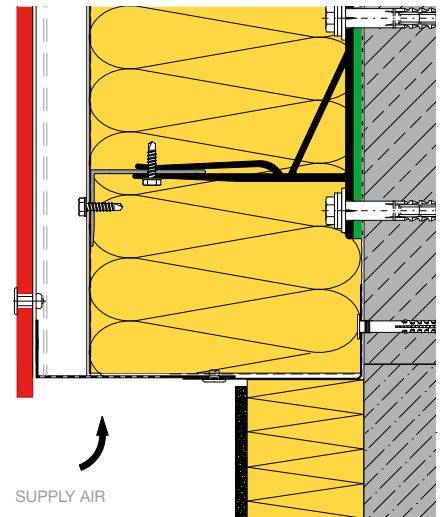

BASE CONNECTION A103

# Secret mechanical fastening with undercut panel anchor



Fig. 1

Installation of Max Exterior panels using concealed, mechanical fastening brackets on an aluminium subconstruction.

The fastening of the brackets to the Max Exterior panel using the fischer-cyclone panel anchor FZP-N in accordance with the ETA-09/0002 has been approved by the building authorities. The current approval notifications can be found and reviewed for changes in the downloads section at [www.fundermax.at](http://www.fundermax.at).

## BASICS

The panel anchor consists of a double-slotted conical plug sleeve with an integrated blind rivet. The plug is placed into the undercut drill hole of the facade panel so that it has a positive fit and then carefully anchored. Max Exterior panel thickness: 10 und 12 mm Maximum dimensions of the Max Exterior panel according to ETA-09/0002 with at least four and at most six individual brackets. The substructure is to be formed in such a way that unstressed fastening of the unstressed fastening of the Max Exterior panels is guaranteed. When the fastenings are made (drill hole, plug installation) a responsible, qualified employee of the manufacturer must be present in the factory or, at the construction site, the employer, a construction manager appointed by him or a proficient representative of the construction manager must be present. This person must ensure that the work is carried out properly. Facades of this type must only be installed by trained specialist employees. Supporting profile joints in the subconstruction are not allowed to be covered by the panels.

The undercut drill holes are to be made in the factory or under workshop conditions with a special drilling tool. The number of anchors must be determined in accordance with approval ETA-09/0002. Individual drill holes can also be made with portable drilling tools on the construction site under workshop conditions. The drilling dust must be removed from the drill hole. The nominal drill hole diameter must correspond to the values in the permit. In the event of a mis-drilling, a new drill hole has to be positioned away from the misdrilled one at a distance of at least twice the depth. Anchoring depths:

The plug is installed with a plug positioning device which is suitable for the system.

## NOTE

FUNDERMAX CAN ALSO PROVIDE THE PANELS COMPLETE WITH FACTORY-MADE UNDERCUT DRILL HOLES IN CONFORMITY WITH THE APPROVAL. PLEASE CONTACT US IF YOU ARE INTERESTED IN PANELS WITH UNDERCUT BORES.

ANCHOR TYPE		FZP 9 X 9 N	FZP 9 X 11 N
Panel thickness	[mm]	10	12
Borehole depth	[mm]	6.5	8.5
Anchoring depth	[mm]	4	6

Table 1

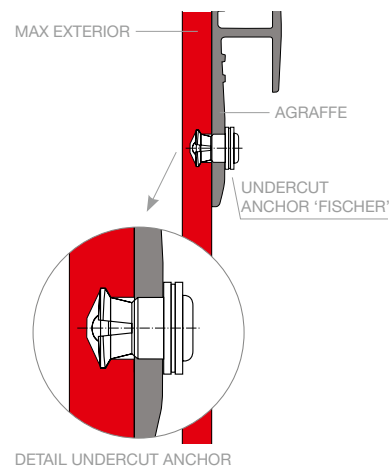

Fig. 2



**CHECKING OF THE EXECUTION**

The drill holes and the installed plugs are to undergo the following checks.

At 1% of all drill holes, the geometry of the drill holes is to be checked. The following measurements are to be checked and documented in accordance with the instructions of the plug manufacturers.

- Diameter of the cylindrical drill hole
- Diameter of the undercut
- Drill hole overcovering and drill hole depth.

The positive fit of the plug in the drill hole is to be tested by a visual check. The edge of the sleeve must finally support itself evenly on the bracket.

Concerning the making of the fastenings, records of the proof of proper installation are to be kept by the construction manager or his representative. These records have to be saved for 5 years by the employer. The permit ETA-09/0002 should be given appropriate attention before starting the planning.

Information must be obtained without fail from:  
 Fischerwerke  
 Artur Fischer GmbH. u. Co KG  
 Weinhalde 14 – 18  
 D-72178 Waldachtal  
 Tel.: +49 (0) 7443/124553  
 Fax: +49 (0) 7443/124568  
 E-Mail: anwendungstechnik@fischerwerke.de  
 Internet: www.fischerwerke.de

The local building regulations must be obeyed.

NAME	MATERIAL
Anchor sleeve	Stainless steel, 1.4571 oder 1.4401
Sleeve	Stainless steel, 1.4567 oder 1.4303
Rivet pin	Stainless steel, 1.4571

Table 2

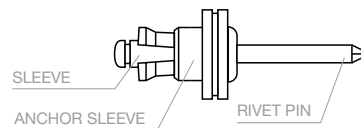
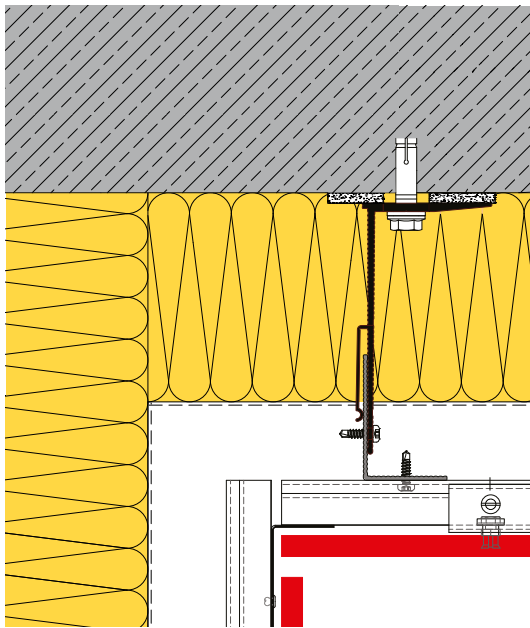

Fig.3

SUPPLIERS: SEE PAGES 106/107 AT THE END OF THE BROCHURE.

# Construction-details horizontal sections undercut panel anchor



INTERNAL CORNER A106

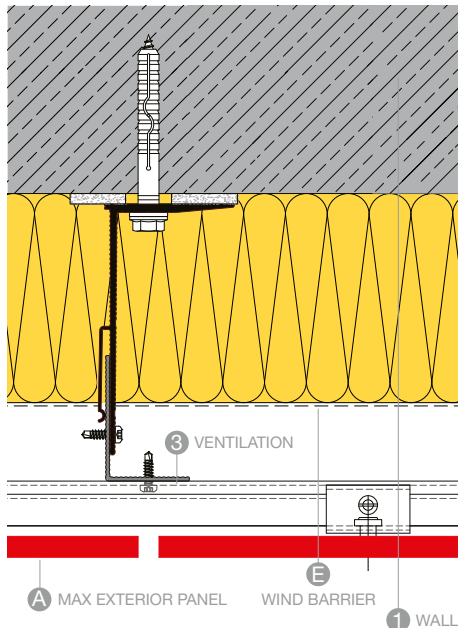

VERTICAL JOINT A107

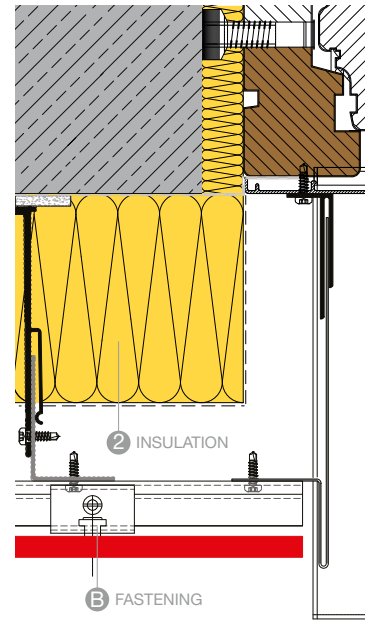

WINDOW REVEAL A104

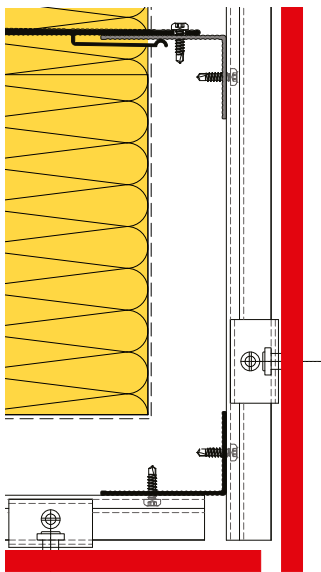

EXTERNAL CORNER A105

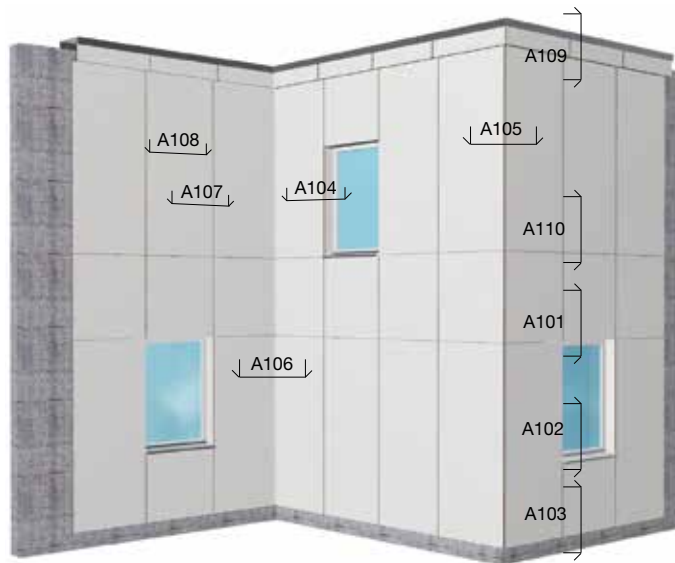

**NOTE**  
 SUPPLIERS:  
 SEE PAGES 106/107 AT THE  
 END OF THE BROCHURE.

ALL PROFILES AND FASTENINGS ARE SHOWN IN THIS BROCHURE ARE PLANNING-  
 SUGGESTIONS AND NOT PART OF THE FUNDERMAX DELIVERY PROGRAMME!  
 ALL DRAWINGS IN THIS BROCHURE ARE **NOT** TRUE TO SCALE!

# Construction-details vertical sections undercut panel anchor

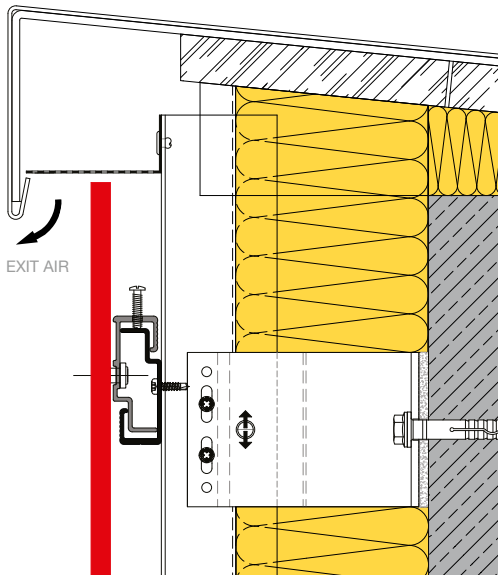

ATTIC CONNECTION A109

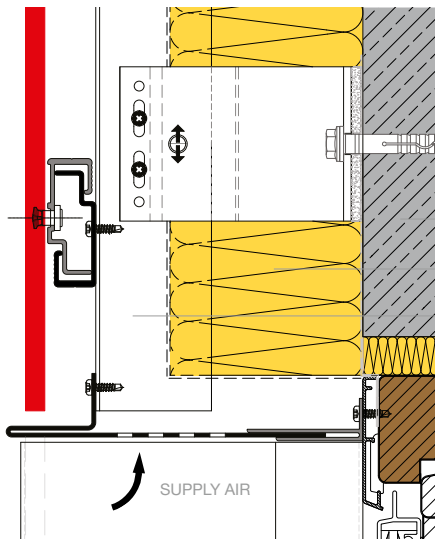

WINDOW LINTEL A101

- 1 WALL
- 2 INSULATION
- 3 VENTILATION

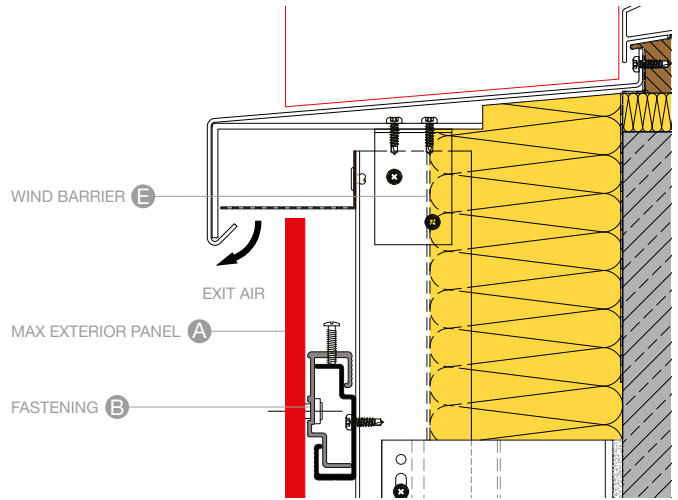

WINDOW SILL CONNECTION A102

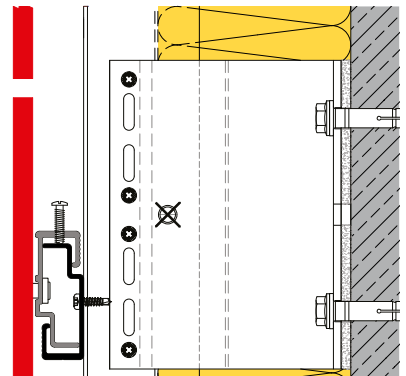

HORIZONTAL JOINT A110

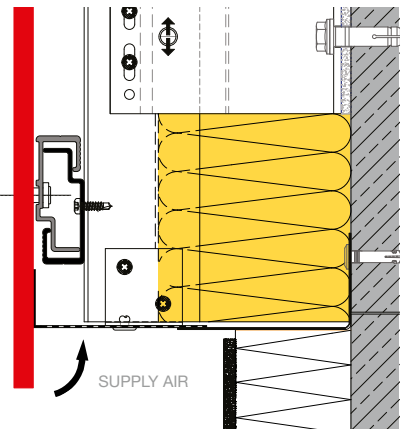

BASE CONNECTION A103

# Secret glued fastening with gluing systems



Fig. 1

## GLUING

An alternative to secret mechanical fixing with plugs is gluing the Max Exterior facade panels with gluing systems which were specially developed for this. It works on normal planed wood or aluminium sub-constructions. Gluing is a clean and simple solution for rear-ventilated facades, attics, visible roof underfaces, reveals and much more. It is important that the responsible building officials of the region or the country give permission. These gluing systems in connection with Max Exterior panels are permitted generally by building authorities in Germany.

- Sika Tack Panel
- Z-10.8-408
- MBE Panel-loc Gluing-System
- Z-10.8-350
- PRO PART Klebedicht KD385
- Z-10.8-453
- Innotec Project System
- Z-10.8-483

## CONSTRUCTION

for the required profile width see the permit.

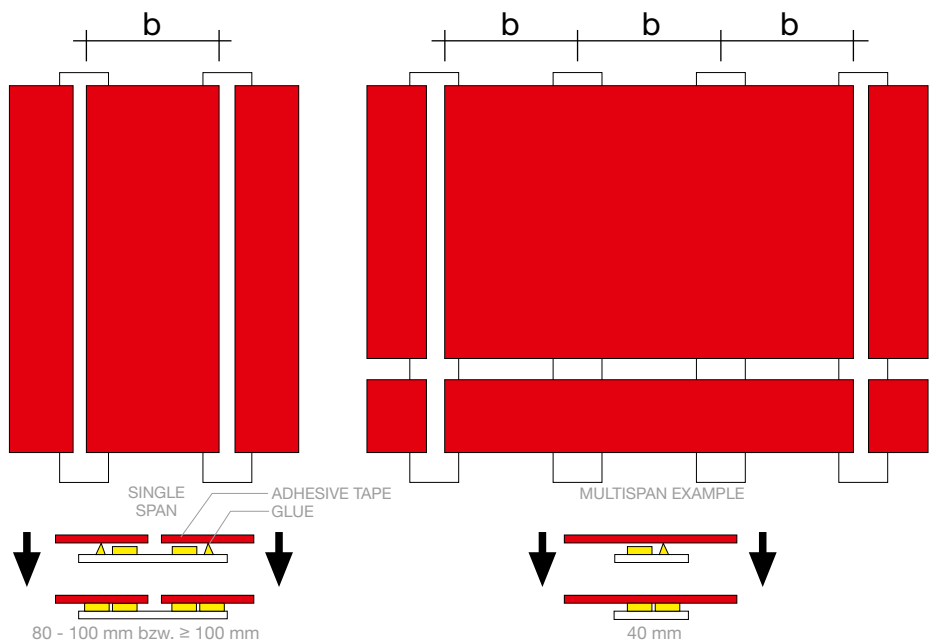

Fig. 2

The local building regulations are to be followed without fail!

FOR GLUED INSTALLATION WITH SIKA TACK PANEL (SPACING OF THE VERTICAL SUPPORT CONSTRUCTION)		
PANEL THICKNESS	SINGLE SPAN PANEL MAX. b	DOUBLE SPAN PANEL MAX. b
6 mm*	450 mm	500 mm
8 - 10 mm	600 mm	650 mm

\* PANEL THICKNESS 6 mm IS NOT PERMITTED IN GERMANY!

Table 1

## GLUING WITH INNOTEC PROJECT SYSTEM\*

	SINGLE SPAN		DOUBLE SPAN	
	8 mm	10 mm	8 mm	10 mm
AUSTRIA, GERMANY, SWITZERLAND	max b	max b	max b	max b
0.5 kN/m <sup>2</sup>	838	1048	1125	1406
1.0 kN/m <sup>2</sup>	665	832	893	1116
1.5 kN/m <sup>2</sup>	581	727	780	975
2.0 kN/m <sup>2</sup>	528	660	708	738

Table 2

Table 3

\* IDENTIFIED VALUES ON BASE OF THE INNOTEC PERMISSION. COUNTRY AND GLUE SPECIFIC STATICS CAN BE ORDERED AT THE MANUFACTURERS OF GLUES. THE GLUING OF 6 MM THICK PANELS ARE GENERALLY POSSIBLE BUT NOT PERMITTED IN GERMANY.

# Working sequence

## BASICS

- It is necessary to keep the work protected from the weather and dust (gluing work can be done on the construction site).
- Air temperature not below 5°C and not over 35°C.
- Relative air humidity not higher than 75%.
- Temperature of the construction elements which are to be glued at least 3°C higher than the dew point temperature of the air.
- Joints in the subconstruction profiles must not be glued if covered with Max Exterior panels.
- The subconstruction must always be arranged vertically.
- The general building authority permit, as well as the manufacturer's working instructions, must be present during the gluing work at every construction site.
- The gluing must only be done by companies with proof of training (for Germany, proof of qualification is necessary in accordance with the building authority permit).
- A construction site log is to be made.

## PRETREATMENT OF MAX EXTERIOR PANELS

- Rub down with an abrasive fleece Clean<sup>1)</sup>
- Ventilation time - 10 minutes
- Apply Primer thinly with a brush
- Ventilation time - at least 10 minutes, max. 8 hours

All surfaces to be glued must be kept clean, dry and grease-free.

## GLUING

- Apply the installation band over the entire length of the vertical profiles. (Do not remove protective film yet).
- Apply glue: The glue is applied as a triangular bead (width, height in accordance to the application recommendation of the producer ) at a distance of at least of 5 or 6 mm from the edge of the profile and the installation band.
- Install panel: Remove the protective film from the installation band. Align the panel exactly (installation angle) until in contact with the installation band, then press on.

Information must be obtained without fail from the manufacturer of the gluing system.

SUPPLIERS OF FASTENING AND SUBSTRUCTURES YOU WILL FIND ON PAGES 106/107 OR AT „WWW.FUNDERMAX.AT“.

<sup>1)</sup>SIKA ACTIVATOR 205 ACTIVATES THE MATERIAL SURFACE AND LEAVES A GREY SHEEN. DO NOT APPLY TO THE FRONT SIDE OF THE PANELS. REMOVE ANY SPLASHES IMMEDIATELY.

# Construction-details horizontal sections Alu-substructure glued

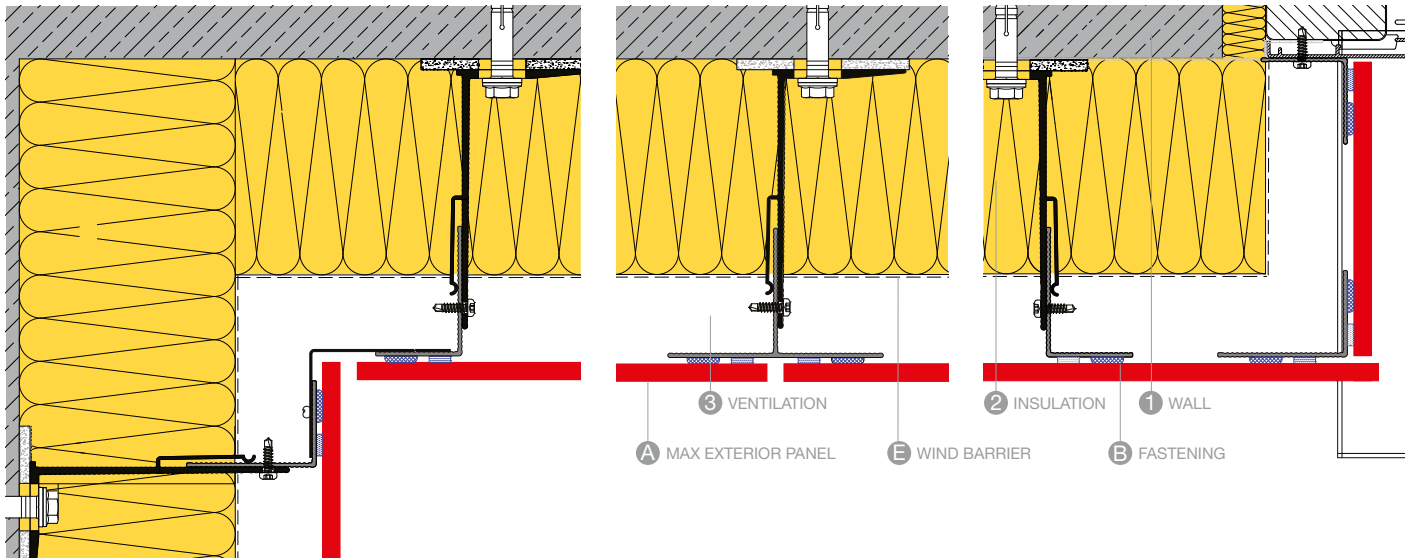

INTERNAL CORNER A106

VERTICAL JOINT A107

WINDOW REVEAL A104

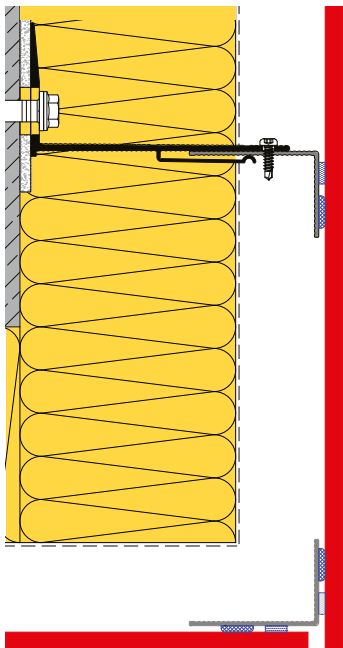

EXTERNAL CORNER A105

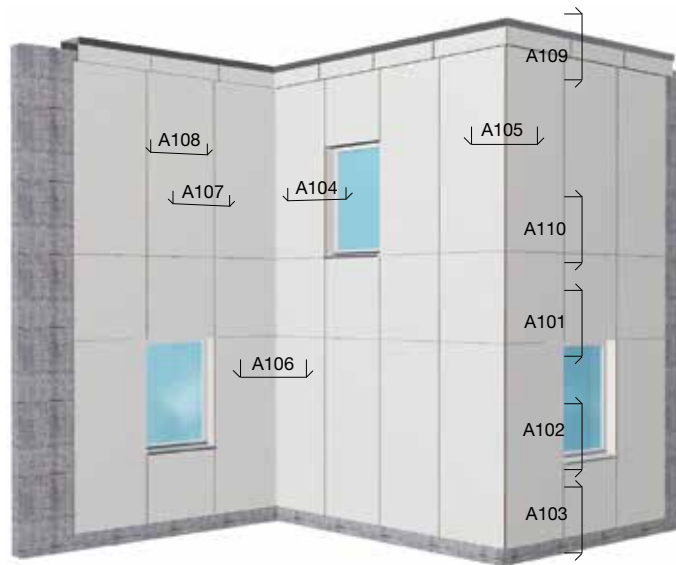

**NOTE**  
SUPPLIERS:  
SEE PAGES 106/107 AT THE  
END OF THE BROCHURE.

ALL PROFILES AND FASTENINGS ARE SHOWN IN THIS BROCHURE ARE PLANNING-  
SUGGESTIONS AND NOT PART OF THE FUNDERMAX DELIVERY PROGRAMME!  
ALL DRAWINGS IN THIS BROCHURE ARE **NOT** TRUE TO SCALE!

# Construction-details vertical sections Alu-substructure glued

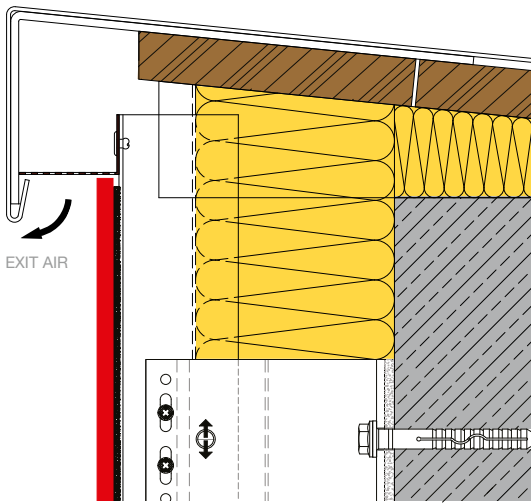

ATTIC CONNECTION A109

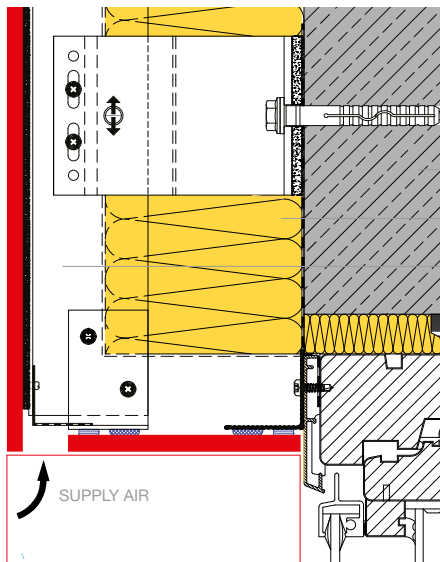

WINDOW LINTEL A101

- 1 WALL
- 2 INSULATION
- 3 VENTILATION

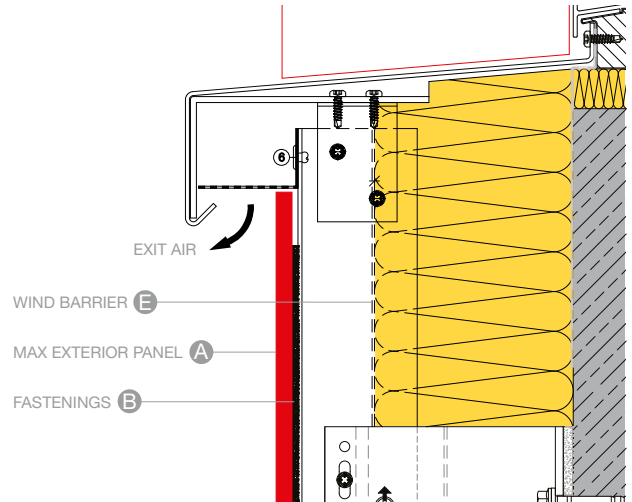

WINDOW SILL CONNECTION A102

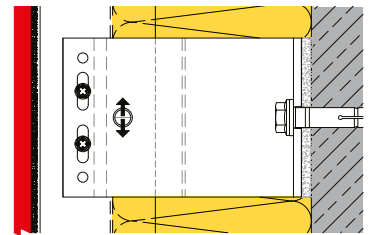

HORIZONTAL JOINT A110

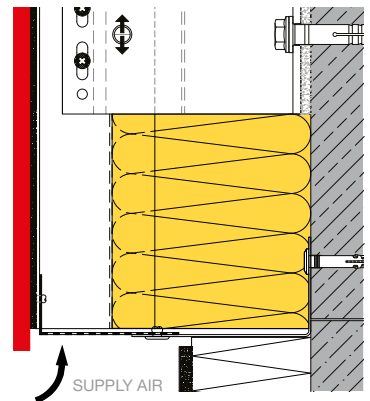

BASE CONNECTION A103

# Construction-details horizontal sections Alu-substructure with Z-/Omega-profiles glued

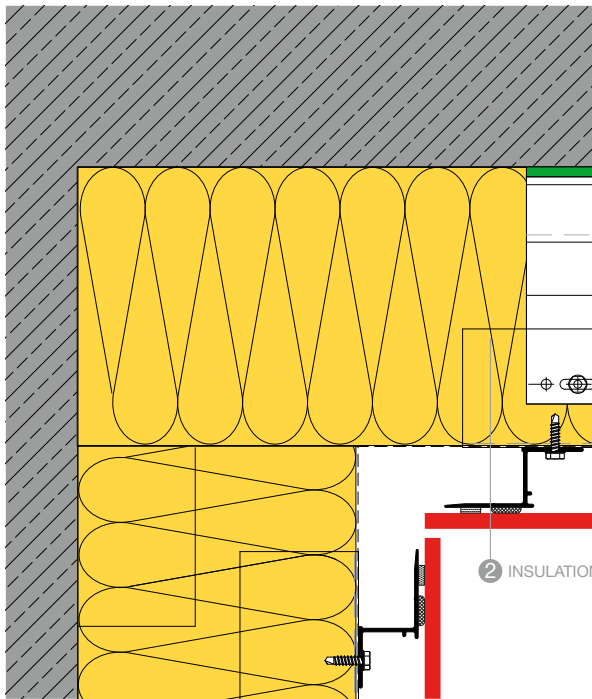

INTERNAL CORNER A106

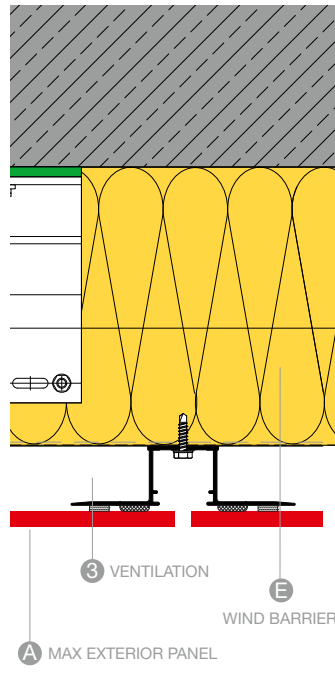

VERTICAL JOINT A107

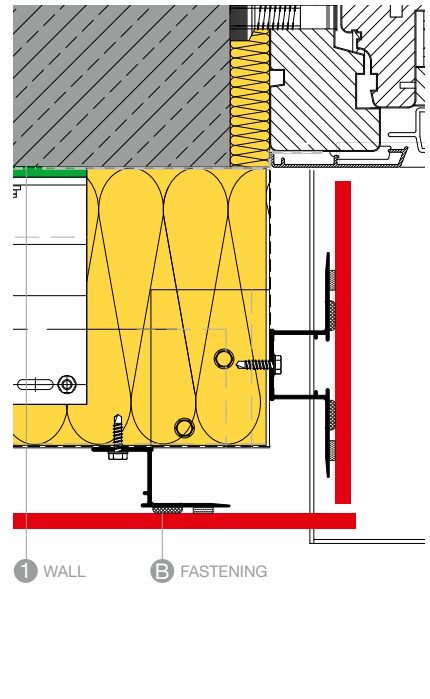

WINDOW REVEAL A104

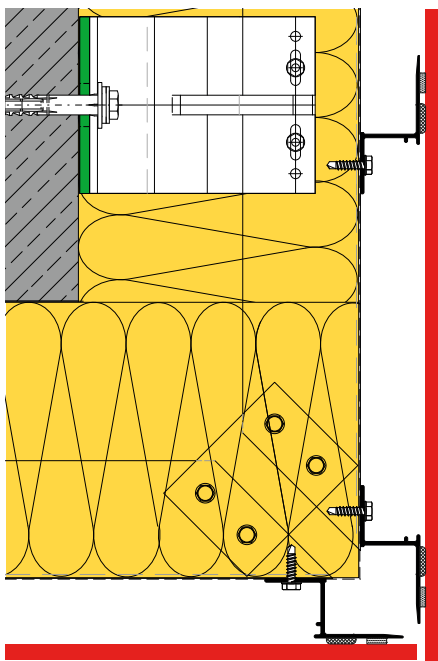

EXTERNAL CORNER A105



**NOTE**  
SUPPLIERS: SEE PAGES 106/107 AT THE END OF THE BROCHURE.

ALL PROFILES AND FASTENINGS ARE SHOWN IN THIS BROCHURE ARE PLANNING-SUGGESTIONS AND NOT PART OF THE FUNDERMAX DELIVERY PROGRAMME! ALL DRAWINGS IN THIS BROCHURE ARE NOT TRUE TO SCALE!



# Construction-details vertical sections Alu-substructure with Z-/Omega-profiles glued

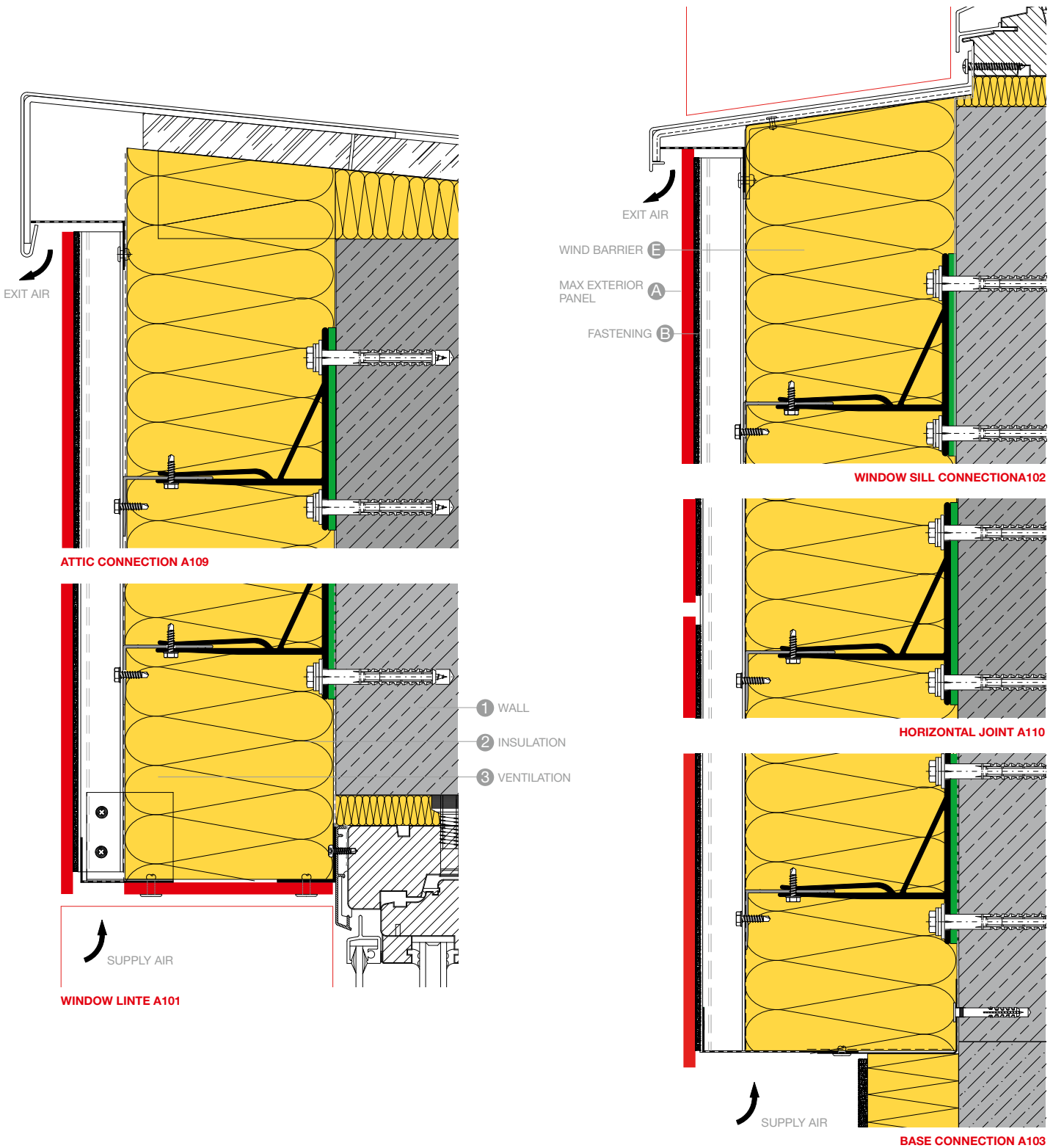

## The ME 01 system for the concealed mounting of Max Exterior facade panels



Fig. 1



Fig. 2

The ME 01 is a specially developed system of concealed mechanical fastening brackets for the rational installation of the Max Exterior facade panel. The system components (Max Exterior panel, bracket, undercut anchor and support profile), are designed for optimum compatibility.

### SYSTEM ADVANTAGES

- Can be used for both horizontal or vertical panel/joint formats
- Only one support profile required for horizontal panel joint
- Experienced system partners
- No visible mounting brackets
- Can be installed under any weather conditions
- Low installation costs
- The fastening means have been approved by the building authorities
- Can be used with 10 mm and 12 mm panels

### FASTENING BRACKET

**Germany:** Fischer undercut anchor FZP technical approval ETA-09/0002 See page 32 - 35.

**France:** SFS TU-S 50 Avis Technique (2/16-1749). For countries in which the fastening means do not require an approval from the building authorities, we recommend using one of the aforementioned approvals.

### SYSTEM DESCRIPTION

The brackets are mounted on the rear side of the Max Exterior facade panels with special blind fasteners into the prepared mounting drill holes.

The SFS TU-50 blind fastener does not require any special mounting drill holes.

The panels provided with brackets are hung in the suspension profiles mounted on the substructure, their height is adjusted, and they are secured against lateral movement.

After the detailed planning for the facade has been completed (mounting distances according to the building authorities), we or a partner will cut the Max Exterior facade panels to size and provide them with the drill holes. The basis for this is a CAD drawing for each part.

The brackets can be attached quickly and easily at the facade builder's or on the construction site using a commercial riveting machine.

**CHECKING OF THE EXECUTION**

The drill holes and the installed plugs are to undergo the following checks.

At 1% of all drill holes, the geometry of the drill holes is to be checked. The following measurements are to be checked and documented in accordance with the instructions of the plug manufacturers.

- Diameter of the cylindrical drill hole
- Diameter of the undercut
- Drill hole overcovering and drill hole depth.

The positive fit of the plug in the drill hole is to be tested by a visual check. The edge of the sleeve must finally support itself evenly on the bracket.

Concerning the making of the fastenings, records of the proof of proper installation are to be kept by the construction manager or his representative. These records have to be saved for 5 years by the employer. The permit should be given appropriate attention before starting the planning.

The local building regulations must be obeyed.

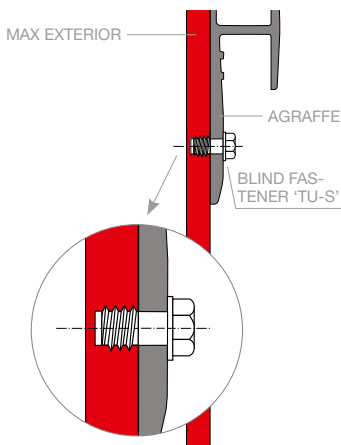

Fig. 3

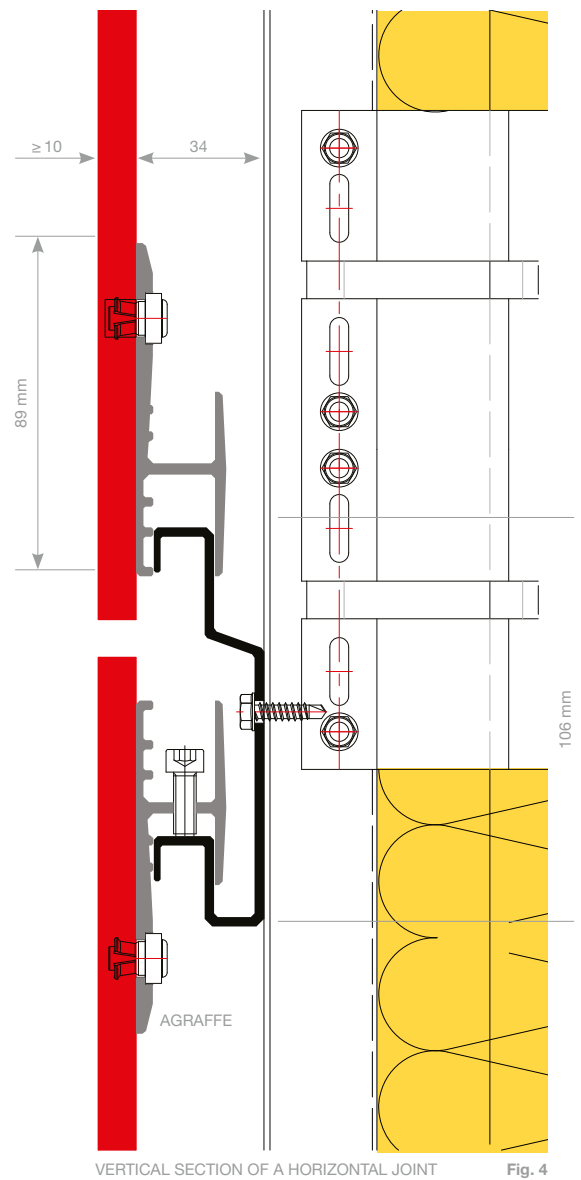
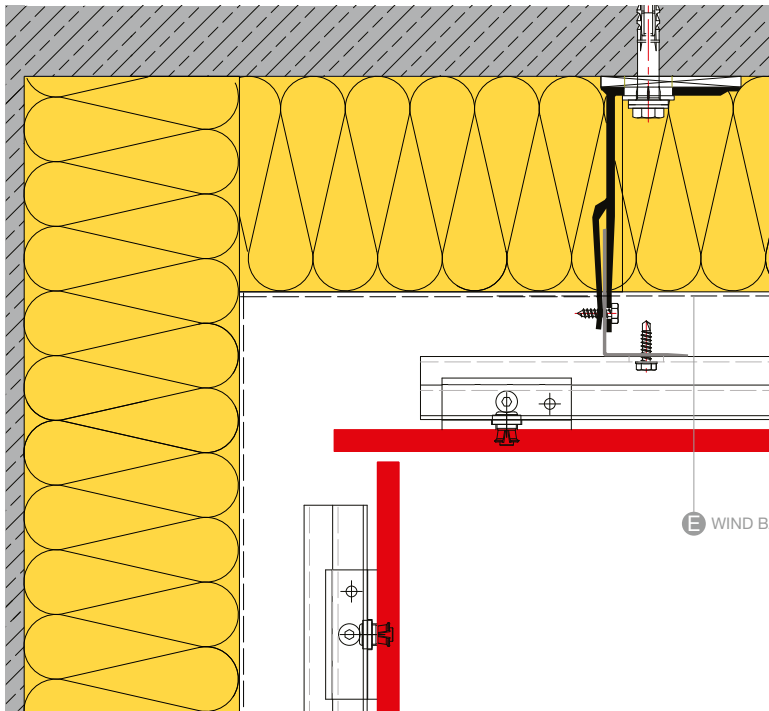
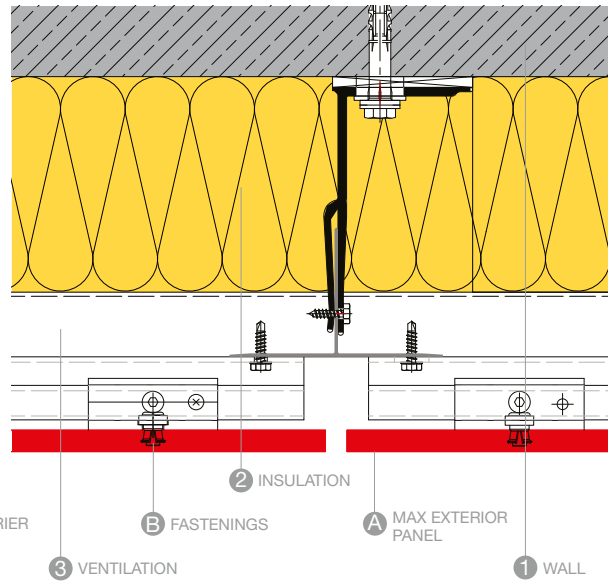

Fig. 4

# Construction-details horizontal sections System ME 01



INTERNAL CORNER A106



VERTICAL JOINT A107

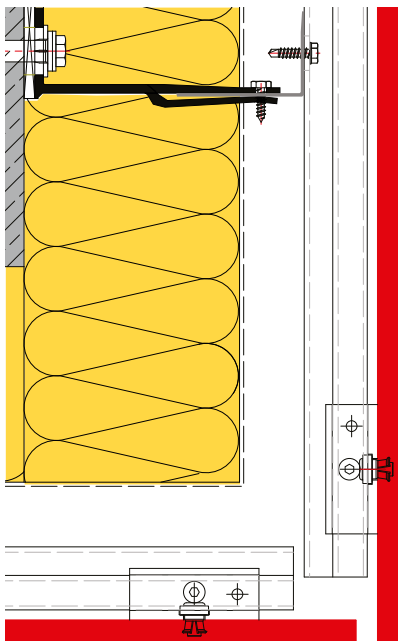

EXTERNAL CORNER A105

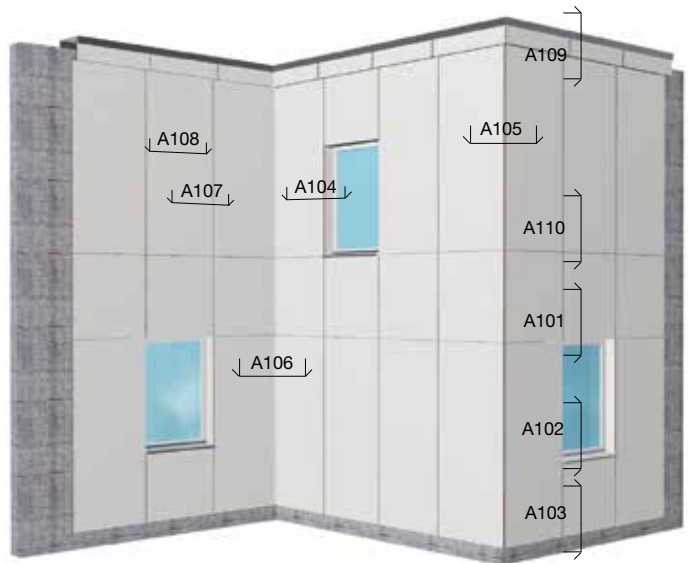

**NOTE**  
SUPPLIERS:  
SEE PAGES 106/107 AT THE  
END OF THE BROCHURE.

ALL PROFILES AND FASTENINGS ARE SHOWN IN THIS BROCHURE ARE PLANNING-  
SUGGESTIONS AND NOT PART OF THE FUNDERMAX DELIVERY PROGRAMME!  
ALL DRAWINGS IN THIS BROCHURE ARE NOT TRUE TO SCALE!

# Construction-details vertical sections System ME 01

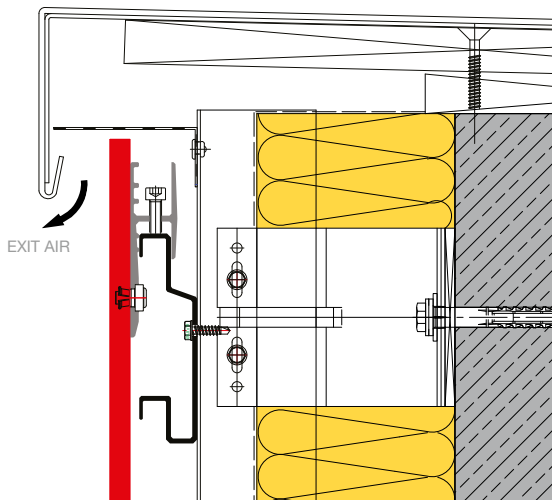

ATTIC CONNECTION A109

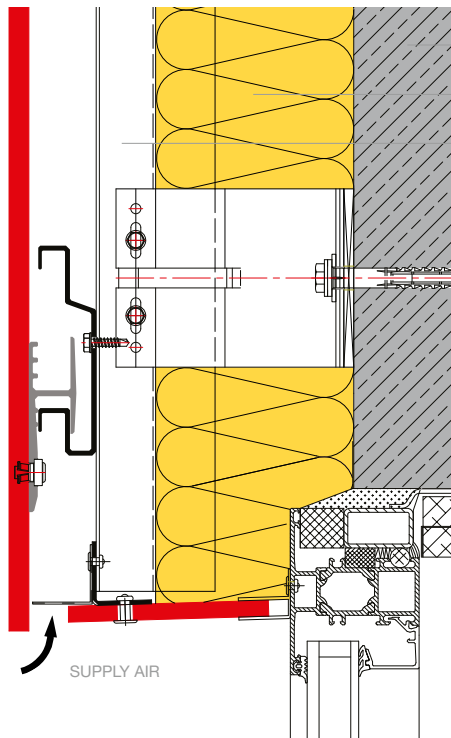

WINDOW LINTEL A101

- 1 WALL
- 2 INSULATION
- 3 VENTILATION

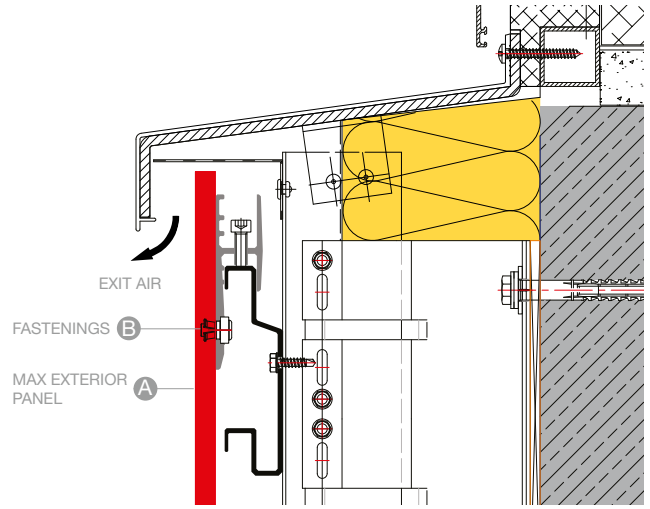

WINDOW SILL CONNECTION A102

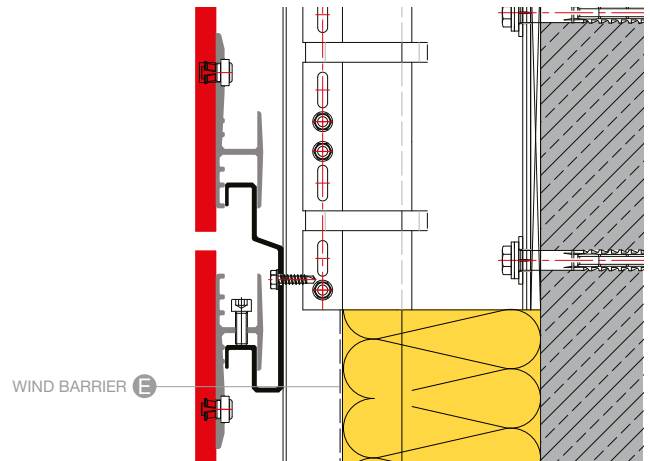

HORIZONTAL JOINT A110

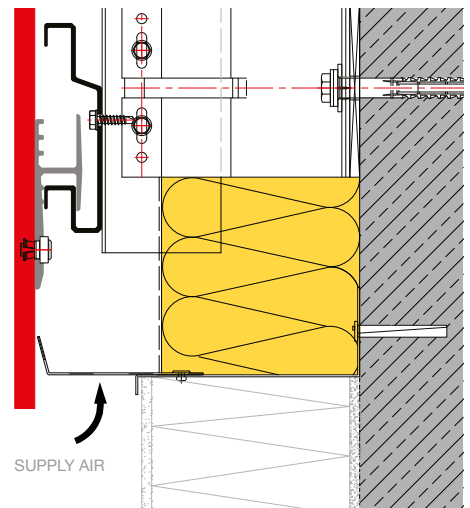

BASE CONNECTION A103

## Important information on rear-ventilated facades supported by wooden substructures.

Wooden substructures for facades have been proven solutions for centuries. Their most obvious advantages are low heat conductivity and a low rate of horizontal expansion, as well as the fact that wood is a renewable resource. In order to ensure their longevity, it is imperative that wooden substructures be given effective, reliable protection from moisture. Depending on the conditions at hand, constructional wood protection or additional chemical-based wood protection may be necessary. Only in hazard class 0 (DE) or service class 0 (AT)—that is, in facades that are protected by eaves and feature closed joints—is chemical wood protection unnecessary.

Battens must be planed on all sides, pre-dried (wood moisture of  $15\% \pm 3$ ) and made of woods such as spruce, fir, pine or larch, and there must also be a backing strip made of EPDM rubber with a minimum thickness of 1.2 mm in order to prevent the penetration of moisture via screws in the substructure. (See Fig., longitudinal cross-section, p. 54.) It is essential that the penetration of moisture behind the EPDM strip near parapets and window edges be prevented.

**Note:** According to DIN 1052, predrilling of spruce (in battens) is no longer permissible. If the wood is denser than  $500 \text{ kg/m}^3$ , DIN 1502-12.6(4) requires pre-drilling to be done with a hole diameter of less than the screw shaft's diameter, adhering to the formulas " $0.6 \times \varnothing$ " or " $0.8 \times \varnothing$ ".

Detailed requirements are specified by those standards and guidelines that apply (see standard list on p. 50). Since wood, as a natural building material, expands and shrinks, it is necessary to conduct regular visual checks of the facade. Screws should be tightened as needed. Assembling a facade made of Max Exterior Panels on a wooden substructure must be done with custom-shaped panels (cut, drilled and, if necessary, chamfered).

### CONSTRUCTIONAL WOOD PROTECTION

According to the applicable standards, constructional wood protection measures include precautionary design, construction, working and processing measures to ensure that wood and wooden building materials remain serviceable. Such measures help to avoid both fungal infestation and excessive expansion and shrinkage. They are not, however, capable of preventing infestation with insects. Taking the following points and/or measures into account will have a strong influence on the functionality and longevity of the substructure. In order to provide clear descriptions of how they can be put into practice for the facade, the following section will look at each point individually. Building wooden substructures for facades is subject to the processing guidelines for wooden construction techniques in effect at the site where they are to be installed, and/or to other rules that represent the state of the art. Adherence to such guidelines is the responsibility of those who process the materials.

For this reason, it is particularly important to define "constructional and chemical wood protection" measures as early as the planning phase.

### EFFECTIVE MEASURES INCLUDE, MOST IMPORTANTLY, PROTECTION FROM

#### a) penetration of moisture into the battens

by using EPDM rubber backing strips with a thickness of at least 1.2 mm. Such backing strips must be used on all battens and be at least 20 mm wider than the battens themselves (see Fig. 2 on p. 52). This measure helps to avoid the formation of wood-destroying moulds that appear when wood moisture exceeds 20% (DIN EN 335-1, appendix A, 2.19).

#### b) precipitation

(e.g. by roofing, weather-protectant covers for parapets, windowsill joints, etc.). Roof overhangs prevent the facade from constant penetration by moisture whenever it rains. The necessary dimensions for such an overhang are determined by the height of the facade and by how the building is situated.

#### c) spraying water

(e.g. by maintaining 300 mm distance from the ground) Wooden substructures are very sensitive to constant penetration by moisture. Therefore, it is essential to ensure that the wooden substructure is at least 300 mm above the level of water saturation (in the case of a gravel surface adjacent to the foundation). In cases of smooth ground and frequent, strong rainfall, the area within which water sprays becomes commensurately larger.

#### d) rising moisture

(e.g. through insulating strips) In buildings affected by rising moisture, insulating strips must be placed between the masonry/concrete and the wooden substructure. This effectively prevents moisture from constantly penetrating the wooden construction elements.

**e) condensation**

(e.g. with a vapour retarder, rear-ventilation for shuttering, insulation of pipes carrying cold water). In order to avoid condensation in the rear-ventilated façade, it is necessary to ensure that air flows in and out constantly. The vertical rear-ventilation opening must be at least 200 cm<sup>2</sup> and, in wooden substructures, a minimum free width of 150 cm<sup>2</sup>/m is required for air inflow and outflow openings (see association rule of the ÖFHF).

**The flow of air is always vertical, meaning that the battens must, accordingly, always be vertically oriented.**

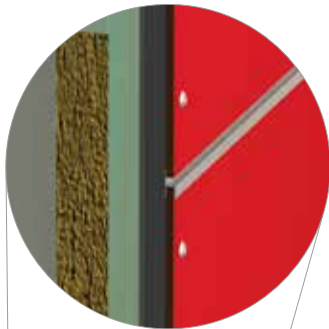

H-PROFILE (E.G. PROTEKTOR)

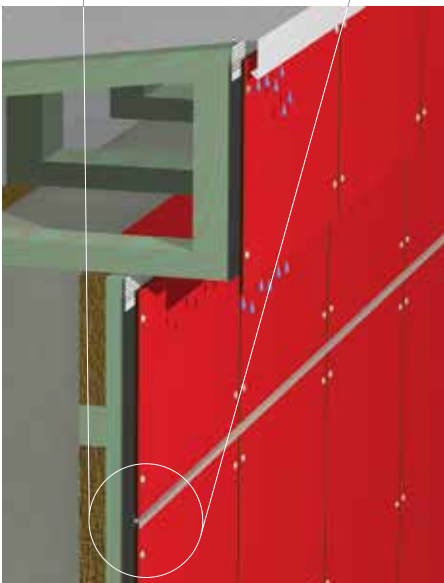
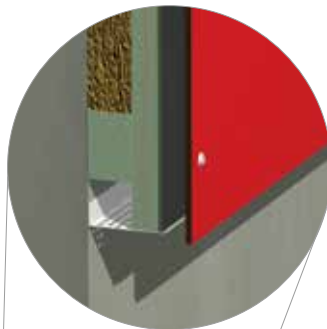

PROTECTION FROM RAIN AROUND PARAPETS / ROOF EDGES

Fig. 1

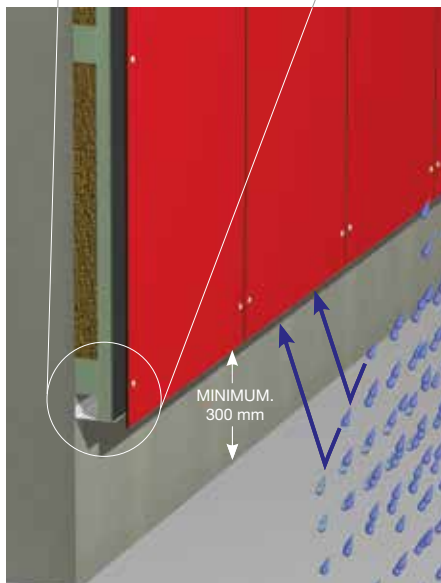

SPRAY WATER NEAR SKIRTING

Fig. 2

ALSO SEE OUR MEASURES FOR AVOIDING ERRORS, DESCRIBED ON PAGES 48 AND 49

# Error avoidance in wooden substructures

We recommend based on the latest technical expertises in practise and on current hands-on experience the following approach for wooden-substructures. In order to avoid making errors when building wooden substructures, a few important points must receive attention. The following pages show the most important potentially problematic areas according to a “correct”/ “incorrect” scheme.

**CORRECTLY DONE BATTENS / CORRECT EPDM STRIP OF 1.2 mm THICKNESS AND AN OVERHANG OF 10 mm ON EACH SIDE (page 52 Fig. 2)**

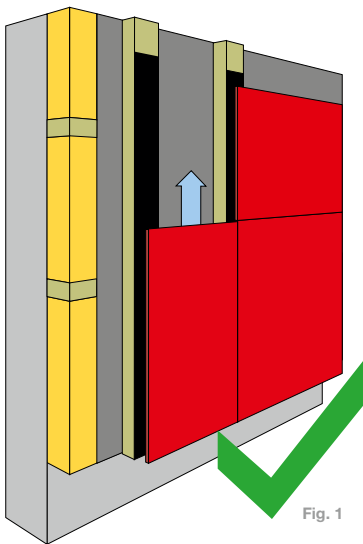

Fig. 1

**MISSING EPDM PROTECTIVE TAPE**

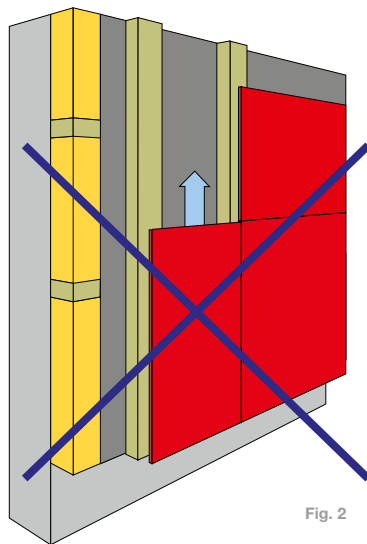

Fig. 2

**INCORRECTLY DONE BATTENS**

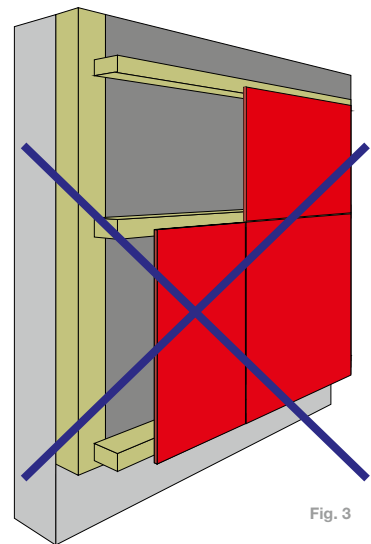
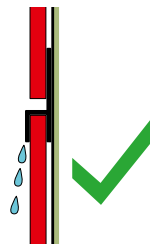

Fig. 3

**PLEASE NOTE**

- Battens must be pre-dried (15%±3\*) and planed on all sides.
- Ensure constructional and/or chemical wood protection!
- Use an EPDM protective tape of at least 1.2 mm thickness and with an overhang of 10 mm per side on all battens.
- Adapt skirting to suit the adjacent terrain.
- A wooden substructure is only permissible in combination with adequate constructional wood protection (roof overhang).
- All horizontal joints must be connected using appropriate profiles (see Fig. 4-6).

**DRAINAGE OF RAINWATER**



VERTICAL SECTION Fig. 4

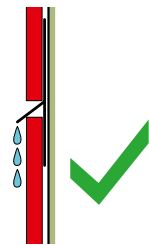

VERTICAL SECTION Fig. 5

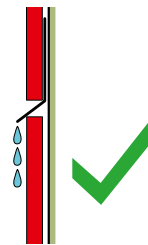

VERTICAL SECTION Fig. 6

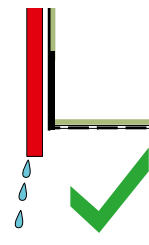

VERTICAL SECTION Fig. 7

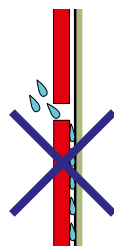

VERTICAL SECTION Fig. 8

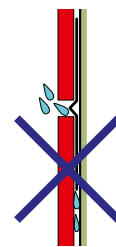

VERTICAL SECTION Fig. 9

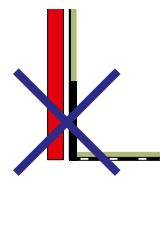

VERTICAL SECTION Fig. 10

$$*WOOD MOISTURE = \frac{WATER CONTENT}{DRY WEIGHT} \times 100 \text{ IN } \%$$



**DRILLED HOLE FOR FIXED POINTS D = 6.0 mm/DO NOT USE A COUNTER-SUNK HEAD**

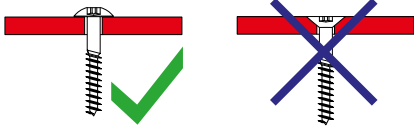

VERTICAL SECTION

Fig. 11

**DRILLED HOLE FOR SLIDING POINTS D = 8.0 mm/DO NOT USE A COUNTER-SUNK HEAD**

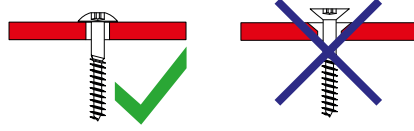

VERTICAL SECTION

Fig. 12

**CAPILLARY ACTION/AVOIDANCE OF NARROW JOINTS**

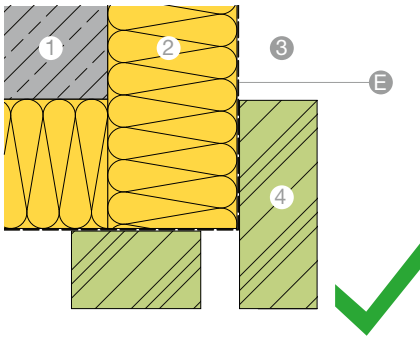

HORIZONTAL SECTION

Fig. 13

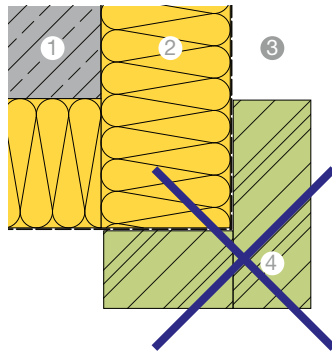

HORIZONTAL SECTION

Fig. 14

**VARIANT WITH EXTERNAL CORNER PROFILE**

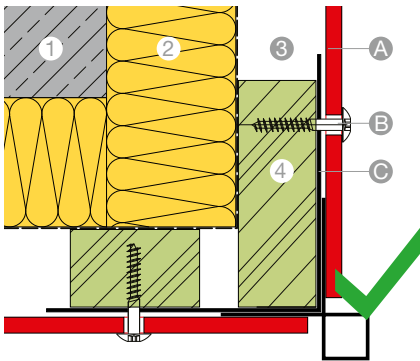

HORIZONTAL SECTION

Fig. 15

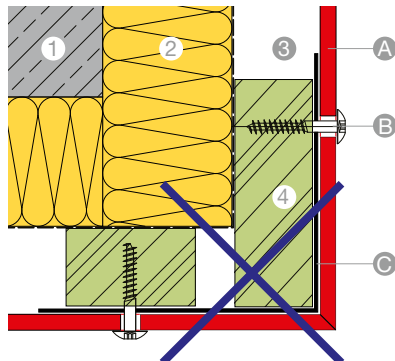

HORIZONTAL SECTION

Fig. 16

**VARIANT WITH OPEN JOINT AND OVERHANG OF THE MAX EXTERIOR PANEL**

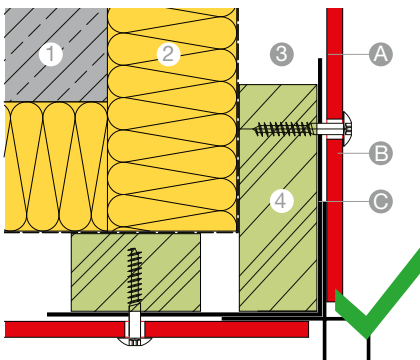

HORIZONTAL SECTION

Fig. 17

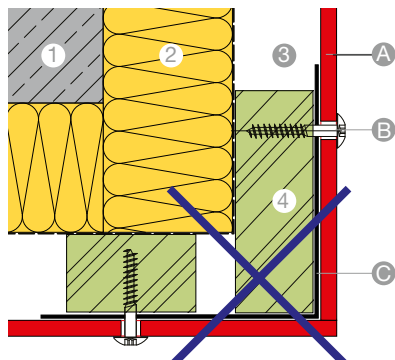

HORIZONTAL SECTION

Fig. 18

**LEGENDE**

- 1 WALL
- 2 INSULATION
- 3 VENTILATION
- 4 CHEMICAL TREATED WOODEN BATTENS
- A MAX EXTERIOR PANEL
- B FASTENING
- C EPDM -PROTECTIVE TAPE MIN. 1.2 mm THICK
- E WIND BARRIER

## Standards for Building with Wood

<b>ÖNORM B 2215</b>	Wood working
<b>ÖNORM B 3801:2009</b>	Wood protection in building and construction – Fundamentals and definitions
<b>ÖNORM B 3802-1:1995</b>	Protection of timber used in buildings – Constructional protection of timber
<b>ÖNORM B 3802-2:1998</b>	Protection of timber used in buildings – Chemical protection of timber
<b>ÖNORM B 3803</b>	Protection of timber used in buildings – Coatings of dimensionally stable wooden outdoor building components
<b>ÖNORM EN 1995-1-1</b>	Design of timber structures - Part 1-1: General – Common rules and rules for buildings
<b>DIN EN 350-1</b>	Durability of wood and wood based products – Natural durability of solid wood – Part 1: Guide to the principles of testing and classification of the natural durability of wood
<b>DIN EN 350-2</b>	Durability of wood and wood based products – Natural durability of solid wood – Part 2: Guide to the natural durability and treatability of selected wood species of importance in Europe
<b>DIN 1052-10</b>	Design and production of timber structures – Part 10 Additional rules
<b>DIN 4108-3</b>	Thermal protection and energy economy in buildings – Part 3: Protection against moisture subject to climate conditions – Requirements and directions for design and construction
<b>DIN 18516-1</b>	Cladding for external walls, ventilated at rear – Part 1: Requirements, principles of testing
<b>DIN 68800-1</b>	Wood preservation – Part 1: General
<b>DIN 68800-2</b>	Wood preservation – Part 2: Preventive constructional measures in buildings
<b>DIN 68800-3</b>	Wood preservation – Part 3: Preventive protection of wood with wood preservatives
<b>DIN 68800-4</b>	Wood preservation – Part 4: Curative treatment of wood destroying fungi and insects and refurbishment
<b>DIN 4074-1</b>	Strength grading of wood – Part 1: Coniferous sawn timber
<b>DIN 4074-5</b>	Strength grading of wood – Part 5: Sawn hard wood
<b>DIN EN 335</b>	Durability of wood and wood based products
<b>DIN EN 336</b>	Structural timber – Sizes, permitted deviations
<b>DIN EN 338</b>	Structural timber – Strength classes
<b>EN 14081</b>	Timber structures – Strength graded structural timber with rectangular cross section Part 1: General requirements: - Visual strength grading – Machine strength grading – Evaluation of conformity – Marking Part 2: Machine grading: additional requirements for factory production control Part 3: Machine grading: additional requirements for factory production control
<b>ÖFHF</b>	Association rule of the ÖFHF (2014) Bulletin for rearventilated facades with wooden substructures (as at: 2014-03-10)

**NOTE**  
PLEASE SEE THE RESPECTIVE AND CURRENT ISSUES OF  
THE STANDARDS MENTIONED ABOVE!



# Design possibilities with Max Exterior panels



Fig. 1



Fig. 2



Fig. 3



Photo: Thomas Pennetier

Fig. 4

# Mounting of Max Exterior panels with screws on a wooden substructure

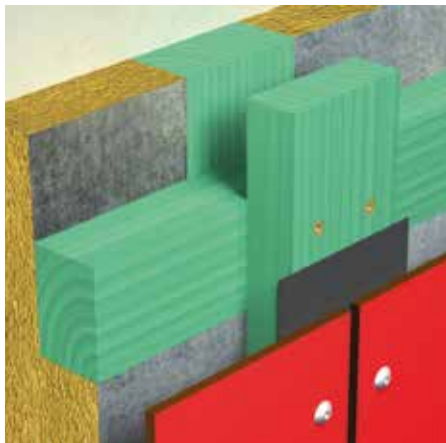

Fig. 1

## SUBSTRUCTURE

Please note the hints on pages 46 up to 52. For applications that do not require structural analysis, the dimensions should be at least 60 x 40 mm for the underlying horizontal base or counter battens, at least 50 x 30 mm for the vertical support battens, and 100 x 30 mm in the joint areas. Due to the material properties of Max Exterior, fixed points and sliding points need to be made to mount the panels (Fig. 4/5). For using higher insulation thicknesses you have to build a counter-batten (Fig. 1).

### NOTE

TO GET A PERFECT DESIGN OF THE FACADE CLADDING WITH A FINISHING SURFACE IT IS RECOMMENDED TO GLUE THE PANELS ON AN ALUMINIUM-SUBCONSTRUCTION. SUBCONSTRUCTION LIKE WOOD DO NOT HAVE THE RIGHT PROPERTIES TO AVOID A WAVY APPEARANCE OF THE CLADDING.

## FIXED POINTS

Fixed points are used for uniform distribution (halving) of the expansion and shrinkage movements. The diameter of the drill hole in Max Exterior has to be made with 6.0 mm.

## SLIDING POINT

The diameter of the drill hole in Max Exterior must be drilled larger than the diameter of the fastening, depending on the required expansion clearance. This is the shaft diameter of the fastening plus 2 mm for every meter of cladding material starting from the fixed point. The head of the fastening must be big enough so that the drill hole in Max Exterior is always covered. The fastening is placed in such a way that the panel can move. Screws must not be over-tightened. Do not use any countersunk screws. The centre point of the drill hole in the subconstruction must coincide with the centre point of the drill hole in the Max Exterior panels. Drill with a centring piece. The fastenings should be put in place starting from the middle of panel outwards.

## FASTENINGS

It is essential that fastenings are made from non-corrosive materials.

Max Exterior Installation screw (Fig. 3) with torx wrench 20 made of stainless steel CrNiMo 17122 Material no. 1.4401 V4A. Lacquered head on request. Diameter of drill hole in Max Exterior  
Sliding points: 8 mm or as required  
Fixed points: 6.0 mm

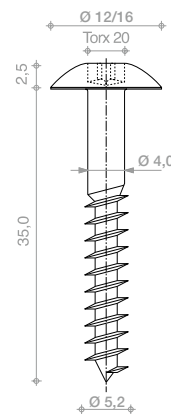
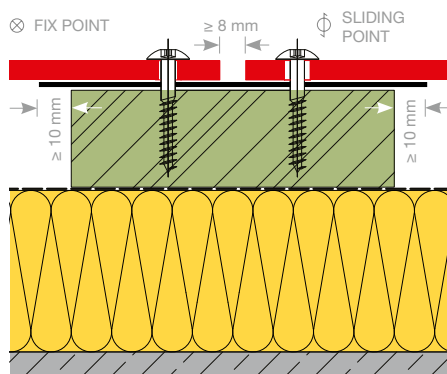

Fig. 3



EXAMPLE VERTICAL JOINT

Fig. 2

## EDGE SPACINGS

For reasons of stability and flatness, the edge spacings must be kept to without fail. The joints must be made at least 8 mm wide so that changes in size can take place without hindrance (Fig. 2).

## FASTENING SPACINGS

These are to be chosen in accordance with the structural engineering requirements (calculations) or, if this is not necessary due to the local regulations, according to table no. 1 or 2.

**TABLE FOR LOAD ON SINGLE SPAN/WIND LOAD\***  
MAX EXTERIOR PANELS SCREWED ON WOODEN SUBSTRUCTURE

PANEL THICKNESS	6 mm		8 mm		10 mm		
	LOAD q (kN/m²)	max b (mm)	max a (mm)	max b (mm)	max a (mm)	max b (mm)	max a (mm)
<b>GERMANY*</b>							
0.50		600	600	700	700	800	800
1.00		600	431	700	539	800	551
1.50		600	311	700	373	800	431
2.00		537	261	700	280	800	323

Values acc. to DIN 1055-T4 bzw. DIN 18516 and permit Z-10.3-712

**AUSTRIA\***

0.50	781	662	970	649	1146	769
1.00	657	394	815	463	964	457
1.50	594	314	737	354	871	396
2.00	537	261	686	286	811	319

Values acc. to ÖNORM B 4014-1,2 or EN 1991-1-4 and permit Z-10.3-712

**SWITZERLAND\***

0.50	781	662	970	649	1146	769
1.00	657	394	815	463	964	457
1.50	594	314	737	354	871	396
2.00	537	261	686	286	811	319

Values acc. to SIA-Standard 261 or Z-10.3-712

**FASTENING SPACINGS FOR AUSTRIA AND SWITZERLAND**

If the specified axis dimension „b“ is not fully utilized, then the allowable mounting distance „a“ can be calculated as follows (source: Typenstatik Max Exterior Fassadenplatten Dipl.-Ing. Gerald Segeth, Dobel 18. 04. 11):

When installing a 8 mm double span panel with a wind load of 0.5 kN, the following applies: max b = 1209 mm and max. a = 343.

If a value of 1000 mm is used for „b“ for example, then the maximum allowable „a“ is calculated as follows:

$$\text{allow a} = \frac{\text{max b}}{\text{for given b}} * \text{max a}$$

Example:

$$\text{allow a} = \frac{1209 \text{ mm}}{1000 \text{ mm}} * 343 \text{ mm} = 414 \text{ mm}$$

Table 1

**TABLE FOR LOAD ON DOUBLE SPAN/WIND LOAD\***  
MAX EXTERIOR PANELS SCREWED ON WOODEN SUBSTRUCTURE

PANEL THICKNESS	6 mm		8 mm		10 mm		
	LOAD q (kN/m²)	max b (mm)	max a (mm)	max b (mm)	max a (mm)	max b (mm)	max a (mm)
<b>GERMANY*</b>							
0.50		600	600	700	591	800	517
1.00		600	345	700	296	800	259
1.50		600	230	700	197	800	172
2.00		537	193	700	148	800	129

Values acc. to DIN 1055-T4 bzw. DIN 18516 and permit Z-10.3-712

**AUSTRIA\***

0.50	974	425	1209	343	1429	290
1.00	759	273	1012	205	1201	172
1.50	620	223	826	167	1033	134
2.00	537	193	716	145	894	116

Values acc. to ÖNORM B 4014-1,2 or EN 1991-1-4 and permit Z-10.3-712

**SWITZERLAND\***

0.50	974	425	1209	343	1429	290
1.00	759	273	1012	205	1201	172
1.50	620	223	826	167	1033	134
2.00	537	193	716	145	894	116

Values acc. to SIA-Standard 261 or Z-10.3-712

\*AN INTERPOLATION IS POSSIBLE ON BASE OF THIS VALUES.  
EXAMPLE: IF YOU DONT USE MAX B IN TOTAL IT APPLIES: PERMITTED A = (MAX B/EXISTING B) \* MAX A  
NOTE: PERMITTED A < MAX B

DIMENSION TABLES FOR THE WIND LOAD RANGE FROM 0.3 KN/M² TO 2.6 KN/M² ARE AVAILABLE UPON REQUEST FROM THE FUNDERMAX SUPPORT TEAM.

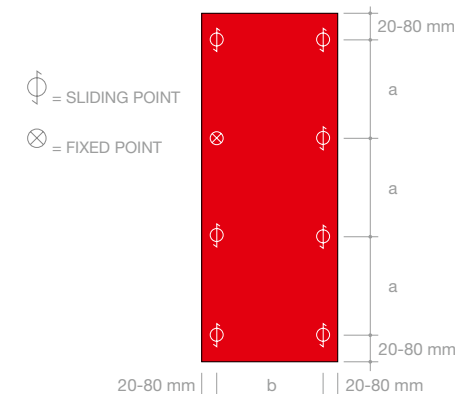

SINGLE SPAN PANEL Fig. 4

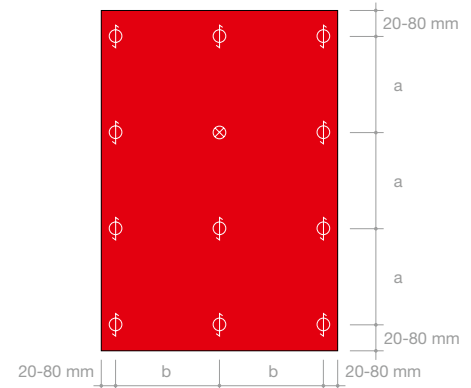

DOUBLE SPAN PANEL Fig. 5

Table 2

# Construction-details wooden substructure horizontal sections

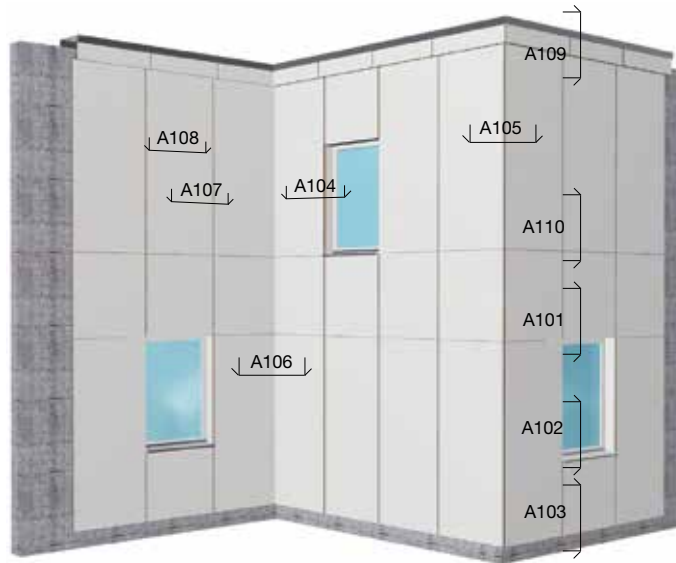
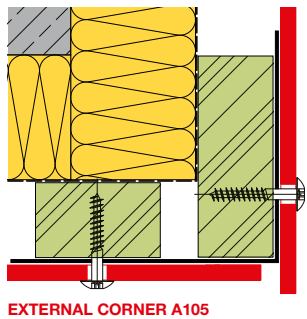
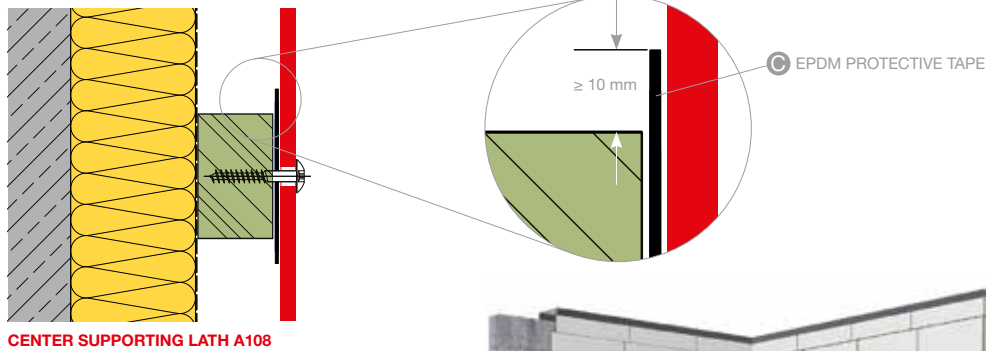
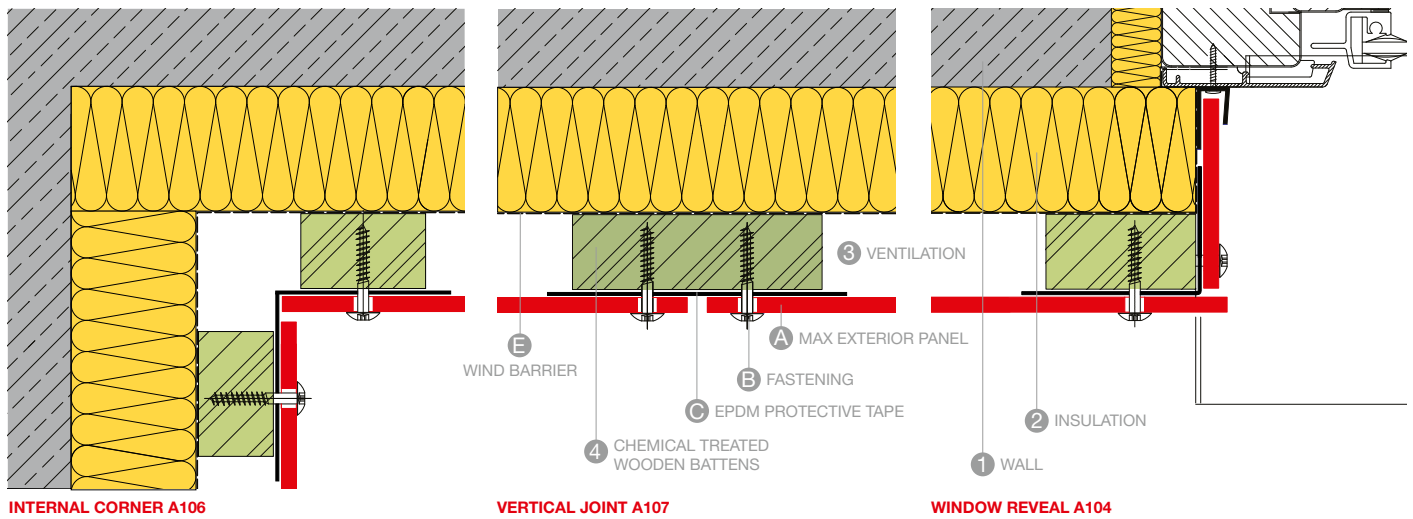

**NOTE**  
SUPPLIERS:  
SEE PAGES 106/107 AT THE  
END OF THE BROCHURE.

ALL PROFILES AND FASTENINGS ARE SHOWN IN THIS BROCHURE ARE PLANNING-SUGGESTIONS AND NOT PART OF THE FUNDERMAX DELIVERY PROGRAMME! ALL DRAWINGS IN THIS BROCHURE ARE NOT TRUE TO SCALE!

# Construction-details wooden substructure vertical sections

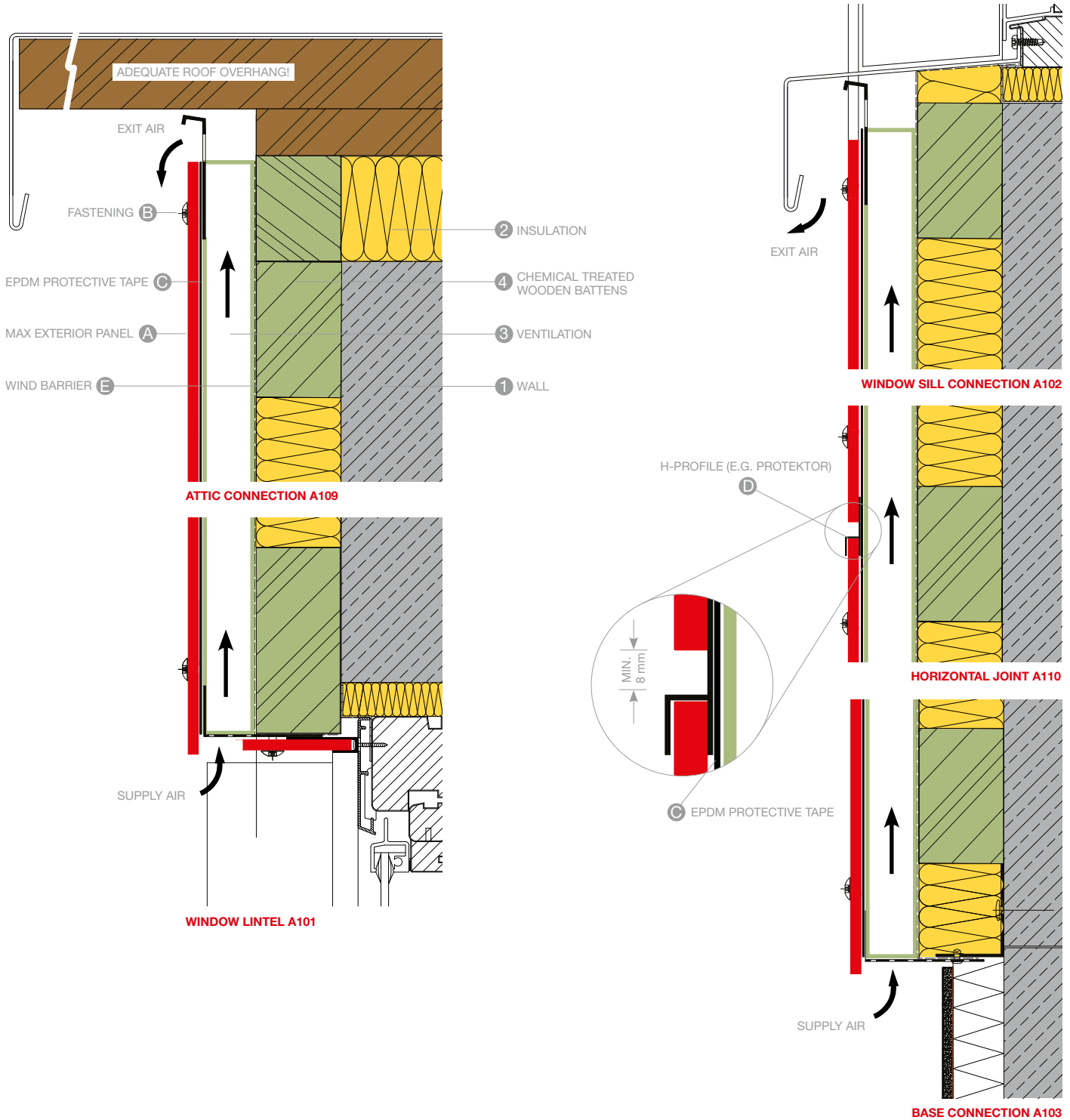

# Scaleo Facade System



Fig. 1

The advantages of an attractive system. With prefabricated Max Exterior panels for lap sidings, it is easy to design robust and modern facades. Through an ideal combination of an easy to install holding system with the proven characteristics of the Max Exterior facade panels.

**Note:** Information about building regulation permits you will find at our website [www.fundermax.at/downloads](http://www.fundermax.at/downloads).

In Austria and Germany is no permission for building classes 1-3 (for panel width 250 mm) necessary.

### AS ACCESSORIES AVAILABLE:

- Mounting clips incl. mounting instructions
- Vertical backing profile

### ADVANTAGES:

- All the benefits of the Max Exterior surface
- Hail-resistant
- weather-resistant
- Lightfast and UV-resistant
- Double-hardened surface
- Fast delivery for stock program
- Wide selection of decors
- Easy to install
- Ideal Scaleo panel dimensions

### SCALEO PANELE

Standardformat: 2800 x 250 mm  
 Thickness: 6 mm  
 Packaging unit: 5 pieces

See our website - [www.fundermax.at](http://www.fundermax.at) - for other available cuts and dimensions.

### PROFILE VARIANTS:

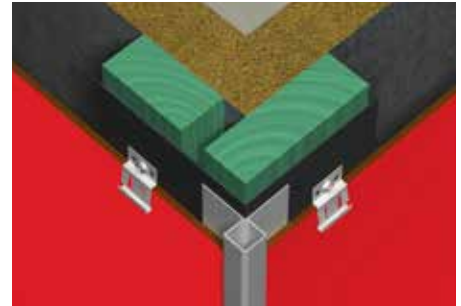

EXTERNAL CORNER WITH SQUARE PROFILE

Fig. 4

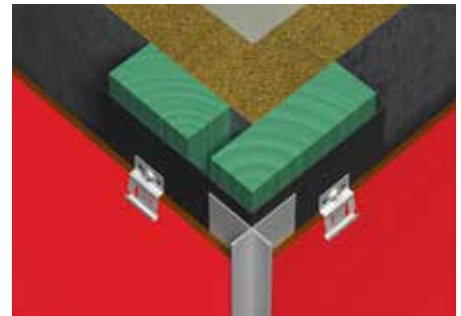

EXTERNAL CORNER WITH CROSS PROFILE

Fig. 5

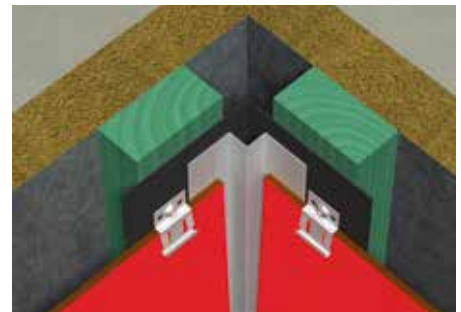

INTERNAL CORNER PROFILE

Fig. 6

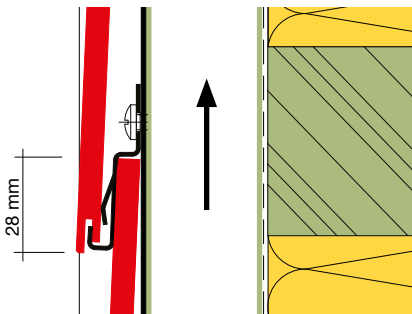

OVERLAP DIMENSION SCALEO ELEMENTS

Fig. 2

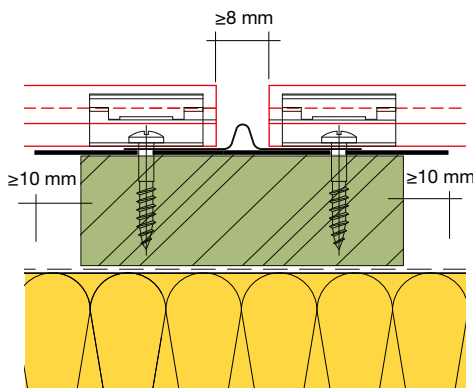

VERTICAL BACKING PROFILE

Fig. 3



## Mounting instructions



Fig. 7



Fig. 8



Fig. 9



Fig. 10



Fig. 11

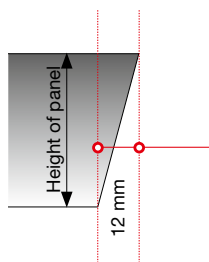

Fig. 12

### 1. PREPARING THE SUBSTRUCTURE

Max Exterior Scaleo elements are installed using mounting clips fixed to a substructure of vertical wooden battens, which are shaped and predried (wood moisture  $15\% \pm 3$ ). Each batten must be at least 50 mm wide for a single mounting clip, or 75 mm wide where two panels join to allow enough space for two mounting clips side-by-side (**Pay attention to constructive or chemical treated wood preservation!**). The gap between each batten should not exceed 500 mm\*. The Scaleo panels are installed starting from the bottom. First of all, fit a horizontal base bar. Now fit the first row of mounting clips so they rest on the bar. Make sure you fit 2 mounting clips at each vertical joint between panels. Alternatively you can use an aluminium substructure. Length of the aluminium profile is maximum 2800 mm. Width of the profile with one mounting clip 40 mm and in case of joints (2 clips) minimum 80 mm. For fixing against shifting we recommend one self-tapping screw with fillister head per panel (screwed in the middle).

\*THE SPACING SPECIFIED APPLIES TO LOW BUILDINGS, I.E. UP TO 8 M IN HEIGHT.

### 2. INSTALLING THE FIRST ROW OF PANELS

Place the groove along the lower edge of the Max Exterior Scaleo elements (the notch points downwards) onto the mounting clips. Secure the panels in place by fixing mounting clips along the top edge of each panel. Tighten each bracket with a facade screw (min. V4A) 4.8 x 30 mm to the substructure. The panel above overlaps the first row of panels by approx. 28 mm. Fit a screw next to the top middle mounting clip on each panel. This is designed to stop the panel shifting sideways.

### 3. VERTICAL JOINT

A batten for fixing the mounting clips must be located at each vertical joint. Two mounting clips, one either side of the joint, are needed to provide the necessary hold. Please use Max Exterior backing strips to seal the vertical joint between cladding panels. If siding elements are arranged so the vertical joints are offset then it is sufficient to install the panel plus joint profile using a single mounting clip on the upper end (see Fig. 10). If vertical joints are in a line then two mounting clips need to be used. There must be a gap of at least 8 mm between the panels at the joint.

### 4. OUTSIDE CORNERS/INSIDE CORNERS WITH MITRE

Max Exterior Scaleo elements can be mitred for both outside and inside corners. **Outside corners:** The top edge of the panel must be 12 mm shorter than the lower edge of the panel (regardless of the panel width). **Inside corners:** The lower edge of the Scaleo panel must be 12 mm shorter than the top edge of the panel (regardless of the panel width). The mitred edges must have a chamfer. The substructure needs to be protected with an EPDM protective tape (min. thickness 1.2 mm) to prevent water entering. **Corner profiles:** Elements can be installed on both outside and inside corners using a variety of shapes of corner profiles. In this case the panels are cut to size without a mitre. Make sure there is a gap of at least 5 mm between each panel and the corner profile.

### 5. INSTALLING THE TOP ROW OF PANELS

Secure the top row of panels by fitting screws along the top edge of each panel. Use screws with painted heads to match the colour of the panels, as used for the installation of full-sized Max Exterior cladding boards.

# Construction-details horizontal sections Scaleo Facade System on wooden substructure

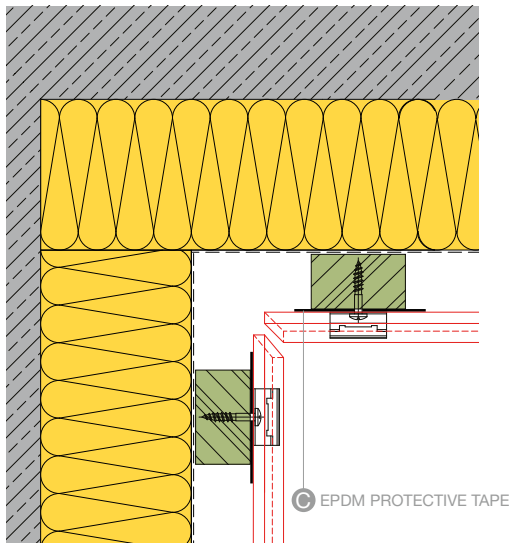

INTERNAL CORNER A106

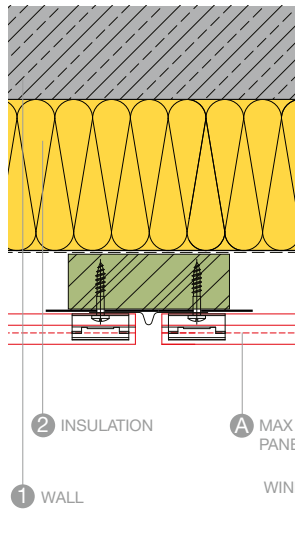

VERTICAL JOINT A108

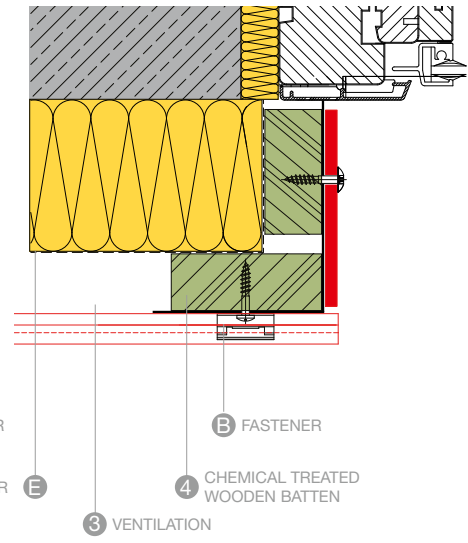

WINDOW REVEAL A104

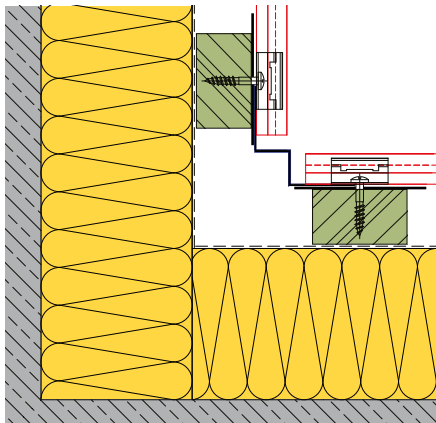

INTERNAL CORNER A106 WITH PROFILE

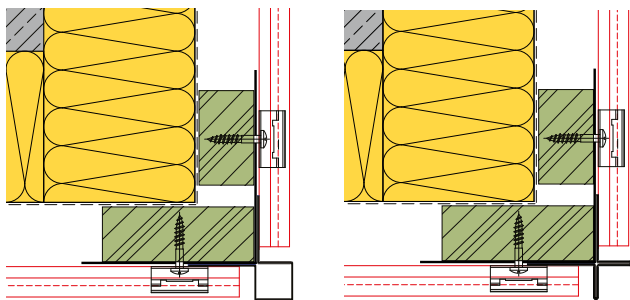

EXTERNAL CORNER A105 WITH SQUARE PROFILE

EXTERNAL CORNER A105 WITH CROSS PROFILE

**NOTE**

SUPPLIERS: SEE PAGES 106/107 AT THE END OF THE BROCHURE.

ALL PROFILES AND FASTENINGS ARE SHOWN IN THIS BROCHURE ARE PLANNING-SUGGESTIONS AND NOT PART OF THE FUNDERMAX DELIVERY PROGRAMME!  
ALL DRAWINGS IN THIS BROCHURE ARE NOT TRUE TO SCALE!



# Construction-details vertical sections Scaleo Facade System on wooden substructure

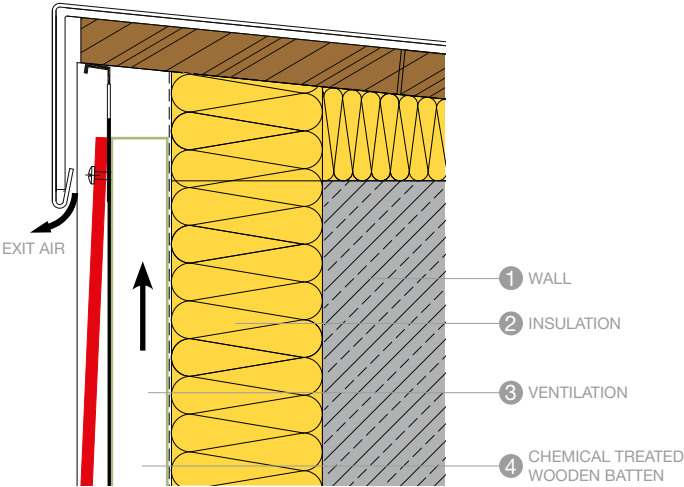

ATTIC CONNECTION A109

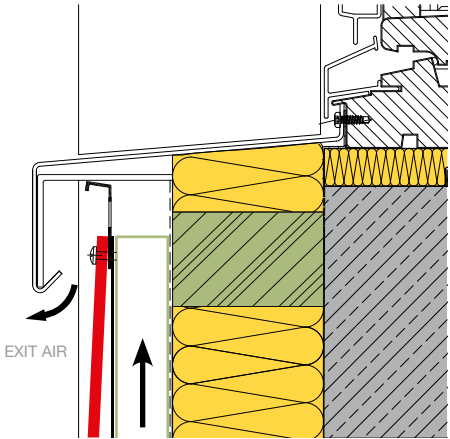

WINDOW SILL CONNECTION A102

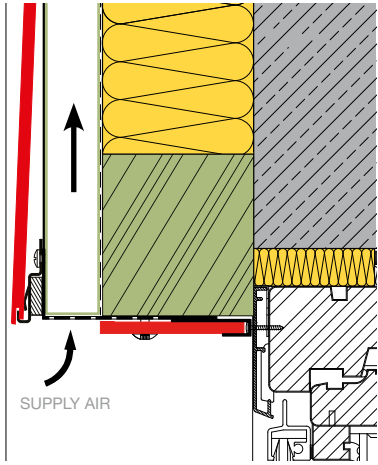

WINDOW LINTEL A101

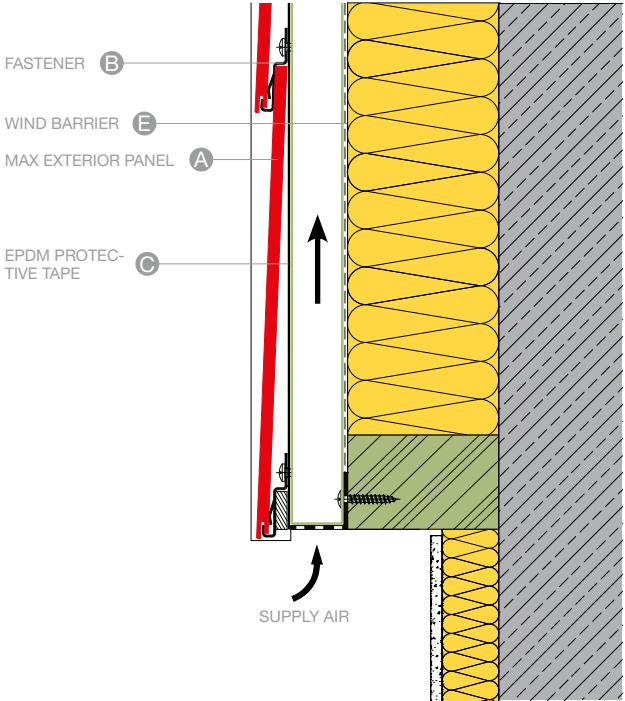

BASE CONNECTION A103

# Construction-details horizontal sections Scaleo Facade System on aluminium substructure

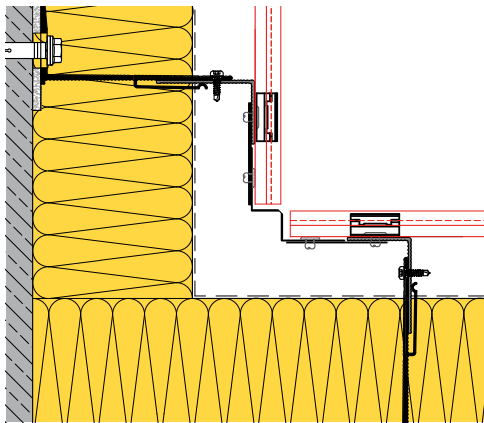
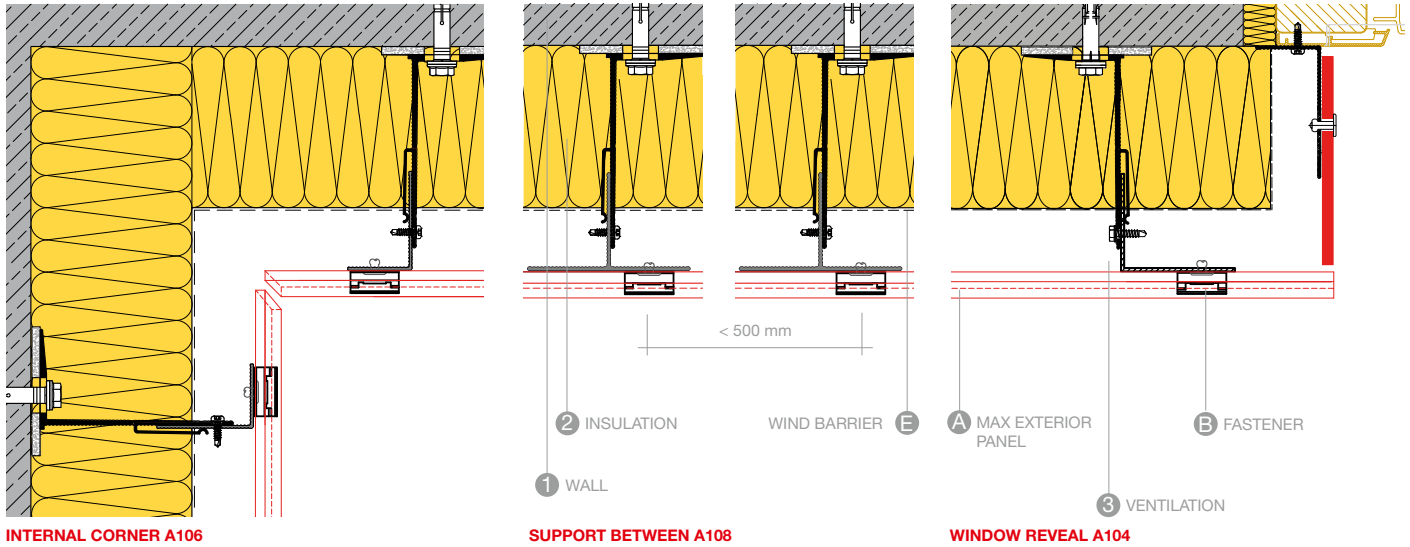

**NOTE**

SUPPLIERS: SEE PAGES 106/107 AT THE END OF THE BROCHURE.

ALL PROFILES AND FASTENINGS ARE SHOWN IN THIS BROCHURE ARE PLANNING-SUGGESTIONS AND NOT PART OF THE FUNDERMAX DELIVERY PROGRAMME!  
ALL DRAWINGS IN THIS BROCHURE ARE NOT TRUE TO SCALE!

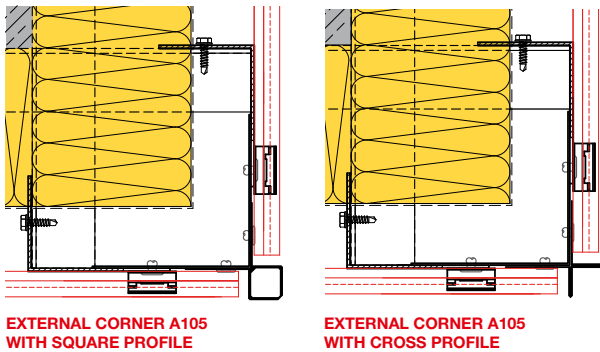

# Construction-details vertical sections Scaleo Facade System on aluminium substructure

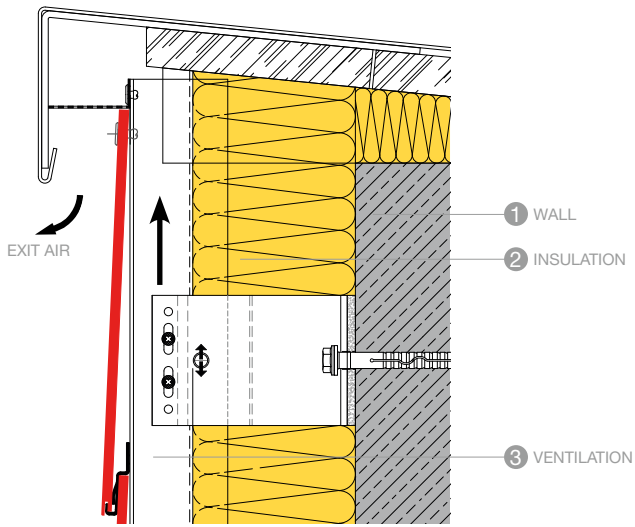

ATTIC CONNECTION A109

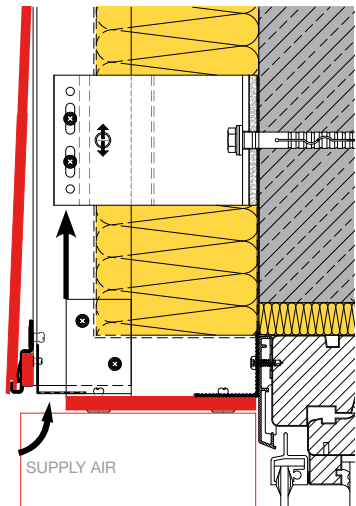

WINDOW LINTEL A101

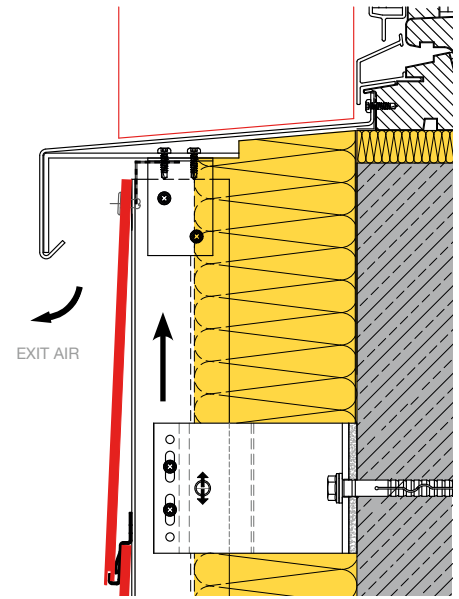

WINDOW SILL CONNECTION A102

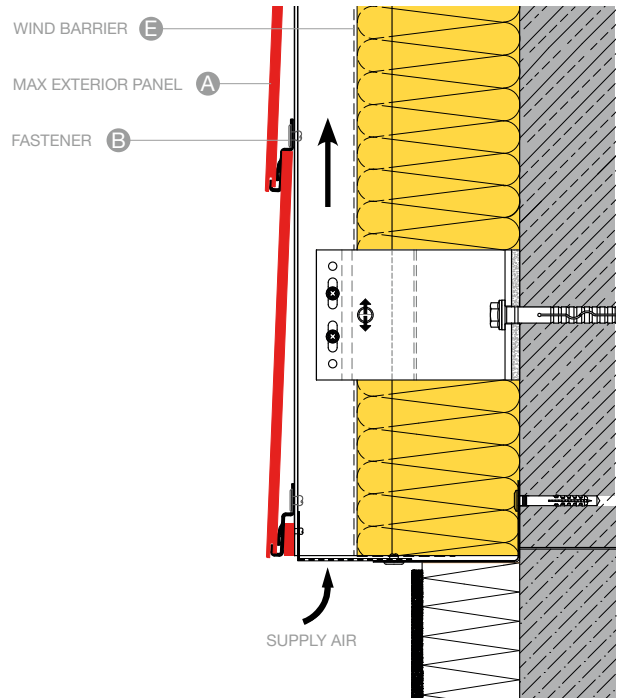

BASE CONNECTION A103

# Modulo Facade System



Fig. 1

## MODULO ASSEMBLY BRACKETS

Packaging unit: 100 pieces  
Requirements, depending on laying procedure, are appr. 8 fasteners/m<sup>2</sup>



ACCESSORIES: FASTENER; FASTENING PROFILE, LOCKING PIN; ASSEMBLY AID Fig. 2

## IMPORTANT ACCESSORIES:

- Fasteners/Fastener Profiles
- Internal and external corner profiles

## ADVANTAGES:

- all advantages of Max Exterior surface
- hail resistant
- weather resistant
- lightfast and UV-stable
- double hardened surface
- quick ship program
- wide range of decors
- easy to install
- narrow joints (2 mm)

## MODULO FACADE SYSTEM

With this modern facade fastening system it is possible to create a facade—as well as interior wall cladding—with prefabricated standard elements with invisible mechanical brackets. The substructure may be a standard wooden or an aluminium substructure.

**Note:** Information about building regulation permits you will find at our website [www.fundermax.at/downloads/](http://www.fundermax.at/downloads/).

## LAYING PROCEDURES OF MODULO

By choosing this laying procedure—and the selection of the décor or varying decors—you have many design possibilities.

**Note:** The arrangement of sheet sizes can significantly influence time and effort required for the substructure. For joints lying vertically one atop the other, particularly careful work is necessary.

## MODULO FORMATS

### Modulo 500:

Format: 465 x 420 mm  
Packaging unit: 6 elements  
Surface coverage: 455 x 414 mm

### Modulo 1000:

Format: 920 x 420 mm  
Packaging unit: 6 elements  
Surface coverage: 910 x 414 mm

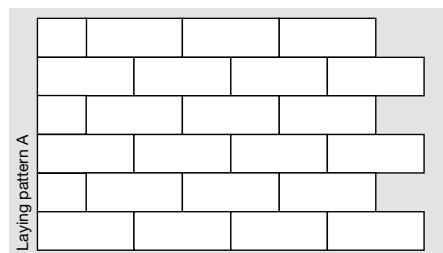

Fig. 3

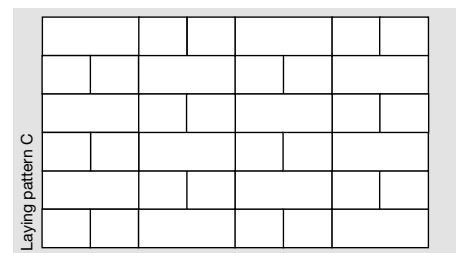

Fig. 5

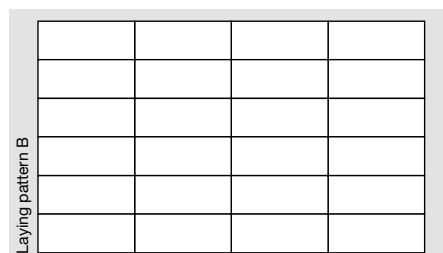

Fig. 4

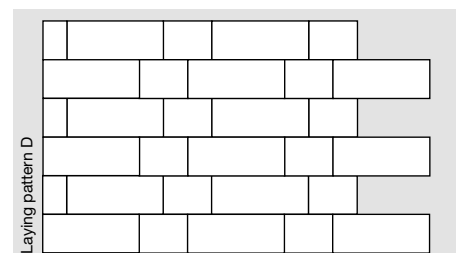

Fig. 6

## Assembly

### 1. PREPARATION

To achieve a visually appealing separation and a cost-efficient cut-off, prior to commencing assembly it is recommended to draw up an exact plan of the facade view based on field measurements. Pay attention to fitting pieces for windows, doors or corners at either end. Do not forget the inner faces of windows and doors when determining the materials to be used. You can also use any oddments that may arise in another line. When doing so, be careful of the vertical rabbets. The elements cannot be rotated! It may be conducive to the appearance (symmetry of support profiles, cuts to fit in the case of windows) and offcuts to begin at the left side and not with an entire element. Determine the needs for Modulo 500 and/or Modulo 1000 elements on this basis.

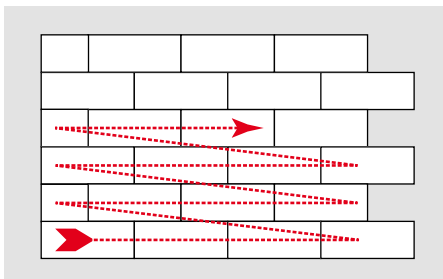

Fig. 7

### 2. SUBSTRUCTURE PREPARATION

As a matter of principle, local building regulations are to be followed in all cases. Pay attention to the hints on pages 46 - 50. The wooden substructure has to be constructed according to the national norms (wood moisture 15%±3). **Pay attention to chemical or constructive wood preservation!** The basic prerequisite for perfect assembly of the facade system Modulo is a professional, precisely aligned substructure with minimum of 85 x 30 mm shaped battens.

In case of using facade screws (List of suppliers you will find on page 106) we recommend a primary drilling of the wooden substructure according to the hints of the screw manufacturer.

The wooden substructure battens has to be protected permanently against moisture by an UV- and weather-resistant EPDM protective tape, which is minimum 1.2 mm thick. It is also possible to use an aluminium substructure. The average distance for the standard lengths of 465/920 mm is 455 mm. For special lengths, please determine this distance yourself. If you use the exterior corner profiles that we offer, a batten width at the exterior corner of 100 mm is recommended.

Due to the system sheets' horizontal and vertical rabbeting, we recommend beginning assembly at the bottom left. In general, the assembly of all facade parts, including the window boards, must begin simultaneously with the facade assembly and be performed from the bottom to the top.



Fig. 8

### 3. ASSEMBLY OF THE FIRST ROW

Once the substructure has been precisely assembled and the necessary metal covering work performed, mount first the fastener profile. This must be aligned horizontally very precisely. The fastener profile of Modulo has to be mounted with a fix-point and sliding-points (long hole 5.1 x 11 mm). All further rows are mounted with Modulo fasteners.



Fig. 9



Fig. 10

**4. ASSEMBLY OF THE FIRST MODULO ELEMENTS**

Set the Modulo elements on top of the substructure beginning at the lower left (with the groove facing downwards). Prior to screwing on the upper bracket, the assembly aid must be inserted into both of the holes in the fastener. This guarantees that the sheet will have sufficient vertical clearance. Screw each fastener tightly onto the substructure using two facade screws (at least V4A), 4.8 x 30 mm.



Fig. 1



Fig. 2

**5. ASSEMBLY OF THE NEXT MODULO ELEMENT**

Screw the second element to the first one at a distance of 2 mm. Use the assembly aid to determine the distance. After screwing on the second element and checking the distance, drill through the Modulo element at the upper left fastener in the hole provided and affix the element to the substructure using the supplied locking pin. The element is thereby secured against lateral shifting.

In case of an aluminium-substructure we recommend to put an approx. 3 cm long glue strip on the lower Modulo fastener (Note: only one fixing per element with glue strip is necessary - see fig. 7). The surfaces of the fastener and panel have to be cleaned according to the hints of the glue-manufacturer. SIKA and Innotec offer such glue systems. Please follow their instruction notes.



Fig. 3

**6. CUTS TO FIT/LATITUDE**

Continue assembly of the facade in this fashion. Cut the right side to fit, as needed. Please always heed a latitude of at least 5 mm to the other construction parts.



Fig. 4

**7. CONCLUDING ASSEMBLY**

For upper or lower cuts to fit, the sheet is to be fastened visibly with facade screws or facade rivets with an appropriate grip of rivet (ex 19 mm, e.g. 5 x 25 mm rivet). For distancing to the substructure, please use off-cuts from the Modulo elements (fasteners are 8 mm thick, sheet off-cuts are likewise 8 mm thick).



Fig. 5



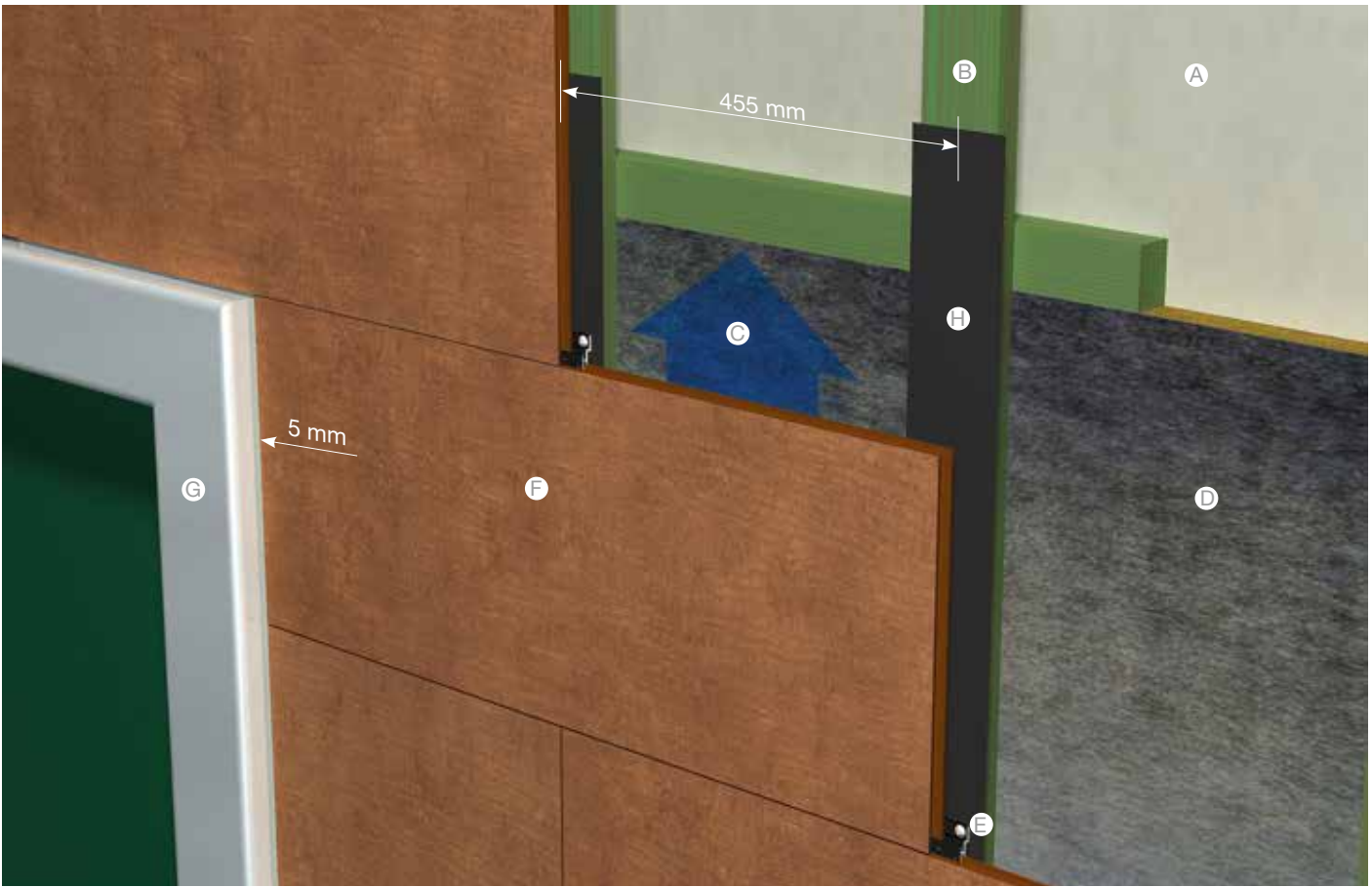

MODULO SYSTEM FACADE

Fig. 6

**MODULO SYSTEM FACADE WITH ALU-SUBSTRUCTURE**

Of course, Modulo can also be assembled with an aluminium substructure. For this type of assembly, 2 blind rivets (5 x 10 mm with max. head K14) per fastener must be used if the substructure's material thickness is between 1.5 and 3 mm (length max. 2800 mm).

The installation process is identical to that of the wooden substructure.

\*ONTO AN ALUMINIUM-SUBSTRUCTURE WE RECOMMEND TO FIX THE PANEL AGAINST SHIFTING WITH ONLY ONE GLUE STRIP PER PANEL (APPROX. 3 CM LONG - SEE FIG. 7).

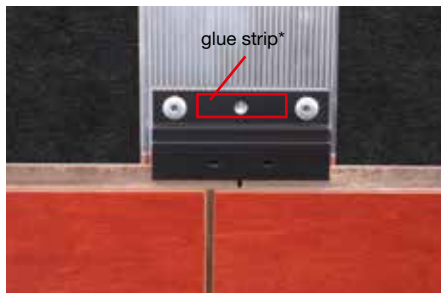

Fig. 7

**LEGENDE**

- A WALL
- B SUBSTRUCTURE
- C VENTILATION
- D INSULATION
- E FASTENER (MOUNTING CLIP)
- F MODULO ELEMENT
- G BUILDING ELEMENTS LIKE WINDOWS/ DOORS OR WALL SOCKETS
- H EPDM PROTECTIVE TAPE (MIN. 1.2 mm THICK)

**NOTE**  
SUPPLIERS: SEE PAGES 106/107 AT THE END OF THE BROCHURE.

# Construction-details horizontal sections Modulo Facade System on wooden substructure

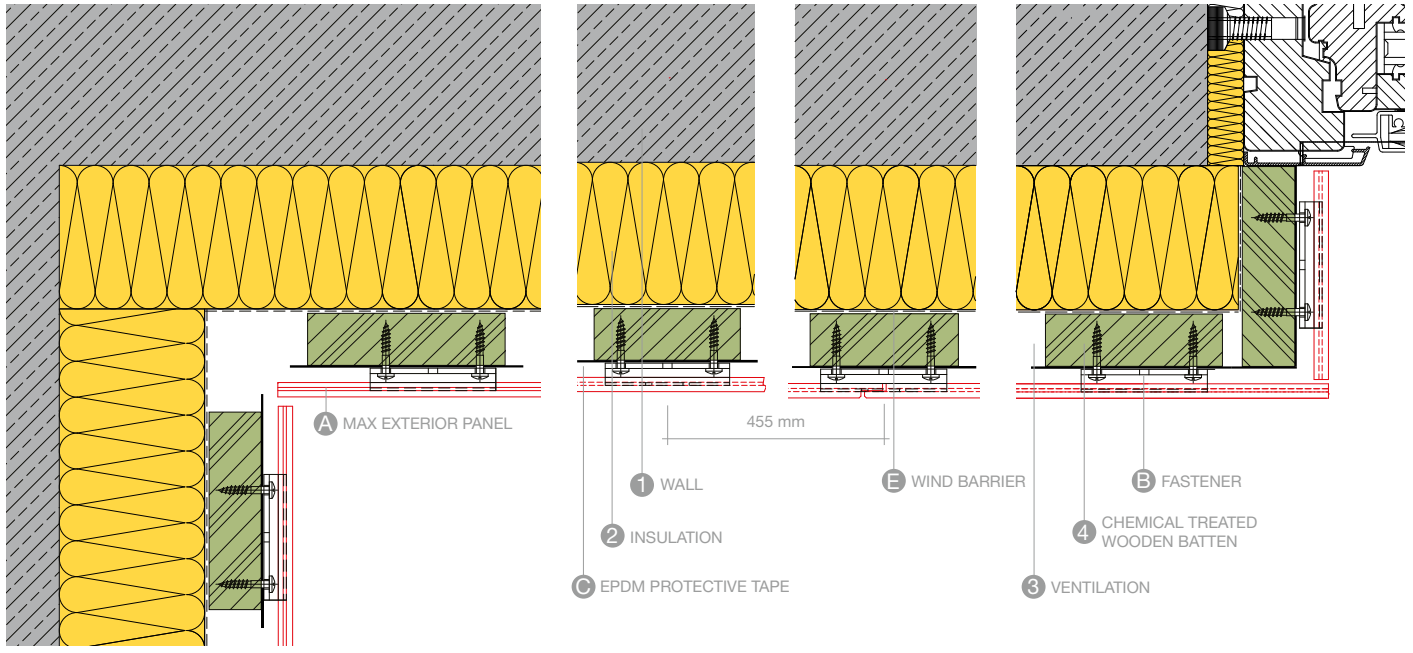

INTERNAL CORNER A106

SUPPORT BETWEEN A108

WINDOW REVEAL A104

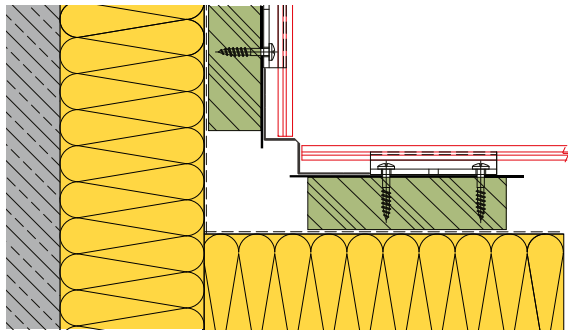

INTERNAL CORNER A106 WITH PROFILE

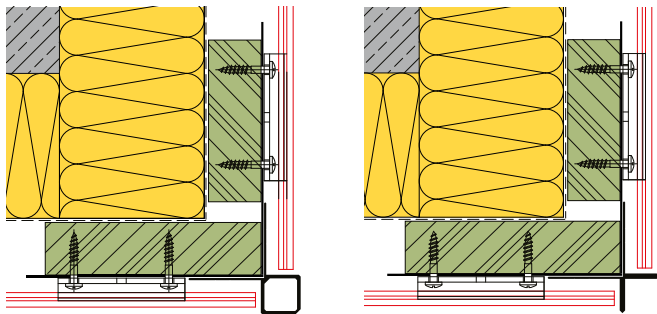

EXTERNAL CORNER A105 WITH SQUARE PROFILE

EXTERNAL CORNER A105 WITH CROSS PROFILE



**NOTE**  
SUPPLIERS: SEE PAGES 106/107 AT THE END OF THE BROCHURE.

ALL PROFILES AND FASTENINGS ARE SHOWN IN THIS BROCHURE ARE PLANNING-SUGGESTIONS AND NOT PART OF THE FUNDERMAX DELIVERY PROGRAMME!  
ALL DRAWINGS IN THIS BROCHURE ARE NOT TRUE TO SCALE!

# Construction-details vertical sections Modulo Facade System on wooden substructure

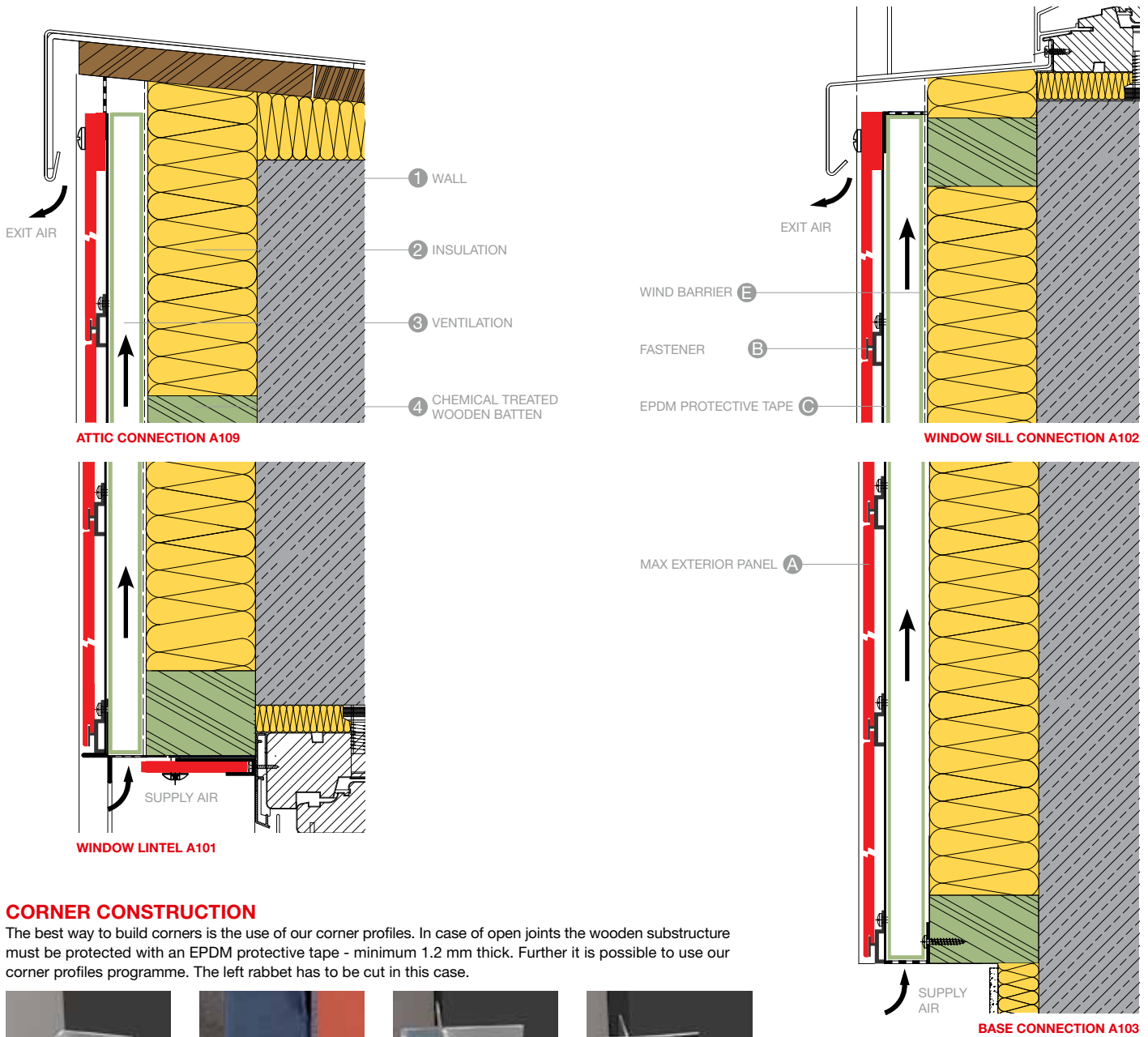

## CORNER CONSTRUCTION

The best way to build corners is the use of our corner profiles. In case of open joints the wooden substructure must be protected with an EPDM protective tape - minimum 1.2 mm thick. Further it is possible to use our corner profiles programme. The left rabbet has to be cut in this case.



INTERNAL CORNER PROFILE Fig. 1



OPEN CORNER JOINT WITH EPDM PROTECTIVE TAPE Fig. 2



SQUARE CORNER PROFILE Fig. 3



CROSS CORNER PROFILE Fig. 4

# Construction-details horizontal sections Modulo Facade System on aluminium-substructure

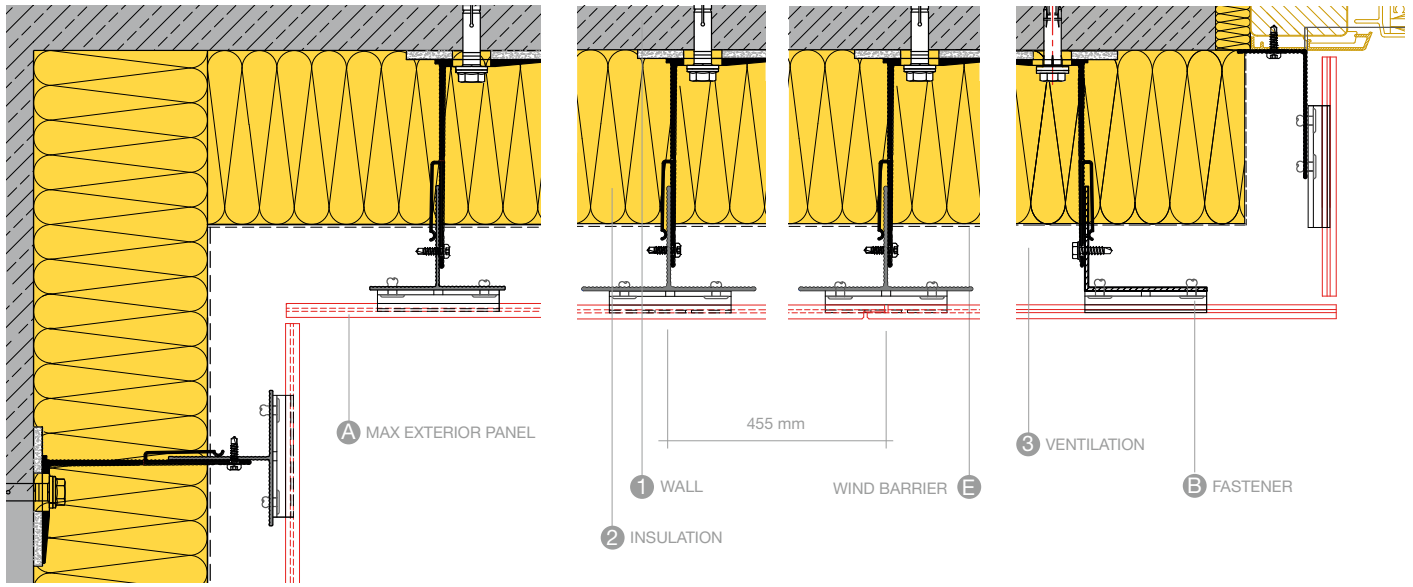

INTERNAL CORNER A106

SUPPORT BETWEEN A108

VERTICAL JOINT A107

WINDOW REVEAL A104

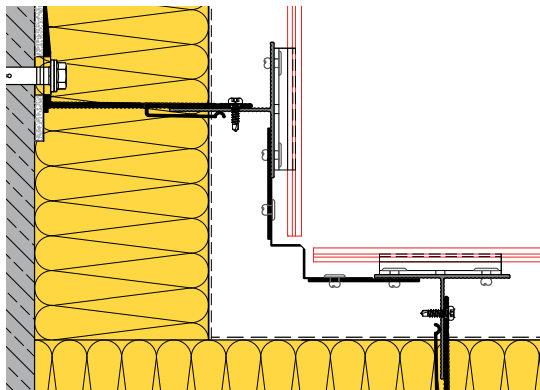

INTERNAL CORNER A106 WITH PROFILE

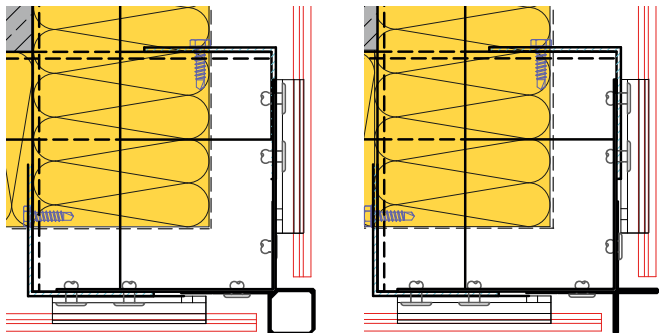

EXTERNAL CORNER A105 WITH SQUARE PROFILE

EXTERNAL CORNER A105 WITH CROSS PROFILE

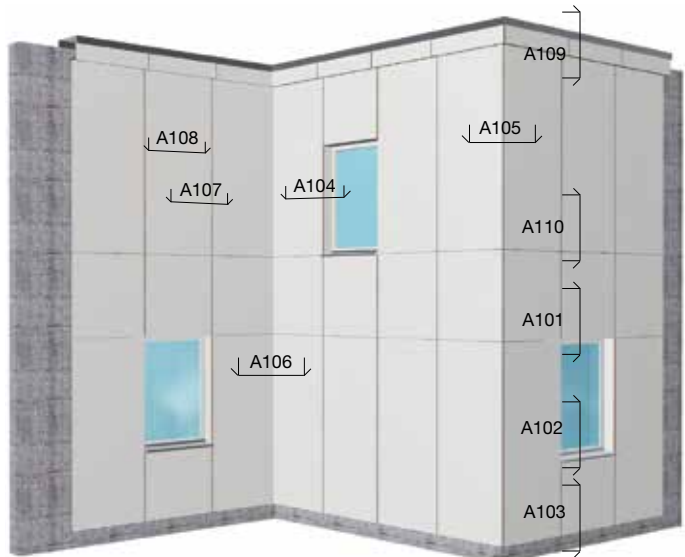

# Construction-details vertical sections Modulo Facade System on aluminium-substructure

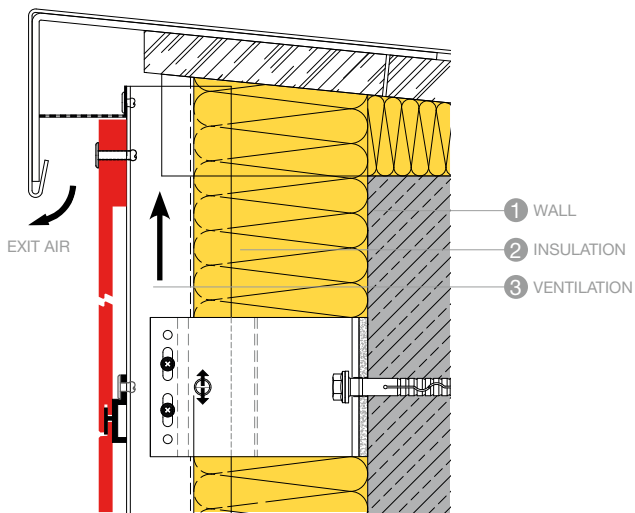

ATTIC CONNECTION A109

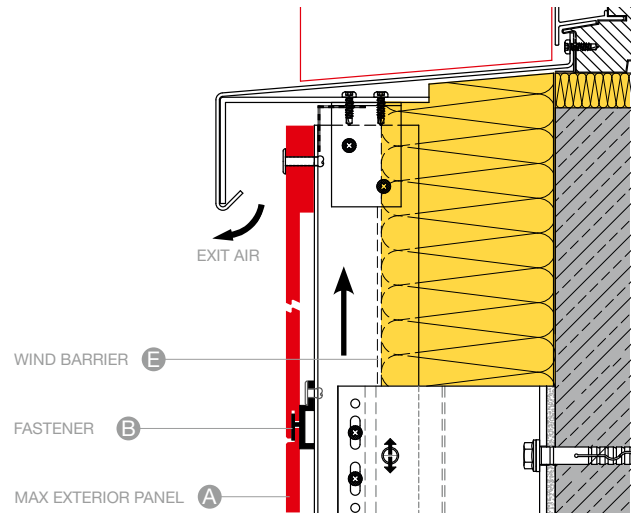

WINDOW SILL CONNECTION A102

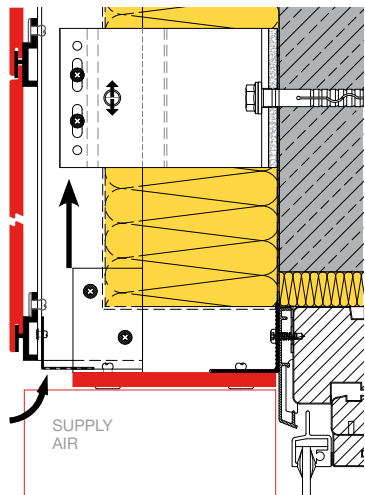

WINDOW LINTEL A101

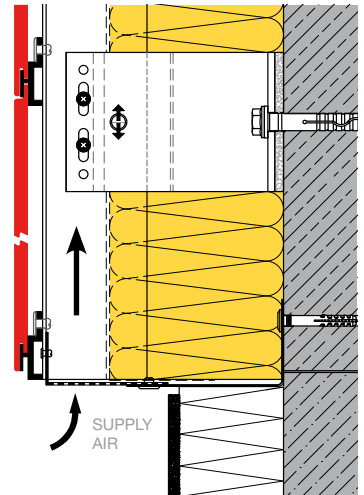

BASE CONNECTION A103

**NOTE**  
SUPPLIERS: SEE PAGES 106/107 AT THE END OF THE BROCHURE.

ALL PROFILES AND FASTENINGS ARE SHOWN IN THIS BROCHURE ARE PLANNING-SUGGESTIONS AND NOT PART OF THE FUNDERMAX DELIVERY PROGRAMME!  
ALL DRAWINGS IN THIS BROCHURE ARE NOT TRUE TO SCALE!

## Visible mechanical fastenings with rivets or screws



Fig. 1



Fig. 2

Max Exterior panels can be mounted using rivets on an aluminium substructure, or with screws on a wood framework. Pay attention to the hints on pages 46 - 50. The wooden substructure has to be constructed according to the national normes (wood moisture  $15\% \pm 3$ ). **Pay attention to chemical or constructive wood preservation!**

There always has to be put a protection tape (thickness 1.2 mm) between the Max Exterior panel and the wooden batten. An overhang of  $\geq 10$  mm on each edge is essential. The lathework has always built in parallel to the airstream. Openings for supply and exit-air have to be done with  $\geq 20$  mm free cross-section. The exit-air always leaves over the rear-ventilated section of the rear-ventilated facade. Connection with EIFS facades are allowed only if these have an exit-air section also.

Due to the material properties of Max Exterior, fixed point and sliding points need to be made to mount the panels.

### FIXED POINTS

Fixed points are used for uniform distribution (halving) of the expansion and shrinkage movements. The diameter of the drill hole in Max Exterior has to be same of the diameter of the fastener.

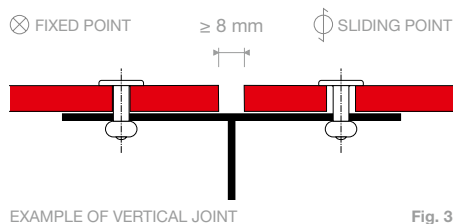

Fig. 3

### NOTE

TO GET A PERFECT DESIGN OF THE FACADE CLADDING WITH NG SURFACE IT IS RECOMMENDED TO GLUE THE PANELS ON AN ALUMINIUM-SUBCONSTRUCTION. SUBCONSTRUCTION LIKE WOOD DO NOT HAVE THE RIGHT PROPERTIES TO AVOID A WAVY APPEARANCE OF THE CLADDING.

### SLIDING POINTS

The diameter of the drill hole in Max Exterior must be drilled larger than the diameter of the fastening, depending on the required expansion clearance. This is the shaft diameter of the fastening plus 2 mm for every meter of cladding material starting from the fixed point. The head of the fastening must be big enough so that the drill hole in Max Exterior is always covered. The fastening is placed in such a way that the panel can move. Screws must not be over-tightened. Do not use any countersunk screws. The centre point of the drill hole in the subconstruction must coincide with the centre point of the drill hole in the Max Exterior panels. Drill with a centring piece. The fastenings should be put in place starting from the middle of panel outwards.

**EDGE SPACINGS**

For reasons of stability and flatness, the edge spacings must be kept to without fail. The joints must be made at least 8 mm wide so that changes in size can take place without hindrance (Fig. 3).

**FASTENING SPACINGS**

These are to be chosen in accordance with the structural engineering requirements (calculations) or, if this is not necessary due to the local regulations, according to table no. 1.

**FASTENINGS**

It is essential that fastenings are made from non-corrosive materials.

**Max Exterior Installation screw**

(page 52, Fig. 3) with Torx wrench 20 made of stainless steel CrNiMo 17122 Material no. 1.4401 V4A. Lacquered head on request.

Diameter of drill hole in Max Exterior for installation with screw  
 Sliding points: 8 mm or as required  
 Fixed points: 6.0 mm

**Alu-Blind rivet**

(Page 25, Fig. 6) with big head colour lacquered for outdoor applications with Max Exterior panels on aluminium-substructures. Rivet sleeve: material-no. EN AW-5019 acc. DIN EN 755-2  
 Rivet pin: steel material-no. 1.4541  
 Pull-off strength of rivet pin: ≤ 5.6 KN  
 Diameter of drill hole in Max Exterior for installation with rivets  
 Sliding points: 8.5 mm or as required  
 Fixed points: 5.1 mm

Diameter of drill hole in aluminium substructure: 5.1 mm The rivets must be put in place with a flexible mouthpiece, clearance 0.3 mm. The rivet, flexible mouthpiece and riveting tool must be suited to each other.

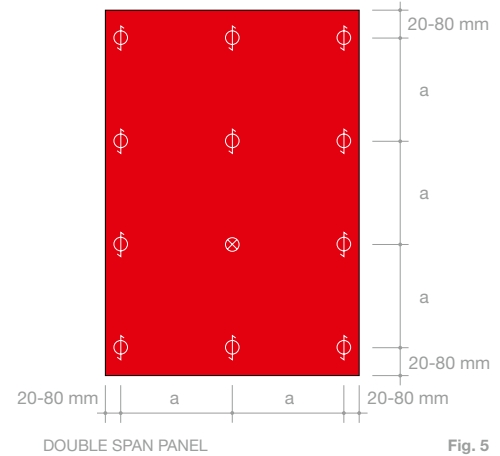
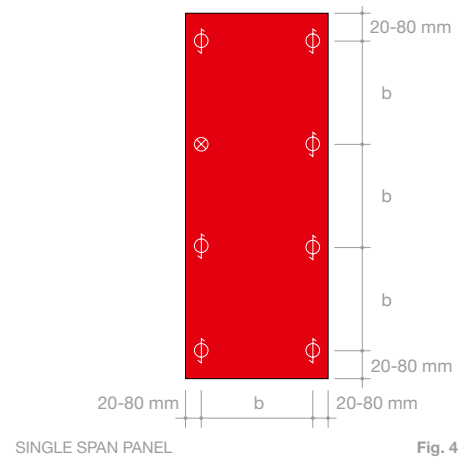

⊖ = SLIDING POINT  
 ⊗ = FIXED POINT

**FOR INSTALLATION WITH MECHANICAL FASTENINGS**

PANEL THICKNESS	MAXIMUM FASTENING SPACING „b“ SINGLE SPAN PANEL	MAXIMUM FASTENING SPACING „a“ DOUBLE SPAN PANEL
6 mm	350 mm	400 mm
8 mm	400 mm	450 mm
10 mm	450 mm	500 mm

Table 1

# Construction-details horizontal sections - Soffits riveted

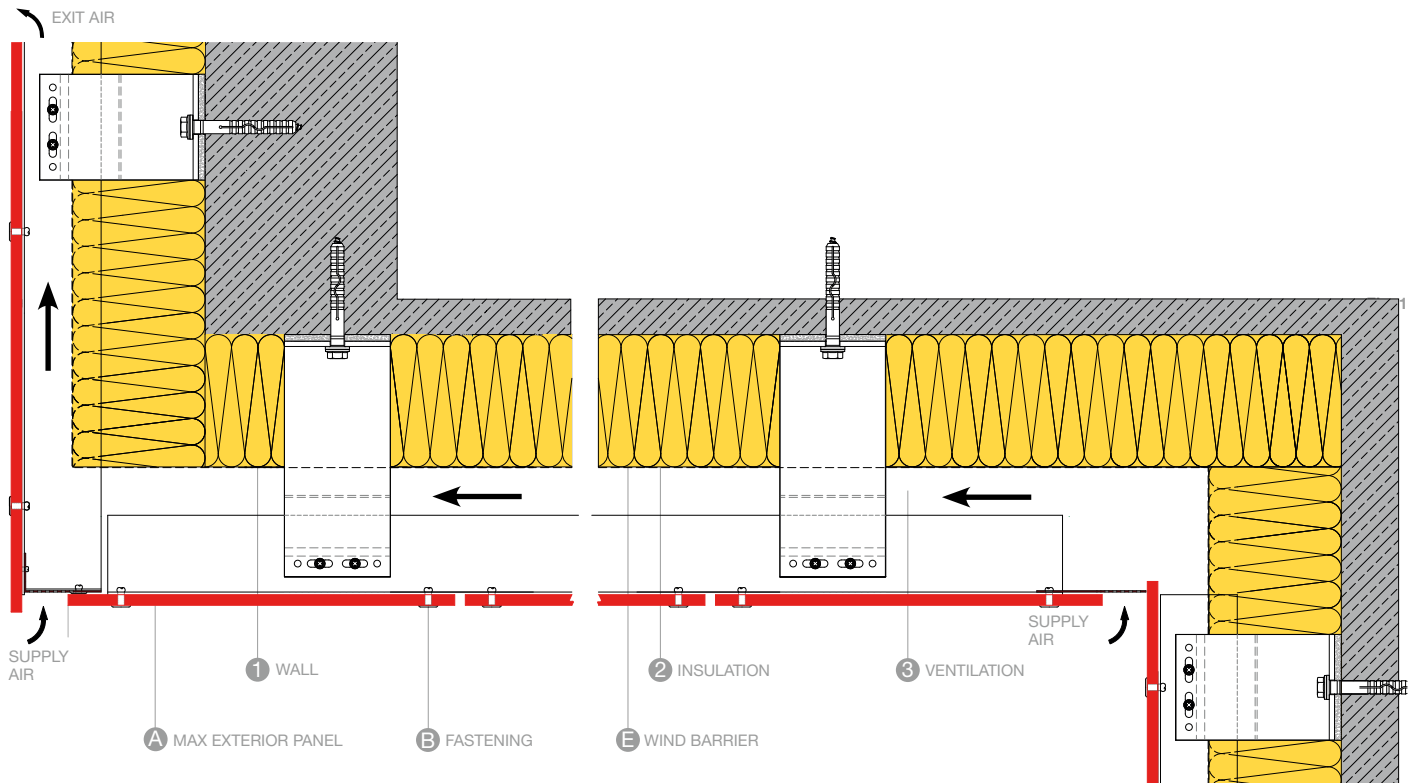



# Concealed mounting with gluing system

## SUPPLIERS OF GLUES

Sika Tack Panel  
Z-10.8-408  
MBE Panel-loc glue system  
Z-10.8-350  
PROPART Klebedicht KD385  
Z-10.8-453  
Innotec Project System  
Z-10.8-483

As an alternative to installation with visible mounting means, Max Exterior panels can be installed with gluing systems on aluminum substructures.

A structural analysis must be performed to verify the stability of each object.

It is important that necessary approvals are obtained from the relevant competent municipal or federal building authorities. Due to the different building regulations in different regions, it could be that the building authorities require additional mechanical securing means such as rivets, screws, or the like.

The gluing process is to be performed in accordance with the manufacturer guidelines for the glue.

FunderMax recommends using gluing systems that are approved by the responsible building authorities for the installation of non-bearing, rear-ventilated facades.

In principle, the following points should be considered during the work process:

## PRETREATMENT OF ALUMINIUM SUBCONSTRUCTIONS

- Rub down with an abrasive fleece
- Clean with a cleaner of the producer of the glue
- Apply the primer as told by the glue system producer

## PRETREATMENT OF MAX EXTERIOR PANEL

- Rub down with an abrasive fleece
- Clean with a cleaner of the producer of the glue
- Apply the primer as told by the glue system producer

All surfaces to be glued must be kept clean, dry and grease-free. The construction design must ensure that the glue is not subjected to any accumulating moisture.

## Recommendations for producing outdoor-furniture

### APPLICATION

Max Exterior panels are often used as table tops, benches or furniture in outdoor applications.

### RESISTANCE

Due to their pore-free surfaces and excellent chemical resistance, Max Exterior panels are very easy to clean. Further advantages of these panels include their high scratch, tear and impact resistance.

### STORAGE

Neither tables nor table panels should be stacked as the heavy stack weight can lead to damage. Further the outdoor-furniture should not be exposed to standing water.

### PANEL THICKNESS

The thickness of Max Exterior (table) panels should either be 12 mm, or at least 10 mm, in order to allow enough depth for screwing. Both panel thickness and mounting distances as well as expected load platforms, are directly linked and must be measured correspondingly.

### FASTENING

The fastening of Max Exterior F-quality panels can be carried out in a number of different ways, however, due to the material characteristics, a linear free expansion must be considered during the mounting process. The panels can be mounted mechanically using screws or using glues. The screws can either be directly screwed into the panels or inserted using sleeve screws with internal and external threads (e.g. Rampa inserts). For this, the panels must be pre-drilled for to establish a thread. Fastening the panels using screws takes place from the underside of the material. Therefore, metric thread and flat-head screws are suitable. Washers can be used if required.

Due to Max Exterior panels material characteristics, the fixing points must be sliding points.

### SLIDING POINT

The drill diameter in the substructure must be bigger than that of the mounting material depending on the corresponding Compact expansion room. The screw head should always cover the borehole. The mounting material will be attached in such a way that the panels are free to move. Screws should not be too tightly fastened. The middle point of the drilling in the substructure should correspond with the middle point of the drilling in the Max Exterior F-quality panel.

Drill with centering sleeve! The fastening material should be attached from the middle of the panel outwards.

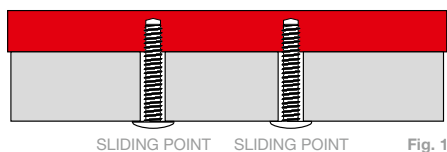
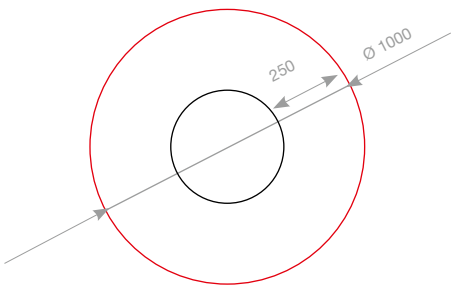

Fig. 1

**FASTENING SPACINGS**

MAX EXTERIOR PANELS		
THICKNESS (mm)	FASTENING SPACING (mm)	PROJECTION (mm)
10	320	180
12	400	250

Table 1



EXAMPLE FOR TABLE APPLICATION

Fig. 2



Fig. 4

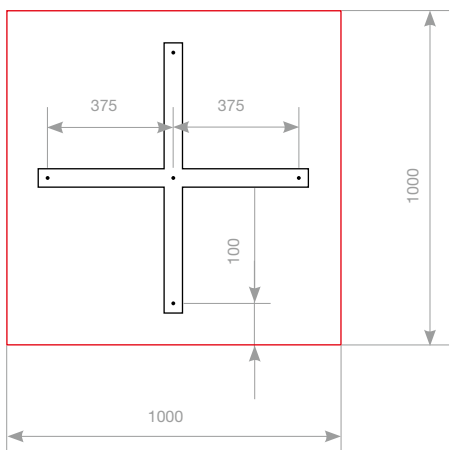

EXAMPLE FOR TABLE APPLICATION

Fig. 3

- 77 General
- 79 Fastenings for balconies
- 80 Principle of fastening the railingstructure
- 81 Fastening and Edge Spacing - Variants
- 88 Balcony partition wall



**NOTE**

PLEASE CHECK ADDITIONAL AT [WWW.FUNDERMAX.AT](http://WWW.FUNDERMAX.AT) FOR THE LATEST VERSION OF THIS BROCHURE.

THE DIAGRAMS IN THIS TECHNICAL INFORMATION ARE SCHEMATICAL REPRESENTATIONS AND ARE NOT TRUE TO SCALE.  
THIS ISSUE REPLACES ALL OTHER ISSUES OF EXTERIOR TECHNIQUES BROCHURES OF FUNDERMAX WHICH WERE PUBLISHED BEFORE.



## General

Max Exterior panels can be mounted in a variety of different designs as panels for balconies, railings or fencing.

### BASICS

During construction and installation, care is to be taken that the material is not exposed to standing water. This means that the panels must always be able to dry out.

Connections of Max Exterior panels to one another always have to be made in the same panel direction. Max Exterior can show deviations from being flat (see EN 438-6, 5.3), and this is to be compensated for by the sub-construction being executed so that it is stable and flat. All connections to other components or to the background must be executed firmly. Elastic intermediate spacers to the sub-construction elements and also between sub-construction elements which permit a greater tolerance than  $\pm 0.5$  mm must definitely be avoided. Max Exterior panels can be mounted with rivets or screws. Due to the material properties of Max Exterior panels, fixed point and sliding points need to be made to mount the panels (page 78, Fig. 3).

### TECHNICAL NOTES

The substructure is to be protected against corrosion regardless of the material or system used. Anchoring elements for installation on walls or for installation of the panels must be suitably dimensioned to withstand the local wind loads and meet the local structural requirements. Verifications are to be submitted to the client. The necessary space for expansion according to the manufacturer's recommendations must be taken into account when installing Max Exterior panels.

# General

## SLIDING POINT

The diameter of the drill hole in Max Exterior must be drilled larger than the diameter of the fastening, depending on the required expansion clearance. This is the shaft diameter of the fastening plus 2 mm for every meter of cladding material starting from the fixed point. The head of the fastening must be big enough so that the drill hole in Max Exterior is always covered. The fastening is placed in such a way that the panel can move. Rivets are put in place with flexible mouth-pieces. The defined clearance of the rivet head, allows movement of the elements in the drill hole. Clearance + 0.3 mm (Fig. 8). Screws must not be over-tightened. Do not use any countersunk screws - use washers if necessary. The centre point of the drill hole in the subconstruction must coincide with the centre point of the drill hole in Max Exterior panel. Drill with a centring piece! The fastenings should be put in place starting from the middle of panel outwards.

## FIXED POINT

Fixed points are used for uniform distribution (halving) of the expansion and shrinkage movements. The diameter of the drill hole in Max Exterior is the same size as the diameter of the fastening.

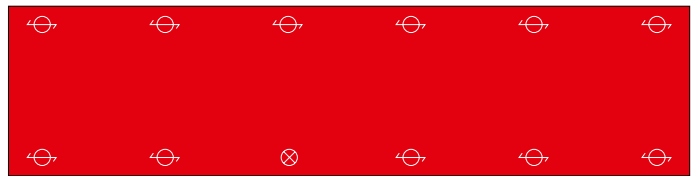

SINGLE SPAN PANEL

Fig. 1

⊖ = SLIDING POINT

⊗ = FIXED POINT

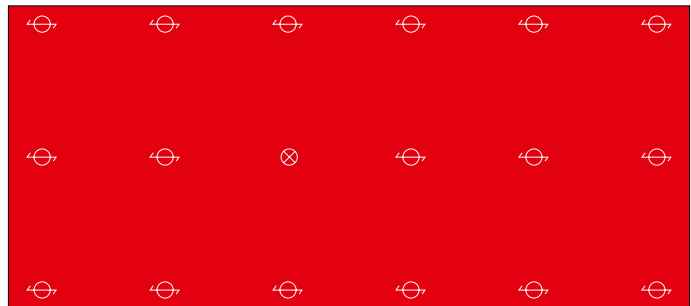

DOUBLE SPAN PANEL

Fig. 2

## PANEL JOINTS

The joints must be made at least 8 mm wide so that changes in size can take place without hindrance. In order to be able to design the inner sides of balconies so that they are uniformly sight, it is possible to produce Max Exterior panels with a white (rear) side decor 0890 NT balcony white. Due to the asymmetric composition the fixing distances should be reduced by 15%.

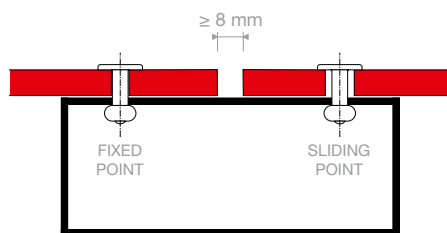

Fig. 3

## BALCONY CORNERS

Especially, in some circumstances, when refurbishing with very uneven subconstructions, it is important to have the front panel protrude about 10 mm in front of the side panel. In this way, inaccuracies can be concealed from the main viewing side.

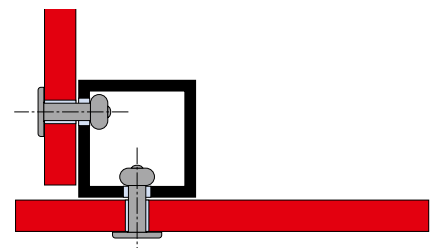

Fig. 4

# Fastenings for balconies

It is essential that fastenings are made from non-corrosive materials.

## MAX EXTERIOR BALCONY SCREW (A2)

With bare head, can be lacquered.  
 Washer between Max Exterior panel and subconstruction made of polyamide.  
 Diameter of drill hole in Max Exterior Panel:  
 Sliding points: 8 mm or as required  
 Fixed points: 6 mm  
 Diameter of drill hole in substructure:  
 Drill hole for mounting: 6 mm or according to the dimension of fix-point-socket.

Screw length =  
 Clamping thickness +  $\geq 9$  mm

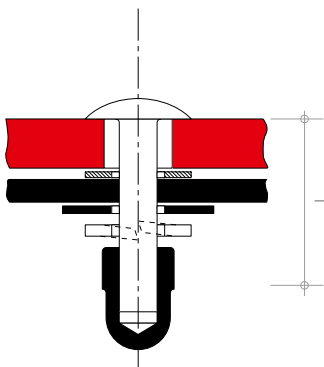

Fig. 5

## ALUMINIUM BLIND RIVET

with big head colour lacquered for Aluminium-subconstructions.  
 Rivet sleeve: material-no. EN AW-5019 acc. DIN EN 755-2  
 Rivet pin: steel material-no. 1.4541  
 Pull-off strength of rivet pin:  $\leq 5.6$  KN

## NIRO/NIRO BLIND RIVET

with big head colour lacquered for steel subconstructions.  
 Rivet sleeve: material-no. 1.4567 (A2)  
 Rivet pin: steel material-no. 1.4541 (A2)  
 Pull-off strength of rivet pin:  $\leq 5.8$  KN

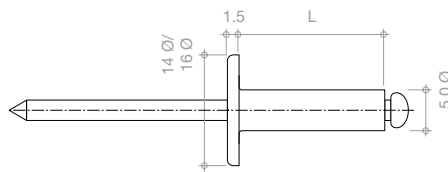

Fig. 6

Diameter of the drill hole in the Max Exterior panel.  
 Sliding points: 8.5 mm or as required.  
 Fixed points: 5.1 mm  
 Diameter of drill hole in the metal subconstruction: 5.1 mm

## GLASS MOUNTING BRACKETS

may be used for fixing Max Exterior panels also. Clamping jaws should have securing pins which prevent the filler elements from falling if the clamp should slacken.

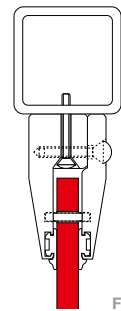

Fig. 7

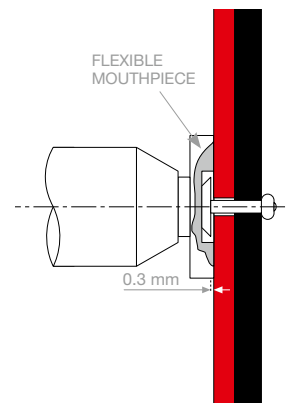

Fig. 8

**The rivets must be put in place with a flexible mouthpiece, clearance 0.3 mm.**

APPROVALS FROM THE BUILDING AUTHORITIES FOR SCREWS AND RIVETS CAN BE OBTAINED FROM THE RESPECTIVE SUPPLIERS.

SUPPLIERS OF FASTENING AND SUBSTRUCTURES YOU WILL FIND ON PAGES 106/107 OR AT „WWW.FUNDERMAX.AT“.

# Principle of fastening the railingstructure

## FASTENING BELOW THE CONCRETE BASE

x = Fastening screw according to the static needs.

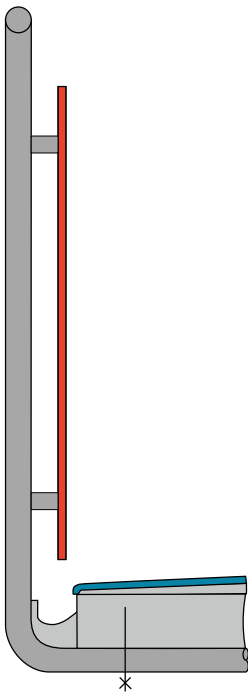

Fig. 1

## FASTENING ON THE CONCRETE BASE

x = Fastening screw according to the static needs.

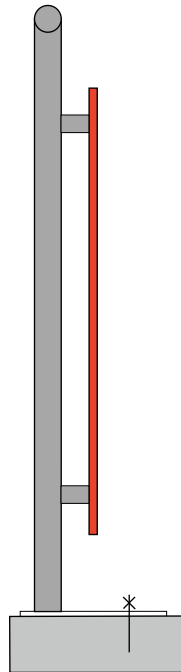

Fig. 2

## FASTENING ON THE FRONTSIDE OF THE CONCRETE BASE

x = Fastening screw according to the static needs.

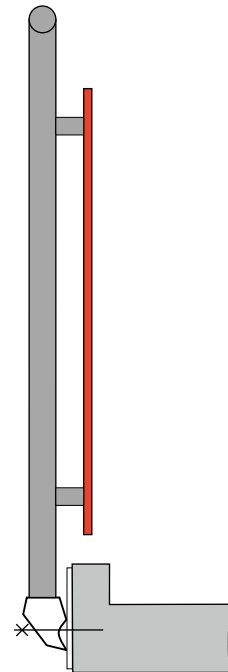

Fig. 3

THE RAILING HEIGHT IS CALCULATED FROM THE UPPER EDGE OF THE CONCRETE UPSTAND AS THIS IS TO BE REGARDED AS THE STEP SURFACE.



# Fastening and Edge Spacing - Variants

**MAX EXTERIOR RIVETED PANELS.  
RIVETING DONE AS DESCRIBED ON PAGE 79.**



Fig. 4

The railing installation variants shown here have been tested at the University of Technology, Hanover in accordance with the ETB guidelines for „Building Components which Safeguard against Falls, June 1985“ and passed.

- $F1 \leq 120 \text{ mm}$
- $F2 \leq 40 \text{ mm}$
- Projecting ends E
- for 6 mm panels:  $20 \text{ mm} \leq E \leq 120 \text{ mm}$
- for 8 mm panels:  $20 \text{ mm} \leq E \leq 200 \text{ mm}$
- for 10 mm panels:  $20 \text{ mm} \leq E \leq 250 \text{ mm}$

Panel thickness in mm		Height of railing*
		H = 900-1100 mm = maximum fastening spacing
6 mm	A	$\leq 350 \text{ mm}$
	L	$\leq 800 \text{ mm}$
8 mm	A	$\leq 350 \text{ mm}$
	L	$\leq 950 \text{ mm}$
10 mm	A	$\leq 400 \text{ mm}$
	L	$\leq 1000 \text{ mm}$

Table 1

\*THE HEIGHT OF THE RAILING MUST COMPLY WITH THE LOCAL BUILDING REGULATIONS. E.G. OIB DIRECTIVE 4 - USE AND ACCESSIBILITY. THE HEIGHT OF THE RAILING MUST BE AT LEAST 1000 mm; STARTING FROM A HEIGHT OF FALL WITH MORE THAN 12 m, MEASURED FROM THE BASE, MUST BE MINIMUM 110 cm.

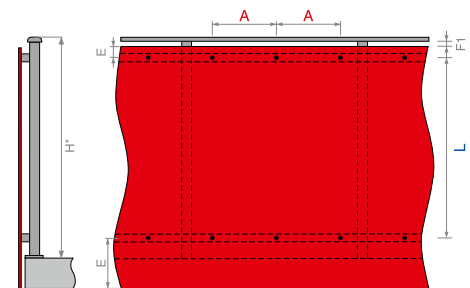

Fig. 5

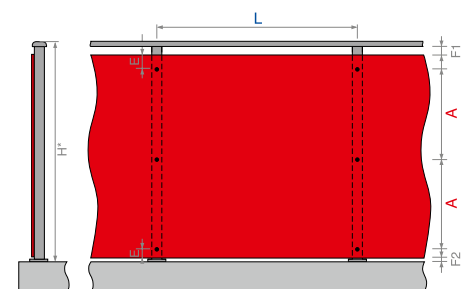

Fig. 6

# Fastening and Edge Spacing - Variants

**MAX EXTERIOR SCREWED PANELS.  
BALCONY SCREWS AS DESCRIBED ON PAGE 79.**



Fig. 1

- F1 ≤ 120 mm
- F2 ≤ 40 mm
- Projecting ends E
  - for 6 mm panels: 20 mm ≤ E ≤ 120 mm
  - for 8 mm panels: 20 mm ≤ E ≤ 200 mm
  - for 10 mm panels: 20 mm ≤ E ≤ 250 mm

Panel thickness mm		Height of railing* H = 900 - 1100 mm = maximum fastening spacing
6 mm	A	≤ 450 mm
	L	≤ 850 mm
8 mm	A	≤ 500 mm
	L	≤ 1000 mm
10 mm	A	≤ 550 mm
	L	≤ 1100 mm

Table 1

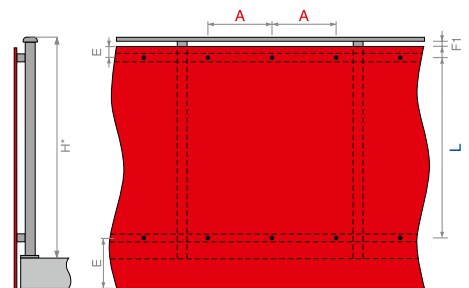

Fig. 2

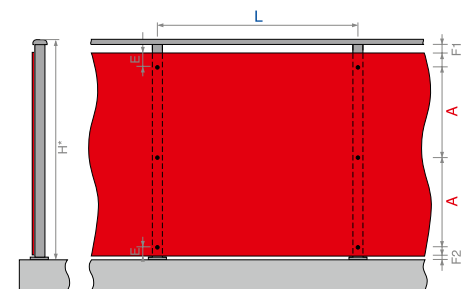

Fig. 3

\* THE HEIGHT OF THE RAILING MUST COMPLY WITH THE LOCAL BUILDING REGULATIONS. E.G. OIB DIRECTIVE 4 - USE AND ACCESSIBILITY. THE HEIGHT OF THE RAILING MUST BE AT LEAST 1000 mm; STARTING FROM A HEIGHT OF FALL WITH MORE THAN 12 m, MEASURED FROM THE BASE, MUST BE MINIMUM 110 cm.

# Fastening and Edge Spacing - Variants

**MAX EXTERIOR PANELS WITH ALUMINIUM EDGE STRIPS FIXED. DIMENSIONING ACCORDING TO STRUCTURAL ENGINEERING REQUIREMENTS.**



Fig. 4

- F1 ≤ 120 mm
- F2 ≤ 40 mm
- B ≥ 1300 mm = Length of element
- P ≥ 28 mm Depth of profile
- D ≥ 8 mm Expansion gap

Attention must be paid to the drainage of the bottom profile!

Panel thickness in mm		Height of railings* H = 900-1100 mm = maximum fastening spacing
6 mm	A	≤ 950 mm
8 mm	A	≤ 1150 mm

Table 2

\* THE HEIGHT OF THE RAILING MUST COMPLY WITH THE LOCAL BUILDING REGULATIONS. E.G. OIB DIRECTIVE 4 - USE AND ACCESSIBILITY. THE HEIGHT OF THE RAILING MUST BE AT LEAST 1000 mm; STARTING FROM A HEIGHT OF FALL WITH MORE THAN 12 m, MEASURED FROM THE BASE, MUST BE MINIMUM 110 cm.

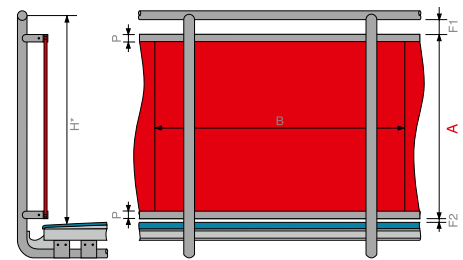

Fig. 5

# Fastening and Edge Spacing - Variants

**MAX EXTERIOR PERFORATED AND RIVETED. BALCONY RIVETED AS DESCRIBED ON PAGE 79.**



Fig. 1

Centre distances have to be built linear and squarebased (see page 85/Fig. 3).

$F1 \leq 120 \text{ mm}$

$F2 \leq 40 \text{ mm}$

Projecting ends E

- for 10 mm panels:  $20 \text{ mm} \leq E \leq 250 \text{ mm}$

Panel thickness in mm		Height of railing*
10 mm	A	$\leq 350 \text{ mm}$
	L	$\leq 840 \text{ mm}$

Table 1

\* THE HEIGHT OF THE RAILING MUST COMPLY WITH THE LOCAL BUILDING REGULATIONS. E.G. OIB DIRECTIVE 4 - USE AND ACCESSIBILITY. THE HEIGHT OF THE RAILING MUST BE AT LEAST 1000 mm; STARTING FROM A HEIGHT OF FALL WITH MORE THAN 12 m, MEASURED FROM THE BASE, MUST BE MINIMUM 110 cm.

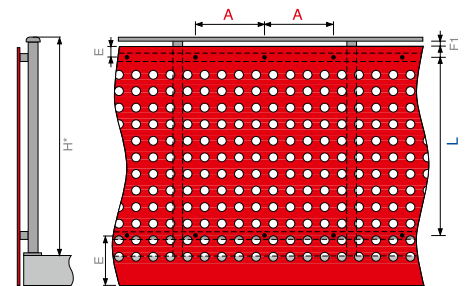

Fig. 2

**RECOMMENDED HOLE PATTERN**

D	Diameter of hole	$\leq 40 \text{ mm}$
G	Hole distance	30 mm
H	Centre distance	70 mm

Table 2

## Fundamentals of Breast-work Constructions

In buildings where, as a rule, children are expected to be present, these must be functional and prevent being climbed over. Designs that feature openings must adhere to local building regulations.

### AUSTRIA

**OIB RL 4.1.3/ÖNORM B5371 Point. 12**  
 Maximum horizontal opening size: 12 cm  
 Maximal vertical opening size: 2 cm

### GERMANY

**DIN 18065:**  
**2001-01/State Building Codes**  
 Maximum horizontal opening sizes  
 In constructions using bars: 12 cm  
 Maximal vertical opening size: 2 cm  
 Diagonal size in constructions using horizontal boards or bars, as well as in lattice constructions: 4 cm

### SWITZERLAND

**SIA-Standard 358/Specialist brochure of the bfu – Swiss Council for Accident Prevention**

In Risk Situation (GF) 1, the diameter of openings in the protective elements up to 75 cm in height may not exceed 12 cm. Climbing should be prevented or impeded by suitable measures such as:  
 Horizontal traverses (openings) should be 1–3 cm max. in size  
 Lattice-like patterns of holes: opening size of max. 4 cm  
 Round drilled holes: opening size of max. 5 cm

**When considering project-specific deviations, please consult with the relevant building authority.**

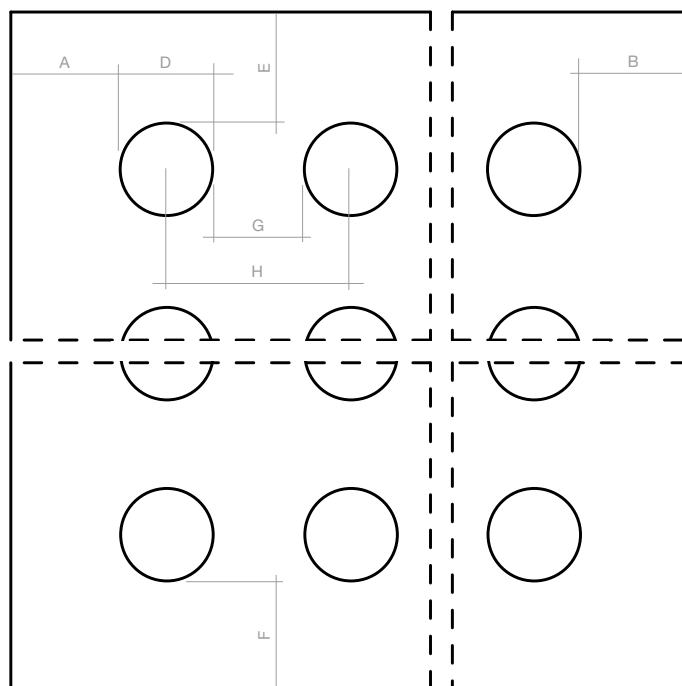

Fig. 3

- LEGEND**  
 A EDGE DISTANCE HORIZONTAL  
 B EDGE DISTANCE HORIZONTAL  
 D DIAMETER OF HOLE  
 E EDGE DISTANCE VERTICAL  
 F EDGE DISTANCE VERTICAL  
 G HOLE DISTANCE HORIZONTAL AND VERTICAL  
 H CENTRE DISTANCE HORIZONTAL AND VERTICAL

# Fastening and Edge Spacing - Variants

**MAX EXTERIOR PANELS PANELS WITH CLAMPING. SECTIONS FIXED (glass mounting brackets).**



Fig. 1

$F1 \leq 120 \text{ mm}$   
 $F2 \leq 40 \text{ mm}$   
 $20 \text{ mm} \leq E \leq 20 \times \text{Panel thickness}$   
 $G \geq 35 \text{ mm}$

At least 3 fastening points must be positioned per side. For each panel element a bracket with safety pin has to be used.

Panel thickness in mm		Height of railing* H = 900-1100 mm = maximum fastening spacing
8 mm	A	$\leq 450 \text{ mm}$
	L	$\leq 950 \text{ mm}$
10 mm	A	$\leq 500 \text{ mm}$
	L	$\leq 1100 \text{ mm}$
13 mm	A	$\leq 550 \text{ mm}$
	L	$\leq 1150 \text{ mm}$

Table 1

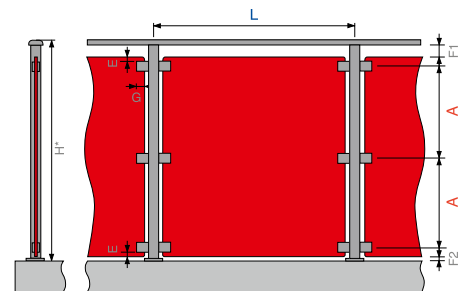

Fig. 2

\*THE HEIGHT OF THE RAILING MUST COMPLY WITH THE LOCAL BUILDING REGULATIONS. E.G. OIB DIRECTIVE 4 - USE AND ACCESSIBILITY. THE HEIGHT OF THE RAILING MUST BE AT LEAST 1000 mm; STARTING FROM A HEIGHT OF FALL WITH MORE THAN 12 m, MEASURED FROM THE BASE, MUST BE MINIMUM 110 cm.

# Fastening and Edge Spacing - Variants

**CURVED BALCONY WITH MAX EXTERIOR PANELS AND METAL EDGE STRIPS. DIMENSIONING ACCORDING TO STRUCTURAL ENGINEERING REQUIREMENTS.**



Fig. 3

The top and bottom edge profiles (2 mm thick) must be pre-bent. Only sliding line fastenings are allowed (no point fastenings). The straight ends and joints of the exterior panels must likewise be edged. (U-profile, H-profile).

**RADIUS AT LEAST 3 m**

- F1 ≤ 120 mm
- F2 ≤ 40 mm
- B ≥ 1300 mm = Length of element
- P ≥ 28 mm Depth of profile

Attention must be paid to the drainage of the bottom profile!

Panel thickness mm		Height of railing*
6 mm	A	H = 900-1100 mm = maximum fastening spacing ≤ 1000 mm

Table 2

\*THE HEIGHT OF THE RAILING MUST COMPLY WITH THE LOCAL BUILDING REGULATIONS. E.G. OIB DIRECTIVE 4 - USE AND ACCESSIBILITY. THE HEIGHT OF THE RAILING MUST BE AT LEAST 1000 mm; STARTING FROM A HEIGHT OF FALL WITH MORE THAN 12 m, MEASURED FROM THE BASE, MUST BE MINIMUM 110 cm.

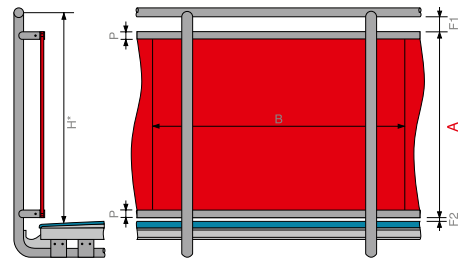

Fig. 4



Fig. 5

# Balcony partition wall

## GENERAL INFORMATION

Dividing walls made from Max Exterior F-quality panels are used to protect individual areas in long balcony-complexes or in access-balcony. The screens are standing vertically to the Building walls and are mounted in several ways like balcony claddings. The height is maximum from the top of the balcony floor to the ceiling of the next level. Like for the railing-subconstruction there is a difference between the fixing:

- Fixing on end-to-end profiles
- Fixing on brackets

The substructure made from hollow-profile has to be realized according to the structural analysis and to be fixed on the reinforced-concrete plates with

permitted dowels or with other mounting-parts. The profiles have to function as a statically line-bearing. The fixing of the Max Exterior F-quality panels has to be done with the same fastenings like on railing-panels. The screens have to be fixed with minimum 3 fastening points on each side.

$$F \geq 8 \text{ mm}$$

$$20 \text{ mm} \leq G \leq 30 \text{ mm}$$

Projecting ends E:  
 for 6 mm panels  $20 \text{ mm} \leq E \leq 120 \text{ mm}$   
 for 8 mm panels  $20 \text{ mm} \leq E \leq 200 \text{ mm}$   
 for 10 mm panels  $20 \text{ mm} \leq E \leq 250 \text{ mm}$

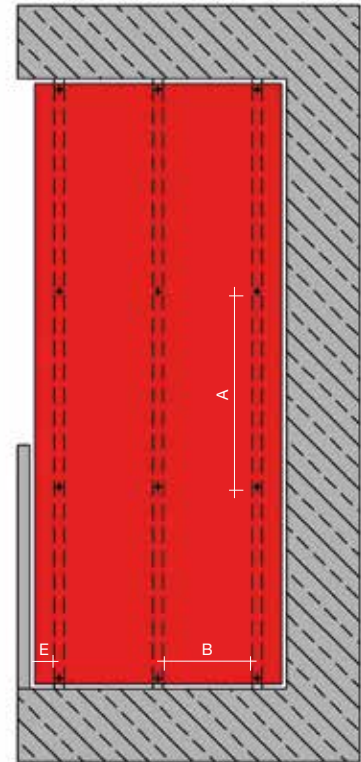

VARIANT 1

Fig. 1

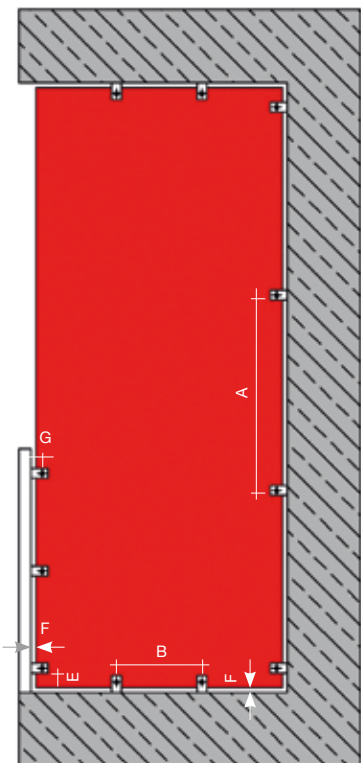

Table 2

VARIANT 2

Fig. 2

**TABLE FOR LOAD ON SINGLE SPAN/WIND LOAD\***  
 MAX EXTERIOR PANELS RIVETED ON ALUMINIUM SUBSTRUCTURE

PANEL THICKNESS	6 mm		8 mm		10 mm	
	LOAD q (kN/m <sup>2</sup> )	MAX B (mm)	MAX A (mm)	MAX B (mm)	MAX A (mm)	MAX B (mm)

GERMANY/AUSTRIA/SWITZERLAND

0.50	600	600	700	700	800	800
1.00	600	431	700	539	800	551
1.50	600	311	700	373	800	455
2.00	537	261	700	280	800	337

Values acc. to DIN 1055-T4 or DIN 18516 or ÖNORM B 4014-1,2 or EN 1991-1-4 or SIA-Norm 261 and permit Z 10.3-712

Table 1

**TABLE FOR LOAD ON DOUBLE SPAN/WIND LOAD\***  
 MAX EXTERIOR PANELS RIVETED ON ALUMINIUM SUBSTRUCTURE

PANEL THICKNESS	6 mm		8 mm		10 mm	
	LOAD q (kN/m <sup>2</sup> )	MAX B (mm)	MAX A (mm)	MAX B (mm)	MAX A (mm)	MAX A (mm)

GERMANY/AUSTRIA/SWITZERLAND

0.50	600	600	700	700	800	800
1.00	600	373	700	400	800	420
1.50	600	249	700	320	800	280
2.00	537	208	700	240	800	210

Values acc. to DIN 1055-T4 or DIN 18516 or ÖNORM B 4014-1,2 or EN 1991-1-4 or SIA-Norm 261 and permit Z 10.3-712

\* DIMENSION TABLES FOR THE WIND LOAD RANGE FROM 0.3 KN/M<sup>2</sup> TO 2.6 KN/M<sup>2</sup> ARE AVAILABLE UPON REQUEST FROM THE FUNDERMAX SUPPORT TEAM.





Fig. 3



Fig. 4



Fig. 5



Fig. 6



Fig. 7

# Max Exterior Balcony Floor Panel

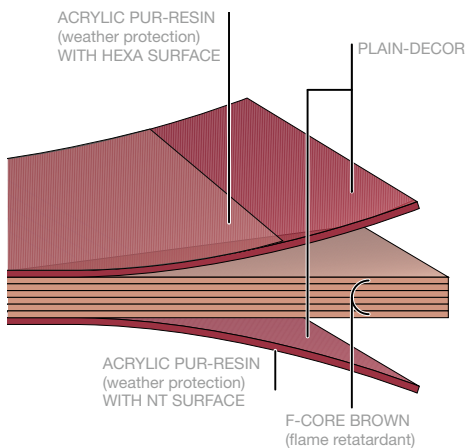

Fig. 1



Fig. 2

SURFACE HEXA



STRUCTURE OF BALCONY FLOOR PANEL

Fig. 3

## MATERIAL DESCRIPTION

The Max Exterior balcony floor panel is a high-quality construction product that is perfect for permanent use on balconies, loggias, staircases, landings and the like because of its anti-slip hexagon surface among other things.

Max Exterior panels are duromer high-pressure laminates (HPL) conforming to EN 438-6 Type EDF with additional, extremely effective, weather protection. This weather protection is made from double hardened Acrylic-Polyurethan-resins. They are produced in lamination presses at great pressure and high temperature Max Exterior panels carry the necessary CE label for applications in the construction sector.

## SURFACE

Front side: NH - Hexa  
Rear side: NT

## DECORS

two-sided; see our valid Max Exterior range of decors or at [www.fundermax.at](http://www.fundermax.at)

## ANTI-SLIP CLASS

R10 in accordance with DIN 51130

## FORMAT

on request or on our website - [www.fundermax.at](http://www.fundermax.at) - you may find the up-to-date information.

XL = 4100 x 1854 mm = 7.6 m<sup>2</sup>  
Tolerances +10 - 0 mm (EN 438-6, 5.3)

Panel formats are production formats. If exact dimensions and angles are necessary, we recommend an all-sided blank. Depending on the method of trimming, net size is reduced by ca. 10 mm.

## CORE

F-Quality, flame-retardant, colour brown

## THICKNESS

6.0 - 20.0 mm  
(depending on the static requirement)

Thicknesses	Tolerances (EN 438-6.5.3)
6.0 - 7.9 mm	±0.4 mm
8.0 - 11.9 mm	±0.5 mm
12.0 - 15.9 mm	±0.6 mm
16.0 - 20.0 mm	±0.7 mm

## NOTE

FOR HORIZONTAL USE ONLY.

**BASICS**

Max Exterior balcony floor panels can be screwed or glued to a variety of suitable substructures with an incline. During construction and installation it is important to ensure that the material is not subjected to accumulating moisture. This means that the panels must always be able to dry off. Generally, balconies should be provided with an incline of 1.5 - 2%. Due to the material properties of Max Exterior balcony floor panels, suitable room for expansion must be taken into account. The joints between panels must be at least 8 mm wide. For substructures that run parallel to joints, the gaps between the panels must always be placed above a substructure, and can additionally be held at the same height by suitable joints, such as tongue and groove joints for example, that allow the appropriate room for expansion. Elastic intermediate layers between the panel and the substructure, as well as between parts of the subconstruction, that allow a tolerance of greater than  $\pm 0.5$  mm are absolutely to be avoided. When installing Max Exterior balcony floor panels on a wooden

substructure with screws, fixed and sliding points must be formed. Pay attention to the advises on pages 52/53. The wood-substructure has to be constructed according to the national standard specifications (wood moisture  $15\% \pm 3$ ). **Pay attention to a qualified structural or chemical wood preservation!** Suitable rear-ventilation is to be ensured so that the panels can be conditioned on both sides. The panels should not be allowed to rest fully on the ground below. The substructure is to be protected against corrosion regardless of the material or system used.

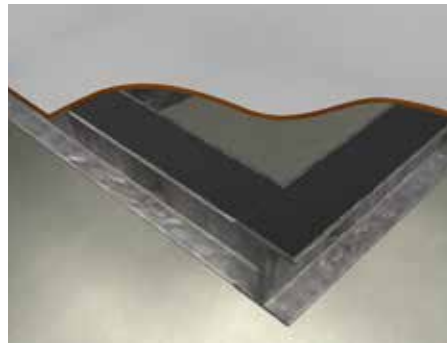
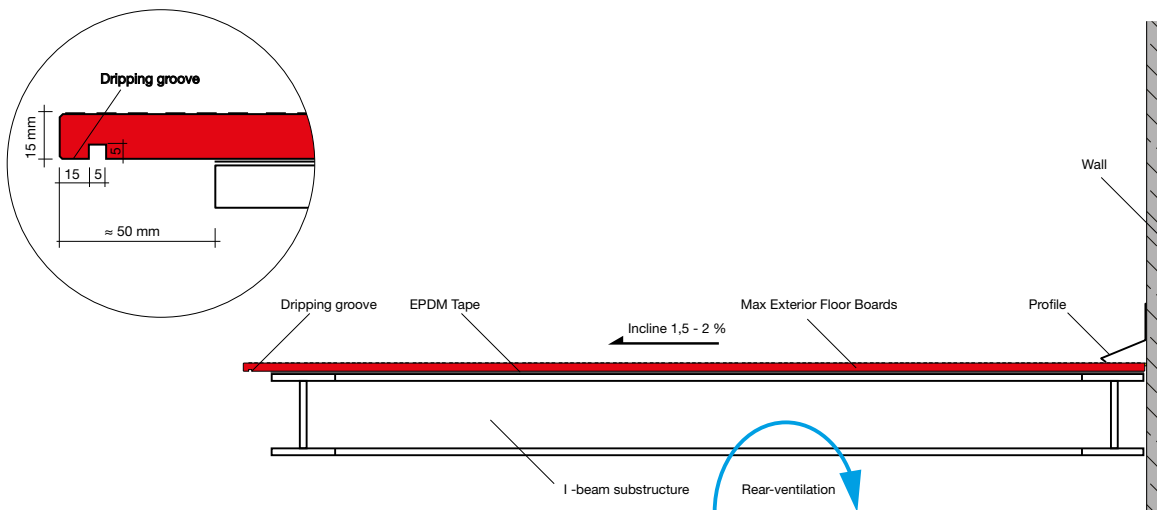

Fig. 4



VERTICAL SECTION: PRINCIPLE OF VENTILATION AND INCLINE

Fig. 5

# Guidelines for laying the floor panels

## FIXING DISTANCES

The substructure battens must have a width of  $\geq 60$  mm, in the joint area  $\geq 100$  mm.

## EDGE DISTANCES

For installation with screws, the edge distance can be 20 - 100 mm.

## PANEL JOINTS AND JOINT FORMATION

The joints must be at least 8 mm wide so that changes in size can take place without hindrance. The joints are filled with a permanently elastic sealant. A permanently elastic rubber band can also be placed in the groove (marked yellow in the drawings and 3D animation).

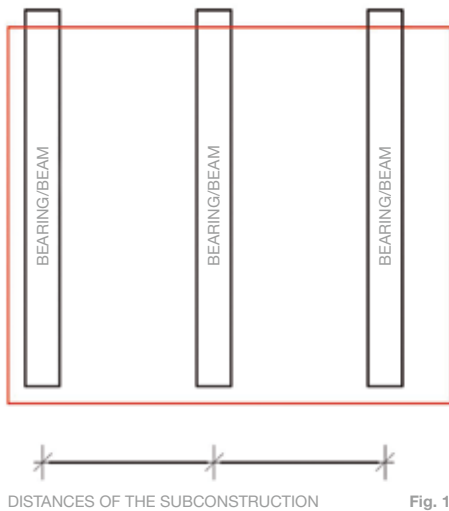

MAX. ALLOWABLE DEFLECTION OF 1/300	TRAFFIC LOAD kN/m <sup>2</sup>		
	3.0	4.0	5.0
<b>PANEL THICKNESS</b>	<b>SUPPORT SPACING IN mm</b>		
	A ≤ 500		
12 mm	X	-	-
16 mm	X	X	X
18 mm	X	X	X
20 mm	X	X	X
	A ≤ 600		
16 mm	X	X	-
18 mm	X	X	X
20 mm	X	X	X
	A ≤ 800		
20 mm	X	X	-

X = ALLOWABLE

Table 1



BALCONY FLOOR PANEL SITE IN ST. VEIT/GLAN, AUSTRIA

Fig. 2



SUBSTRUCTURE/BEAMS

Fig. 3



INCLINE AND PANEL JOINTS

Fig. 4



EXTERNAL CORNER AND EDGES

Fig. 5



INCLINE

Fig. 6

# Mounting of Max Exterior balcony floor panels mechanical non visible fixed

## FIXED POINT

Fixed points serve the uniform distribution (halving) of the swelling and shrinkage movements. The drill hole diameter of the Max Exterior panel has to be made approx. one flight depth lower than the screw diameter.

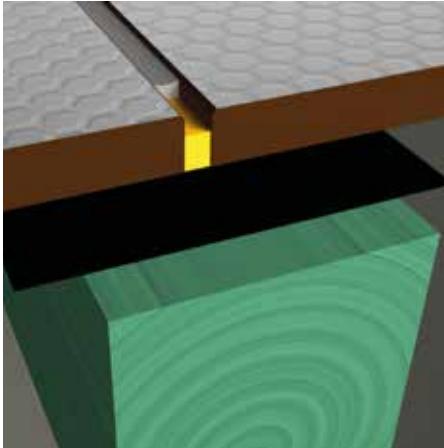
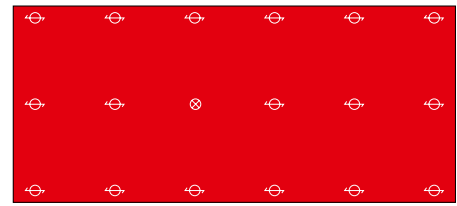

Fig. 1

## SLIDING POINT

Based on how much space is needed for expansion, the diameter of the drill hole in the substructure should be that much larger than the diameter of the fastening means. The diameter of the shank of the fastening means is set such that the panel can move. Screws must not be overtightened. Do not use counter sunk screws. The center of the drill hole in the substructure must coincide with the center of the drill hole in the Max Exterior panel. Suitable drilling aids (drilling equipment) should be used. The fastenings should be put in place starting from the middle of the panel outwards.



DOUBLE SPAN PANEL

Fig. 2

⊗ FIXED POINT

⊕ SLIDING POINT



SINGLE SPAN PANEL

Fig. 3

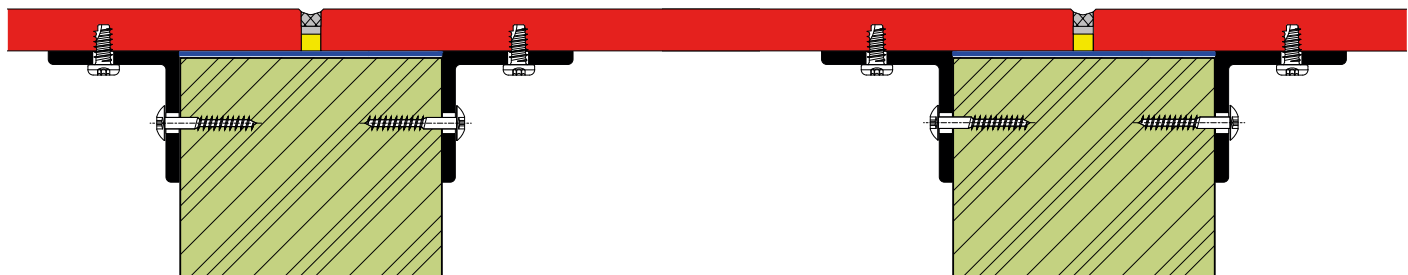

BALCONY FLOOR PANEL INVISIBLE FIXED (SCREWED) ON WOODEN BEAM

Fig. 4

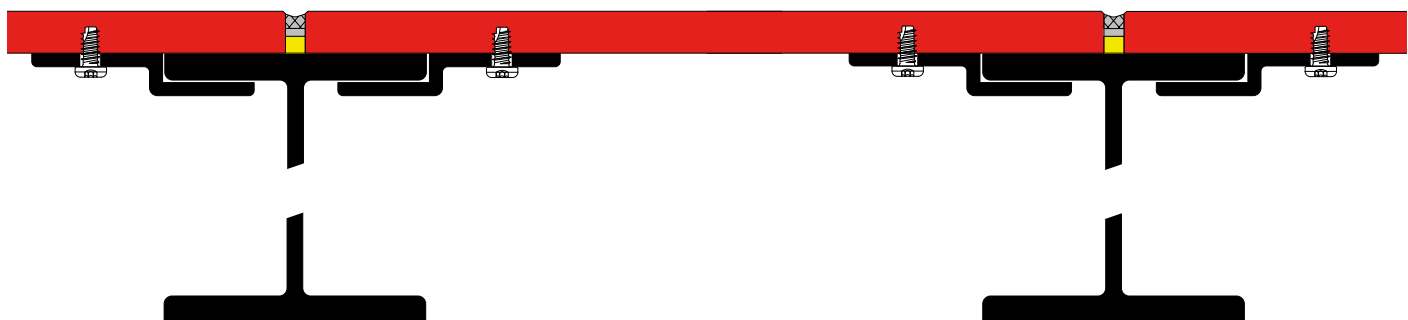

BALCONY FLOOR PANEL INVISIBLE FIXED (SCREWED) ON STEEL BEAM

Fig. 5

# Mounting of Max Exterior balcony floor panels with gluing system

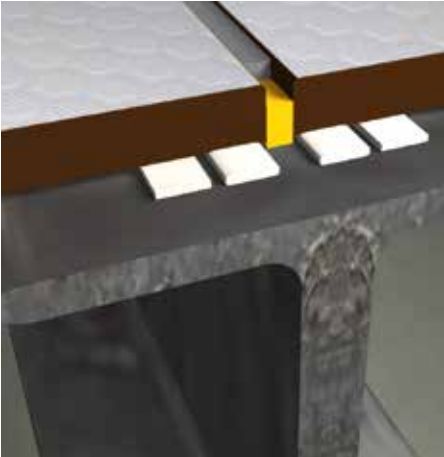

Fig. 6

**GLUING**

An alternative to mechanical fastening is gluing the Max Exterior balcony floor panel with the gluing system Propart or Innotec which were specially developed for this purpose. This works on conventional planed metal substructures.

**Note:**

Ensure that the Max Exterior (balcony floor-) panel is not subjected stress when gluing it into place. When installing the Max Exterior panel, be sure to take the expansion and shrinkage behavior into account.

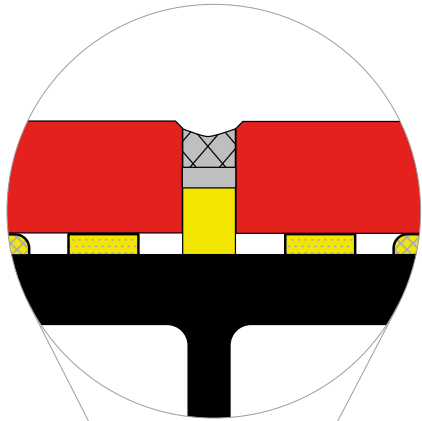

BALCONY FLOOR PANEL WITH SECRET FIXING (GLUED) ON STEEL BEAM

Fig. 7

## General information



Fig. 1

In order to meet the current architectural demands, trend-setting design variations allow the use of a product for both the facade as well as the roof. Design and planning for these constructions is to be carried out with the utmost care, particularly regarding the detail connections. Supporting structures in conjunction with decorative panel materials allow both the architect as well as the builders to provide the object with a special, independent character. By reducing the external shell to the essential optical fields, the gaze of the viewer is consciously directed by the shape and colour. Of course nearly all the advantages of the non-bearing, rear-ventilated facade can be applied to the roof: design, engineering, and cost-efficiency.

### CONSTRUCTION DESIGN

Max Exterior can be used for ventilated roof structures taking into account the following points: Minimum roof pitch 6°.

### VERIFICATION OF STABILITY

This must be determined for all applications in the facade and roof areas for each project and must be performed under consideration of the regional building regulations.

### WIND LOAD

Snow and wind loads are to be taken into account when determining the proper fasteners and spacing of the substructure.

For Austria:

Eurocode ÖNORM EN 1991-1-4

For Germany: DIN EN 1991-1-4

### VENTILATION

Ventilation between the subroof and the panel (height of the counter battens) depends on the rafter length and roof pitch.

### SUBROOF

The subroof must be designed and constructed as a seamless water transport layer for all roof pitches and structural variations. The drainage takes place in the substructure of the facade.

### SUBSTRUCTURE

Depending on the design, the construction consists of horizontal or vertical support profiles and counter battens sufficiently fixed mechanically to the counter battens. It is not allowed to use wood-substructures for roof-claddings.

### SUPPORT BATTENS (-profiles)

Vertical or horizontal metal support profiles serve as support battens; single profiles serve as middle supports, and in the joint areas double profiles are used which also serve a drainage function.



### COMPONENT CONNECTIONS

For example such as skylights, ventilation and exhaust pipes, etc. are to be made with the appropriate sheet metal flashing. Panel material - technical data: Product classification B-s2, d0 according to EN 13501-1

### PANEL INSTALLATION

The roof panels are fastened to the support profiles with stainless steel blind rivets. The fastening distances are to be determined for each object individually.

### FIXED POINT, SLIDING POINTS

The fastening of the Max Exterior panel to the support profiles requires sliding and fixed point installation.

### DRILL HOLES IN THE PANEL

The drill hole diameter for the fixed point has to be 5.1 mm, and for the sliding point 8.5 mm or as required. The rivets must be centered and put in place with a flexible mouthpiece.

### DRILL HOLES IN THE SUPPORT PROFILE

The drill holes in the support profile should be 5.1 mm in diameter and aligned with the drill holes in the panel.

### FIXING THE SUPPORT PROFILE

Depending on the design of the counter battens, the support profile is fixed in place with suitable screws or rivets.

### SOILING

Avoid soiling though:

- Construction measures
- Higher elevated roof surfaces
- separate drainage.



Fig. 2

# Construction-details roof with Max Exterior Panels

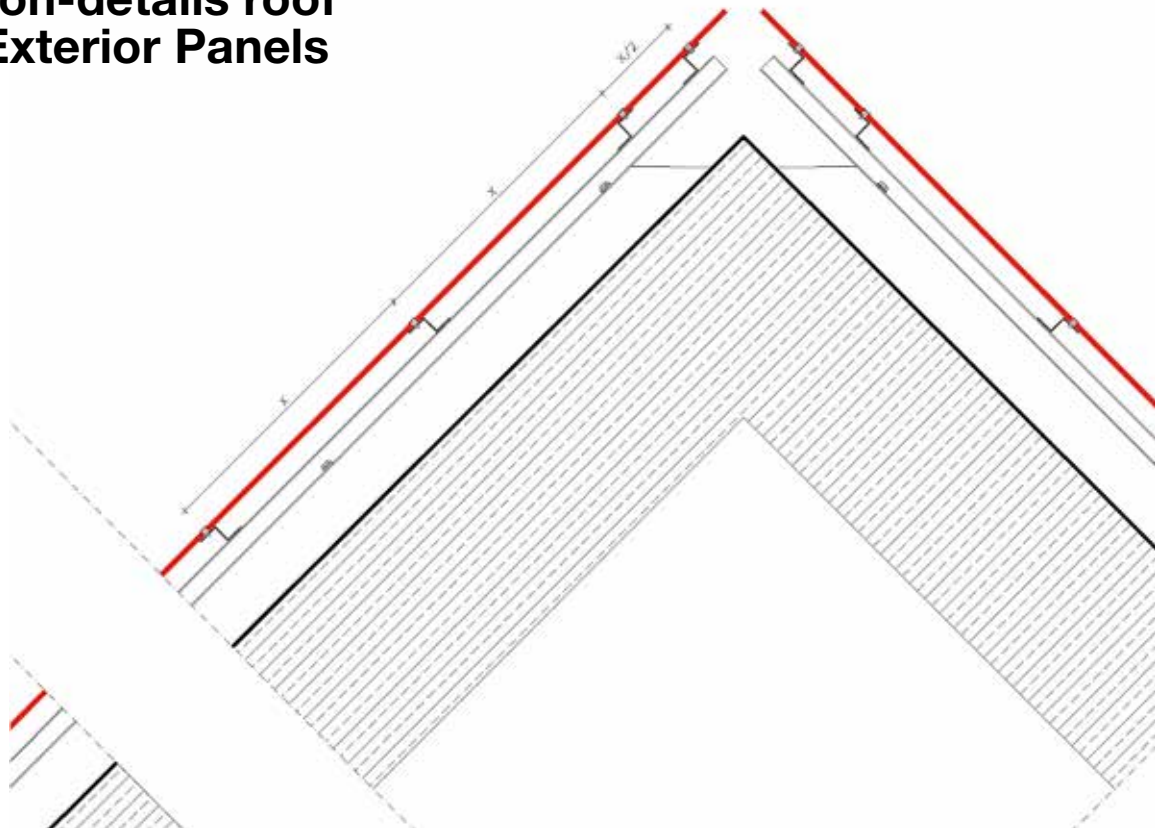

VERTICAL SECTION OF THE APEX OF THE ROOF-STRUCTURE

Fig. 1

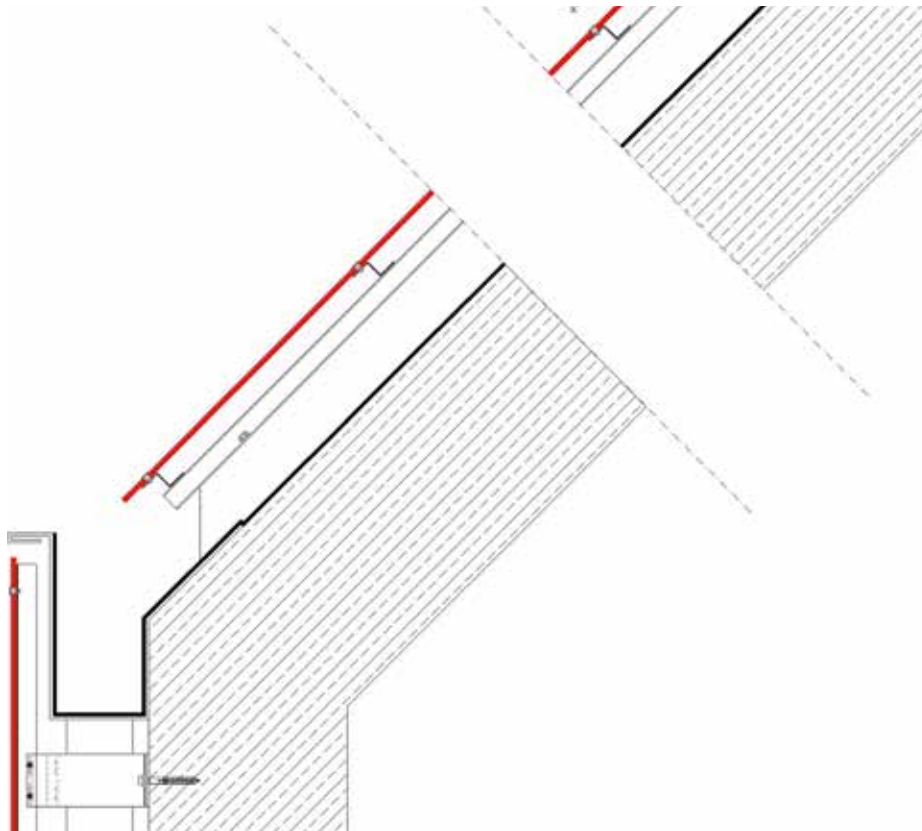

VERTICAL SECTION OF THE EAVE OF THE ROOF-STRUCTURE

Fig. 2



# Construction-details roof with Max Exterior Panels

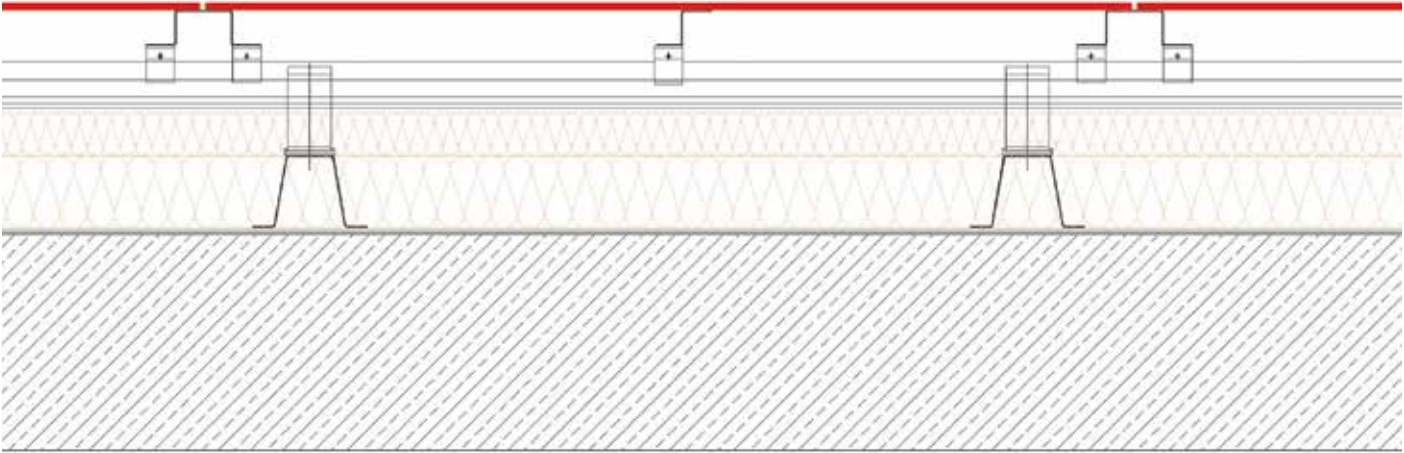

VERTICAL SECTION OF THE STRUCTURE OF THE ROOF

Fig. 3

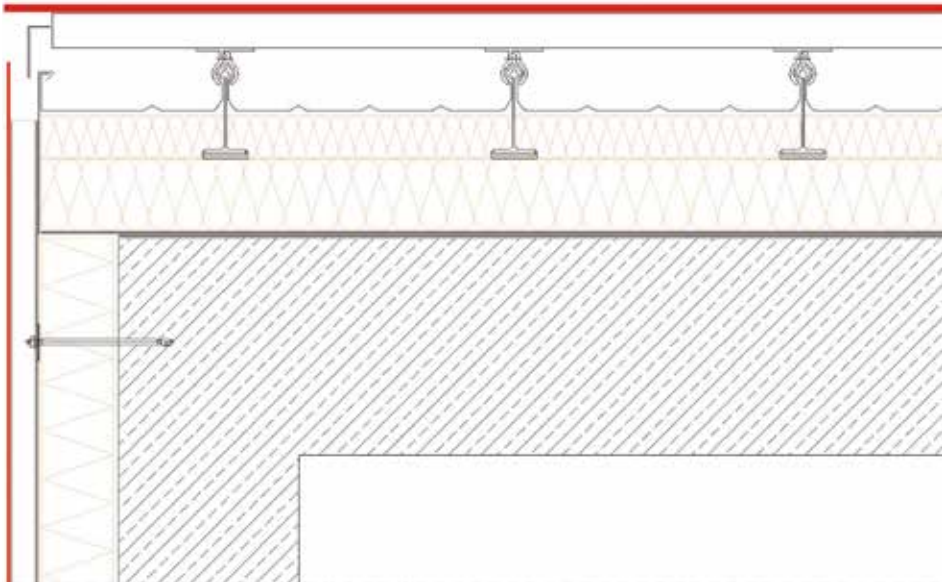

VERTICAL SECTION OF BARGEBOARD

Fig. 4



Fig. 1

MAX EXTERIOR		
PANEL THICKNESS IN mm	PANEL LENGTH IN mm	STRAIN L/300 IN mm
8	≤ 1000	3.0
10	≤ 1100	3.6
12	≤ 1200	3.6
15	≤ 1300	3.2

Table 1

**GENERAL POLICIES**

Max Exterior panels can be used external-ly for sun shade applications at a materials strength of 8 to 15 mm.

The following recommendations should be observed.

The minimum width of the element should not go under a limit of 100 mm. Every element should be secured on at least 2 sides with 2 fasteners per side. Edge distances of the fasteners >20 mm. Installation of the elements must occur in a stress-free manner using fixed and floating points.

The elements must be mounted to adjacent component parts using an expansion joint of >8 mm.

Ventilation of the elements must be guaranteed at all times. Full-surface overlays or adhesion is damaging to the material.

The most common application of Max Exterior panels as sun shades is the horizontal, mostly slightly angled assembly of elements in front of windows. The maximum number of fastener locations depends on the panel thickness, wind load and the fastener angle.

Suppliers of the following design possibilities you will find on page 107.

**MAX. FASTENER DISTANCES FOR SUN SHADES**

These fastener distances are valid for low wind loads. In case of greater wind loads, the fastener distances must be determined from the specific application and materials. In case the panels are framed or have edgewise or rearward metal profiles, the fastener distances specified below may be increased in accordance with the additional rigidity desired.

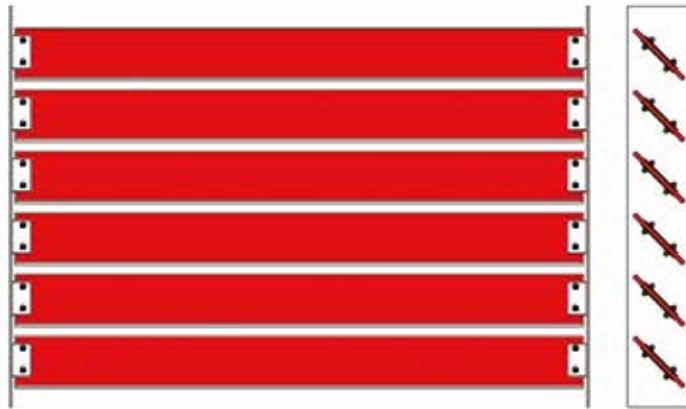

Fig. 2



Fig. 3



Fig. 4

# Sunblinds span width $\leq$ 1300 mm



Fig. 1

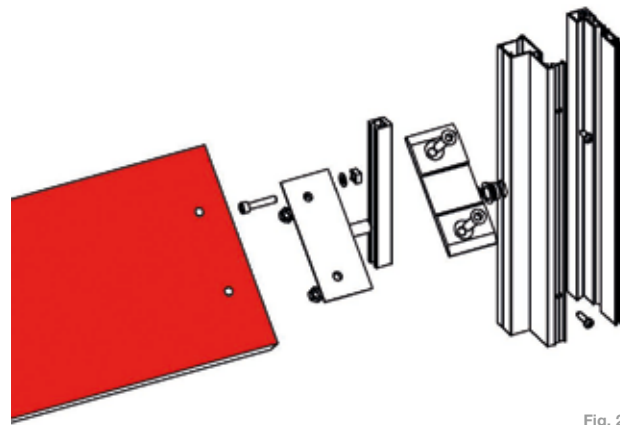

Fig. 2

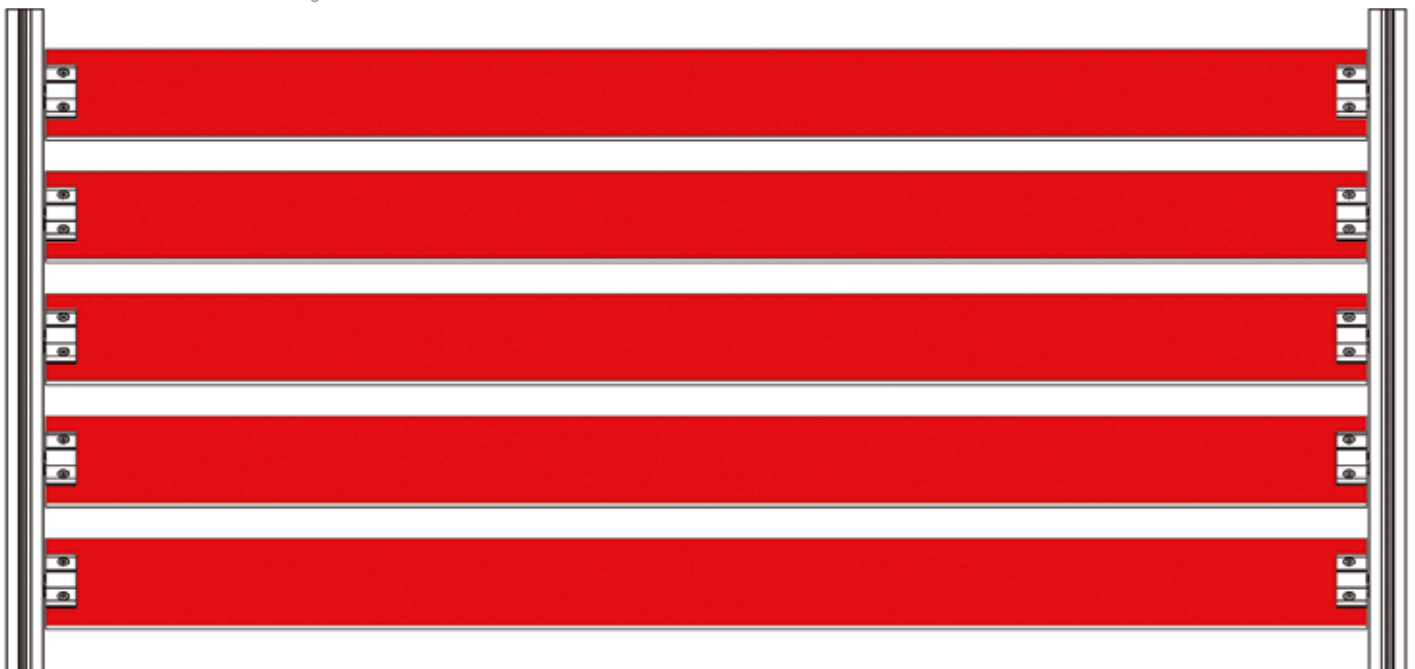

Fig. 3

# Supported sunblinds span width $\geq 1300$ mm

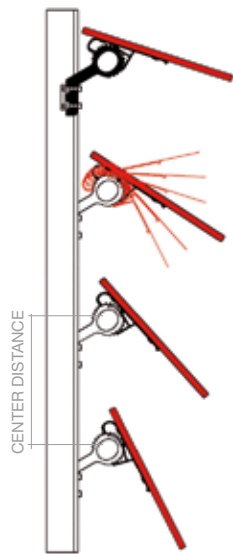

Fig. 4

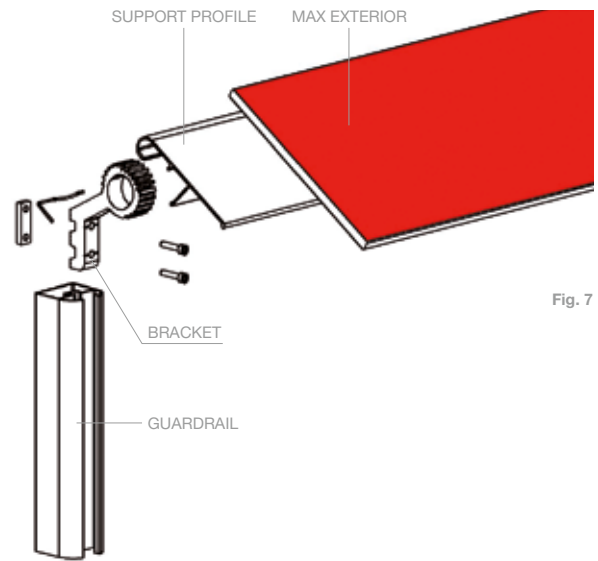

Fig. 7



Fig. 5



Fig. 6

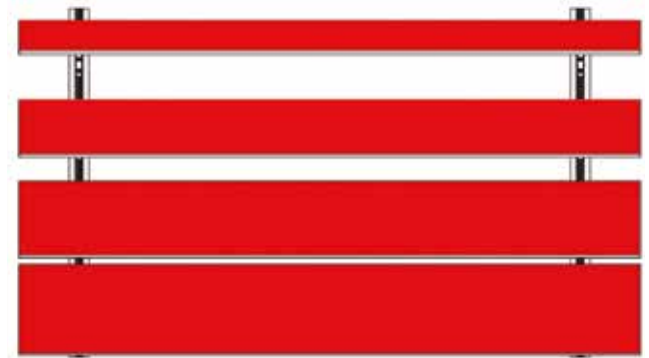

Fig. 8

## Mounting details

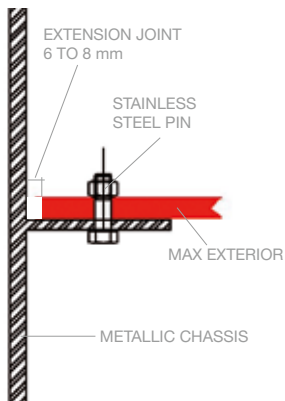

Fig. 9

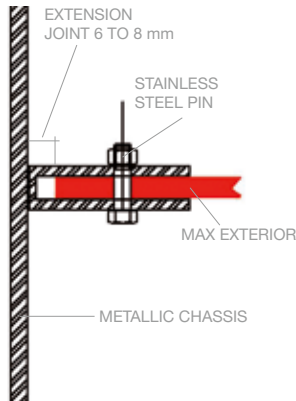

Fig. 10

## Window shutters



Fig. 1



Fig. 2

### FASTENING HINGE JOINTS

When fastening hinge joints, the Max Exterior panels should always be mounted on a metal frame. Using a minimum of three hinge joints per element is recommended. Aluminium profile systems or powder-coated steel frame profiles can be used as a metal frame, assuming the frame has sufficient load bearing capacity. The Max Exterior panel must be mounted with a sufficient tolerance of at least 4 mm per side. UV and weatherproof sealing bands (e.g., EPDM) are to be incorporated between the profile and the panel to avoid noise generated by the panel hitting the building facade. Using adhesives to fasten the Max Exterior panels is not permitted. To drain the frame, boreholing in the lower horizontal frame profile must be provided.

For **sliding elements**, the panels are likewise to be mounted on a metal frame. Mounting of the sliding elements occurs via rollers that must be mounted to the profile frame. The sliding metal fittings must have sufficient load bearing capacity. Please note the maximum fastening distances in the following tables.

#### MOUNTING IN A RACK. FASTENING SPACINGS.

MAX EXTERIOR		
PANEL THICKNESS IN mm	L = LENGTH IN mm	H = HEIGHT IN mm
6	≤ 500	≤ 500
8	≤ 600	≤ 600
10	≤ 600	≤ 600
12	≤ 600	≤ 600

Table 1



## Cleaning order for Max Exterior

### FIRST CLEANING STEP

Clean the surface just with pure hot water and use a soft sponge – (DO NOT use the abrasive „green“ side of the sponge), use a soft cloth or a soft brush (e.g. nylon brush).

### SECOND CLEANING STEP

If stains cannot be removed common household cleaners without abrasives e.g. dish detergent (Palmolive, Fairy), window cleaner (Ajax, Frosch) may be used. Subsequently do the final cleaning.

### THIRD CLEANING STEP

If the contamination is not removable, you can use a solution of soft soap - water (1:3). Depending on the degree of pollution leave it on the surface for a couple of minutes. Subsequently do the final cleaning.

### FOURTH CLEANING STEP

Same as cleaning step 1, but additionally you may use organic solvents (e.g. acetone, alcohol, turpentine, thinner). For persistent stains, try to clean mechanically Caution: Avoid scratching, use plastic or wooden spatula. Subsequently do the final cleaning.

### FIFTH CLEANING STEP

(for adhesives, varnish, sealants, silicone residues) Rub off the surface with a soft cloth or a soft sponge dry. If contaminants cannot be removed, use silicone remover (for example from Molto) or ask the adhesive manufacturer for the ideal cleaning agents.

**Caution:** Cured 2K adhesives, coatings, foams and ealing means **cannot** be removed.

### SIXTH CLEANING STEP

Same as cleaning step 1, but additionally liquid cleaner with polishing chalk (Cif, ATA) may be used. Do this procedure only occasionally! For persistent limescale acidic cleaning agents may be used (for example, 10% acetic acid or citric acid). Subsequently do the final cleaning.

### FINAL CLEANING

Remove all traces of detergent to avoid streaking. Finally, wash with pure water. Wipe the surface dry with an absorbent cloth or paper towel.

**When cleaning with solvent:** Observe the accident prevention regulations! Open windows! No open flame!



Fig. 3

**SUBCONSTRUCTION**

**Austria**

ALLFACE Befestigungstechnologie GmbH & Co KG  
Aredstraße 29/Büro 222,  
A-2544 Leobersdorf  
Tel.: +43 (0)2256/625 18  
Fax: +43 (0)2256/625 18 18  
E-mail: office@allface.com  
www.allface.com

Hilti EUROFOX GmbH  
Gewerbepark 10  
A-2810 Lanzenkirchen  
Tel.: +43 (0) 2627 42400-0  
Fax: +43 (0) 2627 42400-40  
www.eurofox.com

Slavonia Baubedarf GmbH  
Hauffgasse 3-5  
A-1110 Wien  
Tel: +43 (0) 1 / 769 69 29  
Fax: +43 (0)1 / 769 69 27  
www.slavonia.com

**Germany**

BWM  
Dübel und Montagetechnik GmbH  
Ernst-Mey-Str. 1  
D-70771 Leinfelden-Echterdingen  
Tel.: +49 (0) 711 / 90 313-0  
Fax: +49 (0) 711 / 90 313-20  
www.bwm.de

Systea DWS Pohl GmbH  
Margarete-Steiff-Str. 6  
D-24558 Henstedt-Ulzburg  
Tel.: +49 (0) 4193 / 99 11-40  
Fax: +49 4193 / 99 11-49  
www.pohlmet.com

NAUTH SL Fassadentechnik GmbH  
Weinstr. 68 b  
D-76887 Bad Bergzabern  
Tel.: +49(0) 6343 7003-0  
Fax: +49 (0) 6343 7003-20  
www.nauth.de

**France**

L.R ETANCO  
38/40 Rue des Cormiers – BP 21  
78401 CHATOU CEDEX (France)  
Phone: +.33.1.3480.5288  
Fax: +.33.1.3480.5240  
www.etanco.fr

**FASTENINGS  
(mechanical)**

**Austria**

EJOT AUSTRIA GmbH  
Grazer Vorstadt 146  
A-8570 Voitsberg  
phone +43 3142 2 76 00-0  
fax +43 3142 2 76 00-30  
E-mail: info@ejot.at, www.ejot.at

**Germany**

MBE GmbH  
Siemensstraße 1  
D-58706 Menden  
Tel.: +49 (0)2373 17430-0  
Fax: +49 (0)2373 17430-11  
www.mbe-gmbh.de

SFS intec GmbH, Division  
Construction  
In den Schwarzwiesen 2  
D-61440 Oberursel  
Tel.: +49 6171 7002-0  
Fax: +49 6171 7002-55  
www.sfsintec.de

Fischerwerke  
Arthur Fischer GmbH&CoKG  
Weinhalde 14-18  
D-72178 Waldachtal/Tuurlingen  
Tel.: +49 (0) 7443 120  
Fax: +49 (0) 7743 1242 22  
www.fischer.de

KEIL Werkzeugfabrik  
Karl Eischeid GmbH  
Postfach 1158  
D-51751 Engelskirchen-Loope  
Im Auel 42  
D-51766 Engelskirchen-Loope  
Tel.: +49 (0) 2263 8070  
Fax: +49 (0) 2263 807333  
www.keil-werkzeuge.com

**Switzerland**

SFS intec AG (Headquarters)  
Rosenbergsaustasse 10  
CH-9435 Heerbrugg  
Tel.: +41 71 727 62 62  
Fax: +41 71 727 53 07  
E-Mail:gmi.heerbrugg@sfsintec.biz  
www.sfsintec.biz

Koenig Verbindungstechnik AG  
Lagerstrasse 8  
CH-8953 Dietikon  
Tel.: +41 1 743 33 33  
Fax: +41 1 740 65 66  
www.kvt.ch

**FASTENINGS  
(glueing)**

**Austria**

Fassadenklebetechnik Klug GmbH  
Zentrale  
Julius-Tandler-Platz 6/15  
A-1090 Wien  
Tel.: +43 (0) 676 7271724  
E-mail:  
r.klug@fassadenklebetechnik.at  
office@fassadenklebetechnik.at  
www.fassadenklebetechnik.at

PROPART Handels GmbH  
Lauchenholz 28  
A-9123 St. Primus  
Tel.: +43 (0) 4239 40 300  
Fax: +43 (0) 4239 40 300-20  
www.fassaden-kleben.at

Innotec Industries Vertriebs GmbH  
Lofererstrasse 83  
A-6322 Kirchbichl  
Tel.: +43 (0) 53 32 70 800  
Fax: +43 (0) 53 32 70 8000-809  
E-mail: info@innotec.at  
www.fassadenverklebung.at

**Germany**

Walter Hallschmid GmbH&Co.KG  
Lehmhäuserstraße 20 D-94424  
Arnsdorf Tel.: +49 (0) 8723 / 96 120  
Fax: +49 (0) 8723 / 96 127  
www.hallschmid.eu

Innotec GmbH & Co. KG  
Kamper Strasse 54  
D-47445 Moers  
Tel.: +49 (0) 28 41-78670  
Fax: +49 (0) 28 41 -78680  
E-mail: verkauf@innotec-online.de  
Technische Fragen:  
support@innotec-online.de

MBE GmbH Siemensstraße 1  
D-58706 Menden  
Tel.: +49 (0) 2373 17430-0 Fax:  
+49 (0) 2373 17430-11  
www.mbe-gmbh.de

SIKA Deutschland GmbH  
Stuttgarter Straße 117  
D-72574 Bad Urach  
Tel.: +49 711 80090

**Switzerland**

SIKA Chemie GmbH  
Tüffenwies 16-22  
CH-8048 Zürich  
Tel.: +41 (0) 58 / 436 40 40  
Fax: +41 (0) 58 / 270 52 39

**Further suppliers of glues**

(There is no official certificate available for these suppliers of glues in Germany. You must clear technical certificates and processing recommendations with the supplier before mounting!)

DKS Technik GmbH  
Gnadenwald 90A  
A-6069 Gnadenwald  
Tel.: +43 (0) 5223 / 48 488-12  
Fax: +43 (0) 5223 / 48 488-50  
www.dks.at

SOUDAL N.V.  
Olof-Palme-Str. 13  
D-51371 Leverkusen  
Tel.: +49 (0) 214 / 6904-0  
Fax: +49 (0) 217 / 6904-23  
www.soudal.com

**PROFILES/ACCESSORIES**
**Austria**

Protektor Bauprofile GmbH  
Hosnedlgasse 12  
A-1220 Wien  
Tel.: +43 (0)1 259 45 00-0  
Fax: +43 (0)1 259 45 00-19  
www.protektor.com

**Germany**

Protektorwerk  
Florenz Maisch GmbH & Co.KG  
Viktoriastraße 58  
D-76571 Gaggenau  
Tel.: +49 (0)7225 977-0  
Fax: +49 (0)7225 977-111  
www.protektor.com

**France**

PROTEKTOR S.A. BATI-PROFIL  
Rue Pasteur Prolongée  
F-94400 Vitry sur Seine  
Tel.: +33 (0) 1 / 55 53 17 50  
Fax: +33 (0) 1 / 55 53 17 40

**GLASS MOUNTING BRACKETS**
**Austria**

Fa. Längle, A-6840 Götzis,  
www.langleglas.com

Fa. Schmidtschläger, A-1070 Wien,  
www.schmidtschlaeger.at

Fa. Hueck, A-1230 Wien,  
www.hueck.at

**Germany**

Fa. Pauli, D-51545 Waldbröl,  
www.pauli.de

Fa. SWS, D-51545 Waldbröl,  
www.sws-gmbh.de

Fa. QTEC, D-06749 Bitterfeld,  
www.qtec-gmbh.de

**SUNBLIND-ELEMENTS**
**France**

SAB International  
19 ZA Saint Mathieu  
F-28320 Gallardon  
Tel.: +33 (0)2 37 90 46 46  
Fax: +33 (0)2 37 90 20 10  
E-Mail: contact@sab-inter.com  
www.sab-inter.com

**EPDM BANDS**
**Austria**

SFS Intec GmbH  
Wiener Str. 29  
A-2100 Korneuburg  
Tel.: +43 (0)2262 90 500-0  
Fax: +43 (0)2262 90 500-930  
E-mail:  
at.korneuburg@sfsintec.biz  
www.sfsintec.at

Euphalt Handels-GesmbH  
Pummererstraße 17  
4020 Linz  
Tel.: +43 (0)732 77 31 68 0  
Fax: +43 (0)732 77 31 68 3939  
office@euphalt.at  
www.euphalt.at

**Germany**

MBE GmbH  
Siemensstraße 1  
D-58706 Menden  
Tel.: +49 (0)2373 17430-0  
Fax: +43 (0)2373 17430-11  
www.mbe-gmbh.de

SFS Intec GmbH  
In den Schwarzwiesen 2  
D-61440 Oberursel  
E-Mail:  
de.oberursel@sfsintec.biz  
www.sfsintec.de

**REPAIR-MARKERS (lacquer-pen)**
**Austria**

VOTTELER Lacktechnik GmbH  
Malvenstrasse 7  
A-4600 Wels  
Tel.: +43 (0)7242 / 759-0  
Fax: +43 (0)7242 / 759-113  
at.info@votteler.com  
www.votteler.com

**Germany**

Heinrich König & Co. KG  
An der Rosenhelle 5  
D-61138 Niederdorfelden  
Tel.: +49 (0)6101 / 53 60-0  
Fax: +49 (0)6101 / 53 60-11  
info@heinrich-koenig.de  
www.heinrich-koenig.de

MBE GmbH  
Siemensstrasse 1  
D-58706 Menden  
Tel.: +49 (0)2373 / 17430-0  
Fax: +49 (0)2373 / 17430-11  
www.mbe-gmbh.de

FunderMax assumes no liability for the products of the companies listed regarding the quality and suitability for specific applications.

## Exclusion of Liability

The information made available in this document are exclusively for purposes of general information. Not all of the systems mentioned and shown in this document are appropriate or suitable for all areas of application. All customers and third parties are obligated to inform themselves thoroughly about FunderMax products, including their suitability for certain purposes. We explicitly recommend that you and other users of this document seek out independent expert advice on adherence to local planning and use requirements, applicable laws, regulations, standards, guidelines and testing standards. FunderMax accepts no liability in connection with the use of this document.

**COPYRIGHT**

ALL TEXTS, PHOTOGRAPHS, GRAPHICS, AND AUDIO AND VIDEO FILES ARE PROTECTED BY COPYRIGHT LAW AS WELL AS BY FURTHER INTELLECTUAL PROPERTY LAWS AND MAY NOT BE DUPLICATED, ALTERED OR USED ON OTHER WEBSITES FOR PURPOSES OF BUSINESS, ETC.

FUNDERMAX FRANCE  
3 Cours Albert Thomas  
F-69003 Lyon  
Tel.: + 33 (0) 4 78 68 28 31  
Fax: + 33 (0) 4 78 85 18 56  
infofrance@fundermax.at  
www.fundermax.at

FUNDERMAX SPAIN  
Pol. Ind. Can Salvatella Avda. Salvatella, 85-97  
E-08210 Barberà del Vallès (Barcelona)  
Tel.: + 34 93 729 63 45  
Fax: + 34 93 729 63 46  
info.spain@fundermax.biz  
www.fundermax.es

FUNDERMAX INDIA PVT. LTD.  
1<sup>st</sup> floor, #13, 13<sup>th</sup> cross  
Wilson Garden  
IND-Bangalore 560 027  
Tel.: +91 80 4112 7053  
Fax: +91 80 4112 7053  
officeindia@fundermax.biz  
www.fundermax.at

FUNDERMAX POLSKA SP. Z O.O.  
ul. Rybitwy 12  
PL-30 722 Kraków  
Tel.: + 48-12-65 34 528  
Fax: + 48-12-65 70 545  
infopoland@fundermax.biz

FUNDERMAX SWISS AG  
Industriestrasse 38  
CH-5314 Kleindöttingen  
Tel.: + 41 (0) 56-268 83 11  
Fax: + 41 (0) 56-268 83 10  
infoswiss@fundermax.biz  
www.fundermax.ch

FUNDERMAX NORTH AMERICA, INC.  
2015 Ayrsley Town Blvd. Suite 202  
Charlotte, NC 28273, USA  
Tel.: +1 980 299 0035  
Fax: +1 704 280 8301  
office.america@fundermax.biz  
www.fundermax.at

## FunderMax GmbH

Klagenfurter Straße 87-89, A-9300 St. Veit/Glan  
T +43 (0) 5/9494-0, F +43 (0) 5/9494-4200  
office@fundermax.at, www.fundermax.at