



FUNDERMAX®

**SCALEO Façade System**  
**MODULO Façade System**

THE CLEVER MOUNTING SYSTEM FOR SUCCESS

USA/CAN EDITION — JULY 2018

**exterior**

for  
people  
who  
create

## Success Lies in the Right System

With the Modulo and Scaleo Rainscreen Cladding systems, FunderMax offers panels, mounting system and all the necessary accessories from a single source. Thus, you not only efficiently save time with your purchase and installation, you can also be confident that you will receive impact resistant, attractive, durable and UV resistant panels and accessories with proven FunderMax quality.



### Design Meets Tradition!

**MODULO** is a concealed fastening system that can easily be installed on wood or aluminum substructures. The unique system design and attractive décor possibilities lend themselves to new accents and visual interest in your facades.

**SCALEO** lap siding system components can be mounted onto wood or aluminum substructures. The unique system design, combined with the durable and attractive décor offerings, allows you to provide cost effective façades with “character” that will withstand the rigors of time and climate. The Scaleo System offers a variety of solutions for inside and outside corners as well.

### MAX EXTERIOR FACADE PANELS

Sensational decor designs with an enormous spectrum of styles, including rough urban, vibrant solid colours and the wild beauty of a broad range of natural materials.

#### EXCLUSION OF LIABILITY

THE INFORMATION MADE AVAILABLE IN THIS DOCUMENT ARE EXCLUSIVELY FOR PURPOSES OF GENERAL INFORMATION. NOT ALL OF THE SYSTEMS MENTIONED AND SHOWN IN THIS DOCUMENT ARE APPROPRIATE OR SUITABLE FOR ALL AREAS OF APPLICATION. ALL CUSTOMERS AND THIRD PARTIES ARE OBLIGATED TO INFORM THEMSELVES THOROUGHLY ABOUT FUNDERMAX PRODUCTS, INCLUDING THEIR SUITABILITY FOR CERTAIN PURPOSES. WE EXPLICITLY RECOMMEND THAT YOU AND OTHER USERS OF THIS DOCUMENT SEEK OUT INDEPENDENT EXPERT ADVICE ON ADHERENCE TO LOCAL PLANNING AND USE REQUIREMENTS, APPLICABLE LAWS, REGULATIONS, STANDARDS, GUIDELINES AND TESTING STANDARDS. FUNDERMAX ACCEPTS NO LIABILITY IN CONNECTION WITH THE USE OF THIS DOCUMENT.

THE PLANNER AND INSTALLATION TECHNICIAN BEAR SOLE RESPONSIBILITY FOR THE CORRECT AND PROPER INSTALLATION.









FUNDERMAX PRODUCTS ARE AVAILABLE FROM THE DISTRIBUTORS AND FABRICATORS LISTED ON THE FUNDERMAX WEBSITE AND THE INSTALLATION IS PERFORMED BY SPECIALIST COMPANIES. THE GENERAL SALES CONDITIONS OF FUNDERMAX GMBH IN THE CURRENT VERSION AVAILABLE ON OUR WEBSITE AT [WWW.FUNDERMAX.AT](http://WWW.FUNDERMAX.AT) SHALL APPLY FOR ALL OF OUR ORAL AS WELL AS WRITTEN STATEMENTS, OFFERS, SALES QUOTES, SALES, DELIVERIES AND/OR CONTRACTS AND ALL RELATED ACTIVITIES.

#### COPYRIGHT

ALL TEXTS, PHOTOGRAPHS, GRAPHICS, AND AUDIO AND VIDEO FILES ARE PROTECTED BY COPYRIGHT LAW AS WELL AS BY FURTHER INTELLECTUAL PROPERTY LAWS AND MAY NOT BE DUPLICATED, ALTERED OR USED ON OTHER WEBSITES FOR PURPOSES OF BUSINESS, ETC.

## What Max Exterior Can Do

Modulo and Scaleo are offered as cost effective “system solutions” that incorporate mounting clips, trims and panels, that are pre-fabricated to facilitate aesthetics and ease of installation. FunderMax Exterior Panels are the perfect choice for these two unique façade systems! The panels are duomer high-pressure laminates (HPL) designed for exterior applications. They are produced in accordance with EN436-6 Type EDF under high pressure and temperature. The front and back panel surfaces are protected with a double-hardened, acrylic polyurethane resin saturation process. This provides protection to weathering and superior UV resistance, even in the harshest of climates, making it the perfect solution for durable and aesthetically appealing façade cladding that will pass the test of time.

-   
 EXTREMELY WEATHER RESISTANT
-   
 OPTIMAL LIGHT-FASTNESS
-   
 DOUBLE HARDENED
-   
 SCRATCH RESISTANT
-   
 SOLVENT RESISTANT
-   
 EASY TO CLEAN
-   
 IMPACT RESISTANT
-   
 EASY TO INSTALL



**PROPERTIES\*:**

- Weather resistant to EN ISO 4892-2
- lightfast acc. to EN ISO 4892-3
- Double hardened
- Scratch resistant
- Solvent resistant
- Hail resistant
- Easy to clean (non porous)
- Impact resistant EN ISO 178
- Suitable for all exterior applications
- Decorative
- Self-supporting
- Bending resistant EN ISO 178
- Frost resistant -80°C to 180°C
- Heat resistant -80°C to 180°C
- Easy to machine and install

\*STANDARD- AND ACTUAL-VALUES YOU WILL FIND ON OUR WEBSITE [WWW.FUNDERMAX.AT](http://WWW.FUNDERMAX.AT).

## SCALEO: A Robust Façade System with a Perfect Look

### FUNDERMAX MAKES TRADITION EVEN BETTER

Pre-fabricated Max Exterior Panels for Scaleo Lap Siding make it easy to design and install robust and modern façades. With the engineered and easy to install mounting system, a façade of durable, UV resistant, and maintenance free Scaleo Lap Siding creates a beautiful and functional building exterior. The product characteristics make Scaleo Lap Siding a façade material with comprehensive protection. The double-hardened acrylic curing process provides a non-porous surface with tremendous abrasion resistance and UV stability. Scaleo Lap Siding is easy to clean and able to withstand the harshest of environmental conditions.

- Easy to mount (on wooden or aluminum substructure)
- Easy to clean
- Stock program for fast delivery
- Wide selection of Decors
- Lightfast and UV-resistant
- Weather resistant
- Hail resistant
- Scratch resistant
- Pre-fabricated panels
- Double hardened surface



DESIGN: ARCHITEKTURBÜRO FREI & WURZRÄINER ZT



DESIGN: SERAU ARCHITECTURE

**TECHNICAL PROPERTIES DATASHEET  
FUNDERMAX COMPACT EXTERIOR, F QUALITY, NT SURFACE 6MM SCALEO, ROUTED EDGE LAP SIDING SYSTEM**

PROPERTIES	TEST METHOD	STANDARD VALUE	
<b>MECHANICAL PROPERTIES</b>			
Panel Core		Standard Dark Brown Core, Finish on both sides	
Porosity		Non Porous surface and edges	
Antimicrobial Characteristics		FunderMax panels do not support microorganic growth	
Modulus of Elasticity	property tested according to ES 438.2	≥ 9000 N/mm <sup>2</sup>	≥ 1,305,340 psi
Tensile Strength	property tested according to ES 438.2	≥ 80 N/mm <sup>2</sup>	≥ 11,603 psi
Flexural Strength	property tested according to ES 438.2	≥ 90 N/mm <sup>2</sup>	≥ 13,053 psi
Density	Per EN ISO 1183-1	1.35 g/cm <sup>3</sup>	1 N/mm <sup>2</sup> = 1MPa
Surface Impact Resistance	Falling ball test per EN 438-2:21, (standard value ≤ 10mm)	≤ 10mm	
Scratch Resistance	Per EN 438-2:25	4-6 N	4 N = .9 lbf
Abrasion Resistance	1 U = 1 cycle of rotation, property as tested per ES 438.2	≥ 450 U	
Color Stability -Artificial Weathering/Lightfastness	Per EN ISO 4892-2, industry standard ≥ 3	Greyscale value 4-5	

PROPERTIES	TEST METHOD	STANDARD VALUE	
<b>FIRE BEHAVIOR</b>			
Burning Classification	As tested per ASTM E84	Class A rating	
FSI (Flame Spread Index)	As tested per ASTM E84	10	
SDI (Smoke Develop Index)	As tested per ASTM E84	95	

PROPERTIES	TEST METHOD	STANDARD VALUE	
Maximum Design Pressure with vertical battens (panel attachments) at 16" centers		188 psf	
Maximum Design Pressure with vertical battens (panel attachments) at 24" centers		73 psf	

PROPERTIES	TEST METHOD	STANDARD VALUE	
<b>MECHANICAL PROPERTIES</b>			
Thermal Conductivity		0.3 W/mK	
Water Vapor Diffusion Resistance		ca. 17.200 μ	
Dimensional Changes during climatic	Dimensional Stability per EN 438-2:17	I %	0.1
Changes, measured at elevated temperatures		Q %	0.25
Dimensional Tolerance of Nominal Sizes		(+ 10 mm / - 0 mm)	
Dimensional Tolerance of Thicknesses		≤ 12 mm	+/- .5 mm
Resistance to Chemicals	FunderMax panels are highly resistant to many chemicals, complete list available on request		
Ease of maintenance/Cleaning	FunderMax panels resist dirt, easily cleaned with common agents, complete list available		

**USA: For IBC Construction Type I-IV buildings the FUNDERMAX 6 MM LAP SIDING SYSTEM IS FOR INSTALLED HEIGHTS BELOW 40' ONLY. For Canadian applications please contact your local sales representative or [www.fundermax.at](http://www.fundermax.at)**

**NOTE**  
VALUES ARE AVERAGE VALUES.

# System SCALEO

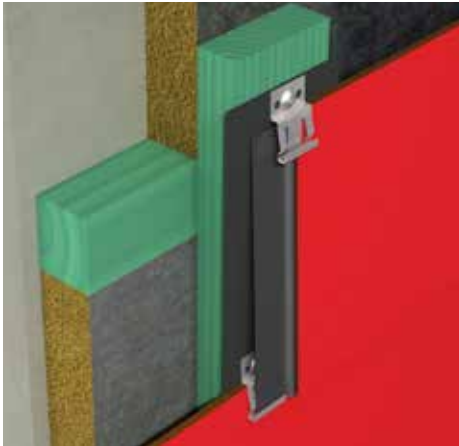

### ACCESSORIES AVAILABLE

- Mounting clips and instructions
- Vertical backing profile
- Inside and outside corner profiles

### ADVANTAGES OF SCALEO LAP SIDING

- Proven quality
- Abrasion resistant
- Impact and hail resistant
- Double-sided, balanced panels
- Weather resistant
- UV stable
- Ease of machining
- Ease of installation
- Minimal maintenance
- Ease of cleaning (non porous)
- Wide range of decors
- Quick ship program

**NOTE**  
STANDARD PANEL SIZE FOR EASE OF INSTALLATION: 110" x 9.84"  
CUSTOM HEIGHTS BETWEEN 6" AND 12"  
AVAILABLE UPON REQUEST

Scaleo provides an attractive system with prefabricated Max Exterior panels for lap siding. Our system is easy to design and use, and provides a robust and modern façade. Scaleo offers an ideal combination of ease of installation with the proven characteristics of Max Exterior façade panels.

**Note:** Information about building regulation permits can be found at our website [www.fundermax.at/en/downloads/technical-approvals/compact.html](http://www.fundermax.at/en/downloads/technical-approvals/compact.html)

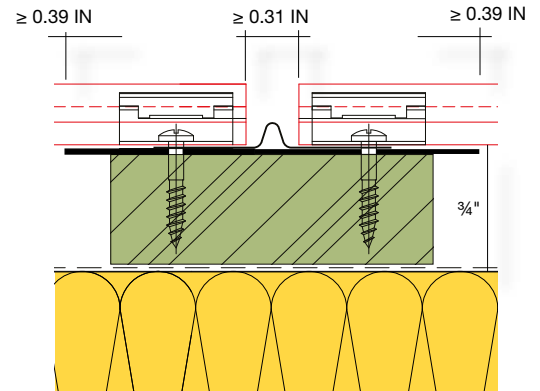

VERTICAL BACKING PROFILE

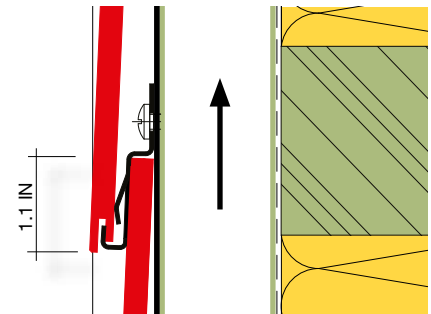

OVERLAP DIMENSION LAP-SIDING ELEMENTS

### INFORMATION SCALEO PANEL

Format	110.24 x 9.84 in
Surface coverage	8.74 in
Minimum order quantity = 1 package = 5 panels (or a multiple)	37.67 sf
Panel thickness	0.24 in
Surface coverage / package	33.37 sf
Surface coverage / panel	6.67 sf

### SCALEO ACCESSORIES

Mounting clips (approx. 10-12 clips/10 sf)	100 clips/unit
Vertical backing profile length = 9.69 in	10 pcs/unit
Vertical backing profile length = 98.43 in	20 pcs/unit

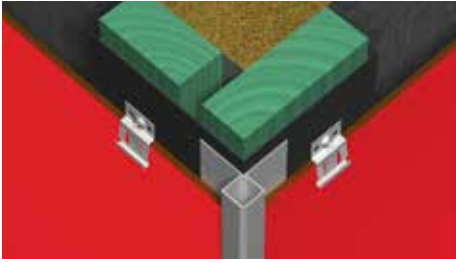

EXTERNAL CORNER WITH SQUARE PROFILE

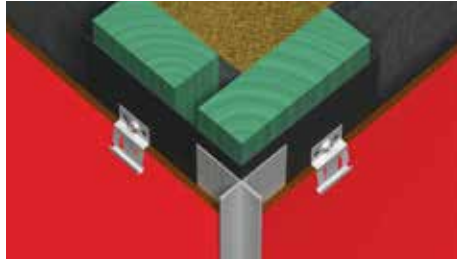

EXTERNAL CORNER WITH CROSS PROFILE

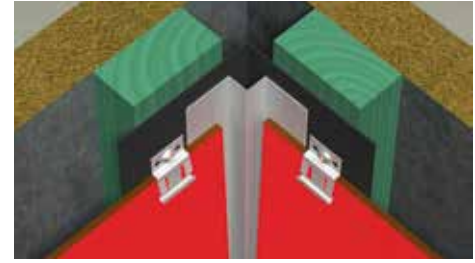

INTERNAL CORNER PROFILE

## Mounting instructions



### 1. PREPARING THE SUBSTRUCTURE

Max Exterior Scaleo elements are installed using mounting clips fixed to a substructure of vertical wooden battens, which are shaped and pre-dried (wood moisture 15%±3). Each batten must be at least 1.97 inch wide for a single mounting clip, or 2.95 inch wide where two panels join to allow enough space for two mounting clips side-by-side. **Pay attention to constructive or chemical treated wood preservation!** The gap between each batten should not exceed 24 inches. The Scaleo panels are installed starting from the bottom. First of all, use a piece of 6 mm Compact Exterior as a shim. Now fit the first row of mounting clips so they rest on the bar. Make sure you fit 2 mounting clips at each vertical joint between panels. Alternatively you can use an aluminum substructure. Length of the aluminum profile is maximum 110.24 inch. Width of the profile with one mounting clip 1.57 inch and in case of joints (2 clips) minimum 3.15 inch. For fixing against shifting we recommend one self-tapping screw with fillister head per panel (screwed in the middle).



### 2. INSTALLING THE FIRST ROW OF PANELS

Place the groove along the lower edge of the Max Exterior Scaleo elements (the notch points downwards) onto the mounting clips. Secure the panels in place by fixing mounting clips along the top edge of each panel. The panel above overlaps the first row of panels by approx. 1.1 inch. Fit a screw next to the top middle mounting clip on each panel. This is designed to stop the panel shifting sideways.



### 3. VERTICAL JOINT

A batten for fixing the mounting clips must be located at each vertical joint. Two mounting clips, one either side of the joint, are needed to provide the necessary hold. Please use Max Exterior backing strips to seal the vertical joint between cladding panels. If siding elements are arranged so the vertical joints are offset then it is sufficient to install the panel plus joint profile using a single mounting clip. If vertical joints are in a line then two mounting clips need to be used. There must be a gap of at least 0.31 inch between the panels at the joint.



### 4. OUTSIDE CORNERS/INSIDE CORNERS WITH MITRE

Max Exterior Scaleo elements can be mitred for both outside and inside corners.

**Outside corners:** The top edge of the panel must be 0.47 inch shorter than the lower edge of the panel (regardless of the panel width).

**Inside corners:** The lower edge of the Scaleo panel must be 0.47 inch shorter than the top edge of the panel (regardless of the panel width). The mitred edges must have a chamfer. The substructure needs to be protected with an EPDM protective tape (min. thickness 0.05 inch) to prevent water entering.

**Corner profiles:** Elements can be installed on both outside and inside corners using a variety of shapes of corner profiles. In this case the panels are cut to size without a mitre. Make sure there is a gap of at least 0.2 inch between each panel and the corner profile.

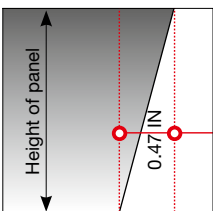

### 5. INSTALLING THE TOP ROW OF PANELS

Secure the top row of panels by fitting screws along the top edge of each panel. Use screws with painted heads to match the colour of the panels, as used for the installation of full-sized Max Exterior cladding boards.



# Construction-details horizontal sections SCALEO Façade System on wooden substructure

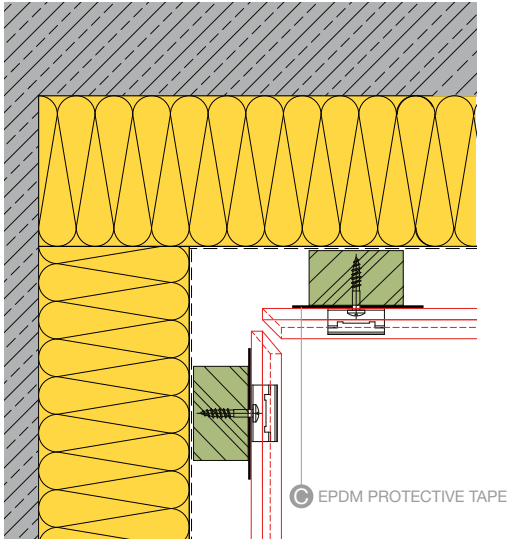

INTERNAL CORNER A106

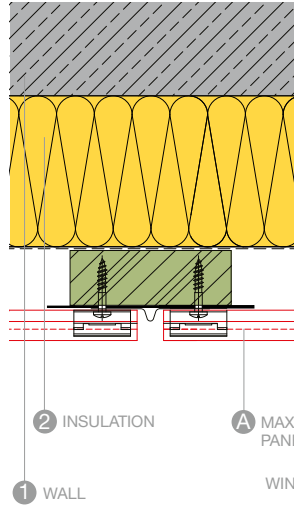

VERTICAL JOINT A107

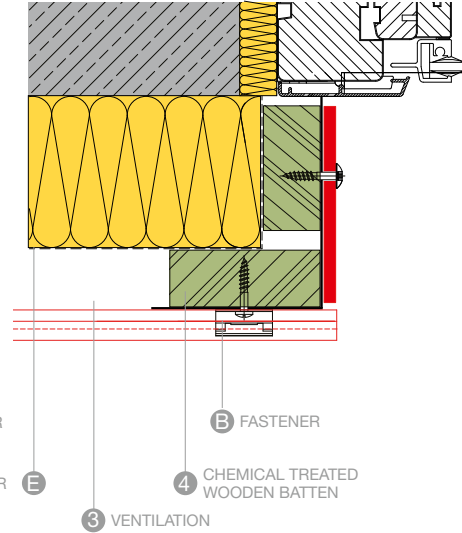

WINDOW REVEAL A104

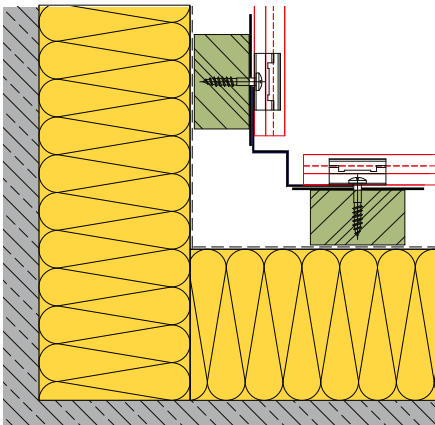

INTERNAL CORNER A106 WITH PROFILE

**NOTE**

MINIMUM 1.2 MM THICK EPDM TAPE IS RECOMMENDED ON ALL WOOD SUBSTRUCTURE, RETURNING BACK 3/8" ON BOTH SIDES.  
ALL SHOWN PROFILES AND FASTENINGS (EXCEPT THE ACCESSORIES MENTIONED ON PAGE 8) ARE PLANNING-SUGGESTIONS AND NOT PART OF THE FUNDERMAX DELIVERY PROGRAMME.  
ALL DRAWINGS IN THIS BROCHURE ARE NOT TRUE TO SCALE.  
CAD-DETAILS ARE AVAILABLE IN THE DOWNLOAD SECTION OF THE FUNDERMAX WEBSITE: [WWW.FUNDERMAX.AT/DOWNLOADS/](http://WWW.FUNDERMAX.AT/DOWNLOADS/)

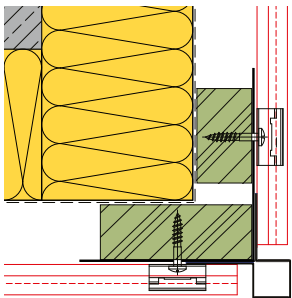

EXTERNAL CORNER A105 WITH SQUARE PROFILE

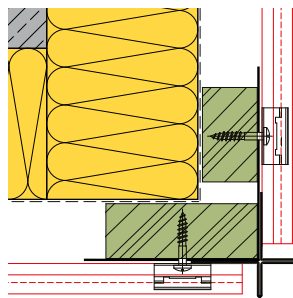

EXTERNAL CORNER A105 WITH CROSS PROFILE

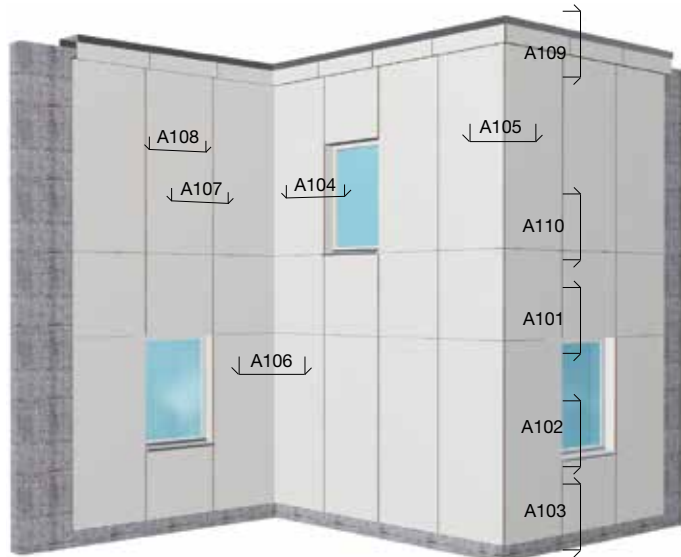



# Construction-details vertical sections SCALEO Façade System on wooden substructure

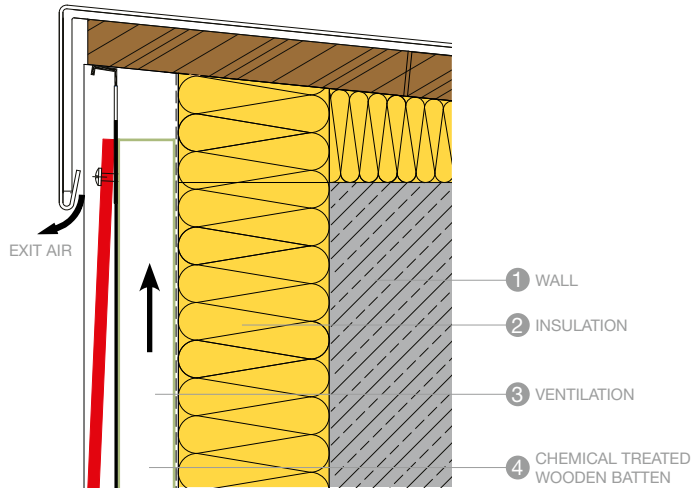

ATTIC CONNECTION A109

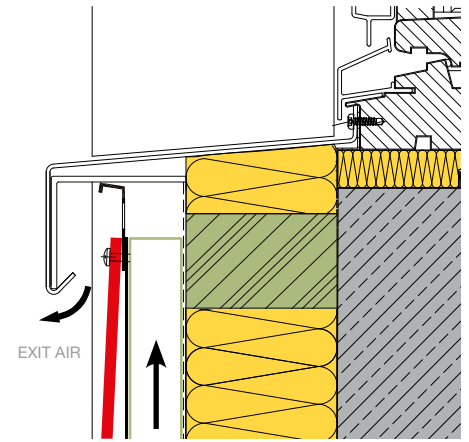

WINDOW SILL CONNECTION A102

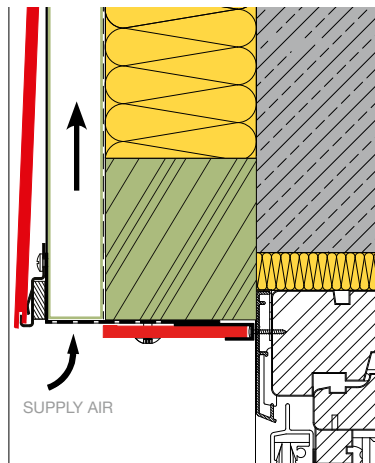

WINDOW LINTEL A101

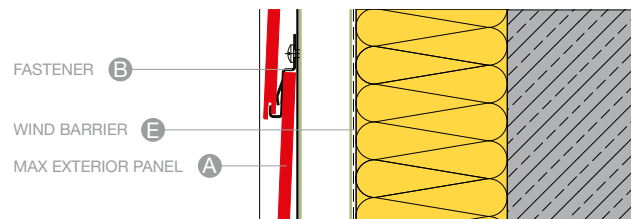

HORIZONTAL JOINT A110

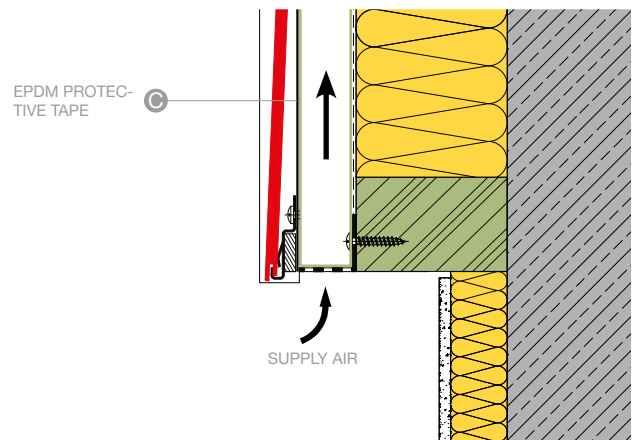

BASE CONNECTION A103

# Construction-details horizontal sections SCALEO Façade System on aluminum substructure

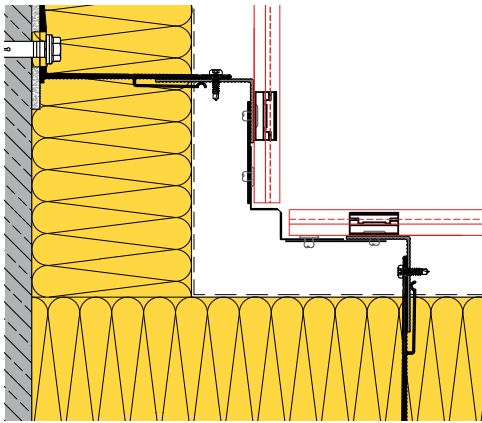
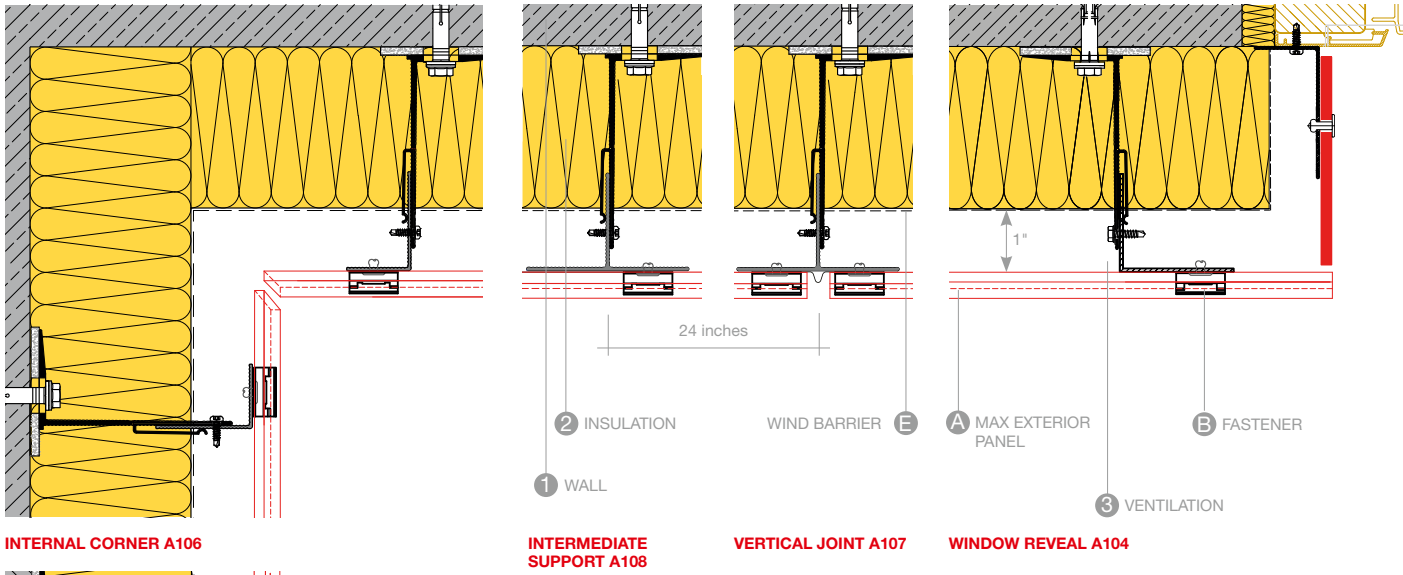

**INTERNAL CORNER A106 WITH PROFILE**

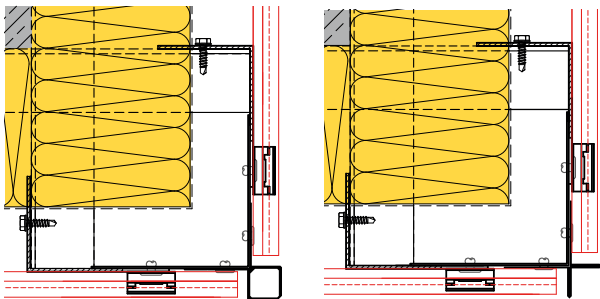

**EXTERNAL CORNER A105 WITH SQUARE PROFILE**

**EXTERNAL CORNER A105 WITH CROSS PROFILE**

**NOTE**

ALL SHOWN PROFILES AND FASTENINGS (EXCEPT THE ACCESSORIES MENTIONED ON PAGE 8) ARE PLANNING-SUGGESTIONS AND NOT PART OF THE FUNDERMAX DELIVERY PROGRAMME.  
ALL DRAWINGS IN THIS BROCHURE ARE NOT TRUE TO SCALE.  
CAD-DETAILS ARE AVAILABLE IN THE DOWNLOAD SECTION OF THE FUNDERMAX WEBSITE: [WWW.FUNDERMAX.AT/DOWNLOADS/](http://WWW.FUNDERMAX.AT/DOWNLOADS/)

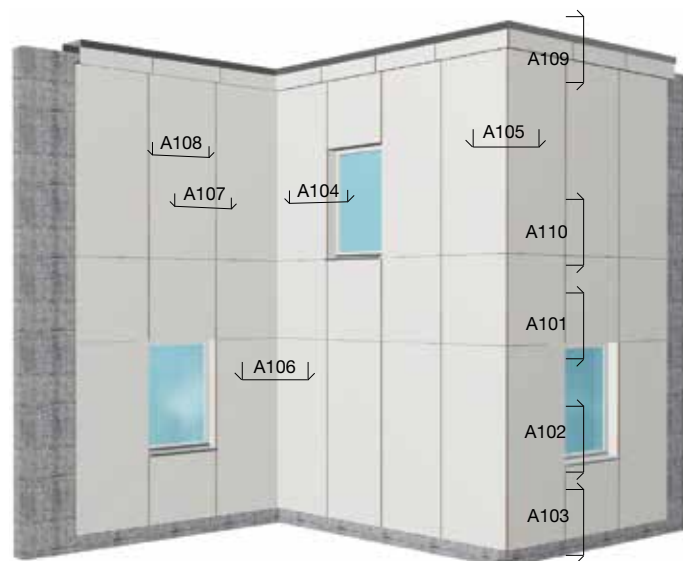

# Construction-details vertical sections SCALEO Façade System on aluminum substructure

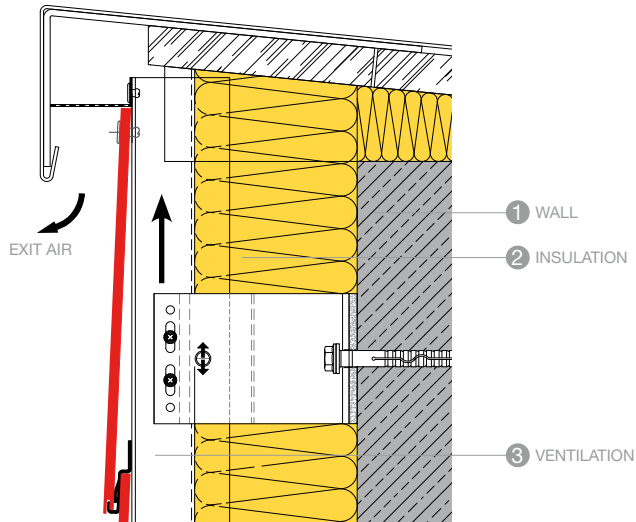

ATTIC CONNECTION A109 / HORIZONTAL JOINT A110

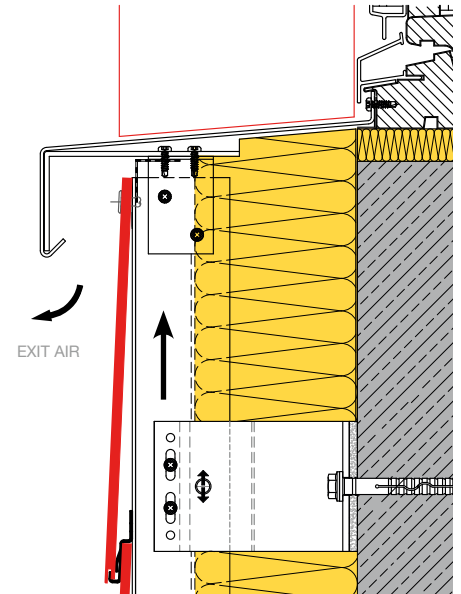

WINDOW SILL CONNECTION A102

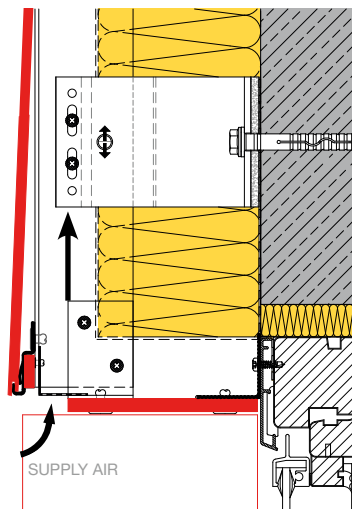

WINDOW LINTEL A101

WIND BARRIER E

MAX EXTERIOR PANEL A

FASTENER B

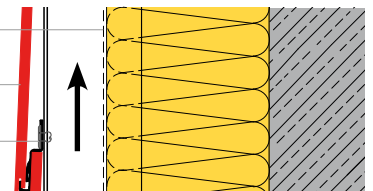

HORIZONTAL JOINT A110

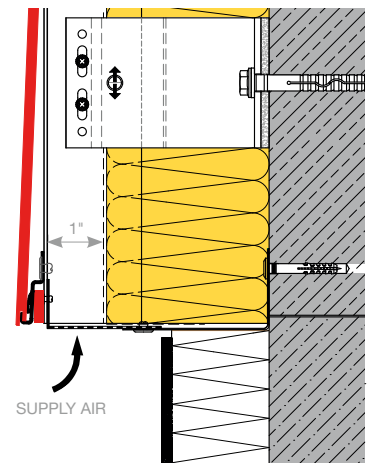

BASE CONNECTION A103

## MODULO: The concealed fastener, closed joint modern façade system from FunderMax



### ADVANTAGES OF MODULO

- NFPA285 Compliant
- Concealed fastening
- Closed joints
- Proven quality
- Abrasion resistant
- Impact and hail resistant
- Double-sided, balanced panels
- Weather resistant
- UV stable
- Ease of machining
- Ease of installation
- Minimal maintenance
- Ease of cleaning (non porous)
- Wide range of decors
- Quick ship program

### MODULO FAÇADE SYSTEM

This modern façade fastening system with high design décor offerings makes it possible to install pre-fabricated panels on a concealed clip system without any open joints vertically or horizontally. The panels can be installed in a stacked bond, running bond or a hybrid of both to create a façade with inspired visual interest. The substructure can be wood or aluminum, and can accommodate exterior insulation.

**Note:** Information about building regulation permits can be found at our website [www.fundermax.at/en/downloads/technical-approvals/compact.html](http://www.fundermax.at/en/downloads/technical-approvals/compact.html)

### NOTE

STANDARD PANEL SIZES FOR EASE OF INSTALLATION: 2'X2' AND 2'X4'  
CUSTOM PANEL HEIGHTS BETWEEN 6" AND 24" AVAILABLE UPON REQUEST



DESIGN: BARILLOT ARCHITECTURE



**INFORMATION MODULO PANEL**

**MODULO 2X2**

Format	24 x 24 in
Surface Coverage not including joint	23,92 x 23,92 in
Minimum order quantity = 1 package = 6 panels (or a multiple)	24 sf
Panel thickness	0.31 in
Surface coverage / package	23,82 sf
Surface coverage / panel	3,97 sf

**MODULO 2X4**

Format	48 x 24 in
Surface Coverage not including joint	47,92 x 23,92 in
Minimum order quantity = 1 package = 6 panels (or a multiple)	48 sf
Panel thickness	0.31 in
Surface coverage / package	47,7 sf
Surface coverage / panel	7,95 sf

**PHYSICAL DATA/PROPERTIES**

Artificial weathering EN ISO 4892-2	4-5
Fire Testing Data	Class A Rated per ASTM E84 See page 27 for more info

**MODULO ACCESSORIES**

Mounting bracket (every 16" OC)	100 pcs/unit
Mounting track (L=118.11 in)	10 pcs/unit

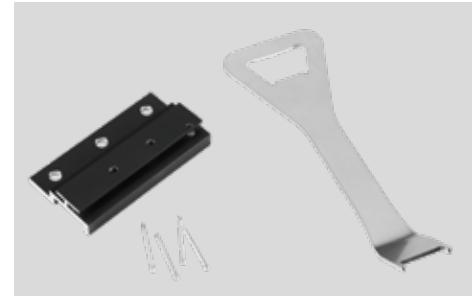

ACCESSORIES: FASTENER; LOCKING PIN; ASSEMBLY AID

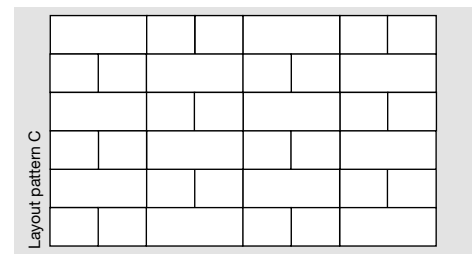
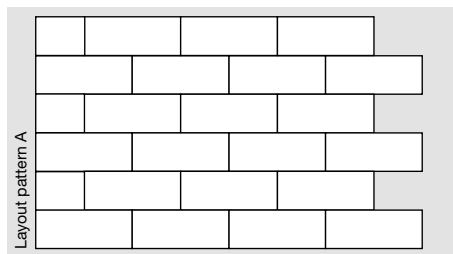

**LAYOUT PROCEDURES OF MODULO**

By choosing this layout procedure — and the selection of the décor or varying décors — you have many design possibilities.

**Note:** The arrangement of sheet sizes can significantly influence time and effort required for the substructure. For joints lying vertically one atop the other, particularly careful work is necessary.

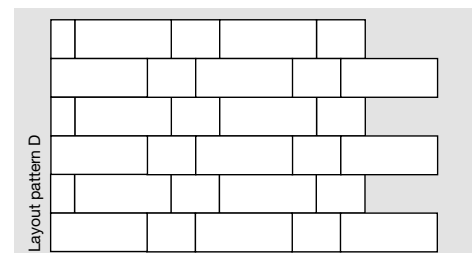
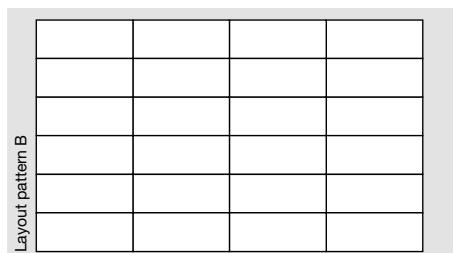

## Assembly

### 1. PREPARATION

To achieve a visually appealing facade and minimize waste, prior to commencing assembly it is recommended to draw up an exact plan of the façade view based on field measurements. Pay attention to fitting pieces for windows, doors or corners at either end. Do not forget the inner faces of windows and doors when determining the materials to be used. You can also use any cut offs on the next course. When doing so, be careful of the vertical rabbets. The elements cannot be rotated! It may be conducive to the appearance (symmetry of support profiles, cuts to fit in the case of windows) and offcuts to begin at the left side and not with an entire element. Determine the needs for Modulo 2x2 and/ or Modulo 2x4 elements on this basis.

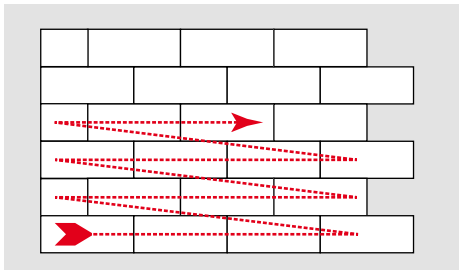

### 2. SUBSTRUCTURE PREPARATION

As a matter of principle, local building regulations are to be followed in all cases. Pay attention to the hints in our brochure “Exterior Technique”. The wooden substructure has to be constructed according to the national standards (wood moisture 15%±3). **Pay attention to chemical or constructive wood preservation!** The basic prerequisite for perfect assembly of the façade system Modulo is a professional, precisely aligned sub-structure with a minimum of 85x30 mm dimensioned wooden substructure battens.

The vertical battens need to be at least 2 3/4" wide to receive the Modulo clip.

In the selection of using façade screws we recommend pre-drilling of the wooden substructure according to the directions of the screw manufacturer.

The wooden substructure battens have to be protected permanently against moisture by an UV- and weather-resistant EPDM protective tape, which is minimum 0.05 inch thick. It is also possible to use an aluminum substructure. The average distance for the standard lengths of 24/48 inch is 16" on-center. For special lengths, please determine this distance yourself. If you use the exterior corner profiles that we offer, a batten width at the exterior corner of 3.94 inch is recommended.

Due to the system sheets' horizontal and vertical rabbeting, we recommend beginning assembly at the bottom left. In general, the assembly of all façade parts, including the window boards, must begin simultaneously with the façade assembly and be performed from the bottom to the top.



### 3. ASSEMBLY OF THE FIRST ROW

Once the substructure has been precisely assembled and the necessary metal covering work performed, mount first the the Modulo clips. These must be aligned horizontally very precisely. All further rows are mounted with Modulo fasteners.



#### 4. ASSEMBLY OF THE FIRST MODULO ELEMENTS

Set the Modulo elements on top of the substructure beginning at the lower left (with the groove facing downwards). Prior to screwing on the upper bracket, the assembly aid must be inserted into both of the holes in the fastener. This guarantees that the sheet will have sufficient vertical clearance. Screw each fastener tightly onto the substructure using two façade screws (at least #12 Screw), 0.19 x 1.18 inch. In certain applications the modulo clip may need to be drilled to receive the installation screw.



#### 5. ASSEMBLY OF THE NEXT MODULO ELEMENT

Screw the second element to the first one at a distance of 0.08 inch. Use the assembly aid to determine the distance. After screwing on the second element and checking the distance, drill through the Modulo element at the upper left fastener in the hole provided and affix the element to the substructure using the supplied locking pin. The element is thereby secured against lateral shifting.



#### 6. CUTS TO FIT/LATITUDE

Continue assembly of the façade in this fashion. Cut the right side to fit, as needed. Please always heed a latitude of at least 0.2 inch to the other construction parts.



#### 7. CONCLUDING ASSEMBLY

For upper or lower cuts to fit, the sheet is to be fastened visibly with façade screws or façade rivets with an appropriate grip of rivet (from 0.75 inch plus, e.g. 0.2 x 0.98 inch rivet). For shimming to the substructure, please use off-cuts from the Modulo elements (fasteners are 0.31 inch thick, sheet off-cuts are likewise 0.31 inch thick).



#### NOTICE

SUPPLIERS FOR FURTHER ACCESSORIES AND GENERAL WORKING INSTRUCTIONS CAN ALSO BE FOUND IN OUR BROCHURE "TECHNIQUE EXTERIOR". PLEASE CONTACT YOUR LOCAL SALES REPRESENTATIVE FOR FURTHER ACCESSORIES COMPLIMENTARY TO THE MODULO SYSTEM

## Basic Design of a MODULO Façade



MODULO FAÇADE SYSTEM

### LEGEND

- A WALL
- B SUBSTRUCTURE
- C VENTILATION
- D MOUNTING CLIP
- E MODULO ELEMENT
- F BUILDING ELEMENTS LIKE WINDOWS/  
DOORS OR WALL SOCKETS





PHOTOGRAPHER: DAVID BOUREAU



ARCHITECT: WAGNER



# Construction-details horizontal sections MODULO Façade System on wooden substructure

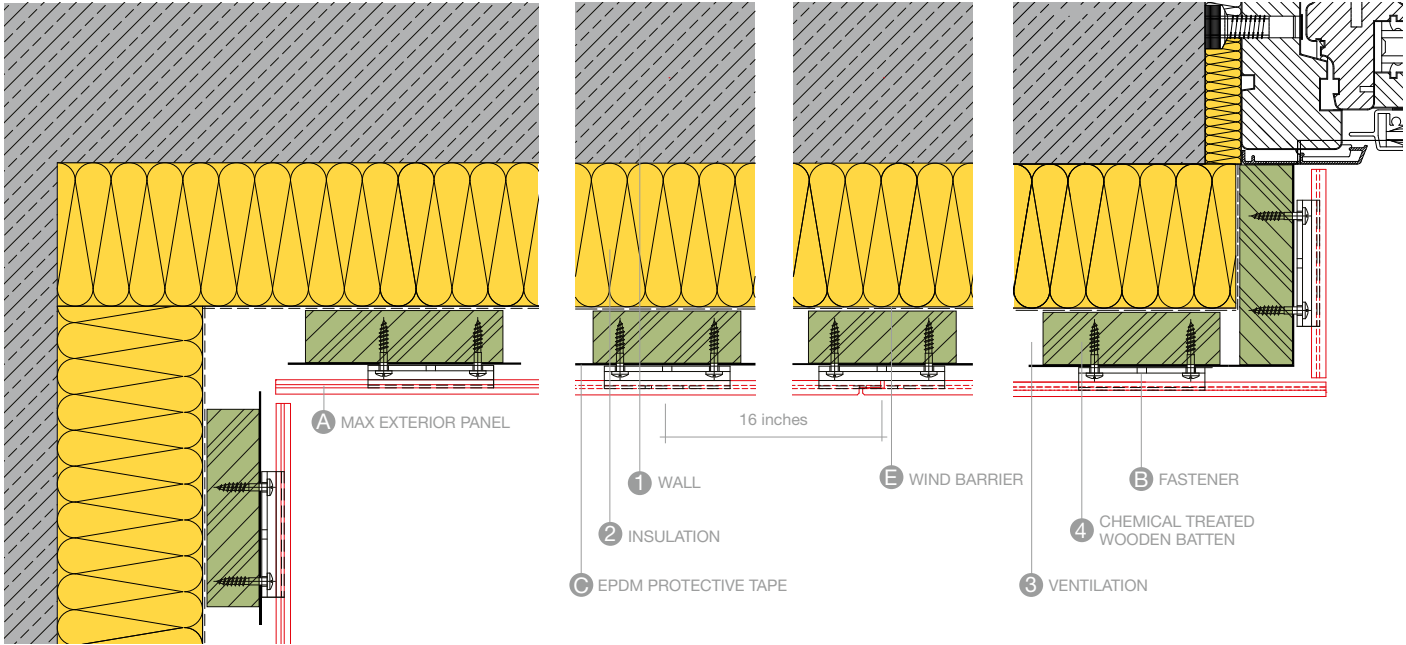

INTERNAL CORNER A106

INTERMEDIATE  
SUPPORT A108

VERTICAL JOINT A107

WINDOW REVEAL A104

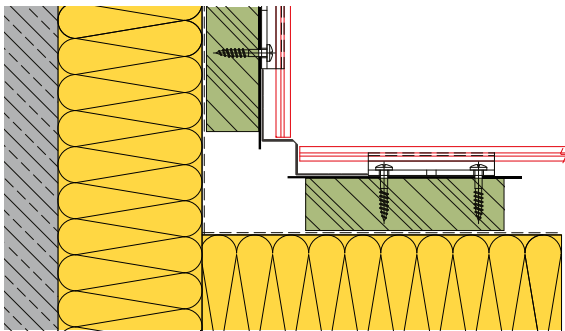

INTERNAL CORNER A106 WITH PROFILE

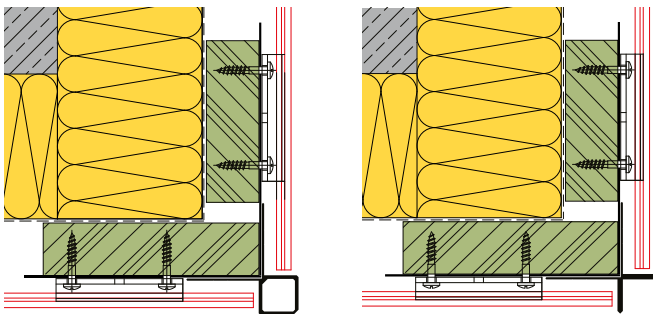

EXTERNAL CORNER A105  
WITH SQUARE PROFILE

EXTERNAL CORNER A105  
WITH CROSS PROFILE

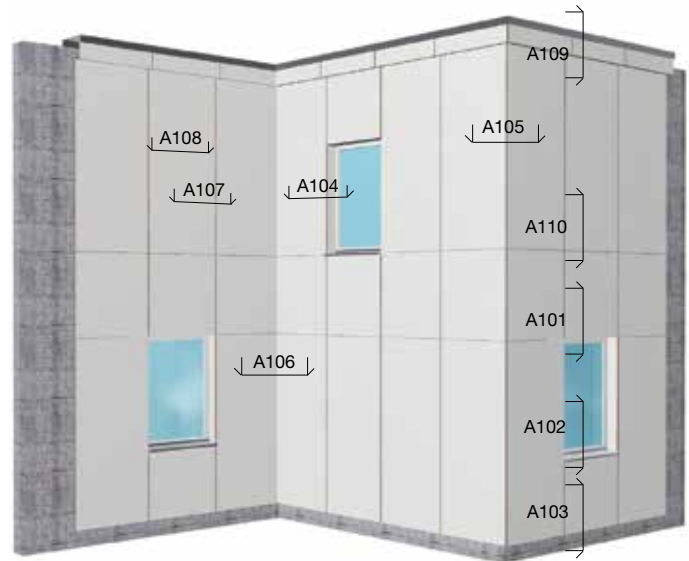

**NOTE**  
MINIMUM 1.2 MM THICK EPDM TAPE IS RECOMMENDED ON ALL WOOD SUBSTRUCTURE, RETURNING BACK 3/8" ON BOTH SIDES.  
ALL THE SHOWN PROFILES AND FASTENINGS (EXCEPT THE FASTENING CLIP AND CORNER PROFILES) ARE PLANNING-SUGGESTIONS AND NOT PART OF THE FUNDERMAX DELIVERY PROGRAMME.  
ALL DRAWINGS IN THIS BROCHURE ARE NOT TRUE TO SCALE.  
CAD-DETAILS ARE AVAILABLE IN THE DOWNLOAD SECTION OF THE FUNDERMAX WEBSITE: [WWW.FUNDERMAX.AT/DOWNLOADS/](http://WWW.FUNDERMAX.AT/DOWNLOADS/)

# Construction-details vertical sections MODULO Façade System on wooden substructure

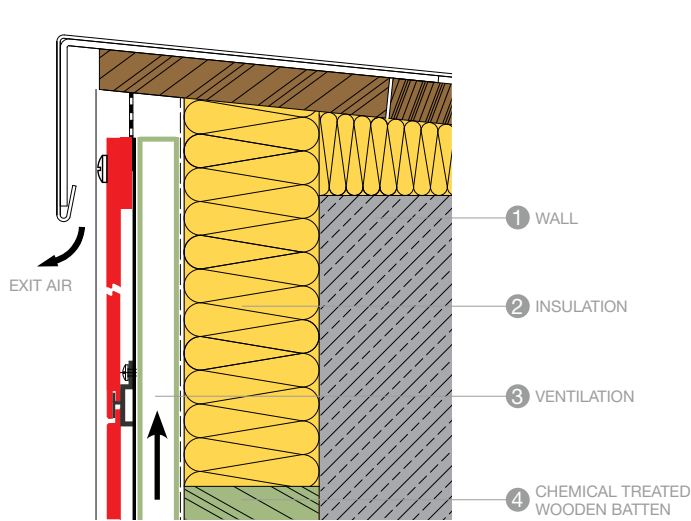

ATTIC CONNECTION A109

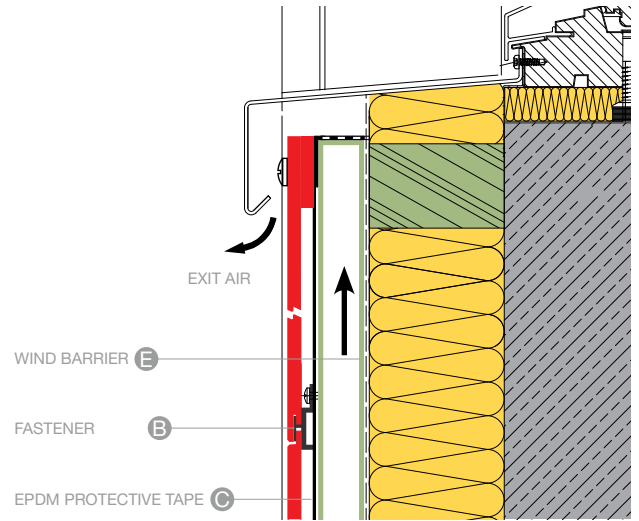

WINDOW SILL CONNECTION A102

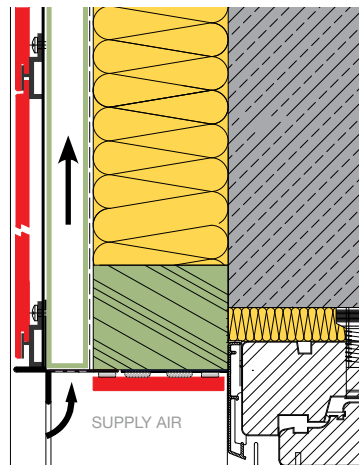

WINDOW LINTEL A101

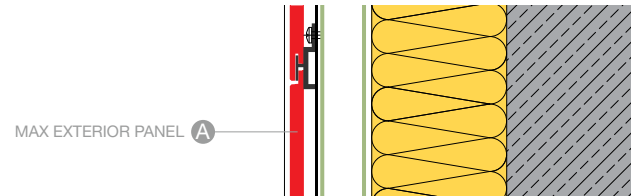

HORIZONTAL JOINT A110

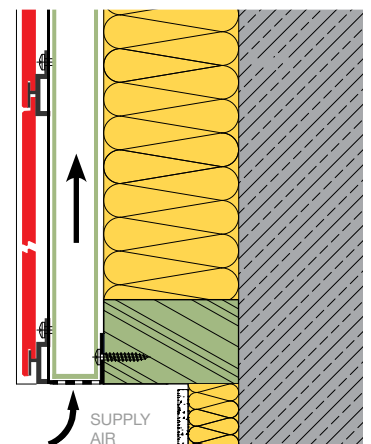

BASE CONNECTION A103

## CORNER CONSTRUCTION

The best way to build corners is the use of our corner profiles. In case of open joints the wooden substructure must be protected with an EPDM protective tape - minimum 0.05 inch thick. Further it is possible to use our corner profiles programme. The right rabbet has to be cut in this case.



INTERNAL CORNER PROFILE Fig. 1



OPEN CORNER JOINT WITH EPDM PROTECTIVE TAPE Fig. 2



SQUARE CORNER PROFILE Fig. 3



CROSS CORNER PROFILE Fig. 4

# Construction-details horizontal sections MODULO Façade System on aluminum-substructure

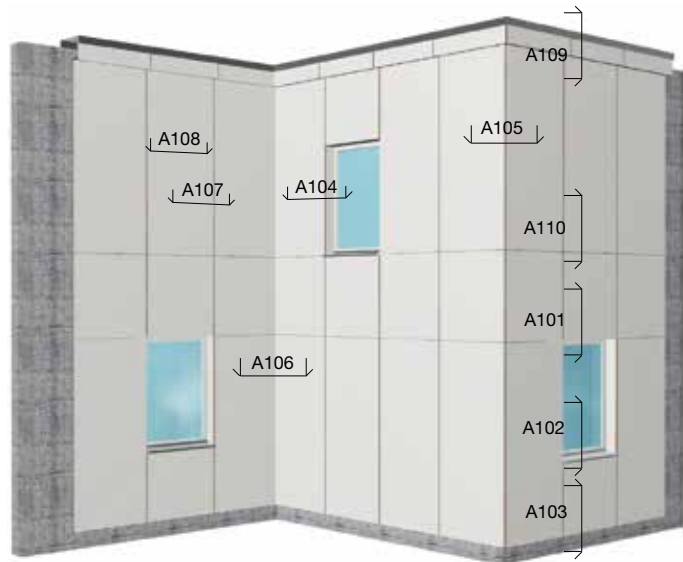
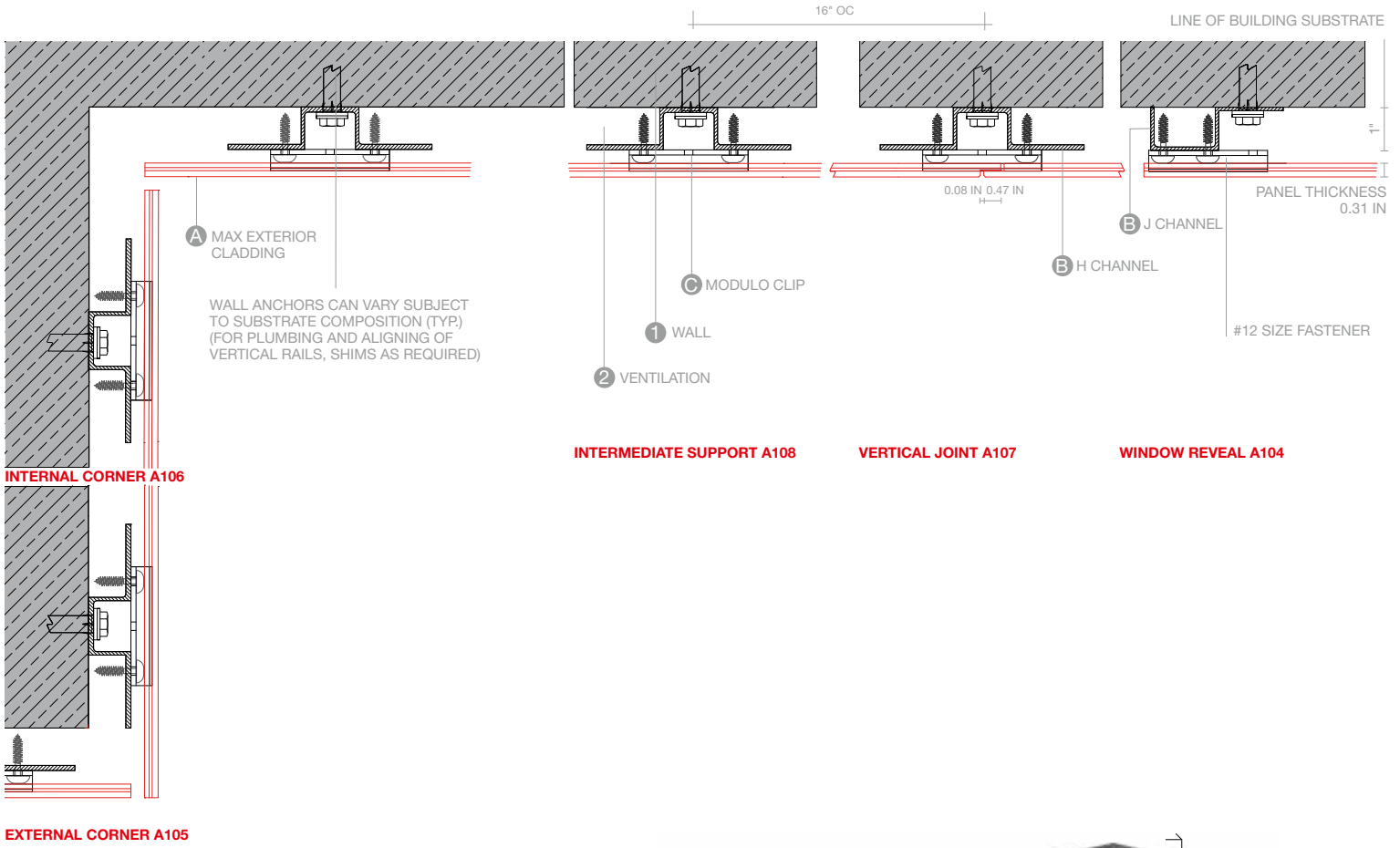

# Construction-details vertical sections MODULO Façade System on aluminum-substructure

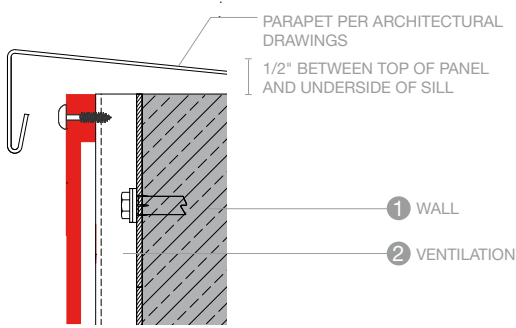

ATTIC CONNECTION A109

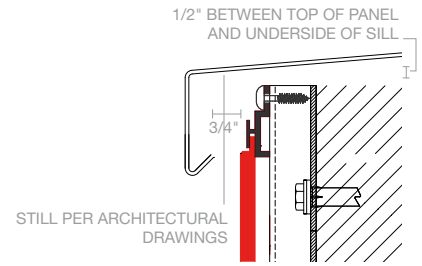
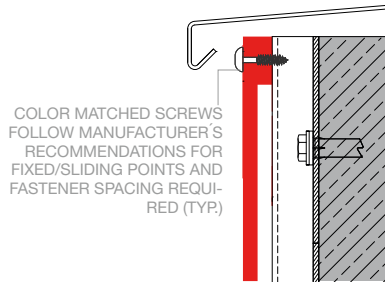

WINDOW SILL CONNECTION A102

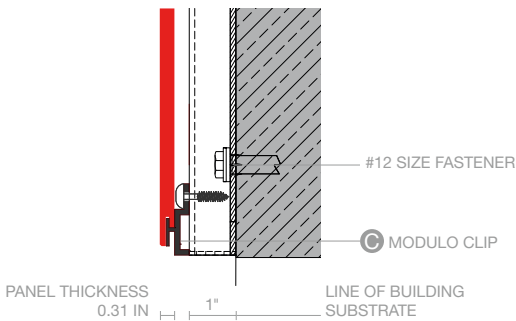

WINDOW LINTEL A101

WALL ANCHORS CAN VARY SUBJECT TO SUBSTRATE COMPOSITION (TYP.) (FOR PLUMBING AND ALIGNING OF VERTICAL RAILS, SHIMS AS REQUIRED)

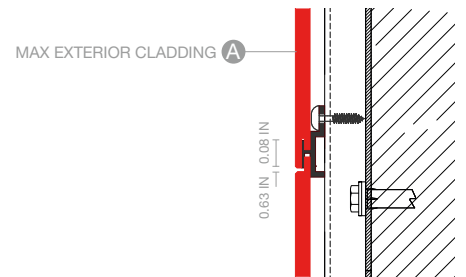

HORIZONTAL JOINT A110

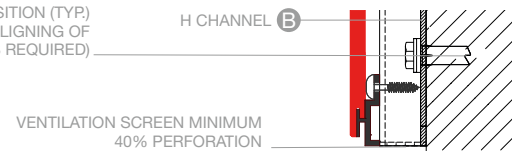

BASE CONNECTION A103

**NOTE**  
ALL THE SHOWN PROFILES AND FASTENINGS (EXCEPT THE FASTENING CLIP AND CORNER PROFILES) ARE PLANNING-SUGGESTIONS AND NOT PART OF THE FUNDERMAX DELIVERY PROGRAMME.  
ALL DRAWINGS IN THIS BROCHURE ARE NOT TRUE TO SCALE!

# Windload

## PANEL SIZE: 2X4 – J-SHAPED EXTRUSION

NO. OF FASTENERS PER CLIP	NOMINAL SIZE OF FASTENER	MINIMUM FASTENER PENETRATION (IN.)	ALLOWABLE WIND PRESSURE (PSF)
2	#12	N/A (full)	33.0
3	#12	N/A (full)	48 (note 8)

## TECHNICAL INFORMATION

- Chart utilizes AAMA TIR-A9-14 (Table 22.10 for allowable pullout of #12 screw in 1/8" 6063-T5 alum.)
- Chart utilizes #12 wood screw with minimum wood penetration shown.
- Wood is assumed to be spruce-pine-fir species with specific gravity,  $G \geq 0.42$ .
- Aluminum and wood verticals and corresponding connection of verticals to substrate beyond must be engineered by others.
- Maximum horizontal on-center spacing of vertical panel supports is 16".
- Maximum panel height is 24".
- Maximum panel wind load deflection used is  $L/60$  of panel length or 1", whichever is smaller.
- Maximum allowable wind load pressure is 48 psf per panel P2.

## PANEL SIZE: 2X4 – SPF WOOD BATTEN\*

NO. OF FASTENERS PER CLIP	NOMINAL SIZE OF FASTENER	MINIMUM FASTENER PENETRATION (IN.)	ALLOWABLE WIND PRESSURE (PSF)
2	#12	1.0	16.2
2	#12	1.5	24.3
2	#12	2.0	32.5
3	#12	1.0	24.3
3	#12	1.5	36.4
3	#12	2.0	48 (note 8)

\* WOOD BATTENS ONLY ALLOWABLE FOR INSTALLED HEIGHTS BELOW 40'. WIND LOAD CHARTS ARE AVAILABLE UPON REQUEST FOR 16"X32" AND 400MM X1000MM PANELS.

# Fire Testing Data

List of the tests/results with qualifications and requirements for NFPA285 assemblies

- ASTM E84 – Class A Rating (FSI = 15, SDI = 70)
- ASTM D 1929 = Pass (Self Ignition Temperature Greater than 650 degrees Celsius)
- NFPA 268 – Surface Ignition Test = Pass
- NFPA 285 – Intermediate Scale Multi Story Apparatus Test = Pass\*

\* THIS IS AN ASSEMBLY TEST, FOR ASSEMBLIES THAT ARE NFPA285 COMPLIANT. SEE DETAILS AND NOTES FOR OPTIONS.

### FOR NFPA285 COMPLIANT ASSEMBLIES:

Base wall to be minimum 18 gauge metal stud framing with 5/8" gypsum sheathing both sides, concrete, or CMU. For these assemblies, panels must be mounted over extruded aluminum mounting systems. Weather resistive barriers can be chosen from the list below based on the amount of exterior mineral wool insulation used in the design. Note that walls not using exterior insulation are also NFPA285 compliant when WRB's from the list below under "Less than 2" of Insulation" are used.

### WEATHER RESISTIVE BARRIER OPTIONS FOR NFPA285 ASSEMBLIES

#### LESS THAN 2-INCH LAYER OF MINERAL WOOL

SUPPLIER	WATER-RESISTIVE BARRIER PRODUCTS
Prosoco	R-Guard Spray Wrap, R-Guard MVP
Dupont	Tyvek, Tyvek Commercial
VaproShield	WrapShield (Green), Reveal Shield, Wrap Shield (Orange; as tested)
Pactive GreenGuard	C500, C200, RainDrop 3D, Classic Wrap
Cosella Dorken	Delta-Vent S/Plus, Delta-Foxx/Plus, Delta-Maxx/Plus
3M	Self-Adhered AVB Membrane 3015
Davis Wire	Building Paper
Mid-State	Building Paper
Hohmann & Barnard	Enviro Barrier VP (15 mils DFT)

#### 2-INCH OR THICKER LAYER OF MINERAL WOOL

Any WRB can be used including asphaltic, butyl based products.

### MINERAL INSULATION REQUIREMENTS FOR WALLS USING EXTERIOR INSULATION:

- The mineral wool must meet the requirements of ASTM C612.
- The mineral wool shall not have any type of facer (foil, etc.) on either side.
- The mineral wool shall be non-combustible via ASTM E 136 testing;
- The R value of the mineral wool shall be a minimum of 2.0.
- The mineral wool insulation must be securely attached to the wall system by either being mechanically attached back to the base wall assembly using insulation pins or equivalent or friction fit within the exterior wall assembly cladding rail system.
- The density of the mineral wool must be a minimum of 4lbs per cubic foot.

# Technical Properties Datasheet

## FUNDERMAX COMPACT EXTERIOR, F QUALITY, NT SURFACE

PROPERTIES	TEST METHOD	STANDARD VALUE	
<b>MECHANICAL PROPERTIES</b>			
Panel Core		Standard Dark Brown Core, Finish on both sides	
Porosity		Non Porous surface and edges	
Antimicrobial Characteristics		FunderMax panels do not support microorganic growth	
Modulus of Elasticity	property tested according to ES 438.2	≥ 9000 N/mm <sup>2</sup>	≥ 1,305,340 psi
Tensile Strength	property tested according to ES 438.2	≥ 80 N/mm <sup>2</sup>	≥ 11,603 psi
Flexural Strength	property tested according to ES 438.2	≥ 90 N/mm <sup>2</sup>	≥ 13,053 psi
Density	Per EN ISO 1183-1	1.35 g/cm <sup>3</sup>	1 N/mm <sup>2</sup> = 1MPa
Surface Impact Resistance	Falling ball test per EN 438-2:21, (standard value ≤ 10 mm)	≤ 10 mm	
Scratch Resistance	Per EN 438-2:25	4-6 N	4 N = .9 lbf
Abrasion Resistance	1 U = 1 cycle of rotation, property as tested per ES 438.2	≤ 450 U	
Color Stability – Artificial Weathering inc. Lightfastness	Per EN ISO 4892-2, industry standard ≥ 3	Greyscale value 4-5	
Resistance to Fixings – Pullout Strength ISO 13894-1		≥ .3937 in	≥ 4000 N

PROPERTIES	TEST METHOD	STANDARD VALUE		
<b>FIRE BEHAVIOR</b>				
Burning Classification	As tested per ASTM E84	Class A rating		
<b>Panel Thickness</b>		<b>8 mm</b>	<b>10 mm</b>	<b>12 mm</b>
FSI (Flame Spread Index)	As tested per ASTM E84	15	10	5
SDI (Smoke Develop Index)	As tested per ASTM E84	70	60	95

PROPERTIES	TEST METHOD	STANDARD VALUE	
<b>MECHANICAL PROPERTIES</b>			
Thermal Conductivity		0.3 W/mK	
Water Vapor Diffusion Resistance		ca. 17.200 μ	
Dimensional Changes during climatic	Dimensional Stability per EN 438-2:17	l %	0.1
Changes, measured at elevated temperatures		Q %	0.25
Dimensional Tolerance of Nominal Sizes		(+10 mm / - 0 mm)	
Dimensional Tolerance of Thicknesses		+/- .5 mm	≤ 12 mm
Resistance to Chemicals	FunderMax panels are highly resistant to many chemicals, complete list available on request		
Ease of maintenance/Cleaning	FunderMax panels resist dirt, easily cleaned with common agents, complete list available		

**SEE FUNDERMAX ICC ESR #3340 FOR ICC AC92 COMPLIANCE (NFPA285 ASSEMBLIES, AND ALL OTHER IBC CODE PRESCRIBED TESTS)**

**NOTE**  
VALUES ARE AVERAGE VALUES.



## Modulo Custom Sizing Guidelines

**Modulo can be manufactured and installed in horizontal plank formats according to the following:**

Minimum Height: 6 in (152 mm)  
Maximum Height: 24 in (610 mm)

Horizontal joints along top and bottom edge will always be 2 mm, set with the Modulo installation tool. For panels going beyond the standard 4' length, the end joints (right and left edge) must be spaced per the following:

**Panels 4-6 ft** (1219 to 1829 mm) = 4 mm joint (5/32 in)

**Panels 6-10 ft** (1829 to 3048 mm) = 6 mm joint (1/4 in)

**Panels 10 ft +** (3048 mm +) = 8 mm joint (5/16 in)

Fastening guidelines for 2 ft x 4 ft sizes are shown in this brochure. All other sizes are subject to the project specific engineering. Maximum allowable distance between clips is 24 in. Fastening must always be along the top and bottom routed edges.



## MODULO: For Modern Interior Design

Thanks to its decorative effect, Modulo is, of course, also perfect for interiors. Closed joint system, glossy surfaces, quick installation – Take advantage of our system and the large variety of designs to make your rooms more comfortably pleasant. Practical advantage: All the wires are hidden behind the panel construction.

In addition to the stock designs on pages 16/17, you can choose from a further 100 designs in our Max Exterior Collection. From interior walls to exterior façades, designing any surface is easy with Modulo.

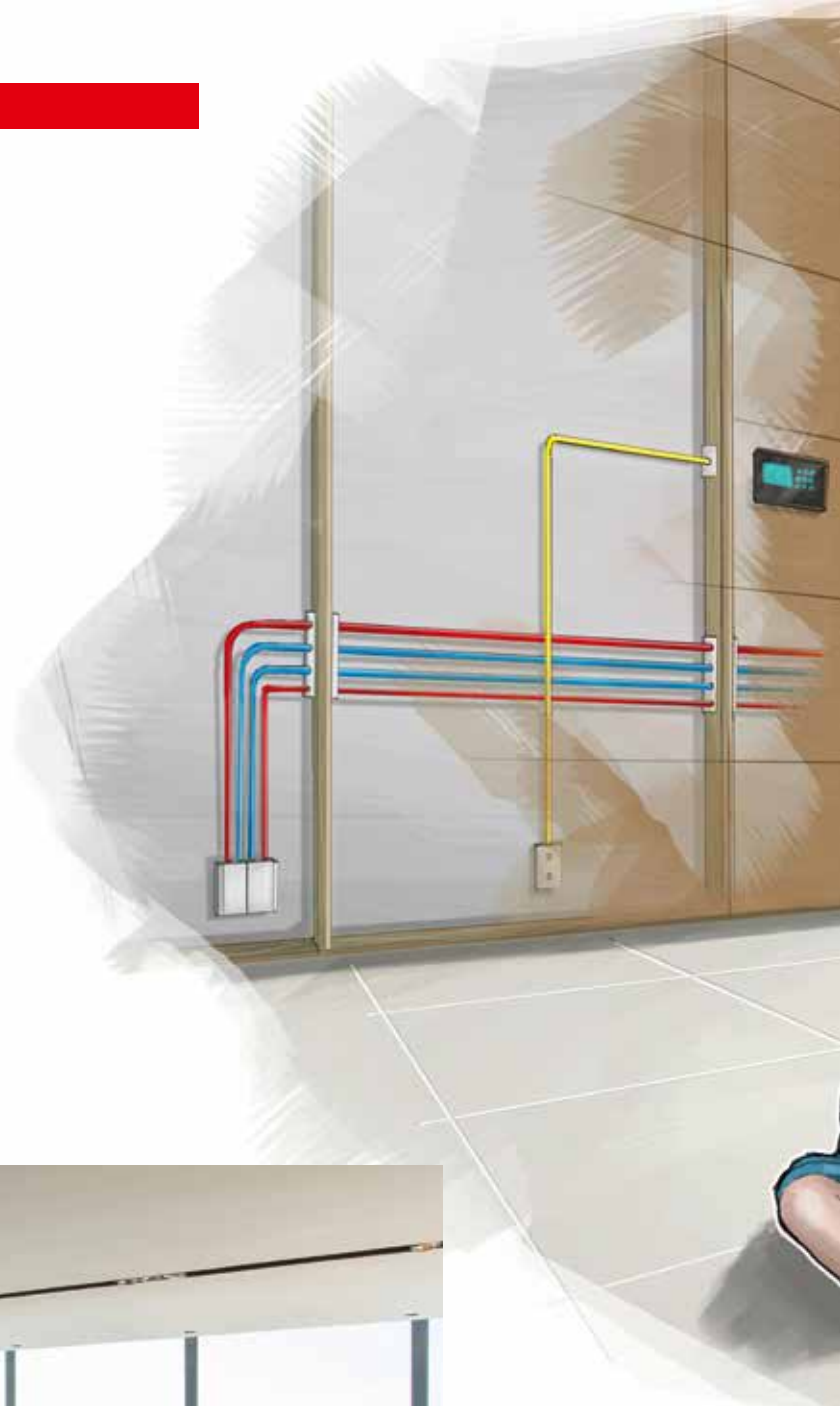

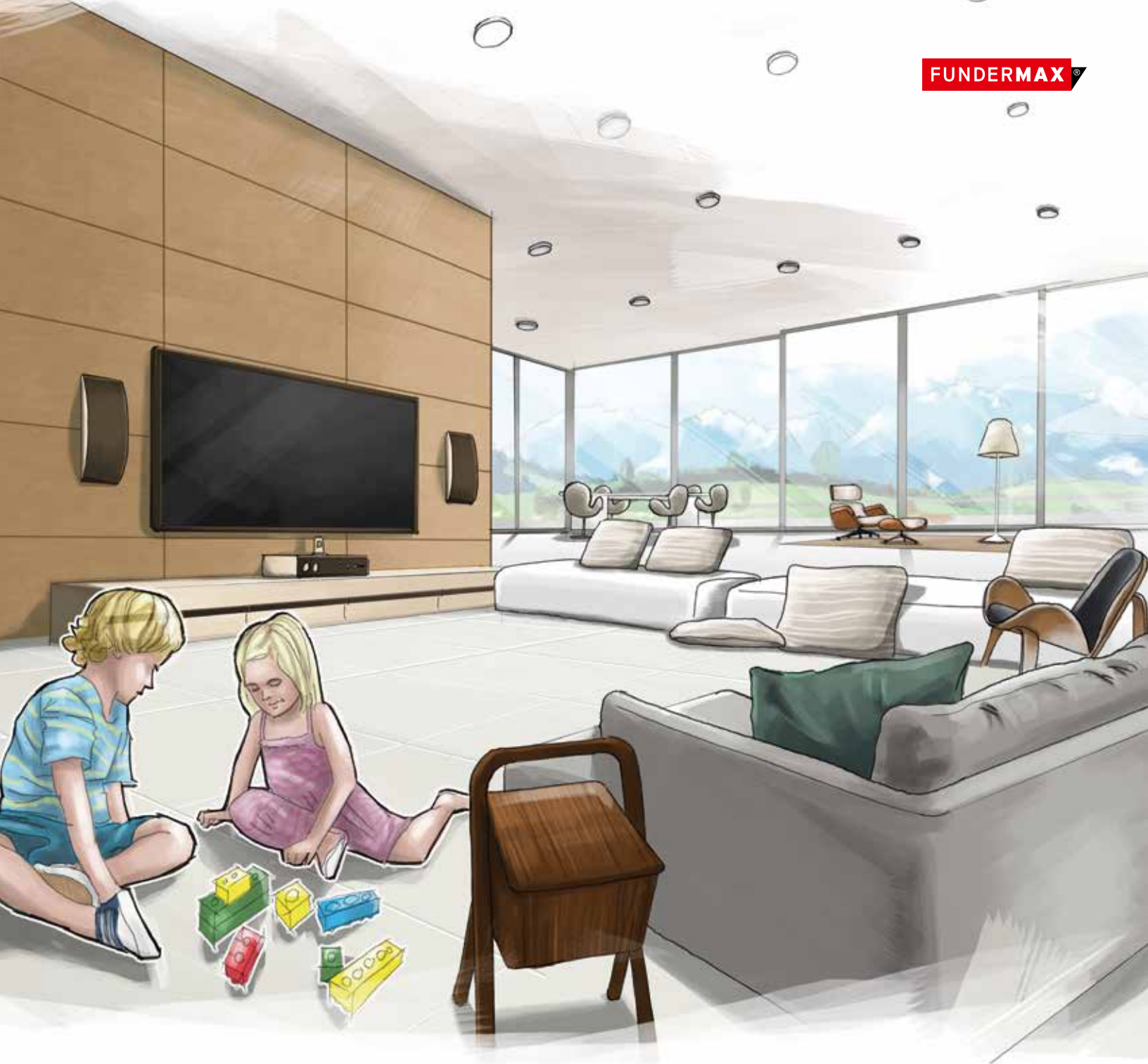

**FunderMax North America, Inc.**

2015 Ayrley Town Blvd. Suite 202  
Charlotte, NC 28273, USA  
Tel.: +1 980 299 0035  
Fax: +1 704 280 8301  
office.america@fundermax.biz  
www.fundermax.at

**FunderMax GmbH**

Klagenfurter Straße 87-89, A-9300 St. Veit/Glan  
T +43 (0) 5/9494-0, F +43 (0) 5/9494-4200  
office@fundermax.at, www.fundermax.at

AVAILABLE THROUGH:

