



2022 RULEBOOK



HEAD AND NECK RESTRAINTS



SCAN TO LEARN MORE:
WWW.NECKSGEN.COM

TABLE OF CONTENTS

NHRA Summit Racing Jr. Drag Racing League Rulebook

Contents	Page
Tech Contacts.....	2
NHRA Division Offices	3
The Basics of Drag Racing	4
Administrative Procedures & Appeals	7
Race Procedures.....	25
Jr. Dragster Rules and Regulations	29
Class Designations.....	29
Engine.....	31
Drivetrain	33
Brakes & Suspension	34
Frame	34
Tires & Wheels.....	37
Interior.....	37
Body	38
Electrical.....	38
Support Group.....	39
Driver.....	41
General	43
Electric-Powered Jr. Dragster.....	43
Jr. Comp	45

In case of differences in interpretation regarding terms used in various translations of the rules and regulations of NHRA, the English text will control.

COPYRIGHT © 2022 by the National Hot Rod Association. No part of this Rulebook may be reproduced without the express written permission of the National Hot Rod Association.



HAVE A TECH QUESTION?

The NHRA's staff of technical personnel is available at all Camping World and Lucas Oil Drag Racing Series events around the country. Additionally, the NHRA has resources in Indianapolis and all seven NHRA divisions to answer your questions about safety, rules, and compliance.

NHRA Divisional Technical Services Representatives **Division 1**

(Connecticut, Delaware, District of Columbia, Maine, Maryland, Massachusetts, New Hampshire, New Jersey, New York, Pennsylvania, Rhode Island, Vermont, Virginia, and West Virginia; Maritime Provinces, Eastern Ontario, and Quebec, Canada)

Contact

Ryck Campbell, Technical Specialist,
rcampbell@nhra.com, 315.335.8295

Division 2

(Alabama, Florida, Georgia, Mississippi, North Carolina, South Carolina, Tennessee, and Virginia; Puerto Rico and the Caribbean)

Contact

Technical Services,
TechDL@NHRA.com, 844.468.7631

Division 3

(Illinois, Indiana, Kentucky, Michigan, Ohio, and Wisconsin; Western Ontario, Canada)

Contact

Joe Lease, Technical Specialist,
jlease@nhra.com, 626.253.3294

Division 4

(Arkansas, Louisiana, Mississippi, New Mexico, Oklahoma, Tennessee, and Texas; Mexico)

Contact

Matt Plotkin (Regional Technical Specialist),
mplotkin@nhra.com, 626.505.4339

Division 5

(Colorado, Illinois, Iowa, Kansas, Minnesota, Missouri, Nebraska, North Dakota, South Dakota, Wisconsin, and Wyoming; Manitoba, Canada)

Contact

Bob Blackwell, Technical Specialist,
bblackwell@nhra.com, 816.795.6127

Division 6

(Alaska, Idaho, Montana, Oregon, and Washington; Alberta, British Columbia, and Saskatchewan, Canada)

Contact

Russ Smith, Regional Technical Specialist,
rsmith@nhra.com, 626.650.4483

Division 7

(Arizona, California, Colorado, Hawaii, Nevada, New Mexico, and Utah; Mexico)

Contact

Pat Cvengros, Technical Specialist,
pcvengros@nhra.com, 626.250.2295

NHRA National Technical Services Representatives

Call 844.468.7631

(Monday-Thursday, 8 a.m.- 8 p.m. ET; Friday, 8 a.m.- 3 p.m. ET)
or TechDL@NHRA.com

NHRA Division Offices

NORTHEAST DIVISION (1) OFFICE

Dave Mohn, Division Director, dmohn@nhra.com, 717.584.1200; fax, 717.390.3052
Ryck Campbell, Technical Specialist, rcampbell@nhra.com, 315.335.8295
Dan Pomponio III, Division Services Coordinator, dpomponio@nhra.com, 717.584.1204
Kyra Martin, Division Administrative Assistant, kmartin@nhra.com, 717.584.1205
2420 Gehman Lane, Suite 200, Lancaster, PA 17602
Monday and Thursday, 8 a.m.-4 p.m. ET, Friday, 8 a.m.-noon ET
Northeast Division: Connecticut, Delaware, District of Columbia, Maine, Maryland, Massachusetts, New Hampshire, New Jersey, New York, Pennsylvania, Rhode Island, Vermont, Virginia, and West Virginia; Maritime Provinces, Eastern Ontario, and Quebec, Canada

SOUTHEAST DIVISION (2) OFFICE

Cody Savage, Division Director, csavage@nhra.com, 352.374.9922; fax, 352.371.4212
Technical Services, TechDL@NHRA.com, 844.468.7631
11223 N. County Road 225, Gainesville, FL 32609
Southeast Division: Alabama, Florida, Georgia, Mississippi, North Carolina, South Carolina, Tennessee, and Virginia; Puerto Rico and the Caribbean

NORTH CENTRAL DIVISION (3) OFFICE

William Tharpe, Division Director, wtharpe@nhra.com, 317.406.7740
Joe Lease, Technical Specialist, jlease@nhra.com, 626.253.3294
Kenny Lubanski, Division Services Coordinator, 317.969.7932
Neysa Jones, Division Administrative Assistant, 317.969.8890
PO Box 34300, Indianapolis, IN 46234; 317.969.8890; fax, 317.291.4220
Monday-Thursday, 8 a.m.-8 p.m. ET, Friday, 8 a.m.-3 p.m. ET
North Central Division: Illinois, Indiana, Kentucky, Michigan, Ohio, and Wisconsin; Western Ontario, Canada

SOUTH CENTRAL DIVISION (4) OFFICE

Trey Capps, Division Director, tcapps@nhra.com, 469.248.0014; fax, 469.248.0024
Matt Plotkin, Regional Technical Specialist, mplotkin@nhra.com, 626.505.4339
Mady Ayesh, Division Services Coordinator, 469.248.0014
12959 Jupiter Road, Suite 240, Dallas, TX 75238
Monday and Friday, 7-9 p.m. CT
South Central Division: Arkansas, Louisiana, Mississippi, New Mexico, Oklahoma, Tennessee, and Texas; Mexico

WEST CENTRAL DIVISION (5) OFFICE

Rob Park, Division Director, rpark@nhra.com, 816.795.8055; fax, 816.795.0515
Bob Blackwell, Technical Specialist, bblackwell@nhra.com, 816.795.6127
Chris Ison, Division Services Coordinator, cison@nhra.com, 816.795.8055
3720 Arrowhead Ave., Suite 103, Independence, MO 64057
Monday-Thursday, 9 a.m.-5 p.m. CT, Friday, 9 a.m.-noon CT
West Central Division: Colorado, Illinois, Iowa, Kansas, Minnesota, Missouri, Nebraska, North Dakota, South Dakota, Wisconsin, and Wyoming; Manitoba, Canada

NORTHWEST DIVISION (6) OFFICE

Matt Levonas, Division Director, mlevonas@nhra.com, 253.446.6594; fax, 253.446.6683
Russ Smith, Regional Technical Specialist, rsmith@nhra.com, 626.650.4483
Judy Richey, Division Administrative Assistant
3702 West Valley Highway N, Suite 104, Auburn, WA 98001
Monday and Friday, 7-9 p.m. PT
Northwest Division: Alaska, Idaho, Montana, Oregon, and Washington; Alberta, British Columbia, and Saskatchewan, Canada

PACIFIC DIVISION (7) OFFICE

Mike Rice, Division Director, mrice@nhra.com, 626.914.4761, ext. 498; fax, 626.466.9089
Pat Cvangros, Technical Specialist, pcvangros@nhra.com, 626.250.2295
140 E. Via Verde Suite 100, San Dimas, CA 91773
Monday-Thursday, 8 a.m.-5 p.m. PT, Friday, 8 a.m.-noon PT
Pacific Division: Arizona, California, Colorado, Hawaii, Nevada, New Mexico, and Utah; Mexico

National Technical Services Representatives

Monday-Thursday, 8 a.m.-8 p.m. ET; Friday, 8 a.m.-3 p.m. ET
For technical questions, call 844.468.7631 (844.HOTROD1)
Tech Services: email, TechDL@nhra.com

Membership Services: 800.308.6472; outside U.S., 626.250.2490; membership@nhra.com

NOTICE

Drag racing is a dangerous sport. There is no such thing as a guaranteed safe drag race. Drag racing always carries with it the risk of serious injury or death in any number of ways. This risk will always exist no matter how much everyone connected with drag racing tries to make our sport safer. Although NHRA works to promote and enhance the safety of the sport, there are no guarantees that such safety measures will guarantee or ensure safety. The participant always has the responsibility for the participant's own safety, and by participating in drag racing, the participant accepts all risks of injury, whether due to negligence, vehicle failure, or otherwise. If at any time a participant does not accept these risks, the participant agrees not to participate in drag racing.

WHAT IS A DRAG RACE?

In basic terms, a drag race is an acceleration contest from a standing start between two vehicles over a measured distance. The accepted standard for Jr. drag racing is an eighth-mile. These contests are started by means of an electronic device commonly called a "Christmas Tree." Upon leaving the starting line, each contestant's vehicle activates a timer, which is stopped when the same vehicle reaches the finish line. The start-to-finish clocking is the vehicle's e.t. (elapsed time), which serves to measure performance and determine handicaps during competition.

Virtually anyone ages 5-17 can participate in NHRA Summit Racing Jr. Drag Racing League competition. Drivers are required to have an NHRA Summit Racing Jr. Drag Racing League participant card and must be capable of the safe operation of the vehicle. The vehicle must meet basic safety criteria outlined in this Rulebook.

It is essential for every participant to understand this fundamental rule of drag racing: Prime responsibility for the safe condition and operation of a vehicle in competition rests with the vehicle owner, driver, and crewmembers. The track operator's main concern is to provide a place to conduct events. NHRA produces guidelines based on experience and circulates information to help perpetuate the sport. Close observance of the standards set forth in this Rulebook is required for all participants, including owners, drivers, and crewmembers. However, drag racing is dangerous. Therefore, no express or implied warranty of safety is created from publication of or compliance with NHRA rules, nor does compliance with NHRA rules guarantee against injury or death to participants, spectators or others. Participants are encouraged to investigate the utility of additional safety devices for their type of competition.

It is the responsibility of the participant to be familiar with the contents of this Rulebook and to comply with its requirements. Do not leave it up to track officials to catch all potential rule compliance problems. That responsibility rests first and foremost with YOU - the participant and the participant's parents.

Additional safety equipment or safety-enhancing equipment is

always permitted, and the levels of safety equipment stated in this Rulebook are minimum prescribed levels for a particular type of competition and do not prohibit individual racer from using additional safety equipment. In disputed cases, whether an item of equipment is safety-enhancing or performance-enhancing will be determined by NHRA in NHRA's sole and absolute discretion.

Regarding performance equipment, it is the general rule that unless optional performance equipment or performance-related modification is specifically permitted by this Rulebook, it is prohibited. All model, engine, or equipment changes or modifications not specifically addressed in this Rulebook must be submitted in writing to NHRA for consideration prior to competition. Approval will be granted or denied in NHRA's sole and absolute discretion. The applicant will be notified of approval or rejection from NHRA headquarters in Glendora, Calif.

Additionally, any type of vehicle not specifically defined in this Rulebook, other official NHRA Rulebooks, or other official NHRA supplements is prohibited for use in competition or exhibition.

Unauthorized cars, parts, and/or equipment will not be considered approved by reason of having passed through technical inspection at any time or any number of times. Moreover, having passed through technical inspection at any time or any number of times is not a defense of a violation found on further inspection.

A Jr. drag racer's primary objective is to become the overall winner of the category of competition in which his or her car is classified. A series of two-car, tournament-style eliminations is conducted. The losing vehicle in each race is eliminated, and the winning drivers progress into succeeding rounds of competition. This series of races continues until one winning driver remains. That driver is declared the category winner.

At an event, Jr. drag racers are divided on the basis of their age and performance, or e.t. (elapsed time), brackets. This form of drag racing offers a good starting point for the novice wishing to become involved in the sport. In this form of racing, two vehicles of varying performance potentials can race on a potentially even basis. The anticipated elapsed times for each vehicle are compared, with the slower car receiving a head start equal to the difference between the two. With this system, virtually any two vehicles can be paired in a competitive drag race. For example: Jr. Dragster A has been timed at 14.78, 14.74, and 14.76 seconds for the eighth-mile, and the driver feels that a "dial-in" of 14.75 is appropriate. The driver of Jr. Dragster B has recorded elapsed times of 12.27, 12.22, and 12.26 on the same track and has chosen a dial-in of 12.25. Accordingly, Jr. Dragster A will get a 2.5-second head start over Jr. Dragster B when the Tree counts down to each car's starting green light. If both vehicles cover the eighth-mile in exactly the predetermined elapsed time, the win will go to the driver who reacted quickest to the starting signal. That reaction to the starting signal is called "reaction time." Both lanes are timed independently of each other, and the clock does not start until the vehicle actually moves. Because of this, a

vehicle may sometimes appear to have a mathematical advantage in comparative elapsed times but will actually lose the race. This makes starting-line reflexes extremely important in drag racing.

Should a driver go quicker than his or her predetermined e.t. dial-in, it is a "breakout" and grounds for disqualification. In the case of both vehicles running under their dial-ins, the win goes to the driver who breaks out the least. Another form of disqualification is a foul start (or "red-light"). This happens when the driver reacts to the Tree too quickly and drives away from the starting line before the green go signal. Should dual infractions occur – for example, a red-light then a breakout – the red-light would be classified as the worst infraction. A driver may also be disqualified for breaking the safety e.t. barrier for his or her age group.

Essentially, drag racing is a pairing of two vehicles against each other in a race through a straightaway course. The start is the key to its uniqueness, because all races start from a standstill. Today's modern starting system is a product of continued development, designed to provide each competitor with the fairest start possible. The system features a vertical series of lights displaying a visual countdown for each driver. Most drivers try to make their move between the last amber light going off and the green light coming on. Technique in staging and starting is one of the most vital skills a Jr. drag racer can develop, because a majority of races are won or lost at the starting line. Close observation and lots of practice can pay off.

Two performances are monitored for each run: the elapsed time and the speed. On a run, the car first leaves the starting line, breaking the light beam that activates the electronic timer. As the car continues through the course, the timer records the elapsed seconds and fractions of seconds until the car breaks the finish-line beam and stops the timer. Top speed is determined by the car breaking two additional light beams at the finish line.

PARTICIPANT AGREEMENTS AND ADMINISTRATIVE AND PROCEDURAL RULES; RULE CHANGES; RULE ENFORCEMENT; DISPUTE RESOLUTION PROCEDURES

1: DEFINITIONS

Certain terms used in this Rulebook are defined terms which, when used herein, have the meaning set forth below:

Participant: The term "participant" shall include officials, any person or entity possessing or who has been issued a credential, and any person or entity directly or indirectly associated with any vehicle that has been permitted to enter an event site for the purpose of participation in an event, including, but not limited to, owners, drivers, crewpersons, parents, and legal guardians. The term "participant" shall include any person or entity that has any ownership interest in a race team, vehicle, or otherwise. As to any entity, the term "participant" shall include each of the entity's owners, principals, agents, parents, subsidiaries, divisions, partners, affiliates and other related persons or entities. NHRA may require at any time and from time to time that verified information regarding team and/or vehicle ownership, crewmembers and other information be supplied.

For any racer under the age of 18, both the racer and his or her parent or guardian are a "participant" and are bound by all provisions of this Rulebook, and in any administrative or disciplinary process, the parent and/or legal guardian shall participate in administrative or disciplinary process and be responsible for any penalty, fine or other matter in connection therewith.

Event: Throughout this Rulebook, there is reference to "event" or "events." Wherever this term is used, it is intended to refer to two types of drag racing activities: (1) NHRA events, which are those events that NHRA conducts. These include but are not limited to events such as NHRA Camping World Drag Racing Series events, NHRA Lucas Oil Drag Racing Series events, National Opens, and the like; and (2) drag racing events conducted at NHRA member tracks which NHRA does not conduct but that are conducted in accordance with NHRA Rules.

2: SCOPE OF NHRA RULEBOOK

The principal source of authority for the conduct of events is the NHRA Rulebook. The Rulebook governs all decisions at NHRA events and governs all NHRA matters affected by the Rulebook.

Each and every participant is bound by the Rulebook and is held responsible for knowledge of and compliance with the Rulebook. Ignorance or misunderstanding of a rule does not excuse noncompliance. Participants' knowledge of and compliance with the Rulebook contributes to the safety of the sport and is required. By participating in the sport, every participant and every parent of a participant affirms that he or she has read, understands and agrees to be bound by all NHRA rules and regulations, including those contained in the NHRA Rulebook, including amendments.

NHRA has developed and published this Rulebook for the purpose of providing guidance in the conduct of NHRA events and events conducted at

NHRA member tracks, and as to all aspects of participation in NHRA, whether or not related to an event. NHRA makes no representations or express or implied warranties that compliance with the rules, regulations and agreements published in this Rulebook or as amended will reduce, prevent or guarantee against injury or death to spectators or participants or damage to property or other economic injury or damages. The rules, regulations, and agreements herein constitute the minimum acceptance standards for competition and are intended as a guide for the conduct of the sport. NHRA does not intend to imply by the publication of the Rulebook, by the conduct of various racing events, by the licensing of drivers, by the acceptance of event entries, or by any other act or omission to act that any person has the right or the inalienable privilege of participating in NHRA events and/or NHRA member track events.

2.1 DEVELOPMENT OF NHRA RULES

Since it was founded by Wally Parks in 1951, NHRA has promulgated rules to govern its sport. Thus, over five decades of experience have shaped, and continue to shape, the NHRA rules. The development of NHRA rules is based on many considerations. Some factors affecting NHRA rulemaking include promoting participant safety; promoting spectator safety; preserving competition; even competition; insurance preservation; costs to participants such as, for example, costs that would have to be incurred if new equipment were allowed and/or mandated; attempts to contain costs being experienced by competitors to ensure continued competition; preserving the ability to race in various geographic locations; concerns affecting television coverage of those events for which television coverage is provided; costs to NHRA; regulating or containing the performance of racing vehicles to address safety and other considerations; other safety and security matters, and numerous other factors that affect the complex and intricate issues with which NHRA, as a sports sanctioning body, must deal and balance.

2.2 NEW RULES AND RULE CHANGES

NHRA rules may be added, deleted and/or amended from time to time and at any time by NHRA. It is the participant's responsibility to stay abreast of all NHRA rule changes that may affect the participant. Additions, deletions or changes to the Rulebook (collectively referred to herein as "amendments") will be communicated as follows:

1. Publication on NHRARacer.com; and/or
2. Publication on JrDragster.NHRA.com

Amendments are effective and enforceable immediately upon publication on NHRARacer.com or on JrDragster.NHRA.com. Racers are responsible to consult and stay up to date with any rules and related information published on NHRARacer.com or on JrDragster.NHRA.com. Amendments always are published on NHRARacer.com and/or JrDragster.NHRA.com.

2.3 OTHER NHRA POLICIES AND PROCEDURES

In addition to the Rulebook, NHRA has set various policies and procedures that also provide guidance for the conduct of racing and are enforceable by NHRA. These items include, without limitation, Competitor Data Sheets, lists of permitted items maintained and available from the Technical Department, and other policies and procedures.

2.4 OFFICIAL OPINIONS ON TECHNICAL ISSUES

Participants may request official opinions on technical issues from NHRA. This type of opinion may be requested, for example, on the acceptability of specific items of equipment or body designs. Any request for an official opinion on technical issues must be made in writing and submitted to

the Technical Department. No opinion on technical issues is binding on NHRA unless published in *Jr. Dragster* online or, if deemed too lengthy for publication in *Jr. Dragster* online, then referred to in *Jr. Dragster* online and published on NHRARacer.com and/or JrDragster.NHRA.com.

2.5 INFORMAL INTERPRETATIONS ON TECHNICAL ISSUES

Participants may communicate with the NHRA Technical Department regarding explanations and interpretations of rules. These communications are advisory only.

3: VOLUNTARINESS; PARTICIPATION NOT A RIGHT; ALL PARTICIPANTS BOUND BY THE RULEBOOK; PARTICIPANT CONDUCT; COVENANT NOT TO SUE

NHRA is a private, voluntary association. While NHRA welcomes the participation of everyone, participation requires a promise and agreement by all participants to abide by all NHRA rules, regulations and agreements, including, but not limited to, those in the NHRA Rulebook. Without this promise and agreement, NHRA would not be able to function as a sport sanctioning body, and NHRA's continuing viability would be at risk. Participation in any and every aspect of NHRA drag racing is a privilege, not a right. See Participant Covenants in Section 3.2.

3.1 PARTICIPANT CONDUCT

Participants at events are expected, at all times, to conduct themselves in a professional and nondisruptive manner consistent with good sportsmanship and NHRA's role as a family-oriented sports organization with events suitable for attendance by all and, as to those events that are televised, suitable for unrestricted viewing by the general public. Any participant who, in the sole and absolute judgment of NHRA (1) verbally or physically threatens another person; (2) uses vulgar or derogatory language; (3) engages in unsportsmanlike conduct; (4) engages in conduct detrimental to the sport of racing; (5) otherwise creates a condition or circumstance that is unsafe, unfair, or out of order; or (6) otherwise violates any NHRA rule, regulation or agreement, shall have violated this rule regarding participant conduct.

Any participant who NHRA believes to have a conflict of interest that does or may improperly affect fair competition shall be disqualified from participating to the extent necessary to avoid such conflict of interest. The scope of such a disqualification shall be determined in the sole and absolute discretion of NHRA.

3.2 PARTICIPANT COVENANTS AND COVENANT NOT TO SUE

Each participant (which for all purposes in this Rulebook includes the parents/legal guardians and the minor participant) expressly agrees to abide by all NHRA rules, regulations and agreements, including but not limited to those contained in the NHRA Summit Racing Jr. Drag Racing League Rulebook, and by NHRA decisions, whether or not related to an event. Notwithstanding any other provision of this Rulebook, by participating in, and in consideration for being allowed to participate in NHRA drag racing, and in consideration of receiving any of the numerous benefits available to participants, each participant understands, acknowledges and agrees that:

- 1) Participation in any and every aspect of NHRA drag racing is a privilege, not a right.

- 2) The participant voluntarily chooses to participate in accordance with all NHRA rules, regulations and agreements, including but not limited to those contained in the NHRA Summit Racing Jr. Drag Racing League Rulebook, and by NHRA decisions, whether or not related to an event.
- 3) When a participant submits an entry for competition in an event, and the entry is accepted, the participant is obligated to compete in the event in good faith to the best of the participant's ability unless prevented from so doing by matters beyond the participant's control.
- 4) The NHRA Summit Racing Jr. Drag Racing League Rulebook and the dispute resolution procedures set forth within the Rulebook apply to any and all decisions, rules, regulations, actions or omissions to act by NHRA, without limitation. For example, and not by way of limitation, decisions on the classification or reclassification of vehicles, what types of vehicles will be allowed to race in a class, whether an event is cancelled, postponed, or rescheduled, whether or how an event is televised, what types of sponsors will be allowed to be featured on race vehicles, and what types of sponsors will not be allowed on site at events at all, to name but a few, are all illustrative of the types of decisions that are governed by and may be challenged only through the dispute resolution procedures set forth in this Rulebook.
- 5) At any event, the participant is bound by and shall abide by the decisions of the event director, the event director's designee(s), and other NHRA or member track officials, which are final unless expressly set forth to the contrary herein.
- 6) Member track officials and personnel (including without limitation member track owners, employees, contractors, agents, vendors or others) are not agents of NHRA and operate independently of NHRA.
- 7) All decisions made by NHRA, including but not limited to those made during or incident to an event, are final and may not be appealed except as expressly subject to review herein, and such decisions may not be made the basis of a lawsuit. The participant further agrees to release and waive from liability and not to bring any action against NHRA, the event director, the event director's designee(s), any NHRA or track official, the racetrack operator, the racetrack owner, event sponsors, other NHRA sponsors, and all other event officials, for any loss, damage, or injury, including without limitation economic loss or damages, caused by any decision, erroneous or otherwise, including without limitation decisions based on malfunctioning electronic or mechanical equipment, and all whether due to negligence or otherwise.
- 8) Any dispute concerning the rules, regulations and agreements of NHRA, any decisions of NHRA or NHRA officials, any acts or omissions to act by NHRA, or any matter regarding participation in NHRA drag racing, shall be resolved exclusively pursuant to the dispute resolution procedures provided in this Rulebook. The participant agrees to indemnify and to hold NHRA harmless from any and all legal fees and costs incurred by NHRA as a result of the failure of the participant to comply with the dispute resolution procedures provided in this Rulebook.
- 9) NHRA, any racing facility, and all of their directors, officers, employees, agents or representatives have no liability to the participant, participant's personal representatives, assigns, heirs, and next of kin for any and all loss or damage and any and all claims or demands of any nature whatsoever including without limitation loss or damage to any property of the participant or property of others entrusted to the participant, whether caused by the negligence of any Releasee (as defined in Section 5.2 herein) or otherwise.
- 10) The participant will not initiate or maintain, directly or indirectly, any kind of civil court lawsuit related to any NHRA rule, regulation, agreement or decision, which lawsuit NHRA determines to be conduct detrimental to NHRA or the sport of drag racing. Factors considered in

determining whether a lawsuit is deemed conduct detrimental to NHRA or to the sport of drag racing include, but are not limited to: the threat posed to maintaining the ability to conduct events and racing activities; the threat posed to the continued viability of the sport of drag racing; disruption to the orderly conduct of the sport of drag racing; damage to NHRA's business and reputation; loss of sponsorship opportunities; disruptions in sponsor relationships; damage to goodwill with vendors, sponsors, customers and members; damage to racing competition; adverse effects upon the insurability of the sport of drag racing, and other damage to NHRA or the sport of drag racing.

- 11) In order to preserve the sport of drag racing, and to preserve NHRA's ability to function and exist as a sanctioning body for drag racing, NHRA must and does rely on the foregoing covenant not to sue.
- 12) NHRA would be severely damaged by breach of the covenant not to sue set forth herein.
- 13) Taking into account the many circumstances affecting the sport of drag racing, and factors that cannot be foreseen and accurately predicted by NHRA and each participant, actual damages to NHRA resulting from breach of the covenant not to sue would be impracticable and extremely difficult to determine.
- 14) In the event of any breach of this covenant not to sue involving a lawsuit filed after May 1, 2004, unless the participant prevails in the participant's lawsuit, the participant:
 - a) May be subject to permanent or temporary suspension or exclusion from NHRA events; and
 - b) Must pay all of NHRA's attorneys' fees and costs related to the lawsuit, including but not limited to fees and costs for in-house counsel (payment must be made before participation, if eligible, in any NHRA event); and
 - c) Must pay any fine assessed by NHRA, (payment must be made before participation, if eligible, in any NHRA event).

3.3 COMPLIANCE WITH NHRA RULES, REGULATIONS AND DECISIONS

Participant compliance with all NHRA rules, regulations and decisions is required. NHRA has the right to take action against any participant for failure to comply with any decision, rule, or regulation of NHRA, including but not limited to failure to comply with the dispute resolution procedures set forth in the Rulebook. NHRA may in its sole and absolute discretion take the action it deems appropriate in response to any such failure to comply.

In addition to imposing any specific sanctions that may be identified herein, the action taken by NHRA may include permanent suspension from NHRA events and/or NHRA member track events; private admonishment; public admonishment; temporary suspension; probation; fines; loss of points won at various events; loss of prize money won at various events; disqualification from competition in an event or events; expulsion from an event; suspension from events; permanent exclusion from NHRA events and/or NHRA member track events; some combination of the foregoing; or such other actions as NHRA shall, from time to time, determine appropriate.

4: FINALITY OF DECISIONS BY EVENT DIRECTOR, DESIGNEES OR OTHER EVENT OFFICIALS

NHRA has provided for a means of review of various NHRA actions and rules. In general, however, there is no provision for review of decisions of the Event Director, the event director's designee(s), or other event officials (collectively

"Event Officials"). The reason such review is not provided is to ensure that there can be finality with regard to events that are run. To provide for an appeal of all actions, inactions or decisions of Event Officials could result in a delay in the determination of literally every event. Such numerous and interminable delays would be disruptive to the sport and unacceptable to participants and spectators. While the decisions, actions or inactions of Event Officials are not appealable, NHRA reserves the right to reverse such decisions or review such actions or inactions on its own initiative if it determines, in its sole and absolute judgment, that such action is warranted.

Event Officials shall have the authority to suspend, disqualify or expel any participant from an event for violation of any of the decisions, rules, or regulations of NHRA. Because Event Officials may take actions which constitute continuing disciplinary action against participants, participants shall have the opportunity to appeal suspensions that last beyond the event in question, and fines, as provided for herein. There is no opportunity to appeal disciplinary actions completed at an event such as suspension, expulsion or disqualification from the event.

5: ASSUMPTION OF RISK AND RELEASE AND WAIVER OF LIABILITY

5.1 ASSUMPTION OF RISK

Drag racing is a dangerous sport that can result in serious injury or death. Participation in all aspects of the sport is voluntary. The ultimate responsibility for participant and vehicle safety lies with the participant, vehicle owner, driver and crew members.

The participant agrees that by entering and participating in an event, the participant has had the opportunity to inspect the event site and acknowledges that the event site is safe and suitable for racing. The participant agrees that he or she will not participate in the event if he or she does not believe that the event site is safe and suitable for racing. The participant further agrees that by entering and participating in an event, the participant has had the opportunity to ascertain the staff and equipment on hand, including without limitation number and location of personnel and number and type of rescue equipment, and acknowledges that the staff and equipment are adequate and suitable for racing. The participant agrees that he or she will not participate in the event if he or she does not believe that the staff and equipment are safe and suitable for racing. The participant also acknowledges that by participating in the event, the participant may suffer bodily injury or death or loss or damage to property. The participant further acknowledges that the participant has voluntarily assumed the risk of bodily injury or death or loss or damage to property and waives any claims for bodily injury or death or loss or damage to property against NHRA, its directors, officers, employees and agents, event officials, event sponsors, racetrack operators and other participants; discharges such persons and entities from responsibility for such losses; and covenants not to sue such persons and entities for bodily injury or death or loss or damage to property.

5.2 RELEASE AND WAIVER OF LIABILITY, ASSUMPTION OF RISK AND INDEMNITY AGREEMENT

All participants shall be required as a condition of participation to sign all required entry forms, including but not limited to such releases as shall be required by NHRA and/or its insurers, consisting of the following or similar wording. Whether or not the participant or the participant's parent(s)/guardian(s) signs such releases, the participant and the participant's

parent(s)/guardian(s) agrees to the terms set forth below and participant and the participant's parent(s)/guardian(s) is hereby put on notice of such terms and makes such agreement either by receiving this Rulebook or by participating in the sport, or both.

The current Jr. waiver is in two parts and both parents are required to sign. Signatures need to be notarized.

IMPORTANT NOTICE

THIS AGREEMENT SHALL APPLY TO ANY AND ALL NHRA AND NHRA MEMBER TRACK EVENTS OR ACTIVITIES ("EVENTS")

PARENT/GUARDIAN RELEASE AND WAIVER OF LIABILITY ASSUMPTION OF RISK AND INDEMNITY AGREEMENT FOR PERSONS UNDER AGE 18

IN CONSIDERATION of ALLOWING MY BELOW-NAMED MINOR CHILD ("the minor") to compete, officiate, observe, work for, or participate in any way in the EVENT(S) or being permitted to enter for any purpose any RESTRICTED AREA (defined as the advanced staging area, burn out area, competition area, shutdown area, staging lanes, return road area, and any other area within the barriers, fences, and/or structures separating the general public from racing activities), I, THE UNDERSIGNED, on behalf of the minor child, for myself individually and for my children, wards, personal representatives, heirs, and next of kin:

1. Represent and agree that I know the nature of the EVENT(S) and the minor's experience and capabilities, and I affirm that the minor is fit and qualified to participate in the EVENT(S).
2. Agree and represent that I and the minor have or will immediately upon entering any such RESTRICTED AREAS, and will continuously thereafter, inspect the RESTRICTED AREAS and further agree and warrant that, if at any time, we are in or about RESTRICTED AREAS and believe anything of any nature to be unsafe or unsatisfactory in any way, we will immediately advise the officials of such and will leave the RESTRICTED AREAS and/or refuse to participate further in the EVENT(S).
3. HEREBY RELEASE, WAIVE, DISCHARGE AND COVENANT NOT TO SUE the promoters, participants, racing associations, sanctioning organizations or any affiliated entities thereof, track operators, track owners, officials, vehicle owners, builders and designers, drivers, crews, rescue personnel, and persons in any RESTRICTED AREA, promoters, sponsors, equipment and parts manufacturers and suppliers, advertisers, owners and lessees of premises used to conduct the EVENT(S), premises and event inspectors, surveyors, underwriters/brokers, consultants and others who give recommendations, directions, or instructions or engage in risk evaluation or loss control activities, regarding the premises or EVENT(S) and for each of them, their directors, officers, agents, and employees, (the "RELEASEES") FROM ALL LIABILITY TO ME, to the minor, and to my children, wards, personal representatives, assigns, heirs, and next of kin, FOR ANY AND ALL LOSS OR DAMAGE, AND ANY CLAIM OR DEMAND THEREFORE ON ACCOUNT OF INJURY TO PERSON OR PROPERTY OR RESULTING IN DEATH ARISING OUT OF OR RELATED TO THE EVENT(S), WHETHER CAUSED BY NEGLIGENCE OF ANY RELEASEE(S) OR OTHERWISE.
4. HEREBY AGREE that if, despite signing this Agreement, I, the minor, or anyone on the minor's behalf, makes a claim for loss or damage against any of the Releasees, I AGREE TO INDEMNIFY AND SAVE AND HOLD HARMLESS the RELEASEES and each of them FROM ANY LOSS, LIABILITY, DAMAGE, FEES OR COSTS they may incur arising out of or related IN ANY MANNER TO MY OR THE MINOR'S ATTENDANCE AT OR PARTICIPATION

IN THE EVENT(S), AND WHETHER CAUSED BY THE NEGLIGENCE OF ANY RELEASEE(S) OR OTHERWISE.

5. HEREBY acknowledge and agree that THE EVENT(S) ARE DANGEROUS and involve the risk of serious injury, death and/or property damage. I also expressly acknowledge that INJURIES RECEIVED MAY BE COMPOUNDED OR INCREASED BY NEGLIGENT RESCUE OPERATIONS OR PROCEDURES OF THE RELEASEES.

6. HEREBY ASSUME FULL RESPONSIBILITY FOR ANY RISK OF BODILY INJURY, DEATH OR PROPERTY DAMAGE arising out of or related to the EVENT(S) whether caused by the NEGLIGENCE OF ANY RELEASEE(S) OR OTHERWISE.

7. HEREBY agree that this Parent/Guardian Release and Waiver of Liability, Assumption of Risk and Indemnity Agreement for Persons Under 18 ("Agreement") extends to ALL acts of negligence by the RELEASEES, INCLUDING NEGLIGENT RESCUE OPERATIONS and is intended to be as broad and inclusive as is permitted by the laws of the State or Province in which the EVENT(S) is/are conducted and that if any portion thereof is held invalid, I agree that the balance shall, notwithstanding, continue in full legal force and effect.

I HAVE READ THIS AGREEMENT, FULLY UNDERSTAND ITS TERMS, UNDERSTAND THAT I HAVE GIVEN UP SUBSTANTIAL RIGHTS FOR MYSELF AND FOR OTHERS BY SIGNING IT, AND HAVE SIGNED IT FREELY AND VOLUNTARILY WITHOUT ANY INDUCEMENT, ASSURANCE OR GUARANTEE BEING MADE TO ME AND INTEND MY SIGNATURE FOR THIS TO BE A COMPLETE AND UNCONDITIONAL RELEASE OF ALL LIABILITY TO THE GREATEST EXTENT ALLOWED BY LAW.

[SIGNATURES OF BOTH PARENTS]
[NOTARIAL BLOCK]

MINOR'S PARTICIPATION AND ASSUMPTION OF RISK STATEMENT ALL EVENTS ALL DATES

I have my parent's permission to participate in this event. "Participate" includes driving, working on cars, helping in some way, being in the "restricted area", or watching the event. I understand that the "restricted area" is a place I need special permission to be in, such as the race track itself and the area close to it. If I don't know if an area is restricted or not, I will ask an event official. I understand that I am assuming the risks of getting hurt during the event, and by signing my name below I state the following:

1. My parents (or guardians) and I believe I am qualified and fit to participate in the event. I will carefully look at the place where this event is being held, and the equipment at this place, and if, at any time, I think ANYTHING is unsafe, I will leave right away and refuse to participate further in the event.

2. I understand that the ACTIVITIES OF THE EVENT ARE DANGEROUS and by participating in the event, there is the RISK AND DANGER that I could be BADLY HURT, PARALYZED OR KILLED. I understand that these risks and dangers can be unexpected. Even though I could get seriously injured or killed in this event, I still want to participate.

3. I know that these risks and dangers may be caused by what I do or fail to do, by the actions or inactions of people participating in the event, by the rules of the event, by the condition and layout of the event location and equipment, and/or by the NEGLIGENCE OR CARELESSNESS of others, including the people responsible for putting on the event.

4. I ASSUME ALL THESE RISKS, EVEN IF THE RISKS ARE CAUSED BY THE NEGLIGENCE OR CARELESSNESS of the promoters, participants,

racing associations, sanctioning organizations, or any of its subdivisions, track operators, track owners, equipment and parts manufacturers and suppliers, officials, car owners, builders and designers, drivers, pit crews, rescue personnel, any persons in any restricted areas, sponsors, equipment and parts manufacturers and suppliers, advertisers, owners, and lessees of premises used to hold the events, premises or event inspectors, surveyors, underwriters, consultants, and any other person or entity who gives recommendations, directions, or instructions, or engages in risk evaluation, loss control activities or sales regarding the premises or events, and each of them, their directors, officers, agents, and employees.

I have read this Statement, I understand it, I have discussed it with my parents (or guardians), I have their permission to sign it, and I agree to make this my own truthful Statement.

[PARTICIPANT'S SIGNATURE]

[SIGNATURE OF PARENT/GUARDIAN]

6: LICENSURE; TECHNICAL INSPECTION; PROTEST PROCEDURES; RETENTION OF VEHICLES AND PARTS

6.1 NHRA LICENSE AND MEMBERSHIP

A license issued by NHRA is to be used only by the driver to whom it is assigned and it is restricted to the categories listed on the license. The license is valid until its expiration date or until revoked by NHRA. The license is intended only to signify that the driver has demonstrated basic qualifications for drag racing classes up to and including the one in which the driver has qualified. The license does not convey a right but rather conveys a revocable privilege to participate in events. A license will not be granted if the driver does not meet the then-current medical criteria set by NHRA's medical professionals. NHRA Summit Racing Jr. Drag Racing League membership is required. Any driver or parent who falsifies, omits, or causes to be falsified or omitted pertinent information on the medical application shall be subject to denial of such application and further disciplinary action including without limitation preclusion from participation in NHRA events. All prescription medications are to be disclosed on a driver's medical application or if subsequently prescribed after prior application approval, the participant must immediately inform the NHRA National Field Office and request approval. Certain medications preclude licensure. Specific medical clearance by NHRA's medical professionals may be granted for selected medications and requests for clearance require the applicant's cooperation in providing requested medical records and history. Application for a competition number after licensure has been declined on medical grounds may similarly be denied.

6.2 TECHNICAL INSPECTION

At a time and place and in a manner determined by Event Officials, prior to racing activities of any nature (including without limitation competition, testing, time trials etc.), all vehicles and driver equipment must undergo a technical inspection, or have been inspected under the Extended Technical Inspection program. In addition, every vehicle is subject to further technical inspection at any time before, during or after an event, at the time and in the place and manner directed by any Event Official. NHRA may at any time inspect, seal for inspection, and/or tear down a participant's vehicle. Not complying in full with any inspection request will result in disqualification for further competition and such other penalties as deemed appropriate by NHRA.

All determinations by Event Officials regarding the timing and method of technical inspection shall be final and not subject to appeal or review. Technical inspection assists Event Officials with determining, in their judgment, eligibility for participation in an event. The technical inspection does not ensure that the vehicle or any part thereof is safe. The technical inspection does not in any way change the fact that the driver, the crewmembers, and the vehicle owner are ultimately responsible for the safety and operation of the vehicle and equipment.

By conducting a technical inspection, NHRA and its member tracks, and each of their respective directors, officers, employees and officials, make no representations, warranties, or assurances that a technical inspection, including the review of any written information, will do any or all of the following:

- 1) Detect every or any problem with a vehicle, or a driver's personal equipment or clothing; or
- 2) Detect every problem with rule compliance; or
- 3) Prevent injury, death or property damage.

The participant agrees that participant bears the ultimate responsibility at all times to ensure the safety of participant's vehicle, equipment and clothing and compliance with all NHRA rules, regulations, and agreements, including but not limited to those contained in the Rulebook. The participant agrees that participant is in the best position to know about the construction and operation of participant's vehicle, equipment, and clothing, and whether there has been compliance with all NHRA rules, regulations and agreements, including but not limited to those contained in the Rulebook. Moreover, in the case of technical violations, the participant acknowledges, understands and agrees that the participant is charged with full knowledge of every component of participant's vehicle and that even if a third party (for example, an engine builder) has caused the participant's vehicle to be noncompliant, the participant will still be responsible for and charged with any applicable violation and sanction. Disclaiming knowledge of the particular part or parts, or disclaiming knowledge of the rule or rules, or disclaiming responsibility for the actions of the third party, will not be defenses to any violation or any sanction therefor.

The weighing and measuring devices used by Event Officials shall be the standards that will determine an engine's or vehicle's compliance with the rules. Any latitude or tolerance must be made by the racer or engine builder.

After a competitor's vehicle has been inspected and classified, no changes of class are permitted. NHRA reserves the right at any time to inspect, seal for inspection, and/or tear down a participant's vehicle. As a general rule, unless optional performance equipment or a performance modification is specifically permitted by this Rulebook, it is prohibited.

In order to facilitate technical inspection, NHRA may, from time to time, accept certain products as having met minimum requirements for technical inspection, test certain elements of vehicles, and certify compliance of such elements as complying with minimum requirements for technical inspections, and take other similar actions. The acceptance or certifications made by NHRA are for the sole purpose of communicating compliance to NHRA technical inspectors, and shall not constitute any warranty, express or implied, including without limitation any warranty of merchantability or fitness for a particular purpose. NHRA intends no other representation by such actions and specifically disclaims any liability or responsibility for any reliance by any person or entity upon such representations, including

but not limited to any incidental or consequential damages that might be claimed as a result of reliance upon such representations. As a general rule, unless optional performance equipment or a performance modification is specifically permitted by this rulebook, it is prohibited.

6.3 RETENTION OF VEHICLES AND PARTS

Participant hereby grants NHRA, its member tracks, and each of their agents and assigns, full and unconditional permission to collect and retain vehicles, parts of vehicles, equipment, or any other items used in conjunction with participation that are owned by or in the possession of participant or present at an event (collectively "items"), including such items that may be relevant incident to the investigation of an incident; the inspection or testing of such items; or for any other purpose. NHRA may exercise this right to take and retain items at any time when NHRA determines in its sole and absolute discretion that such actions are necessary. Participant fully releases NHRA from any liability whatsoever for loss of, damage to, or destruction of any such items. When an item is suspected of being out of compliance with an NHRA rule, or when an item has been involved in an incident, NHRA may in its sole and absolute discretion collect and retain such items if NHRA believes it necessary to do so to further investigate, make a final determination, and/or preserve evidence, all in NHRA's sole and absolute discretion. At any time that NHRA collects and retains items, NHRA will try to safeguard such items and return such items when NHRA has completed its work with them, but NHRA makes no representations or warranties that the items will not be lost, damaged, destructively tested, destroyed or otherwise affected. However, notwithstanding the foregoing sentence, if NHRA believes that an Item should be retained or destroyed, or indefinitely or permanently retained, to prevent further use of such item in competition, NHRA may so retain or destroy such Item. The rights granted to NHRA in this subsection shall also apply to any NHRA member track if deemed necessary by the member track officials.

7: RULE ENFORCEMENT; REVIEW AND APPEALS; EXCLUSIVE MECHANISM FOR DISPUTE RESOLUTION

7.1 ACTIONS AGAINST PARTICIPANTS – INITIAL ACTION

If NHRA is made aware of a violation of the decisions, rules, or regulations of NHRA, NHRA shall determine whether action by NHRA is warranted. Before taking action against a participant NHRA shall, to the extent reasonably practicable, conduct an inquiry concerning the alleged violation, including the collection of relevant information. Where reasonably practicable NHRA will obtain a statement from the participant before taking action, however, it shall not be necessary to receive a statement from the participant prior to initiating action against the participant. Having conducted a review of the information, NHRA shall take whatever action it shall, in its sole and absolute discretion, deem appropriate. NHRA may take immediate action against a participant if NHRA deems such action necessary (e.g., because of danger to participants, spectators, or property, or to avoid continuing violations). Such action may include but is not limited to suspension, disqualification or expulsion of the participant from an event and the event site.

Delivery of Documentation: Deadlines

For any requests, notices and/or documentation to be provided by NHRA and/or the participant pursuant to Sections 7.2 through 7.7 below, the party and place to which such requests, notices and/or documentation are to be sent is as follows:

If to NHRA by overnight carrier:

NHRA Review/Appeals
140 E. Via Verde Suite 100
San Dimas, CA 91773

If to NHRA by email: Appeals@NHRA.com

If to participant by mail, overnight carrier and/or email: The address and/or email address listed on participant's Application for NHRA License and Competition Number Registration. All NHRA requests, notices and/or documentation shall be sent by overnight carrier and/or by email, in NHRA's discretion. Participant understands that if the only available address is a P.O. Box, delivery may be delayed. Participant is responsible for keeping participant's contact information up to date with NHRA.

Requests, notices and/or documentation to be provided by NHRA and/or the participant pursuant to Sections 7.2 through 7.7 shall be deemed received:

- (i) upon actual receipt as shown by proof of delivery when sent by overnight carrier; and,
- (ii) the "sent" date of the email if the email was sent prior to 5 p.m. Pacific Time on a normal business day; or, the next business day if the email was sent after 5 p.m. Pacific Time.

If business exigencies require, in NHRA's sole discretion, all deadlines specified under Sections 7.2 through 7.7 below may be extended or expedited, as deemed appropriate.

7.2 STATEMENT OF ACTION AGAINST PARTICIPANT

When action is taken against a participant a Statement of Action Against Participant will be issued in due course by the Technical Department or another appropriate NHRA department or official depending upon the nature of the alleged violation of any decision, rule or regulation, or of any sanction.

The Statement of Action Against Participant shall outline the violation. The participant will have the opportunity to respond to the Statement of Action Against Participant as described below. No action taken by NHRA shall be automatically delayed pending issuance of the Statement of Action Against Participant, however, NHRA may, in cases where immediacy is not required, provide a reasonable delay in implementation of any action or sanction so that the participant may respond (as outlined below) to the Statement of Action Against Participant before implementation of the action or sanction. Similarly, NHRA may suspend a participant pending investigation and prior to issuing a Statement of Action, in order for NHRA to have sufficient time to conduct an investigation, and where circumstances warrant immediate action in NHRA's sole discretion. Such action shall be called a "Pending Statement of Action."

7.2.1 STAY PENDING APPEAL

A participant who is eligible to and does appeal a suspension or termination of the opportunity to participate in NHRA events, or a fine, may request a stay of the action, in writing, until the review or appeal is concluded.

NHRA will respond in writing and may grant, grant with conditions, or deny the stay in its sole and absolute discretion. Points or awards obtained during a stay may be lost if the appeal is not successful or if otherwise deemed

appropriate by NHRA. NHRA may revoke a stay during the pendency of the review or appeal if NHRA deems such revocation appropriate and in the best interests of NHRA or the sport of drag racing. A participant suspended, disqualified or expelled from an event will not be permitted to compete at the same event by filing an immediate request for review or appeal.

7.2.2 COMPLIANCE AND PUBLICATION

Except during the pendency of a stay as provided in Section 7.2.1 if a participant is required to pay a fine or take any remedial action, the participant may be suspended from NHRA events and/or NHRA member track events until the fine is paid or the remedial action taken. Failure to pay fines or take remedial action in a timely fashion may result in additional action being taken by NHRA. NHRA may deduct fines owed by the participant to NHRA from any prize money owed to a participant.

NHRA at all times may publish in *Jr. Dragster*, jrdragster.NHRA.com, and on NHRARacer.com, or anywhere else, information regarding all or part of any Statement of Action Against Participant, including without limitation suspension, disqualification, expulsion and/or fines, and all related items including appeals and results of appeals. Publication may occur whether or not an appeal may be or has been filed. Participants agree that they shall not initiate any legal action against NHRA as a result of any such publication.

7.3 ACTIONS AGAINST PARTICIPANTS – PARTICIPANT’S RESPONSE

As a first step in the appellate process regarding any appealable violation of any NHRA rule, regulation or decision, the participant may respond, in writing, which writing must be received by NHRA within **ten (10) business days** of the date of the Statement of Action Against Participant, to the Statement of Action Against Participant, explaining the participant’s position and the basis therefor (“Participant’s Response to Statement of Action Against Participant”). If the participant submits a Participant’s Response to Statement of Action Against Participant, NHRA will evaluate it, and NHRA may, in its sole and absolute discretion, modify the action to be taken against the participant if it determines that a different action or no action is warranted. Within **ten (10) business days** of NHRA’s receipt of the Participant’s Response to Statement of Action Against Participant, NHRA shall respond to the Participant’s Response to Statement of Action Against Participant in writing, unless NHRA requires more time to conduct any investigation or analysis it deems necessary, in which case NHRA shall respond as promptly as practicable under the circumstances (“NHRA’s Response to Statement of Action Against Participant”). If applicable, NHRA’s Response to Statement of Action Against Participant shall advise the participant of participant’s right to further appeal the decision, as set forth below.

7.4 ACTIONS AGAINST NHRA; APPEAL OF NHRA DECISIONS

As stated in Section 4, decisions of Event Officials as described in Section 4 shall not be subject to review or appeal. In addition, rule changes that are technical in nature (e.g., acceptable and/or mandatory parts and/or modifications, changes made to address safety issues, changes made to equalize performance or control performance, changes made to balance competition) shall not be subject to review or appeal. Whether a rule change is technical in nature and not subject to review or appeal shall be determined in the sole and absolute judgment of NHRA.

Other than as set forth above, if an individual or other entity is directly

affected by and is the subject of a decision, ruling, action, or failure to act of NHRA, including but not limited to disciplinary action, the individual or entity will be allowed to appeal the decision, ruling, action or failure to act of NHRA. Such appeals shall be undertaken as provided in this section.

At any stage of appeal, the panel reviewing the decision, ruling, action or failure to act at issue shall not include individuals who were involved in the initial decision, ruling, action or failure to act or individuals who have a personal interest in the decision of the reviewing panel.

Failure to comply with any appeal procedure herein will constitute a waiver of the appeal associated with the procedure and any subsequent review or appeal. For participants who have received a Statement of Action Against Participant, the first step in the appellate process is submission of the Participant's Response to Statement of Action Against Participant, as set forth in Section 7.3. For participants appealing a decision of NHRA for which no Statement of Action Against Participant was issued, the first step in the appellate process is submission of the Notice of and Grounds for Appeal, as set forth in Section 7.5.

7.5 NOTICE OF AND GROUNDS FOR APPEAL

If a participant has received and responded in writing to a Statement of Action Against Participant, and wishes to appeal an appealable decision set forth in NHRA's Response to Statement of Action Against Participant, the participant must submit a written Notice of and Grounds for Appeal to NHRA so that it is received by NHRA within **ten (10) business days** of the date of NHRA's Response to Statement of Action Against Participant. The Statement of Action Against Participant will indicate the person or department of NHRA to whom the response should be directed. For those participants appealing a decision of NHRA for which no Statement of Action Against Participant was issued (for example, a decision not involving a disciplinary or rule violation matter), the participant must submit a written Notice of and Grounds for Appeal so that it is received by NHRA within **fifteen (15) business days** of the date of the NHRA action the participant wishes to appeal.

The Notice of and Grounds for Appeal must state specifically what decision or action is being appealed and the grounds for the appeal (i.e., why the decision or action should be changed). The Notice of and Grounds for Appeal, and the Final Appeal, if applicable, shall include a filing fee pursuant to the schedule shown below.

Notice of and Grounds for Appeal Filing Fee:

Up to but not including Final Appeal Level. \$1,000

Final Appeal Filing Fee:

Final Appeal level \$1,000

If the participant seeking review prevails in total, then the Notice of and Grounds for Appeal Filing Fee shall be refunded in total. Otherwise, there shall be no refund, and NHRA or the appellate panel may assess NHRA's and the panel's costs on appeal against an appealing participant who does not prevail, which costs must be paid before further participation in NHRA drag racing as set forth in Section 7.2.2.

The Notice of and Grounds for Appeal should include, to the maximum extent possible, all documents and other evidence that the participant believes substantiates the participant's position and that the participant wishes to have considered by NHRA. The Notice of and Grounds for Appeal should include the following:

- A summary of the underlying facts
- The grounds for the appeal including why the appeal is being made
- The issues to be reviewed
- The rule(s), decision(s) or action(s) involved
- The identity of any witnesses, and what each witness would be expected to say, and/or witness statements
- Any citations from the Rulebook or elsewhere that participant believes are relevant
- Other information that the participant believes relevant.

Within **twenty (20) business days** of NHRA's receipt of the Notice of and Grounds for Appeal, the appropriate NHRA representative(s) shall submit the following to the Reviewing Panel (as defined in Section 7.6 below), and provide a copy of the same to the appealing participant (the "Appeal Summary"):

- A summary of the underlying facts, including the background and prior proceedings (if any) and the basis for the original decision
- The issues to be reviewed
- The rule(s), decision(s) or action(s) involved
- The identity of any witnesses, and what each witness would be expected to say, and/or witness statements
- Any citations from the Rulebook or elsewhere believed to be relevant
- Other information believed relevant

7.6 REVIEW PANEL

Within **thirty (30) business days** of NHRA's receipt of any Notice of and Grounds for Appeal, at least three individuals designated to be members of the NHRA Review Panel (which members shall be referred to as the "Reviewing Panel") shall convene and shall review the existing record, including all evidence and materials submitted by the participant with participant's Notice of and Grounds for Appeal and all evidence and materials submitted by the appropriate NHRA representative(s) (the "Review Panel Meeting").

The Reviewing Panel shall review the Notice of and Grounds for Appeal. The procedure followed by the Reviewing Panel shall be informal, shall be guided by the chair of the Reviewing Panel, and shall be conducted with the goal of promptly and fairly reaching resolution of the appeal. The Reviewing Panel may, if it deems it appropriate, arrange a meeting or conference call with the aggrieved participant and/or the other concerned parties or witnesses, and also may question witnesses, call additional witnesses, call for additional information or evidence, and/or conduct informal investigation outside the hearing. The appealing participant and other participants called on for information shall cooperate with the Reviewing Panel's requests and shall be subject to discipline for failure to cooperate. The Reviewing Panel shall not be required to follow formal or statutory rules of evidence or procedure.

The Reviewing Panel may take such action as it deems appropriate, including but not limited to increasing or decreasing penalties that have been imposed by NHRA. Within **twenty (20) business days** of the Review Panel Meeting, the Reviewing Panel shall complete its review and render its decision in writing to the appealing participant ("Review Panel Decision"). Notwithstanding the foregoing, the Reviewing Panel reserves the right to take more time to conduct any investigation or analysis it deems necessary. If such investigation will cause the Review Panel Decision to be rendered more than 30 days after the Review Panel hearing, the appellant shall be so notified.

7.7 FINAL APPEAL

If the participant alleges the Review Panel Decision was in error, the participant may submit a Notice of Appeal of Review Panel Decision which must be accompanied by the applicable Final Appeal Filing Fee (provided for in Section 7.5 above), and must be received by NHRA within **ten (10) business days** of the date of the Review Panel Decision. This is the third stage of review for those appealing a decision where a Statement of Action Against Participant was rendered, and the second stage of review for others. This stage of review shall be the final appeal ("Final Appeal").

With the submission of Appellant's Final Appeal papers, appellant may request a waiver of the Final Appeal Filing Fee, in writing, if genuine hardship exists. Appellant must set forth the grounds for the fee waiver request, which shall be granted or denied in NHRA's sole discretion. If a fee waiver is sought, the matter shall be stayed until the fee waiver issue is resolved.

If the participant seeking the Final Appeal prevails in total, then the Final Appeal Filing Fee and the Notice of and Grounds for Appeal Filing Fee shall be refunded in total. Otherwise, there shall be no refund, and NHRA or the Final Appeal Panel may assess NHRA's and the Final Appeal Panel's costs on appeal against an appealing participant who does not prevail, which costs must be paid before further participation in NHRA drag racing as set forth in Section 7.2.2.

The Notice of Appeal of Review Panel Decision submitted by the appellant must contain all information on which the appellant relies for the appeal including without limitation a list of witnesses and evidence to be presented at the Final Appeal Hearing, and must state all reasons why the appellant is seeking further appeal including any errors claimed by appellant to have been made by the Review Panel.

Within **twenty (20) business days** after receipt of a Notice of Appeal of Review Panel Decision, NHRA will appoint a three-member appellate panel and disclose the identities of such panel to the appealing participant, which shall be comprised of the following: one member of NHRA's management staff, and two members of the racing community who are not current NHRA employees ("Final Appeal Panel"). The non-NHRA employee members of the Final Appeal Panel shall meet the following requirements: (a) they shall not have been involved as a competitor of the participant in NHRA events in the given calendar year; (b) they shall not have a personal financial interest in the outcome of the Final Appeal; and (c) they shall not have an actual conflict of interest with the appealing participant.

The appealing participant shall have **five (5) business days** after the date of disclosure of the identities of the members of the Final Appeal Panel to object, if the participant chooses, to the composition of the Final Appeal Panel in writing and stating the grounds for such objection. NHRA shall have **fifteen (15) business days** from the date of NHRA's receipt of the participant's objection to the Final Appeal Panel to respond to such objection, if any, by either reconstituting the Final Appeal Panel or by rejecting the objection as untimely or unfounded. The time for conducting the Final Appeal shall be adjusted if deemed necessary because of an objection. If any member of a reconstituted Final Appeal Panel is challenged, the same timeline shall apply.

The decision of the Final Appeal Panel shall be final and binding on all of the parties and not subject to further review.

The date of the Final Appeal Hearing shall be no more than **forty-five (45) calendar days** from the date of NHRA's receipt of the Notice of Appeal of

Review Panel Decision, unless adjusted because of an objection to the Final Appeal Panel. The date, time and place for the Final appeal Hearing shall be set by the Final appeal Panel and shall be provided to the appealing participant with the disclosure of the Final Appeal Panel. No later than **ten (10) days prior** to the date of the Final Appeal Hearing, NHRA shall provide the appellant and the Final Appeal Panel with a list of witnesses and evidence to be presented at the Final Appeal Hearing. Either party may supplement with further information but all efforts should be made to be complete at the party's designated time to provide information.

Prior to the Final Appeal Hearing the Final Appeal Panel will review whatever information has been provided to it by each side. At the Final Appeal Hearing, the appealing participant must personally appear and participate and cooperate in the proceeding, and may also bring counsel who also may participate in the proceeding on behalf of the appealing participant. All such participation by the participant and counsel, and any witnesses appellant wishes to appear in person, shall be at the appealing party's sole cost and expense. NHRA shall attempt to accommodate scheduling conflicts with regard to the date and time of the Final Appeal Hearing, however, NHRA reserves the right to unilaterally set the date and time for the hearing if attempts to cooperatively schedule with appellant fail, in NHRA's sole and absolute discretion. The appealing participant and NHRA may present witnesses and documentary or other evidence. All witnesses, including the appealing participant, may be questioned by the Final Appeal Panel. The appealing participant and the NHRA representative(s) may also review the evidence presented against each side and may question adverse witnesses. The Final Appeal Hearing will proceed, in general, as follows:

- Introduction of Final Appeal Panel
- Statement by NHRA representative(s) regarding issue at hand
- NHRA witnesses and evidence
- Statement by appellant of basis for appeal
- Appellant's witnesses and evidence
- Responsive statements and evidence by each party, as necessary

The Final Appeal Hearing proceeding is informal and shall not be conducted as an adversary proceeding. The Final Appeal Panel shall determine the most effective procedures for developing the relevant facts and arriving at a conclusion. The Final Appeal Panel may question witnesses, call additional witnesses, call for additional information or evidence, and/or conduct informal investigation outside the hearing. The appealing participant and other participants called on for information shall cooperate with the Final Appeal Panel's requests and shall be subject to discipline for failure to cooperate. The Final Appeal Panel shall not be required to follow formal or statutory rules of evidence or procedure. In considering an appeal, it may be necessary for the Final Appeal Panel to call various participants to appear at the Final Appeal Hearing. Failure to comply with a request by the Panel to appear at such a hearing shall subject a participant to disciplinary action as may be determined appropriate by NHRA.

At the conclusion of the Final Appeal Hearing, the Final Appeal Panel may render a decision or may take the matter under advisement and render a decision at a later date. The decision of the Final Appeal Panel shall be rendered no later than **thirty (30) calendar days** of the Final Appeal Hearing unless additional time is required by the Final Appeal Panel to gather important and relevant information. The decision of the Final Appeal Panel shall be in writing and shall state the basis of the decision. The Final Appeal Panel may take such action as it deems appropriate, including but not limited to increasing or decreasing penalties that previously have been imposed.

The participants to the appeal agree that the determination of the Final Appeal

Panel shall be final and shall not be further appealable to the NHRA or to any court, it being agreed that the dispute resolution procedures provided for herein are the exclusive remedy for the redress of grievances. However, if and to the extent that the Final Appeal Panel makes any ruling that changes the results of races, the awarding of points or the awarding of prize money, that portion of the decision must be approved or disapproved by the President of NHRA.

8: PUBLICITY

In consideration of being allowed to enter and by being issued credentials to an NHRA event or an event at an NHRA member track, the vehicle owner, the vehicle driver, crewmembers, extra crewmembers, advertisers, sponsors, and other holders of event credentials (the "participants") agree as follows:

- 1) All rights to use still or audio-visual images, or sounds from the events for any purpose, such as advertising, promotion, exhibition, and commercial exploitation of the event, the participants and vehicles entered in the event, and their activities at the site of the event before, during, and after the event and reasonably related to the event, are reserved to NHRA, its licensees and assigns;
- 2) Participants hereby grant NHRA, its licensees and assigns (a) full and unconditional permission to make still or motion pictures and any other type(s) of audio or audio-visual recordings of their and their vehicle's participation in the event and their activities at the site of the event before, during, and after the event and reasonably related to the event; and (b) the exclusive, worldwide and perpetual rights to use any and all recordings or portions thereof, together with their names, likenesses, and biographies, and the names, likeness, and data of, or relating to, their entered vehicles and any other information concerning their participation as collected or generated by NHRA for any purpose, in any form, on any platform, on any media by any and all means now known or hereafter developed.
- 3) Participants agree: (a) that, without the prior written consent of NHRA, they shall not take any still or motion pictures or make any audio or audio-visual recording of the event, participants therein, or activities at the site of the event for use other than personal, in-home use of the participant, or cause or permit others to do so or to use any pictures or recording or event related data compilations from the event; (b) that NHRA shall have exclusive, worldwide, and perpetual use of any pictures or recordings, or event related data compilations made or used in violation of this paragraph; and (c) that NHRA shall be irreparably harmed by the making or use of such pictures, recordings or data compilations without such permission.
- 4) Participants agree that, without the prior written consent of NHRA, they shall not offer for sale, sell, give away, or otherwise distribute at the site of the event any token, any souvenir, any product, or thing of value, or permit others to do so, and that NHRA shall be irreparably harmed by a violation of this paragraph.
- 5) Participants represent and warrant that they have obtained agreement to the above provisions of Section 8 from any person contributing to or participating on their team; and that they have or have obtained from any person or entity whose intellectual property, logos, brands, service marks or trademarks appear on their vehicles any and all rights, clearances and permissions necessary for NHRA, its licensees and assigns, to exploit the distribution rights to sounds and images, still or audio-visual content, of the event for any purpose, in any form, on any platform, on any media and by any and all means now known or hereafter developed. Participants shall promptly provide written evidence of such rights, clearances and permissions to NHRA upon request.
- 6) Participants acknowledge NHRA's sole right to license, publish, distribute and exploit any data or statistics compiled relating to the events or

their participation in the events, whether generated by using the NHRA scoring and timing systems or otherwise, in any form, live or in a compilation, in perpetuity, however, NHRA grants permission for participants to use their own data for non-commercial purposes.

9: PROPRIETARY RIGHTS

NHRA owns all rights in the "National Hot Rod Association" and "NHRA" name and marks, which are registered with the United States Patent and Trademark Office (Registration Nos. 2,220,219; 2,221,363; 1,293,428; and 1,295,041). In addition, the names National Hot Rod Association, NHRA, NHRA Camping World Drag Racing Series, NHRA Full Throttle Drag Racing Series, NHRA Lucas Oil Drag Racing Series, NHRA Summit Racing Series, NHRA Championship Drag Racing, the "Wally" name and trophy, Countdown to the Championship and its variations, and other names used by NHRA, and all NHRA trademarks, service marks and trade names, as well as all associated marks, logos, designs, emblems, slogans and indicia, and the images and sounds created by and used by NHRA racing and events (collectively "NHRA Property"), are the property of NHRA or used by permission. The NHRA Property (or any colorable imitation, variation or adaptation thereof) is subject to federal and state statutory and common law trademark and copyright protections. Use of any NHRA Property without permission is prohibited. Racers and race teams are granted a nonexclusive license with no right of assignment or sublicense to use the "National Hot Rod Association" and "NHRA" marks, and Series marks as specified and required in this Rulebook, on certain items such as team uniforms and race vehicles, for race team use solely in connection with NHRA racing and events and not for use on point of sale materials or any item that is sold or resold unless pursuant to a separate written license agreement with NHRA. For guidance on permitted logo usage consult the NHRA Marketing Department. Commercial use of any NHRA Property without permission is strictly prohibited. All use of NHRA Property shall inure to the benefit of NHRA.

Photo credentials governed by NHRA Photo Policy; strict compliance required; noncompliance may result in permanent denial of credential requests. Policy available from NHRA Media, 626-914-4761. Media photography restricted to news use only. Commercial photography of any means or nature without prior written consent of NHRA prohibited. To inquire about license/access agreements or to license footage, email ip@nhra.com.

Any commercial activity on site at an NHRA event is subject to the approval of NHRA and may be discontinued, and the participating parties made to leave the premises, if the activity is not approved or deemed not in the best interests of the sport.

RACE PROCEDURES

Each Jr. Dragster must complete and satisfactorily pass inspection by the Technical Services Department before being allowed to make a trial run or participate in any event conducted at an NHRA member track (this includes private test sessions).

Throughout this Rulebook, a number of references are made for particular products to meet certain specifications (i.e., SFI Specs, Snell, DOT, etc.). It is important to realize that these products are manufactured to meet certain specifications, and upon completion, the manufacturer labels the product as meeting that spec. Therefore, except as outlined under SFI requirements, any change to the product voids that certification.

Under no circumstances may any certified product be modified, altered, or in any way vary from the "as manufactured" condition. Such a

practice is in violation of the SFI, Snell, DOT, etc. program, voids such certification and therefore will not be accepted by NHRA.

NOTICE: It is the responsibility of the participant, not NHRA or any track, to ensure that all safety equipment is approved and is correctly installed, worn, maintained, and used.

EVENT PARTICIPATION

In the NHRA Summit Racing Jr. Drag Racing League, one car may be shared by more than one driver. In such cases, it is the total responsibility of the participant to appear for races in a timely manner when called by race officials. A contestant cannot drive more than one Jr. Dragster in the same category at the same event. Each driver/car combination is considered a separate entry and any applicable fees must be paid for each entry.

The event director has the option of permitting driver or vehicle changes. Such changes must be made prior to eliminations.

1. All previous event times are void for vehicles and drivers involved.
2. Vehicle must pass a technical and safety inspection.
3. Changes must be made and driver take time trials during the normal schedule, as posted, for the event. No changes are permitted once pre-event time trial or qualifying is completed.
4. Driver must stay within original category entered and have the proper credentials to drive the replacement vehicle.
5. Only one change permitted during the course of an event.

Vehicle changes for a postponed event are permitted with advance notification and approval of the event director. No such changes are allowed for races halted in progress and then completed on a subsequent date.

DIAL-IN

During handicap E.T. bracket-style racing, each competitor must post his or her desired dial-in on his or her car in a manner clearly visible to the tower and available to his or her opponent. Reader boards must be attached to the car. Dial-in cannot be changed after the track-designated "ready line."

LANE CHOICE

If necessary, lane choice will be determined by a coin flip or random draw.

BURNOUTS

All pre-race burnouts are restricted to designated areas, using water only. If a contestant's car should break on a burnout and cannot be pushed back, it is not permitted to turn on the track and drive back to the starting line. Crossing the centerline during a burnout is not a disqualification. Fire burnouts are strictly prohibited. No person is permitted to hold or touch cars during burnouts.

STAGING

Once a car reaches the front of the staging lanes for a run, it must be prepared to fire and race. To be a legitimate race winner, a contestant's car must start and self-stage. This rule also applies to single runs. Push-staging any vehicle is prohibited. Staging must be done under the vehicle's own engine power. If a vehicle loses fire and the opponent has been sent on a single run, the vehicle losing fire may not restart and the run is forfeited.

The application or use of any device, mechanical or electronic, that permits the driver to ascertain the position of his or her vehicle in relation to the starting line is prohibited. Only visual observation of track equipment may be used to ascertain the vehicle's position.

If both drivers of a race leave the line before the start system is activated, the driver leaving first is disqualified. If unable to determine who left first,

both drivers are disqualified. Any e.t.s posted would be void for lane choice or other consideration. A driver on a single run would advance.

THE FINAL STAGING MOTION, USING APPLIED POWER, MUST BE IN A FORWARD MOTION GOING FROM PRE-STAGE TO STAGE POSITION. A reasonable amount of time will be permitted for drivers to stage. The time limit will be determined at the sole and absolute discretion of the official starter. Failure to stage upon the starter's instructions is possible grounds for disqualification. After proper staging and receiving the starter's signal to go, re-staging for a second time is prohibited. Any driver leaving the starting line before the start system is activated, including a driver on a single run, will have his or her time disqualified for the run.

BREAKOUT RULES

Breakout rules are enforced as follows: Contestants who race below their dial-in or posted index (subject to performance barrier rules listed under Class Designations) during eliminations are disqualified, with the following exceptions:

1. When an opponent foul starts or crosses a boundary line.
2. On a single run.
3. When both drivers run under their dial-in or indexes, the driver who is the least under is the winner.
4. If two contestants run under by the same margin (with elapsed times extended to a thousandth of a second), the driver crossing the finish line first is the winner.

See individual classes for breakout limits

SINGLE RUNS

In situations where a driver is making a single run, he or she is considered the winner once he or she stages and receives the start signal. Drivers who run under elapsed time barriers outlined above are disqualified even if on a single run.

DISQUALIFICATIONS

Discovery of any device, action, or operation not included in this Rulebook or in conflict with rules contained within this Rulebook is grounds for immediate disqualification.

One of the rarities at a Jr. drag racing event is the situation in which two cars are disqualified during the same elimination race. In most cases, both offending contestants are disqualified. Those situations include both drivers crossing the boundary lines or both drivers leaving the line before the start system is activated.

Should a driver receive a red-light foul start and the opposing driver cross the lane boundary line, the latter infraction would prevail, and the driver committing the foul start would be reinstated. In determining lane-boundary-crossing violations, it is considered a disqualification when any portion of a tire completely crosses the painted line surface. In cases where both opponents cross the centerline or outside line, both drivers will be disqualified. In situations where multiple boundary lines are utilized, the line directly adjacent to the competitor's racing lane will be used for reference. Anytime it has been judged that excessive braking has resulted in the loss of control as to cause contact with the guardwall, light fixtures, or crossing the center boundary lines — **INCLUDING PAST THE FINISH LINE** — the contestant will be disqualified. Contact with guardwall, barriers, or any other track fixture (rubber cones, when used, are considered visual aids, not fixtures) is grounds for disqualification and/or other actions. Intentional crossing of boundary lines to leave track or avoid depositing debris on track is not grounds for disqualification.

Any driver and/or crewmember found to be under the influence of alcoholic beverages or drugs, regardless of amount, will be ejected from the event. Such a condition is cause for suspension, fine, and/or revocation of competition privileges.

Notwithstanding any other provision of this Rulebook, participation in any program conducted by or in conjunction with NHRA is conditioned upon being in good standing with NHRA, as determined in NHRA's sole and absolute discretion. Any person found guilty of drug-related offenses or other serious offenses is subject to such disciplinary action as NHRA shall determine appropriate in its sole and absolute discretion, including but not limited to immediate expulsion from NHRA and/or the NHRA Summit Racing Jr. Drag Racing League and a termination of good standing. Such person may be immediately excluded from all NHRA and/or NHRA Summit Racing Jr. Drag Racing League programs and may not be eligible for titles, prize money, or other awards that have not already been bestowed, as shall be determined by NHRA. Further, any annual awards that might be granted may be made contingent upon maintaining good standing with NHRA through the year following the annual award, if so determined by NHRA. Further still, any person who shall be facing prosecution for a drug-related offense or other serious offense may be granted such awards on a contingent basis and may not be eligible for annual awards of prize money unless and until he or she shall not have been found not guilty of such offenses during the year following the award of such prizes if so determined by NHRA.

WEIGHING OF VEHICLE/FUEL CHECK

Under no circumstances may a competitor reject scaling his/her vehicle or fuel check. Any competitor who fails to report to post-run inspection (scales or fuel check) will be disqualified from the event and will be subject to additional disciplinary action in the sole and absolute discretion of NHRA.

USE OF SAFETY EQUIPMENT

Seat belts must be worn and adjusted in such a manner that the driver's torso and head cannot extend outside the parameters of the roll cage. Drivers are also required to properly use safety equipment until the vehicle exits the racing surface and the vehicle is no longer moving. Seat belts, arm restraints, helmets, gloves, neck collars, and face shields must be worn until the vehicle has been shut off. Violators will be subject to disciplinary action in the sole and absolute discretion of NHRA.

LOGO PLACEMENT

All vehicles participating in an NHRA Summit Racing Jr. Drag Racing League event conducted by NHRA or at NHRA member tracks must prominently display the applicable logo as required (see illustration) to be eligible for competition. Logos must be properly displayed to enter an event, to pass technical inspection, and to make any runs. Logos must continue to be properly displayed at all times during the conduct of any event. Vehicle must display the NHRA Summit Racing Jr. Drag Racing League logo on both sides of the race vehicle at all times during any event.

Required logo placement is acceptable in the highlighted area.

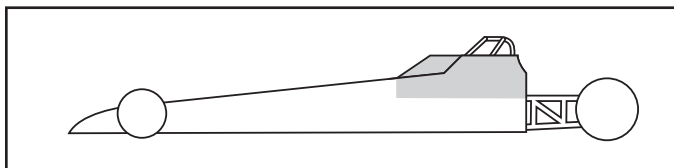

JR. DRAGSTER RULES AND REGULATIONS

The NHRA Summit Racing Jr. Drag Racing League is a multifaceted program designed to afford youth as young as 5 years old the opportunity to drive in the League and those 6 and older the opportunity to race against their peers in near replicas of the models that the Pros drive. NHRA Jr. drag racing is restricted to competition in half-scale sized dragsters over a maximum distance of an eighth-mile. Competition is designed to be conducted on an e.t. dial-your-own format or a preset index on a heads-up breakout basis. Actual class or age-group breaks may vary from track to track. Contact your local track to see if it participates in the program and if so, for information on class structure. Each track, in its discretion, may set its own age requirements for participation (for example, a track may allow only those 8 and older to participate).

Consistent with its endeavor to maintain simplicity and cost controls of the NHRA Summit Racing Jr. Drag Racing League, NHRA will continue to monitor elapsed times and speeds and may in time implement additional e.t. and speed limits.

CLASS DESIGNATIONS

AGE REQUIREMENTS: Drivers may enter the NHRA Summit Racing Jr. Drag Racing League on the day of their 5th birthday in the noncompetitive Trainee category. Drivers may compete in the Jr. Drag Racing League from the day of their 6th birthday through the year of their 18th birthday. **All Jr. Drag Racing League participants must submit a certified birth certificate on all new participant registration. Subsequent renewals do not require resubmission of certified birth certificate or notarized copy of birth certificate.** Willfully falsifying NHRA membership and/or participation documents for any reason including avoiding age restrictions will be grounds for denial of license, suspension or revocation of license, or other action deemed appropriate by NHRA in NHRA's sole and absolute discretion, including but not limited to exclusion from the NHRA Jr. Drag Racing League Eastern/Western Conference Finals. Driver must be the minimum age for the Age Group class (i.e., to run in the 10-year-old class, the driver must have already celebrated his or her 10th birthday). Likewise, a driver can compete in a lower Age Group class if his or her birthday falls after Jan. 1 of the current year (i.e., a driver who turned 13 on July 1 can compete as a 12-year-old through the entire calendar year).

TRAINEE: age 5; elapsed time restricted to 20.00 seconds or slower; no racer can run quicker than 20.000. Limited to noncompetition, single passes. Engine restricted to factory-sealed Briggs & Stratton 206 crate engine (part no. 124332 8201) with red slide valve (part no. 555733), or an electric powered motor meeting the rules found in the Electric-Powered Jr. Dragster section of this rulebook. An NHRA accepted voltage regulator may be required in the future. If the racer runs faster than 20.00 seconds, he or she will be disqualified for the remainder of the event and may face further action deemed appropriate by NHRA in NHRA's sole and absolute discretion.

YOUTH: ages 6 and 7; dial-in restricted to 13.90 seconds or slower based on either an e.t. dial-your-own or heads-up basis; breakout rules apply. In qualified events, no racer can qualify quicker than 13.900.

Any competitor running quicker than 13.70 e.t. in the eighth-mile or 7.00 e.t. in 330 feet at any time during an event generally will receive one warning unless the race director feels further action would be appropriate. If the same competitor runs quicker than 13.70 e.t. in the eighth-mile or 7.00 e.t. in 330 feet again at the same event, he or she will be disqualified for the remainder of the event and may face further action deemed appropriate by NHRA in NHRA's sole and absolute discretion. Any competitor running quicker than 13.50 e.t. in the eighth-mile or 6.80 e.t. in 330 feet at any time during an event will be immediately disqualified for the remainder of the event and may face further action deemed appropriate by NHRA in NHRA's sole and absolute discretion. Penalties will be imposed regardless of whether the infraction(s) occur during time trials or eliminations. See also Breakout Rules in Race Procedures. Engine restricted to factory- sealed Briggs & Stratton 206 crate engine (part no. 124332 8201) with blue slide valve (part no. 555734), or an electric powered motor meeting the rules found in the Electric-Powered Jr. Dragster section of this rulebook. An NHRA accepted voltage regulator may be required in the future.

NOVICE: ages 8 and 9; dial-in restricted to 11.90 seconds or slower based on either an e.t. dial-your-own or heads-up basis; breakout rules apply. In qualified events, no racer can qualify quicker than 11.900. Any competitor running quicker than 11.70 e.t. in the eighth-mile or 6.10 e.t. in 330 feet at any time during an event will receive one warning unless the race director feels further action would be appropriate. If the same competitor runs quicker than 11.70 e.t. in the eighth-mile or 6.10 e.t. in 330 feet again at the same event, he or she will be disqualified for the remainder of the event and may face further action deemed appropriate by NHRA in NHRA's sole and absolute discretion. Any competitor running quicker than 11.50 e.t. in the eighth-mile or 5.90 e.t. in 330 feet at any time during an event will be immediately disqualified for the remainder of the event and may face further action deemed appropriate by NHRA in NHRA's sole and absolute discretion. Penalties will be imposed regardless of whether the infraction(s) occur during time trials or eliminations. See also Breakout Rules in Race Procedures.

INTERMEDIATE: ages 10 to 12; dial-in restricted to 8.90 seconds or slower based on either an e.t. dial-your-own or heads-up basis; breakout rules apply. In qualified events, no competitor can qualify quicker than 8.900. Any competitor running quicker than 8.70 e.t. in the eighth-mile or 4.70 e.t. in 330 feet at any time during an event will receive one warning unless the race director feels further action would be appropriate. If the same competitor runs quicker than 8.70 e.t. in the eighth-mile or 4.70 e.t. in 330 feet again at the same event, he or she will be disqualified for the remainder of the event and may face further action deemed appropriate by NHRA in NHRA's sole and absolute discretion. Any competitor running quicker than 8.50 e.t. in the eighth-mile or 4.50 e.t. in 330 feet at any time during an event will be immediately disqualified for the remainder of the event and may face further action deemed appropriate by NHRA in NHRA's sole and absolute discretion. Penalties will be imposed regardless of whether the infraction(s) occur during time trials or eliminations. See also Breakout Rules in Race Procedures.

ADVANCED: ages 13 to 18; dial-in restricted to 7.90 seconds or slower based on either an e.t. dial-your-own or heads-up basis; breakout rules apply. In qualified events, no competitor can qualify quicker than 7.900. See also Breakout Rules in Race Procedures.

Any competitor running quicker than 7.50 e.t. in the eighth-mile or 4.10 e.t. in 330 feet or faster than 85.00 mph at any time during eliminations will be disqualified from the event.

Any competitor running quicker than 7.50 e.t. in the eighth-mile or 4.00 e.t. in 330 feet or faster than 89.99 mph at any time during time trials or qualifying will be disqualified from the event and will be subject to additional disciplinary action in the sole and absolute discretion of NHRA.

MASTER: Ages 18 and higher; dial-in restricted to 7.90 seconds or slower based on either an e.t. dial-your-own or heads-up basis; breakout rules apply. In qualified events, no competitor can qualify quicker than 7.900. See also Breakout Rules in Race Procedures.

Any competitor running quicker than 7.50 e.t. in the eighth-mile or 4.10 e.t. in 330 feet or faster than 85.00 mph at any time during eliminations will be disqualified from the event.

Any competitor running quicker than 7.50 e.t. in the eighth-mile or 4.00 e.t. in 330 feet or faster than 89.99 mph at any time during time trials or qualifying will be disqualified from the event and will be subject to additional disciplinary action in the sole and absolute discretion of NHRA.

CREDENTIALS

Valid NHRA Jr. Master license required. License requires test runs and witnesses.

REQUIREMENTS AND SPECIFICATIONS

ENGINE: 1

CAMSHAFT

Any camshaft permitted; no overhead valves, no overhead cams. Any size valve permitted. Any valve spring permitted.

ENGINE

All vehicles restricted to a maximum of one rear-mounted – based on a five-horsepower, single-cylinder, single-spark-plug, flathead-configured, four-cycle engine or factory-sealed Briggs & Stratton 206 crate engine – engine from a recognized OEM or NHRA-accepted aftermarket supplier. Must be NHRA accepted. NHRA-accepted aftermarket block permitted. Must retain original five-horsepower engine block configuration. Porting, polishing, and relieving of block; boring of cylinder; machining of deck surface permitted. Aftermarket head permitted. Adding material to deck surface, installing a spacer between the block and cylinder head, or any other modification designed to increase the effective deck height of the cylinder prohibited. Briggs & Stratton 206 crate engine must maintain untampered hologram seal installed at the factory. No alterations or modifications to Briggs & Stratton 206 crate engine permitted except for installation of exhaust header and air filter.

Accepted aftermarket engines for Novice, Intermediate, Advanced and Master classes: Metro Racing flathead, McGee Racing flathead, Tecumseh flathead, LPW Racing Products monster racing block, JR Race Car flathead, Pure Power Racing flathead, M-1 Machine racing block, SR71 Racing Block by Soltz Racing, Huddleston Performance Sniper, R&S Machine Terminator, TRS block, and Briggs & Stratton 206 factory-sealed engine (with a red, blue or black slide valve) or an electric powered motor meeting the rules found in the Electric-Powered Jr. Dragster section of this rulebook. All accepted

aftermarket flathead engines must not exceed 10 11/16 inches from base to deck. Any measurement that exceeds that limit is prohibited. See Trainee and Youth Class Designations for their engine requirements.

EXHAUST

Regardless of design, no part of tailpipe may extend more than 27 inches past exhaust attachment point on rear of engine block. Outlet must be directed rearward, away from driver and engine. Mufflers permitted. Tailpipe support mandatory on Briggs & Stratton 206 crate engine.

FUEL

Restricted to gasoline, alcohol, or gasohol. Nitrous oxide and/or propylene oxide and/or nitromethane prohibited. No fuel additives, power enhancers, or mix-ins allowed; scents permitted. For Trainee and Youth categories, all fuels other than gasoline are prohibited.

AIR FILTERS

Air filters must be properly mounted per manufacturers' instructions.

FUEL SYSTEM

Any naturally aspirated carburetor permitted. Carburetors that are mounted via rubber boots/adapters and clamps must have a secondary mechanical device (bolt, turnbuckle, bracket, etc.) securing the carburetor to the engine/intake manifold. Fuel injection prohibited. Auxiliary vacuum fuel pump permitted; must be pulsed from manifold only. Pressurized fuel systems prohibited. Fuel tank must be located behind driver, below the shoulder hoop of roll cage, and be securely mounted. Insulated fuel tanks prohibited. Maximum one fuel tank permitted. Maximum capacity of fuel tank or cell, 1 gallon. Fuel tank/cell must be equipped with a screw-on or positive locking cap. All vents must be routed downward and away from driver. Open holes(s) in fuel tank/cell prohibited.

IGNITION SYSTEM

Magneto or battery ignition systems permitted. When a battery ignition system is used, the MSD Small Engine Ignition kits 41500 and 41510 and MSD ignition unit 42231 are the only accepted units for NHRA competition. The 42231 is limited to use of a high-side chip only. The low-side chip must be zero. The accepted coils are the MSD 42921, MSD 8232, Master Blaster 2, and Master Blaster 3 coils. Any other coils are prohibited in NHRA competition.

All other battery ignition systems prohibited. Any other attachment prohibited. Ignition systems and/or components must be utilized in an unaltered manner consistent with the manufacturer's installation and instruction books unless otherwise approved.

OIL SYSTEM

Oil additives for the intent of producing power prohibited.

STARTER

Pull-rope or remote starter mandatory. Any driver-activated/operated starting system prohibited.

SUPERCHARGER, TURBOCHARGER

Prohibited.

THROTTLE

All vehicles must be equipped with a positive throttle return spring, which shall close throttle when released. Throttle control must be manually operated by driver's foot. Electronics, pneumatics, hydraulics, or any other device may in no way affect the throttle operation. Throttle stops, other than mechanical (i.e., a positive stop under throttle pedal), prohibited. Must

be securely mounted (no tie wraps). NHRA-accepted hand controls for the physically challenged permitted.

VENT TUBES, BREATHERS

Where used, must be securely fastened (no tie wraps). Container/catch tank must be designed to prevent spillage onto racing surface (no open-top containers).

DRIVETRAIN: 2

CHAIN GUARD

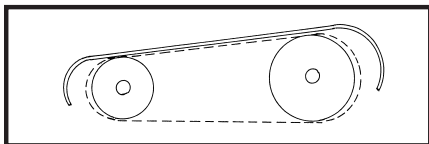

All cars must be equipped with a guard to cover the width and at least the top run to the forward and trailing centerline of the sprockets on any chains. Chain guards

must be minimum .060-inch steel or .090-inch aluminum. Chain guard must be within 4 inches of the chain at all points. Must be securely mounted (no tie wraps). Plastic and carbon fiber chain guard prohibited. Moving engine/drivetrain parts must be protected by framersails or guards.

CLUTCH

Maximum one dry centrifugal-type engine clutch. Chain or belt drive only. Axle clutches prohibited. The clutch face plate must have sufficient material to cover the clutch housing using billet aluminum or steel. All clutch covers designed after April 24, 2006, must be NHRA-accepted. Accepted clutch face plates: Polar, Gaged Engineering, McGee Racing Cams, JR Race Car, Craw Racing, Metro Racing, Power Block (HRD), Comet, Cheetah Supply, Salisbury, Blossom Racing, M&S Machine, Haddock Ltd., MX2, and Brand X Racing Engines.

CLUTCH GUARD

Clutch cover/guard that provides 180-degree coverage over the top of the entire clutch plate, cover, hat, arms, springs, etc. made of .090-inch 2024T3, 6061T6, or 7075T6 aluminum or .060-inch steel mandatory. All other materials prohibited.

CLUTCH SUPPORT

A clutch/crank support mandatory on any car running 9.99 or quicker, accepted on all vehicles. If a clutch/crank support is used, the clutch-side crank support bracket and bottom plate must be made of .350-inch-thick aluminum at its thinnest point. If the support bracket and bottom plate are built using a .500-inch-thick material, it will be allowed to have a pocket/cavity with a minimum thickness of the bracket .250-inch at its thinnest point. The support bracket must be mounted using three 5/16-inch bolts or four 1/4-inch bolts to the bottom plate. A clutch support arm may be used in lieu of clutch/crank support bracket. Support arm must be made of .625-inch-thick aluminum and connected to block by 1 1/4-inch-diameter stud and held in place by a 3/8-inch bolt. If Tecumseh block and clutch system is used, a clutch support is not mandatory.

FLYWHEEL

Aftermarket billet flywheel or NHRA-accepted aftermarket flywheel shield mandatory unless original, stock carburetor is used. With original, stock carburetor, aftermarket billet or stock steel flywheel mandatory. Cast aluminum flywheel prohibited. Keyway modifications permitted. Lightening or modifications to stock flywheel prohibited.

TRANSMISSION

Gear-type prohibited. Torque converter belt assembly units permitted.

BRAKES & SUSPENSION: 3

BRAKES

Two rear-wheel hydraulic drum or disc brakes, or NHRA-accepted mechanical brakes are mandatory. Hydraulic brake lines must be steel or steel braided. High-pressure brake hose must be used with steel line for vibration connections. Front brakes permitted, but only in conjunction with rear brakes. Live axle may have brakes on one wheel only if 7-inch-minimum go-kart puck-type disc brake is used. Use of drive sprocket as a brake rotor prohibited. Drilling of brake components prohibited. Steel disc brake rotors are required and must be a minimum of 7-inch diameter with a .228-inch minimum thickness; dual steel brake rotors, 6-inch diameter with a 3/16-inch minimum thickness; or aluminum brake rotor, 11-inch diameter with a .228-inch minimum thickness. Line-locs prohibited. Hand brake permitted, but must be directly coupled to foot brake; hand brake cannot be independent of, or in lieu of, foot brake. Application and release of brakes must be a direct function of the driver; electronics, pneumatics, or any other device may in no way affect or assist brake operation.

SUSPENSION

Suspension permitted; maximum upward suspension travel 2 inches.

STEERING

Set screw steering shaft couplers/attachments prohibited. All components must have a positive "through" bolt connection; no roll or pressed pins, no ball-lock pins, set screws, etc. All rod ends must be installed with flat washers to prevent bearing pullout. Flexible steering shaft prohibited. Minimum spindle diameter 1/2-inch. Vertical adjustment of spindles via shims is permitted; aftermarket spindles configured to permit a maximum of two front rear locations (with secondary locking devices) to change rollout/wheelbase stagger are permitted. Cars running 8.89 to 7.90 must have rack and pinion steering only.

WHEELIE BARS

Permitted. Using wheelie-bar wheels as "fifth wheel" sensing device prohibited.

FRAME: 4

ALIGNMENT

Each car in competition must have sufficient positive front-end caster to ensure proper handling of car at all speeds.

BALLAST

Maximum amount of removal ballast is 25 pounds; maximum amount of total ballast (removable plus permanent ballast) is 100 pounds. Removable ballast must be secured to frame with minimum one 3/8-inch-diameter bolt per 5-pound weight, or two 3/8-inch-diameter bolts for weights of 10 to 25 pounds; hose clamps, wire, strapping, tape, tie wraps, etc. prohibited. If additional ballast is needed, it must be permanently attached to frame, bolted with minimum one 3/8-inch-diameter bolt per 5-pound weight, or two 3/8-inch-diameter bolts for weights of 10 to 25 pounds with nuts welded to bolts. Ballast must be in the form of metal plates, bars, straps, etc., attached as described above. A steel pipe filled with shot may be substituted; must have screw-on, sealed cap(s). Ballast prohibited in cockpit. No part of ballast may be installed higher than top of rear tires. Discovery of loose or disguised ballast will result in disqualification from the event, regardless of whether infraction occurs during qualifying or eliminations. No ballast may be added, removed, or relocated after the engine has been started. Additional penalties may be imposed in the sole and absolute discretion of NHRA.

DEFLECTOR PLATE

A deflector plate of minimum 1/16-inch aluminum must be installed between roll cage and engine extending from lower framerail to the top of driver's helmet. Portion between shoulder hoop and top of helmet must be minimum 7 inches wide, may be narrowed or rounded above the helmet. Two-piece plate permitted with no air gap between the two. Carbon fiber prohibited.

GROUND CLEARANCE

Minimum 3 inches from front of car to 12 inches behind centerline of front axle; 2 inches for remainder of car.

MOUNTING HARDWARE

Hose clamps and tie wraps may be used only to support hoses and wires; all other components must be welded, bolted, aircraft clamped, etc. All self-locking fasteners must be metallic.

ROLL CAGE

All new chassis must have manufacturer's name, serial number, and date of manufacture. Construction must conform to standard dragster configuration as outlined in illustration with minimum 5-point roll cage mandatory. When driver is in driving position, roll cage must be at least 3 inches in front of helmet. Roll cage hoops, upper framerails, and lower framerails must be minimum 1 1/8-inch diameter by .083-inch wall thickness round mild steel tubing. Uprights must be minimum 7/8-inch by .083-inch. Diagonals must be minimum 3/4-inch by .083-inch. An upright (within 30 degrees of

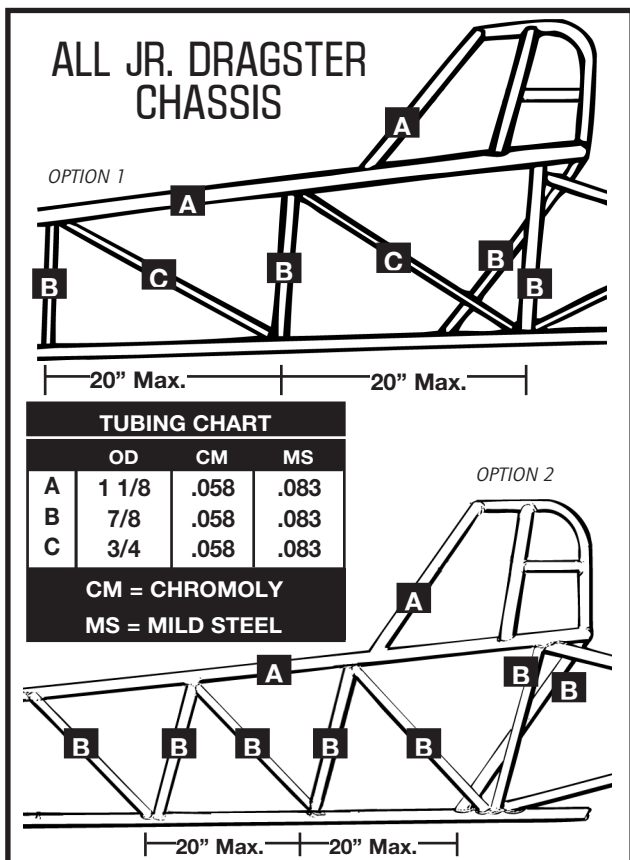

ALL JR. DRAGSTER CHASSIS

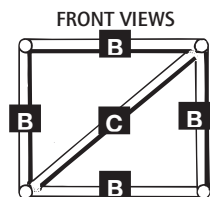

OPTION 1

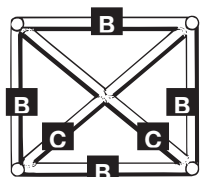

OPTION 2

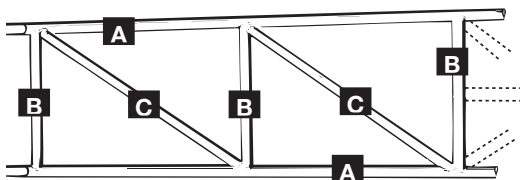

BOTTOM VIEW

REAR VIEWS

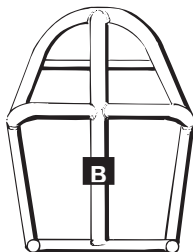
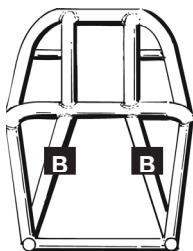

perpendicular to the lower framerail) is required on each side of the roll cage within six inches of the second roll-cage hoop; must be fully welded to both the upper and lower frameraills. If the upright spacing at the top framerail exceeds 28 inches, then a 7/8-inch by .083-inch or 3/4-inch by .083-inch, depending on corresponding diagonal thickness, X must be used in lieu of a single diagonal. Within the driver compartment (from foot box to back of seat), the maximum distance between uprights is 20 inches. Foot box must incorporate a minimum 3/4-inch by .083-inch diagonal. Note: .058-inch chromoly may be used in place of .083-inch mild steel. Chromoly mandatory on any car running between 8.89 and 7.90.

Helmet bars (3/4-inch OD x .058-inch chromoly tubing or 3/4-inch x .083-inch mild steel, or 1/2-inch x .090-inch flat strap) are required between the secondary upper roll cage hoop and the upper roll cage rear braces on each side of the car. If the center-to-center distance between the upper roll cage rear braces exceeds 6 inches, then an additional helmet bar is required between the back braces. The helmet bars are to be installed at a height above the shoulder hoop that will keep the driver's helmet inside of the upper roll cage.

All cage structures must be designed in an attempt to protect the driver from any angle. With the driver in the normal driving position, the driver's lower extremities, including the knees, must be below the top of the upper framerail. A steering crossmember 1/2-inch x .058-inch chromoly or .083-inch mild steel must be installed or plate or net must be installed across the upper frameraills so as to retain the driver's feet/legs in case of upset/incident. The steering crossmember, plate, or net must be located within 6 inches (forward or behind) of the driver's knees. If a crossmember is used, it must be either

welded or aircraft clamped (no hose clamps). If a plate is used, it must be either welded or bolted in place unless it is located and fastened below the upper framerails. All chromoly welding must be done by approved TIG heliarc process; mild steel welding must be by approved MIG wire feed or TIG heliarc process. Welding must be free of slag and porosity. Any grinding of welds prohibited. Plating of chassis prohibited on all new vehicles.

ROLL CAGE PADDING

Roll-cage padding meeting SFI Spec 45.1 or SFI 45.2 mandatory anywhere driver's helmet may come in contact with roll-cage components during an accident. Roll bar padding must be installed in such a manner that the helmet can never contact any of the roll cage bars, including the front bars of the roll cage.

WEIGHT

Minimum weight (without driver or driver apparel/equipment) is 225 pounds.

WHEELBASE

Minimum 90 inches; maximum 150 inches on long side. Maximum wheelbase variation from left to right: 2 inches.

TIRES & WHEELS: 5

TIRES

Rear tires minimum 18-inch diameter by 7 1/2 inches wide, as noted by size designation on sidewall of tire or by physical measurement at widest or tallest point. All front tires must have a manufacturer's maximum inflation rating. Tires may not be inflated above manufacturer's ratings. All tires must be pneumatic; no solid tires. Tires will be visually checked for condition, pressure, etc. and must be considered free of defects by the technical inspector prior to any run. Treatment of tires is prohibited in or near the staging lanes or starting-line area. Tire covers must be removed before leaving the staging lanes.

WHEELS

All wheels must be constructed from aluminum, billet, or steel. All other materials prohibited. Front wheels, minimum 5 inches diameter; minimum spindle diameter, 1/2-inch. Spindle nut must utilize a cotter pin or be of the nylon-locking type. Wire spoke wheels must utilize .100-inch-minimum-diameter steel spokes. Rear wheels, minimum 8-inch diameter. Modifications to any wheel prohibited. The use of "spinner"-style wheels or any wheel designs that incorporate movable pieces while vehicle is in motion or stationary are prohibited.

INTERIOR: 6

FOOT-BOX BULKHEAD

All cars must be equipped with a bulkhead in front of the driver's feet, minimum .024-inch steel, .032-inch aluminum, or .060-inch carbon fiber. Bulkhead must be directly in front of or directly behind foot-box diagonal.

SEAT

Properly braced, framed, and supported seat constructed of aluminum or fiberglass mandatory.

SHEET METAL

Driver-compartment interior must be aluminum, steel, fiberglass, or carbon fiber. Magnesium prohibited.

UPHOLSTERY

Optional.

BODY: 7

AIR FOILS, WINGS

All wings must be bolted to frame structure. A positive locking device to prevent movement mandatory. No part may come in contact with tire or wheel at any time. Spring-loaded spoilers, wings, or canards prohibited. Adjustment of air foils, wings, or spoilers during run prohibited. Ball lock pins and other quick-release fasteners prohibited. No rear wing may be supported with struts, rods, etc. attached to the roll cage. All rear wing supports must attach to the framersails at least 12 inches behind the roll cage. Front wings and spill plates permitted, must be at least 3 inches above the ground, no more than 15 inches forward of the center of the front spindle, and no more than 6 inches wider than the outside of the front tires. Rear wings must be at least 4 inches from rear tires; front wings must be at least 2 inches from front tires. All spill plates must be flat, vertical, and parallel to each other.

BODY

Body and cowl must be constructed of aluminum, fiberglass, or carbon fiber and extend forward to foot-box bulkhead. Driver compartment, frame structure, roll cage, and body must be designed to prevent driver's body or limbs from making contact with wheels, tires, exhaust system, or track surface. Any portion of the body side panels that extend upward into the driver's line of sight must be clear and permit an unobstructed horizontal view for a minimum of 180 degrees. Body may not cover top of engine, wheels, or tires. Front overhang not to exceed 15 inches, measured from centerline of front spindle to forwardmost point of car.

Body must be of accepted dragster style/design. Roadster, altered, Funny Car, etc. body styles prohibited. Only OEM-style mirrors, mounted in the conventional fashion, permitted. Cover or canopy over cockpit prohibited. Front-wheel fairings and front wings that cover any part of the front wheel prohibited.

COMPETITION NUMBERS

Each car in competition must display the driver's permanent number. Minimum size: 4 inches x 1 inch. Driver's competition number and class designation must be displayed in a legible manner in a contrasting color to the vehicle's background color, or light color on windows, in a prominent position, and be clearly visible to the tower personnel.

FLOOR

Full floor, mounted on top of lower framersail cross braces, extending from driver's seat forward to 6 inches past pedals, mandatory.

WIND DEFLECTOR

All cars must be equipped with a wind screen or deflector to direct foreign matter over the driver's head. Wind screen or deflector must be a minimum of 4 inches tall. No blinders of any description are permitted. Windscreen minimum opening is 18 inches. Opening is measured from the leading edge of the roll cage or roll cage padding, whichever is less.

ELECTRICAL: 8

BATTERIES

Dry cell batteries only permitted. Maximum total weight 5 pounds. Must be securely mounted outside driver's compartment.

BUTTONS/SWITCHES

Entrants are allowed to use a total of two switches/buttons in the cockpit. One of these switches/buttons is for the ignition shutoff, which cannot be momentary and cannot be reset from the driver's compartment; the second is available for any function (including a momentary ignition cutoff), except for the use of a transbrake or downtrack stutler.

DELAY BOXES/DEVICES

Prohibited.

IGNITION SHUTOFF

A positive ignition shutoff, located within easy reach of driver, and which cannot be reset from the driver's compartment, mandatory. Shutoff switches must be positive action (no "momentary contact" switches) and must be clearly labeled "on" and "off." A second shutoff switch, located on the deflector plate 3 inches or less from the top of the roll cage, within easy reach of crewmember or race official, mandatory. If equipped with a shroud over the top of the roll cage, second shutoff switch must be mounted on top of shroud 3" minimum from rear edge of shroud. The second shutoff-switch wiring must be completely independent of the primary switch (i.e., wired in parallel from end to end of both wires). All ignition wiring connections, including the coil and switch, must use eyelet, lug, terminal board, or other screw-type connections; push-on-type, quick disconnect-type, and twist-type connectors prohibited. A wire tie, minimum 6 inches long, must be attached to the spark-plug wire within 1 inch of the spark plug. All magneto ignition systems must be equipped with an NHRA-accepted manual kill switch. When a battery ignition system is used, a master cutoff switch ("push/pull" type) is mandatory in the driver's compartment and must be connected to the positive side of the electrical system and must stop all electrical functions. Timed ignition-interruption devices (stutter boxes) or any action that causes ignition interruption prohibited.

TAILLIGHTS

One functioning light mandatory. Must be visible from rear of the car. Taillight must be permanently mounted to the car in a manner that batteries are also secured; tie wraps, wire ties, hose clamps, etc. prohibited. All other lighting (e.g. underglow etc.) may not be illuminated while the vehicle is on the racing surface.

SUPPORT GROUP: 9

CAMERAS

One camera permitted unless NHRA permission is granted for additional cameras. May not be intentionally directed at the racer in the other lane without NHRA permission. Video may not be transmitted in any means or manner without NHRA permission, which permission, if granted, may be revoked at any time. Incident video may not be transmitted under any circumstances. No video monitors permitted in or on the car. Video may not be used in any way to determine track position in real time. Must be securely attached to the vehicle with appropriate fasteners. May not be attached with suction cups, wire ties, hose clamps etc. For any camera mounted external to any vehicle, all mounting brackets, associated fasteners, hardware, etc. from the camera to the vehicle attachment point must be metal, no plastic or nonmetallic components permitted. For all vehicles, attachment to the driver, the driver's helmet, or the steering wheel prohibited.

COMPUTERS

Prohibited. A computer is defined as any device (electrical, mechanical, pneumatic, hydraulic, etc.) that activates any function of, or in any way affects the operation of, the vehicle based on measurement, sensing, processing, etc. of any data related to the performance of the vehicle. Display or transmission of any data gathered or processed, to the driver or any remote location, is prohibited.

DATA RECORDERS

A data recorder may be used to record only engine rpm, engine temperature, exhaust temperature, and jack-shaft sensor data; may not activate or initiate any function of the vehicle. Data recorder may not be activated by

the throttle, brake, or other mechanisms, nor by the Christmas Tree, radio transmitter, sensing of wheel speed, inertia, laser device, or transmission of track position. Must be activated by separate switch. Transmission or display of data gathered or processed by data recorder to the driver (during the run) or any remote location is prohibited. Data may be reviewed after the run.

Discovery of a device that displays or transmits "on track"- or "track location"-type data will be grounds for immediate disqualification from event, loss of all points for the season, and suspension from all NHRA Summit Racing Jr. Drag Racing League events for remainder of season. Additional penalties may be imposed at the sole and absolute discretion of NHRA.

GAUGES

Tachometer, engine-temperature, and cylinder-head-temperature gauges permitted. All other gauges and indicators prohibited. Playback-type gauge(s) permitted. Download capabilities (other than stand-alone tachometers) classify unit as a data recorder, and it must be located outside driver compartment (see also Data Recorders, above). Analog or digital display permitted. Gauges (display) may not be mounted on steering wheel. Speedometer and/or rpm/shift light of any description prohibited.

ELECTRONIC CONTROLS

Prohibited. Electronic controls may in no way affect any functions (i.e., clutch, throttle, brakes, etc.). All controls must be a function of the driver.

LIFTING DEVICES

Any form of mechanical, hydraulic, or other leverage-type device for raising a car's driving wheels off the starting-line surface is prohibited.

STAGING AIDS/DEVICES

Mechanical, hydraulic, electric, pneumatic, and similar devices to aid in staging vehicle prohibited. Shutoff switches must be positive action (no "momentary contact" switches) and must be clearly labeled "on" and "off." Push-staging any vehicle is prohibited. Staging must be done under the vehicle's own power.

TOWING

A Jr. Dragster is not allowed to be driven under power outside of designated racing areas at any time. Driving of a Jr. Dragster in pit area is strictly prohibited and will subject participant to disciplinary action in the sole and absolute discretion of NHRA. Jr. Dragsters can be towed by either a tow strap or a front-end dolly or a combination of both. No full-size tow vehicles permitted. A Jr. Dragster may not be pushed by any motorized vehicle. It is mandatory that a fluorescent or brightly colored flag be attached to each Jr. Dragster anytime the vehicle is being towed by a strap or a front-end dolly. Minimum height of the flag is five feet.

When the tow strap only method is being used, the driver must be properly seated in the cockpit in the driving position, not sitting on the roll cage or standing up. The tow strap cannot be attached to the roll cage. A total of two vehicles can be towed in tandem with a strap. No vehicles can be towed side by side using a tow strap.

When the front-end dolly method is being used the front end must be secured and the front wheels must be elevated off the ground. A driver is not required in the cockpit when using the front-end dolly method. Any driver that chooses to be in the cockpit must be properly seated in the cockpit in the driving position, not sitting on the roll cage or standing up. A total of three vehicles can be towed by the vehicle dolly method. A tow strap cannot be used in conjunction with the front-end dolly method when more than one vehicle is attached to the front-end dolly.

When using a combination of the front-end dolly and tow strap methods, a maximum of one vehicle may be attached to a front-end dolly and a maximum of one vehicle may be attached to a tow strap. There must be a driver in the vehicle being towed by the tow strap and they must be properly seated in the driving position, not sitting on the roll cage or standing up. A driver is not required in the cockpit when using the front-end dolly method. Any driver that chooses to be in the cockpit of a vehicle that is being towed by the front-end dolly must be properly seated in the cockpit in the driving position, not sitting on the roll cage or standing up.

TWO-WAY RADIOS

Prohibited. Any communication to and/or from the driver or any telemetry signals between driver/vehicle and/or any remote location prohibited. Use of two-way communication by driver and/or any crewmember to any remote location prohibited. Use of headset or handheld radios by crewmembers in the starting-line area is prohibited. The use of any portable or handheld electronic devices (e.g., iPods, MP3 players) prohibited in staging lanes or on the racetrack.

WARM-UPS

Vehicle must be off the ground and have a qualified Jr. drag racing driver seated in the cockpit any time the engine is running.

DRIVER: 10

AGE REQUIREMENTS

Minimum age 5 years to drive in the League; those 6 and older can race against their peers. Drivers 5 years old restricted to 20.00 or slower e.t.; 6 and 7 years old restricted to 13.90 or slower e.t.; 8 and 9 years old restricted to 11.90 or slower e.t. Drivers 10 to 12 years old restricted to 8.90 or slower e.t. Drivers 13 to 18 years old whose cars meet Advanced class criteria restricted to 7.90 or slower e.t., and 85.00 mph or slower. Drivers 13 to 18 years old whose cars do **NOT** meet Advanced class criteria restricted to 8.90 or slower e.t.

APPAREL

Each member of a participant crew must be fully attired when present in the staging, starting, and competition areas of the racetrack. Shoes are mandatory.

APPEARANCE

Vehicles participating in drag racing events must be presentable in appearance at all times; those considered improperly prepared may be rejected by the technical inspector. The appearance of personnel attending contestant vehicles is equally important and is subject to the same considerations.

ARM RESTRAINTS

Mandatory. Must be worn and adjusted in such a manner that driver's hands and/or arms cannot be extended outside of roll cage and/or framerails. Arm restraints shall be combined with the driver restraint system such that the arm restraints are released with the driver restraints. Refer to manufacturer for instructions.

CREDENTIALS

Valid NHRA Summit Racing Jr. Drag Racing League license mandatory.

DRIVER RESTRAINT SYSTEM

Five-point, 1 3/4-inch-wide driver restraint system mandatory. Driver restraint system must meet SFI Spec 16.1 or 16.2 and be updated at two-year intervals from date of manufacture. All seat-belt and shoulder-harness installations must be mutually compatible, originally designed to be used with each other. For harness installation, see illustration below. Only units that release all five attachment points in one motion are permitted. When arm restraints are worn

with a restraint system that uses a "latch lever," a protective cover must be installed to prevent arm restraint from accidentally releasing the latch lever. Protective cover not required if system uses "duck-bill" latch hardware. All harness sections must be mounted to the frame, crossmember, or reinforced mounting and installed to limit driver's body travel both upward and forward. Wrapping of belts around lower framerail prohibited. Where belts are wrapped around the frame members, they must be secured from sliding along the axis of the tube/frame member either by a tab or additional tubing. Under no circumstances are bolts inserted through belt webbing permitted for mounting.

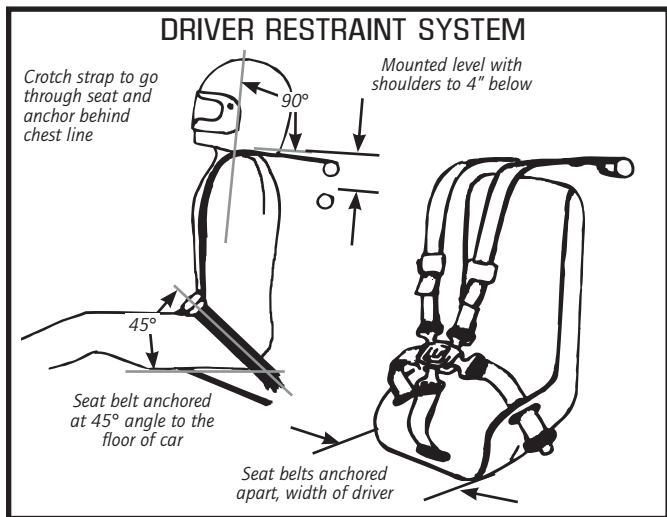

HELMET

A full-face helmet meeting Snell: SA2015, SA2020, K2015, K2020, M2015, M2020, SAH2010, 24.1/2015, 24.1/2020, 31.1/2015, 31.1/2020, 41.1/2015, 41.1/2020, FIA: 8860-2010, 8860-2015 or 8860-2018 helmet and shield mandatory. Taping or other modification to the helmet or visor that reduces the driver's field of vision is prohibited.

NHRA Helmet Expiration Dates

Label	Expires	Label	Expires
Snell 2015	1/1/2027	SFI 24.1/2020 (JDRL only)	1/1/2032
Snell 2020	1/1/2032	Snell CMR 2016 (JDRL only)	1/1/2028
SFI 31.1 and 41.1/2015	1/1/2027	FIA 8860-2010	1/1/2028
SFI 31.1 and 41.1/2020	1/1/2032	FIA 8860-2015	1/1/2033
SFI 24.1/2015 (JDRL only)	1/1/2027	FIA 8860-2018	1/1/2036

NECK COLLAR/HEAD AND NECK RESTRAINT DEVICE/SYSTEM

FOR TRAINEE, YOUTH, NOVICE, INTERMEDIATE AND ADVANCED CLASSES: Beginning June 1, 2020, a head and neck restraint device/system meeting SFI 38.1 is mandatory and must display a valid SFI label. At all times that the driver is in the race vehicle, from the ready line until the vehicle is on the return road, driver must properly utilize an SFI 38.1 head and neck restraint device/system, including connecting the helmet as required for full functionality of the device. The SFI 38.1 head and neck restraint device/system, when connected, must conform to the manufacturer's mounting instructions, and it must be configured, maintained, and used in accordance with the manufacturer's instructions. A head and neck restraint device/system may be used with or without an SFI 3.3 neck collar. If the device/system is used without a neck collar, an SFI 3.3 head sock or SFI 3.3 skirted helmet mandatory.

FOR MASTERS CLASS: Neck collar meeting SFI 3.3 Mandatory.

A head and neck restraint device/system meeting SFI 38.1 is permitted. The head and neck restraint device/system, when connected, must conform to the manufacturer's mounting instructions, and it must be configured, maintained, and used in accordance with the manufacturer's instructions.

A head and neck restraint device/system may be used with or without a neck collar. If the device/system is used without a neck collar, an SFI 3.3 head sock or SFI 3.3 skirted helmet mandatory.

PROTECTIVE EQUIPMENT

All drivers are required to wear a jacket and pants meeting SFI Spec 3.2A/1. Shoes, gloves, and socks mandatory. Socks must extend up into the pants. Nylon or nylon-type gloves and socks prohibited. No open-toe or open-heel shoes or sandals. Synthetic clothing not recommended.

GENERAL: 11

ADVERTISING AND OTHER MATERIAL/DISPLAYS

NHRA reserves the right to regulate any advertising or other material that is present on site at any NHRA event including without limitation any material appearing on any participant, on the body or any other visible part of any vehicle or transporter participating in NHRA events including on support vehicles, in any pit area, in any area of the dragstrip from the staging lanes to the end of the dragstrip, and any item or material on site that may constitute a product placement. Participants and vehicles may be excluded from competition and from event facilities if, in NHRA's discretion, any advertising or other material displayed on a person, race or support vehicle, or in a pit area or otherwise is not in the best interests of NHRA and the sport of drag racing, and/or is or may be in conflict with any applicable law. Moreover, NHRA will require compliance with all guidelines and requirements of any telecaster for events that will be telecast. In addition, NHRA may require certain indicia to be visible on a vehicle as a condition of participation in competition if NHRA determines that such requirement is in the best interests of NHRA and the sport of drag racing.

By way of illustration and without limitation, online gambling is an activity deemed by NHRA to be not in the best interests of NHRA and the sport of drag racing, and an activity that NHRA will not allow to be displayed or advertised on site at any NHRA event or in connection with NHRA in any manner whatsoever. Web sites that allow gaming that is entirely free and for fun may be permitted pursuant to further guidelines that may be requested from NHRA. Violation of any part of any such guideline will be treated as violation of the NHRA Rulebook and NHRA Jr. Rulebook.

ELECTRIC-POWERED JR. DRAGSTER

Requirements and specifications for electric-powered Jr. Dragster vehicles are the same as those for the NHRA Summit Racing Jr. Drag Racing League with the following exceptions:

DESIGNATIONS

EPJD, preceded by competition number.

Competition is designed to be conducted on an e.t. dial-your-own format or a preset index on a heads-up breakout basis. Actual class or age-group

breaks may vary from track to track. Contact your local track for information on class structure.

REQUIREMENTS & SPECIFICATIONS

MOTOR: 1

MOTOR

All vehicles are restricted to a maximum of one (1) rear-mounted electric motor. Motor must be mounted in conventional position. Exposed motors must have a shield of .024-inch steel, .032-inch aluminum, or .120-inch Lexan.

FRAME: 4

DEFLECTOR PLATE

A deflector plate of minimum 1/8-inch steel must be installed between roll cage and battery pack extending from lower frame rail to the top of driver's helmet. Portion between lower and upper shoulder hoop must extend and attach to the body panel. Two-piece plate permitted with no gaps. Portion between shoulder hoop and top of helmet must be minimum 7 inches wide, may be narrowed or rounded above the helmet. Two-piece plate permitted with no air gap between the two. Carbon fiber, titanium and all other materials prohibited.

WEIGHT

Minimum weight less driver 225 pounds; weight greater than 400 pounds less driver with all batteries requires SFI chassis specification 2.7.

ELECTRICAL: 8

BATTERIES

Wet (free liquid) batteries prohibited. All batteries must be securely mounted outside of and completely sealed from driver compartment. Batteries may not be located above top of drive tires or outside of frame. Batteries must be installed so as to withstand a force four times (vertical) and eight times (horizontal) the weight of the battery pack, and each battery or battery pack must be secured with bolts and straps commensurate with the size and weight of the battery (see chart). Vehicles are permitted to use ABSORBED GLASS MAT, STARVED ELECTROLYTE, OR SEALED VENTED NICAD-style batteries for power source. The use of flooded batteries is limited to an NHRA-accepted installation. Traction motor and/or high-current wiring may not be located in driver's compartment. Instrumentation wiring permitted. All traction wiring must be isolated from vehicle chassis.

Battery on Flat Surface with Two-Bolt Strap Only			
Bolt Size	Grade 1 Battery	Grade 5 Battery	Grade 8 Battery
#8		16	22
#10		20	28
1/4	14	36	50
5/16	23	58	82
3/8	34	86	121
7/16	46	117	166
1/2	61	157	222
9/16	78	201	284
5/8	97	250	353
Battery in Rack or Box-Mounted			
Bolt Size	Grade 1 Battery	Grade 5 Battery	Grade 8 Battery
#8	15	39	55
#10	19	49	69
1/4	35	88	124
5/16	57	145	205
3/8	83	214	302
7/16	114	293	413
1/2	152	392	553
9/16	195	503	710
5/8	243	624	881

FUSING OF BATTERIES

All battery packs must have over-current protection. Circuit breaker(s) or fuse(s) permitted. Such protection devices must have a DC voltage rating equal to or greater than nominal pack voltage. Current rating must be lower than master disconnect, wiring, and battery pack can carry without damage. Battery sub-packs must be individually fused.

IGNITION

All vehicles must be equipped with a switch, attached to driver with a lanyard, capable of shutting off all power to motor. Switch may actuate relay or contactor. Solid state switch prohibited. A flashing yellow light must be affixed to top of roll cage indicating when electrical system is energized.

MASTER CUTOFF

All vehicles must incorporate a master electrical disconnect switch that must disable all electrical functions. Switch must be located on deflector plate no more than three inches from top of roll cage. Must be clearly labeled as to "off" position. Must disconnect all power from motor. Switch may actuate relay or contactor.

RECHARGING

Batteries may be recharged in pits or other designated areas only. Polarized plug connection to battery pack from charger mandatory.

VOLTAGE

Maximum permitted operational voltage 144 volts nominal. Voltage checked at battery pack. No load using digital voltmeter. Maximum fully charged battery-pack voltage 156 volts.

JR. COMP

Requirements and specifications for Jr. Comp vehicles are the same as those for the NHRA Summit Racing Jr. Drag Racing League with the following exceptions:

DESIGNATION

J/C, preceded by car number.

The class is conducted on the eighth-mile format.

Jr. Comp may not run against, or side by side with, any other Jr. Drag Racing League category.

AGE REQUIREMENTS

Drivers may compete from the day of their 14th birthday through the year of their 20th birthday. Driver must complete test runs and obtain a Jr. Drag Racing League Jr. Comp competition license before participation.

Car and driver older than 16 may compete in appropriate E.T. category.

E.T. RESTRICTIONS

Dial-in restricted to 6.90 seconds or slower based on either an e.t. dial-your-own or heads-up basis; breakout rules apply. In qualified events, no racer can qualify quicker than 6.900.

Any racer running quicker than 6.70 or faster than 110.00 mph at any time during an event will be disqualified from the event. Any racer running quicker than 6.50 e.t. or faster than 114.99 mph at any time during the event will be disqualified from the event, and will be subject to additional disciplinary action in the sole and absolute discretion of NHRA.

REQUIREMENTS & SPECIFICATIONS

ENGINE: 1

CAMSHAFT

Overhead valves; overhead cams permitted.

ENGINE

All vehicles restricted to one four-stroke, OEM motorcycle, snowmobile, personal watercraft, or industrial engine (nonautomotive), with a maximum of four cylinders and a minimum of two cylinders. Must be NHRA accepted. Any internal modifications permitted. Aftermarket cylinder heads permitted.

EXHAUST

Outlet(s) must be directed rearward, away from driver and engine. No part of tailpipes may extend beyond the rear of the chassis or tires, whichever is greater. Mufflers permitted. Subject to local regulations and track rules, vehicle must not be able to exceed 90 decibels as measured on the A scale at 50 feet from the car while under acceleration on the racetrack. An engine shield mandatory between engine block and exhaust system.

FUEL

Restricted to gasoline, alcohol, or gasohol. Nitrous oxide and/or propylene oxide and/or nitromethane prohibited.

FUEL SYSTEM

Fuel injection permitted. Electronic fuel injection must be a "closed" system (i.e., monitors only engine functions and does not monitor vehicle speed, wheel speed). Pressurized fuel system permitted. Maximum capacity of fuel tank or cell, 3 gallons. Fuel tank/cell must be equipped with a screw-on or positive locking cap. All vents must be routed downward and away from driver. Open holes in fuel tank/cell prohibited.

FUEL LINES

All fuel lines (including gauge and/or data recorder lines) must be metallic, steel-braided, or NHRA-accepted woven or woven-pushlock.

IGNITION

Battery ignition system permitted.

STARTER

Onboard starter permitted. Pull-rope or remote starter permitted. No push-starting allowed.

DRIVETRAIN: 2

CLUTCH

Centrifugal, slider, or conventional motorcycle clutch permitted. If non-centrifugal clutch is used, clutch handle may be mounted on steering wheel or may be operated through use of a clutch pedal. If clutch pedal is used, hand brake mandatory. Electronics, electric solenoids, pneumatics, hydraulics, or any other device may in no way affect the clutch operation.

FLYWHEEL

Aftermarket billet flywheel or NHRA-accepted aftermarket flywheel shield mandatory. Stock steel or cast aluminum flywheel prohibited. Keyway modifications permitted.

TRANSMISSION

Permitted. Transmission may be shifted by direct action of the driver or with a preset time OR rpm-activated electrical, mechanical, pneumatic, or hydraulic device only. Rpm-based automatic shifters may not have a time delay incorporated into the device. Torque converter belt assembly units permitted in lieu of transmission. The shift timer start switch may be activated by the throttle pedal, clutch pedal, or throttle shaft: the shift timer switch may not control or be wired into any other component on the race car.

BRAKES & SUSPENSION: 3

BRAKES

Two rear-wheel hydraulic disc brakes mandatory. With a total car weight of 1,000 pounds or less, and a one-piece rear axle, may use a single brake rotor with dual calipers. Hydraulic brake lines must be steel or steel braided. High-pressure brake hose must be used with steel line for vibration connections. Front brakes permitted, but only in conjunction with rear brakes. Use of drive sprocket as a brake rotor prohibited. Drilling of brake components prohibited. Line-locs prohibited. Hand brake permitted. If used, must be located inside body or driver compartment. Application and release of brakes must be a direct function of the driver; electronics, pneumatics, or any other device may in no way affect or assist operation of brakes.

STEERING

Rack-and-pinion steering mandatory.

FRAME: 4

ROLL CAGE

Mandatory. Must conform to SFI Spec 2.7. Plating of chassis prohibited. Chassis must be inspected every three years by NHRA and have a serialized sticker affixed to the frame before participation.

WEIGHT

No minimum weight.

WHEELBASE

Minimum 150 inches; maximum 190 inches on long side. Maximum wheelbase variation from left to right: 2 inches.

TIRES & WHEELS: 5

TIRES

Rear tires minimum: 20-inch diameter by 8 inches wide, as noted by size designation on sidewall of tire or by physical measurement at widest and tallest point.

ELECTRICAL: 8

BATTERIES

Dry or wet cell batteries permitted. Any battery weighing more than five pounds must be secured with minimum of two 3/8-inch-diameter bolts directly to frame or frame structure.

BUTTONS/SWITCHES

Entrants will be allowed to use multiple buttons and switches in the cockpit. One of these switches/buttons is for the master cutoff, which cannot be momentary. Additional switches may be used for the starter, data recorder, water pump, fan, fuel pump, etc. The use of line-locs, transbrakes, or downtrack stutter devices is prohibited, and no switch or associated wiring, solenoids, or any other component associated with these devices may be on the car.

IGNITION

Timed ignition-interruption devices (stutter boxes) prohibited. Two-step devices legal unto themselves, but altered or installed so as to function as a downtrack rpm controller, prohibited. Two-step must be activated by release of the clutch pedal/handle, brake pedal/handle, or brake pressure switch. The two-step switch may only be used for activation of the two-step. The two-step switch may not control or be wired into any other component on the car. The use of any multipoint rev limiter and/or rate of rpm acceleration

limiter of any description (whether stand-alone or a collection/combination of components) is prohibited. Ignition system may not be connected to the brake system, throttle control, or transmission shifter/position system. The use of an rpm-activated shift light is permitted on all cars. All wiring associated with the ignition system must be fully visible, labeled, and traceable.

SUPPORT GROUP: 9

DATA RECORDERS

Single-channel playback tachometers permitted. Any and all installed data recorders may only be connected to/record a maximum of four sensors/channels per run. Additional unconnected/non-used sensors may be on the vehicle. Data recorder may not activate or initiate any function of the vehicle. Other than data-recording functions built into NHRA-accepted ignition systems (such as the MSD SB6) that start data acquisition automatically, data recorder may not be activated by the throttle, brake, two-step, or any other mechanisms, nor by the Christmas Tree, radio transmitter, sensing of wheel speed, inertia, acceleration, laser device, or transmission of track position. Must be activated by separate switch by the driver or crewperson. Transmission or live-time display of any data gathered or processed by the data recorder to the driver (during the run) or remote relocation is prohibited. Data from any sensor connected to the data recorder, other than a playback tachometer, may not be displayed during the run. Data may be only reviewed after the run.

GAUGES/INSTRUMENTS

One tachometer, engine/cylinder head/water temperature, oil pressure, and fuel pressure gauge permitted. Speedometer of any description prohibited.

DRIVER: 10

AGE REQUIREMENTS

Drivers may compete from the day of their 14th birthday through the year of their 20th birthday. Car and driver older than 16 may compete in appropriate E.T. category.

CREDENTIALS

Valid NHRA Jr. Comp license required. License requires test runs and witnesses.

DRIVER RESTRAINT SYSTEM

Driver restraint system meeting SFI Spec 16.1 or 16.2 mandatory. Restraint system must be updated at two-year intervals from date of manufacture. When arm restraints are worn with restraint system that uses a "latch lever," a protective cover must be installed to prevent arm restraint from accidentally releasing the lever. Wrapping of belts around any framerail prohibited.

NECK COLLAR/HEAD AND NECK RESTRAINT DEVICE/SYSTEM

Beginning June 1, 2020, a head and neck restraint device/system meeting SFI 38.1 is mandatory and must display a valid SFI label. At all times that the driver is in the race vehicle, from the ready line until the vehicle is on the return road, driver must properly utilize an SFI 38.1 head and neck restraint device/system, including connecting the helmet as required for full functionality of the device. The SFI 38.1 head and neck restraint device/system, when connected, must conform to the manufacturer's mounting instructions, and it must be configured, maintained, and used in accordance with the manufacturer's instructions. A head and neck restraint device/system may be used with or without a neck collar. If the device/system is used without a neck collar, an SFI 3.3 head sock or SFI 3.3 skirted helmet mandatory.

PROTECTIVE EQUIPMENT

Jacket and pants meeting SFI Spec 3.2A/5, gloves meeting SFI Spec 3.3/1 mandatory for all drivers.

BECOME A MEMBER!



NHRA MEMBER BENEFITS INCLUDE:

- 12 issues of NHRA *National Dragster*
- 25% off subscription to NHRA.tv
- Up to \$40 OFF your tickets to your favorite NHRA Camping World Drag Racing Series events
- 10% OFF NHRA merchandise from NitroMall and NitroMall.com
- Official NHRA membership card, Exclusive NHRA Member T-shirt and NHRA Member Lanyard, a collector's pin and decal
- \$575,000 Excess Medical Insurance
- Plus more!

**For as little as \$78 per year,
you can become an NHRA Member.
Visit member.nhra.com for details**

BECOME A MEMBER || NHRA.com || 800.308.NHRA



Winning Takes Work. Getting Parts is Easy.

Summit Racing Equipment has the right mix of race parts to keep Jr. Drag Racers tearing up the track. There's engine and performance components, chassis and suspension, drivetrain, safety equipment, and much more so you can take that W!



And you'll get it all fast, at the lowest possible prices—guaranteed! Plus we can ship directly to the race track.

1.800.230.3030 SummitRacing.com®



**Proud to be the Title Sponsor of
NHRA Jr. Drag Racing League.**