

AALUX1 | ALUX™

MINI ARCHITECTURAL ALUMINUM BASEBOARD



THE SMALLEST IN ITS CLASS

A mini baseboard that lives up to the great expectations of designers, architects and engineers alike. Only 4 1/2 in. high and 2 in. deep, the AALUX1 can be installed in locations previously thought impossible. Discreetly blending into the decor, the AALUX1 mini architectural baseboard heater is solid, powerful and elegant all at once. Even though it is compact in size, the AALUX1 conforms to the strictest standards.

EXTRUDED ALUMINUM FRONT AND TOP COVER
WITH A UNIQUE, LUXURY DESIGN

EXTREMELY SOLID, IMPACT AND RUST RESISTANT

VERSATILE
ADAPTS TO ANY BUILDING'S ARCHITECTURE

PERSONALIZED INSTALLATION
BLANK SECTIONS, PEDESTALS AND CLEAN BACKS AVAILABLE

COLORS

- **standard:** white, soft white
- **luxury finish:** anodized aluminum (see price list)
- **ORORA (optional):** refer to www.stelpro.com/en-US/orora

FINISH

- epoxy-polyester powdercoat or anodized aluminum finish

MANUFACTURING

- 2 in. x 4 1/2 in. compact profile
- solid 20-gauge steel cabinet
- extremely resistant extruded aluminum front cover with a thickness equivalent to 10 gauge
- bottom air intake and top air discharge
- thermal protection with automatic reset
- full-length wireway

ELEMENT

- single tubular, stainless steel sheathed element with boxed aluminum fins for improved heat dissipation; the element is securely fastened at its centre, floating in nylon sleeves at each end, eliminating expansion and contraction noises

CONTROL

- wall thermostat (not included) – the use of an electronic thermostat is strongly recommended
- built-in tamper-proof thermostat accessible without removing front grille, installed in the left junction box only (optional)
- low voltage relay kit installed in the left junction box only (optional)

INSTALLATION

- surface mounted
- wall or floor mounted with or without pedestal kit (optional)
- at least 2 in. from the floor
- wiring compartment at both ends of unit
- for a continuous look, custom blank sections with a simple attachment system are available (optional)

WARRANTY

- three years

IDEAL FOR:

commercial building or shopping mall, hospital, office, private residence, hotel

°STELPRO

°STELPRO reserves the right to modify descriptions, manufacturing specifications or prices without prior notice. No returns accepted on optional-color products. For all the latest models and prices, please refer to our website at www.stelpro.com.



FC_AALUX1_US_061118

TECHNICAL SPECIFICATIONS

COMMERCIAL USE 150 W PER LINEAR FOOT			RESIDENTIAL USE 100 W PER LINEAR FOOT			VOLTAGE	LENGTH	WEIGHT	PRICE	
CODE	WATTS	BTU/H	CODE	WATTS	BTU/H	VOLTS	IN.	LB	W OR SW	CA
AALUX106031	300	1024	---	---	---	120	23 5/8	6.4	507.50	574.50
AALUX106038	300	1024	---	---	---	208	23 5/8	6.4	507.50	574.50
AALUX106032	300	1024	---	---	---	240	23 5/8	6.4	507.50	574.50
AALUX109041	450	1536	AALUX109031	300	1024	120	35 7/16	9.1	571.50	638.00
AALUX109048	450	1536	AALUX109038	300	1024	208	35 7/16	9.1	571.50	638.00
AALUX109042	450	1536	AALUX109032	300	1024	240	35 7/16	9.1	571.50	638.00
AALUX109047	450	1536	AALUX109037	300	1024	277	35 7/16	9.1	571.50	638.00
AALUX112061	600	2048	AALUX112041	400	1365	120	47 1/4	13.6	636.00	703.00
AALUX112068	600	2048	AALUX112048	400	1365	208	47 1/4	13.6	636.00	703.00
AALUX112062	600	2048	AALUX112042	400	1365	240	47 1/4	13.6	636.00	703.00
AALUX112067	600	2048	AALUX112047	400	1365	277	47 1/4	13.6	636.00	703.00
AALUX115071	750	2560	AALUX115051	500	1706	120	59 1/16	16.8	699.50	766.50
AALUX115078	750	2560	AALUX115058	500	1706	208	59 1/16	16.8	699.50	766.50
AALUX115072	750	2560	AALUX115052	500	1706	240	59 1/16	16.8	699.50	766.50
AALUX115077	750	2560	AALUX115057	500	1706	277	59 1/16	16.8	699.50	766.50
AALUX115075	750	2560	AALUX115055	500	1706	480	59 1/16	16.8	699.50	766.50
AALUX118091	900	3071	AALUX118061	600	2048	120	70 7/8	20.0	766.50	833.00
AALUX118098	900	3071	AALUX118068	600	2048	208	70 7/8	20.0	766.50	833.00
AALUX118092	900	3071	AALUX118062	600	2048	240	70 7/8	20.0	766.50	833.00
AALUX118097	900	3071	AALUX118067	600	2048	277	70 7/8	20.0	766.50	833.00
AALUX118095	900	3071	AALUX118065	600	2048	480	70 7/8	20.0	766.50	833.00
AALUX121101	1050	3583	AALUX121071	700	2388	120	82 11/16	23.1	830.00	897.00
AALUX121108	1050	3583	AALUX121078	700	2388	208	82 11/16	23.1	830.00	897.00
AALUX121102	1050	3583	AALUX121072	700	2388	240	82 11/16	23.1	830.00	897.00
AALUX121107	1050	3583	AALUX121077	700	2388	277	82 11/16	23.1	830.00	897.00
AALUX121105	1050	3583	AALUX121075	700	2388	480	82 11/16	23.1	830.00	897.00
AALUX124121	1200	4095	AALUX124081	800	2730	120	94 1/2	26.7	894.50	961.50
AALUX124128	1200	4095	AALUX124088	800	2730	208	94 1/2	26.7	894.50	961.50
AALUX124122	1200	4095	AALUX124082	800	2730	240	94 1/2	26.7	894.50	961.50
AALUX124127	1200	4095	AALUX124087	800	2730	277	94 1/2	26.7	894.50	1025.00
AALUX124125	1200	4095	AALUX124085	800	2730	480	94 1/2	26.7	894.50	961.50
AALUX127138	1350	4607	AALUX127098	900	3071	208	106 5/16	26.7	958.00	1025.00
AALUX127132	1350	4607	AALUX127092	900	3071	240	106 5/16	26.7	958.00	1025.00
AALUX127137	1350	4607	AALUX127097	900	3071	277	106 5/16	26.7	958.00	1025.00
AALUX127135	1350	4607	AALUX127095	900	3071	480	106 5/16	26.7	958.00	1025.00

Add W for white, SW for soft white or CA for clear anodized (finish) (consult the optional colors chart or contact your °STELPRO representative for all other colors).
 --- not available

TECHNICAL DRAWINGS

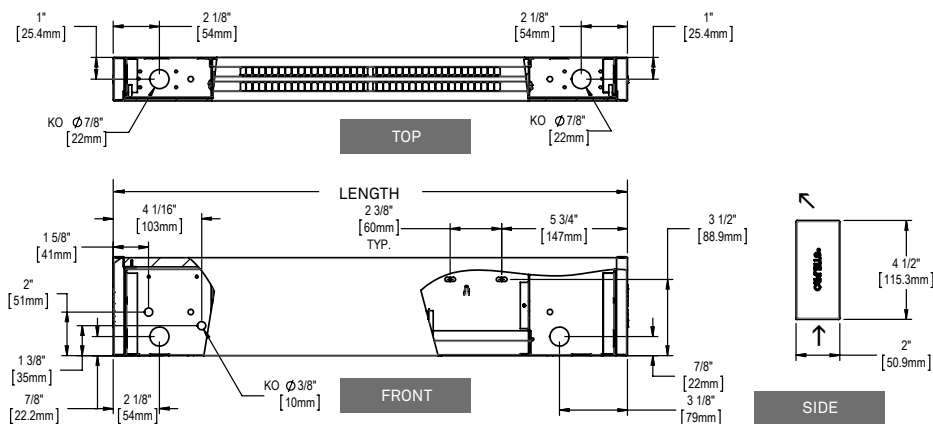

°STELPRO reserves the right to modify descriptions, manufacturing specifications or prices without prior notice. No returns accepted on optional-color products.
 For all the latest models and prices, please refer to our website at www.stelpro.com.



ACCESSORIES

PRODUCT	DESCRIPTION	PRICE
ALUX1T12*	built-in tamper-proof single pole thermostat	159.00
ALUX1RE153*	built-in electronic low voltage relay [15 A @ 120 V-347 V]	81.50
ALUX1RE156*	built-in electronic low voltage relay [6 A @ 600 V]	143.00
ALUX1RE153T*	built-in electronic low voltage relay c/w transformer 24 V [15 A @ 208 V-347 V]	110.00
ALUX1DIS250*	disconnect switch [120 V-250 V] [17 A @ 120 V-12 A @ 250 V]	152.50
ALUX1DIS600*	disconnect switch [277 V-600 V]	161.00
PK4*	pedestal kit – single (kit of two)	163.00
PK4CAP	anodized aluminum (paint) pedestal kit – single (kit of two)	185.50
PK4D*	pedestal kit – double (kit of two)	267.00
PK4DCAP	anodized aluminum (paint) pedestal kit – double (kit of two)	295.50
ALUX1JS*	joiner strip (2 in.)	142.00
ALUX1JSCAP	anodized aluminum (paint) joiner strip (2 in.)	156.00
ALUX1IC90*	inside corner (back measures 5 11/16 in. long on each side)	492.00
ALUX1IC90CA	anodized aluminum (finish) inside corner (back measures 5 11/16 in. long on each side)	540.50
ALUX1OC90*	outside corner (back measures 5 11/16 in. long on each side)	492.00
ALUX1OC90CA	anodized aluminum (finish) outside corner (back measures 5 11/16 in. long on each side)	540.50
ALUX1CB**	clean back (fully finished, no mounting holes or knockouts)	212.00

Electronic relays can receive a PWM (pulsed width modulation) or digital (on/off) signal

* Add W for white or SW for soft white

* Factory installed

