

MODEL E/R B-VENT CHIMNEY

Type B Gas Vent 3" - 8"



ECCO™ is proud to be a member of:



SMACNA
Sheet Metal and Air
Conditioning Contractors'
National Association
www.smacna.org



HRAI
Heating, Refrigeration and
Air Conditioning
Institute of Canada
www.hrai.ca



HARDI
Heating, Air-conditioning
& Refrigeration
Distributors International
www.hardinet.org



ADI
Air
Distribution
Institute
www.steelduct.org



AD
Affiliated Distributors™
www.adhq.com



CME
Canadian
Manufacturers &
Exporters
www.cme-mec.ca



SPIDA
Spiral Duct
Manufacturers
Association
www.spida.org



MODEL E/R TYPE B GAS VENT 3" – 8"

INDEX

ADAPTERS	
A-VENT TO B-VENT.....	B1-17
B-VENT TO B-VENT — BA.....	B1-16
FEMALE — B-VENT — FMA.....	B1-16
FEMALE — B-VENT — FMSA.....	B1-16
MALE — B-VENT — MA.....	B1-17
MALE — B-VENT — MSA.....	B1-17
ATTIC INSULATION SHIELDS — AIS.....	B1-9
COLLARS	
FINISHING — FC.....	B1-18
STORM — SC.....	B1-9
STORM — SPUN — SSC.....	B1-9
CONNECTORS	
B-VENT TO FLEX — BF.....	B1-16
B-VENT TO SINGLE WALL — BSW.....	B1-15
DRAFT HOOD — DHCI.....	B1-15
DRAFT HOOD — DHCH.....	B1-15
GAS VENT — FLEXIBLE — FGVC.....	B1-5
ELBOWS	
45 DEGREE — 45EL — 2 PIECE.....	B1-10
45 DEGREE — 45EL — 3 PIECE.....	B1-11
90 DEGREE — 90EL.....	B1-11
DIRECT CONNECT — 90 DEGREE.....	B1-11
FIRESTOP SPACERS — FS.....	B1-9
FLASHINGS	
ADJUSTABLE	
1/12 – 7/12 — AF.....	B1-7
1/12 – 7/12 — ARF — SOLDERED.....	B1-7
8/12 – 12/12 — AFS.....	B1-7
8/12 – 12/12 — ARF — SOLDERED.....	B1-7
FLAT — FF.....	B1-8
FLAT — PIPE SIZE — HOT WELDED.....	B1-8
GASKET — BUTYL (SEALANT TAPE).....	B1-17
INCREASERS — DOUBLE WALL — INC.....	B1-15
MODEL E/R TYPE 'B' GAS VENT 3" – 8"	
APPLICATION / DIAGRAM / INSTALLATION.....	B1-3 – B1-4
RAIN CAPS — RC.....	B1-8
SUPPORT PLATES — SP.....	B1-10
SUPPORT RINGS — SR.....	B1-10
TEE CAPS — SPUN — TC.....	B1-12
TEES	
DOUBLE WALL	
DWT.....	B1-12
DWT TAPER.....	B1-12
SINGLE WALL	
ALUMINUM — SWTA.....	B1-14
BASE — ALUMINUM — SWBTA.....	B1-13
BASE — GALVANIZED — SWBT.....	B1-13
GALVANIZED — SWT.....	B1-12
TYPE B GAS VENT KITS	
LESS DRAFT HOOD CONNECTOR.....	B1-19
WITH DRAFT HOOD CONNECTOR.....	B1-18
WITH SINGLE WALL BASE TEE.....	B1-19
TYPE B OVAL GAS VENT AND FITTINGS	
4".....	B1-20
5".....	B1-20
VENT PIPE — VP.....	B1-5
ADJUSTABLE — VPA.....	B1-6
ADJUSTABLE WITH CLAMP — VPAC.....	B1-6
WALL BANDS — WB.....	B1-18
WALL THIMBLES — ROUND PIPE.....	B1-20
WARRANTY.....	B1-21
WYES — SWIVEL — DOUBLE WALL — DWW.....	B1-14

LEGEND

NOTE: The boxed columns throughout the tables are intended to provide a quick determination of ordering dimensions.

ABBREVIATIONS: CTN/QTY = Carton Quantity
 WT/100 = Weight per 100 Pieces
 PCS/BNDL = Pieces per Bundle

– E.&O.E. – Subject to Change Without Notice – May Not Be Available At All Locations –

FINISH COLLAR



SUPPORT RING



SUPPORT PLATE

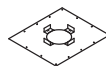

FIRE STOP SPACER



RAIN CAP



ALUMINUM TEE REDUCER WYFABS



Type B Gas Vent Installation Model E/R-Residential 3"-8"

ASSEMBLY

- 3", 4", 5" SIZES
- TO JOIN VENT PIPES, ALIGN THE SEAMS, SLIDE THE UPPER VENT OVER THE LOWER VENT AND ROTATE THE UPPER VENT 1/4 TURN TO THE LEFT

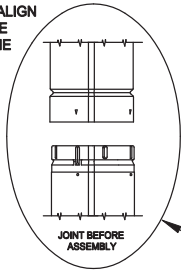

- 6", 7", 8" SIZES
- TO JOIN VENT PIPES, ALIGN THE SEAMS, SLIDE THE UPPER VENT OVER THE LOWER VENT AND SNAP LOCK IN PLACE

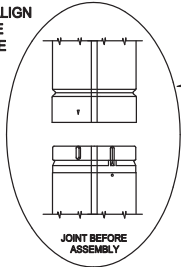

B-VENT TO B-VENT ADAPTOR



B-VENT TO FLEX CONNECTOR



DOUBLE WALL INCREASER



SINGLE WALL TEE



DRAFT HOOD CONNECTOR



SPUN PLUG/TCAP



CONSTRUCTION DETAILS

- ROLL FORMED FINISH**
- ELIMINATES SHARP EDGES
 - INTEGRATES THE INNER AND OUTER PIPE AS ONE UNIT

- LOCKING INDENTATION**
- ASSURES A SECURE CONNECTION

- POSITIVE CONNECT INDICATOR**
- ENSURES INSTALLER HAS ACHIEVED COMPLETE CONNECTION

- ALUMINUM INNER CONDUIT**
- RESISTS CORROSION

- 1/4" INSULATING AIR SPACE**
- ELIMINATES CONDENSATION, WHILE KEEPING THE OUTER CASING COOL

- GALVALUME OUTER CASING**
- PROVIDES STRENGTH AND DURABILITY

- LOCKING TABS**
- ASSURES POSITIVE CONNECTION

- HANGER PROVISION**
- PROVIDED ON EVERY VENT PIPE AND ELBOW
 - ALLOWS INSERTION OF HANGER STRAP FOR CONVENIENT SUPPORT OF THE VENT SYSTEM

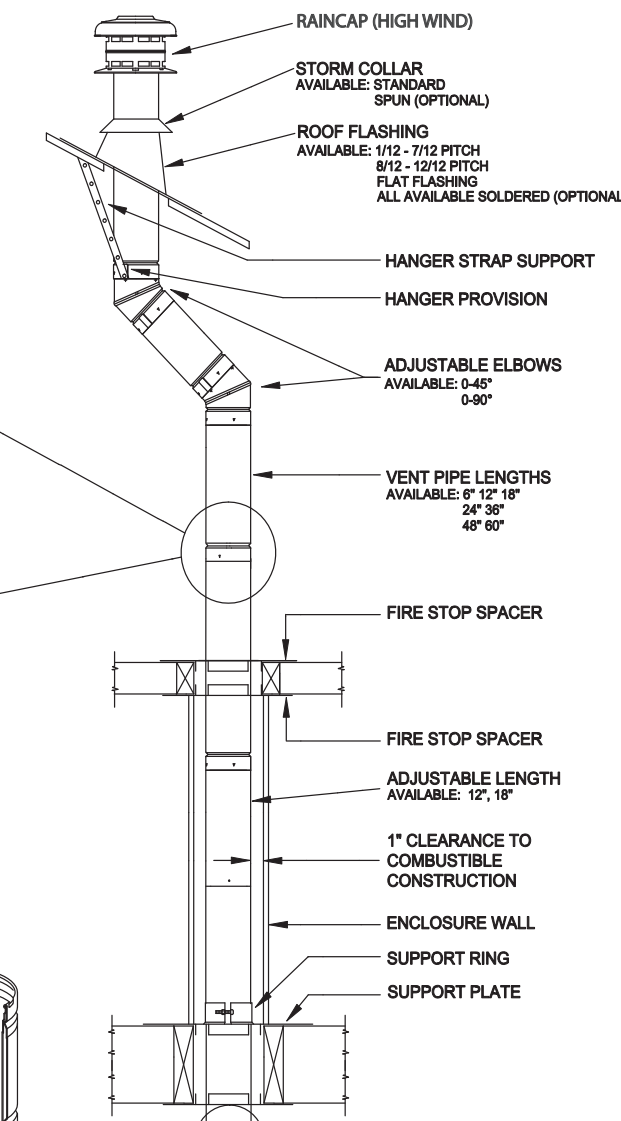

DOUBLE WALL TEE CUSTOM BRANCH SIZES AVAILABLE

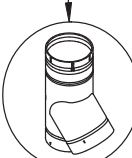

DOUBLE WALL WYE



SINGLE WALL TEE

DRAFT HOOD CONNECTOR (C-VENT ADAPTOR)

STORM COLLAR



FLAT ROOF FLASHING



ADJUSTABLE ROOF FLASHING 8/12 - 7/12 PITCH



ADJUSTABLE ROOF FLASHING 12/12 PITCH



B-VENT PIPE



ADJUSTABLE B-VENT PIPE



DOUBLE WALL ELBOW 45°



- E.&O.E. - Subject to Change Without Notice - May Not Be Available At All Locations -

ECCO Manufacturing PRINTED IN CANADA 29/02/08 J0



MODEL E/R TYPE B GAS VENT 3" – 8"

MODEL E/R TYPE 'B' GAS VENT 3" – 8"

APPLICATION / INSTALLATION

Vent sizing and installation are to be made in accordance with the applicable codes shown below.

In USA

Connection to appliance and vent sizing to be in accordance with the NATURAL FUEL GAS CODE, ANSI Z223.1 (NFPA 54), NFPA 211, GAMA VENTING TABLES, and/or the requirements of the local authorities having jurisdiction.



In Canada

Connection to appliance and vent sizing to be in accordance with the NATURAL GAS INSTALLATION CODE, CAN/CGA-B149.1 or the PROPANE INSTALLATION CODE, CAN/CGA-B149.2 and/or the requirements of the local authorities having jurisdiction.



Tested to UL441 "Gas Vent" basic standard.

ECCO Type B Gas Vent and accessories are for venting listed Natural Gas or Liquid Propane Category 1 appliances only. ECCO Type B Gas Vent Systems may be used on other gas-burning appliances, providing the appliance is certified for use with Type B Gas Vent, the installation conforms to the appliance manufacturer's certified installation instructions, and the installation is acceptable to the requirements of the local authority having jurisdiction. Type B Gas Vent shall not be used to vent flue products from incinerators, combination gas/oil appliances, oil-fired, or wood-burning appliances. If there is a question about the use of Type B Gas Vents, contact the appliance manufacturer, the authority having jurisdiction, or ECCO Manufacturing™ for further information.

TABLE OF 45° OFFSETS (for attic area where required)

Use this table to determine the maximum offset produced by two 45° elbows and one length of vent pipe.

NOTE: Maximum Offsets for 4", 5", and 6" elbows are at 60°

Offset

VENT SIZE	LENGTH USED							
	NONE	6"	12"	18"	24"	36"	48"	60"
3	3-1/2	6-5/8	10-7/8	15-1/8	19-3/8	27-3/4	36-1/4	44-3/4
4	6-1/4	10	15-1/4	20-3/8	25-5/8	36	46-3/8	56-3/4
5	6-3/4	10-1/2	15-3/4	20-7/8	26-1/8	36-1/2	46-7/8	57-1/4
6	7-3/8	11-1/8	16-3/8	21-1/2	26-3/4	37-1/8	47-1/2	57-7/8
7	5	8-1/8	12-3/8	16-5/8	20-7/8	29-1/4	37-3/4	46-1/4
8	5-1/2	8-5/8	12-7/8	17-1/8	21-3/8	29-3/4	38-1/4	46-3/4

Vertical Rise

VENT SIZE	LENGTH USED							
	NONE	6"	12"	18"	24"	36"	48"	60"
3	8-3/8	11-1/2	15-3/4	20	24-1/4	32-5/8	41-1/8	49-5/8
4	10-3/4	13	16	19	22	28	34	40
5	11-3/4	14	17	20	23	29	35	41
6	12-1/2	14-3/4	17-3/4	20-3/4	23-3/4	29-3/4	35-3/4	41-3/4
7	11-7/8	15	19-1/4	23-1/2	27-3/4	36-1/8	44-5/8	53-1/8
8	12-5/8	15-3/4	20	24-1/4	28-1/2	36-7/8	45-3/8	53-7/8

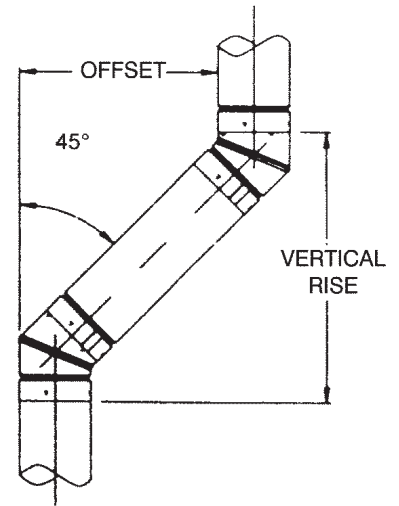

- E.&O.E. - Subject to Change Without Notice - May Not Be Available At All Locations -



MODEL E/R TYPE B GAS VENT 3" – 8"

GAS VENT CONNECTORS — FLEXIBLE — FGVC

ITEM #	MODEL #	A (")	B (")	C (")	CTN/QTY	WT/100
200392	3" x 24"	3	3-1/2	24	25	130
200393	3" x 36"	3	3-1/2	36	16	230
200394	3" x 48"	3	3-1/2	48	16	290
200395	3" x 60"	3	3-1/2	60	16	345
200492	4" x 24"	4	4-1/2	24	16	220
200493	4" x 36"	4	4-1/2	36	9	300
200494	4" x 48"	4	4-1/2	48	9	365
200495	4" x 60"	4	4-1/2	60	9	445
210592	5" x 24"	5	5-1/2	24	12	260
210593	5" x 36"	5	5-1/2	36	9	345
210594	5" x 48"	5	5-1/2	48	9	435
210595	5" x 60"	5	5-1/2	60	9	510

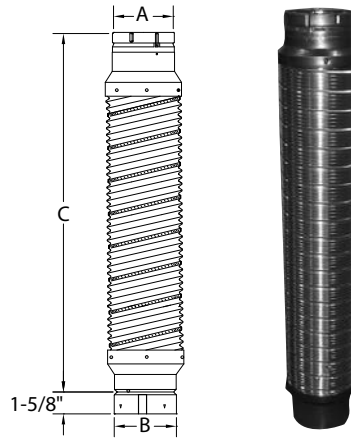

VENT PIPE — VP

ITEM #	MODEL #	A (")	B (")	C (")	CTN/QTY	WT/100
200301	360VP	3	3-1/2	58-3/8	8	475
200401	460VP	4	4-1/2	58-3/8	6	600
210501	560VP	5	5-1/2	58-3/8	6	700
210601	660VP	6	6-1/2	58-3/8	6	900
220701	760VP	7	7-1/2	58-3/8	3	1008
220801	860VP	8	8-1/2	58-3/8	3	1100

NOTE: Dimension C is installed length. Nominal length is 60".

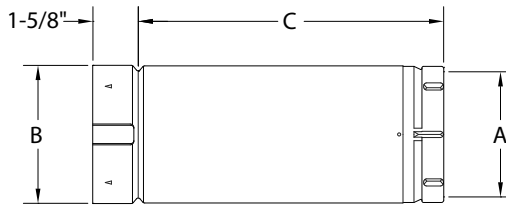

ITEM #	MODEL #	A (")	B (")	C (")	CTN/QTY	WT/100
200350	348VP	3	3-1/2	46-3/8	4	375
200450	448VP	4	4-1/2	46-3/8	6	500
210550	548VP	5	5-1/2	46-3/8	6	600
210650	648VP	6	6-1/2	46-3/8	6	675
220750	748VP	7	7-1/2	46-3/8	4	775
220850	848VP	8	8-1/2	46-3/8	4	900

NOTE: Dimension C is installed length. Nominal length is 48".

ITEM #	MODEL #	A (")	B (")	C (")	CTN/QTY	WT/100
200302	336VP	3	3-1/2	34-3/8	4	275
200402	436VP	4	4-1/2	34-3/8	6	375
210502	536VP	5	5-1/2	34-3/8	6	450
210602	636VP	6	6-1/2	34-3/8	6	525
220702	736VP	7	7-1/2	34-3/8	4	600
220802	836VP	8	8-1/2	34-3/8	4	700

NOTE: Dimension C is installed length. Nominal length is 36".

ITEM #	MODEL #	A (")	B (")	C (")	CTN/QTY	WT/100
200352	324VP	3	3-1/2	22-3/8	8	200
200452	424VP	4	4-1/2	22-3/8	6	250
210552	524VP	5	5-1/2	22-3/8	6	300
210652	624VP	6	6-1/2	22-3/8	6	350
220752	724VP	7	7-1/2	22-3/8	8	400
220852	824VP	8	8-1/2	22-3/8	8	450

NOTE: Dimension C is installed length. Nominal length is 24".

ITEM #	MODEL #	A (")	B (")	C (")	CTN/QTY	WT/100
200303	318VP	3	3-1/2	16-3/8	8	150
200403	418VP	4	4-1/2	16-3/8	8	200
210503	518VP	5	5-1/2	16-3/8	8	225
210603	618VP	6	6-1/2	16-3/8	8	275
220703	718VP	7	7-1/2	16-3/8	8	325
220803	818VP	8	8-1/2	16-3/8	8	350

NOTE: Dimension C is installed length. Nominal length is 18".

ITEM #	MODEL #	A (")	B (")	C (")	CTN/QTY	WT/100
200304	312VP	3	3-1/2	10-3/8	12	100
200404	412VP	4	4-1/2	10-3/8	12	125
210504	512VP	5	5-1/2	10-3/8	12	150
210604	612VP	6	6-1/2	10-3/8	12	200
220704	712VP	7	7-1/2	10-3/8	12	225
220804	812VP	8	8-1/2	10-3/8	12	250

NOTE: Dimension C is installed length. Nominal length is 12".

ITEM #	MODEL #	A (")	B (")	C (")	CTN/QTY	WT/100
200356	306VP	3	3-1/2	4-3/8	10	50
200456	406VP	4	4-1/2	4-3/8	10	80
210556	506VP	5	5-1/2	4-3/8	10	80
210656	606VP	6	6-1/2	4-3/8	10	100
220756	706VP	7	7-1/2	4-3/8	8	125
220856	806VP	8	8-1/2	4-3/8	8	125

NOTE: Dimension C is installed length. Nominal length is 6".

We have custom capabilities to manufacture any sizes you may require. Contact factory for special sizes and configurations not listed.

– E.&O.E. – Subject to Change Without Notice – May Not Be Available At All Locations –



MODEL E/R TYPE B GAS VENT 3" – 8"

VENT PIPE ADJUSTABLE — VPA

ITEM #	MODEL #	A (")	B (")	C (")	CTN/QTY	WT/100
200305	312VPA	3	3-5/8	12	12	100
200405	412VPA	4	4-5/8	12	12	125
210505	512VPA	5	5-5/8	12	12	150
210605	612VPA	6	6-5/8	12	12	200
220705	712VPA	7	7-5/8	12	12	225
220805	812VPA	8	8-5/8	12	12	250

NOTE: 12" lengths adjust from 4" to 10". Includes sheet metal screws.

ITEM #	MODEL #	A (")	B (")	C (")	CTN/QTY	WT/100
200326	318VPA	3	3-5/8	18	8	150
200426	418VPA	4	4-5/8	18	8	200
210526	518VPA	5	5-5/8	18	8	225
210626	618VPA	6	6-5/8	18	8	275
220726	718VPA	7	7-5/8	18	8	325
220826	818VPA	8	8-5/8	18	8	350

NOTE: 18" lengths adjust from 4" to 16". Includes sheet metal screws.

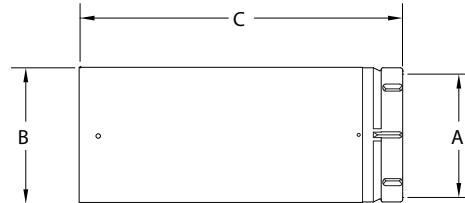

VENT PIPE ADJUSTABLE WITH CLAMP — VPAC

ITEM #	MODEL #	A (")	B (")	C (")	CTN/QTY	WT/100
200396	312VPAC	3	3-5/8	12	12	100
200496	412VPAC	4	4-5/8	12	12	125
210596	512VPAC	5	5-5/8	12	12	150
210696	612VPAC	6	6-5/8	12	12	200
220796	712VPAC	7	7-5/8	12	12	225
220896	812VPAC	8	8-5/8	12	12	250

ITEM #	MODEL #	A (")	B (")	C (")	CTN/QTY	WT/100
200397	318VPAC	3	3-5/8	18	8	150
200497	418VPAC	4	4-5/8	18	8	200
210597	518VPAC	5	5-5/8	18	8	225
210697	618VPAC	6	6-5/8	18	8	275
220797	718VPAC	7	7-5/8	18	8	325
220897	818VPAC	8	8-5/8	18	8	350

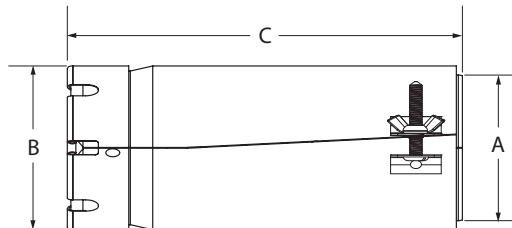

We have custom capabilities to manufacture any sizes you may require. Contact factory for special sizes and configurations not listed.

– E.&O.E. – Subject to Change Without Notice – May Not Be Available At All Locations –



MODEL E/R TYPE B GAS VENT 3" - 8"

FLASHINGS — ADJUSTABLE — 1/12 — 7/12 — AF

ITEM #	MODEL #	SIZE (")	A (")	B (")	C (")	D (")	CTN/QTY	WT/100
200308	3AF	3	15 × 15	3-5/8	7	4	10	160
200408	4AF	4	16 × 16	4-5/8	8	4	10	180
210508	5AF	5	17 × 17	5-5/8	9	4	10	200
210608	6AF	6	18 × 18	6-5/8	10	4	10	230
220708	7AF	7	19-1/2 × 19-1/2	7-5/8	11-1/2	4	8	275
220808	8AF	8	20-1/2 × 20-1/2	8-5/8	12-1/2	4	8	300

NOTE: Soldered roof flashings available upon request.

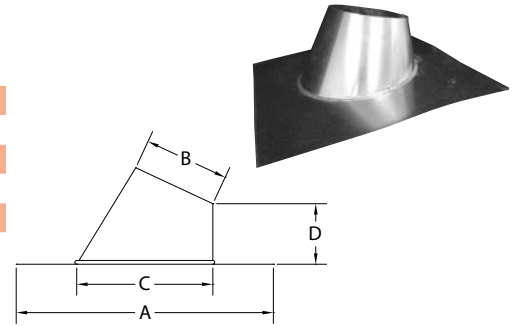

FLASHINGS — ADJUSTABLE — 8/12 — 12/12 — AFS

ITEM #	MODEL #	SIZE (")	A (")	B (")	C (")	D (")	CTN/QTY	WT/100
200328	3AFS	3	18 × 18	3-5/8	9-3/8	4	10	250
200428	4AFS	4	19-1/2 × 19-1/2	4-5/8	10-5/8	4	10	260
210528	5AFS	5	20-3/4 × 20-3/4	5-5/8	12	4	10	300
210628	6AFS	6	21-3/8 × 21-3/8	6-5/8	13-3/8	4	10	340
220728	7AFS	7	23 × 23	7-5/8	15	4	5	400
220828	8AFS	8	24-3/8 × 24-3/8	8-5/8	16-3/8	4	5	440

NOTE: Soldered roof flashings available upon request.

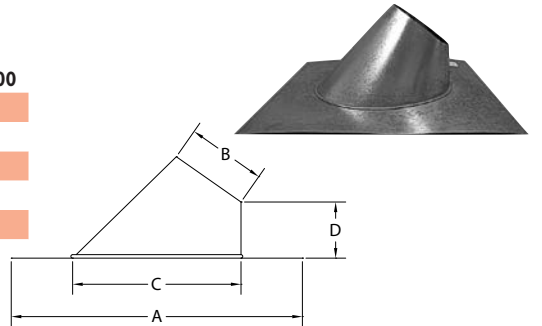

FLASHINGS — ADJUSTABLE — 1/12 — 7/12 — ARF — SOLDERED

ITEM #	MODEL #	A (")	B (")	C (")	CTN/QTY	WT/100
200369	3ARF	15 × 15	3-5/8	7	10	160
200469	4ARF	16 × 16	4-5/8	8	10	180
210569	5ARF	17 × 17	5-5/8	9	10	200
210669	6ARF	18 × 18	6-5/8	10	10	230
220769	7ARF	19-1/2 × 19-1/2	7-5/8	11-1/2	8	275
220869	8ARF	20-1/2 × 20-1/2	8-5/8	12-1/2	8	300

NOTE: All seams are soldered.

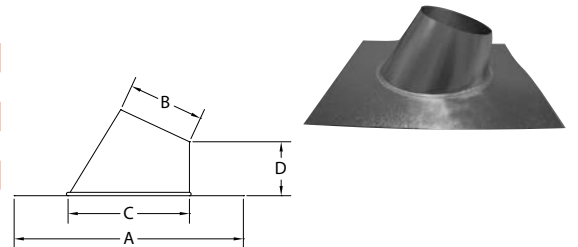

FLASHINGS — ADJUSTABLE — 8/12 — 12/12 — ARF — SOLDERED

ITEM #	MODEL #	A (")	B (")	C (")	CTN/QTY	WT/100
200370	3ARF	18 × 18	3-5/8	9-3/8	10	250
200470	4ARF	19-1/2 × 19-1/2	4-5/8	10-5/8	10	260
210570	5ARF	20-3/4 × 20-3/4	5-5/8	12	10	300
210670	6ARF	21-3/8 × 21-3/8	6-5/8	13-3/8	10	340
220770	7ARF	23 × 23	7-5/8	15	5	400
220870	8ARF	24-3/8 × 24-3/8	8-5/8	16-3/8	5	580

NOTE: All seams are soldered.

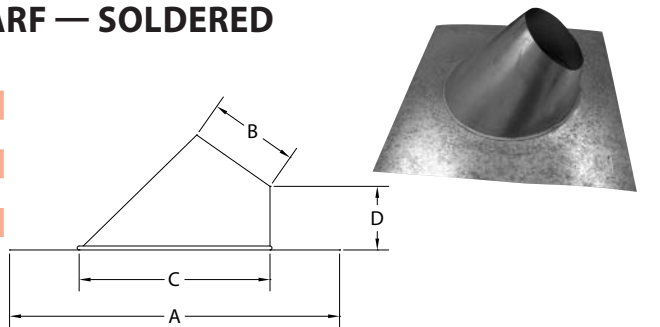

We have custom capabilities to manufacture any sizes you may require. Contact factory for special sizes and configurations not listed.

— E.&O.E. — Subject to Change Without Notice — May Not Be Available At All Locations —



MODEL E/R TYPE B GAS VENT 3" – 8"

FLASHINGS — FLAT — FF

ITEM #	MODEL #	SIZE (")	A (")	B (")	C (")	D (")	CTN/QTY	WT/100
200309	3FF	3	16 × 16	3-5/8	8	10	5	300
200409	4FF	4	16 × 16	4-5/8	8	10	5	320
210509	5FF	5	18 × 18	5-5/8	10	10	5	360
210609	6FF	6	18 × 18	6-5/8	10	10	5	360
220709	7FF	7	20 × 20	7-5/8	12	10	5	420
220809	8FF	8	20 × 20	8-5/8	12	10	5	420

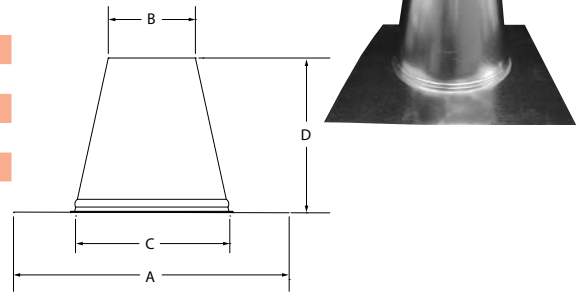

NOTE: All seams are soldered.

FLASHINGS — FLAT — PIPE SIZE — HOT WELDED

ITEM #	DESCRIPTION	SIZE (")	A (")	B (")	C (")	CTN/QTY	WT/100
131382	10" H/W Flat Flashing Pipe Size	10	20	10-1/2	12	*	400
131383	12" H/W Flat Flashing Pipe Size	12	22	12-1/2	14	*	520

* Product shipped individually.

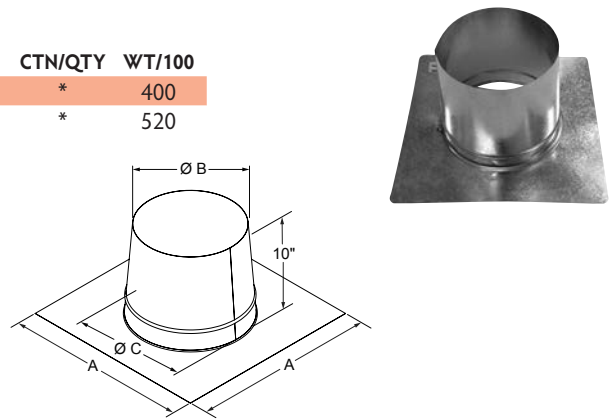

RAIN CAPS — RC

ITEM #	MODEL #	A (")	B (")	C (")	CTN/QTY	WT/100
200306	3RC	3	8	6-1/8	10	40
200406	4RC	4	9-3/8	6-1/8	16	90
210506	5RC	5	10-3/4	7	16	100
210606	6RC	6	12-3/8	7	8	120
220706	7RC	7	14	7-3/4	8	140
220806	8RC	8	15-5/8	7-3/4	6	160

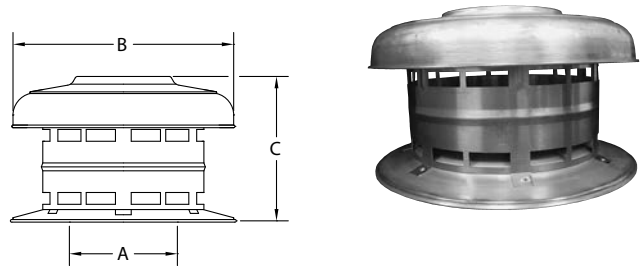

We have custom capabilities to manufacture any sizes you may require. Contact factory for special sizes and configurations not listed.

– E.&O.E. – Subject to Change Without Notice – May Not Be Available At All Locations –



MODEL E/R TYPE B GAS VENT 3" – 8"

STORM COLLARS — SC

ITEM #	MODEL #	SIZE (")	A (")	B (")	PCS/BNDL	WT/100
200307	3SC	3	6-1/4	3-1/2	10	20
200407	4SC	4	7-1/4	4-1/2	10	26
210507	5SC	5	8-1/4	5-1/2	10	27
210607	6SC	6	9-1/4	6-1/2	10	30
220707	7SC	7	10-1/4	7-1/2	8	34
220807	8SC	8	11-1/4	8-1/2	8	38

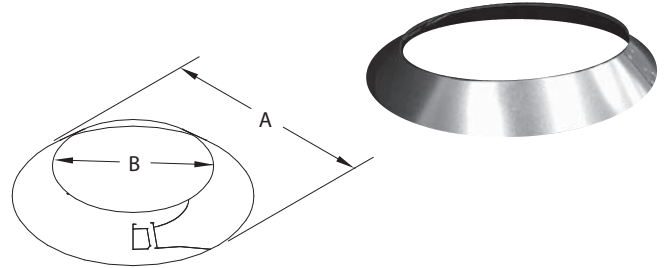

STORM COLLARS — SPUN — SSC

ITEM #	MODEL #	SIZE (")	A (")	B (")	CTN/QTY	WT/100
200390	3SSC	3	6-3/4	3-1/2	50	14
200490	4SSC	4	7-3/4	4-1/2	50	18
210590	5SSC	5	8-3/4	5-1/2	50	22
210690	6SSC	6	9-3/4	6-1/2	50	26
220790	7SSC	7	10-3/4	7-1/2	50	36
220890	8SSC	8	11-3/4	8-1/2	50	44

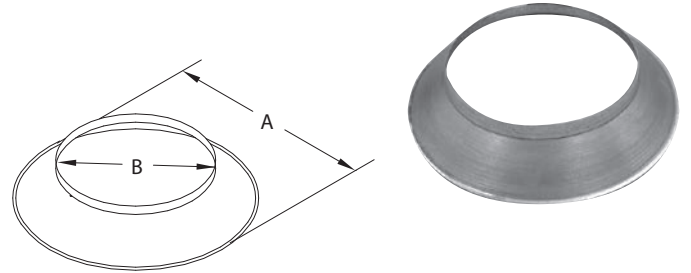

ATTIC INSULATION SHIELDS — AIS

ITEM #	MODEL #	A (")	B (")	CTN/QTY	WT/100
200316	3AIS	3-5/8	5-3/4	1	335
200416	4AIS	4-5/8	6-3/4	1	365
210516	5AIS	5-5/8	7-3/4	1	395
210616	6AIS	6-5/8	8-3/4	1	425
220716	7AIS	7-5/8	9-3/4	1	455
220816	8AIS	8-5/8	10-3/4	1	485

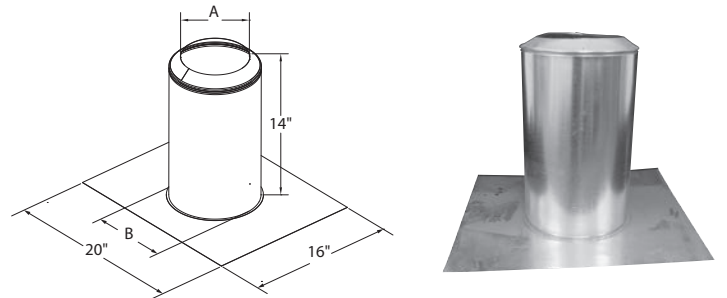

FIRESTOP SPACERS — FS

ITEM #	MODEL #	SIZE (")	A (")	B (")	C (")	CTN/QTY	WT/100
200310	3FS	3	5-5/8 × 5-5/8	3-5/8	13	20	100
200410	4FS	4	6-5/8 × 6-5/8	4-5/8	13	20	100
210510	5FS	5	7-5/8 × 7-5/8	5-5/8	13	20	95
210610	6FS	6	8-5/8 × 8-5/8	6-5/8	13	20	90
220710	7FS	7	9-5/8 × 9-5/8	7-5/8	13	16	75
220810	8FS	8	10-5/8 × 10-5/8	8-5/8	13	5	75

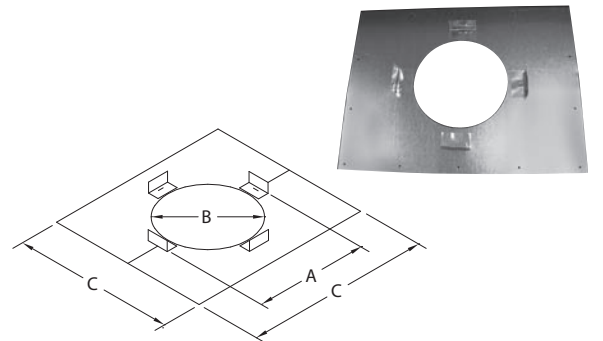

NOTE: Firestop Spacers are required above and below each floor and ceiling level penetrated by the vent.

We have custom capabilities to manufacture any sizes you may require. Contact factory for special sizes and configurations not listed.

– E.&O.E. – Subject to Change Without Notice – May Not Be Available At All Locations –



MODEL E/R TYPE B GAS VENT 3" – 8"

SUPPORT PLATES — SP

ITEM #	MODEL #	SIZE (")	A (")	B (")	C (")	D (")	E (")	CTN/QTY	WT/100
200317	3SP	3	5-5/8 × 5-5/8	3-5/8	13	17	4	10	210
200417	4SP	4	6-5/8 × 6-5/8	4-5/8	13	17	4	10	200
210517	5SP	5	7-5/8 × 7-5/8	5-5/8	13	17	4	10	200
210617	6SP	6	8-5/8 × 8-5/8	6-5/8	13	17	4	10	200
220717	7SP	7	9-5/8 × 9-5/8	7-5/8	13	17	4	8	200
220817	8SP	8	10-5/8 × 10-5/8	8-5/8	13	17	4	8	150

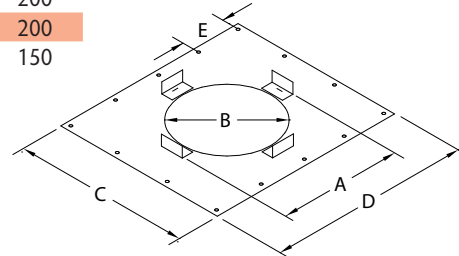
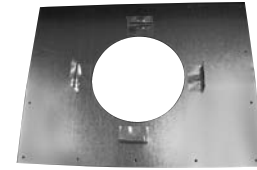

NOTE: Support Plate and Support Ring required for every 30 feet of vent height.

SUPPORT RINGS — SR

ITEM #	MODEL #	SIZE (")	A (")	CTN/QTY	WT/100
200318	3SR	3	3-1/2	20	25
200418	4SR	4	4-1/2	20	30
210518	5SR	5	5-1/2	20	40
210618	6SR	6	6-1/2	20	50
220718	7SR	7	7-1/2	16	50
220818	8SR	8	8-1/2	16	50

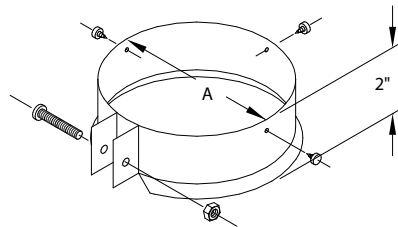

NOTE: Support Plate and Support Ring required for every 30 feet of vent height.
Includes sheet metal Screws and Assembly Bolt for installation.

ELBOWS — 45 DEGREE — 45EL — 2 PIECE

ITEM #	MODEL #	A (")	B (")	C (")	D (")	E (")	F (")	G (")	CTN/QTY	WT/100
220713	745EL	7	7-1/2	3	4-1/4	3-3/8	5	11-7/8	12	175
220813	845EL	8	8-1/2	3-1/4	4-1/2	3-3/8	5-1/2	12-5/8	12	200



NOTE: Adjustable 0 deg. to 45 deg. Two piece construction. Dimension G is installed length.

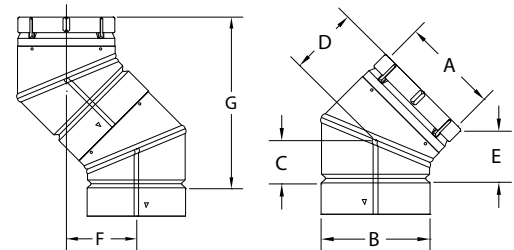

We have custom capabilities to manufacture any sizes you may require. Contact factory for special sizes and configurations not listed.

– E.&O.E. – Subject to Change Without Notice – May Not Be Available At All Locations –



MODEL E/R TYPE B GAS VENT 3" - 8"

ELBOWS — 45 DEGREE — 45EL — 3 PIECE

ITEM #	MODEL #	A (")	B (")	C (")	D (")	E (")	F (")	G (")	CTN/QTY	WT/100
200313	345EL	3	3-1/2	3	3-7/8	3-1/8	6-1/4	9-5/8	12	65
200413	445EL	4	4-1/2	3	4-1/4	3-1/8	6-1/4	10-3/4	10	100
210513	545EL	5	5-1/2	3-1/4	4-5/8	3-1/4	6-3/4	11-3/4	10	100
210613	645EL	6	6-1/2	3-1/2	5	3-1/4	7-3/8	12-1/2	10	125

NOTE: Adjustable 0 deg. to 60 deg. Three piece construction. Dimension G is installed length.

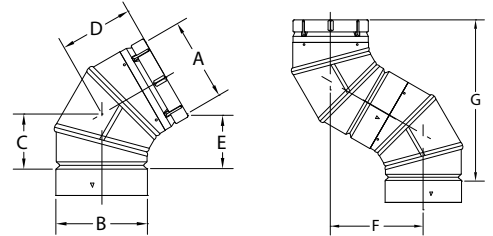

ELBOWS — 90 DEGREE — 90EL

ITEM #	MODEL #	A (")	B (")	C (")	D (")	E (")	F (")	CTN/QTY	WT/100
200314	390EL	3	3-1/2	5-1/4	4-1/4	2	7-3/8	8	100
200414	490EL	4	4-1/2	6	4-5/8	2-1/4	8-5/8	10	125
210514	590EL	5	5-1/2	6-5/8	5	2-1/2	9-3/8	8	175
210614	690EL	6	6-1/2	6-5/8	5	2-3/4	9-3/4	8	200
220714	790EL	7	7-1/2	7-1/2	7-1/2	3	11-1/4	8	275
220814	890EL	8	8-1/2	8-1/4	6-5/8	3	11-3/4	6	300

NOTE: Adjustable 0 deg. to 90 deg. Dimension F is installed length.

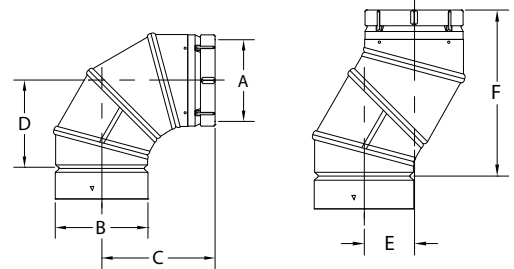

ELBOWS — DIRECT CONNECT — 90 DEGREE

ITEM #	MODEL #	A (")	B (")	C (")	D (")	E (")	F (")	CTN/QTY	WT/100
200380	3DCE	3	3-1/2	5-1/4	4-1/4	2	7-3/8	8	100
200480	4DCE	4	4-1/2	6	4-5/8	2-1/4	8-5/8	10	125

NOTE: Inner Liner flared to directly connect to appliance.

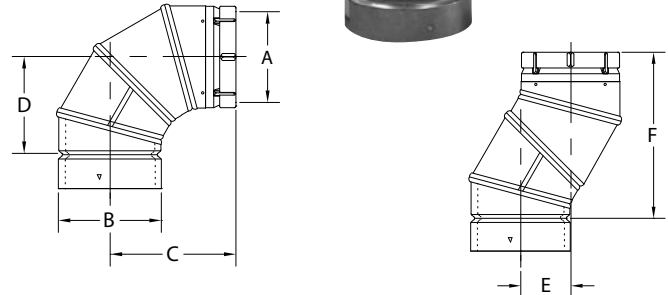

We have custom capabilities to manufacture any sizes you may require. Contact factory for special sizes and configurations not listed.

-E.&O.E. - Subject to Change Without Notice - May Not Be Available At All Locations -



MODEL E/R TYPE B GAS VENT 3" - 8"

TEES — DOUBLE WALL — DWT

ITEM #	MODEL #	A (")	B (")	C (")	D (")	E (")	F (")	CTN/QTY	WT/100
200312	3DWT	3	3-1/2	3	3	2-3/4	7-1/8	6	100
200412	4DWT	4	4-1/2	4	3-1/2	3-1/4	8-1/8	6	200
210512	5DWT	5	5-1/2	5	4	3-3/4	9-1/8	8	200
210545	5DWT3	5	5-1/2	3	4	2-3/4	7-1/8	8	200
210544	5DWT4	5	5-1/2	4	4	3-1/4	8-1/8	6	200
210612	6DWT	6	6-1/2	6	4-1/2	4-1/4	10-1/8	6	250
210642	6DWT63	6	6-1/2	3	4-1/2	2-3/4	7-1/8	6	250
210644	6DWT4	6	6-1/2	4	4-1/2	3-1/4	8-1/8	6	250
210645	6DWT5	6	6-1/2	5	4-1/2	3-3/4	9-1/8	6	275
220712	7DWT	7	7-1/2	7	5	4-3/4	11-1/8	6	300
220774	7DWT4	7	7-1/2	4	5	3-1/4	8-1/8	6	300
220743	7DWT5	7	7-1/2	5	5	3-3/4	9-1/8	6	260
220742	7DWT6	7	7-1/2	6	5	4-1/4	10-1/8	6	300
220812	8DWT	8	8-1/2	8	5-1/2	5-1/4	12-1/8	6	400

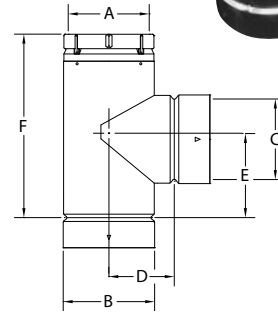

NOTE: Dimension F is installed length. Tee Cap not included.

TEES — DOUBLE WALL — DWT TAPER

ITEM #	MODEL #	A (")	B (")	C (")	D (")	E (")	F (")	CTN/QTY	WT/100
210542	5DWT43	5	4-1/2	3	4-1/4	4-1/2	9-7/8	8	190
210543	5DWT44	5	4-1/2	4	4-1/4	4-1/2	9-7/8	8	190
210643	6DWT54	6	5-1/2	4	4-1/4	5	11	8	215

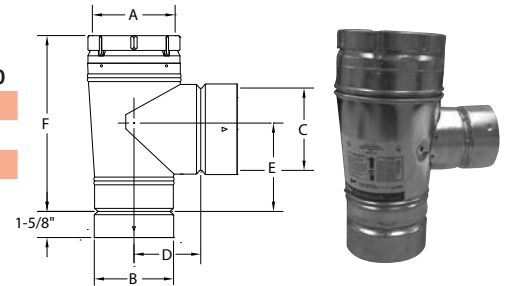

NOTE: Dimension F is installed length.

TEES — SINGLE WALL — GALVANIZED — SWT

ITEM #	MODEL #	A (")	B (")	C (")	D (")	E (")	F (")	CTN/QTY	WT/100
200311	3SWT	3	3-1/2	3	4	6	12	10	110
200411	4SWT	4	4-1/2	4	5	6	12	10	150

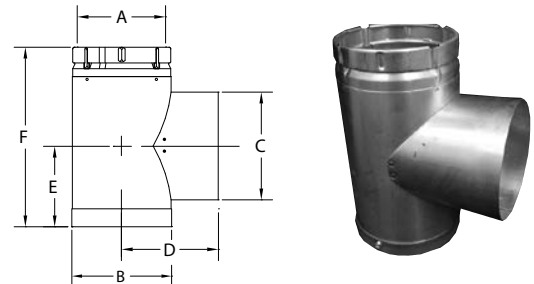

TEE CAPS — SPUN — TC

ITEM #	MODEL #	A (")	CTN/QTY	WT/100
570326	3TC	3	20	20
570426	4TC	4	20	26
570526	5TC	5	20	35
570626	6TC	6	20	46
570726	7TC	7	20	60
570826	8TC	8	20	72

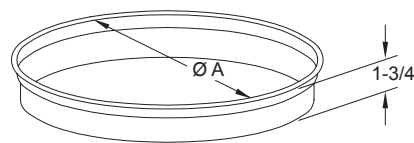

We have custom capabilities to manufacture any sizes you may require. Contact factory for special sizes and configurations not listed.

- E.&O.E. - Subject to Change Without Notice - May Not Be Available At All Locations -



MODEL E/R TYPE B GAS VENT 3" - 8"

TEES — SINGLE WALL BASE — GALVANIZED — SWBT

ITEM #	MODEL #	A (")	B (")	C (")	D (")	E (")	F (")	G (")	H (")	CTN/QTY	WT/100
200422	4SWT43	4	4-1/2	15-3/8	4-1/4	7	5	3	4	10	180
210522	5SWT43	5	5-1/2	15-3/8	4-1/4	7	5-1/2	3	4	10	230
210524	5SWT44	5	5-1/2	15-3/8	4-1/4	7	5-1/2	4	4	10	200
210511	5SWT53	5	5-1/2	15-3/8	4-1/4	7	5-1/2	3	5	10	240
210523	5SWT54	5	5-1/2	15-3/8	4-1/4	7	5-1/2	4	5	10	240
210525	5SWT55	5	5-1/2	15-3/8	4-1/4	7	5-1/2	5	5	10	240
210625	6SWT44	6	6-1/2	15-3/8	4-1/4	7	6	4	4	10	230
210622	6SWT53	6	6-1/2	15-3/8	4-1/4	7	6	3	5	10	250
210624	6SWT54	6	6-1/2	15-3/8	4-1/4	7	6	4	5	10	275
210621	6SWT55	6	6-1/2	15-3/8	4-1/4	7	6	5	5	10	251
210611	6SWT63	6	6-1/2	15-3/8	4-1/4	7	6	3	6	10	250
210623	6SWT64	6	6-1/2	15-3/8	4-1/4	7	6	4	6	10	250
210620	6SWT65	6	6-1/2	15-3/8	4-1/4	7	6	5	6	10	250
210627	6SWT66	6	6-1/2	15-3/8	4-1/4	7	6	6	6	10	250
220722	7SWT53	7	7-1/2	15-3/8	4-1/4	7	6-1/2	3	5	10	300
220720	7SWT55	7	7-1/2	15-3/8	4-1/4	7	6-1/2	5	5	10	300
220723	7SWT63	7	7-1/2	15-3/8	4-1/4	7	6-1/2	3	6	10	300
220725	7SWT64	7	7-1/2	15-3/8	4-1/4	7	6-1/2	4	6	10	300
220711	7SWT73	7	7-1/2	15-3/8	4-1/4	7	6-1/2	3	7	10	300
220724	7SWT74	7	7-1/2	15-3/8	4-1/4	7	6-1/2	4	7	10	300
220721	7SWT75	7	7-1/2	15-3/8	4-1/4	7	6-1/2	5	7	10	300
220811	8SWT83	8	8-1/2	17-5/8	6	7-1/2	7	3	8	8	375
220824	8SWT84	8	8-1/2	17-5/8	6	7-1/2	7	4	8	8	375

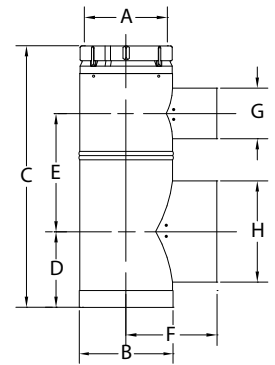

NOTE: Swivel Joint allows a full 360 deg. Rotation between top and bottom of tee. Factory installed Tee Cap attached to bottom of Tee.

TEES — SINGLE WALL BASE — ALUMINUM — SWBTA

ITEM #	MODEL #	A (")	B (")	C (")	D (")	E (")	F (")	G (")	H (")	CTN/QTY	WT/100
210584	5SWT43A	5	5-1/2	15-3/8	4-1/4	7	5-1/2	3	4	10	160
210583	5SWT44A	5	5-1/2	15-3/8	4-1/4	7	5-1/2	4	4	10	160
210582	5SWT53A	5	5-1/2	15-3/8	4-1/4	7	5-1/2	3	5	10	104
210581	5SWT54A	5	5-1/2	15-3/8	4-1/4	7	5-1/2	4	5	10	160
210687	6SWT44A	6	6-1/2	15-3/8	4-1/4	7	6	4	4	10	270
210686	6SWT53A	6	6-1/2	15-3/8	4-1/4	7	6	3	5	10	170
210685	6SWT54A	6	6-1/2	15-3/8	4-1/4	7	6	4	5	10	170
210683	6SWT63A	6	6-1/2	15-3/8	4-1/4	7	6	3	6	10	108
210682	6SWT64A	6	6-1/2	15-3/8	4-1/4	7	6	4	6	10	170
220786	7SWT64A	7	7-1/2	15-3/8	4-1/4	7	6-1/2	4	6	10	200
220783	7SWT74A	7	7-1/2	15-3/8	4-1/4	7	6-1/2	4	7	10	200
220886	8SWT74A	8	8-1/2	17-5/8	6	7-1/2	7	4	7	10	185

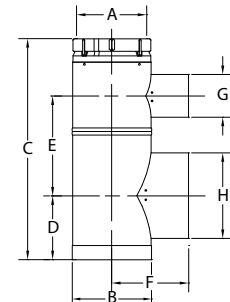

We have custom capabilities to manufacture any sizes you may require. Contact factory for special sizes and configurations not listed.

-E.&O.E. - Subject to Change Without Notice - May Not Be Available At All Locations -



MODEL E/R TYPE B GAS VENT 3" - 8"

TEES — SINGLE WALL — ALUMINUM — SWTA

ITEM #	MODEL #	A (")	B (")	C (")	D (")	E (")	F (")	CTN/QTY	WT/100
200330	3SW/TA	3	3-1/2	3	3-1/2	5	10	10	40
200430	4SW/TA	4	4-1/2	4	4-3/4	5	10	10	50
210530	5SW/TA	5	5-1/2	5	5-1/2	5	10	10	100
210630	6SW/TA	6	6-1/2	6	5-3/4	5-1/2	11	10	100
220730	7SW/TA	7	7-1/2	7	6-1/4	6	12	10	130
220830	8SW/TA	8	8-1/2	8	7	6-1/2	13	8	175

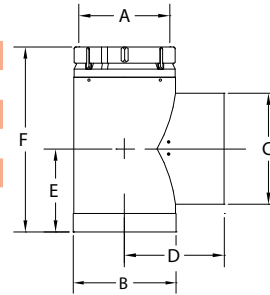

NOTE: Factory Tee Cap attached to bottom of Tee.

WYES — SWIVEL — DOUBLE WALL — DWW

ITEM #	MODEL #	A (")	B (")	C (")	D (")	E (")	F (")	CTN/QTY	WT/100
200434	4DW/W33	4	3-1/2	3	4-11/16	6-3/4	11-1/8	6	200
200433	4DW/W43	4	4-1/2	3	4-11/16	6-3/4	11-1/8	6	200
200431	4DW/W44	4	4-1/2	4	5 3/16	6-3/4	11-1/8	6	200
210536	5DW/W33	5	3-1/2	3	5-3/8	7-1/2	11-11/16	6	225
210535	5DW/W43	5	4-1/2	3	5-3/8	7-1/2	11-11/16	6	225
210534	5DW/W44	5	4-1/2	4	5-7/8	7-1/2	11-11/16	6	225
210533	5DW/W53	5	5-1/2	3	5-3/8	7-1/2	11-11/16	6	225
210532	5DW/W54	5	5-1/2	4	5-7/8	7-1/2	11-11/16	6	225
210531	5DW/W55	5	5-1/2	5	6-3/8	7-1/2	12-3/16	6	225
210638	6DW/W44	6	4-1/2	4	6-5/8	7-1/2	10-15/16	6	275
210637	6DW/W53	6	5-1/2	3	6-1/8	7-1/2	10-15/16	6	275
210636	6DW/W54	6	5-1/2	4	6-5/8	7-1/2	10-15/16	6	275
210634	6DW/W63	6	6-1/2	3	6-1/8	7-1/2	10-15/16	4	275
210633	6DW/W64	6	6-1/2	4	6-5/8	7-1/2	10-15/16	6	275
210632	6DW/W65	6	6-1/2	5	7-1/8	8-1/4	12-3/8	4	275
210631	6DW/W66	6	6-1/2	6	7-5/8	9	13-7/8	4	275
220734	7DW/W74	7	7-1/2	4	9	9	12-7/16	6	270
220733	7DW/W75	7	7-1/2	5	9-1/2	9	12-7/16	6	280
220732	7DW/W76	7	7-1/2	6	8-3/8	9-1/2	13-7/8	4	290
220731	7DW/W77	7	7-1/2	7	8-7/8	10	14-15/16	4	350
220831	8DW/W88	8	8-1/2	8	9-7/8	11-1/2	17-1/8	4	450

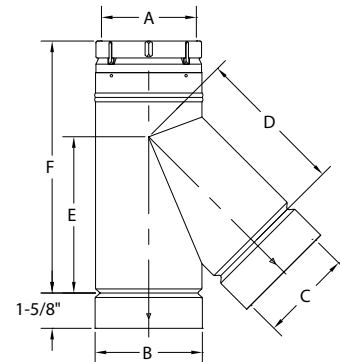

NOTE: Stub dimension B and C may vary according to customer requirements. If an Increasing Wye is required, use a standard Wye and an Increaser.

DRAFT HOOD CONNECTORS — DHC

ITEM #	MODEL #	A (")	B (")	C (")	D (")	CTN/QTY	WT/100
200315	3DHC	3	3-1/2	8-1/2	5-1/2	10	40
200415	4DHC	4	4-1/2	8-1/2	5-1/2	10	50
210515	5DHC	5	5-1/2	8-1/2	5-1/2	10	70
210615	6DHC	6	6-1/2	8-1/2	5-1/2	10	80
220715	7DHC	7	7-1/2	8-1/2	5-1/2	8	100
220815	8DHC	8	8-1/2	8-1/2	5-1/2	8	100

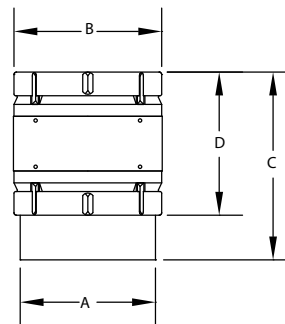

We have custom capabilities to manufacture any sizes you may require. Contact factory for special sizes and configurations not listed.

-E.&O.E. - Subject to Change Without Notice - May Not Be Available At All Locations -



MODEL E/R TYPE B GAS VENT 3" – 8"

DRAFT HOOD CONNECTORS WITH HEM — DHCH

ITEM #	MODEL #	A (")	B (")	CTN/QTY	WT/100
200372	3DHCH	3	3-1/2	10	40
200472	4DHCH	4	4-1/2	10	45
210572	5DHCH	5	5-1/2	10	50
210672	6DHCH	6	6-1/2	10	55
220772	7DHCH	7	7-1/2	8	60
220872	8DHCH	8	8-1/2	8	65

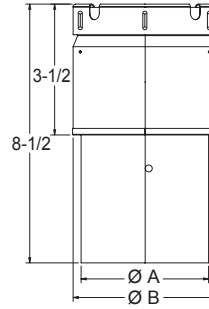

DRAFT HOOD CONNECTOR INCREASER — DHCI

ITEM #	MODEL #	A (")	B (")	CTN/QTY	WT/100
200471	3DHCI	4-1/2	3.10	25	55

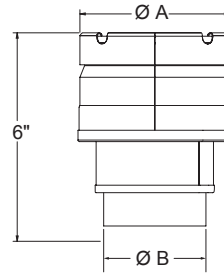

INCREASERS — DOUBLE WALL — INC

ITEM #	MODEL #	A (")	B (")	C (")	CTN/QTY	WT/100
200358	304INC	3	4	2-1/4	10	50
200359	305INC	3	5	2-1/4	10	60
200458	405INC	4	5	2-1/4	10	70
200459	406INC	4	6	2-1/4	10	85
200460	407INC	4	7	2-1/4	10	72
200461	408INC	4	8	2-1/4	10	80
210558	506INC	5	6	2-1/4	10	90
210559	507INC	5	7	2-1/4	10	108
210561	508INC	5	8	2-1/4	10	80
210658	607INC	6	7	2-1/4	10	110
210659	608INC	6	8	2-1/4	10	118
210660	610INC	6	10	2-1/4	10	100
220758	708INC	7	8	2-1/4	10	125
220858	810INC	8	10	2-1/4	10	120

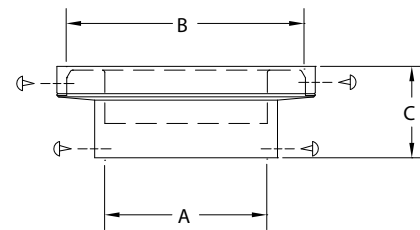

NOTE: Includes Sheet Metal Screws for installation.

B-VENT TO SINGLE WALL CONNECTORS — BSW

ITEM #	MODEL #	A (")	B (")	CTN/QTY	WT/100
200363	3BSW	3	3-1/2	10	40
200463	4BSW	4	4-1/2	10	50
210563	5BSW	5	5-1/2	10	70
210663	6BSW	6	6-1/2	10	90

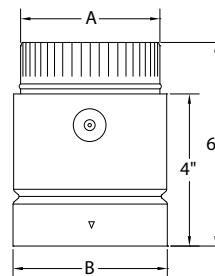

We have custom capabilities to manufacture any sizes you may require. Contact factory for special sizes and configurations not listed.

– E.&O.E. – Subject to Change Without Notice – May Not Be Available At All Locations –



MODEL E/R TYPE B GAS VENT 3" – 8"

B-VENT TO FLEX CONNECTORS — BF

ITEM #	MODEL #	A (")	B (")	C (")	CTN/QTY	WT/100
200362	3BF	3	3-5/8	9	10	120
200462	4BF	4	4-5/8	9	10	140
210562	5BF	5	5-5/8	9	10	160
210662	6BF	6	6-5/8	9	10	180
220762	7BF	7	7-5/8	9	5	280
220862	8BF	8	8-5/8	9	5	320

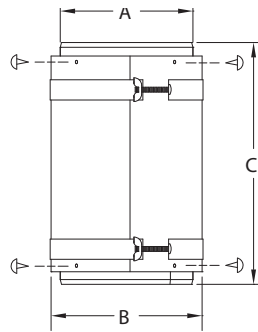

NOTE: Includes Sheet Metal Screws for installation.

B-VENT TO B-VENT ADAPTERS — BA

ITEM #	MODEL #	A (")	B (")	C (")	CTN/QTY	WT/100
200364	3BA	3	2-3/4	6-1/2	10	50
200464	4BA	4	3	6-1/2	10	60
210564	5BA	5	3	6-1/2	10	70
210664	6BA	6	3	6-1/2	10	80
220764	7BA	7	3	6-1/2	10	90
220864	8BA	8	3	6-1/2	10	100

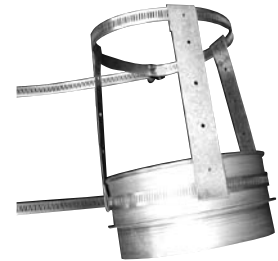
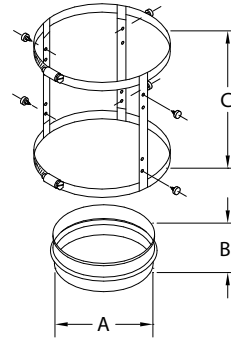

NOTE: Includes Sheet Metal Screws for installation.

ADAPTERS — FEMALE — B-VENT — FMSA

ITEM #	MODEL #	A (")	B (")	CTN/QTY	WT/100
200373	3FMSA	3-5/8	3	25	65
200473	4FMSA	4-5/8	4	25	70
210573	5FMSA	5-5/8	5	10	75
210673	6FMSA	6-5/8	6	10	80
220773	7FMSA	7-5/8	7	8	85
220873	8FMSA	8-5/8	8	8	90

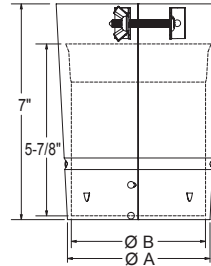

ADAPTERS — FEMALE — B-VENT — FMA

ITEM #	MODEL #	A (")	B (")	C (")	CTN/QTY	WT/100
200365	3FMA	3	3-5/8	3-3/8	10	70
200465	4FMA	4	4-5/8	4-3/8	10	85
210565	5FMA	5	5-5/8	5-3/8	10	100
210665	6FMA	6	6-5/8	6-3/8	10	115
220765	7FMA	7	7-5/8	7-3/8	8	100
210865	8FMA	8	8-5/8	8-3/8	8	110

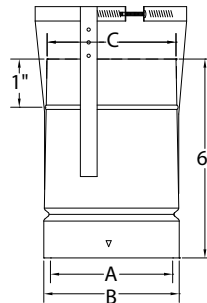

We have custom capabilities to manufacture any sizes you may require. Contact factory for special sizes and configurations not listed.

– E.&O.E. – Subject to Change Without Notice – May Not Be Available At All Locations –



MODEL E/R TYPE B GAS VENT 3" – 8"

ADAPTERS — MALE — B-VENT — MA

ITEM #	MODEL #	A (")	B (")	CTN/QTY	WT/100
200366	3MA	3	3-5/8	10	70
200466	4MA	4	4-5/8	10	85
210566	5MA	5	5-5/8	10	100
210666	6MA	6	6-5/8	10	115

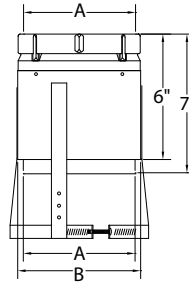

ADAPTERS — MALE — B-VENT — MSA

ITEM #	MODEL #	A (")	B (")	CTN/QTY	WT/100
200375	3MSA	3-5/8	3	25	65
200475	4MSA	4-5/8	4	25	70
210575	5MSA	5-5/8	5	10	75
210675	6MSA	6-5/8	6	10	80
220775	7MSA	7-5/8	7	8	85
220875	8MSA	8-5/8	8	8	90

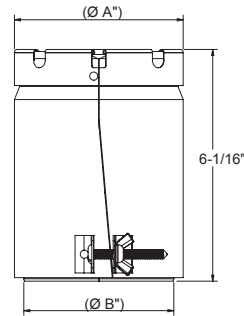

ADAPTERS — A-VENT TO B-VENT

ITEM #	SIZE (")	A (")	CTN/QTY	WT/100
139074	4	4-5/8	50	110
139075	5	5-5/8	50	110
139076	6	6-5/8	50	110

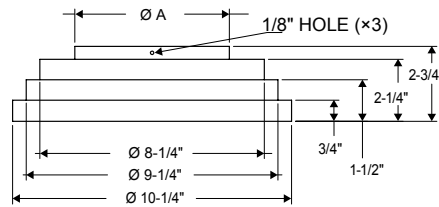

BUTYL GASKET (SEALANT TAPE)

ITEM #	DESCRIPTION	CTN/QTY	WT/100
704930	3/4" x 3/16" x 25'	5	250



We have custom capabilities to manufacture any sizes you may require. Contact factory for special sizes and configurations not listed.

– E.&O.E. – Subject to Change Without Notice – May Not Be Available At All Locations –



MODEL E/R TYPE B GAS VENT 3" - 8"

WALL BANDS — WB

ITEM #	MODEL #	A (")	CTN/QTY	WT/100
200319	3WB	3-5/16	20	35
200419	4WB	4-5/16	20	33
210519	5WB	5-5/16	20	38
210619	6WB	6-5/16	20	44

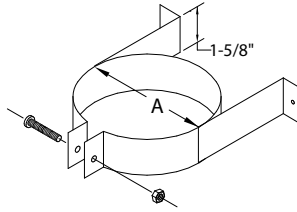

FINISHING COLLARS — FC

ITEM #	MODEL #	SIZE (")	A (")	B (")	CTN/QTY	WT/100
200389	3FC	3	3-5/8	8-1/2	50	30
200489	4FC	4	4-5/8	9-1/2	50	34
210589	5FC	5	5-5/8	10-1/2	50	40
210689	6FC	6	6-5/8	11-1/2	50	44
220789	7FC	7	7-5/8	12-1/2	50	50
220889	8FC	8	8-5/8	13-1/2	50	56

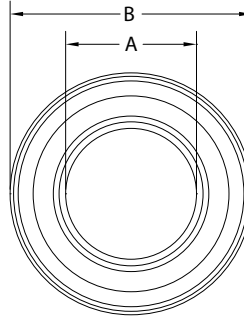

TYPE B GAS VENT KITS WITH DRAFT HOOD CONNECTOR

ITEM #	MODEL #	CTN/QTY	WT/100
200346	3GVK	1	500
200446	4GVK	1	600
210546	5GVK	1	700
210646	6GVK	1	800
220746	7GVK	1	900
220846	8GVK	1	1000



Kit includes:

- 1 – Rain Cap
- 1 – Storm Collar
- 1 – Adjustable Flashing
- 1 – Support Plate
- 1 – Support Ring
- 1 – Draft Hood Connector

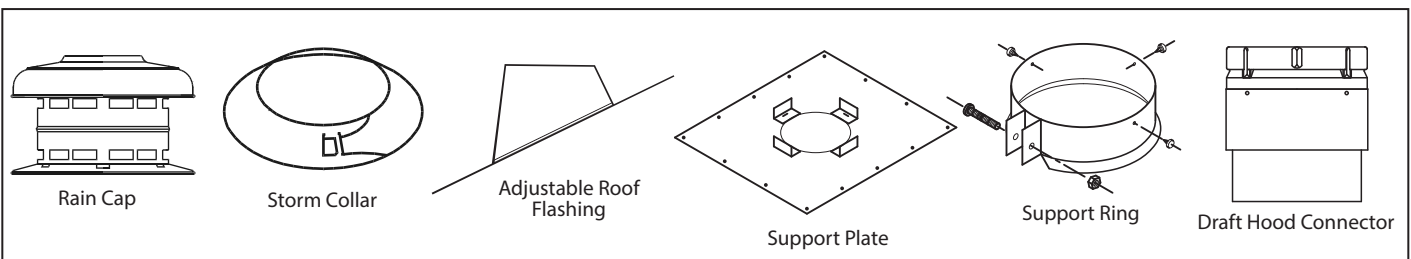

We have custom capabilities to manufacture any sizes you may require. Contact factory for special sizes and configurations not listed.

– E.&O.E. – Subject to Change Without Notice – May Not Be Available At All Locations –



MODEL E/R TYPE B GAS VENT 3" - 8"

TYPE B GAS VENT KITS WITH SINGLE WALL BASE TEE

ITEM #	MODEL #	CTN/QTY	WT/100
200347	3GVK-T	1	570
200447	4GVK-T	1	640
210547	5GVK-T	1	770
210647	6GVK-T	1	860
220747	7GVK-T	1	980
220847	8GVK-T	1	1080



Kit includes:

- 1 – Rain Cap
- 1 – Storm Collar
- 1 – Adjustable Flashing
- 1 – Support Plate
- 1 – Support Ring
- 1 – Single Wall Base Tee

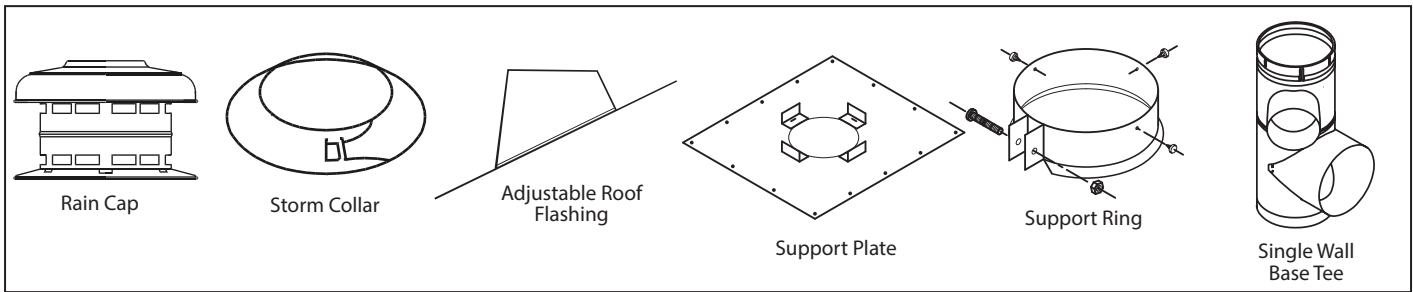

TYPE B GAS VENT KITS LESS DRAFT HOOD CONNECTOR

ITEM #	MODEL #	CTN/QTY	WT/100
200449	4GVK	1	490
210549	5GVK	1	530
210649	6GVK	1	605

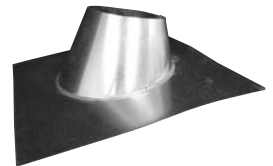

Kit includes:

- 1 – Rain Cap
- 1 – Storm Collar
- 1 – Adjustable Flashing
- 1 – Support Plate
- 1 – Support Ring

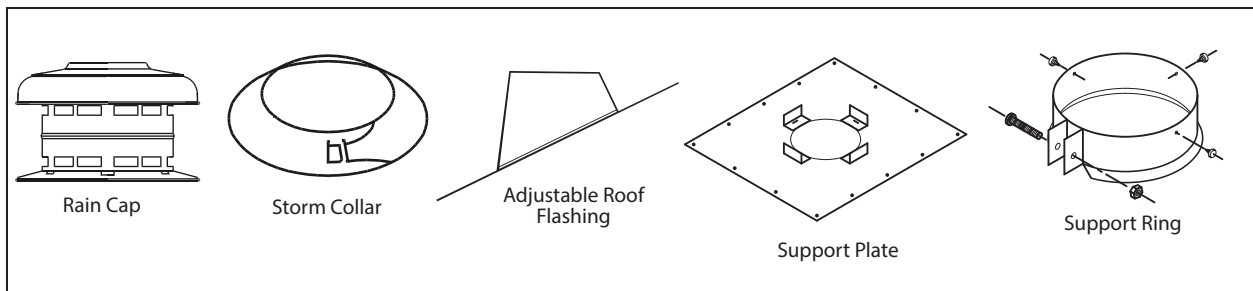

We have custom capabilities to manufacture any sizes you may require. Contact factory for special sizes and configurations not listed.

– E.&O.E. – Subject to Change Without Notice – May Not Be Available At All Locations –



MODEL E/R TYPE B GAS VENT 3" – 8"

WALL THIMBLES — ROUND PIPE

ITEM #	MODEL	SIZE (")	CTN/QTY	WT/100
614153	3RWT	3	12	133
614154	4RWT	4	12	133
614155	5RWT	5	12	150
614156	6RWT	6	12	167
614157	7RWT	7	*	200
614158	8RWT	8	*	200



*Product shipped individually.

TYPE B OVAL GAS VENT AND FITTINGS — 4"

ITEM #	MODEL	DESCRIPTION	CTN/QTY	WT/100
614002	4OV5	4" x 5 ft. Oval Gas Vent	6	717
614004	4OV4	4" x 4 ft. Oval Gas Vent	6	600
614006	4OV3	4" x 3 ft. Oval Gas Vent	6	450
614008	4OV2	4" x 2 ft. Oval Gas Vent	6	300
614010	4OV18	4" x 18" Oval Gas Vent	6	233
614012	4OV12	4" x 12" Oval Gas Vent	6	150
614014	4OV6	4" x 6" Oval Gas Vent	6	83
614016	4OV12A	4" x 12" Oval Gas Vent Adj. Length	6	150
614018	4OVSL	4" x 45° Elbow – Standard	6	133
614020	4OVFL	4" x 45° Elbow – Flat	6	133
614036	4OVWVT	4" Wall Vent Tee	6	–
614022	4OV-RD	4" Oval to Round Adapter	6	100
614024	4RD-OV	4" Round to Oval Adapter	6	100
614031	4OVFS	4" Firestop Spacers 2" x 4"	25 pairs	148
614032	4OVFS6	4" Firestop Spacers 2" x 6"	*	–
614026	4OVAC	4" Oval White Cap	24	–
614030	4OVF	4" Oval Flashing	12	–
614028	4OVSC	4" Oval Storm Collar	24	–

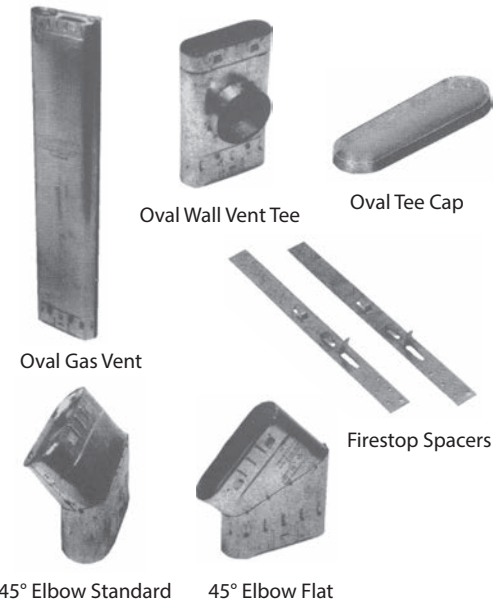

*Product shipped individually.

TYPE B OVAL GAS VENT AND FITTINGS — 5"

ITEM #	MODEL	DESCRIPTION	CTN/QTY	WT/100
614102	5OV5	5" x 5 ft. Oval Gas Vent	4	1025
614104	5OV4	5" x 4 ft. Oval Gas Vent	4	850
614106	5OV3	5" x 3 ft. Oval Gas Vent	6	616
614108	5OV2	5" x 2 ft. Oval Gas Vent	6	400
614110	5OV18	5" x 18" Oval Gas Vent	6	333
614112	5OV12	5" x 12" Oval Gas Vent	6	217
614114	5OV6	5" x 6" Oval Gas Vent	6	117
614116	5OV12A	5" x 12" Oval Pipe Gas Vent Adj. Length	6	217
614118	5OVSL	5" x 45° Elbow – Standard	6	117
614120	5OVFL	5" x 45° Elbow – Flat	6	167
614134	5OVT	5" Oval Wall Tee	6	–
614122	5OV-RD	5" Oval to Round Adapter	6	167
614124	5RD-OV	5" Round to Oval Adapter	6	167
614132	5OVFS6	5" Firestop Spacers 2" x 6"	*	–
614126	5OVAC	5" Oval White Cap	12	–
614130	5OVF	5" Oval Flashing	12	–
614128	5OVSC	5" Oval Storm Collar	*	–

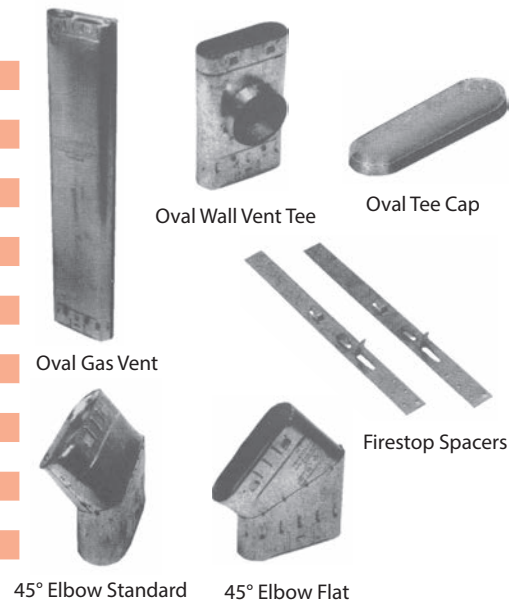

*Product shipped individually.

– E.&O.E. – Subject to Change Without Notice – May Not Be Available At All Locations –



MODEL E/R TYPE B GAS VENT 3" – 8"

GAS-VENT, Type B LIMITED LIFETIME WARRANTY

This limited LIFETIME warranty is granted by ECCO Manufacturing™ a division of ECCO Heating Products Ltd. 19860 Fraser Highway Langley B.C. Canada V3A 4C9 (Hereinafter referred to as "Warrantor")

LIMITED WARRANTY:

The Warrantor grants a warranty to the initial consumer that the **ECCO GAS VENT** will be free from defects in material and workmanship under normal use for the lifetime of the product. This warranty is not valid if the **ECCO GAS VENT** is not installed in accordance with the recommendations provided in the installation manual and with all the components provided by the manufacturer. This product must be used for the application for which it was designed and intended.

The Warrantor shall not be liable for damages due to normal wear of the **ECCO GAS VENT**, accidents, misuse, lack of reasonable and necessary maintenance, improper installation or unauthorized repairs, alterations or modifications of the product.

The Warrantor's liability with respect to defects shall be limited to the replacement of the **ECCO GAS VENT** chimney lengths considered defective by the Warrantor for the lifetime of the product. The initial consumer shall bear all other costs.

The Warrantor reserves the right to replace **ECCO GAS VENT** chimney lengths with an equivalent product and the replacement must be carried out in accordance with the Warrantor's recommendations.

The warranty is limited to the replacement of defective lengths and does not include any damages resulting from any defect in the product nor does it include expenses sustained in connection with the product, including damages to property.

IN NO EVENT WILL WARRANTOR BE LIABLE TO YOU OR ANY OTHER PERSON FOR ANY DAMAGES, INCLUDING ANY INCIDENTAL OR CONSEQUENTIAL DAMAGES. SOME STATES DO NOT ALLOW THE ABOVE LIMITATION OR EXCLUSION OF INCIDENTAL OR CONSEQUENTIAL DAMAGES, SO THE ABOVE LIMITATIONS OR EXCLUSIONS MAY NOT APPLY TO YOU.

The warranty is only valid for an initial consumer who buys ECCO GAS VENT lengths and may not be assigned.

EXCEPT AS EXPRESSLY SET FORTH ABOVE, NO OTHER WARRANTIES, EITHER EXPRESSED OR IMPLIED, WRITTEN OR ORAL, ARE MADE INCLUDING BUT NOT LIMITED TO THE IMPLIED WARRANTIES OF MERCHANTABILITY AND FITNESS FOR A PARTICULAR PURPOSE, AND THE WARRANTOR EXPRESSLY DISCLAIMS ALL WARRANTIES NOT STATED HEREIN. SOME STATES DO NOT ALLOW THE EXCLUSION OF IMPLIED WARRANTIES, SO THE ABOVE EXCLUSION MAY NOT APPLY TO YOU. THIS WARRANTY GIVES YOU SPECIFIC LEGAL RIGHTS AND YOU MAY ALSO HAVE OTHER RIGHTS THAT VARY FROM STATE TO STATE.

OBTAINING REPLACEMENT:

To obtain a replacement, contact the Warrantor or the dealer. **Proof of purchase is required.** If defective lengths have to be returned, it will be at the consumer's expense. The Warrantor will replace any lengths which upon examination by Warrantor or its designated representative, prove to be defective.

Rev: 1

03-2010

– E.&O.E. – Subject to Change Without Notice – May Not Be Available At All Locations –



www.eccomfg.com

Langley Distribution

19860 Fraser Highway
Langley, British Columbia
Canada V3A 4C9

Phone: 604-530-4151
Toll Free: 1-877-955-4805
Fax: 604-533-9335

Calgary Distribution

21 – 11150 38th Street, S.E.
Calgary, Alberta
Canada T2C 2Z6

Phone: 403-720-0895
Toll Free: 1-877-955-4815
Fax: 403-720-0897

Kent Distribution

20001 87th Ave. S, Bldg E
Kent, Washington
USA 98031

Phone: 253-872-3721
Toll Free: 1-800-207-6859
Fax: 253-872-3724