

FITTINGS



ECCO™ is proud to be a member of:



SMACNA
Sheet Metal and Air
Conditioning Contractors'
National Association
www.smacna.org



HRAI
Heating, Refrigeration and
Air Conditioning
Institute of Canada
www.hrai.ca



HARDI
Heating, Air-conditioning
& Refrigeration
Distributors International
www.hardinet.org



ADI
Air
Distribution
Institute
www.steelduct.org



AD
Affiliated Distributors™
www.adhq.com



CME
Canadian
Manufacturers &
Exporters
www.cme-mec.ca



SPIDA
Spiral Duct
Manufacturers
Association
www.spida.org



INDEX

ADAPTERS	
RANGE HOOD TRANSITIONS	A4-34
ROOF CAP ADAPTERS — RVA	A4-47
STANDARD GAUGE	A4-47
SQUARE TO ROUND	A4-36 – A3-37
B-BOXES	A4-39
BOOTS	
CEILING / ACCESSORIES.....	A4-4
END BOOTS.....	A4-5 – A4-6
RIGHT ANGLE	A4-3 – A4-4
ROUND TO OVAL	A4-8
UNIVERSAL	A4-6 – A4-7
BRASS TAIL PIECE — ONLY	A4-34
CAPS	
CHINA — GALVANIZED.....	A4-41
SLAB DIFFUSER.....	A4-9
WALL W/SPRING LOADED DAMPER — GALVANIZED.....	A4-41
COLLARS	
CONICAL SPIN-IN.....	A4-26
CONICAL SPIN-IN WITH DAMPER.....	A4-25
SLAB DIFFUSER COLLARS	A4-9
SPIN-IN — 4" LONG.....	A4-24
SPIN-IN WITH DAMPER.....	A4-24 – A4-25
STORM — PIPE SIZE.....	A4-43
TAP-IN — LARGE END (STARTING COLLARS).....	A4-24
TAP-IN — SMALL END	A4-22 – A4-23
WITH FLANGE.....	A4-43
COMBUSTION AIR POTS.....	A4-35
CONICAL STANDOFFS — WITH 3/8" ROD DAMPER.....	A4-26
DIFFUSER CANS	A4-38
DRAIN PANS	
EQUIPMENT	A4-33
DRAIN PANS — 2" HIGH — C/W PVC FITTING	A4-32
SPUN ROUND.....	A4-31 – A4-33
SQUARE	A4-33
DUCTBOARD — SPIN-IN.....	A4-27
ECCO-SEAL	
CONICAL.....	A4-29
FLAT.....	A4-27 – A4-28
HIGH EFFICIENCY TAKE OFF	A4-30
RADIUS.....	A4-28
EC RETURN AIR CANS	A4-37
FLASHINGS	
I.P.S. ADJUSTABLE ROOF	A4-43
ADJUSTABLE	
PIPE SIZE — 1/12-7/12	A4-42
PIPE SIZE — 1/12-7/12 — SOLDERED.....	A4-42
PIPE SIZE — 8/12-12/12.....	A4-43
FLAT	
HOT WELDED.....	A4-41
PIPE SIZE — HOT WELDED	A4-42
PIPE SIZE — SOLDERED.....	A4-41
FRESH AIR GRILLES — GALVANIZED	A4-40
FRESH AIR INTAKES	A4-40
FRESH AIR SNORKELS	A4-40
HI EXTENSION — 12"	A4-9
KICKBOARD BOXES	A4-39
LINESET — ADJUSTABLE — 1/12-7/12	A4-43
LINT TRAPS	A4-35 – A4-36
NAILING STRIPS.....	A4-35
NPT PIPE NIPPLE CADDY	A4-34
PVC FITTING.....	A4-32
REGISTER BOXES	A4-36
RETURN AIR CANS.....	A4-38
RETURN AIR SUPPORT BOXES	A4-39
ROOF JACKS	
EC144.....	A4-45
MOBILE HOME — 8 x 8	A4-45
ROUND	A4-44 – A4-46
SQUARE TOP — SOLDERED — 8 x 8 — 26 GAUGE.....	A4-44
TAKE OFFS	
DUCTBOARD	A4-11
ELBOWS	A4-11
ELBOW — GALVANIZED	A4-11
PIPE.....	A4-14
SADDLE.....	A4-13 – A4-14
SIDE.....	A4-12 – A4-13
TOP	A4-10
UNIVERSAL	A4-10
SLEEVES WITH DAMPERS (KS-145 REGULATOR)	A4-26 – A4-27
STAKES — SLAB.....	A4-9
STRANKO BOXES.....	A4-34
TEES	
24 GAUGE /26 GAUGE / 30 GAUGE	A4-20 – A4-21
AIR CUSHION	A4-20
SADDLE — GALVANIZED.....	A4-20
THIMBLES — WALL	A4-34 – A4-35
VENTS — ROOF	
ATTIC — SQUARE — SOLDERED — GALVANIZED	A4-47
BUILT UP	A4-47
PLASTIC CAP STEM VENTS — BVDS.....	A4-48
WITH STEM	A4-47
WATER TANK STANDS.....	A4-34
WYES	
BRANCHES — 26 GAUGE.....	A4-18
PANT — GALVANIZED — SMALL END.....	A4-17
SADDLE — GALVANIZED.....	A4-17
STRAIGHT CONE	A4-19
UNIVERSAL	A4-15 – A4-16

LEGEND

NOTE: The boxed columns throughout the tables are intended to provide a quick determination of ordering dimensions.

ABBREVIATIONS: CTN/QTY = Carton Quantity
 WT/100 = Weight per 100 Pieces
 WT/100 FT = Weight per 100 Feet
 FT/BNDL = Feet per Bundle

RIGHT ANGLE BOOTS — P13

ITEM #	DESCRIPTION	A (")	B (")	C (")	D (")	E (")	F (")	CTN/QTY	WT/100
074210	4 - 2-1/4" x 10	4	2-1/4	10	3-1/4	3	4	30	85
074310	4 - 3" x 10"	4	3	10	3-1/4	3	5	30	96
074313	4 - 3" x 10" c/w Hem	4	3	10	3-1/4	2-1/2	4-1/2	30	96
074410	4 - 4" x 10"	4	4	10	3-1/4	3	4	20	124
074411	4 - 4" x 10" c/w 1" Flange	4	4	10	3-1/4	3	4	20	126
075210	5 - 2-1/4" x 10"	5	2-1/4	10	3	3	4	20	105
075212	5 - 2-1/4" x 12"	5	2-1/4	12	3-1/4	3	4	20	142
075214	5 - 2-1/4" x 14"	5	2-1/4	14	3-3/4	3	4	20	154
075310	5 - 3" x 10"	5	3	10	2-3/4	3	4	30	100
075313	5 - 3" x 10" c/w Hem	5	3	10	2-3/4	2-1/2	3-1/2	30	100
075380	5 - 3" x 10" c/w Plate	5	3	10	2-3/4	2-7/8	3-7/8	20	134
075311	5 - 3-1/4" x 10" c/w Cleats	5	3-1/4	10	2-1/2	3	4	30	103
075410	5 - 4" x 10"	5	4	10	3	3	4	20	106
075411	5 - 4" x 10" c/w 1" Flange	5	4	10	3	3	4	20	111
075420	5 - 4" x 10" Short	5	4	10	2-3/4	1-1/2	2-1/2	20	99
075422	5 - 4" x 10", 4" Throat	5	4	10	3	4	5	20	116
075412	5 - 4" x 12"	5	4	12	3	3	4	20	110
075433	5 - 6" x 12" c/w 1" Flange	5	6	12	3-1/2	3	4	20	213
076200	6 - 2" x 10" L/E c/w Damper	6	2	10	3	2-1/2	3-1/2	20	130
076210	6 - 2-1/4" x 10"	6	2-1/4	10	3-1/4	2-1/2	3-1/2	20	130
076212	6 - 2-1/4" x 12"	6	2-1/4	12	3-1/2	3	4	10	130
076214	6 - 2-1/4" x 14"	6	2-1/4	14	4-1/2	3	4	10	140
076310	6 - 3" x 10"	6	3	10	2-3/4	3	4	20	133
076408	6 - 4" x 8"	6	4	8	2-3/4	3	5	20	135
076400	6 - 4" x 10" L/E c/w Damper	6	4	10	3-1/2	3	5	20	144
076409	6 - 4" x 10" c/w 1" Flange	6	4	10	3-1/2	3	5	20	130
076410	6 - 4" x 10"	6	4	10	3-1/2	3	5	20	138
076402	6 - 4" x 12" L/E c/w Damper	6	4	12	3-1/2	3	5	10	158
076411	6 - 4" x 12" c/w 1" Flange	6	4	12	3-1/2	3	5	10	111
076412	6 - 4" x 12"	6	4	12	3-1/2	3	5	10	150
076413	6 - 4" x 10" c/w Hem	6	4	10	3-1/2	2-1/2	4-1/2	20	138
076404	6 - 4" x 14" L/E c/w Damper	6	4	14	3-1/2	3	4-1/2	10	179
076414	6 - 4" x 14"	6	4	14	3-1/2	3	4-1/2	10	170
076415	6 - 4" x 14" c/w 1" Flange	6	4	14	3-1/2	3	4-1/2	10	160
076608	6 - 6" x 8"	6	6	8	3	2-3/4	4	10	155
076610	6 - 6" x 10"	6	6	10	2-1/2	1-1/2	2-3/4	10	155
076611	6 - 6" x 10" c/w 1" Flange	6	6	10	2-1/2	1-1/2	2-3/4	10	176
076612	6 - 6" x 12"	6	6	12	3	3	4-1/2	10	160
076613	6 - 6" x 12" c/w 1" Flange	6	6	12	3	3	4-1/2	10	227
077400	7 - 4" x 10" L/E c/w Damper	7	4	10	3	2-1/2	4-3/4	10	150
077410	7 - 4" x 10"	7	4	10	3	2-1/2	4-3/4	10	142
077402	7 - 4" x 12" L/E c/w Damper	7	4	12	2-3/4	3	4-1/2	10	168
077412	7 - 4" x 12"	7	4	12	2-3/4	3	4-1/2	10	160
077414	7 - 4" x 14"	7	4	14	3-1/4	3	5	10	160
077415	7 - 4" x 14" c/w 1" Flange	7	4	14	3-1/4	3	5	10	165
077610	7 - 6" x 10"	7	6	10	3	3	4-1/4	10	180
077611	7 - 6" x 10" c/w 1" Flange	7	6	10	3	3	4-1/4	10	258
077612	7 - 6" x 12"	7	6	12	3-1/4	3	5-1/4	10	185
077613	7 - 6" x 12" c/w 1" Flange	7	6	12	3-1/4	3	5-1/4	10	261
077614	7 - 6" x 14"	7	6	14	3-1/2	2-1/2	4	10	195

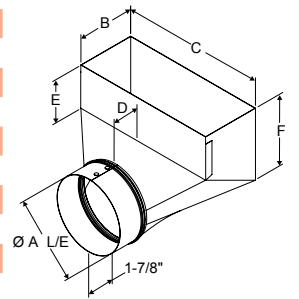
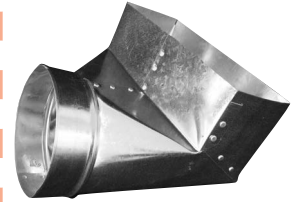

Right Angle Boot

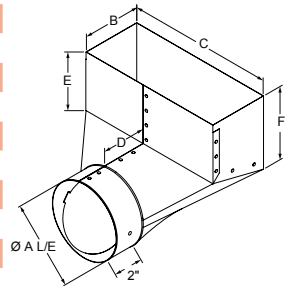

Right Angle Boot with Damper

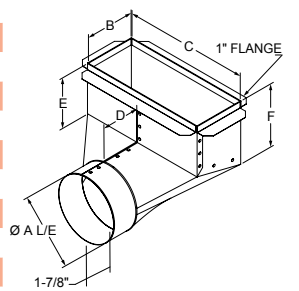

Right Angle Boot with 1" Flange

(cont'd on next page)

- E.&O.E. - Subject to Change Without Notice - May Not Be Available At All Locations -

RIGHT ANGLE BOOTS — P13 (cont'd)

ITEM #	DESCRIPTION	A (")	B (")	C (")	D (")	E (")	F (")	CTN/QTY	WT/100
078400	8 – 4" × 10" L/E c/w Damper	8	4	10	3	3	4-1/2	10	190
078402	8 – 4" × 12" L/E c/w Damper	8	4	12	3-1/2	2-1/2	5-1/2	10	200
078412	8 – 4" × 12"	8	4	12	3-1/2	2-1/2	5-1/2	10	190
078404	8 – 4" × 14" L/E c/w Damper	8	4	14	3-1/2	3	4-3/4	10	210
078414	8 – 4" × 14"	8	4	14	3-1/2	3	4-3/4	10	200
078415	8 – 4" × 14" c/w 1" Flange	8	4	14	3-1/2	3	4-3/4	10	205
078608	8 – 6" × 8"	8	6	8	3	2-3/4	4-1/2	10	170
078610	8 – 6" × 10"	8	6	10	3-1/4	3	6-1/2	10	180
078612	8 – 6" × 12"	8	6	12	3-1/4	3	6-1/2	10	200
078611	8 – 6" × 12" L/E c/w Damper	8	6	12	3-1/4	3	6-1/2	10	321
078613	8 – 6" × 12" c/w 1" Flange	8	6	12	3-1/4	3	6-1/2	10	295
078604	8 – 6" × 14" L/E c/w Damper	8	6	14	3-1/4	3	6-1/2	10	215
078614	8 – 6" × 14"	8	6	14	3-1/4	3	6-1/2	5	200
078615	8 – 6" × 14" c/w 1" Flange	8	6	14	3-1/4	3	6-1/2	10	205
079614	9 – 6" × 14"	9	6	14	3-1/4	3	6-1/2	10	210
078674	10 – 6" × 14" c/w Damper	10	6	14	4	3	6	10	220

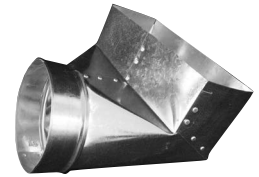

RIGHT ANGLE BOOTS WITH CLEATS — F13

ITEM #	SIZE (")	A (")	B (")	C (")	CTN/QTY	WT/100
076311	6 – 3-1/4 × 10	6	3-1/4	10	20	140
076312	6 – 3-1/4 × 12	6	3-1/4	12	10	146
076314	6 – 3-1/4 × 14	6	3-1/4	14	10	150
077311	7 – 3 1/4 × 10	7	3-1/4	10	20	112
077312	7 – 3-1/4 × 12	7	3-1/4	12	10	145
077314	7 – 3-1/4 × 14	7	3-1/4	14	10	118
078312	7 – 3-1/4 × 12	8	3-1/4	12	10	124
078314	8 – 3-1/4 × 14	8	3-1/4	14	10	130

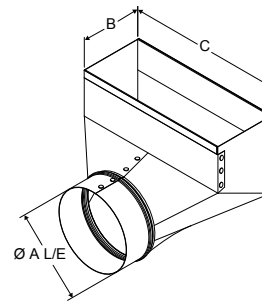

RIGHT ANGLE CEILING BOOTS

ITEM #	DESCRIPTION	A (")	B (")	C (")	CTN/QTY	WT/100
072300	5" – 3" × 10"	5	3	10	30	101
072400	5" – 4" × 10"	5	4	10	20	107

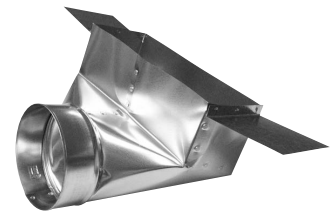
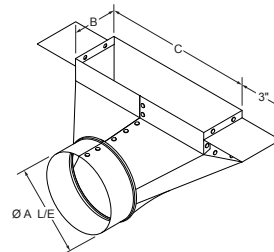

BOOT ACCESSORIES

ITEM #	DESCRIPTION	A (")	B (")	CTN/QTY	WT/100
072460	4" × 10" Plate	4	10	50	110
072450	Basement Boot Wings 3"/Pair	3	3	300 pairs	3

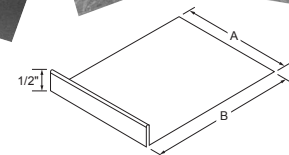
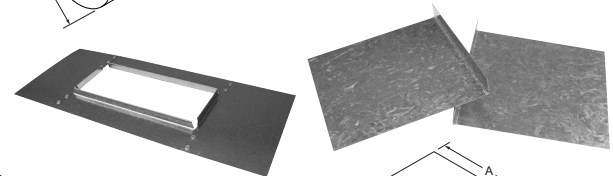
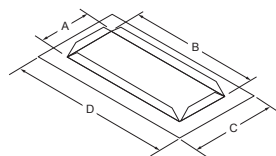

– E.&O.E. – Subject to Change Without Notice – May Not Be Available At All Locations –

END BOOTS — P17

ITEM #	DESCRIPTION	A (")	B (")	C (")	D (")	E (")	CTN/QTY	WT/100
084310	4 – 3" x 10"	4	3	10	2-1/2	3-1/4	30	88
084313	4 – 3" x 10" c/w Hem	4	3	10	2	2-3/4	30	88
084410	4 – 4" x 10"	4	4	10	2-1/2	3-1/4	20	128
085210	5 – 2-1/4" x 10"	5	2-1/4	10	2-1/2	3-1/4	30	125
085212	5 – 2-1/4" x 12"	5	2-1/4	12	2-1/2	3-1/4	30	145
085214	5 – 2-1/4" x 14"	5	2-1/4	14	2-1/2	3-1/4	20	130
085310	5 – 3" x 10"	5	3	10	2-1/2	3-1/4	40	94
085313	5 – 3" x 10" c/w Hem	5	3	10	2	2-3/4	40	94
085400	5 – 4" x 10" c/w Damper	5	4	10	2-1/2	3-1/4	30	105
085410	5 – 4" x 10"	5	4	10	2-1/2	3-1/4	30	100
085412	5 – 4" x 12"	5	4	12	2-1/2	3-1/4	20	104
085420	5 – 4" x 10" Short	5	4	10	1-1/2	2-1/4	20	95
085422	5 – 4" x 10", 4" Throat	5	4	10	3-1/2	4-1/4	20	110
086200	6 – 2" x 10" c/w Damper	6	2	10	2-1/2	3-1/4	20	153
086210	6 – 2-1/4" x 10"	6	2-1/4	10	2-1/2	3-1/4	20	135
086212	6 – 2-1/4" x 12"	6	2-1/4	12	2-1/2	3-1/4	20	135
086214	6 – 2-1/4" x 14"	6	2-1/4	14	2-1/2	3-1/4	10	160
086310	6 – 3" x 10"	6	3	10	2-1/2	3-1/4	20	127
086400	6 – 4" x 10" c/w Damper	6	4	10	2-1/2	3-1/4	20	160
086410	6 – 4" x 10"	6	4	10	2-1/2	3-1/4	20	152
086413	6 – 4" x 10" c/w Hem	6	4	10	2	2-3/4	20	152
086402	6 – 4" x 12" c/w Damper	6	4	12	2-1/2	3-1/4	20	170
086412	6 – 4" x 12"	6	4	12	2-1/2	3-1/4	20	125
086404	6 – 4" x 14" c/w Damper	6	4	14	2-1/2	3-1/4	10	190
086414	6 – 4" x 14"	6	4	14	2-1/2	3-1/4	10	190
086415	6 – 4" x 14" c/w 1" Flange	6	4	14	2-1/2	3-1/4	10	195
086610	6 – 6" x 10"	6	6	10	2-1/2	3-1/4	10	125
086612	6 – 6" x 12"	6	6	12	2-1/2	3-1/4	10	130
086614	6 – 6" x 14"	6	6	14	2-1/2	3-1/4	10	200
087410	7 – 4" x 10"	7	4	10	2-1/2	4-1/4	10	135
087412	7 – 4" x 12"	7	4	12	2-1/2	3-1/4	10	150
087405	7 – 4" x 12" c/w Damper	7	4	12	2-1/2	3-1/4	10	207
087414	7 – 4" x 14"	7	4	14	2-1/2	6	10	150
087610	7 – 6" x 10"	7	6	10	2-1/2	4	10	150
087612	7 – 6" x 12"	7	6	12	2-1/2	4	10	155
087614	7 – 6" x 14"	7	6	14	2-1/2	4	10	212
088412	8 – 4" x 12"	8	4	12	3	7-1/2	10	165
088402	8 – 4" x 12" c/w Damper	8	4	12	3	4	10	285
088414	8 – 4" x 14"	8	4	14	3	4	10	170
088413	8 – 4" x 14" c/w Damper	8	4	14	3	4	10	289
088610	8 – 6" x 10"	8	6	10	3	7-1/2	10	170
088612	8 – 6" x 12"	8	6	12	3	7-1/2	10	180
088611	8 – 6" x 12" c/w Damper	8	6	12	3	7-1/2	10	290
088614	8 – 6" x 14"	8	6	14	2-1/2	7-1/2	10	190
088674	10 – 6" x 14" LE c/w Damper	10	6	14	4	5	10	220

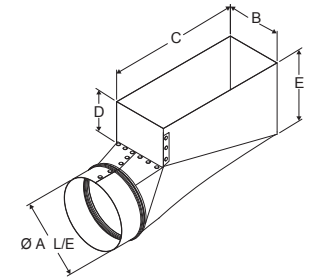

End Boot

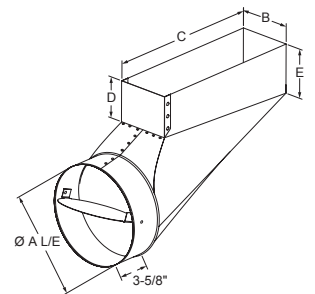

End Boot with Damper

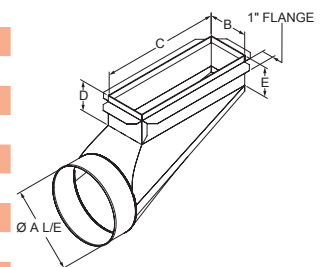

End Boot with 1" Flange

– E.&O.E. – Subject to Change Without Notice – May Not Be Available At All Locations –

END BOOTS WITH CLEATS — F17

ITEM #	SIZE (")	A (")	B (")	C (")	D (")	E (")	CTN/QTY	WT/100
085311	5 – 3-1/4 × 10	5	3-1/4	10	2-1/2	3-1/4	20	103
086311	6 – 3-1/4 × 10	6	3-1/4	10	2-1/2	3-1/4	20	127
086312	6 – 3-1/4 × 12	6	3-1/4	12	2-1/2	3-1/4	20	120
087312	7 – 3-1/4 × 12	7	3-1/4	12	2-1/2	3-1/4	10	135
088312	8 – 3-1/4 × 12	8	3-1/4	12	2-1/2	3-1/4	20	124
088314	8 – 3-1/4 × 14	8	3-1/4	14	2-1/2	3-1/4	10	130

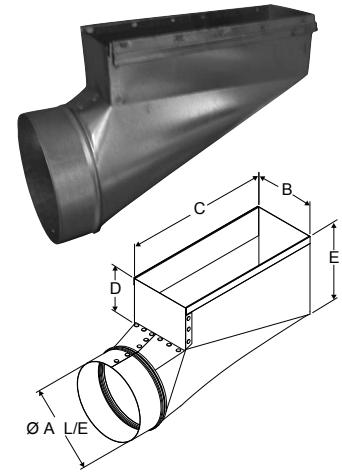

UNIVERSAL BOOTS — P5

ITEM #	DESCRIPTION	A (")	B (")	C (")	D (")	E (")	CTN/QTY	WT/100
095400	5 – 4" × 10" L/E c/w Damper	5	4	10	7-1/4	2-1/2	40	115
093540	5 – 4" × 10" S/E Collar	5	4	10	7-1/4	2-1/2	20	105
094209	4 – 2-1/4" × 10" EXT	4	2-1/4	10	9-1/2	4	30	90
094210	4 – 2-1/4" × 10"	4	2-1/4	10	8-5/8	3	20	86
094212	4 – 2-1/4" × 12" EXT	4	2-1/4	12	9-1/2	4	20	66
094310	4 – 3" × 10"	4	3	10	7-1/2	2-1/2	30	82
094313	4 – 3" × 10" c/w Hem	4	3	10	7	2	20	82
094408	4 – 4" × 8"	4	4	8	8	2-1/2	20	125
094409	4 – 4" × 10" EXT	4	4	10	9-1/2	4	20	95
094410	4 – 4" × 10"	4	4	10	7-1/2	2-1/2	20	126
094420	4 – 4" × 10" c/w 1" Flange	4	4	10	7-1/2	2-1/4	20	126
094412	4 – 4" × 12"	4	4	12	9-3/4	2-1/2	20	130
095209	5 – 2-1/4" × 10" EXT	5	2-1/4	10	9-1/2	4	30	105
095210	5 – 2-1/4" × 10"	5	2-1/4	10	8	3	30	81
095212	5 – 2-1/4" × 12"	5	2-1/4	12	8	3	30	114
095310	5 – 3" × 10"	5	3	10	7-3/4	3	40	100
095313	5 – 3" × 10" c/w Hem	5	3	10	7-1/4	2-1/2	40	100
095408	5 – 4" × 8"	5	4	8	8	2-1/2	40	115
095409	5 – 4" × 10" EXT	5	4	10	9-1/2	4	20	110
095410	5 – 4" × 10"	5	4	10	7-3/8	2-1/2	40	114
095390	5 – 4" × 10" c/w 1" Flange	5	4	10	9-1/2	4	40	171
095412	5 – 4" × 12" EXT	5	4	12	9-1/2	4	20	121
096200	6 – 2" × 10" L/E c/w Damper	6	2	10	8-1/2	2-3/8	20	120
096210	6 – 2-1/4" × 10" EXT	6	2-1/4	10	9-1/2	4	10	120
096212	6 – 2-1/4" × 12" EXT	6	2-1/4	12	9-1/2	4	10	120
096214	6 – 2-1/4" × 14" EXT	6	2-1/4	14	9-1/2	3	10	130
096310	6 – 3" × 10"	6	3	10	7-1/2	3	20	100
096408	6 – 4" × 8"	6	4	8	8	3	20	105
096400	6 – 4" × 10" L/E c/w Damper	6	4	10	7	2-1/2	20	126
096409	6 – 4" × 10" EXT	6	4	10	9-1/2	4	20	120
096410	6 – 4" × 10"	6	4	10	7	2-1/2	20	105
096402	6 – 4" × 12" L/E c/w Damper	6	4	12	9-1/2	3-1/4	20	132
096412	6 – 4" × 12" EXT	6	4	12	9-1/2	3-1/4	20	100
096413	6 – 4" × 12" c/w Hem	6	4	10	7	2	20	105

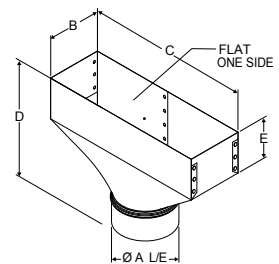

Universal Boot

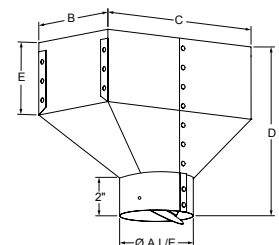

Universal Boot with Damper

(cont'd on next page)

UNIVERSAL BOOTS — P5 (cont'd)

ITEM #	DESCRIPTION	A (")	B (")	C (")	D (")	E (")	CTN/QTY	WT/100
096414	6 – 4" x 14" EXT	6	4	14	9-1/2	3	10	130
096610	6 – 6" x 10" EXT	6	6	10	9-1/2	3-13/16	10	120
096600	6 – 6" x 10" c/w 1" Flange	6	6	10	9-1/2	3-3/4	10	193
096612	6 – 6" x 12" EXT	6	6	12	9-1/2	3-13/16	10	120
096622	6 – 6" x 12" c/w 1" Flange	6	6	12	9-1/2	3-3/4	10	220
097400	7 – 4" x 10" L/E c/w Damper	7	4	10	9-1/2	4	10	139
097410	7 – 4" x 10" EXT	7	4	10	9-1/2	4	10	132
097402	7 – 4" x 12" L/E c/w Damper	7	4	12	9-1/2	4	10	147
097412	7 – 4" x 12" EXT	7	4	12	9-1/2	4	10	140
097415	7 – 4" x 14" c/w 1" Flange	7	4	14	9-1/2	4	10	160
097414	7 – 4" x 14" EXT	7	4	14	9-1/2	4	10	140
097610	7 – 6" x 10" EXT	7	6	10	9-1/2	4	10	160
097612	7 – 6" x 12" EXT	7	6	12	9-1/2	4	10	165
097613	7 – 6" x 12" c/w 1" Flange	7	6	12	9-1/2	4	10	221
097614	7 – 6" x 14" EXT	7	6	14	9-1/2	4	10	175
097624	7 – 6" x 14" c/w 1" Flange	7	6	14	9-1/2	3-1/8	10	258
098400	8 – 4" x 10" L/E c/w Damper	8	4	10	9-1/2	4	10	172
098402	8 – 4" x 12" L/E c/w Damper	8	4	12	9-1/2	4	10	179
098412	8 – 4" x 12" EXT	8	4	12	9-1/2	4	10	170
098404	8 – 4" x 14" L/E c/w Damper	8	4	14	9-1/2	4	10	185
098414	8 – 4" x 14" EXT	8	4	14	9-1/2	4	10	175
098610	8 – 6" x 10" EXT	8	6	10	9-1/2	4	10	160
098612	8 – 6" x 12" EXT	8	6	12	9-1/2	3-3/4	10	170
098613	8 – 6" x 12" c/w 1" Flange	8	6	12	9-1/2	3-3/4	10	242
098611	8 – 6" x 12" L/E c/w Damper	8	6	12	9-1/2	3-3/4	10	164
098614	8 – 6" x 14" EXT	8	6	14	9-1/2	3	10	180
098624	8 – 6" x 14" L/E c/w Damper	8	6	14	9-1/2	4	10	192
098623	8 – 6" x 14" c/w 1" Flange	8	6	14	9-1/2	3	10	252
099614	9 – 6" x 14" EXT	9	6	14	9-1/2	4	10	170
098674	10 – 6" x 14" LE c/w Damper	10	6	14	9-1/2	3-7/8	10	220

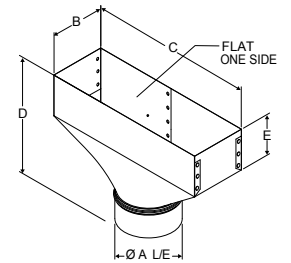

Universal Boot

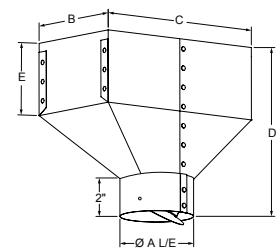

Universal Boot with Damper

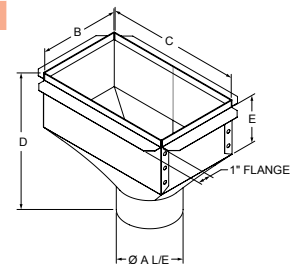

Universal Boot with 1" Flange

UNIVERSAL BOOTS WITH CLEATS — F5

ITEM #	SIZE (")	A (")	B (")	C (")	CTN/QTY	WT/100
095311	5 – 3-1/4 x 10	5	3-1/4	10	20	103
096311	6 – 3-1/4 x 10	6	3-1/4	10	10	100
096312	6 – 3-1/4 x 12	6	3-1/4	12	10	96
096314	6 – 3-1/4 x 14	6	3-1/4	14	10	100
097311	7 – 3-1/4 x 10	7	3-1/4	10	10	112
097312	7 – 3-1/4 x 12	7	3-1/4	12	10	125
097314	7 – 3-1/4 x 14	7	3-1/4	14	10	118
098311	8 – 3-1/4 x 10	8	3-1/4	10	10	160
098312	8 – 3-1/4 x 12	8	3-1/4	12	10	165
098314	8 – 3-1/4 x 14	8	3-1/4	14	10	170

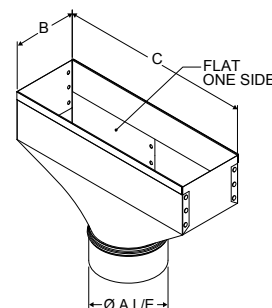

– E.&O.E. – Subject to Change Without Notice – May Not Be Available At All Locations –

ROUND TO OVAL ANGLE BOOTS 90°

ITEM #	SIZE (")	A (")	B (")	C (")	CTN/QTY	WT/100
097500	5 to 6 – (3 × 7-3/4)	5	3	7-3/4	30	90
097550	5 to 5 – (3 × 6-1/8)	5	3	6-1/8	30	85
097602	6 to 6 – (3 × 7-3/4)	6	3	7-3/4	30	130
097607	6 to 7 – (3 × 9-1/4)	6	3	9-1/4	12	135
097800	8 to 8 – (3 × 10-7/8)	8	3	10-7/8	10	170

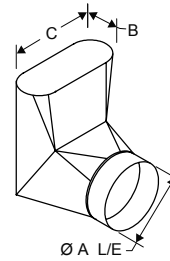

ITEM #	MODEL	SIZE (")	A (")	B (")	C (")	CTN/QTY	WT/100
097600	GV2098	6 to 6 – (3 × 7-3/4)	6	3	7-3/4	16	130
097700	GV2099	7 to 7 – (3 × 9-1/4)	7	3	9-1/4	12	150

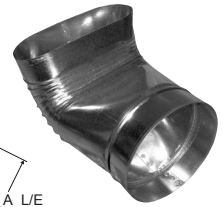
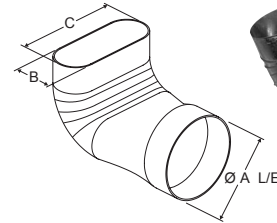

ROUND TO OVAL END BOOTS 90°

ITEM #	SIZE (")	A (")	B (")	C (")	CTN/QTY	WT/100
098495	5 to 5 – (3 × 6-1/8)	5	3	6-1/8	20	75
098500	5 to 6 – (3 × 7-3/4)	5	3	7-3/4	20	80
098600	6 to 6 – (3 × 7-3/4)	6	3	7-3/4	20	80
098607	6 to 7 – (3 × 9-1/4)	6	3	9-1/4	10	90
098700	7 to 7 – (3 × 9-1/4)	7	3	9-1/4	10	100
098800	8 to 8 – (3 × 10-7/8)	8	3	10-7/8	10	110

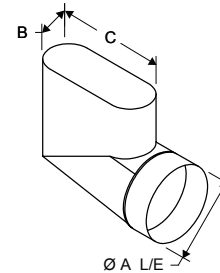

ROUND TO OVAL STRAIGHT BOOTS

ITEM #	SIZE (")	A (")	B (")	C (")	D (")	CTN/QTY	WT/100
099500	5 to 6 – (3 × 7-3/4)	5	3	7-3/4	7-1/2	20	80
099505	5 to 5 – (3 × 6-1/8)	5	3	6-1/8	7-1/2	20	74
099600	6 to 6 – (3 × 7-3/4)	6	3	7-3/4	7-1/2	20	80
099700	7 to 7 – (3 × 9-1/4)	7	3	9-1/4	6-5/8	10	100
099800	8 to 8 – (3 × 10-7/8)	8	3	10-7/8	7-3/4	10	110

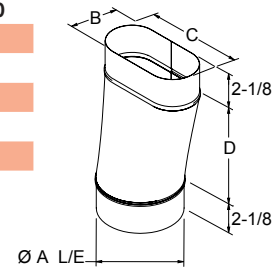

– E.&O.E. – Subject to Change Without Notice – May Not Be Available At All Locations –

HI EXTENSION — 12"

ITEM #	SIZE (")	A (")	B (")	C (")	GA	CTN/QTY	WT/100
136000	4 × 10	4	10	11-1/2	30	10	229

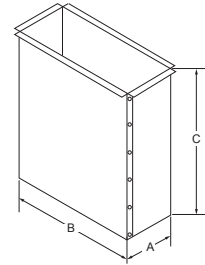

SLAB DIFFUSER COLLARS — OFF TOP

ITEM #	SIZE (")	A (")	B (")	GA	CTN/QTY	WT/100
551926	3 × 10	3	10	26	20	158
552026	4 × 10	4	10	26	20	171

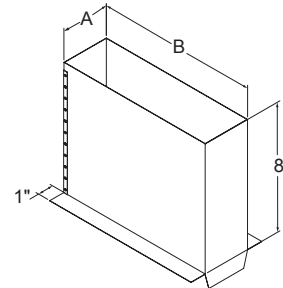

SLAB DIFFUSER COLLARS — OFF SIDE

ITEM #	SIZE (")	A (")	B (")	GA	CTN/QTY	WT/100
560426	3 × 10	3	10	26	10	176
560526	4 × 10	4	10	26	10	191

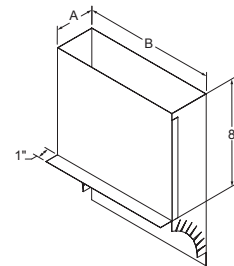

SLAB DIFFUSER CAPS

ITEM #	SIZE (")	A (")	B (")	GA	CTN/QTY	WT/100
573326	3 × 10	3	10	26	10	38
573426	4 × 10	4	10	26	10	45

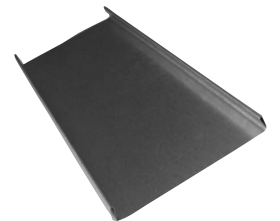
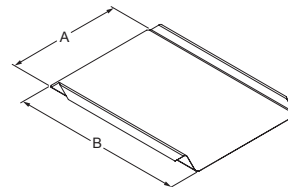

SLAB STAKES

ITEM #	SIZE (")	A (")	GA	CTN/QTY	WT/100
574020	36	36	20	10	83

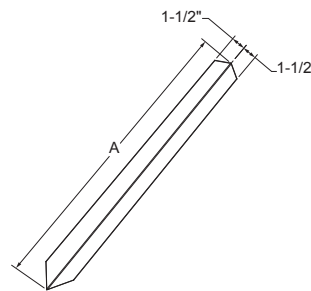

— E.&O.E. — Subject to Change Without Notice — May Not Be Available At All Locations —

TOP TAKE OFFS

4" — 7"

ITEM #	SIZE (")	A (")	B (")	C (")	CTN/QTY	WT/100
060400	4	4	4	6	40	65
060500	5	5	5	7	50	85
060600	6	6	6	7	30	95
060700	7	7	7	9	20	120

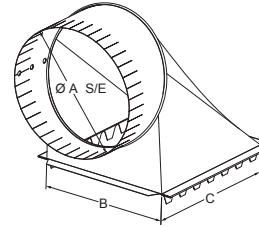

8" — 14"

ITEM #	SIZE (")	A (")	B (")	C (")	CTN/QTY	WT/100
060800	8	8	10	8	10	180
060809	9	9	11	9	5	300
060900	10	10	12	10	5	375
061000	12	12	14	12	3	600
061100	14	13-15/16	16	14	2	700

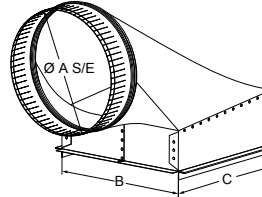

TOP TAKE OFFS — 26 GAUGE

4" — 7"

ITEM #	SIZE (")	A (")	B (")	C (")	GA	CTN/QTY	WT/100
500304	4	4	4	6	26	40	124
500305	5	5	5	7	26	50	134
500306	6	6	6	7	26	30	154
500307	7	7	7	9	26	30	194

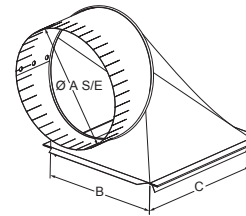

8" — 12"

ITEM #	SIZE (")	A (")	B (")	C (")	GA	CTN/QTY	WT/100
500308	8	8	10	8	26	10	291
500309	9	9	11	9	26	5	363
500310	10	10	12	10	26	5	435
500312	12	12	14	12	26	3	375

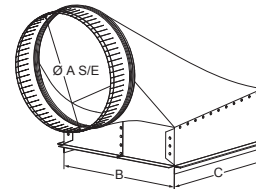

TOP TAKE OFFS — 5" TWO WAY

ITEM #	SIZE (")	A (")	B (")	C (")	CTN/QTY	WT/100
062400	5	5	8	8	20	140

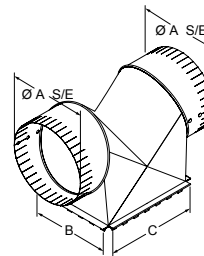

UNIVERSAL TAKE OFFS

ITEM #	SIZE (")	A (")	B (")	CTN/QTY	WT/100
062900	4	4	5	25	60
063000	5	5	6	36	72
063100	6	6	7	20	100

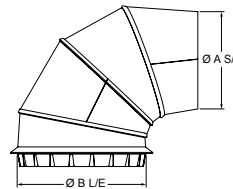

— E.&O.E. — Subject to Change Without Notice — May Not Be Available At All Locations —

ELBOW TAKE OFFS — GALVANIZED

ITEM #	SIZE (")	A (")	B (")	C (")	CTN/QTY	WT/100
063185	5	5	2-5/8	2-1/8	30	57
063186	6	6	2-11/16	2-11/16	20	76
063187	7	7	2-7/8	2-3/4	15	98
063188	8	8	3	3-1/4	15	129

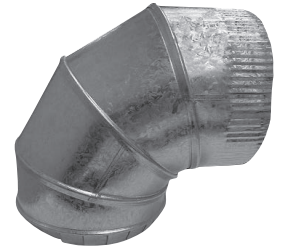
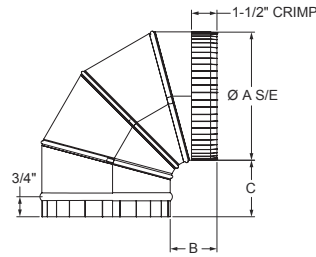

DUCTBOARD TAKE OFFS

ITEM #	SIZE (")	A (")	CTN/QTY	WT/100
133274	4	4	20	63
133275	5	5	10	81
133276	6	6	10	99
133277	7	7	10	119
133278	8	8	20	140
133279	9	9	8	162
133280	10	10	12	185
133282	12	12	8	235
133284	14	14	5	289
133286	16	16	5	347
133288	18	18	5	410
133290	20	20	2	477

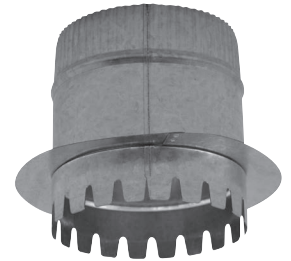
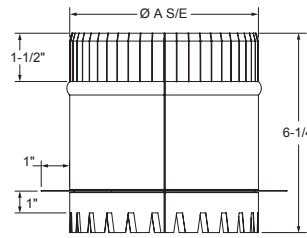

DUCTBOARD TAKE OFF ELBOWS

ITEM #	SIZE (")	A (")	B (")	C (")	CTN/QTY	WT/100
502455	5	5	2-7/8	2-5/8	30	117
502456	6	6	3-7/16	2-11/16	20	145
502457	7	7	3-1/2	2-7/8	15	194
502458	8	8	4	3	15	250

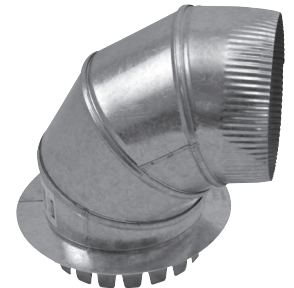
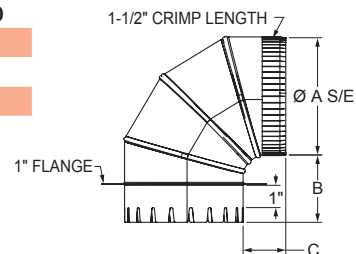

-E.&O.E. - Subject to Change Without Notice - May Not Be Available At All Locations -

SIDE TAKE OFFS

4" – 8"

ITEM #	SIZE (")	A (")	B (")	C (")	CTN/QTY	WT/100
061400	4	4	4	6	20	56
061500	5	5	5	7	50	62
061600	6	6	6	7	50	58
061700	7	7	8	8	50	90
061800	8	8	8	11	20	150

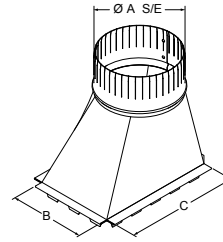

10" – 14"

ITEM #	SIZE (")	A (")	B (")	C (")	CTN/QTY	WT/100
061810	10	10	10	13	20	270
061812	12	12	12	14	10	340
061814	14	13-15/16	14	17	10	440

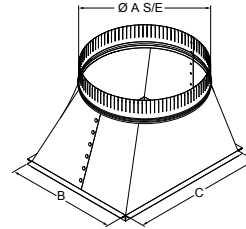

26 GAUGE

4" – 8"

ITEM #	SIZE (")	A (")	B (")	C (")	GA	CTN/QTY	WT/100
500426	4	4	4	6	26	20	80
500526	5	5	5	7	26	20	100
500626	6	6	6	8	26	20	142
500726	7	7	7	9	26	20	150
500826	8	8	8	10	26	20	216

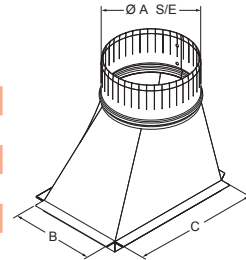

9" – 14"

ITEM #	SIZE (")	A (")	B (")	C (")	GA	CTN/QTY	WT/100
500926	9	9	9	11	26	20	290
501026	10	10	10	12	26	20	316
501226	12	12	12	14	26	10	366
501426	14	13-15/16	14	16	26	10	540

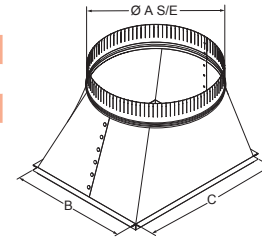

24 GAUGE

16" – 24"

ITEM #	SIZE (")	A (")	B (")	C (")	GA	CTN/QTY	WT/100
501624	16	15-15/16	16	19	24	6	730
501824	18	17-7/8	18	21	24	5	790
502024	20	19-7/8	20	23	24	5	840
502224	22	21-7/8	22	26	24	*	990
502424	24	23-7/8	24	28	24	*	1100

*Product shipped individually.

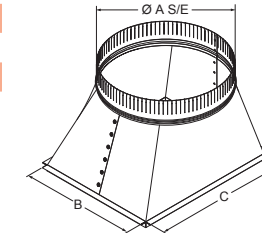

22 GAUGE

22" – 24"

ITEM #	SIZE (")	A (")	B (")	C (")	GA	CTN/QTY	WT/100
502222	22	21-7/8	22	26	22	*	1200
502422	24	23-7/8	24	28	22	*	1340

*Product shipped individually.

-E.&O.E. - Subject to Change Without Notice - May Not Be Available At All Locations -

SIDE TAKE OFFS WITH DAMPER (KS-145 REGULATOR)

ITEM #	SIZE (")	A (")	B (")	C (")	GA	CTN/QTY	WT/100
502505	5	5	5	7	26	30	114
502506	6	6	6	7	26	20	122
502507	7	7	8	8	26	10	166
502508	8	8	8	11	26	10	242
502510	10	10	10	13	26	6	433
502512	12	12	12	14	26	4	550
502514	14	13-15/16	14	17	26	2	850

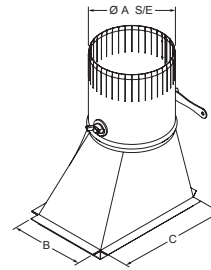

SADDLE TAKE OFFS

ITEM #	SIZE (")	A (")	B (")	C (")	CTN/QTY	WT/100
061900	4	4	2	10	20	50
062000	5	5	2	10	50	55
062100	6	6	2	12	50	60
062200	7	7	2	12	50	80
062300	8	8	3	12	20	120

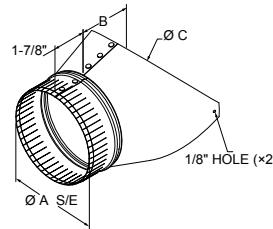

28 GAUGE

ITEM #	SIZE (")	A (")	B (")	C (")	GA	CTN/QTY	WT/100
502804	4	4	2	10	28	20	70
502805	5	5	2	10	28	50	70
502806	6	6	2	12	28	50	73
502807	7	7	2	12	28	50	86
502808	8	8	3	12	28	20	125
502809	9	9	3	14	28	20	133
502810	10	10	3	14	28	20	140
502812	12	12	3	14	28	10	266
502814	14	13-15/16	3	16	28	10	300
502816	16	15-15/16	3	18	26	10	342
502818	18	17-7/8	3	20	26	6	380
502820	20	19-7/8	3	22	24	*	420

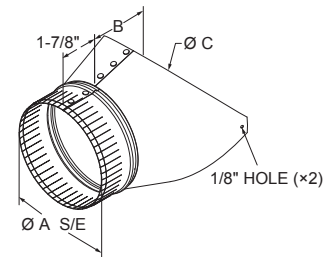
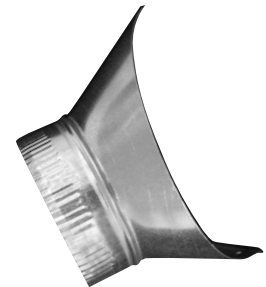

*Product shipped individually.

26 GAUGE

ITEM #	SIZE (")	A (")	B (")	C (")	GA	CTN/QTY	WT/100
502816	16	15-15/16	3	18	26	10	342
502818	18	17-7/8	3	20	26	6	380

24 GAUGE

ITEM #	SIZE (")	A (")	B (")	C (")	GA	CTN/QTY	WT/100
502820	20	19-7/8	3	22	24	*	420

*Product shipped individually.

SADDLE TAKE OFFS WITH 5" COLLAR

ITEM #	SIZE (")	A (")	B (")	C (")	GA	CTN/QTY	WT/100
502825	4	4	2	10	26	30	80
502826	5	5	2	10	26	30	75
502827	6	6	2	12	26	30	85
502828	7	7	2	12	26	20	95
502829	8	8	3	12	26	20	125
502830	9	9	3	14	26	10	155
502831	10	10	3	14	26	10	185
502832	12	12	3	14	26	10	230
502833	14	13-15/16	3	16	26	8	270
502834	16	15-15/16	3	18	26	*	320
502835	18	17-7/8	3	20	26	*	370
502836	20	19-7/8	3	22	24	*	440

*Product shipped individually.

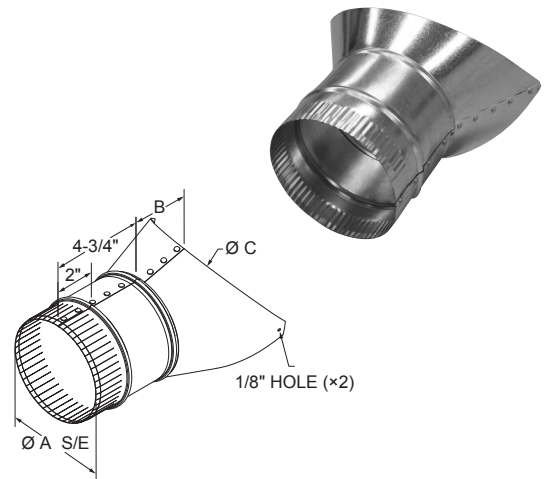

PIPE TAKE OFFS

ITEM #	SIZE (")	A (")	B (")	C (")	GA	CTN/QTY	WT/100
550426	4	4	4	6	26	20	80
550526	5	5	5	7	26	20	100
550626	6	6	6	8	26	20	142
550726	7	7	7	9	26	20	175
550826	8	8	8	10	26	20	208

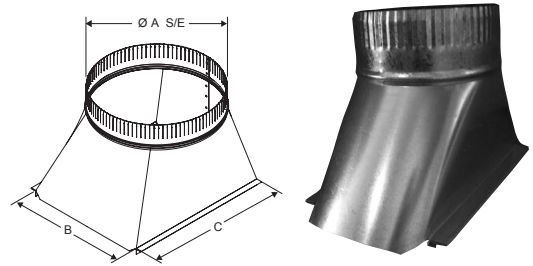

ITEM #	SIZE (")	A (")	B (")	C (")	GA	CTN/QTY	WT/100
551026	10	10	10	12	26	20	292
551226	12	12	12	14	26	10	366

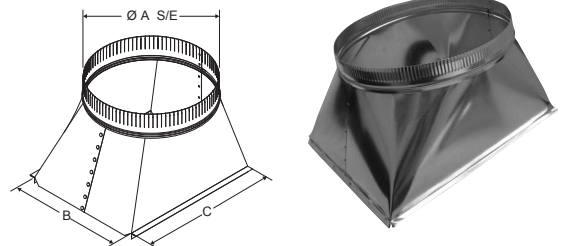

- E.&O.E. - Subject to Change Without Notice - May Not Be Available At All Locations -

UNIVERSAL WYES

ITEM #	SIZE (")	A (")	B (")	C (")	CTN/QTY	WT/100
134898	4 × 3 × 3	4	3	3	20	155
134902	4 × 4 × 3	4	4	3	20	160
134904	4 × 4 × 4	4	4	4	20	160
134910	5 × 3 × 3	5	3	3	20	150
134912	5 × 4 × 3	5	4	3	20	165
134914	5 × 4 × 4	5	4	4	20	165
134915	5 × 5 × 4	5	5	4	20	312
134916	5 × 5 × 5	5	5	5	20	303
134920	6 × 4 × 4	6	4	4	20	175
134923	6 × 5 × 4	6	5	4	10	325
134924	6 × 5 × 5	6	5	5	10	175
134925	6 × 6 × 4	6	6	4	10	331
134926	6 × 6 × 5	6	6	5	10	185
134928	6 × 6 × 6	6	6	6	10	190
134931	7 × 5 × 4	7	5	4	10	200
134932	7 × 5 × 5	7	5	5	10	200
134934	7 × 6 × 4	7	6	4	10	200
134936	7 × 6 × 5	7	6	5	10	210
134937	7 × 6 × 6	7	6	6	10	200
134938	7 × 7 × 5	7	7	5	10	225
134940	7 × 7 × 7	7	7	7	10	225
134941	8 × 5 × 5	8	5	5	10	240
134943	8 × 6 × 5	8	6	5	10	220
134944	8 × 6 × 6	8	6	6	10	225
134945	8 × 7 × 5	8	7	5	10	230
134946	8 × 7 × 6	8	7	6	10	240
134947	8 × 7 × 7	8	7	7	10	250
134942	8 × 8 × 5	8	8	5	10	260
134948	8 × 8 × 6	8	8	6	10	260
134950	8 × 8 × 8	8	8	8	5	260
134949	9 × 8 × 8	9	8	8	5	280
134952	9 × 6 × 6	9	6	6	10	255
134953	9 × 7 × 5	9	7	5	10	255
134954	9 × 7 × 6	9	7	6	10	260
134955	9 × 7 × 7	9	7	7	5	275
134956	9 × 8 × 5	9	8	5	10	255
134957	9 × 8 × 6	9	8	6	5	270
134958	9 × 8 × 7	9	8	7	5	280
134951	9 × 9 × 9	9	9	9	5	290
134961	10 × 6 × 6	10	6	6	5	260
135008	10 × 7 × 6	10	7	6	5	270
134962	10 × 7 × 7	10	7	7	5	280
135009	10 × 8 × 5	10	8	5	5	283
134963	10 × 8 × 6	10	8	6	5	285
134964	10 × 8 × 7	10	8	7	5	290
134965	10 × 8 × 8	10	8	8	5	305
134960	10 × 9 × 5	10	9	5	5	290
134966	10 × 9 × 6	10	9	6	5	290
134967	10 × 9 × 7	10	9	7	5	305
134969	10 × 9 × 8	10	9	8	5	305
134959	10 × 9 × 9	10	9	9	5	305
134968	10 × 10 × 6	10	10	6	5	305

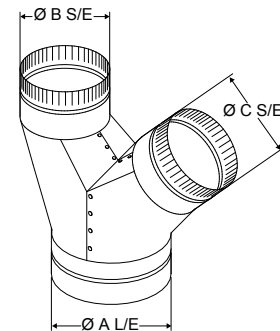

(cont'd on next page)

-E.&O.E. - Subject to Change Without Notice - May Not Be Available At All Locations -

UNIVERSAL WYES (cont'd)

ITEM #	SIZE (")	A (")	B (")	C (")	CTN/QTY	WT/100
134970	10 × 10 × 8	10	10	8	4	305
134971	10 × 10 × 10	10	10	10	4	305
135010	12 × 6 × 6	12	6	6	5	305
134972	12 × 8 × 6	12	8	6	5	305
135017	12 × 8 × 7	12	8	7	5	315
134973	12 × 8 × 8	12	8	8	5	325
135011	12 × 9 × 7	12	9	7	5	325
134978	12 × 9 × 8	12	9	8	5	345
134974	12 × 9 × 9	12	9	9	5	345
134975	12 × 10 × 6	12	10	6	5	330
134979	12 × 10 × 7	12	10	7	5	345
134976	12 × 10 × 8	12	10	8	5	345
134980	12 × 10 × 9	12	10	9	5	370
134977	12 × 10 × 10	12	10	10	4	370
134981	12 × 12 × 6	12	12	6	*	380
135012	12 × 12 × 8	12	12	8	5	380
135018	12 × 12 × 10	12	12	10	5	380
134983	12 × 12 × 12	12	12	12	*	380
135016	14 × 8 × 8	14	8	8	*	385
135013	14 × 10 × 8	14	10	8	*	425
134982	14 × 10 × 10	14	10	10	*	390
134984	14 × 12 × 8	14	12	8	*	390
134985	14 × 12 × 6	14	12	6	*	390
135015	14 × 12 × 7	14	12	7	*	390
135014	14 × 12 × 9	14	12	9	*	415
134986	14 × 12 × 10	14	12	10	*	415
134988	14 × 12 × 12	14	12	12	*	435
134987	14 × 14 × 6	14	14	6	*	435
134989	14 × 14 × 8	14	14	8	*	435
135020	14 × 14 × 12	14	14	12	*	435
134995	16 × 10 × 10	16	10	10	*	440
134990	16 × 12 × 10	16	12	10	*	440
134991	16 × 12 × 8	16	12	8	*	440
134992	16 × 12 × 12	16	12	12	*	460
134993	16 × 14 × 8	16	14	8	*	460
134994	16 × 14 × 10	16	14	10	*	460
134996	16 × 14 × 12	16	14	12	*	480
134998	16 × 14 × 14	16	14	14	*	505
134997	16 × 16 × 8	16	16	8	*	460
134999	16 × 16 × 16	16	16	16	*	510
135001	18 × 14 × 12	18	14	12	*	480
135002	18 × 14 × 14	18	14	14	*	480
135007	18 × 16 × 8	18	16	8	*	480
135005	18 × 16 × 10	18	16	10	*	480
135006	18 × 16 × 12	18	16	12	*	480
135003	18 × 16 × 14	18	16	14	*	480
135004	18 × 16 × 16	18	16	16	*	485
135025	20 × 18 × 12	20	18	12	*	500
135024	20 × 18 × 14	20	18	14	*	525
135027	20 × 18 × 16	20	18	16	*	550
135026	20 × 18 × 18	20	18	18	*	580

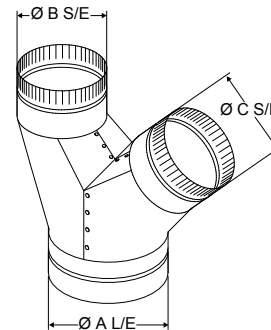

*Product shipped individually.

– E.&O.E. – Subject to Change Without Notice – May Not Be Available At All Locations –

PANT WYES — GALVANIZED — SMALL END

ITEM #	SIZE (")	A (")	B (")	C (")	GA	CTN/QTY	WT/100
134832	6 × 6 × 6	6	6	6	28	10	160
134836	8 × 6 × 6	8	6	6	28	10	220
134838	8 × 8 × 8	8	8	8	28	5	220
134840	10 × 6 × 6	10	6	6	28	6	280
134842	10 × 8 × 8	10	8	8	28	5	280
134844	10 × 10 × 10	10	10	10	28	4	280
134848	12 × 8 × 8	12	8	8	28	3	350
134850	12 × 10 × 10	12	10	10	28	3	350
134852	12 × 12 × 12	12	12	12	28	2	350

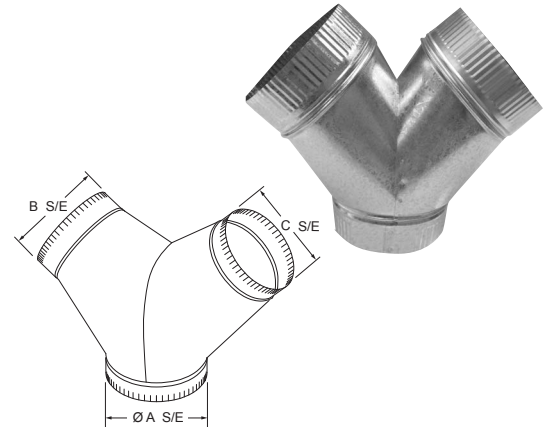

SADDLE WYES — GALVANIZED — SMALL END

ITEM #	SIZE	A (")	B (")	C (")	TO FIT PIPE DIAMETER	GA	CTN/QTY	WT/100
133144	4" × 45°	4	10	2-5/16	8, 10, 12, 14, 16	26	20	127
133145	5" × 45°	5	11	2	8, 10, 12, 14	26	20	161
133146	6" × 45°	6	13	2-3/8	10, 12	26	10	214
133147	7" × 45°	7	14	2-1/8	12, 14	26	10	245
133148	8" × 45°	8	15-1/2	2-3/16	12, 14	26	10	300
133149	9" × 45°	9	17-1/2	2-1/2	14, 16	26	10	334
133150	10" × 45°	10	19-1/2	2-13/16	14, 16	26	5	417
133152	12" × 45°	12	22	2-5/8	14, 16	26	5	532
133154	14" × 45°	13-15/16	26	3-1/2	16, 18	26	5	660

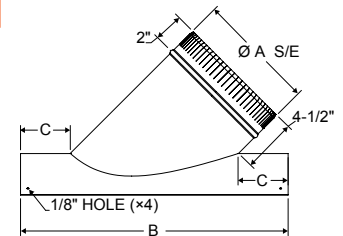

SADDLE WYES — GALVANIZED

ITEM #	SIZE	A (")	GA	CTN/QTY	WT/100
135363	3" × 45°	3	28	20	42
135364	4" × 45°	4	28	20	53
135365	5" × 45°	5	26	10	130
135366	6" × 45°	6	26	10	134

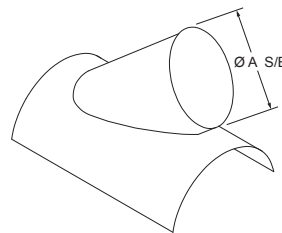

— E.&O.E. — Subject to Change Without Notice — May Not Be Available At All Locations —

WYE BRANCHES — 26 GAUGE

ITEM #	SIZE (")	A (")	B (")	C (")	D (")	E (")	F (")	CTN/QTY	WT/100
135028	3 x 3 x 3	3	3	3	8-3/4	5-3/4	2	20	70
135030	4 x 3 x 3	4	3	3	9-1/4	6-3/8	2-5/8	20	100
135035	4 x 4 x 3	4	4	3	9	6-13/16	2-3/4	20	116
135040	4 x 4 x 4	4	4	4	10	7-3/8	2-1/2	20	120
135042	5 x 3 x 3	5	3	3	9-1/2	6-5/8	3	20	136
135043	5 x 4 x 3	5	4	3	10	6-15/16	3	20	138
135044	5 x 4 x 4	5	4	4	11-1/2	7-15/16	3	20	140
135046	5 x 5 x 3	5	5	3	9	7-1/2	2-1/2	20	143
135050	5 x 5 x 4	5	5	4	10	8	2-3/8	20	145
135051	5 x 5 x 5	5	5	5	11	8-1/2	2	20	150
135090	6 x 4 x 4	6	4	4	10-3/4	7-1/2	3-1/4	20	160
135100	6 x 5 x 3	6	5	3	10	7-5/8	3	20	155
135200	6 x 5 x 4	6	5	4	11	8-3/16	3-1/4	20	165
135201	6 x 5 x 5	6	5	5	13	9-3/16	3-1/2	20	170
135202	6 x 6 x 5	6	6	5	11-1/2	9-1/4	2-1/2	20	185
135203	6 x 6 x 6	6	6	6	12-3/4	9-3/4	2-1/4	10	190
135299	6 x 6 x 3	6	6	3	9	8-1/2	2-1/2	20	182
135300	6 x 6 x 4	6	6	4	10	9	2-3/8	20	190
135305	7 x 6 x 4	7	6	4	10-3/4	8-3/8	3	10	200
135310	7 x 7 x 4	7	7	4	10	9-1/2	2-1/2	10	220
135311	7 x 7 x 5	7	7	5	12	10	2-1/2	10	225
135312	7 x 7 x 6	7	7	6	13	10-1/2	2-1/2	10	225
135313	7 x 7 x 7	7	7	7	14	10-11/16	2-1/2	10	230
135318	8 x 6 x 6	8	6	6	13-1/4	9	3-1/2	10	250
135322	8 x 8 x 4	8	8	4	11-1/2	11-1/4	3	10	250
135323	8 x 8 x 5	8	8	5	13-1/8	11-3/16	3-1/2	10	250
135324	8 x 8 x 6	8	8	6	13	11-3/16	2-1/2	10	260
135326	8 x 8 x 8	8	8	8	15-1/2	12-3/16	2-1/4	5	270
135336	10 x 8 x 6	10	8	6	13-3/4	11-7/8	3	4	360
135338	10 x 8 x 8	10	8	8	16-3/4	12-3/4	3	4	380
135341	10 x 10 x 10	10	10	10	20-1/4	15-13/16	3	4	420
135348	12 x 12 x 12	12	12	12	23	17-1/2	3	2	540

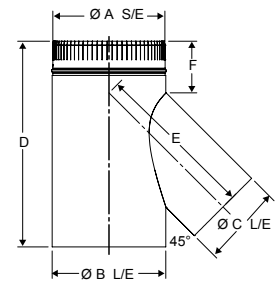

- E.&O.E. - Subject to Change Without Notice - May Not Be Available At All Locations -

STRAIGHT CONE WYES

ITEM #	SIZE (")	A (")	B (")	C (")	CTN/QTY	WT/100
563200	6 × 6 × 6	6	6	6	12	200
563201	8 × 6 × 6	8	6	6	12	270
563202	8 × 8 × 6	8	8	6	6	300
563204	10 × 8 × 6	10	8	6	12	370
563205	10 × 8 × 8	10	8	8	6	450
563206	10 × 10 × 6	10	10	6	4	490
563207	10 × 10 × 8	10	10	8	4	520
563209	12 × 8 × 8	12	8	8	4	480
563210	12 × 10 × 8	12	10	8	4	560
563211	12 × 10 × 10	12	10	10	4	540
563212	12 × 12 × 6	12	12	6	4	560
563213	12 × 12 × 8	12	12	8	2	590
563214	12 × 12 × 10	12	12	10	2	620
563216	14 × 10 × 8	14	10	8	2	660
563217	14 × 10 × 10	14	10	10	4	710
563224	14 × 12 × 9	14	12	9	4	740
563218	14 × 12 × 10	14	12	10	4	750
563219	14 × 12 × 12	14	12	12	3	790
563220	14 × 14 × 6	14	14	6	2	750
563221	14 × 14 × 8	14	14	8	2	800
563222	14 × 14 × 10	14	14	10	2	850
563223	14 × 14 × 12	14	14	12	1	890
563226	16 × 12 × 10	16	12	10	2	980
563227	16 × 12 × 12	16	12	12	2	1040
563228	16 × 14 × 10	16	14	10	2	1090
563229	16 × 14 × 12	16	14	12	2	1190
563230	16 × 14 × 14	16	14	14	2	1250
563233	18 × 14 × 14	18	14	14	1	1400
563234	18 × 16 × 12	18	16	12	2	1400
563235	18 × 16 × 14	18	16	14	1	1500
563236	18 × 16 × 16	18	16	16	2	1600
563237	18 × 18 × 18	18	18	18	2	1700

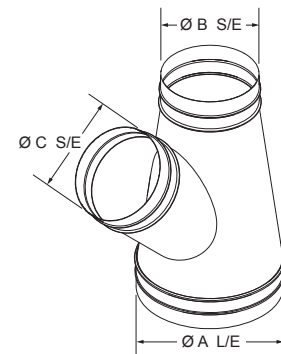

- E.&O.E. - Subject to Change Without Notice - May Not Be Available At All Locations -

AIR CUSHION TEES

ITEM #	SIZE (")	A (")	B (")	C (")	GA	CTN/QTY	WT/100
502840	6 × 6 × 6	6	6	6	26	10	280
502850	8 × 8 × 8	8	8	8	26	5	450
502860	10 × 10 × 10	10	10	10	26	4	660
502870	12 × 12 × 12	12	12	12	26	2	910

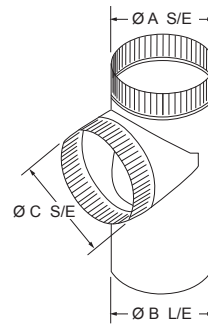

SADDLE TEES — GALVANIZED

ITEM #	SIZE	A (")	B (")	TO FIT PIPE DIAMETER	GA	CTN/QTY	WT/100
133124	4" × 90°	4	8	8, 10, 12, 14, 16	26	40	72
133125	5" × 90°	5	9	8, 10, 12, 14	26	25	85
133126	6" × 90°	6	10	10, 12, 14	26	20	110
133127	7" × 90°	7	11	12, 14	26	20	125
133128	8" × 90°	8	12	12, 14	26	20	143
133129	9" × 90°	9	13	14, 16	26	10	156
133130	10" × 90°	10	14	14, 16	26	10	170
133132	12" × 90°	12	18	14, 16	26	6	211

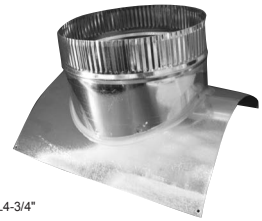
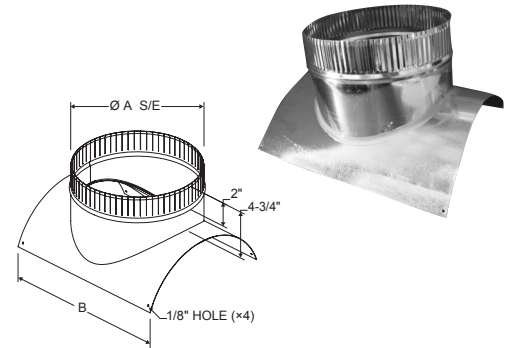

SADDLE TEES — GALVANIZED — NO CRIMP

ITEM #	SIZE	A (")	B (")	TO FIT PIPE DIAMETER	GA	CTN/QTY	WT/100
133106	6" × 90°	6	10	10, 12, 14	30	20	90

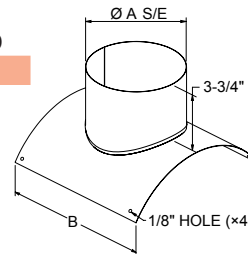

TEES — 30 GAUGE

ITEM #	SIZE (")	A (")	B (")	C (")	D (")	E (")	F (")	CTN/QTY	WT/100
135690	6 × 6 × 6	6	6	6	10-1/2	2-1/4	2-1/2	20	90

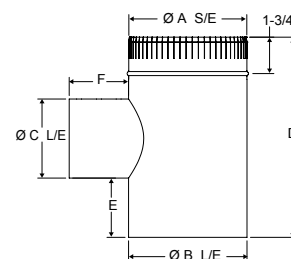

– E.&O.E. – Subject to Change Without Notice – May Not Be Available At All Locations –

TEES — 26 GAUGE

ITEM #	SIZE (")	A (")	B (")	C (")	D (")	E (")	F (")	CTN/QTY	WT/100
135380	3 x 3 x 3	3	3	3	8	2-1/2	2-1/2	20	65
135399	4 x 4 x 3	4	4	3	9	3	2-1/4	20	110
135398	4 x 4 x 4	4	4	4	9	2-1/2	2-1/2	20	100
135403	5 x 4 x 4	5	4	4	10	3-1/2	2-3/4	26	140
135400	5 x 5 x 3	5	5	3	8	2-1/8	2-1/2	20	115
135401	5 x 5 x 4	5	5	4	9	2	2-1/2	20	120
135402	5 x 5 x 5	5	5	5	10	2	2-1/4	20	130
135701	6 x 4 x 4	6	4	4	10	3	2-1/2	26	135
135699	6 x 6 x 3	6	6	3	8	2-1/2	2-1/4	20	135
135700	6 x 6 x 4	6	6	4	9	2	2-1/2	20	135
135698	6 x 6 x 5	6	6	5	10	2	2-1/2	20	150
135697	6 x 6 x 6	6	6	6	10-1/2	2-1/4	2-1/2	20	165
135702	7 x 7 x 3	7	7	3	8	2-3/4	2-1/4	10	190
135703	7 x 7 x 4	7	7	4	8	2-1/2	2-1/2	10	200
135704	7 x 7 x 5	7	7	5	10	2	2-3/8	10	210
135706	7 x 7 x 6	7	7	6	11	2-1/4	2-1/2	10	215
135707	7 x 7 x 7	7	7	7	11-1/2	2-1/4	2-1/2	10	220
136003	8 x 8 x 3	8	8	3	10	2-1/2	2-1/4	10	260
136004	8 x 8 x 4	8	8	4	9	2-1/2	2-1/2	10	265
136005	8 x 8 x 5	8	8	5	10	2-1/2	2-1/2	10	265
136006	8 x 8 x 6	8	8	6	11	2-1/8	2-1/2	10	265
136017	8 x 8 x 7	8	8	7	13	3	3	10	270
136018	8 x 8 x 8	8	8	8	13	2	2-1/2	10	270
136199	9 x 9 x 9	9	9	9	14	2-1/2	2-1/2	10	425
136201	10 x 10 x 10	10	10	10	15	2-1/2	2-1/2	6	400
136202	12 x 12 x 12	12	12	12	17	2-1/8	2-1/2	4	480
136204	14 x 14 x 14	13-15/16	13-15/16	13-15/16	18	2-1/2	2-1/2	*	860

*Product shipped individually.

TEES — 24 GAUGE

ITEM #	SIZE (")	A (")	B (")	C (")	D (")	E (")	F (")	CTN/QTY	WT/100
135397	4 x 4 x 4	4	4	4	9	2-1/2	2-1/2	20	105
135405	5 x 5 x 5	5	5	5	10	2-1/2	2-1/2	20	165
135692	6 x 6 x 6	6	6	6	10-1/2	2-1/4	2-1/2	20	212
135710	7 x 7 x 7	7	7	7	11-1/2	2-1/4	2-1/2	10	280
136020	8 x 8 x 8	8	8	8	13	2	2-1/2	10	345
136022	10 x 10 x 10	10	10	10	15	2-1/2	2-1/2	6	505
136024	12 x 12 x 12	12	12	12	17	2-1/8	2-1/2	4	567
136026	14 x 14 x 14	13-15/16	13-15/16	13-15/16	18	2-1/2	2-1/2	*	625
136028	16 x 16 x 16	15-15/16	15-15/16	15-15/16	22	3	3	*	892
136030	18 x 18 x 18	17-7/8	17-7/8	17-7/8	24	3-1/4	3	*	950

*Product shipped individually.

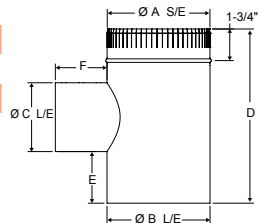
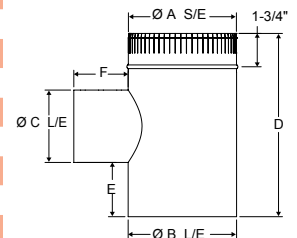

TAP-IN COLLARS SMALL END (STARTING COLLARS)

ITEM #	SIZE (")	A (")	PCS/BNDL	WT/100
133300	3	3	5	25
133400	4	4	5	33
133500	5	5	10	41
133600	6	6	10	48
133700	7	7	10	56
133800	8	8	10	63
133900	9	9	10	71
134190	9-1/4	9-1/4	10	76
134000	10	10	10	78
134120	12	12	10	111
134140	14	13-15/16	10	129
134160	16	15-15/16	10	147
134180	18	17-7/8	10	165

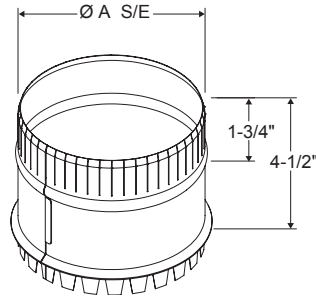

TAP-IN COLLARS SMALL END LONG — SEAM WELDED

ITEM #	SIZE (")	A (")	PCS/BNDL	WT/100
134224	4	4	20	35
134225	5	5	20	43
134226	6	6	20	52
134227	7	7	20	60
134228	8	8	10	82
134229	9	9	10	93
134230	10	10	8	103
134232	12	12	8	123
134234	14	14	8	143
134236	16	16	*	164
134238	18	18	*	184

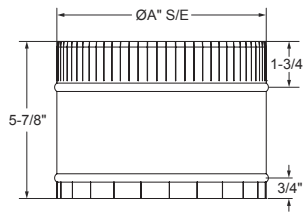

*Product shipped individually.

TAP-IN COLLARS SMALL END LONG WITH DAMPER

ITEM #	SIZE (")	A (")	PCS/BNDL	WT/100
134206	6	6	20	60
134207	7	7	20	68
134208	8	8	10	78
134210	10	10	8	96
134212	12	12	8	137
134214	14	14	8	159
134216	16	16	*	181
134218	18	18	*	203

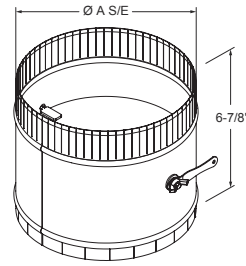

*Product shipped individually.

TAP-IN COLLARS SMALL END — 3" LONG

ITEM #	SIZE (")	A (")	PCS/BNDL	WT/100
050333	3	3	40	14
050334	4	4	40	18
050335	5	5	25	22
050340	6	6	20	25
050347	7	7	25	31
050348	8	8	20	35
050349	9	9	20	39
050350	10	10	20	44
050352	12	12	20	52
050354	14	14	10	61
050356	16	16	20	69
050358	18	18	10	78

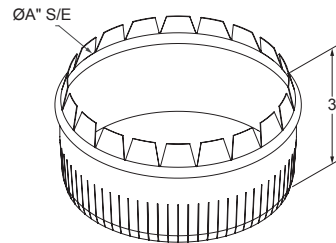

TAP-IN COLLARS LARGE END (STARTING COLLARS)

ITEM #	DESCRIPTION	A (")	PCS/BNDL	WT/100
133301	3"	3	5	26
133401	4"	4	5	34
133501	5"	5	10	41
133601	6"	6	10	49
133701	7"	7	10	56
133801	8"	8	10	64
133901	9"	9	10	71
134001	10"	10	10	79
134121	12"	12	10	112
134129	12" X-OVER KIT	12	KIT	112
134141	14"	13-15/16	10	130
134161	16"	15-15/16	10	148
134181	18"	17-7/8	10	166

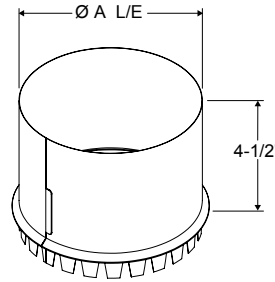

SPIN-IN COLLARS — 4" LONG

ITEM #	SIZE (")	A (")	B (")	GA	CTN/QTY	WT/100
502604	4	4	3-3/4	26	40	40
502605	5	5	4-3/4	26	40	52
502606	6	6	5-3/4	26	40	62
502607	7	7	6-3/4	26	40	73
502608	8	8	7-3/4	26	40	78
502609	9	9	8-3/4	26	20	90
502610	10	10	9-3/4	26	20	110
502612	12	12	11-3/4	26	10	139
502614	14	13-15/16	13-9/16	26	*	158
502616	16	15-15/16	15-9/16	26	*	135
502618	18	17-7/8	17-1/2	26	*	151
502620	20	19-7/8	19-1/2	24	*	214

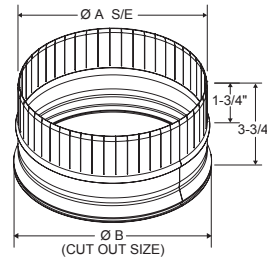

*Product shipped individually.

SPIN-IN COLLARS WITH DAMPER

ITEM #	SIZE (")	A (")	B (")	C (")	GA	CTN/QTY	WT/100
502744	4	4	3-3/4	6	26	20	77
502745	5	5	4-3/4	6	26	20	96
502746	6	6	5-3/4	6	26	25	114
502747	7	7	6-3/4	6	26	20	134
502748	8	8	7-3/4	7	26	20	171
502749	9	9	8-3/4	8	26	10	218
502750	10	10	9-3/4	9	26	10	262
502752	12	12	11-3/4	11	26	6	395

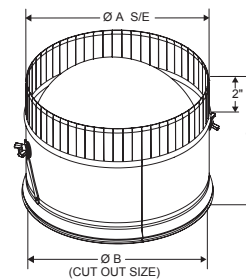

ITEM #	SIZE (")	A (")	B (")	C (")	D (")	GA	CTN/QTY	WT/100
502734	14	13-15/16	13-9/16	13	6-1/2	26	*	517
502736	16	15-15/16	15-9/16	15	7-1/2	26	*	675
502738	18	17-7/8	17-1/2	17	8-1/2	26	*	848
502740	20	19-7/8	19-1/2	19	9-1/2	24	*	1212

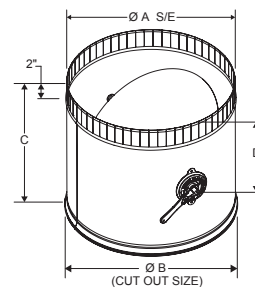

NOTE: Sizes 14" through 20" include a 3/8" continuous rod damper.

*Product shipped individually.

-E.&O.E. - Subject to Change Without Notice - May Not Be Available At All Locations -

SPIN-IN COLLARS WITH DAMPER AND SCOOP

ITEM #	SIZE (")	A (")	B (")	C (")	GA	CTN/QTY	WT/100
502585	5	4	4-3/4	6	28	20	100
502586	6	5	5-3/4	6	28	20	115
502587	7	6	6-3/4	6	28	20	145
502588	8	7	7-3/4	7	28	15	175
502589	9	8	8-3/4	8	28	12	200
502590	10	9	9-3/4	9	26	6	245
502592	12	12	11-3/4	11	26	6	299

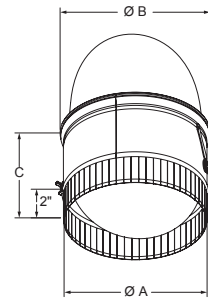

SPIN-IN COLLARS WITH DAMPER (KS-145 REGULATOR)

ITEM #	SIZE (")	A (")	B (")	C (")	D (")	GA	CTN/QTY	WT/100
502704	4	4	3-3/4	5	2	26	40	65
502705	5	5	4-3/4	5-7/16	2	26	40	93
502706	6	6	5-3/4	6-7/16	2-1/2	26	20	125
502707	7	7	6-3/4	7-1/2	3	26	20	153
502708	8	8	7-3/4	7-3/4	3-1/2	26	20	183
502709	9	9	8-3/4	9-1/4	4	26	10	245
502710	10	10	9-3/4	10-1/4	4-1/2	26	10	300
502712	12	12	11-3/4	12-1/4	5-1/2	26	6	450
502714	14	13-15/16	13-9/16	14-1/4	6-1/2	26	2	660

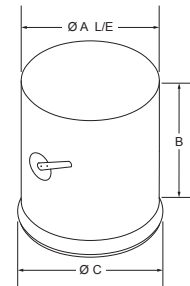

CONICAL SPIN-IN COLLARS WITH DAMPER

ITEM #	SIZE (")	A (")	B (")	C (")	D (")	GA	CTN/QTY	WT/100
502545	5	5	7	7-7/8	3-1/8	26	20	160
502546	6	6	8	7-7/8	3-1/8	26	25	180
502547	7	7	9	7-7/8	3-1/8	26	20	190
502548	8	8	10	7-7/8	3 1/8	26	20	200
502549	9	9	12	8-3/8	3-7/8	26	10	255
502550	10	10	12	8-3/8	3-7/8	26	10	305
502552	12	12	13-15/16	10-3/8	4-7/8	26	5	420

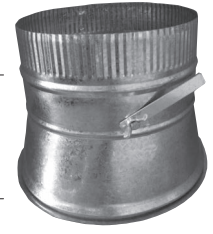
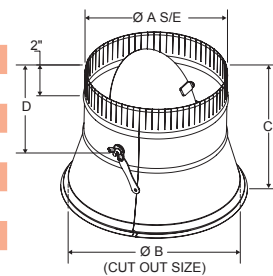

ITEM #	SIZE (")	A (")	B (")	C (")	D (")	GA	CTN/QTY	WT/100
502554	14	13-15/16	15-7/8	13	6-1/2	26	*	530
502556	16	15-15/16	17-7/8	14-3/4	7-1/2	26	*	640
502558	18	17-7/8	19-7/8	16-3/4	8-1/2	26	*	760
502560	20	19-7/8	21-7/8	18-3/4	9-1/2	24	*	980

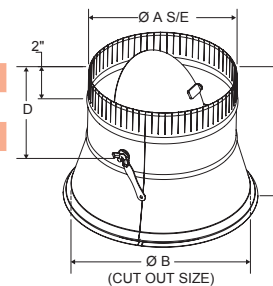

NOTE: Sizes 14" through 20" include a 3/8" continuous rod damper.

*Product shipped individually.

CONICAL SPIN-IN COLLARS

ITEM #	SIZE (")	A (")	B (")	GA	CTN/QTY	WT/100
502525	5	5	7	26	40	95
502526	6	6	8	26	30	105
502527	7	7	9	26	20	120
502528	8	8	10	26	20	130
502529	9	9	12	26	10	145
502530	10	10	12	26	10	160
502532	12	12	13-15/16	26	10	205
502534	14	13-15/16	15-7/8	26	*	235
502536	16	15-15/16	17-7/8	26	*	265
502538	18	17-7/8	19-7/8	26	*	307
502540	20	19-7/8	21-7/8	24	*	460

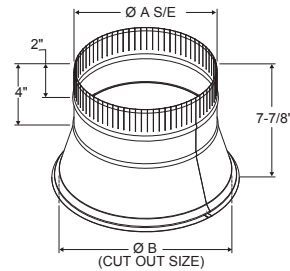

*Product shipped individually.

CONICAL STANDOFFS — WITH 3/8" ROD DAMPER

ITEM #	SIZE (")	A (")	B (")	C (")	D (")	GA	CTN/QTY	WT/100
502565	5	5	7	10-3/4	6	26	20	195
502566	6	6	8	10-3/4	6	26	20	225
502567	7	7	9	10-3/4	6	26	10	253
502568	8	8	10	10-3/4	6	26	10	280
502569	9	9	12	10-3/4	6	26	10	313
502570	10	10	12	10-3/4	6	26	10	340
502572	12	12	13-15/16	11	6	26	5	393
502574	14	13-15/16	15-7/8	13	6-1/2	26	4	490
502576	16	15-15/16	17-7/8	15	7-1/2	26	*	630
502578	18	17-7/8	19-7/8	17	8-1/2	26	*	768

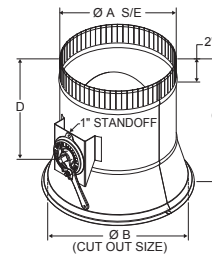

*Product shipped individually.

SLEEVES WITH DUAL STEM DAMPERS

ITEM #	SIZE (")	A (")	GA	CTN/QTY	WT/100
596024	4	4	28	20	73
596025	5	5	28	20	75
596026	6	6	28	20	104
596027	7	7	28	10	146
596028	8	8	28	10	172
596030	10	10	28	10	255
596032	12	12	28	5	364

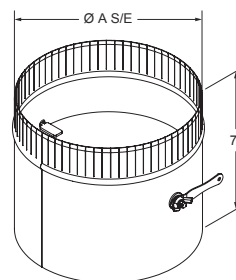

— E.&O.E. — Subject to Change Without Notice — May Not Be Available At All Locations —

SLEEVES WITH DAMPERS (KS-145 REGULATOR)

ITEM #	SIZE (")	A (")	GA	CTN/QTY	WT/100
596004	4	4	26	50	73
596005	5	5	26	50	75
596006	6	6	26	50	104
596007	7	7	26	30	146
596008	8	8	26	30	172
596010	10	10	26	16	255
596012	12	12	26	8	364

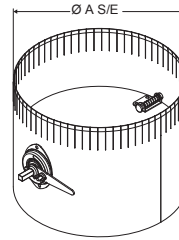

DUCTBOARD SPIN-IN

ITEM #	SIZE (")	A (")	CTN/QTY	WT/100
502646	6	6	*	90
502647	7	7	*	100
502648	8	8	*	110
502649	9	9	*	125
502650	10	10	*	140
502652	12	12	*	170
502654	14	14	*	190
502656	16	16	*	210

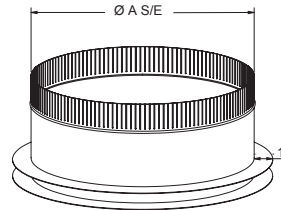

*Product shipped individually.

DUCTBOARD SPIN-IN WITH DAMPER

ITEM #	SIZE (")	A (")	CTN/QTY	WT/100
502626	6	6	*	110
502628	8	8	*	150
502630	10	10	*	240
502632	12	12	*	300
502634	14	14	*	360
502636	16	16	*	520
502638	18	18	*	580

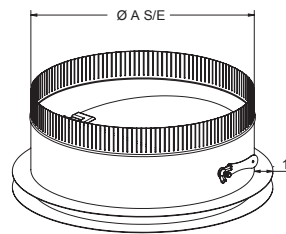

*Product shipped individually.

ECCO-SEAL — FLAT

ITEM #	SIZE (")	A (")	B (")	GA	CTN/QTY	WT/100
504004	4	4	7	26	20	55
504005	5	5	8	26	20	67
504006	6	6	9	26	20	80
504007	7	7	10	26	20	92
504008	8	8	11	26	20	104
504009	9	9	12	26	20	116
504010	10	10	13	26	20	129
504012	12	12	15	26	10	153
504014	14	13-15/16	17	26	10	177
504016	16	15-15/16	19	26	10	202
504018	18	17-7/8	21	26	10	226
504020	20	19-7/8	23	24	5	314

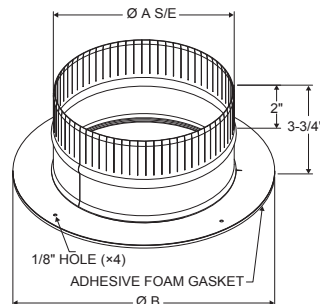

-E.&O.E. - Subject to Change Without Notice - May Not Be Available At All Locations -

ECCO-SEAL — FLAT WITH DAMPER

ITEM #	SIZE (")	A (")	B (")	C (")	D (")	GA	CTN/QTY	WT/100
504034	4	4	7	6	3-1/4	26	20	98
504035	5	5	8	6	3-1/4	26	25	121
504036	6	6	9	6	3-1/4	26	20	143
504037	7	7	10	6	3-1/4	26	20	166
504038	8	8	11	7	3-3/4	26	20	208
504039	9	9	12	8	4-1/4	26	10	258
504040	10	10	13	9	4-3/4	26	10	307
504042	12	12	15	11	5-3/4	26	4	447

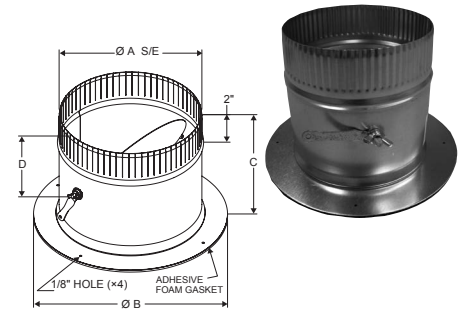

ITEM #	SIZE (")	A (")	B (")	C (")	D (")	GA	CTN/QTY	WT/100
504044	14	13-15/16	17	13	6-1/2	26	*	573
504046	16	15-15/16	19	15	7-1/2	26	*	729
504048	18	17-7/8	21	17	8-1/2	26	*	896
504050	20	19-7/8	23	19	9-1/2	24	*	1395

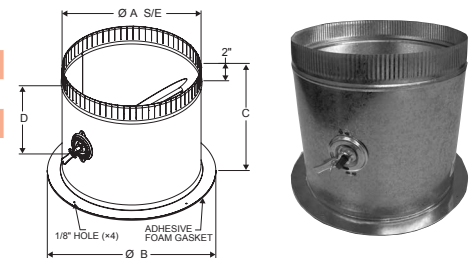

NOTE: Sizes 14" through 20" include a 3/8" continuous rod damper.

*Product shipped individually.

ECCO-SEAL — RADIUS

ITEM #	SIZE (")	A (")	B (")	TO FIT PIPE DIAMETER	GA	CTN/QTY	WT/100
504054	4	4	8	8, 10, 12, 14, 16	26	30	68
504055	5	5	9	8, 10, 12, 14	26	20	84
504056	6	6	10	10, 12, 14	26	20	101
504057	7	7	11	12, 14	26	20	119
504058	8	8	12	12, 14	26	20	140
504059	9	9	13	14, 16	26	10	158
504060	10	10	14	14, 16	26	10	182
504062	12	12	18	14, 16	26	5	237
504064	14	13-15/16	20	16, 18	26	*	290
504066	16	15-15/16	22	18, 20	26	*	347

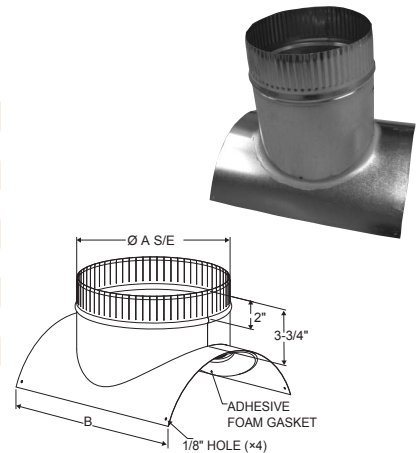

*Product shipped individually.

ECCO-SEAL — RADIUS WITH DAMPER

ITEM #	SIZE (")	A (")	B (")	C (")	D (")	TO FIT PIPE DIAMETER	GA	CTN/QTY	WT/100
504074	4	4	6	3	8	8, 10, 12, 14, 16	26	20	110
504075	5	5	6	3	9	8, 10, 12, 14	26	20	137
504076	6	6	6	3	10	10, 12, 14	26	20	164
504077	7	7	6	3	11	12, 14	26	10	193
504078	8	8	7	3-1/2	12	12, 14	26	10	243
504079	9	9	8	4	13	14, 16	26	8	299
504080	10	10	9	4-1/2	14	14, 16	26	6	358
504082	12	12	11	5-1/2	18	14, 16	26	3	530
504084	14	13-15/16	13	6-1/2	20	16, 18	26	2	694
504086	16	15-15/16	15	7-1/2	22	18, 20	26	*	901

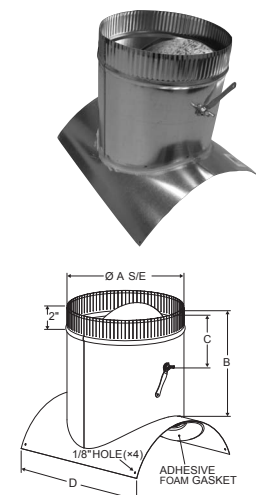

*Product shipped individually.

- E.&O.E. - Subject to Change Without Notice - May Not Be Available At All Locations -

ECCO-SEAL — CONICAL

ITEM #	SIZE (")	A (")	B (")	C (")	GA	CTN/QTY	WT/100
504094	4	4	6	9	26	20	152
504095	5	5	7	10	26	20	167
504096	6	6	8	11	26	20	182
504097	7	7	9	12	26	20	197
504098	8	8	10	13	26	10	212
504099	9	9	12	15	26	10	227
504100	10	10	12	15	26	10	242
504102	12	12	14	17	26	5	272
504104	14	13-15/16	16	19	26	5	302
504106	16	15-15/16	18	21	26	*	332

*Product shipped individually.

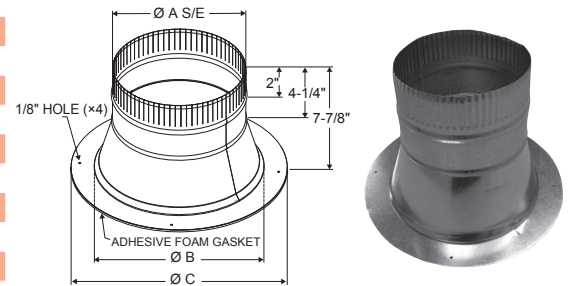

ECCO-SEAL — CONICAL WITH DAMPER

ITEM #	SIZE (")	A (")	B (")	C (")	D (")	E (")	GA	CTN/QTY	WT/100
504114	4	4	6	7-7/8	3-1/8	9	26	20	169
504115	5	5	7	7-7/8	3-1/8	10	26	20	189
504116	6	6	8	7-7/8	3-1/8	11	26	20	209
504117	7	7	9	7-7/8	3-1/8	12	26	20	220
504118	8	8	10	7-7/8	3-1/8	13	26	10	237
504119	9	9	12	8-3/8	3-7/8	15	26	10	290
504120	10	10	12	8-3/8	3-7/8	15	26	10	350
504122	12	12	14	10-3/8	4-7/8	17	26	5	472
504124	14	13-15/16	16	13	6-1/2	19	26	*	586
504126	16	15-15/16	18	14-3/4	7-1/2	21	26	*	698

*Product shipped individually.

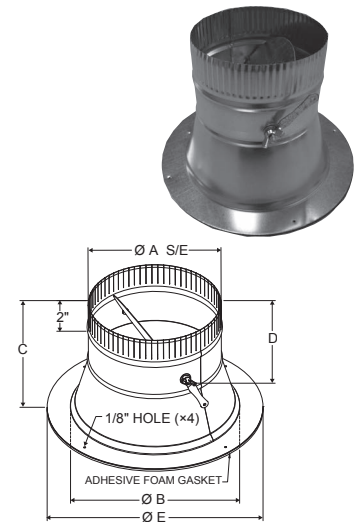

ECCO-SEAL — CONICAL WITH STANDOFF DAMPER

ITEM #	SIZE (")	A (")	B (")	C (")	D (")	E (")	GA	CTN/QTY	WT/100
504145	5	5	7	10-3/4	6	10	26	10	205
504146	6	6	8	10-3/4	6	11	26	10	243
504147	7	7	9	10-3/4	6	12	26	10	280
504148	8	8	10	10-3/4	6	13	26	10	320
504149	9	9	12	10-3/4	6	15	26	6	372
504150	10	10	12	10-3/4	6	15	26	6	403
504152	12	12	14	11	6	17	26	4	506
504154	14	13-15/16	16	13	6-1/2	19	26	*	638
504156	16	15-15/16	18	15	7-1/2	21	26	*	813
504158	18	17-7/8	20	17	8-1/2	23	26	*	1002

*Product shipped individually.

NOTE: The damper includes a 3/8" continuous rod damper.

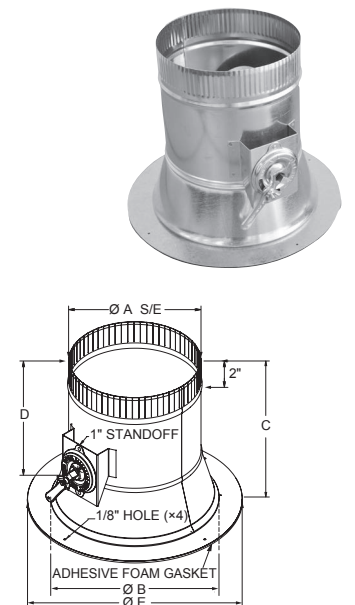

ECCO-SEAL — HIGH EFFICIENCY TAKE OFF

ITEM #	SIZE (")	A (")	B (")	C (")	GA	CTN/QTY	WT/100
504164	4	4	4	6	24	20	97
504165	5	5	5	7	24	20	122
504166	6	6	6	8	24	20	168
504167	7	7	7	9	24	10	180
504168	8	8	8	10	24	10	250
504169	9	9	9	11	24	6	328
504170	10	10	10	12	24	6	359
504172	12	12	12	14	24	4	417
504174	14	14	14	16	24	*	599
504176	16	16	16	19	24	*	816

*Product shipped individually.

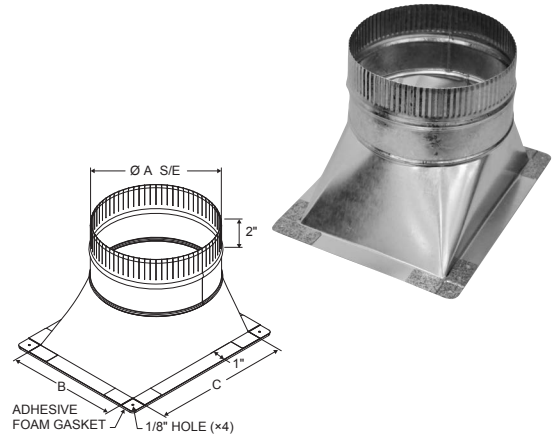

ECCO-SEAL — HIGH EFFICIENCY TAKE OFF WITH DAMPER

ITEM #	SIZE (")	A (")	B (")	C (")	D (")	GA	CTN/QTY	WT/100
504184	4	4	4	6	3-1/8	24	20	135
504185	5	5	5	7	3-1/8	24	20	163
504186	6	6	6	8	3-1/8	24	20	201
504187	7	7	7	9	3-1/8	24	10	231
504188	8	8	8	10	3-1/8	24	10	269
504189	9	9	9	11	3-7/8	24	6	341
504190	10	10	10	12	3-7/8	24	6	412
504192	12	12	12	14	4-7/8	24	4	549

504194	14	14	14	16	6-1/2	24	*	977
504196	16	16	16	19	7-1/2	24	*	1395

*Product shipped individually.

NOTE: Sizes 14" through 16" include a 3/8" continuous rod damper.

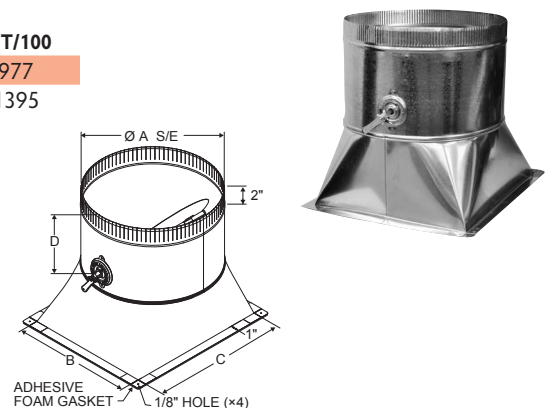
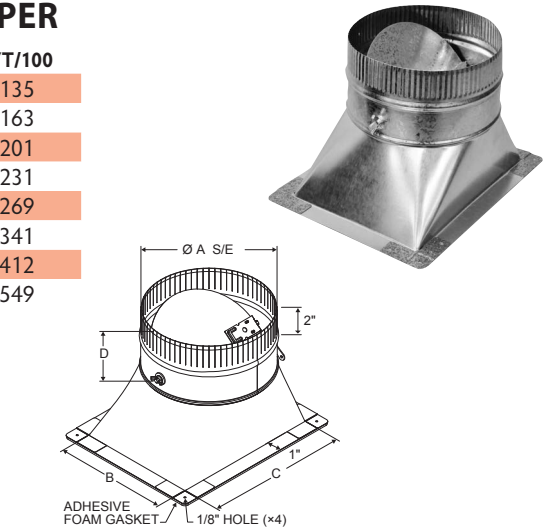

DRAIN PANS — SPUN ROUND — 1" HIGH — BOTTOM MOUNT — 1-1/2" TAIL PIECE INCLUDED

ITEM #	SIZE (")	A (")	CTN/QTY	WT/100
138800	22	21-7/8	12	250
138900	24	23-7/8	10	300
139000	26	25-7/8	6	350
139002	31	30-1/2	*	770

*Product shipped individually.

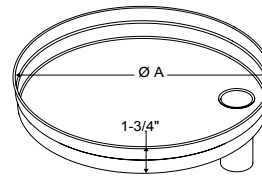

DRAIN PANS — SPUN ROUND — 1" HIGH — BOTTOM HOLE ONLY

ITEM #	SIZE (")	A (")	CTN/QTY	WT/100
138801	22	21-7/8	*	230
138901	24	23-7/8	*	320
139001	26	25-7/8	*	350
138790	20	19-7/8	*	305
139024	28	27-7/8	*	567
139005	31	30-1/2	*	664

*Product shipped individually.

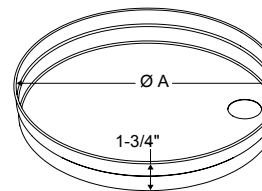

DRAIN PANS — SPUN ROUND — 2" HIGH — SIDE STUB

ITEM #	SIZE (")	A (")	CTN/QTY	WT/100
138821	22	21-1/2	*	425
138921	24	23-3/4	*	493
139003	26	25-1/2	*	703
139025	28	27-1/2	*	646
139004	31	30-1/2	*	815

*Product shipped individually.

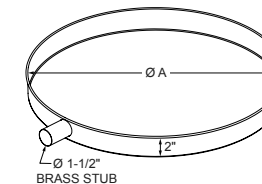

DRAIN PANS — SPUN ROUND — 2" HIGH — SIDE HOLE ONLY

ITEM #	SIZE (")	A (")	CTN/QTY	WT/100
138822	22	21-1/2	*	425
138922	24	23-3/4	*	493
139021	26	25-1/2	*	566
139026	28	27-1/2	*	646
139007	31	30-1/2	*	815

*Product shipped individually.

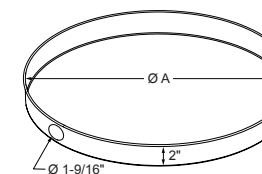

DRAIN PANS — SPUN ROUND — 2" HIGH — BOTTOM HOLE ONLY

ITEM #	SIZE (")	A (")	B (")	CTN/QTY	WT/100
138820	22	21-1/2	2	*	426
138920	24	23-3/4	2	*	494
139022	26	25-1/2	2	*	703
139027	27 - 28	27 - 28	2	*	646

*Product shipped individually.

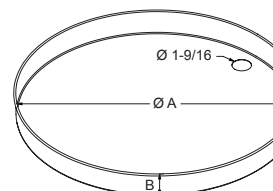

DRAIN PANS — SPUN ROUND — 2" HIGH — C/W PVC FITTING

ITEM #	SIZE (")	A (")	CTN/QTY	WT/100
138791	20	19-1/2	*	305
138823	22	21-1/2	*	425
138830	24	23-3/4	*	600
138930	26	25-1/2	*	703
138998	28	27-1/2	*	441
138999	31	30-1/2	*	527

*Product shipped individually.

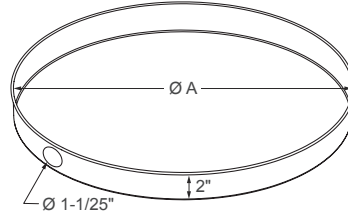

DRAIN PANS — 2" HIGH — C/W PVC FITTING

ITEM #	SIZE (")	CTN/QTY	WT/100
139045	25 x 39	*	807

*Product shipped individually.

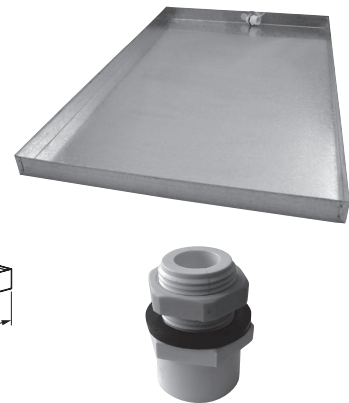
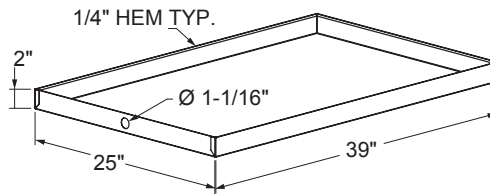

PVC FITTING

ITEM #	DESCRIPTION	DIA (")	CTN/QTY	WT/100
798106	PVC Drain Pan Fitting	1-1/50	*	5

*Product shipped individually.



DRAIN PANS — SQUARE — 2" HIGH — 1-1/2" TAIL PIECE INCLUDED

BOTTOM STUB

ITEM #	SIZE (")	A (")	CTN/QTY	WT/100
138902	24 × 24	24	*	700
138923	26 × 26	26	*	703

*Product shipped individually.

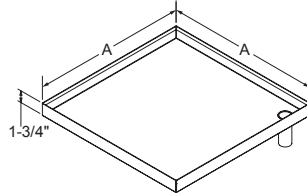

SIDE STUB — LEFT

ITEM #	SIZE (")	A (")	CTN/QTY	WT/100
138903	24 × 24	24	*	700
138924	26 × 26	26	*	703

*Product shipped individually.

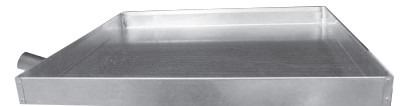
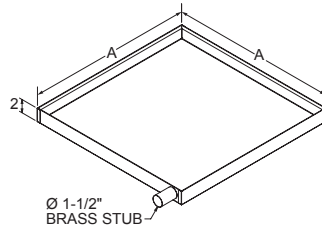

SIDE STUB — RIGHT

ITEM #	SIZE (")	A (")	CTN/QTY	WT/100
138905	24 × 24	24	*	700
138925	26 × 26	26	*	703

*Product shipped individually.

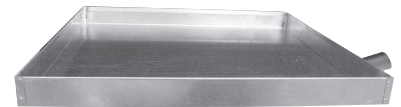
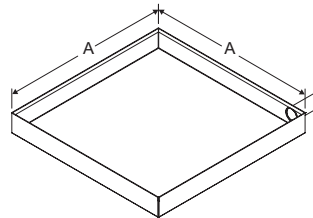

DRAIN PANS — SQUARE — 2" HIGH NO HOLE

ITEM #	SIZE (")	A (")	CTN/QTY	WT/100
138904	24	24	*	425
138997	26	26	*	567

*Product shipped individually.

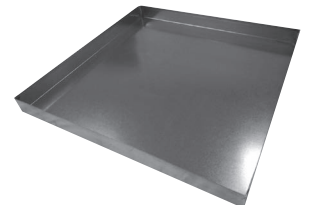
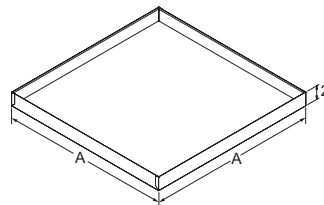

BOTTOM HOLE ONLY

ITEM #	SIZE (")	A (")	CTN/QTY	WT/100
138996	26	26	*	567

*Product shipped individually.

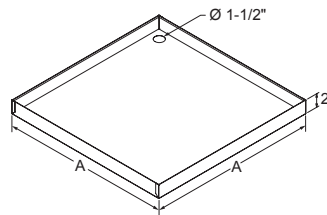

DRAIN PAN WITH OPENING

ITEM #	SIZE (")	A (")	B (")	OPENING		GA	CTN/QTY	WT/100
				C (")	D (")			
139040	25 × 30	25	30	21	20	26	*	475

*Product shipped individually.

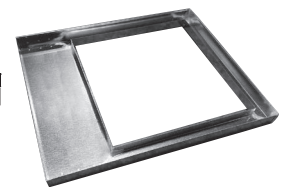
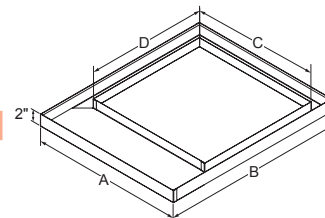

DRAIN PAN — EQUIPMENT

ITEM #	SIZE (")	A (")	B (")	GA	CTN/QTY	WT/100
139030	30 × 63	30	63	26	*	1495

*Product shipped individually.

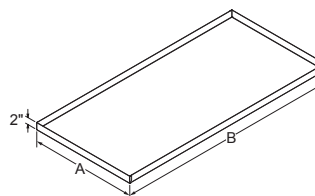

— E.&O.E. — Subject to Change Without Notice — May Not Be Available At All Locations —

BRASS TAIL PIECE — ONLY

ITEM #	SIZE (")	A (")	CTN/QTY	WT/100
798100	1-1/2 × 2-5/8	1-1/2	25	12

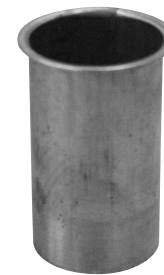
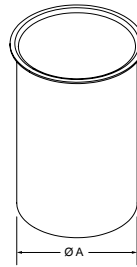

WATER TANK STANDS

ITEM #	SIZE (")	A (")	CTN/QTY	WT/100
139010	24	23-7/8	*	1600
139012	26	25-7/8	*	1800

*Product shipped individually.

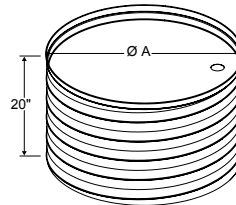

NPT PIPE NIPPLE CADDY

ITEM #	SIZE (")	CTN/QTY	WT/100
139301	1/2"	4	500
139303	3/4"	3	555
139305	1"	3	650

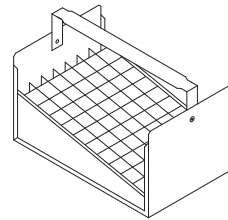

STRANKO BOXES

ITEM #	DESCRIPTION	A (")	CTN/QTY	WT/100
139309	9" Round	9	10	204

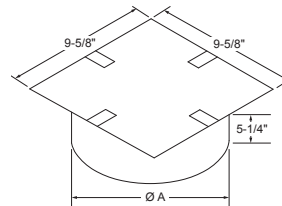

RANGE HOOD TRANSITIONS (ADAPTERS)

ITEM #	SIZE (")	A (")	B (")	C (")	D (")	E (")	CTN/QTY	WT/100
138400	4 – 3-1/4 × 10	4	3-1/4	10	6-3/8	3	40	70
138500	5 – 3-1/4 × 10	5	3-1/4	10	5-3/8	2-1/2	50	75
138600	6 – 3-1/4 × 10	6	3-1/4	10	6-1/4	3	30	90
138700	7 – 3-1/4 × 10	7	3-1/4	10	5-1/2	2-1/2	30	100
138750	8 – 3-1/4 × 10	8	3-1/4	10	7-1/2	2-1/2	20	115

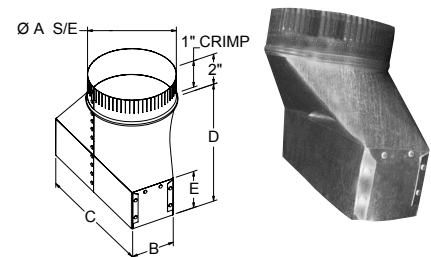

THIMBLES — WALL

ITEM #	SIZE (")	A (")	CTN/QTY	WT/100
137294	4	4-3/4	10	365

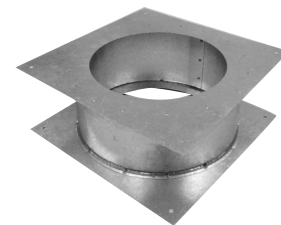
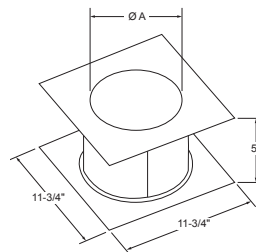

– E.&O.E. – Subject to Change Without Notice – May Not Be Available At All Locations –

THIMBLES

ITEM #	SIZE (")	A (")	CTN/QTY	WT/100
137400	4	5-1/8	10	50
137500	5	6-1/8	10	60
137600	6	7-1/8	10	80
137800	8	9-1/8	6	100

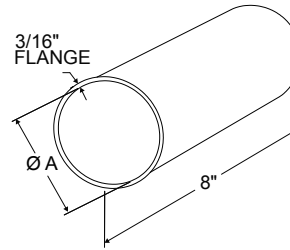

NAILING STRIPS

ITEM #	SIZE (")	A (")	GA	PCS/BNDL	WT/100
150025	18	18	16	20	63
150026	24	24	16	20	84
150028	18	18	18	20	51
150029	24	24 <td 18	20	68	

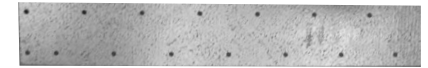
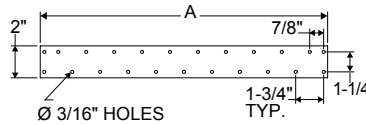

COMBUSTION AIR POTS

ITEM #	SIZE (")	A (")	B (")	CTN/QTY	WT/100
139204	4	4	7	9	263
139205	5	5	8	8	315
139206	6	6	9	5	376
139207	7	7	10	4	423
139208	8	8	11	3	490

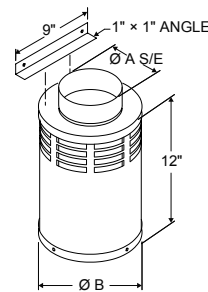

LINT TRAPS — 180° NO FLANGE

ITEM #	SIZE (")	A (")	CTN/QTY	WT/100
599700	4 - 5	5	15	240
599701	4 - 4	4	15	235

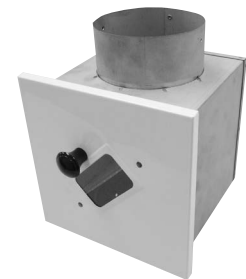
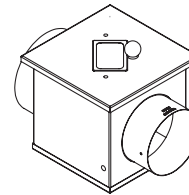
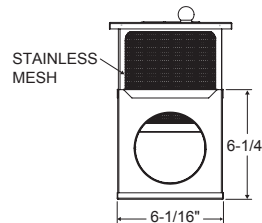
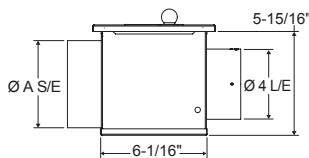
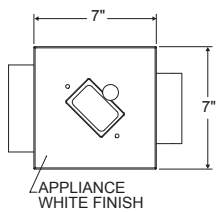

LINT TRAPS — 180° WITH FLANGE

ITEM #	SIZE (")	CTN/QTY	WT/100
599703	4 - 4	1	235

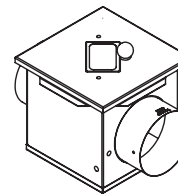
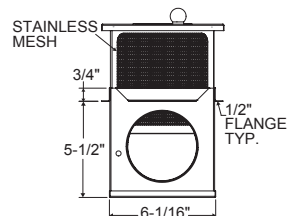
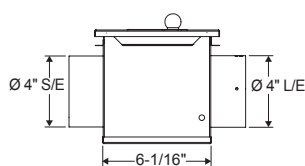
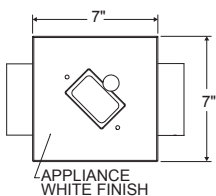

- E.&O.E. - Subject to Change Without Notice - May Not Be Available At All Locations -

LINT TRAPS — SLIM LINE (PATENTED)

ITEM #	SIZE (")	A (")	B (")	CTN/QTY	WT/100
599704	4 - 5 × 28-1/2	28 - 1/2	5	2	600
599706	4 - 5 × 30-1/2	30 - 1/2	5	2	610
599707	4 - 4 × 30-1/2	30 - 1/2	4	2	610

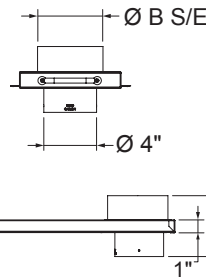
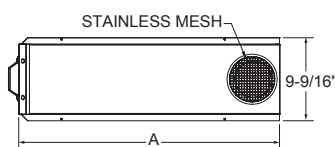

REGISTER BOX WITH SCREEN

ITEM #	SIZE (")	A (")	B (")	C (")	D (")	CTN/QTY	WT/100
562906	6 × 6 × 6	6	6-1/4	6	10 - 1/2	*	270
562908	8 × 8 × 8	8	8-1/4	8	12 - 1/2	*	410
562910	10 × 10 × 10	10	10-1/4	10	14 - 1/2	*	570
562912	12 × 12 × 12	12	12-1/4	12	16 - 1/2	*	770
562914	14 × 14 × 14	14	14-1/4	13-15/16	18 - 1/2	*	1000
562916	16 × 16 × 16	16	16-1/4	15-15/16	20 - 1/2	*	1250

*Product shipped individually.

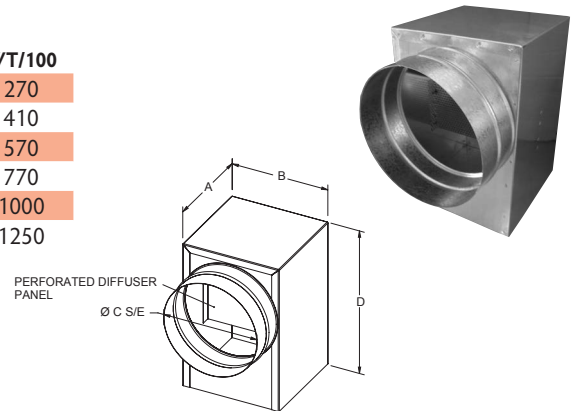

REGISTER BOX WITH 1" FLANGE

ITEM #	SIZE (")	A (")	B (")	C (")	D (")	CTN/QTY	WT/100
562918	8 × 8 × 6	8	8	6	10-1/2	*	377
562920	10 × 10 × 8	10	10	8	12-1/2	*	535

*Product shipped individually.

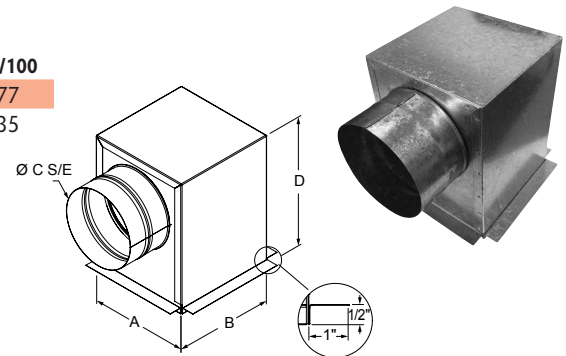

SQUARE TO ROUND ADAPTERS

ITEM #	SIZE (")	A (")	B (")	C (")	GA	CTN/QTY	WT/100
563010	6 × 6-6	6	6	6	26	*	90
563016	8 × 8-6	8	8	6	26	*	100
563020	8 × 8-8	8	8	8	26	*	110
563027	9 × 9-8	9	9	8	26	*	120
563030	9 × 9-9	9	9	9	26	*	125
563039	10 × 10-8	10	10	8	26	*	140
563040	10 × 10-10	10	10	10	26	*	150
563056	12 × 12-6	12	12	6	26	*	180
563058	12 × 12-8	12	12	8	26	*	185
563059	12 × 12-10	12	12	10	26	*	175
563060	12 × 12-12	12	12	12	26	*	170
563079	14 × 14-12	14	14	12	26	*	230

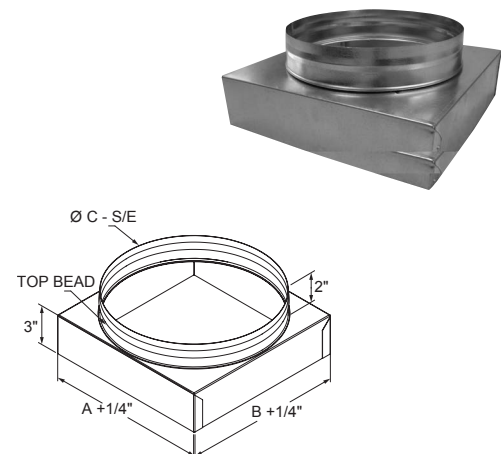

(cont'd on next page)

-E.&O.E. - Subject to Change Without Notice - May Not Be Available At All Locations -

SQUARE TO ROUND ADAPTERS (cont'd)

ITEM #	SIZE (")	A (")	B (")	C (")	GA	CTN/QTY	WT/100
563080	14 x 14-14	14	14	14	26	*	230
563090	15 x 15-14	15	15	14	26	*	240
563099	16 x 16-14	16	16	14	26	*	260
563100	16 x 16-16	16	16	16	26	*	260
563119	18 x 18-16	18	18	16	26	*	330
563120	18 x 18-18	18	18	18	26	*	330
563139	20 x 20-18	20	20	18	26	*	360
563140	20 x 20-20	20	20	20	26	*	360
563157	22 x 10-6	22	10	6	26	*	190
563159	22 x 10-8	22	10	8	26	*	200
563160	22 x 10-10	22	10	10	26	*	210
563184	22 x 22-12	22	22	12	26	*	350
563185	22 x 22-14	22	22	14	26	*	350
563186	22 x 22-16	22	22	16	26	*	360
563187	22 x 22-18	22	22	18	26	*	370
563188	22 x 22-20	22	22	20	26	*	380

*Product shipped individually.

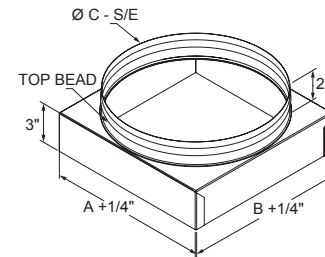

SQUARE TO ROUND ADAPTERS WITH 1\" FLANGE

ITEM #	SIZE (")	A (")	B (")	C (")	GA	CTN/QTY	WT/100
563008	6 x 6-5	6	6	5	26	*	123
563009	6 x 6-6	6	6	6	26	*	183
563015	8 x 8-6	8	8	6	26	*	234
563018	8 x 8-7	8	8	7	26	*	166
563019	8 x 8-8	8	8	8	26	*	154
563036	10 x 10-6	10	10	6	26	*	212
563037	10 x 10-7	10	10	7	26	*	217
563038	10 x 10-8	10	10	8	26	*	221
563041	10 x 10-10	10	10	10	26	*	195
563057	12 x 12-8	12	12	8	26	*	344
563063	12 x 12-9	12	12	9	26	*	180
563061	12 x 12-12	12	12	12	26	*	398
563062	12 x 12-10	12	12	10	26	*	375
563068	14 x 14-10	14	14	10	26	*	412
563078	14 x 14-12	14	14	12	26	*	422
563084	14 x 14-14	14	14	14	26	*	306
563096	16 x 16-12	16	16	12	26	*	485
563098	16 x 16-14	16	16	14	26	*	260
563103	16 x 16-16	16	16	16	26	*	351
563133	20 x 20-18	20	20	18	26	*	440

*Product shipped individually.

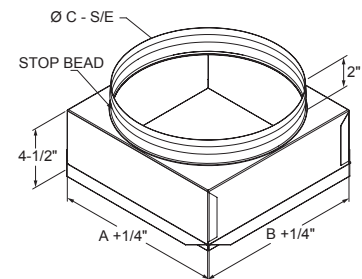

EC RETURN AIR CANS

ITEM #	SIZE (")	A (")	B (")	GA	CTN/QTY	WT/100
563000	11-3/4 x 23-3/4	11-3/4	23-3/4	26	*	308
563002	23-3/4 x 23-3/4	23-3/4	23-3/4	26	*	526

*Product shipped individually.

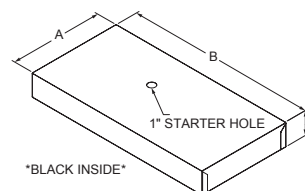

BLACK INSIDE

- E.&O.E. - Subject to Change Without Notice - May Not Be Available At All Locations -

RETURN AIR CANS

ITEM #	SIZE (")	A (")	B (")	C (")	CTN/QTY	WT/100
562830	14-1/4 x 20-1/4	14-1/4	20-1/4	10	6	340
562832	14-1/4 x 20-1/4	14-1/4	20-1/4	12	6	360
562834	14-1/4 x 20-1/4	14-1/4	20-1/4	14	6	370
562858	14-1/4 x 24-1/4	14-1/4	24-1/4	14	6	430
562859	14-1/4 x 24-1/4	14-1/4	24-1/4	16	6	500
562862	14-1/4 x 25-1/4	14-1/4	25-1/4	12	6	420
562864	14-1/4 x 25-1/4	14-1/4	25-1/4	14	6	440
562866	14-1/4 x 25-1/4	14-1/4	25-1/4	16	6	460
562844	16-1/4 x 20-1/4	16-1/4	20-1/4	14	6	400
562846	16-1/4 x 20-1/4	16-1/4	20-1/4	16	6	410
562872	16-1/4 x 25-1/4	16-1/4	25-1/4	12	6	440
562874	16-1/4 x 25-1/4	16-1/4	25-1/4	14	6	450
562876	16-1/4 x 25-1/4	16-1/4	25-1/4	16	6	460
562848	20-1/4 x 20-1/4	20-1/4	20-1/4	12	6	440
562854	20-1/4 x 20-1/4	20-1/4	20-1/4	14	6	450
562856	20-1/4 x 20-1/4	20-1/4	20-1/4	16	6	430
562857	20-1/4 x 20-1/4	20-1/4	20-1/4	18	6	450
562860	20-1/4 x 24-1/4	20-1/4	24-1/4	16	6	520
562861	20-1/4 x 24-1/4	20-1/4	24-1/4	18	6	540
562884	20-1/4 x 25-1/4	20-1/4	25-1/4	14	6	490
562886	20-1/4 x 25-1/4	20-1/4	25-1/4	16	6	540
562887	20-1/4 x 25-1/4	20-1/4	25-1/4	18	6	550
562896	20-1/4 x 30-1/4	20-1/4	30-1/4	16	6	590
562898	20-1/4 x 30-1/4	20-1/4	30-1/4	18	6	690

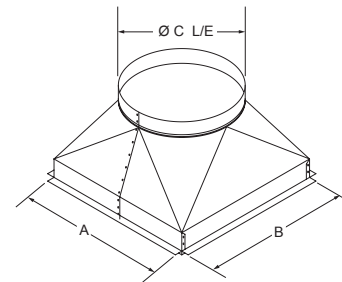

DIFFUSER CANS

ITEM #	SIZE (")	A (")	B (")	CTN/QTY	WT/100
566006	6 x 6	6	6	*	145
566008	8 x 8	8	8	*	206
566009	9 x 9	9	9	*	238
566010	10 x 10	10	10	*	273
566012	12 x 12	12	12	*	347
566014	14 x 14	14	14	*	427
566015	15 x 15	15	15	*	470
566016	16 x 16	16	16	*	514
566018	18 x 18	18	18	*	607
566020	20 x 14	20	14	*	495
566022	20 x 16	20	16	*	565
566024	20-1/4 x 20-1/4	20-1/4	20-1/4	*	719
566028	21-3/4 x 21-3/4	21-3/4	21-3/4	*	799
566030	22 x 10	22	10	*	369
566042	24 x 12	24	12	*	462
566044	24 x 24	24	24	*	925
566054	25 x 14	25	14	*	551
566056	25 x 16	25	16	*	629
566058	25 x 20	25	20	*	787

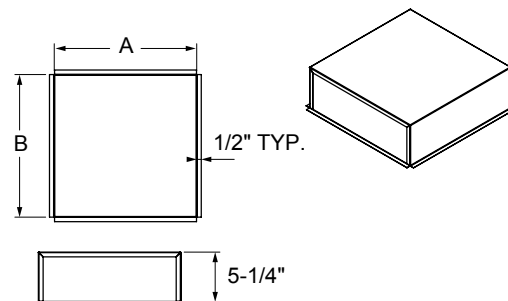
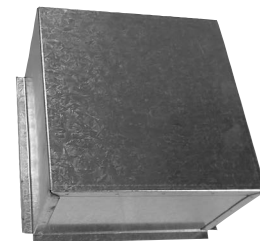

*Product shipped individually.

- E.&O.E. - Subject to Change Without Notice - May Not Be Available At All Locations -

B-BOXES

ITEM #	SIZE (")	A (")	B (")	C (")	CTN/QTY	WT/100
562941	6 x 6-4	6	6	4	12	270
562942	6 x 6-5	6	6	5	12	270
562943	6 x 6-6	6	6	6	12	270
562946	7 x 7-7	7	7	7	12	150
562949	8 x 6-5	8	6	5	12	350
562953	8 x 8-6	8	8	6	12	410
562954	8 x 8-7	8	8	7	12	410
562955	8 x 8-8	8	8	8	12	410
562958	9 x 9-8	9	9	8	12	180
562963	10 x 10-6	10	10	6	12	570
562965	10 x 10-8	10	10	8	12	570
562966	10 x 10-10	10	10	10	12	570
562973	12 x 12-6	12	12	6	12	770
562975	12 x 12-8	12	12	8	12	770
562977	12 x 12-10	12	12	10	12	770
562978	12 x 12-12	12	12	12	12	770
562983	14 x 14-10	14	14	10	6	1000
562984	14 x 14-12	14	14	12	6	1000
562985	14 x 14-14	14	14	14	6	1000
562994	16 x 16-12	16	16	12	*	1250
562995	16 x 16-14	16	16	14	*	1250
562996	16 x 16-16	16	16	16	*	1250

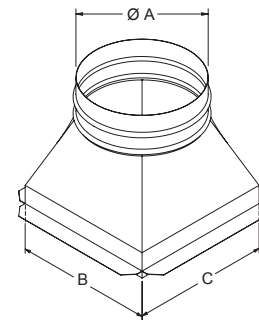

*Product shipped individually.

RETURN AIR SUPPORT BOX

ITEM #	SIZE (")	A (")	B (")	C (")	D (")	E (")	CTN/QTY	WT/100
010294	30 x 28 x 10 - 24 x 8	30	28	10	24	8	*	2800
010290	34 x 28 x 12 - 24 x 10	34	28	12	24	10	*	3250
010296	38 x 28 x 10 - 25 x 12	38	28	10	25	12	*	3400

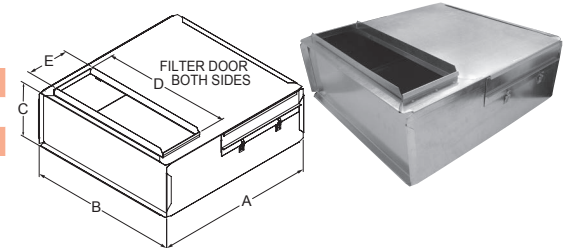

*Product shipped individually.

RETURN AIR SUPPORT BOX — NO DOOR

ITEM #	SIZE (")	A (")	B (")	C (")	D (")	E (")	CTN/QTY	WT/100
010298	38 x 26 x 10 - 24 x 8	38	26	10	24	8	*	3300

*Product shipped individually.

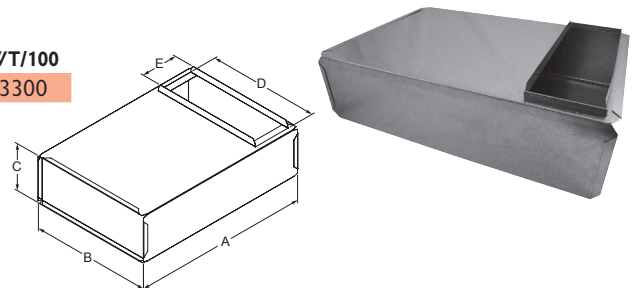

KICKBOARD BOXES

ITEM #	DESCRIPTION	A (")	B (")	C (")	CTN/QTY	WT/100
050724	2-1/4 x 12 No Hole	-	2-1/4	12	20	120
050725	5" - 2-1/4" x 12"	5	2-1/4	12	30	140
050726	5" - 3-1/4" x 10" with End Cap	5	3-1/4	10	20	140

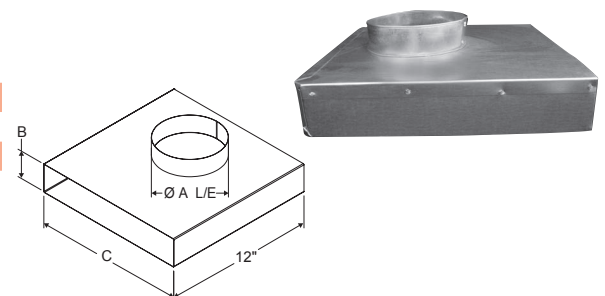

- E.&O.E. - Subject to Change Without Notice - May Not Be Available At All Locations -

FRESH AIR GRILLES — GALVANIZED

ITEM #	DESCRIPTION	A (")	PCS/BNDL	WT/100
138200	5" x 5"	5	*	25
702200	6" x 6" White	6	*	55
138210	7" x 7"	7	*	28
138212	7" x 7" White	7	*	28

*Product shipped individually.

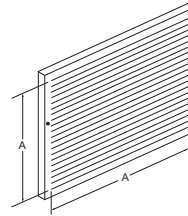

FRESH AIR INTAKES — 1/4" BIRDSCREEN

ITEM #	SIZE (")	A (")	B (")	C (")	D (")	E (")	CTN/QTY	WT/100
050775	3	3	9	6-3/4	6-5/16	1/4	20	85
050800	4	4	9	6-3/4	6-5/16	1/4	20	105
050900	5	5	9	8-5/8	7-11/16	1/4	20	140
051000	6	6	9	8-5/8	7-11/16	1/4	20	160
051050	7	7	9	9-7/8	9-1/8	1/4	10	200
051080	8	8	9	10-7/8	10-1/4	1/4	10	260
051090	10	10	9	13	12-1/4	1/4	5	480
051091	12	12	9-1/2	15	14-1/4	1/4	2	360

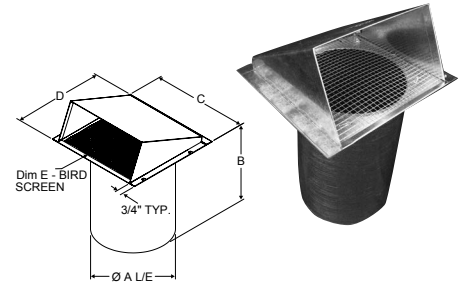

FRESH AIR INTAKES — 1/2" BIRDSCREEN

ITEM #	SIZE (")	A (")	B (")	C (")	D (")	E (")	CTN/QTY	WT/100
050764	4	4	9	6-3/4	6-5/16	1/2	20	105
050765	5	5	9	8-5/8	7-11/16	1/2	20	140
050766	6	6	9	8-5/8	7-11/16	1/2	20	160
050767	7	7	9	9-7/8	9-1/8	1/2	10	200

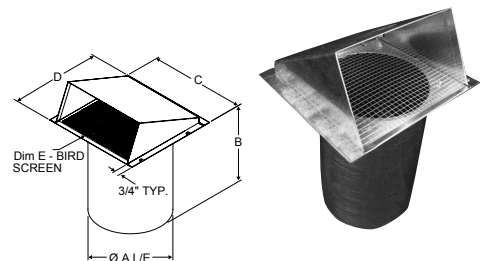

FRESH AIR INTAKES / WALL CAP COMBO — SOLDERED

ITEM #	SIZE (")	A (")	B (")	C (")	CTN/QTY	WT/100
051204	4	4	11-3/4	11-3/8	10	300
051205	5	5	11-3/4	11-3/8	20	310
051206	6	6	11-3/4	11-3/8	10	320
051207	7	7	13-1/2	13-1/2	10	390
051208	8	8	13-1/2	13-1/2	10	420

NOTE: All seams are fully soldered on hood.

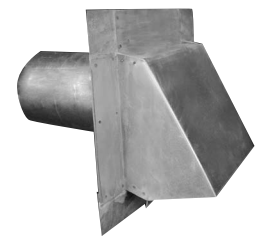
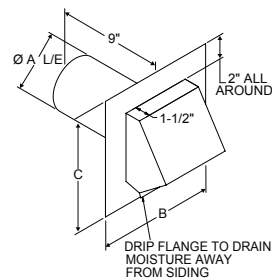

FRESH AIR SNORKELS

ITEM #	SIZE (")	A (")	CTN/QTY	WT/100
051214	4	4	*	445
051215	5	5	*	460
051216	6	6	*	475

*Product shipped individually.

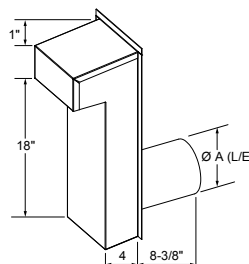

- E.&O.E. - Subject to Change Without Notice - May Not Be Available At All Locations -

WALL CAPS WITH SPRING LOADED DAMPER — GALVANIZED

ITEM #	SIZE (")	A (")	B (")	C (")	D (")	CTN/QTY	WT/100
051094	4	4	9	6-3/4	6-5/6	20	97
051095	5	5	9	8-5/8	7-11/16	20	135
051096	6	6	9	8-5/8	7-11/16	20	144
051097	7	7	9	9-7/8	9-1/8	10	168
051098	8	8	9	10-7/8	10-1/4	10	234
051099	10	10	9	13	12-1/4	5	422
051100	12	12	9-1/2	15	14-1/4	2	675

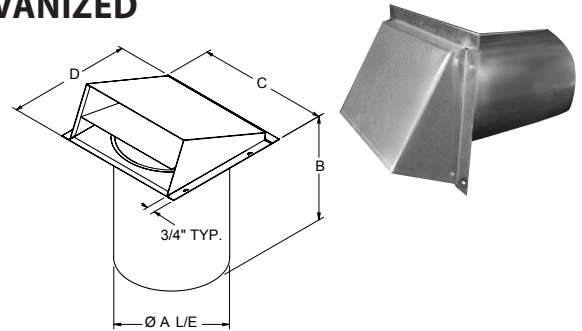

CHINA CAPS — GALVANIZED

ITEM #	SIZE (")	A (")	B (")	C (")	CTN/QTY	WT/100
134300	3	3	7-3/4	5-3/4	20	75
134400	4	4	7-3/4	6	20	85
134500	5	5	9	6	20	120
134600	6	6	10-1/4	6	20	145
134700	7	7	12-1/4	6	10	186
134800	8	8	12-1/4	6	10	190
134810	10	10	15-1/2	6	5	280
134812	12	12	17-3/4	6-1/2	5	300
134814	14	14	19-3/4	7	5	320

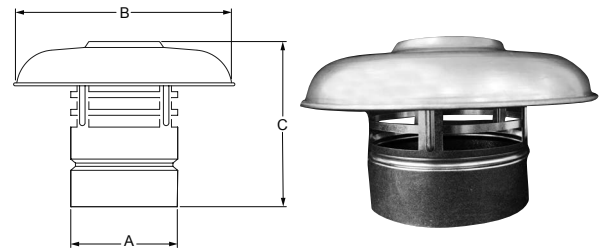

FLASHINGS — FLAT — PIPE SIZE — SOLDERED

ITEM #	SIZE (")	A (")	B (")	CTN/QTY	WT/100
131410	10	10-1/2	22	*	480
131415	12	12-1/2	24	*	520
131420	14	14-1/2	26	*	580

*Product shipped individually.

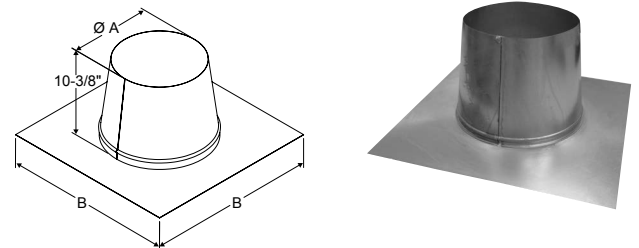

FLASHINGS — FLAT — HOT WELDED

ITEM #	MODEL	SIZE (")	A (")	B (")	C (")	D (")	CTN/QTY	WT/100
131362	4" Hot Weld Flat Flashing B-Vent	4	14	4-5/8	6	10	*	206
131364	5" Hot Weld Flat Flashing B-Vent	5	15	5-5/8	7	10	*	237
131366	6" Hot Weld Flat Flashing B-Vent	6	16	6-5/8	8	10	*	268
131368	7" Hot Weld Flat Flashing B-Vent	7	17	7-5/8	9	10	*	300
131370	8" Hot Weld Flat Flashing B-Vent	8	18	8-5/8	10	10	*	332

*Product shipped individually.

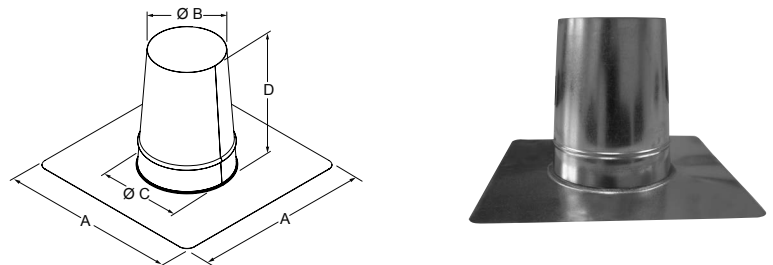

— E.&O.E. — Subject to Change Without Notice — May Not Be Available At All Locations —

FLASHINGS — FLAT — PIPE SIZE — HOT WELDED

ITEM #	DESCRIPTION	SIZE (")	A (")	B (")	C (")	CTN/QTY	WT/100
131382	10" H/W Flat Flashing Pipe Size	10	20	10-1/2	12	*	400
131383	12" H/W Flat Flashing Pipe Size	12	22	12-1/2	14	*	520

* Product shipped individually.

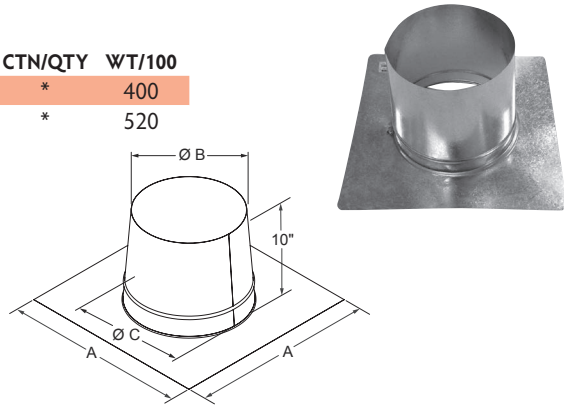

FLASHINGS — ADJUSTABLE — PIPE SIZE — 1/12-7/12 — SOLDERED

ITEM #	SIZE (")	A (")	B (")	CTN/QTY	WT/100
131409	10	10-1/2	24	*	480
131414	12	12-1/2	26	*	480
131419	14	14-1/2	28	*	490

*Product shipped individually.

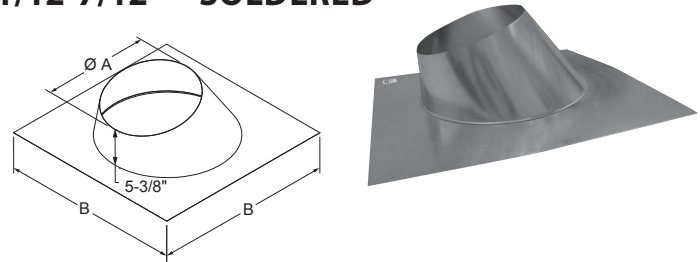

FLASHINGS — ADJUSTABLE — PIPE SIZE — 1/12-7/12

ITEM #	SIZE (")	A (")	B (")	C (")	D (")	CTN/QTY	WT/100
131503	3	3-1/4	7	4	15	*	160
131504	4	4-1/4	8	4	16	*	180
131505	5	5-1/4	9	4	1	*	200
131506	6	6-1/4	10	4	18	*	230
131507	7	7-1/4	11-1/2	4	19-1/2	*	275
131508	8	8-1/4	12-1/2	4	20-1/2	*	300
131510	10	10-1/4	14-1/2	4-1/2	22-1/2	*	410

*Product shipped individually.

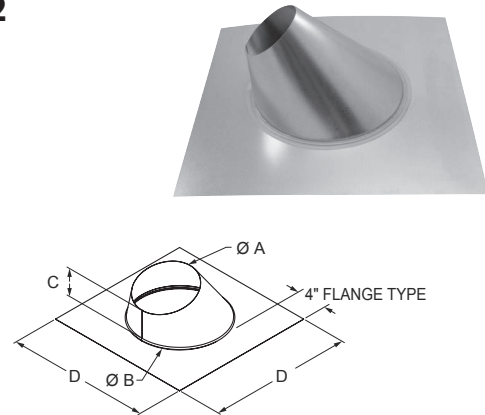

FLASHINGS — ADJUSTABLE — PIPE SIZE — 8/12-12/12

ITEM #	SIZE (")	A (")	B (")	C (")	D (")	CTN/QTY	WT/100
131523	3	3	9-1/2	4	17-1/2	*	142
131524	4	4	10-1/2	4	18-1/2	*	164
131525	5	5	12-1/2	4	20-1/2	*	186
131526	6	6	13-1/2	4	21-1/2	*	211
131527	7	7	15	4	23	*	246
131528	8	8	16	4	24	*	273
131529	9	9	19	4	27	*	300
131530	10	10	20	4-1/2	28	*	341

*Product shipped individually.

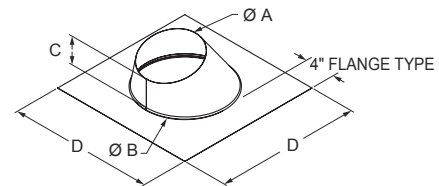
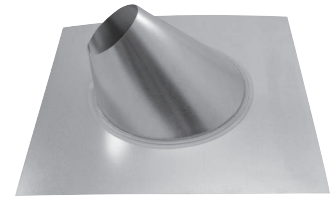

LINESET — ADJUSTABLE — 1/12-7/12

ITEM #	SIZE (")	CTN/QTY	WT/100
131484	4	10	180

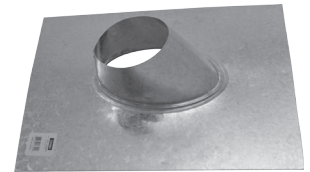
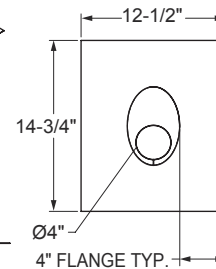
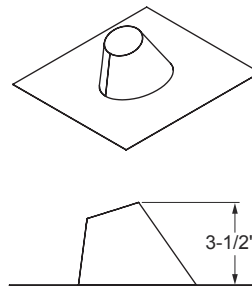

I.P.S. ADJUSTABLE ROOF FLASHINGS

ITEM #	SIZE (")	COLOR	A (")	CTN/QTY	WT/100
131201	1-1/2	Galvanized	1-1/2	10	210
131202	2-1/2	Galvanized	2-1/2	10	220
131203	3-1/2	Galvanized	3-1/2	10	230

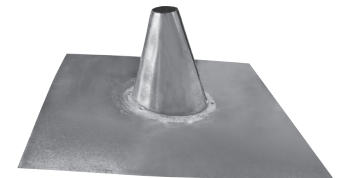
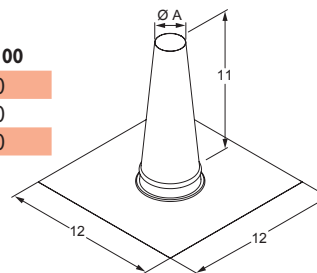

STORM COLLARS — PIPE SIZE

ITEM #	SIZE (")	A (")	CTN/QTY	WT/100
131412	10	10	*	46
131417	12	12	*	50
131422	14	14	*	60

*Product shipped individually.

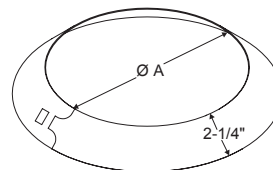

COLLARS WITH FLANGE

ITEM #	SIZE (")	A (")	B (")	C (")	CTN/QTY	WT/100
134866	6 × 3	6	3	2	20	90
134868	8 × 3	8	3	2	20	120
134870	10 × 3	10	3	2	20	160
134872	12 × 3	12	3	2	20	210

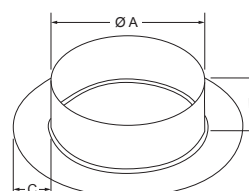

— E.&O.E. — Subject to Change Without Notice — May Not Be Available At All Locations —

ROOF JACKS ALL PITCH

ITEM #	DESCRIPTION	A (")	B (")	C (")	D (")	E (")	CTN/QTY	WT/100
130200	6" x 6"	5	8	13	15	7	10	201
130209	6" x 6" - Soldered	5	8	13	15	7	10	180

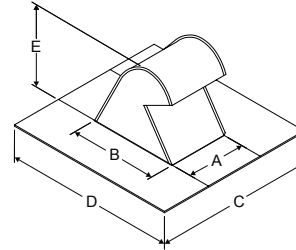

ROOF JACKS ALL PITCH — 8 x 8

ITEM #	SIZE (")	A (")	B (")	C (")	D (")	E (")	F (")	CTN/QTY	WT/100
130100	8 x 8	8	9	7-1/2	15	17	8-1/2	10	298

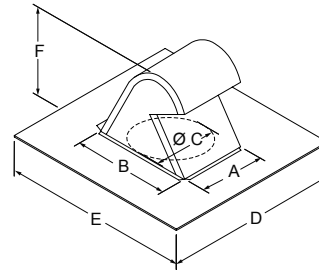

ROOF JACKS — ROUND — ALL PITCH

ITEM #	SIZE (")	A (")	B (")	CTN/QTY	WT/100
131034	3-4	4	12	15	250
131056	5-6	6	15	8	380
131078	7-8	8	18	5	460

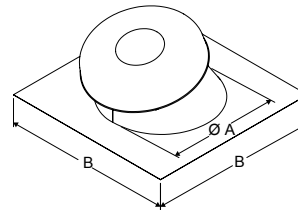

ROOF JACKS SQUARE TOP — SOLDERED — 8 x 8 — 26 GAUGE

ITEM #	SIZE (")	A (")	B (")	C (")	D (")	E (")	CTN/QTY	WT/100
130108	8 x 8	8	8	16	16	7	10	270

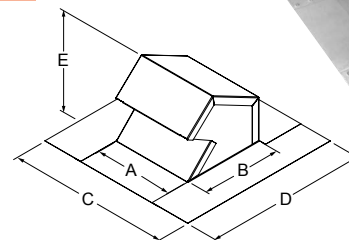

-E.&O.E. - Subject to Change Without Notice - May Not Be Available At All Locations -

ROOF JACKS — MOBILE HOME — 8 × 8

ITEM #	SIZE (")	A (")	B (")	C (")	D (")	E (")	F (")	CTN/QTY	WT/100
131010	8 × 8	8	9	7-1/2	15	17	10	6	345

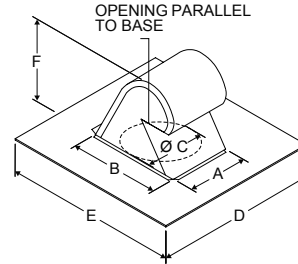

ROOF JACKS ROUND TOP — SOLDERED — 8 × 8

ITEM #	SIZE (")	A (")	B (")	C (")	D (")	E (")	CTN/QTY	WT/100
130109	8 × 8	8	8	15	15-5/8	8	10	270

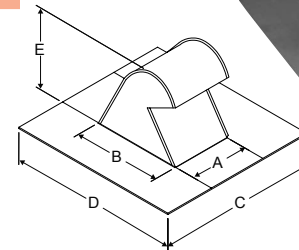

ROOF JACKS — EC144

ITEM #	DESCRIPTION	CTN/QTY	WT/100
130600	Galvanized	*	1075
130602	Brown	*	1075
130604	Black	*	1075
130605	Charcoal	*	1075

*Product shipped individually.

NOTE: Free Area = 100 Sq. In.

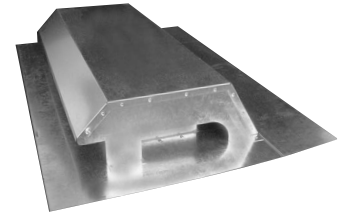
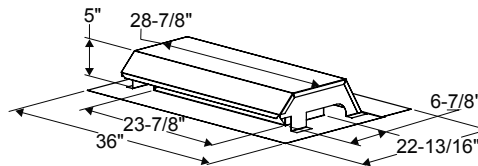

ROOF JACKS — ROUND

ITEM #	DESCRIPTION	COLOR	A (")	B (")	C (")	D (")	CTN/QTY	WT/100
130250	6" with Damper	Galvanized	6	4-1/4	14	7-1/2	10	190
130309	6" Soldered	Galvanized	6	4-1/4	14	7-1/2	10	190
130303	6" – 12" High	Galvanized	6	12	14	15-1/2	10	200
130307	6" – 12" High Soldered	Galvanized	6	12	14	15-1/2	10	240
130308	6" – 12" High with Damper Soldered	Galvanized	6	12	14	15-1/2	10	245
130330	6" – 12" High	Brown	6	12	13-1/2	15-1/2	10	240
130331	6" – 12" High	Black	6	12	13-1/2	15-1/2	10	240
130332	6" – 12" High	Charcoal	6	12	13-1/2	15-1/2	10	240
130305	6" – 12" High 4/12P	Galvanized	6	11-1/2	14	14-7/8	10	200
130260	6" with Damper and Screen	Galvanized	6	4-1/4	14	7-1/2	10	195
130259	6" with Damper Soldered	Galvanized	6	4-1/4	14	7-1/2	10	195
130311	6" Round	Brown	6	4-1/4	14	7-1/2	10	140
130313	6" Round	Black	6	4-1/4	14	7-1/2	10	140
130314	6" Round	Charcoal	6	4-1/4	14	7-1/2	10	140
130315	6" Round	Grey	6	4-1/4	14	7-1/2	10	140
130301	6" Round – Flared Base	Galvanized	6	4-1/4	14	7-1/2	10	190
130302	6" Round – 8" High	Galvanized	6	8	13-1/2	11	10	210
130316	6" with Damper	Brown	6	4-1/4	14	7-1/2	10	190
130318	6" with Damper	Black	6	4-1/4	14	7-1/2	10	190
130320	6" with Damper	Charcoal	6	4-1/4	14	7-1/2	10	190
130322	6" with Damper	Grey	6	4-1/4	14	7-1/2	10	190
130336	6" – 12" High with Damper	Brown	6	4-1/4	13-1/2	15-1/2	10	245
130337	6" – 12" High with Damper	Black	6	4-1/4	13-1/2	15-1/2	10	245
130338	6" – 12" High with Damper	Charcoal	6	4-1/4	13-1/2	15-1/2	10	245
130500	8" – All Pitch	Galvanized	7-3/4	4-3/4	15	8-7/8	10	230
130509	8" Soldered	Galvanized	7-3/4	4-3/4	15	8-7/8	10	260
130501	8" Round	Brown	7-3/4	4-3/4	15	8-7/8	10	190
130502	8" Round	Black	7-3/4	4-3/4	15	8-7/8	10	190
130503	8" Round	Charcoal	7-3/4	4-3/4	15	8-7/8	10	190
130505	8" Round	Grey	7-3/4	4-3/4	15	8-7/8	10	190
130550	8" with Damper	Galvanized	7-3/4	4-3/4	15	8-7/8	10	235
130551	8" with Damper	Brown	7-3/4	4-3/4	15	8-7/8	10	200
130552	8" with Damper	Black	7-3/4	4-3/4	15	8-7/8	10	200
130553	8" with Damper	Charcoal	7-3/4	4-3/4	15	8-7/8	10	200
130555	8" with Damper	Grey	7-3/4	4-3/4	15	8-7/8	10	200

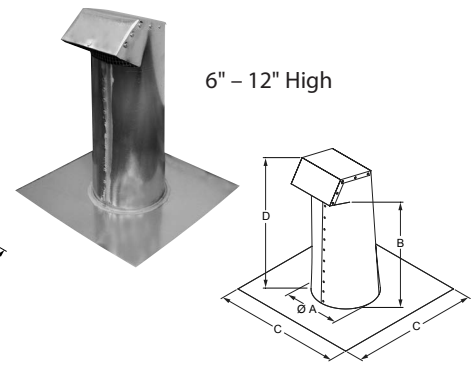
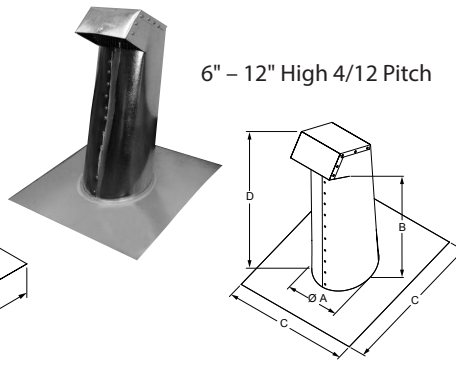
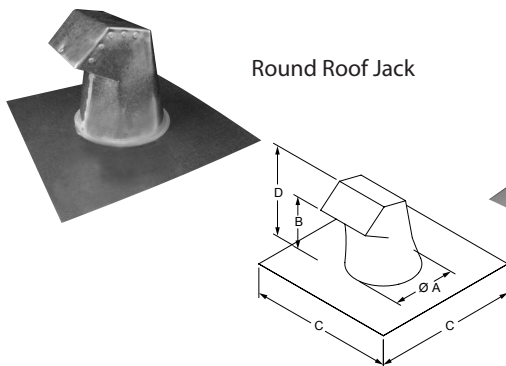

– E.&O.E. – Subject to Change Without Notice – May Not Be Available At All Locations –

BUILT UP ROOF VENTS

ITEM #	SIZE (")	COLOR	A (")	B (")	CTN/QTY	WT/100
130569	5 × 14	Galvanized	5	14	*	620
130560	6 × 6	Galvanized	6	6	*	420
130562	8 × 8	Galvanized	8	8	*	540
130566	12 × 12	Galvanized	12	12	*	780

*Product shipped individually.

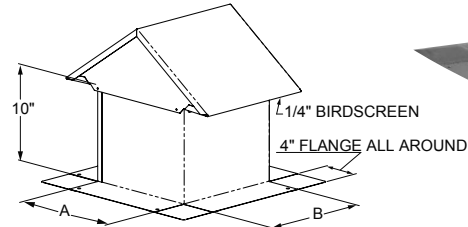

ROOF CAP ADAPTERS — RVA

STANDARD GAUGE

ITEM #	SIZE (")	A (")	B (")	CTN/QTY	WT/100
130094	4	4	10	25	64
130095	5	5	11	25	77
130096	6	6	12	20	89
130097	7	7	13	10	102
130098	8	8	14	10	114

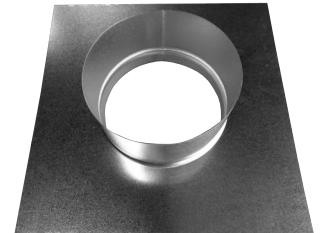
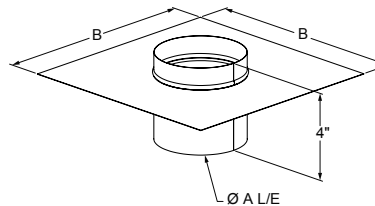

ATTIC VENTS — SQUARE — SOLDERED — GALVANIZED

ITEM #	SIZE (")	CTN/QTY	WT/100
130596	14 × 12	*	990

*Product shipped individually.

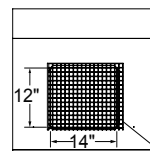

1/4" × 1/4" BIRDSCREEN

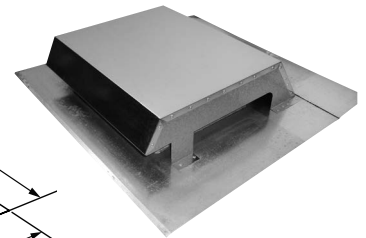
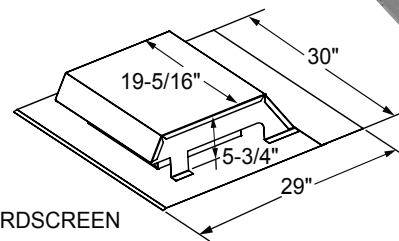

ROOF VENTS WITH STEM

ITEM #	DESCRIPTION	COLOR	A (")	B (")	C (")	D (")	CTN/QTY	WT/100
130044	Roof Vent with Stem	Black	4	6-1/2	12	4-1/4	*	170
130049	Roof Vent with Stem	Dark Brown	4	6-1/2	12	4-1/4	*	170
130064	Roof Vent with Stem	Black	6	8	14	5-1/4	*	280
130069	Roof Vent with Stem	Dark Brown	6	8	14	5-1/4	*	280

*Product shipped individually.

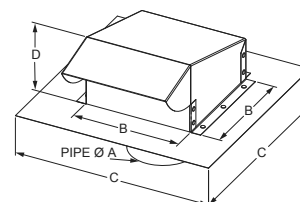

— E.&O.E. — Subject to Change Without Notice — May Not Be Available At All Locations —

PLASTIC ROOF CAP STEM VENTS — BVDS

ITEM #	DESCRIPTION	COLOR	A (")	B (")	C (")	D (")	CTN/QTY	WT/100
681410	BVDS-4" Roof Vent	Black	4	11	12-1/2	5	4	150
681411	BVDS-4" Roof Vent	Brown	4	11	12-1/2	5	4	150
681412	BVDS-4" Roof Vent	Dark Brown	4	11	12-1/2	5	4	150
681413	BVDS-4" Roof Vent	Grey	4	11	12-1/2	5	4	150
681414	BVDS-4" Roof Vent	Wood Grey	4	11	12-1/2	5	4	150
681416	BVDS-5" Roof Vent	Black	5	13	14-3/4	4-3/4	4	165
681417	BVDS-5" Roof Vent	Brown	5	13	14-3/4	4-3/4	4	165
681418	BVDS-5" Roof Vent	Dark Brown	5	13	14-3/4	4-3/4	4	165
681419	BVDS-5" Roof Vent	Grey	5	13	14-3/4	4-3/4	4	165
681420	BVDS-5" Roof Vent	Wood Grey	5	13	14-3/4	4-3/4	4	165
681421	BVDS-6" Roof Vent	Black	6	13	14-3/4	4-1/2	4	175
681423	BVDS-6" Roof Vent	Dark Brown	6	13	14-3/4	4-1/2	4	175
681424	BVDS-6" Roof Vent	Grey	6	13	14-3/4	4-1/2	4	175
681425	BVDS-6" Roof Vent	Wood Grey	6	13	14-3/4	4-1/2	4	175

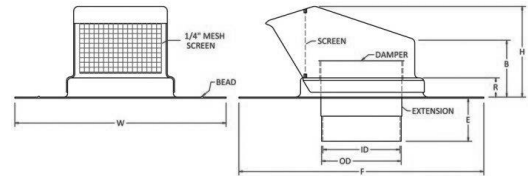

– E.&O.E. – Subject to Change Without Notice – May Not Be Available At All Locations –



www.eccomfg.com

Langley Distribution

19860 Fraser Highway
Langley, British Columbia
Canada V3A 4C9

Phone: 604-530-4151
Toll Free: 1-877-955-4805
Fax: 604-533-9335

Calgary Distribution

21 – 11150 38th Street, S.E.
Calgary, Alberta
Canada T2C 2Z6

Phone: 403-720-0895
Toll Free: 1-877-955-4815
Fax: 403-720-0897

Kent Distribution

20001 87th Ave. S, Bldg E
Kent, Washington
USA 98031

Phone: 253-872-3721
Toll Free: 1-800-207-6859
Fax: 253-872-3724