

- 关于Opengear
- 带外管理
- 故障转移到蜂窝
- 产品系列
- 主要特征
- 现状/未来
- 技术支持
- 讨论



关于OPENGEAR

获奖创新技术

- 成立于2004年 – 工厂在犹他州. 总部,营销和产品管理在新泽西. 研发分别在澳大利亚和硅谷. 销售分遍在亚洲,欧洲和美国.
- 广泛采用的带外管理解决方案.
- 我们的解决方案使网络更具弹性, 即使在网络中断期间也能提供正常运行



什么是“带外管理”？

带外（OOB）利用备用网络来获得在网络故障期间控制台访问这些设备



宽带或以太网带外管理



管理以太网（IP）

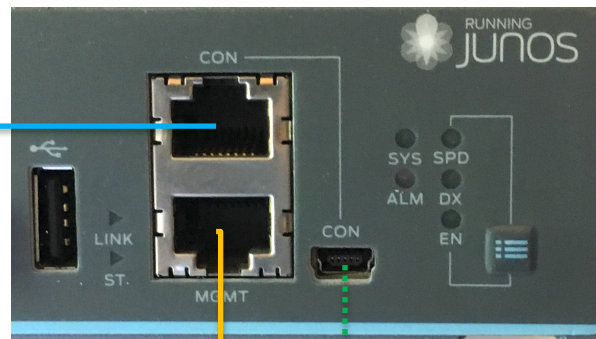
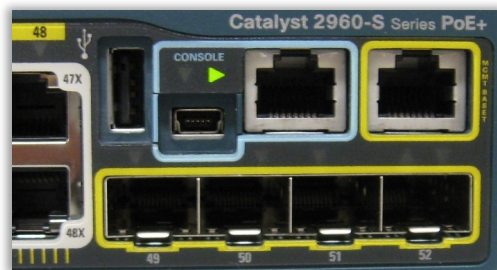

USB控制台

现代领导的先锋带外管理解决方案

90%的Opengear产品已连接上 Cisco, Juniper, Brocade 和 Arista. 我们也常常连接到 F5, Riverbed, HP. 我们的产品适合用于世界各地的数据中心和分支机构。

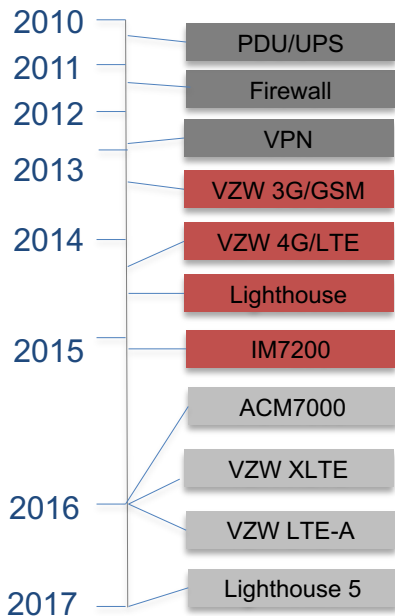

管理大多数供应商和大多数设备

- 网络和通信基础设施
- 数据中心，网络核心，边缘，分支
- 路由器，交换机，防火墙，负载均衡器
- SD-WAN，服务器，熄灯卡，存储
- 供应商中立电源 - PDU，UPS



客户使用我们的解决方案唯

DAY ONE: 新的数据中心或机房部署：

- 远程配置新开箱即用的设备。
- ZTP服务器/ TFTP存储，用于快速自动配置

DAY TWO: 现有的网络设置。用于监控和维护

- 通过串行IP (SSH或GUI) 和VPN进行故障排除和修复网络系统
- 远程电源循环 - UPS监控和警报 - 环境监测
- 共享同样的终端站以提供远程帮助和协调
- 用于审计和根本原因分析的端口日志

首次服务推出和迁移：

- 轻松迁移到新设施地点和新服务推出



解决方案 - 故障转移到移动网络和带外管理

通过4G / LTE备份互联网连接，并在同一个盒子中进行带外管理。主要用于远程站点和分支机构。



购买我们的产品的行业？



云端
数据中心



电信业



零售业



金融业



医疗保健
和制药业

咨询订购：400-010-8885、Support@opengear.com.cn

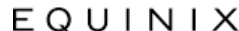

IT agility. Your way.®

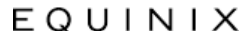

J.CREW



ERNST & YOUNG
Quality In Everything We Do



Empowering Healthcare



Lighthouse 5

带外网络集中管理

跨网络的清晰视图

通过Lighthouse的单镜头查看整个带外网络

- 安全，中央的带外管理系统
- 远程访问Opengear控制台服务器和第三方设备
- NetOps自动化引擎和业务流程
- 可扩展的管理和自动化
 - 新站点配置
 - 常规操作
 - 灾难恢复



在凌晨3点网络崩溃时“给我一个控制台”

- 标准浏览器用户界面（不使用Java！）
- 智能标记和通过元标记分组
- 按名称访问受管设备
- 完整功能RESTful API

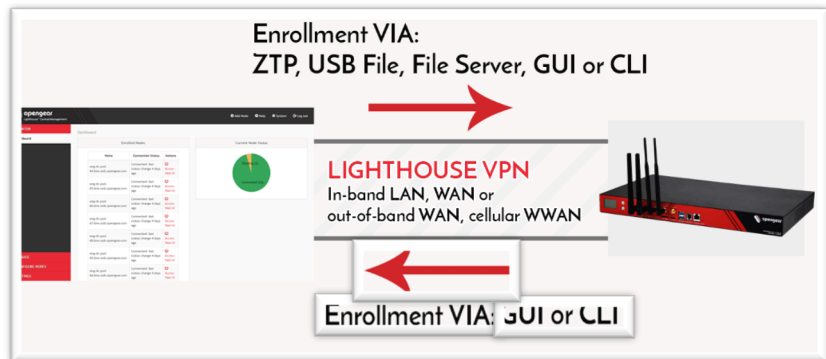

- Lighthouse作为虚拟机提供
 - 兼容VMWare , VirtualBox和HyperV
- 图像可用于托管云提供商
 - 谷歌计算机引擎
 - Microsoft Azure
 - AWS将于2019年第三季度上市

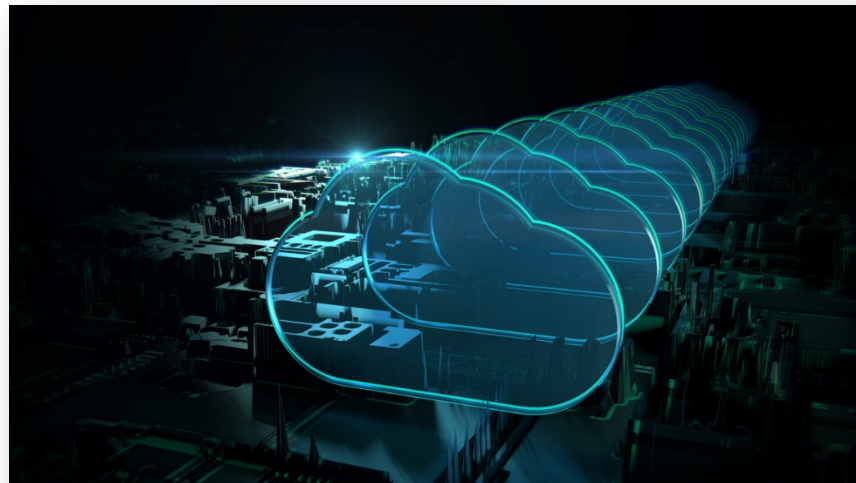

Lighthouse模块作为一年许可证出售

- 购买任意数量的节点
- 可以一次购买多个连续年份许可证
- 许可证期限包括更新和支持
- 所有订阅都通过经销商网络销售



产品范围



IM7200 控制台服务器



ACM7000 弹性网关



CM7100 Console服务器

高性能设计

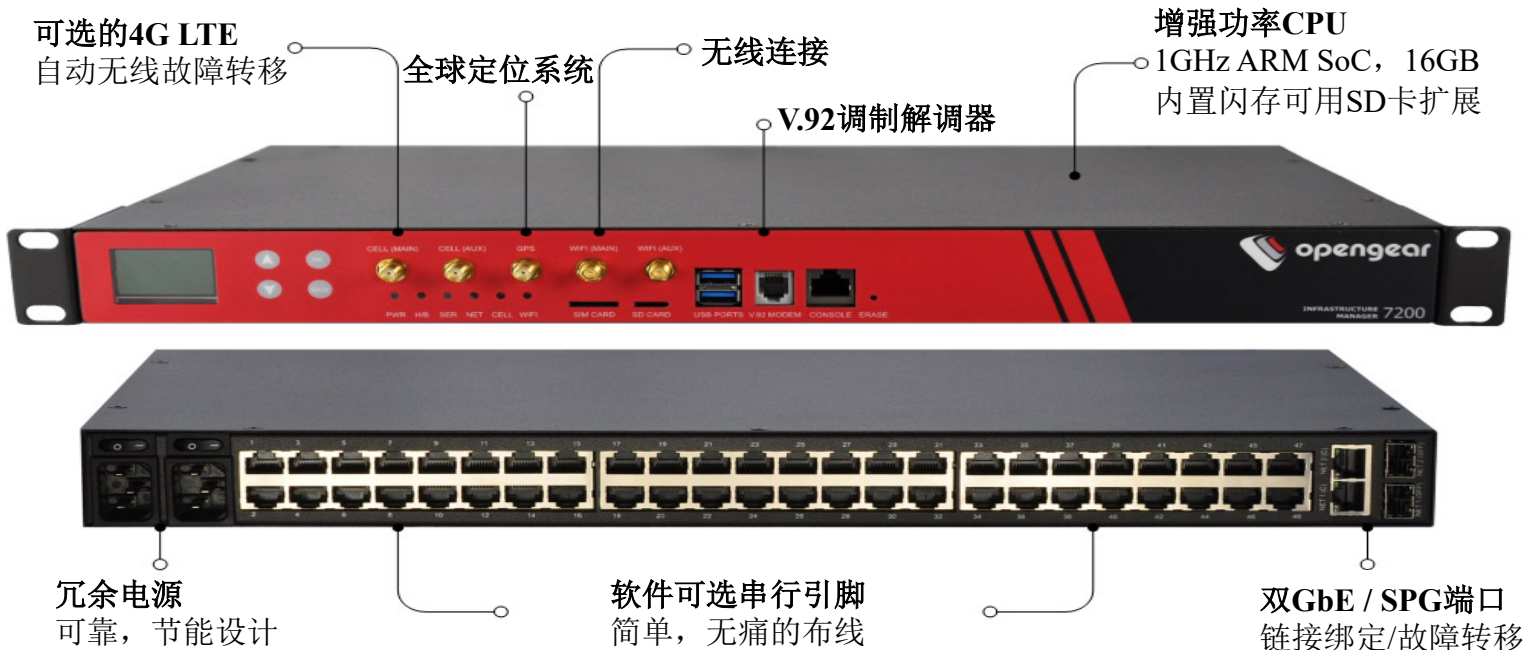

CM7100 Console服务器

简化带外管理



- 成本效益 - 无调制解调器或LTE
- 16,32,48或96个串行端口
- 思科直接引出
- 双10/100/1000铜
- 内置TFTP / FTP和4GB闪存
- 环境监测/警报
- 电源开/关设备
- 双交流或直流电源
- 端口共享
- TACACS + , LDAP , RADIUS Auth

用户体系架构

IM7200 控制台服务器

- 主机托管和数据中心
- 4G / LTE的前端
- 中至大型分公司
- SSH和VPN访问
- 链接无4G网络的串口设备
- 使用WiFi/LTE 远程连接到中央管理软件 Lighthouse

CM7100 Console服务器

- 主机托管和数据中心
- 高密度串行端口
- 双电源 - 成本效益



ACM7000 弹性网关

在分支机构和远程站点，确保它可以正常工作并解决网络边缘的问题



- 4或8个串行端口
- 双10/100/1000铜缆（可选SFP）
- 支持多个移动网络运营商- 双SIM卡
- 内置TFTP / FTP和4GB闪存
- 用于外部传感器的内置数字I/O.
- 环境监测/警报
- 电源开/关设备
- 数据缓冲
- 端口共享
- 强化安全性

用户体系架构

ACM7000 弹性网关

- 零售，分支机构和远程站点
- 托管服务网关
- 故障转移到4G / LTE
- SSH和VPN访问
- 使用WiFi/LTE 远程连接到中央管理软件 Lighthouse
- IoT/M2M
- SD-WAN OOBM
- ZTP服务器用于快速部署

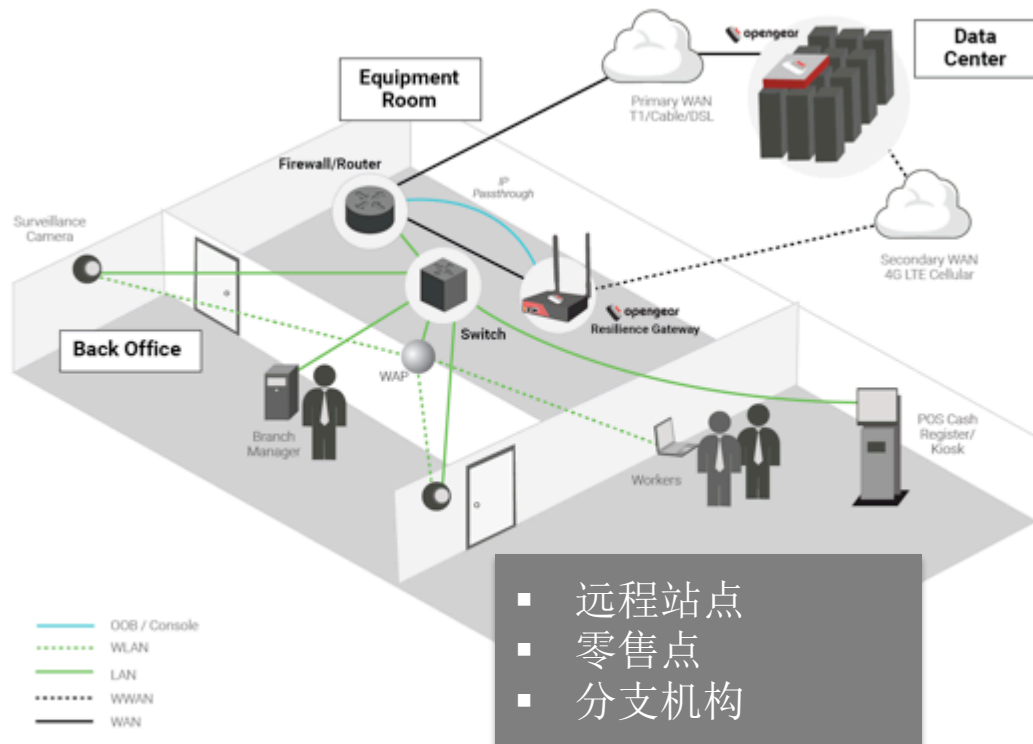

供应商电源管理

Opengear基础设施管理设备独特地提供供应商中立的电力监控和控制 - 建立在流行的开放式网络UPS工具, Powerman 和 ipmitools项目之上。每个设备内置的功能是通过以太网, USB和串行管理接口监控100多家供应商的UPS和PDU设备。

- 启动服务器关闭
- 监控并提醒UPS负载, 电池, 充电, 健康
- 将热键集成到交换式PDU中, 实现简单的电源循环
- 创建检查条件以监控电源并触发操作事件和警报
- 图形访问UPS系统数据和日志历史记录



Fig. 2

In-session 电源控制

将Opengear串行端口与电源板插座相关联

Juniper T1600	Serial (Port 1 (Juniper_T1600)) RPC (Opengear_Power_Strip Outlet 2)	No Active Users, View: Logs ● On - 26 sec ago	Connect: via SSH via Web Terminal Power:   
---------------	--	--	---

~p - 唤起电源菜单

O - 打开电源

P - 关闭电源

R - 关闭电源然后再打开

s - 显示当前电源状态

. - 退出电源菜单

? - 显示此消息

无需要人力控制电源 - 减少所需的工具数量

环境监测

Opengear基础架构管理设备弥合物理设备层和您的监控仪表盘之间的缝隙，以监测环境和功率传感器，如温度，湿度，气流和电力负荷的支持。这为您的数据中心经理提供了电源容量规划所需的持续指标，以及预防由热点和冷却系统故障引起的问题的能力。

可插拔的物理传感器，包括门接触传感器，漏水检测和烟雾报警器，可以持续监控和记录，为客户提供最佳的安心和物理审计跟踪安全保障。



EMD5000
环境监测装置



烟雾传感器



漏水传感器



振动传感器



门接触传感器



检查 - 回复 - 解决

自动了解情况并在问题发生之前做出反应

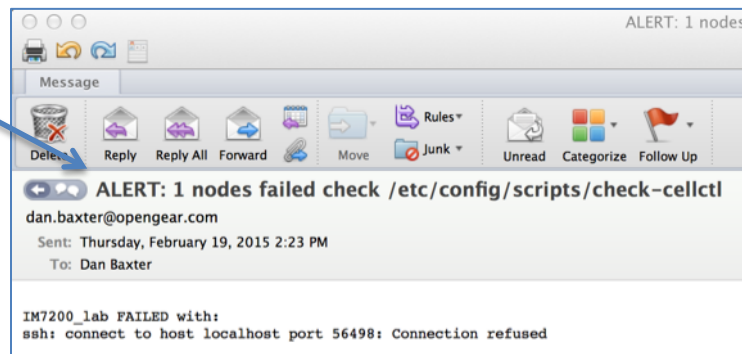
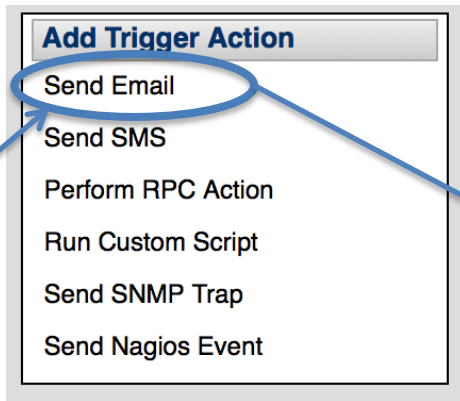
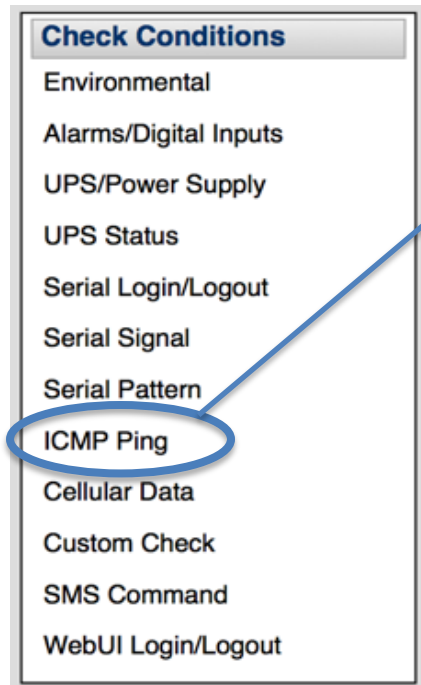

示例 - 如果设备ping失败，则发送电子邮件

内置T/FTP

含4GB或16GB内部闪存并启用TFTP或FTP服务

IOS图像
设备备份

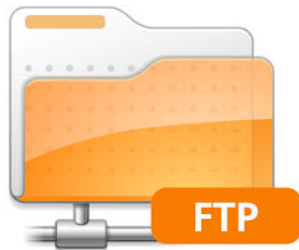

Opengear IM7248 - 16GB闪存
TFTP / FTP服务器已启用

```

Shell
Dans-MacBook-Pro:~ dan$ ftp ftp@192.168.1.202
Connected to 192.168.1.202.
220 IM7200_test_2 FTP server (GNU inetutils 1.4.1) ready.
331 Password required for ftp.
Password:
230 User ftp logged in.
Remote system type is UNIX.
Using binary mode to transfer files.
ftp> ls
227 Entering Passive Mode (192,168,1,202,224,183)
ftp: Can't connect to `192.168.1.202': Connection refused
200 PORT command successful.
150 Opening ASCII mode data connection for '/bin/ls'.
drwxrwxr-x  2  0    9           16384 Oct  6 17:11 Config Backups
drwxrwxr-x  2  0    9           16384 Jan  3 2029 Image Backups
drwxr-xr-x  3  0    0           5774 Jan 13 04:30 bin
-rwxrwxr-x  1  0    9          12833411 Jan  3 2029 im72xx-3.15.0.f
    
```

ZTP - 零接触部署

- 允许快速轻松部署
- 使用基于文本的配置文件自动配置Opengear，轻松编辑和扩展
- 在启动时自动升级设备
- 轻松集成到自动配置系统中

- 网络设备盒上带有MAC地址的条形码
- 在接收基座上扫描
- 加载到资产跟踪系统
- 配置系统，创建配置文件



SKU: IM7248-2-DAC

WLAN: 000E8E123456



MAC 1: 00:13:C6:01:12:34



MAC 2: 00:13:C6:01:12:35



Serial No: 72001234121201



Model: IM7248-2-DAC

Assembled in U.S.A.

This device complies with Part 15 of the FCC rules. Operation is subject to the following two conditions: (1) this device may not cause harmful interference, and (2) this device must accept any interference received, including interference that may cause undesired operation.

WARNING: No operator serviceable parts inside, refer servicing to qualified personnel. To reduce the risk of shock, disconnect both power cords before servicing the unit.

AVERTISSEMENT: Aucune pièce n'est réparable par l'opérateur à l'intérieur, confiez la réparation à un personnel qualifié. Pour réduire le risque de choc, débranchez les deux cordons d'alimentation avant de réparer l'appareil.

Internal Modem: Complies with 47 CFR Part 68 US:3A4MM00BTM

CAN ICES-3(A)/NMB-3(A)

INPUT: 100-240Vac, 50-60Hz, 1.6A



Part No.: 509155-02

519288-02

技术支持

- 4年硬件保修 <https://opengear.zendesk.com/entries/23104027-Product-Warranty>
- 免费软件下载产品的生命周期
- 支持票据已打开，RMA已发布，交叉发货可提供24小时周转时间
- 技术支持时间周一至周五上午7点至下午6点MST
- 技术支持电邮 support@opengear.com

咨询订购：400-010-8885、Support@opengear.com.cn

