

EZFLOW® ENGINEERED FRENCH DRAIN

EZflow® Gravel-Free French Drain

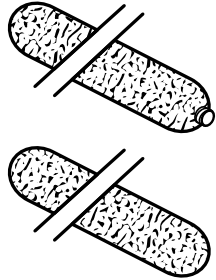

Part No.	Description	Color	Bundle size/ Linear Feet	Wt. per Bundle (lbs.)	Product Class	Specifications
EZ-0701F	7" mesh with 3" slotted pipe (center)	Black	90	32.4	11RP	10 ft. polyethylene slotted drain pipe surrounded by 100% recycled polystyrene aggregate and enclosed in 30-sieve polyethylene geotextile mesh.
EZ-1001F	10" mesh with 4" slotted pipe (center)	Black	50	29.5	11RP	
EZ-1501F	15" mesh with 6" slotted pipe (center)	Black	20	26.0	11RP	
EZ-1501FB	15" mesh with 6" slotted pipe (bottom)	Black	20	26.0	11RP	
EZ-0701A	7" mesh without pipe – aggregate only	Black	90	18.0	11RP	10 ft. segment of 100% recycled polystyrene aggregate only, enclosed in 30-sieve polyethylene geotextile mesh.
EZ-1001A	10" mesh without pipe – aggregate only	Black	50	13.5	11RP	
EZ-1501A	15" mesh without pipe – aggregate only	Black	20	12.4	11RP	

DRAINAGE

EZflow® Internal Couplings & End Caps

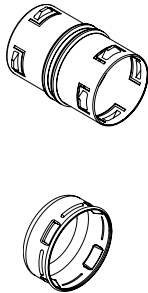

Part No.	Description	Color	Pkg. Qty.	Wt. Ea. (lbs.)	Product Class
3C05	3" Corrugated Internal Coupling	Black	60/box	0.30	11RP
4C07	4" Corrugated Internal Coupling	Black	36/box	0.30	11RP
6C07	6" Corrugated Internal Coupling	Black	12/box	0.80	11RP
3C06	3" Corrugated End Cap	Black	33/box	0.30	11RP
4C06	4" Corrugated End Cap	Black	21/box	0.50	11RP
6C06	6" Corrugated End Cap	Black	15/box	0.50	11RP

Storage & Flow for EZflow® Drainage Bundles *(45% void space among consolidated EPS aggregate)*

Pipe Bundles						
Product	Storage Volume (gallons/10 ft. bundle)	Flow Capacity (gpm @ 1% slope)				
EZ-0701F	11.4	80.8	7"	3" PIPE (CENTERED)		
EZ-101F	21.5	130.9	10"	4" PIPE (CENTERED)		
EZ-1501F/EZ-1501FB	45.8	345.0	15"	6" PIPE (BOTTOM)		
			15"	6" PIPE (CENTERED)		
Aggregate-Only Bundles						
Product	Storage Volume (gallons/10 ft. bundle)	Flow Capacity (gpm @ 1% slope)				
EZ-0701A	8.8	37.1	7"	NO PIPE		
EZ-1001A	17.2	75.7	10"	NO PIPE		
EZ-1501A	36.5	170.3	15"	NO PIPE		

FLO-WELL® ENGINEERED DRY WELL

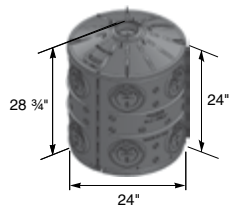

Part No.	Description	Color	Pkg. Qty.	Wt. Ea. (lbs.)	Product Class	Specifications
FWAS24WH	24" diam. x 28.75"H Flo-Well® Stormwater Leaching System	Black	1	18.96	10FW	NDS #FWAS24WH structural foam polyolefin round drywell system with UV inhibitors. 50 gal. storage capacity.
Includes 3 side panels, 1 top component. Fits 4" Sch. 40 Pipe and 4" DWV Pipe.						

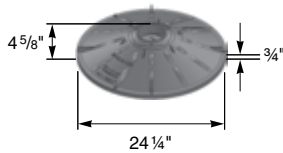

Part No.	Description	Color	Pkg. Qty.	Wt. Ea. (lbs.)	Product Class	Specifications
FWAS24CWH	24" diam. Flo-Well® Cover	Black	2	5.92	10FW	Structural foam polyolefin round drywell system cover with UV inhibitors. 24 1/4" dia., 4 5/8" height, 3/4" outer lip, 4.5" center knockout fits NDS #FWSD69, std pipe and 4" Sch. 40 pipe.
Use with #FWAS24.						

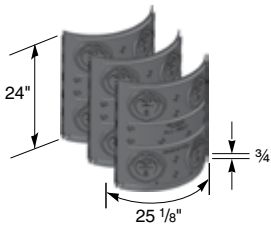

Part No.	Description	Color	Pkg. Qty.	Wt. Ea. (lbs.)	Product Class	Specifications
FWSPS3WH	Flo-Well® Side Panels/Extension Only	Black	1	4.35	10FW	Structural foam polyolefin side panels with UV inhibitors with 22 1-1/2" knockout leaching ports and 4 4.5" knockout inlet/outlet ports per panel. 0.75" lip for firm stacking.
Includes 3 side panels; makes 1 round drywell. (May also be used as a durable compost bin)						

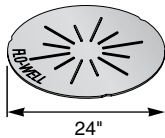

Part No.	Description	Color	Pkg. Qty.	Wt. Ea. (lbs.)	Product Class	Specifications
FWBP24	24" diam. Flo-Well® Bottom	Black	5	3.41	10FW	Structural foam polyolefin round Flo-Well® bottom with UV inhibitors. 24" diameter with six 1-1/2" leaching ports. Collects debris for easy cleanout.
Fits #FWAS24. (Not included in #FWAS24 kit)						

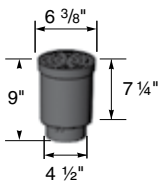

Part No.	Description	Color	Pkg. Qty.	Wt. Ea. (lbs.)	Product Class	Specifications
FWSD69	4" Sch. 40 Surface Drain Inlet with Grate	Black	8	1.85	10FW	Structural foam polyolefin 6" grate with 4" inlet with UV inhibitors. 6" diameter at inlet. 9" high. 4.5" OD fits Sch. 40 PVC fittings. Open surface area 8.22 square inches. 25.15 GPM.
Fits #FWAS24 and #FWAS24C. ADA Compliant.						

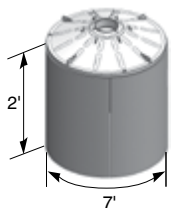

Part No.	Description	Color	Pkg. Qty.	Wt. Ea. (lbs.)	Product Class	Specifications
FWFF67	Porous Filter Fabric Wrap for Flo-Well®	Black	1	0.35	10FW	7" long x 2" wide to surround Flo-Well® Drywell System. Non-woven fabric. Weight 1 oz. Mullen burst 175 psi. 200 GPM flow-through.
Use with #FWAS24.						

CATCH BASINS

DRAINAGE



NDS catch basins and grates collect surface water while minimizing the amount of debris entering the system

Available in a range of sizes from 6" round to 24" square, and with various grating and filter options for commercial and residential systems.

NDS Drainage Solutions

NDS offers a complete line of catch basins and grates for residential and commercial stormwater management solutions. NDS catch basins have sump areas that collect debris and prevent clogging of the pipeline, and grates are available in a variety of patterns and colors to blend in with surrounding surfaces. Depending on the size of the round, square, or atrium grates, they may fit directly into a riser of pipe, sewer and drain fitting, or our catch basins.



Small Grates

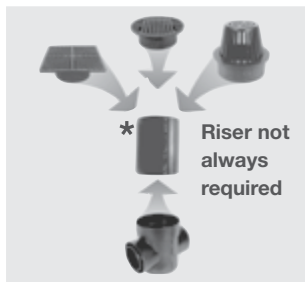

Spee-D® Basin

* Shown with section of 6" S&D pipe (Not NDS product).

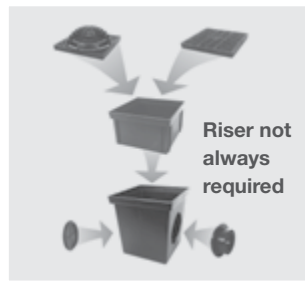

Large Catch Basin

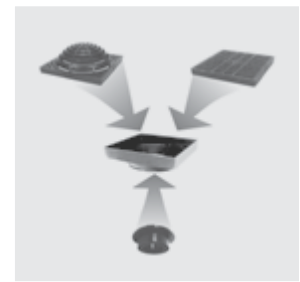

Adapter

Spee-D® Basins

Use our compact 6" round Spee-D Basins with grates to collect runoff water while its sump area collects debris and prevents clogging. Also use Spee-D Basins with 6" Pop-Up Emitters to provide a point of discharge or overflow in a drainage system.

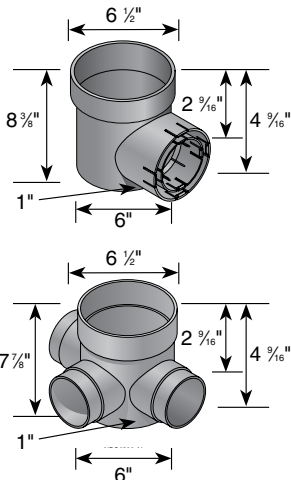

Part No.	Description	Color	Pkg. Qty.	Wt. Ea. (lbs.)	Product Class	Specifications
101	1 - 3" and 4" Locking Outlet*	Black	10	1.60	10ND	6" styrene catch basin with locking outlet. 68 GPM per outlet capacity.
201	3" and 4" Locking Outlets*	Black	10	1.83	10ND	
Fit 3" or 4" Sewer & Drain Pipe, 3" or 4" Corrugated Pipe, 4" Sch. 40 and 3" & 4" Triple Wall Pipe. Use 6" Sewer and Drain Pipe as a riser for all 6" round catch basins. Use waterproof silicone to make water-tight connections. * New Locking Outlet snaps on to most 3" and 4" corrugated pipe.						

Part No.	Description	Color	Pkg. Qty.	Wt. Ea. (lbs.)	Product Class	Specifications
250	2 - 3" and 4" 90° Outlets	Black	12	1.64	10ND	6" styrene catch basin with locking outlet. 83 GPM per outlet capacity.
300	3 - 3" and 4" Outlets	Black	12	1.82	10ND	
350	3" and 4" Outlets	Black	12	2.00	10ND	
Fit 3" or 4" Sewer & Drain Pipe, 3" or 4" Corrugated Pipe, 4" Sch. 40 and 3" & 4" Triple Wall Pipe. Use 6" Sewer and Drain Pipe as a riser for all 6" round catch basins. Use waterproof silicone to make water-tight connections.						

CATCH BASINS

9" Catch Basin Series



Part No.	Description	Color	Pkg. Qty.	Wt. Ea. (lbs.)	Product Class	Specifications
900FF	9" Catch Basin Filter	Blue Frame/ Black Bag	8	0.06	10ND	Polypropylene Frame Fabric is non-woven geotextile 956 PM/SF.
Compatible with these basins: 900, 900-4 and 916 NDS Catch Basins, Risers and Kits						

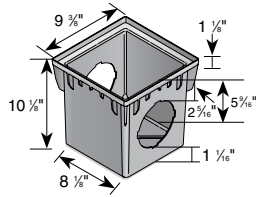

Part No.	Description	Color	Pkg. Qty.	Wt. Ea. (lbs.)	Product Class	Specifications
900BLKIT	9" x 9" Catch Basin Kit	Black Grate	4	4.90	10ND	9" x 9" tapered Catch Basin. Polypropylene.
900GRKIT	9" x 9" Catch Basin Kit	Green Grate	4	4.90	10ND	
900KITDISP	9" x 9" Catch Basin Kit	Black Grate	8	39.2	10ND	Kits include 2-opening Catch Basin, Grate, Screws, 2 Outlets and 1 Plug.
900	9" x 9" Catch Basin 2-opening	Black	4	2.18	10ND	
900-4	9" x 9" Catch Basin 4-opening	Black	4	2.00	10ND	
Requires either #1206, #1242, #1243, #1245 or #1266 Universal Outlet to connect pipe to basin. (see page 33)						DISP includes display box.

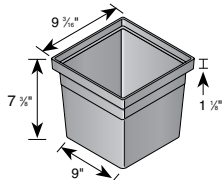

Part No.	Description	Color	Pkg. Qty.	Wt. Ea. (lbs.)	Product Class	Specifications
916	9" x 9" Catch Basin Riser	Black	4	1.75	10ND	6" Riser for 9" x 9" Catch Basin. Styrene.
Use with 9" x 9" Catch Basin Series. Stacks on top of 9" catch basins to add up to 6" to top of basin. Can be cut to size.						

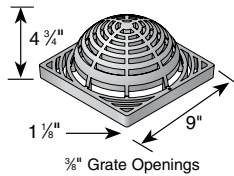

Part No.	Description	Color	Pkg. Qty.	Wt. Ea. (lbs.)	Product Class	Specifications
981	9" x 9" Atrium Grate	Black	6	0.87	10ND	9" Structural Foam Polyolefin Dome Atrium Grate with UV inhibitor.
991	9" x 9" Atrium Grate	Green	6	0.87	10ND	Open surface area 31.50 square inches. 96.36 GPM.
Use with 9" x 9" Catch Basin Series.						

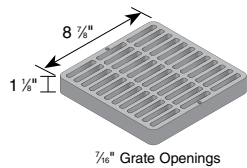

Part No.	Description	Color	Pkg. Qty.	Wt. Ea. (lbs.)	Product Class	Specifications
980	9" Square Grate	Black	8	1.50	10ND	9" Square Structural Foam Polyolefin Grate with UV inhibitor. Open surface area 37.49 square inches. 114.69 GPM.
990	9" Square Grate	Green	8	1.50	10ND	
999	9" Square Grate	Gray	8	1.50	10ND	
999S	9" Square Grate	Sand	8	1.50	10ND	
Use with 9" x 9" Catch Basin Series. NDS #980, 990, 999, 999S: Class A Load Rated. ADA Compliant. NDS #930B: Class B Load Rated. (see page 72). ADA Compliant.						

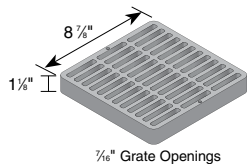

Part No.	Description	Color	Pkg. Qty.	Wt. Ea. (lbs.)	Product Class	Specifications
930B	9" Square Brass Grate	Brass	1	5.11	15BR	Open surface area 34.00 square inches. 104.01 GPM. Includes SS Screws.
(see page 72). ADA Compliant.						

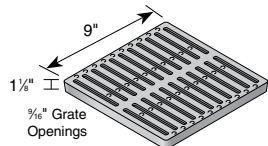

Part No.	Description	Color	Pkg. Qty.	Wt. Ea. (lbs.)	Product Class	Specifications
913	9" Square Ductile Iron Grate	Black	4	7.89	10ND	9" Square Heavy-Duty Ductile Iron Grate. Open surface area 21.70 square inches. 66.38 GPM.
Use with 9" x 9" Catch Basin Series. (see page 72)						

DRAINAGE

CATCH BASINS

9" Catch Basin Series (continued)

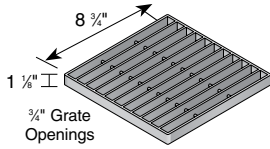

Part No.	Description	Color	Pkg. Qty.	Wt. Ea. (lbs.)	Product Class	Specifications
915	9" Square Galvanized Steel Grate	Galvanized Steel	4	3.80	10ND	9" Square Heavy-Duty Galvanized Steel Bar Grate. Open surface area 61.94 square inches. 189.48 GPM.
	Use with 9" x 9" Catch Basin Series. (see page 72)					

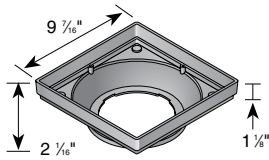

Part No.	Description	Color	Pkg. Qty.	Wt. Ea. (lbs.)	Product Class	Specifications
930	9" x 9" Low-Profile Adapter	Black	8	0.75	10ND	9" x 9" Low-Profile Adapter. Styrene.
	Requires NDS #1243, #1245, #1266 or #1889 Universal Outlets to connect pipes.					

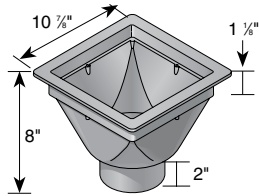

Part No.	Description	Color	Pkg. Qty.	Wt. Ea. (lbs.)	Product Class	Specifications
931	9" x 9" Deep Housing Spigot Adapter	Black	10	2.40	10ND	9" x 9" Square Deep Housing Spigot Adapter. Styrene.
	Fits 4" Corrugated Pipe. Use #933 to adapt to 4" Sewer and Drain Pipe.					

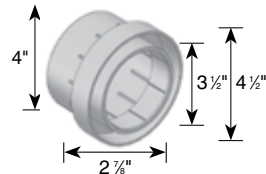

Part No.	Description	Color	Pkg. Qty.	Wt. Ea. (lbs.)	Product Class	Specifications
933	Adapter Bushing	Black	20	0.30	10ND	Styrene.
	Fits 4" Sewer and Drain Pipe. Use Housing Adapter Bushing with #931.					

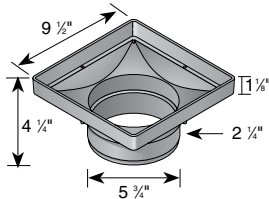

Part No.	Description	Color	Pkg. Qty.	Wt. Ea. (lbs.)	Product Class	Specifications
932	9" x 9" Low-Profile Housing Adapter	Black	8	1.13	10ND	NDS #932, 9" x 9" Square Low-Profile Housing Adapter with 6" Outlet. Styrene.
	Fits 6" Spee-D® Basin and 6" Sewer and Drain Pipe & Fittings.					

CATCH BASINS

12" Catch Basin Series



Part No.	Description	Color	Pkg. Qty.	Wt. Ea. (lbs.)	Product Class	Specifications
1200FF	12" Catch Basin Filter	Blue Frame/ Black Bag	8	0.10	10ND	Polypropylene Frame Fabric is non-woven geotextile 956 PM/SF.
Compatible with these basins: 1200, 1200NGB, 1203, 1204, 1216, 1217, 1225 NDS Catch Basins & Kits.						

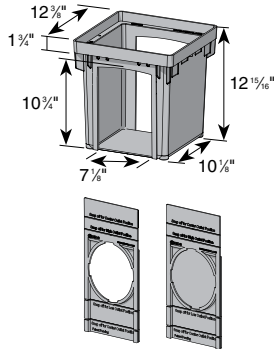

Part No.	Description	Color	Pkg. Qty.	Wt. Ea. (lbs.)	Product Class	Specifications
1200NGBKIT	12" x 12" Catch Basin, 2 Open Slides	Black	4	4.65	10ND	
1200NGB	12" x 12" Catch Basin	Black	4	3.45	10ND	
1207	Open Slide for 1200NGB	Black	8	0.60	10ND	
1208	Plug Slide for 1200NGB	Black	8	0.76	10ND	

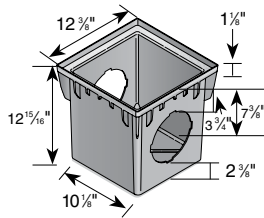

Part No.	Description	Color	Pkg. Qty.	Wt. Ea. (lbs.)	Product Class	Specifications
1200BLKIT	12" x 12" Catch Basin, 2 Open Sides	Black Grate	4	7.59	10ND	12" x 12" Tapered Catch Basin. Polypropylene.
1200GRKIT	12" x 12" Catch Basin, 2 Open Sides	Green Grate	4	7.59	10ND	
1200KITDISP	12" x 12" Catch Basin, 2 Open Sides	Black Grate	8	7.59	10ND	Kits include 2-opening Catch Basin, Grate, 2 Outlets and 1 Plug.
1200DGBLKITWH	12" Basin with Wave Decorative Grate	Black Grate	4	7.59	10ND	
1200DGGKITWH	12" Basin with Botanical Decorative Grate	Green Grate	4	7.59	10ND	DISP includes display box.
1200	12" x 12" Catch Basin, 2 Openings	Black	4	4.25	10ND	
1203	12" x 12" Catch Basin, 3 Openings	Black	4	3.75	10ND	
1204	12" x 12" Catch Basin, 4 Openings	Black	4	3.75	10ND	
Requires either #1206, #1242, #1243, #1245, #1266 or #1889 Universal Outlet to connect pipe to basin (see page 33). Bottom cutout can be removed.						

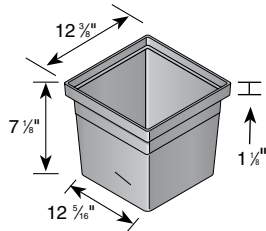

Part No.	Description	Color	Pkg. Qty.	Wt. Ea. (lbs.)	Product Class	Specifications
1216	12" x 12" Catch Basin Riser	Black	8	2.75	10ND	6" Riser for 12" Catch Basin. Styrene.
Use with 12" x 12" Catch Basin Series. Stacks on top of 12" catch basins to add up to 6" to top of basin. Can be cut to size.						

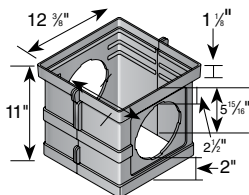

Part No.	Description	Color	Pkg. Qty.	Wt. Ea. (lbs.)	Product Class	Specifications
1217	12" x 12" Riser with 2 Openings	Black	4	4.00	10ND	12" Riser with Two Openings. Styrene.
Nests on top of 12" Catch Basin Series for shallow outlets and 12" Sump Box for more sump area. Requires either #1206, #1242, #1243, #1245, #1266 or #1889 Universal Outlet to connect pipe to riser.						

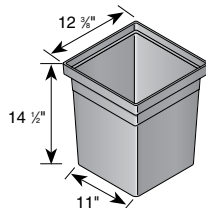

Part No.	Description	Color	Pkg. Qty.	Wt. Ea. (lbs.)	Product Class	Specifications
1225	12" x 12" Sump Box	Black	4	6.75	10ND	One-piece 12" Sump Box. Styrene.
Use with 12" x 12" Grate or #1220 Valve Box Cover.						

DRAINAGE

CATCH BASINS

12" Catch Basin Series (continued)

DRAINAGE

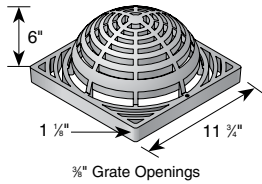

Part No.	Description	Color	Pkg. Qty.	Wt. Ea. (lbs.)	Product Class	Specifications
1280	12" x 12" Atrium Grate	Green	8	1.74	10ND	12" Structural Foam Polyolefin Dome Atrium Grate with UV inhibitor. Open surface area 50.60 square inches. 154.79 GPM.
1290	12" x 12" Atrium Grate	Black	8	1.74	10ND	
Use with 12" x 12" Catch Basin Series.						

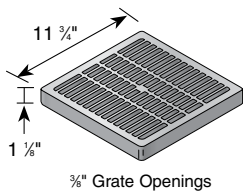

Part No.	Description	Color	Pkg. Qty.	Wt. Ea. (lbs.)	Product Class	Specifications
1210	12" x 12" Square Grate	Gray	8	2.33	10ND	12" Square Structural Foam Polyolefin Grate with UV inhibitor. Open surface area 50.76 square inches. 155.28 GPM.
1211	12" x 12" Square Grate	Black	8	2.33	10ND	
1212	12" x 12" Square Grate	Green	8	2.33	10ND	
1212S	12" x 12" Square Grate	Sand	8	2.33	10ND	
Use with 12" x 12" Catch Basin Series. (see page 72). ADA Compliant.						

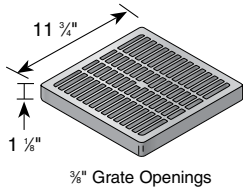

Part No.	Description	Color	Pkg. Qty.	Wt. Ea. (lbs.)	Product Class	Specifications
1230B	12" Square Brass Grate	Brass	1	9.24	15BR	Open surface area 42.87 square inches. 131.14 GPM. Includes SS Screws.
(see page 72). ADA Compliant.						

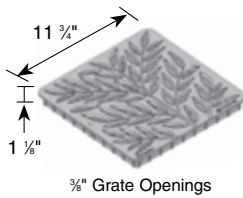

Part No.	Description	Color	Pkg. Qty.	Wt. Ea. (lbs.)	Product Class	Specifications
1218S	12" x 12" Square Botanical Grate	Sand	8	3.27	10ND	12" Square Structural Foam Polyolefin Botanical Grate with UV inhibitor. Open surface area 24.44 square inches. 74.77 GPM. Class B load rated.
1218GR	12" x 12" Square Botanical Grate	Green	8	3.27	10ND	
1218GY	12" x 12" Square Botanical Grate	Gray	8	3.27	10ND	
1218	12" x 12" Square Botanical Grate	Black	8	3.27	10ND	
839	Stainless Steel Screws, FH #6 x 1-3/4"	Metal	40	n/a	10ND	
(see page 72). ADA Compliant.						

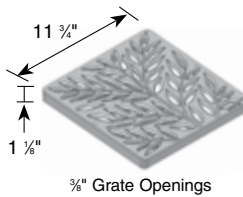

Part No.	Description	Color	Pkg. Qty.	Wt. Ea. (lbs.)	Product Class	Specifications
1218CI	12" x 12" Square Botanical Cast Iron Grate	Raw Iron	1	12.67	10ND	12" Square Cast Iron Botanical Grate. Open surface area 24.44 square inches. 74.77 GPM. Class B load rated.
629	Stainless Steel Screws, FH #20 x 1-1/2"	Metal	40	n/a	10ND	
(see page 72). ADA Compliant.						

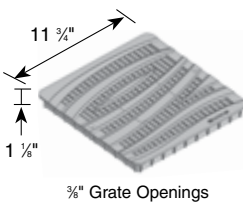

Part No.	Description	Color	Pkg. Qty.	Wt. Ea. (lbs.)	Product Class	Specifications
1224S	12" x 12" Square Wave Grate	Sand	8	2.68	10ND	12" Square Structural Foam Polyolefin Wave Grate with UV inhibitor. Open surface area 25.67 square inches. 78.53 GPM. Class B load rated.
1224GR	12" x 12" Square Wave Grate	Green	8	2.68	10ND	
1224GY	12" x 12" Square Wave Grate	Gray	8	2.68	10ND	
1224	12" x 12" Square Wave Grate	Black	8	2.68	10ND	
839	Stainless Steel Screws, FH #6 x 1-3/4"	Metal	40	n/a	10ND	
(see page 72). ADA Compliant.						

CATCH BASINS

12" Catch Basin Series (continued)

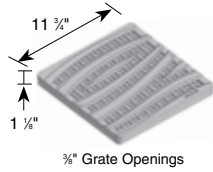

Part No.	Description	Color	Pkg. Qty.	Wt. Ea. (lbs.)	Product Class	Specifications
1224CI	12" x 12" Square Wave Cast Iron Grate	Raw Iron	1	13.90	10ND	12" Square Cast Iron Wave Grate. Open surface area 25.60 square inches. 78.31 GPM. Class B load rated.
629	Stainless Steel Screws, FH #20 x 1-1/2"	Metal	40	n/a	10ND	
	 (see page 72). ADA Compliant/Heel-proof.					

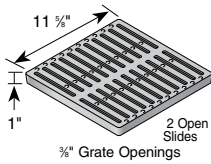

Part No.	Description	Color	Pkg. Qty.	Wt. Ea. (lbs.)	Product Class	Specifications
1213	12" x 12" Square Ductile Iron Grate	Black	1	15.30	10ND	12" Square Heavy-Duty Ductile Iron Grate. Open surface area 37.20 square inches. 113.80 GPM.
	 Use with 12" x 12" Catch Basin Series. (see page 72). ADA Compliant.					

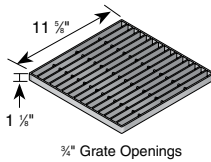

Part No.	Description	Color	Pkg. Qty.	Wt. Ea. (lbs.)	Product Class	Specifications
1215	12" x 12" Square Galvanized Steel Grate	Galvanized Steel	1	5.85	10ND	12" Square Heavy-Duty Galvanized Steel Bar Grate. Open surface area 113.78 square inches. 348.07 GPM.
	 Use with 12" x 12" Catch Basin Series. (see page 72)					

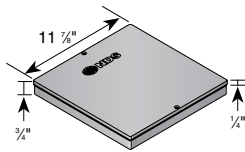

Part No.	Description	Color	Pkg. Qty.	Wt. Ea. (lbs.)	Product Class	Specifications
1220	12" x 12" Sump Pump Box	Black	8	2.23	10ND	NDS #1220, 12" Square Structural Foam Polyolefin Solid Cover.
	Use with NDS 12" x 12" Catch Basin Series and NDS #1219 Backwater Valve Box.					

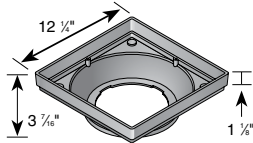

Part No.	Description	Color	Pkg. Qty.	Wt. Ea. (lbs.)	Product Class	Specifications
1230	12" x 12" Low-Profile Adapter	Black	8	1.25	10ND	12" x 12" Low-Profile Adapter. Styrene.
	Requires either #1243, #1245, #1266 or #1889 Universal Outlet for connection to 3", 4" or 6" Sewer and Drain or Corrugated Pipe. (see page 33)					

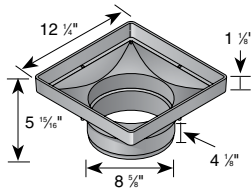

Part No.	Description	Color	Pkg. Qty.	Wt. Ea. (lbs.)	Product Class	Specifications
1221	12" x 12" Square, Low-Profile Adapter	Black	12	1.92	10ND	12" x 12" Low-Profile Adapter. Styrene.
1222	12" x 12" Square, Low-Profile Spigot Adapter	Black	12	1.92	10ND	
	Fits 8" Corrugated Pipe, Sch 40, Corrugated Spigot, S&D Hub.					

CATCH BASINS

18" Catch Basin Series

DRAINAGE

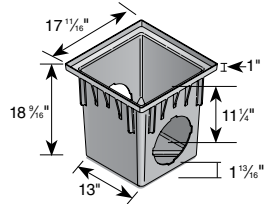

Part No.	Description	Color	Pkg. Qty.	Wt. Ea. (lbs.)	Product Class	Specifications
1882	18" One-Piece Catch Basin 2 Openings	Black	1	10.00	10ND	18"x18" One-Piece Tapered Catch Basin. Structural Foam Polyolefin.
1884	18" One-Piece Catch Basin 4 Openings	Black	1	9.65	10ND	
Requires either #1206, #1242, #1243, #1245, #1266, #1888 or #1889 Universal Outlet to connect pipe to basin. Includes 2 or 4 #1890 Reducer Rings.						

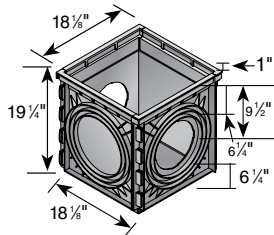

Part No.	Description	Color	Pkg. Qty.	Wt. Ea. (lbs.)	Product Class	Specifications
1800	18" x 18" Expandable Catch Basin 2 Openings*	Black	1	16.00	10ND	18" x 18" Modular Catch Basin with Locking Tabs. Styrene.
1804	18" x 18" Expandable Catch Basin 4 Openings*	Black	1	16.00	10ND	
Assembly Required. #1800 includes: 2 #1822, 2 #1820, 1 #1828. #1804 includes: 4 #1822, 1 #1828. Use #1800 and #1804 with #1206, #1243, #1245, #1266 or #1888 Universal Outlets to connect pipes to basin. Includes 2 or 4 #1890 Reducer Rings. (Note: Use Silicone to seal joints.)						

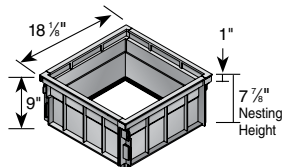

Part No.	Description	Color	Pkg. Qty.	Wt. Ea. (lbs.)	Product Class	Specifications
1816	8" Riser for 18" Catch Basin	Black	1	6.00	10ND	8" Riser for 18" x 18" Catch Basin. Styrene.
Riser package includes 4 sides. Use with #1800, #1804, #1882 or #1884.						

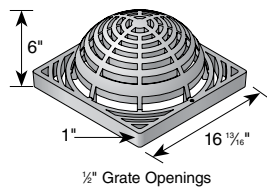

Part No.	Description	Color	Pkg. Qty.	Wt. Ea. (lbs.)	Product Class	Specifications
1881	18" x 18" Atrium Grate	Black	2	6.51	10ND	18" Structural Foam Polyolefin Dome Atrium Grate with UV inhibitor. Open surface area 89.40 square inches. 273.49 GPM.
1891	18" x 18" Atrium Grate	Green	2	6.51	10ND	
Use with 18" x 18" Catch Basin Series.						

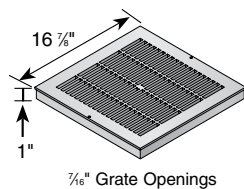

Part No.	Description	Color	Pkg. Qty.	Wt. Ea. (lbs.)	Product Class	Specifications
1810	18" x 18" Square Grate	Gray	4	7.72	10ND	18" Square Structural Foam Polyolefin Grate with UV inhibitor. Open surface area 86.31 square inches. 264.03 GPM.
1811	18" x 18" Square Grate	Black	4	7.72	10ND	
1812	18" x 18" Square Grate	Green	4	7.72	10ND	
Use with 18" x 18" Catch Basin Series. (see page 72). ADA Compliant.						

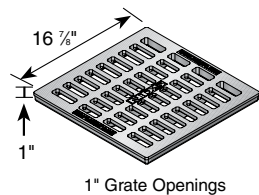

Part No.	Description	Color	Pkg. Qty.	Wt. Ea. (lbs.)	Product Class	Specifications
1813	18" x 18" Cast Iron Square Grate	Black	1	46.00	10ND	18" Square Heavy-Duty Cast Iron Grate. Open surface area 110.70 square inches. 338.65 GPM. H-20 Load Rating.
Use with 18" x 18" Catch Basin Series.						

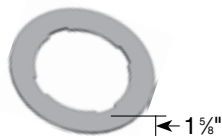

Part No.	Description	Color	Pkg. Qty.	Wt. Ea. (lbs.)	Product Class	Specifications
1890	Universal Outlet Reducer Ring	Black	8	0.33	10ND	Styrene.
Required on #1821 basin side when using 3", 4" or 6" pipe. Required on #1821 basin side when connecting to #1206, #1243, #1245, #1266 or #1889 Universal Outlets.						

CATCH BASINS

18" Catch Basin Series (continued)

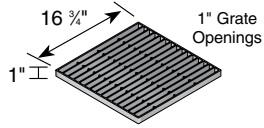

Part No.	Description	Color	Pkg. Qty.	Wt. Ea. (lbs.)	Product Class	Specifications
1815	18" Square Galvanized Steel Grate	Galvanized Steel	1	10.78	10ND	18" Square Heavy-Duty Galvanized Steel Bar Grate. Open surface area 239.00 square inches. 731.13 GPM.
 Use with 18" x 18" Catch Basin Series. (see page 72)						

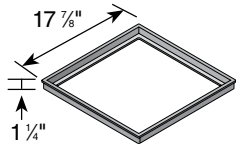

Part No.	Description	Color	Pkg. Qty.	Wt. Ea. (lbs.)	Product Class	Specifications
1840	Frame to adapt 18" x 18" grate to concrete catch basin	Black	4	2.00	10ND	18" x 18" Frame. Styrene.
Use with 18" x 18" Grates.						

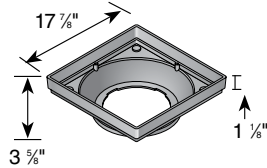

Part No.	Description	Color	Pkg. Qty.	Wt. Ea. (lbs.)	Product Class	Specifications
1830	18" x 18" Low-Profile Adapter	Black	4	4.75	10ND	18" x 18" Low-Profile Adapter. Styrene.
Includes NDS #1890 Reducer Ring. Requires either an NDS #1243, #1245, #1266 or #1888 Universal Outlet to connect to pipe.						

18" Component Parts

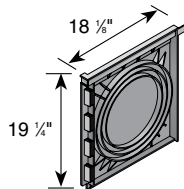

Part No.	Description	Color	Pkg. Qty.	Wt. Ea. (lbs.)	Product Class	Specifications
1820	Basin Side – No Opening	Black	4	4.00	10ND	18" x 18" Catch Basin Side, No Opening. Styrene.

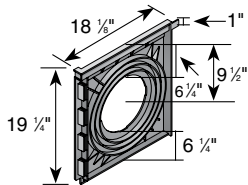

Part No.	Description	Color	Pkg. Qty.	Wt. Ea. (lbs.)	Product Class	Specifications
1821	Basin Side – 8" Opening	Black	4	4.00	10ND	18" x 18" Catch Basin Side, 8" Opening. Styrene.
Reducer Ring not included. Requires #1888 Universal Outlet to fit 8" Corrugated Pipe or Sewer and Drain Pipe or #1266 Universal Outlets. #1889 Universal Outlet does not fit this #1821 Basin Side.						

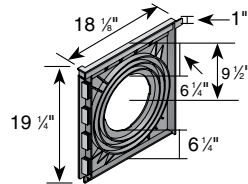

Part No.	Description	Color	Pkg. Qty.	Wt. Ea. (lbs.)	Product Class	Specifications
1822	Basin Side – 6" or 8" Opening	Black	4	3.75	10ND	18" x 18" Catch Basin Side, 6" or 8" Opening. Styrene.
Opening using Universal Outlet. Includes #1890 Reducer Ring. Use with #1206, #1242, #1243, #1245, #1266 or #1888 Universal Outlets.						

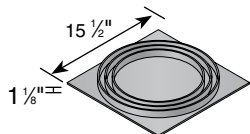

Part No.	Description	Color	Pkg. Qty.	Wt. Ea. (lbs.)	Product Class	Specifications
1828	Basin Bottom	Black	4	2.50	10ND	18" x 18" Catch Basin Bottom. Styrene.

CATCH BASINS

24" Catch Basin Series

DRAINAGE

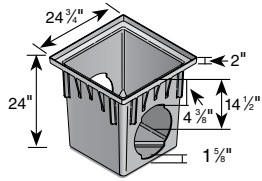

Part No.	Description	Color	Pkg. Qty.	Wt. Ea. (lbs.)	Product Class	Specifications
2400	24" x 24" Catch Basin, 2 Openings	Black	1	18.00	10ND	24" x 24" One-Piece Tapered Catch Basin. HDPE with Structural Foam.
2404	24" x 24" Catch Basin, 4 Openings Requires 2 or 4 #2410 Universal Outlets.	Black	1	15.00	10ND	

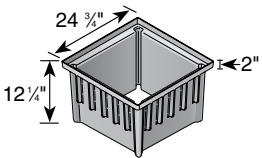

Part No.	Description	Color	Pkg. Qty.	Wt. Ea. (lbs.)	Product Class	Specifications
2418	24" x 24" Catch Basin Extension (No Bottom) Use with 24" x 24" Catch Basin Series.	Black	1	14.60	10ND	8" Extension for 24" x 24" Catch Basin. HDPE with Structural Foam.

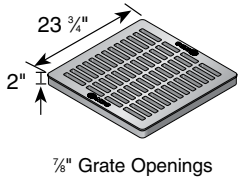

Part No.	Description	Color	Pkg. Qty.	Wt. Ea. (lbs.)	Product Class	Specifications
2411	24" x 24" Square Grate	Black	1	19.75	10ND	24" Square HDPE with Structural Foam Grate with UV inhibitor. Open surface area 231.69 square inches. 708.77 GPM.
2412	24" x 24" Square Grate Use with 24" x 24" Catch Basin Series.  (see page 72)	Green	1	19.75	10ND	

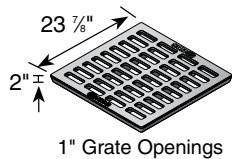

Part No.	Description	Color	Pkg. Qty.	Wt. Ea. (lbs.)	Product Class	Specifications
2413	24" x 24" Square Cast Iron Grate Use with 24" x 24" Catch Basin Series.  (see page 72)	Black	1	147.00	10ND	24" Square Heavy-Duty Cast Iron Grate. Open surface area 197.00 square inches. 602.65 GPM. Structural Foam.

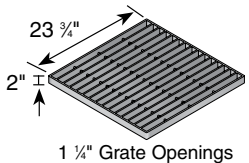

Part No.	Description	Color	Pkg. Qty.	Wt. Ea. (lbs.)	Product Class	Specifications
2415	24" x 24" Square Galvanized Steel Grate Use with 24" x 24" Catch Basin Series.  (see page 72)	Galvanized Steel	1	62.88	10ND	24" Square Heavy-Duty Galvanized Steel Bar Grate. Open surface area 422.45 square inches. 1292.33 GPM. Structural Foam.

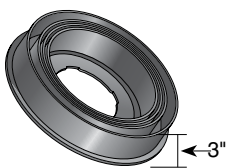

Part No.	Description	Color	Pkg. Qty.	Wt. Ea. (lbs.)	Product Class	Specifications
2410	10" & 12" Universal Adapter Includes #1890 (comes pre-inserted). Fits 10" and 12" Sewer and Drain Pipe; 10" and 12" Dual Wall Corrugated Pipe; 12" Single Wall Corrugated Pipe (does not fit 10" Single Wall Corrugated Pipe). Reduces opening to fit most 3" to 8" adapters above (all except #1889) for use with 3", 4", 6" and 8" Sewer and Drain Pipe; 3", 4", 6" and 8" Corrugated Pipe; and 4" Sch. 40 Pipe (select corresponding adapter above). Use with 24" Catch Basin Series.	Black	1	4.20	10ND	10"/12" Universal Adapter. HDPE.

CATCH BASINS

Catch Basin Universal Outlets

Universal Outlets and Adapters allow you to quickly connect to 3"-12" drain pipes to accommodate the needs of any job. They offer greater flexibility during install saving time and money.

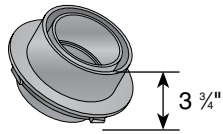

Part No.	Description	Color	Pkg. Qty.	Wt. Ea. (lbs.)	Product Class	Specifications
1242	3" & 4" Universal Outlet w/4" Spigot	Black	20	0.74	10ND	3" & 4" Universal Outlet. Styrene.
Fits 3" & 4" Corrugated Pipe, 3" & 4" Sewer and Drain Pipe, 4" Sch. 40 Pipe, 4" Triple Wall Pipe. Allows for adjusting inlet height. Use with 9", 12", 18" and 24" Catch Basin Series. Use with 24" Catch Basin also requires #2410 Adapter.						

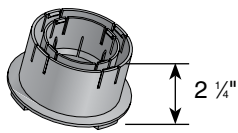

Part No.	Description	Color	Pkg. Qty.	Wt. Ea. (lbs.)	Product Class	Specifications
1243	3" & 4" Universal Locking Outlet*	Black	20	0.60	10ND	3" & 4" Patented Universal Locking Outlet. Styrene.
Fits 3" & 4" Corrugated Pipe, 3" & 4" Sewer and Drain Pipe, 4" Sch. 40 Pipe and 3" & 4" Triple Wall Pipe. Use with 9", 12", 18" and 24" Catch Basin Series and #930, #1230, #1830 and #2410 Adapters. Use with 24" Catch Basin also requires #2410 Adapter.						
*New Locking Outlet snaps on to most 3" and 4" corrugated pipe.						

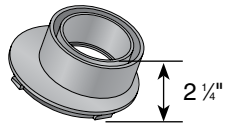

Part No.	Description	Color	Pkg. Qty.	Wt. Ea. (lbs.)	Product Class	Specifications
1245	3" & 4" Offset Universal Outlet	Black	20	0.50	10ND	3" & 4" Offset Universal Outlet. Styrene.
Fits 3" & 4" Corrugated Pipe, 3" & 4" Sewer and Drain Pipe, 4" Sch. 40 Pipe, 4" Triple Wall Pipe. Allows for adjusting inlet height. Use with 9", 12", 18" and 24" Catch Basin Series. Use with 24" Catch Basin also requires #2410 Adapter.						

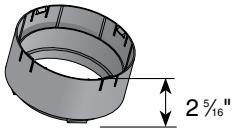

Part No.	Description	Color	Pkg. Qty.	Wt. Ea. (lbs.)	Product Class	Specifications
1266	6" Universal Locking Outlet*	Black	20	0.55	10ND	6" Universal Locking Outlet. Styrene.
Fits 6" Sewer and Drain Pipe, 6" Corrugated Pipe. Use with 9", 12", 18" and 24" Catch Basin Series and #930, #1230 and #1830 Low-Profile Adapters. Use with 24" Catch Basin also requires #2410 Adapter.						
*New, improved Locking Outlet snaps on to most 6" corrugated pipe.						

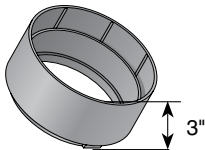

Part No.	Description	Color	Pkg. Qty.	Wt. Ea. (lbs.)	Product Class	Specifications
1888	8" Universal Outlet	Black	8	1.05	10ND	8" Universal Outlet. Styrene.
Fits 8" Sewer and Drain Pipe, 8" Corrugated Pipe. Use with 18" and 24" Catch Basin Series. Use with 24" Catch Basin also requires #2410 Adapter.						

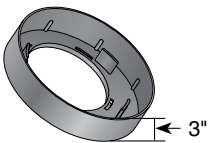

Part No.	Description	Color	Pkg. Qty.	Wt. Ea. (lbs.)	Product Class	Specifications
1889	8" Offset Universal Adapter	Black	10	0.74	10ND	8" Offset Universal Adapter. Styrene.
Fits 8" Sewer and Drain Pipe, 8" Corrugated Pipe. Use with 12" and most 18" Catch Basin Series (except 1800 and 1804).						

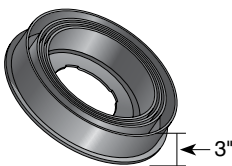

Part No.	Description	Color	Pkg. Qty.	Wt. Ea. (lbs.)	Product Class	Specifications
2410	10" & 12" Universal Adapter	Black	1	4.20	10ND	10"/12" Universal Adapter. HDPE.
Includes #1890 (comes pre-inserted). Fits 10" and 12" Sewer and Drain Pipe; 10" and 12" Dual Wall Corrugated Pipe; 12" Single Wall Corrugated Pipe (does not fit 10" Single Wall Corrugated Pipe). Reduces opening to fit most 3" to 8" adapters above (all except #1889) for use with 3", 4", 6" and 8" Sewer and Drain Pipe; 3", 4", 6" and 8" Corrugated Pipe; and 4" Sch. 40 Pipe (select corresponding adapter above). Use with 24" Catch Basin Series.						

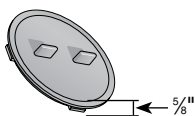

Part No.	Description	Color	Pkg. Qty.	Wt. Ea. (lbs.)	Product Class	Specifications
1206	6" Universal Adapter Plug	Black	20	0.35	10ND	Universal Plug. Styrene.

DRAINAGE

POP-UP DRAINAGE EMITTERS

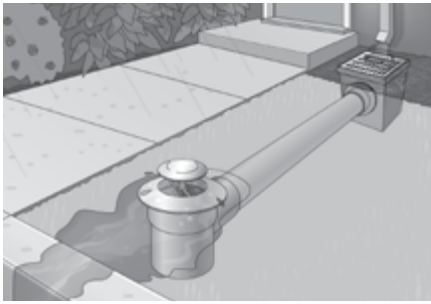

The Pop-up Drainage Emitter is an easy, safe and efficient solution that allows water to be diverted and released to water-safe areas away from structures, erosion-prone landscapes and poor drainage areas.

Pop-up Drainage Emitters allow water captured by grates, catch basins, channel drains, Flo-Well, EZflow, downspouts and roof gutter systems to flow through drainage pipe and away from structural foundations to safe or useful areas. For example, water can be routed from a low area next to a foundation to a water-safe area in the landscape, or a curbside drainage system where allowed. The emitter opens under minimal hydrostatic pressure from water through upstream drainage pipes; the emitter closes as flow diminishes. The special patented design allows the Emitter to open with even the smallest flows. Since the Emitter is closed during dry weather, debris and rodents cannot enter the drain pipes. Spring automatically retracts – closes and prevents damage from lawn mowers. It's flat profile blends discreetly into the surrounding landscapes.

3" & 4" Pop-up Drainage Emitter

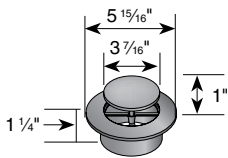

Part No.	Description	Color	Pkg. Qty.	Wt. Ea. (lbs.)	Product Class	Specifications
420	3" & 4" Pop-up Drainage Emitter Fits 3" and 4" Sewer and Drain Fittings. Ideal for discharging excess water from stormwater management system. Spring automatically retracts.	Green	20	0.28	10ND	3" and 4" polyolefin spring-loaded Pop-up Drainage Emitter with UV inhibitor. 40 GPM capacity. 0.04 psi or 1" of head to raise top.

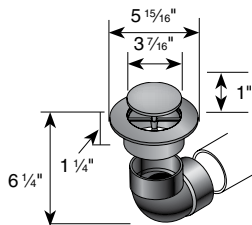

Part No.	Description	Color	Pkg. Qty.	Wt. Ea. (lbs.)	Product Class	Specifications
321	Emitter with 3" Elbow Fits 3" Sewer and Drain Pipe. Ideal for discharging excess water from stormwater management system. Spring automatically retracts.	Green	25	0.60	10ND	NDS #420 polyolefin spring-loaded Pop-up Drainage Emitter with UV inhibitor, 3" styrene 90 degree elbow with 1/4" drain hole. 40 GPM. 0.04 psi or 1" of head to raise top.

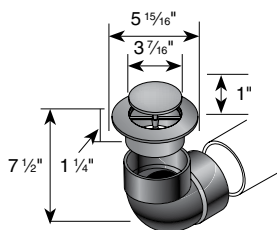

Part No.	Description	Color	Pkg. Qty.	Wt. Ea. (lbs.)	Product Class	Specifications
421	Emitter with 4" Elbow Fits 4" Sewer and Drain Pipe. Ideal for discharging excess water from stormwater management system. Spring automatically retracts.	Green	20	0.85	10ND	NDS #420 polyolefin spring-loaded Pop-up Drainage Emitter with UV inhibitor, 4" styrene 90 degree elbow with 1/4" drain hole. 40 GPM. 0.04 psi or 1" of head to raise top.

POP-UP DRAINAGE EMITTERS

3" & 4" Pop-up Drainage Emitter (continued)

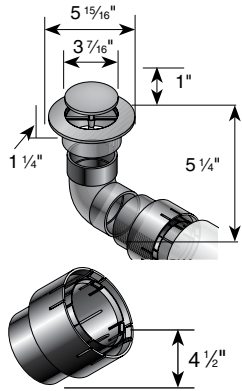

Part No.	Description	Color	Pkg. Qty.	Wt. Ea. (lbs.)	Product Class	Specifications
430	Pop-up Drainage Emitter with 3" Elbow and Universal Adapter	Green	20	1.00	10ND	NDS #420 polyolefin spring-loaded Pop-up Drainage Emitter with UV inhibitor, 3" styrene 90 degree elbow with 1/4" drain hole and universal pipe adapter. 40 GPM. 0.04 psi or 1" of head to raise top.
1241	3" & 4" Universal Adapter w/4" Spigot	Blacj	20	0.70	10ND	3" & 4" Patented Universal Adapter. Styrene.

6" Pop-up Drainage Emitter

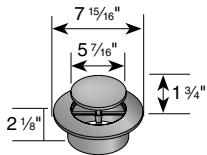

Part No.	Description	Color	Pkg. Qty.	Wt. Ea. (lbs.)	Product Class	Specifications
620	6" Pop-up Drainage Emitter	Green	15	0.61	10ND	6" polyolefin spring-loaded Pop-up Drainage Emitter with UV inhibitor. 88 GPM capacity. 0.04 psi or 1" of head to raise top.

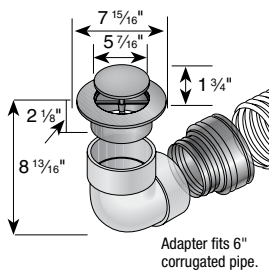

Part No.	Description	Color	Pkg. Qty.	Wt. Ea. (lbs.)	Product Class	Specifications
624	6" Pop-up Emitter with Elbow and Corrugated Pipe Adapter	Green	10	3.45	10ND	NDS #620 polyolefin spring-loaded Pop-up Drainage Emitter with UV inhibitor, 6" styrene 90 degree elbow with 1/4" drain hole and corrugated pipe adapter. 88 GPM. 0.04 psi or 1" of head to raise top.

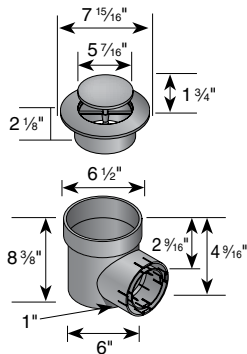

Part No.	Description	Color	Pkg. Qty.	Wt. Ea. (lbs.)	Product Class	Specifications
625	6" Pop-up Emitter with Spee-D® Basin	Green	8	2.21	10ND	NDS #620 polyolefin spring-loaded Pop-up Drainage Emitter with UV inhibitor and Spee-D basin. 88 GPM. 0.04 psi or 1" of head to raise top.

DRAINAGE

COMMON DRAINAGE FITTINGS

90 Degree PVC Elbow

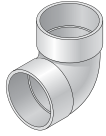

	Part No.	Description	Color	Pkg. Qty.	Wt. Ea. (lbs.)	Product Class
PVC	3P02	3" PVC 90 Degree Elbow (HUB x HUB)	White	40	0.40	30PV
	4P02	4" PVC 90 Degree Elbow (HUB x HUB)	White	25	0.68	30PV
	6P02	6" PVC 90° Elbow (HUB x HUB)	White	12	3.00	30PV

DRAINAGE

Corrugated Adapter

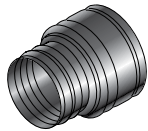

Part No.	Description	Color	Pkg. Qty.	Wt. Ea. (lbs.)	Product Class
351	3" Polyethylene Corrugated Adapter (CORR HUB x S&D SPT or HUB)	Black	50	0.10	30ST
451	4" Polyethylene Corrugated Adapter (CORR HUB x S&D SPT or HUB)	Black	25	0.20	30ST
651	6" Polyethylene Corrugated Adapter (CORR HUB x S&D SPT or HUB)	Black	12	0.25	30ST

Corrugated Internal Couplings

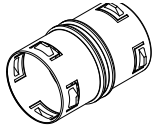

Part No.	Description	Color	Pkg. Qty.	Wt. Ea. (lbs.)	Product Class
3C05	3" Corrugated Coupling	Black	60	0.07	30PE
4C07	4" Corrugated Coupling	Black	36	0.08	30PE
6C07	6" Corrugated Coupling	Black	12	0.08	30PE

Corrugate End Caps

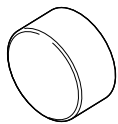

Part No.	Description	Color	Pkg. Qty.	Wt. Ea. (lbs.)	Product Class
3C06	3" Corrugated Endcap	Black	33	0.05	30PE
4C06	4" Corrugated Endcap	Black	30	0.06	30PE
6C06	6" Corrugated Endcap	Black	15	0.50	30PE

Note: See Fittings section (pages 156-173) for additional fitting options.

GRATES: STANDARD, DECORATIVE & METAL

Brass & Chrome Grates

DRAINAGE

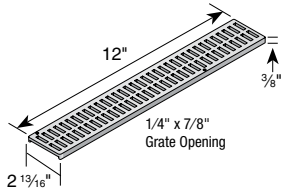

Part No.	Description	Color	Pkg. Qty.	Wt. Ea. lbs.	Product Class	Specifications
552B	1 ft. Brass Channel Grate	Satin Brass	12	1.21	25PF	1 foot Mini Channel Solid Brass Grate with brass screws. Open surface area 9.20 square inches per foot. 28.14 GPM per foot.
553PB	1 ft. Brass Channel Grate	Polished Brass	12	1.21	25PF	
 Fits #500 and #550 Mini Channels. (see pages 50). (see page 72). ADA Compliant/Heel-proof.						

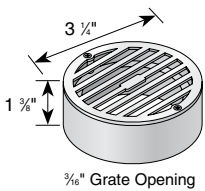

Part No.	Description	Color	Pkg. Qty.	Wt. Ea. lbs.	Product Class	Specifications
909B	3" Round Brass Grate w/PVC Collar	Satin Brass	20	0.40	15BR	3" Round Solid Brass Grate and brass screws with PVC collar. Open surface area 2.68 square inches. 8.20 GPM.
905PB	3" Round Brass Grate w/PVC Collar	Polished Brass	20	0.40	15BR	
 Fits 2" SCH-40 Pipe and 3" Sewer and Drain Fittings. (see page 72). ADA Compliant/Heel-proof.						

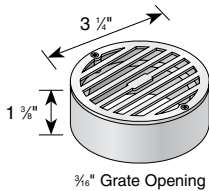

Part No.	Description	Color	Pkg. Qty.	Wt. Ea. lbs.	Product Class	Specifications
915SC	3" Round Chrome Grate w/PVC Collar	Satin Chrome	20	0.40	15BR	3" Round Solid Chrome Grate and screws with PVC collar. Open surface area 2.68 square inches. 8.20 GPM.
907PB	3" Round Chrome Grate w/PVC Collar	Polished Chrome	20	0.40	15BR	
 Fits 3" Sewer and Drain Fittings and 2" SCH-40 Pipe. (see page 72). ADA Compliant/Heel-proof.						

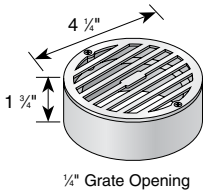

Part No.	Description	Color	Pkg. Qty.	Wt. Ea. lbs.	Product Class	Specifications
910B	4" Round Brass Grate w/PVC Collar	Satin Brass	20	0.64	15BR	4" Round Solid Brass Grate and brass screws with PVC collar. Open surface area 5.25 square inches. 16.06 GPM.
906PB	4" Round Brass Grate w/PVC Collar	Polished Brass	20	0.64	15BR	
 Fits 3" Sewer & Drain Pipe, 4" Sewer & Drain Fittings. (see page 72). ADA Compliant/Heel-proof.						

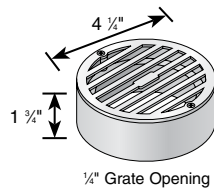

Part No.	Description	Color	Pkg. Qty.	Wt. Ea. lbs.	Product Class	Specifications
917SC	4" Round Chrome Grate w/PVC Collar	Satin Chrome	20	0.66	15BR	4" Round Chrome Grate and screws with PVC collar. Open surface area 5.25 square inches. 16.06 GPM.
908PC	4" Round Chrome Grate w/PVC Collar	Polished Chrome	20	0.66	15BR	
 Fits 3" Sewer & Drain Pipe, 4" Sewer & Drain Fittings. (see page 72). ADA Compliant/Heel-proof.						

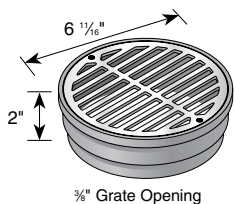

Part No.	Description	Color	Pkg. Qty.	Wt. Ea. lbs.	Product Class	Specifications
918B	6" Round Brass Grate w/Styrene Collar	Satin Brass	8	1.38	15BR	6" Round Solid Brass Grate and brass screws with styrene collar. Open surface area 13.10 square inches. 40.07 GPM.
919PB	6" Round Brass Grate w/Styrene Collar	Polished Brass	8	1.38	15BR	
 Fits Spee-D® Basin, 6" Sewer & Drain Fittings. (see page 72). ADA Compliant.						

GRATES: STANDARD, DECORATIVE & METAL

Brass & Chrome Grates (continued)

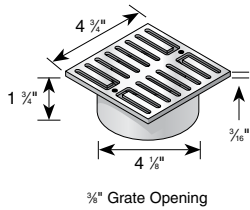

Part No.	Description	Color	Pkg. Qty.	Wt. Ea. lbs.	Product Class	Specifications
913B	5" Square Brass Grate w/PVC Collar	Satin Brass	10	1.21	15BR	5" Square Solid Brass Grate with brass screws and PVC collar. Open surface area 2.5 square inches. 7.65 GPM.
914PB	5" Square Brass Grate w/PVC Collar	Polished Brass	10	1.21	15BR	
 Fits 4" Sewer and Drain Fittings, 3" Sewer and Drain Pipe, and 3" Triple Wall Pipe. (see page 72). ADA Compliant.						

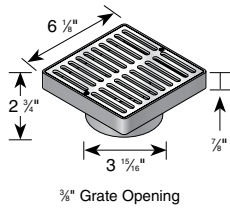

Part No.	Description	Color	Pkg. Qty.	Wt. Ea. lbs.	Product Class	Specifications
920B	6" Square Brass Grate w/Styrene Adapter	Satin Brass	8	1.65	15BR	6" Square Solid Brass Grate with brass-colored styrene low-profile adapter and brass screws. Open surface area 11.60 square inches. 35.49 GPM.
923PB	6" Square Brass Grate w/Styrene Adapter	Polished Brass	8	1.65	15BR	
 Fits 3" or 4" Sewer and Drain Pipe or Fittings, 3" or 4" Corrugated Pipe, and 3" or 4" Triple Wall Pipe. (see page 72). ADA Compliant.						

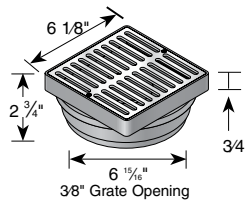

Part No.	Description	Color	Pkg. Qty.	Wt. Ea. lbs.	Product Class	Specifications
921B	6" Square Brass Grate w/Styrene Adapter	Satin Brass	8	1.71	15BR	6" Square Solid Brass Grate with brass-colored styrene low-profile adapter and brass screws. Open surface area 11.60 square inches. 35.49 GPM.
922PB	6" Square Brass Grate w/Styrene Adapter	Polished Brass	8	1.70	15BR	
 Fits Spee-D® Basin, 6" Sewer and Drain Pipe & Fittings. (see page 72). ADA Compliant.						

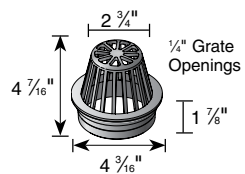

Part No.	Description	Color	Pkg. Qty.	Wt. Ea. lbs.	Product Class	Specifications
78B	4" Atrium Brass Grate	Brass	1	2.00	15BR	Open surface area 10.20 square inches. 31.20 GPM.
 Fits 4" Sewer and Drain Pipe & Fittings.						

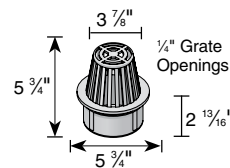

Part No.	Description	Color	Pkg. Qty.	Wt. Ea. lbs.	Product Class	Specifications
90B	6" Atrium Brass Grate	Brass	1	5.30	15BR	Open surface area 22.50 square inches. 68.83 GPM.
 Fits 6" Sewer and Drain Pipe & Fittings.						

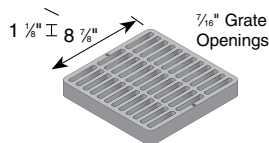

Part No.	Description	Color	Pkg. Qty.	Wt. Ea. lbs.	Product Class	Specifications
930B	9" Square Brass Grate	Brass	1	5.11	15BR	Open surface area 34.00 square inches. 104.01 GPM. Includes SS Screws.
 (see page 72). ADA Compliant.						

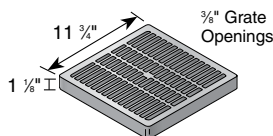

Part No.	Description	Color	Pkg. Qty.	Wt. Ea. lbs.	Product Class	Specifications
1230B	12" Square Brass Grate	Brass	1	9.24	15BR	Open surface area 42.87 square inches. 131.14 GPM. Includes SS Screws.
 (see page 72). ADA Compliant.						

GRATES: STANDARD, DECORATIVE & METAL

Decorative Grates

Designed to meet today's demand for products that are as beautiful as they are functional. NDS decorative grates feature consumer-tested designs and offer a range of colors and materials ideal for any application or setting.



DRAINAGE

Catch Basin Plastic & Metal Decorative Grates

Fits 12" Catch Basins. Available in Botanical and Wave designs, in multiple colors or in cast iron. Plastic grates are "T-top" and overlap basin edge. Iron grates sit flush.

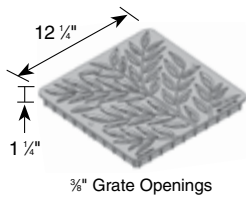

Part No.	Description	Color	Pkg. Qty.	Wt. Ea. (lbs.)	Product Class	Specifications
1218S	12" x 12" Square Botanical Grate	Sand	8	3.27	10ND	12" Square Structural Foam Polyolefin Botanical Grate with UV inhibitor. Open surface area 24.44 square inches. 74.77 GPM. Class B load rated.
1218GR	12" x 12" Square Botanical Grate	Green	8	3.27	10ND	
1218GY	12" x 12" Square Botanical Grate	Gray	8	3.27	10ND	
1218	12" x 12" Square Botanical Grate	Black	8	3.27	10ND	
839	#6 x 1-3/4 FH Phillips Screw	Metal	40	n/a	10ND	
Use Screw # 839, FH#6 x 1-3/4". (see page 72). ADA Compliant.						

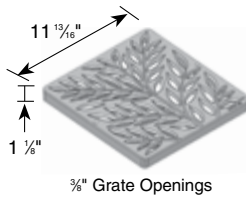

Part No.	Description	Color	Pkg. Qty.	Wt. Ea. (lbs.)	Product Class	Specifications
1218CI	12" x 12" Square Botanical Cast Iron Grate	Raw Iron	1	12.67	10ND	12" Square Cast Iron Botanical Grate. Open surface area 24.44 square inches. 74.77 GPM. Class B load rated.
629	#20 x 1-1/2 FH Phillips Screw	Metal	40	n/a	10ND	
Use Screw # 629, FH#20 x 1-1/2". (see page 72). ADA Compliant.						

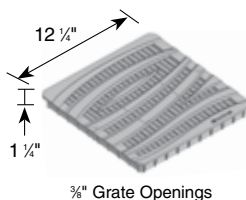

Part No.	Description	Color	Pkg. Qty.	Wt. Ea. (lbs.)	Product Class	Specifications
1224S	12" x 12" Square Wave Grate	Sand	8	2.68	10ND	12" Square Structural Foam Polyolefin Wave Grate with UV inhibitor. Open surface area 25.67 square inches. 78.53 GPM. Class B load rated.
1224GR	12" x 12" Square Wave Grate	Green	8	2.68	10ND	
1224GY	12" x 12" Square Wave Grate	Gray	8	2.68	10ND	
1224	12" x 12" Square Wave Grate	Black	8	2.68	10ND	
839	#6 x 1-3/4 FH Phillips Screw	Metal	40	n/a	10ND	
Use Screw # 839, FH#6 x 1-3/4". (see page 72). ADA Compliant.						

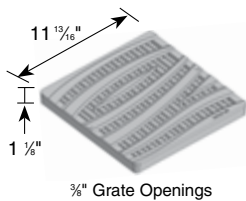

Part No.	Description	Color	Pkg. Qty.	Wt. Ea. (lbs.)	Product Class	Specifications
1224CI	12" x 12" Square Wave Cast Iron Grate	Raw Iron	1	13.90	10ND	12" Square Cast Iron Wave Grate. Open surface area 25.60 square inches. 78.31 GPM. Class B load rated.
629	#20 x 1-1/2 FH Phillips Screw	Metal	40	n/a	10ND	
Use Screw # 629, FH#20 x 1-1/2". (see page 72). ADA Compliant.						

GRATES: STANDARD, DECORATIVE & METAL

Mini Channel Plastic & Metal Decorative Grates

Fits 500 Series Mini Channel. Available in Botanical and Wave designs, in multiple colors or in cast iron. Plastic grates are "T-top" and overlap basin edge. Iron grates sit flush.

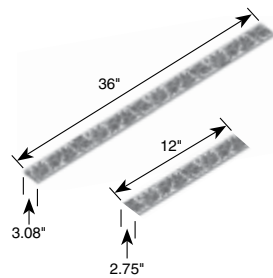

Part No.	Description	Color	Pkg. Qty.	Wt. Ea. (lbs.)	Product Class	Specifications
846	Stainless Steel Screws, FH #4 x 5/8"	Steel	64	0.10	25PF	3 ft. Structural Foam Polyolefin botanical pattern Channel Grate with UV inhibitor. Open surface area 5.44 square inches per foot. 16.64 GPM per foot.
554S	3' Botanical Channel Grate	Sand	16	0.89	25PF	
554GR	3' Botanical Channel Grate	Green	16	0.89	25PF	
554GY	3' Botanical Channel Grate	Gray	16	0.89	25PF	
553	3' Botanical Channel Grate	Black	16	0.89	25PF	
554CI	1' Botanical Cast Iron Channel Grate	Raw Iron	1	1.82	10ND	1 ft. Mini Channel botanical Cast Iron Channel Grate. Open surface area 5.39 square inches per foot. 16.49 GPM per foot. Class B load rated.
629	#20 x 1-1/2 FH Phillips Screw	Metal	40	n/a	10ND	
 (see page 72), ADA Compliant.						

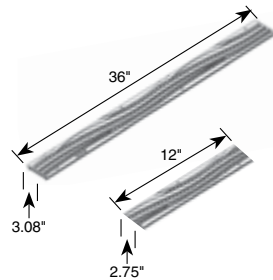

Part No.	Description	Color	Pkg. Qty.	Wt. Ea. (lbs.)	Product Class	Specifications
846	Stainless Steel Screws, FH #4 x 5/8"	Steel	64	0.10	25PF	3 ft. Structural Foam Polyolefin wave pattern Channel Grate with UV inhibitor. Open surface area 5.73 square inches per foot. 17.54 GPM per foot.
555S	3' Wave Channel Grate	Sand	16	0.88	25PF	
555GR	3' Wave Channel Grate	Green	16	0.88	25PF	
555GY	3' Wave Channel Grate	Gray	16	0.88	25PF	
555	3' Wave Channel Grate	Black	16	0.88	25PF	
555CI	1' Wave Cast Iron Channel Grate	Raw Iron	1	1.30	10ND	1 ft. Mini Channel Wave Cast Iron Channel Grate. Open surface area 4.11 square inches per foot. 12.56 GPM per foot. Class B load rated.
629	#20 x 1-1/2 FH Phillips Screw	Metal	40	n/a	10ND	
 (see page 72), ADA Compliant.						

Spee-D® Channel Plastic & Metal Decorative Grates

Fits Spee-D® Channel. Available in Botanical and Wave designs, in multiple colors or in cast iron. Plastic grates are "T-top" and overlap basin edge. Iron grates sit flush.

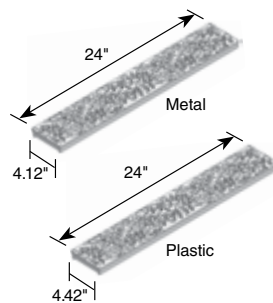

Part No.	Description	Color	Pkg. Qty.	Wt. Ea. (lbs.)	Product Class	Specifications
829	Stainless Steel Screws, FH #8 x 1"	Steel	48	0.06	25PF	2 ft. Structural Foam Polyolefin decorative botanical Channel Grate with UV inhibitor. Open surface area 7.78 square inches per foot. 23.80 GPM per foot.
252S	2' Channel Botanical Grate	Sand	24 ft.	1.74	25PF	
252GR	2' Channel Botanical Grate	Green	24 ft.	1.74	25PF	
252GY	2' Channel Botanical Grate	Gray	24 ft.	1.74	25PF	
252	2' Channel Botanical Grate	Black	24 ft.	1.74	25PF	
252CI	2' Cast Iron Channel Botanical Grate	Raw Iron	1 ft.	7.06	25PF	2 ft. Cast Iron decorative botanical Channel Grate. Open surface area 8.99 square inches per foot. 27.50 GPM per foot. Class B load rated.
629	#20 x 1-1/2 FH Phillips Screw	Metal	40	n/a	10ND	
 (see page 72), ADA Compliant.						

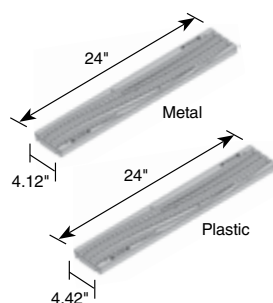

Part No.	Description	Color	Pkg. Qty.	Wt. Ea. (lbs.)	Product Class	Specifications
829	Stainless Steel Screws, FH #8 x 1"	Steel	48	0.06	25PF	2 ft. Structural Foam Polyolefin decorative wave Channel Grate with UV inhibitor. Open surface area 7.78 square inches per foot. 23.80 GPM per foot.
253S	2' Channel Wave Grate	Sand	24 ft.	1.84	25PF	
253GR	2' Channel Wave Grate	Green	24 ft.	1.84	25PF	
253GY	2' Channel Wave Grate	Gray	24 ft.	1.84	25PF	
253	2' Channel Wave Grate	Black	24 ft.	1.84	25PF	
253CI	2' Cast Iron Channel Wave Grate	Raw Iron	2 ft.	7.52	25PF	2 ft. Cast Iron decorative wave Channel Grate. Open surface area 7.41 square inches per foot. 22.67 GPM per foot. Class B load rated.
629	#20 x 1-1/2 FH Phillips Screw	Metal	40	n/a	10ND	
 (see page 72), ADA Compliant.						

DRAINAGE

GRATES: STANDARD, DECORATIVE & METAL

Dura Slope Metal Decorative Grates

Fits all Dura Slope channels. Available in five designs: Weave, Tile, Brick, Diamond and Slot. Ductile iron material, rated Class D and ADA compliant.

DRAINAGE

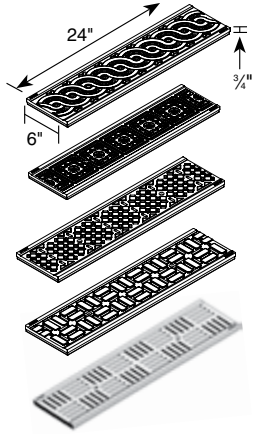

Part No.	Description	Color	Pkg. Qty.	Wt. Ea. (lbs.)	Product Class	Specifications
DS-601	Weave Pattern	Raw Iron	1	14.50	25DS	Decorative grates are made of ductile iron. Weave: open area 6.75 square inches per foot; 20.65 GPM. Diamond: open area 9.55 square inches per foot; 29.21 GPM. Tile: open area 7.95 square inches per foot; 24.32 GPM. Brick: open area 11.35 square inches per foot; 34.725 GPM. Deco slot: open area 16.75 square inches per foot; 51.24 GPM.
DS-602	Diamond Pattern	Raw Iron	1	14.30	25DS	
DS-603	Tile Pattern	Raw Iron	1	14.70	25DS	
DS-604	Brick Pattern	Raw Iron	1	14.30	25DS	
DS-609	Deco Slot	Raw Iron	1	14.50	25DS	
<p>Use with Dura Slope Drains (page 51), Dura Slope Catch Basins (page 53).</p> <p>Decorative grates are made of ductile iron. Uncoated raw iron will develop a rust patina over time. Additional powder-coat colors available: Black (K), White (W), Silver (S), Bronze (Z), Green (G), Blue (B), Orange (O), Gray (Y), Brown (N)</p> <p>MTO 6-7 week lead time.</p> <p>(see page 72). ADA Compliant/Heelproof. Must be used with DS-200H to achieve Class D Load Rating.</p>						

Round Grates

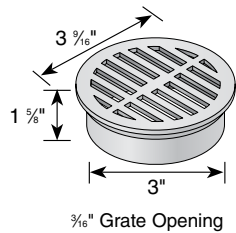

Part No.	Description	Color	Pkg. Qty.	Wt. Ea. lbs.	Product Class	Specifications
14	3" Round Grate	Black	40	0.13	10ND	3" Round Structural Foam Polyolefin Grate with UV inhibitor. Open surface area 2.60 square inches. 7.95 GPM.
15	3" Round Grate	Gray	40	0.13	10ND	
16	3" Round Grate	Green	40	0.13	10ND	
16P	3" Round Grate	Purple	40	0.13	10ND	
16S	3" Round Grate	Sand	40	0.13	10ND	
<p>Fits 3" Sewer and Drain Pipe & Fittings, 3" Corrugated Pipe, and 3" Triple Wall Pipe.</p> <p>(see page 72). ADA Compliant/Heel-proof.</p>						

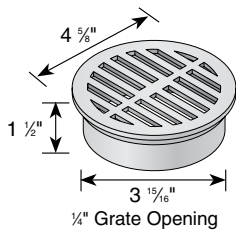

Part No.	Description	Color	Pkg. Qty.	Wt. Ea. lbs.	Product Class	Specifications
11	4" Round Grate	Black	25	0.17	10ND	4" Round Structural Foam Polyolefin Grate with UV inhibitor. Open surface area 3.85 square inches. 11.78 GPM.
12	4" Round Grate	Gray	25	0.17	10ND	
13	4" Round Grate	Green	25	0.17	10ND	
13P	4" Round Grate	Purple	25	0.17	10ND	
13S	4" Round Grate	Sand	25	0.17	10ND	
<p>Fits 4" Sewer and Drain Pipe & Fittings, 4" Corrugated Pipe, and 4" Triple Wall Pipe.</p> <p>(see page 72). ADA Compliant/Heel-proof.</p>						

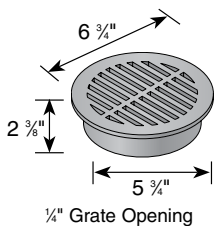

Part No.	Description	Color	Pkg. Qty.	Wt. Ea. lbs.	Product Class	Specifications
40	6" Round Grate	Black	10	0.49	10ND	6" Round Structural Foam Polyolefin Grate with UV inhibitor. Open surface area 9.10 square inches. 27.84 GPM.
50	6" Round Grate	Green	10	0.49	10ND	
60	6" Round Grate	Gray	10	0.49	10ND	
60S	6" Round Grate	Sand	10	0.49	10ND	
<p>Fits Spee-D® Basin, 6" Sewer and Drain Pipe & Fittings and 6" Corrugated Pipe.</p> <p>(see page 72). ADA Compliant/Heel-proof.</p>						

GRATES: STANDARD, DECORATIVE & METAL

Round Grates

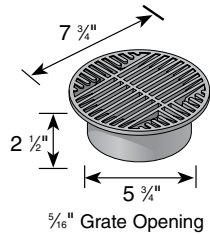

Part No.	Description	Color	Pkg. Qty.	Wt. Ea. lbs.	Product Class	Specifications
10	8" Round Grate	Black	10	0.60	10ND	8" Round Structural Foam Polyolefin Grate with UV inhibitor. Open surface area 11.50 square inches. 35.18 GPM.
20	8" Round Grate	Green	10	0.60	10ND	
30	8" Round Grate	Gray	10	0.60	10ND	
30S	8" Round Grate	Sand	10	0.60	10ND	
 Fits Spee-D® Basin, 6" Sewer and Drain Pipe & Fittings and 6" Corrugated Pipe. (see page 72). ADA Compliant.						

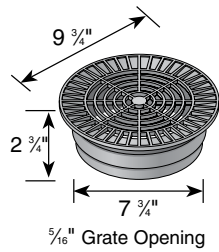

Part No.	Description	Color	Pkg. Qty.	Wt. Ea. lbs.	Product Class	Specifications
1040	10" Round Grate	Black	10	1.01	10ND	10" Round Structural Foam Polyolefin Grate with UV inhibitor. Open surface area 21.57 square inches. 65.99 GPM.
1050	10" Round Grate	Green	10	1.01	10ND	
1060	10" Round Grate	Gray	10	1.01	10ND	
1060S	10" Round Grate	Sand	10	1.01	10ND	
 Fits 8" Sewer and Drain Pipe & Fittings, 8" Corrugated Pipe. (see page 72). ADA Compliant.						

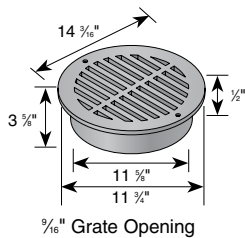

Part No.	Description	Color	Pkg. Qty.	Wt. Ea. lbs.	Product Class	Specifications
1240	12" Round Grate	Black	6	2.44	10ND	12" Round Structural Foam Polyolefin Grate with UV inhibitor. Open surface area 46.00 square inches. 140.72 GPM.
1250	12" Round Grate	Green	6	2.44	10ND	
1260	12" Round Grate	Gray	6	2.44	10ND	
 Fits 12" Sewer and Drain Pipe, 12" Corrugated Pipe. (see page 72)						

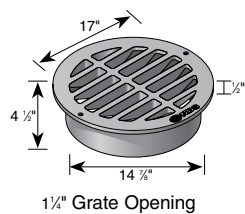

Part No.	Description	Color	Pkg. Qty.	Wt. Ea. lbs.	Product Class	Specifications
1511	15" Round Grate	Black	6	6.89	10ND	15" Round Structural Foam Polyolefin Grate with UV inhibitor. Open surface area 85.60 square inches. 261.86 GPM.
1512	15" Round Grate	Green	6	6.89	10ND	
 Fits 15" Sewer and Drain Fittings, 15" Corrugated Pipe. (see page 72)						

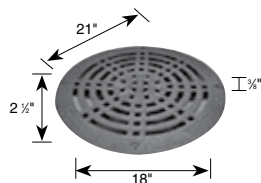

Part No.	Description	Color	Pkg. Qty.	Wt. Ea. lbs.	Product Class	Specifications
1801SDG	18" Round Grate	Green	1	7.50	28ND	Round Polypropylene Grate. Open surface area 75.55 square inches. 231.12 GPM. Includes lag bolts.
 Fits 18" Sewer and Drain Fittings, 18" Corrugated Pipe, includes Lag Bolts. (see page 72)						

GRATES: STANDARD, DECORATIVE & METAL

DRAINAGE

Atrium Grates

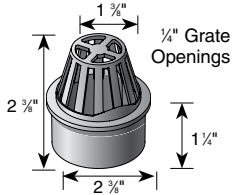

Part No.	Description	Color	Pkg. Qty.	Wt. Ea. lbs.	Product Class	Specifications
270	2" Atrium Grate	Gray	20	0.10	10ND	Flat-Top PVC Atrium Grate with UV inhibitor. Open surface area 4.00 square inches. 12.24 GPM.
Fits 2" Schedule 40 Fittings.						

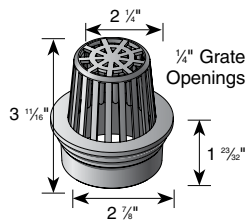

Part No.	Description	Color	Pkg. Qty.	Wt. Ea. lbs.	Product Class	Specifications
70	3" Atrium Grate	Green	20	0.16	10ND	Flat-Top Structural Foam Polyolefin Atrium Grate with UV inhibitor. Open surface area 9.40 square inches. 28.76 GPM.
72	3" Atrium Grate	Gray	20	0.16	10ND	
74	3" Atrium Grate	Black	20	0.16	10ND	
74S	3" Atrium Grate	Sand	20	0.16	10ND	
Fits 3" Sewer and Drain Pipe & Fittings, 3" Corrugated Pipe, and 3" Triple Wall Pipe.						

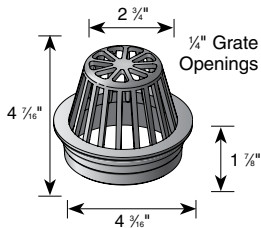

Part No.	Description	Color	Pkg. Qty.	Wt. Ea. lbs.	Product Class	Specifications
75	4" Atrium Grate	Green	20	0.21	10ND	Flat-Top Structural Foam Polyolefin Atrium Grate with UV inhibitor. Open surface area 17.00 square inches. 52.01 GPM.
76	4" Atrium Grate	Gray	20	0.21	10ND	
78	4" Atrium Grate	Black	20	0.21	10ND	
78S	4" Atrium Grate	Sand	20	0.21	10ND	
Fits 4" Sewer and Drain Pipe & Fittings, 4" Corrugated Pipe, and 4" Triple Wall Pipe.						

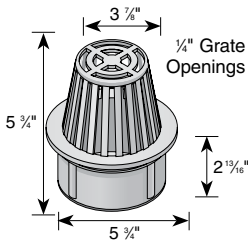

Part No.	Description	Color	Pkg. Qty.	Wt. Ea. lbs.	Product Class	Specifications
80	6" Atrium Grate	Green	10	0.62	10ND	Flat-Top Structural Foam Polyolefin Atrium Grate with UV inhibitor. Open surface area 28.40 square inches. 86.88 GPM.
81	6" Atrium Grate	Gray	10	0.62	10ND	
90	6" Atrium Grate	Black	10	0.62	10ND	
90S	6" Atrium Grate	Sand	10	0.62	10ND	
Fits Spee-D® Basin, 6" Sewer and Drain Pipe & Fittings, 6" Corrugated Pipe.						

GRATES: STANDARD, DECORATIVE & METAL

Square Grates

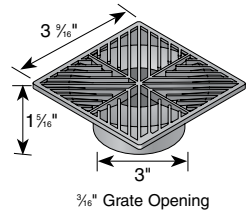

Part No.	Description	Color	Pkg. Qty.	Wt. Ea. lbs.	Product Class	Specifications
1	4" Square Grate	Green	40	0.11	10ND	4" Square Structural Foam Polyolefin Grate with diagonally converging pattern with UV inhibitor. Open surface area 3.45 square inches. 10.55 GPM.
2	4" Square Grate	Black	40	0.11	10ND	
3	4" Square Grate	Gray	40	0.11	10ND	
 Fits 3" Sewer and Drain Pipe & Fittings, 3" Corrugated Pipe, and 3" Triple Wall Pipe. (see page 72). ADA Compliant/Heel-proof.						

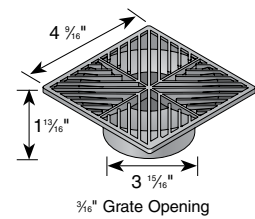

Part No.	Description	Color	Pkg. Qty.	Wt. Ea. lbs.	Product Class	Specifications
7	5" Square Grate	Green	25	0.20	10ND	5" Square Structural Foam Polyolefin Grate with diagonally converging pattern with UV inhibitor. Open surface area 4.25 square inches. 13.00 GPM.
8	5" Square Grate	Black	25	0.20	10ND	
9	5" Square Grate	Gray	25	0.20	10ND	
 Fits 4" Sewer and Drain Pipe & Fittings, 4" Corrugated Pipe, and 4" Triple Wall Pipe. (see page 72). ADA Compliant/Heel-proof.						

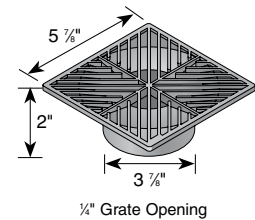

Part No.	Description	Color	Pkg. Qty.	Wt. Ea. lbs.	Product Class	Specifications
4	6" Square Grate	Black	10	0.40	10ND	6" Square Structural Foam Polyolefin Grate with diagonally converging pattern with UV inhibitor. Open surface area 10.40 square inches. 31.81 GPM.
5	6" Square Grate	Green	10	0.40	10ND	
6	6" Square Grate	Gray	10	0.40	10ND	
06S	6" Square Grate	Sand	10	0.40	10ND	
 Fits 3" or 4" Sewer and Drain Pipe, 3" or 4" Corrugated Pipe, and 3" or 4" Triple Wall Pipe. (see page 72). ADA Compliant/Heel-proof.						

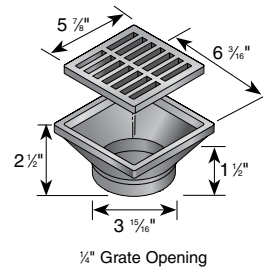

Part No.	Description	Color	Pkg. Qty.	Wt. Ea. lbs.	Product Class	Specifications
640	6" x 6" x 4" Square Grate & Adapter	Black	8	0.83	10ND	6"x6" Low-Profile Adapter and Structural Foam Polyolefin Removable Grate with UV inhibitor and stainless steel screws. Open surface area 14.44 square inches. 44.17 GPM.
641	6" x 6" x 4" Square Grate & Adapter	Green	8	0.83	10ND	
642	6" x 6" x 4" Square Grate & Adapter	Gray	8	0.83	10ND	
 Fits 3" or 4" Sewer and Drain Pipe & Fittings, 3" or 4" Corrugated Pipe, and 3" or 4" Triple Wall Pipe. (see page 72). ADA Compliant/Heel-proof.						

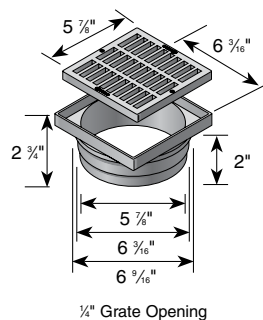

Part No.	Description	Color	Pkg. Qty.	Wt. Ea. lbs.	Product Class	Specifications
637	6" x 6" x 6" Square Grate & Adapter	Black	8	0.88	10ND	6"x6" Low-Profile Adapter and Structural Foam Polyolefin Removable Grate with UV inhibitor and stainless steel screws. Open surface area 14.44 square inches. 44.17 GPM.
639	6" x 6" x 6" Square Grate & Adapter	Gray	8	0.88	10ND	
 Fits Spee-D® Basin, 6" Sewer and Drain Pipe & Fittings. (see page 72). ADA Compliant/Heel-proof.						

GRATES: STANDARD, DECORATIVE & METAL / SPEE-D® BASINS

Square Grates (continued)

DRAINAGE

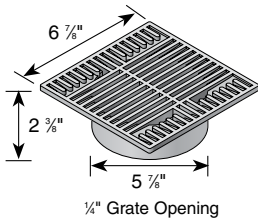

Part No.	Description	Color	Pkg. Qty.	Wt. Ea. lbs.	Product Class	Specifications	
771	7" Square Grate	Black	10	0.65	10ND	7" Square Structural Foam Polyolefin Grate with UV inhibitor. Open surface area 13.60 square inches. 41.60 GPM.	
772	7" Square Grate	Green	10	0.65	10ND		
773	7" Square Grate	Gray	10	0.65	10ND		
773S	7" Square Grate	Sand	10	0.65	10ND		
		 Fits Spee-D® Basin, 6" Sewer and Drain Pipe & Fittings, 6" Corrugated Pipe. (see page 72). ADA Compliant/Heel-proof.					

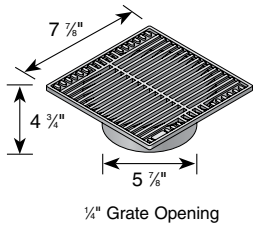

Part No.	Description	Color	Pkg. Qty.	Wt. Ea. lbs.	Product Class	Specifications	
881	8" Square Grate	Black	10	0.79	10ND	8" Square Structural Foam Polyolefin Grate with UV inhibitor. Open surface area 17.16 square inches. 52.49 GPM.	
882	8" Square Grate	Green	10	0.79	10ND		
883	8" Square Grate	Gray	10	0.79	10ND		
883S	8" Square Grate	Sand	10	0.79	10ND		
		 Fits Spee-D® Basin, 6" Sewer and Drain Pipe & Fittings, 6" Corrugated Pipe and DWV Pipe. (see page 72). ADA Compliant/Heel-proof.					

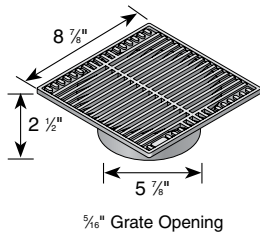

Part No.	Description	Color	Pkg. Qty.	Wt. Ea. lbs.	Product Class	Specifications	
950	9" Square Grate	Green	10	1.11	10ND	9" Square Structural Foam Polyolefin Grate with UV inhibitor. Open surface area 28.40 square inches. 86.88 GPM.	
960	9" Square Grate	Gray	10	1.11	10ND		
970	9" Square Grate	Black	10	1.11	10ND		
970S	9" Square Grate	Sand	10	1.11	10ND		
		 Fits Spee-D® Basin, 6" Sewer and Drain Pipe & Fittings, 6" Corrugated Pipe. (see page 72). ADA Compliant.					

GRATES: STANDARD, DECORATIVE & METAL

Duracast™ In-Line Grates

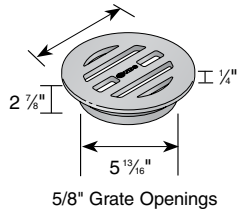

Part No.	Description	Color	Pkg. Qty.	Wt. Ea. (lbs.)	Product Class	Specifications
D6	6" Round Grate	Black	1	7.30	10ND	6" Round Heavy-Duty Ductile Grate with Black Paint. Open surface area 7.05 square inches. 21.57 GPM. H-20 load rating.
	Fits 6" Corrugated and Sewer and Drain Pipe. D6 is not a custom grate and qualifies for normal NDS freight terms. Fits SPEE-D® Basin. (see page 72)					

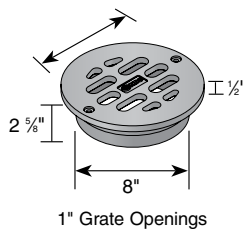

Part No.	Description	Color	Pkg. Qty.	Wt. Ea. (lbs.)	Product Class	Specifications
D8	8" Round Grate	Black	1	14.59	10ND	8" Round Heavy-Duty Ductile Iron Grate with Black Paint. Open surface area 13.98 square inches. 42.77 GPM. Bolt holes for added security. H-20 load rating.
	Fits 8" Corrugated and Sewer and Drain Pipe. D8 is not a custom grate and qualifies for normal NDS freight terms. (see page 72)					

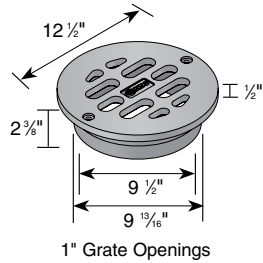

Part No.	Description	Color	Pkg. Qty.	Wt. Ea. (lbs.)	Product Class	Specifications
D10	10" Round Grate	Black	1	20.60	10ND	10" Round Heavy-Duty Ductile Iron Grate with Black Paint. Open surface area 26.82 square inches. 82.05 GPM. Bolt holes for added security. H-20 load rating.
	Fits 10" Corrugated and Sewer and Drain Pipe. D10 is not a custom grate and qualifies for normal NDS freight terms. (see page 72)					

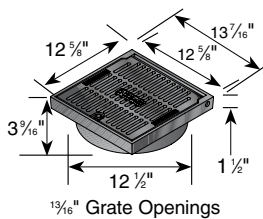

Part No.	Description	Color	Pkg. Qty.	Wt. Ea. (lbs.)	Product Class	Specifications
D12H-WO	12" Square Hinged Cast Iron Grate without Adapter	Black	1	48.00	10ND	H-20 load rating. Open surface area 48.30 square inches. 147.76 GPM.
D12	12" Round Grate	Black	1	16.00	10ND	H-20 load rating. Open surface area 55.16 square inches. 169.74 GPM.
	Fits 12" Corrugated and Sewer and Drain Pipe. (see page 72)					

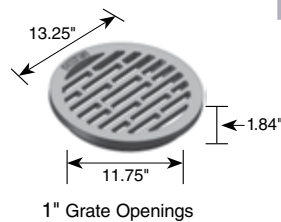

DURA SLOPE™ TRENCH DRAIN – PRE-SLOPED

Dura Slope™ Channel Drain Sections

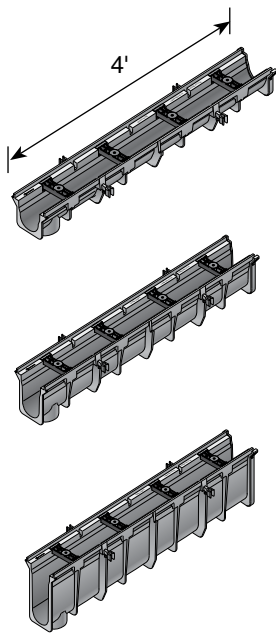

Part No.	Description	Color	Pkg. Qty.	Wt. Ea. (lbs.)	Product Class
DS-090N	3.99" Deep Neutral Dura Slope Channel	Light Gray	1	7.45	25DS
DS-091	3.99" to 4.34" Deep Dura Slope Channel	Light Gray	1	7.52	25DS
DS-091N	4.34" Deep Neutral Dura Slope Channel	Light Gray	1	7.81	25DS
DS-092	4.34" to 4.67" Deep Dura Slope Channel	Light Gray	1	7.92	25DS
DS-093	4.67" to 5.00" Deep Dura Slope Channel	Light Gray	1	8.27	25DS
DS-094	5.00" to 5.34" Deep Dura Slope Channel	Light Gray	1	8.64	25DS
DS-094N	5.34" Deep Dura Slope Channel	Light Gray	1	8.93	25DS
DS-095	5.34" to 5.68" Deep Dura Slope Channel	Light Gray	1	8.99	25DS
DS-096	5.68" to 6.01" Deep Dura Slope Channel	Light Gray	1	9.36	25DS
DS-097	6.01" to 6.35" Deep Dura Slope Channel	Light Gray	1	9.74	25DS
DS-097N	6.35" Deep Neutral Dura Slope Channel	Light Gray	1	10.04	25DS
DS-098	6.35" to 6.69" Deep Dura Slope Channel	Light Gray	1	10.11	25DS
DS-099	6.69" to 7.02" Deep Dura Slope Channel	Light Gray	1	10.48	25DS
DS-100	7.02" to 7.36" Deep Dura Slope Channel	Light Gray	1	10.86	25DS
DS-100N	7.36" Deep Neutral Dura Slope Channel	Light Gray	1	11.16	25DS
DS-101	7.36" to 7.69" Deep Dura Slope Channel	Light Gray	1	11.23	25DS
DS-102	7.69" to 8.03" Deep Dura Slope Channel	Light Gray	1	11.60	25DS
DS-103	8.03" to 8.37" Deep Dura Slope Channel	Light Gray	1	11.98	25DS
DS-103N	8.37" Deep Neutral Dura Slope Channel	Light Gray	1	12.27	25DS
DS-104	8.37" to 8.70" Deep Dura Slope Channel	Light Gray	1	12.34	25DS
DS-105	8.70" to 9.04" Deep Dura Slope Channel	Light Gray	1	12.71	25DS
DS-106	9.04" to 9.37" Deep Dura Slope Channel	Light Gray	1	13.07	25DS
DS-106N	9.37" Deep Neutral Dura Slope Channel	Light Gray	1	13.39	25DS
DS-107	9.37" to 9.70" Deep Dura Slope Channel	Light Gray	1	13.40	25DS
DS-108	9.70" to 10.05" Deep Dura Slope Channel	Light Gray	1	13.83	25DS
DS-109	10.05" to 10.38" Deep Dura Slope Channel	Light Gray	1	14.20	25DS
DS-109N	10.38" Deep Neutral Dura Slope Channel	Light Gray	1	14.50	25DS
DS-110	10.38" to 10.71" Deep Dura Slope Channel	Light Gray	1	14.57	25DS
DS-111	10.71" to 11.05" Deep Dura Slope Channel	Light Gray	1	14.95	25DS
DS-112	11.05" to 11.39" Deep Dura Slope Channel	Light Gray	1	15.32	25DS
DS-112N	11.39" Deep Neutral Dura Slope Channel	Light Gray	1	15.60	25DS
DS-113	11.39" to 11.72" Deep Dura Slope Channel	Light Gray	1	15.69	25DS
DS-114	11.72" to 12.06" Deep Dura Slope Channel	Light Gray	1	16.06	25DS

DRAINAGE

DURA SLOPE™ TRENCH DRAIN – PRE-SLOPED

Standard Grates

DRAINAGE

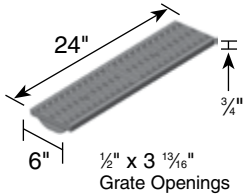

Part No.	Description	Color	Pkg. Qty.	Wt. Ea. (lbs.)	Product Class	Specifications
660	2 ft. Channel Grate	White	24 ft.	2.82	25DS	2 ft. Structural Foam Polyolefin, secured Channel Grate with UV inhibitor. Open surface area 25.40 square inches per foot. 77.70 GPM per foot.
661	2 ft. Channel Grate	Dark Gray	24 ft.	2.82	25DS	
661LG	2 ft. Channel Grate	Light Gray	24 ft.	2.82	25DS	
662	2 ft. Channel Grate	Green	24 ft.	2.82	25DS	
663	2 ft. Channel Grate	Black	24 ft.	2.82	25DS	
664	2 ft. Channel Grate	Sand	24 ft.	2.82	25DS	
665	2 ft. Channel Grate	Brick Red	24 ft.	2.82	25DS	
Use with Dura Slope Drains (page 51), Dura Slope Catch Basins (page 53). (see page 72). ADA Compliant.						

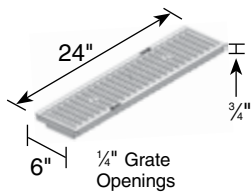

Part No.	Description	Color	Pkg. Qty.	Wt. Ea. (lbs.)	Product Class	Specifications
DS-670	2 ft. Plastic Perforated Channel Grate	Light Gray	24 ft.	2.81	25DS	2 ft. Structural Foam Polyolefin, secured Channel Grate with UV inhibitor, light traffic rated, heelproof, ADA compliant. Open surface area 8.75 square inches per foot. 26.77 GPM per foot.
DS-671	2 ft. Plastic Perforated Channel Grate	White	24 ft.	2.81	25DS	
Use with Dura Slope Drains (page 51), Dura Slope Catch Basins (page 53). (see page 72). ADA Compliant/Heelproof.						

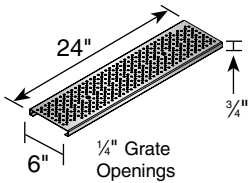

Part No.	Description	Color	Pkg. Qty.	Wt. Ea. (lbs.)	Product Class	Specifications
DS-226	2 ft. Stainless Steel Perforated Channel Grate	Steel	24 ft.	3.16	25DS	Perforated Metal Grate, pedestrian traffic rated, heelproof, ADA compliant. Open surface area 7.63 square inches per foot. 23.34 GPM per foot.
DS-228	2 ft. Galvanized Steel Perforated Channel Grate	Steel	24 ft.	3.83	25DS	
Use with Dura Slope Drains (page 51), Dura Slope Catch Basins (page 53). (see page 72). ADA Compliant/Heelproof.						

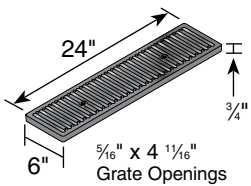

Part No.	Description	Color	Pkg. Qty.	Wt. Ea. (lbs.)	Product Class	Specifications
DS-231	2 ft. Cast Iron Channel Grate	Black	1	18.90	25DS	2 ft. heavy-duty Iron Channel Grate. Open surface area 20.85 square inches per foot. 63.78 GPM per foot. H-20 load rating.
DS-232	2 ft. Ductile Iron	Black	1	15.20	25DS	
Use with Dura Slope Drains (page 51), Dura Slope Catch Basins (page 53). (see page 72). ADA Compliant. Must be used with DS-200H to achieve Class D Load Rating.						

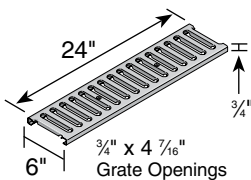

Part No.	Description	Color	Pkg. Qty.	Wt. Ea. (lbs.)	Product Class	Specifications
DS-221	2 ft. Galvanized Steel Channel Grate	Steel	24 ft.	6.64	25DS	2 ft. Galvanized Rolled Steel Grate. Open surface area 23.09 square inches per foot. 70.64 GPM per foot.
Use with Dura Slope Drains (page 51), Dura Slope Catch Basins (page 53). Includes bracket to attach grate to channel and screws. (see page 72)						

DURA SLOPE™ TRENCH DRAIN – PRE-SLOPED

Decorative Grates

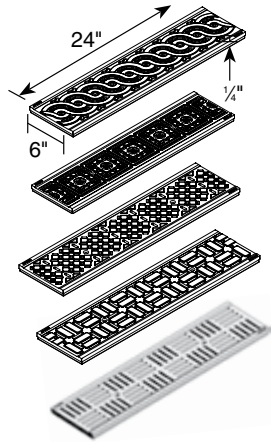

Part No.	Description	Color	Pkg. Qty.	Wt. Ea. (lbs.)	Product Class	Specifications
DS-601	Weave Pattern	Raw Iron	1	14.50	25DS	Decorative grates are made of ductile iron. Weave: open area 6.75 square inches per foot; 20.65 GPM. Diamond: open area 9.55 square inches per foot; 29.21 GPM. Tile: open area 7.95 square inches per foot; 24.32 GPM. Brick: open area 11.35 square inches per foot; 34.725 GPM. Deco slot: open area 16.75 square inches per foot; 51.24 GPM.
DS-602	Diamond Pattern	Raw Iron	1	14.30	25DS	
DS-603	Tile Pattern	Raw Iron	1	14.70	25DS	
DS-604	Brick Pattern	Raw Iron	1	14.30	25DS	
DS-609	Deco Slot	Raw Iron	1	14.50	25DS	
<p>Use with Dura Slope Drains (page 51), Dura Slope Catch Basins (see below).</p> <p>Decorative grates are made of ductile iron. Uncoated raw iron will develop a rust patina over time. Additional powder-coat colors available: Black (K), White (W), Silver (S), Bronze (Z), Green (G), Blue (B), Orange (O), Gray (Y), Brown (N)</p> <p>MTO 6-7 week lead time.</p> <p>(see page 72). ADA Compliant/Heel-proof. Must be used with DS-200H to achieve Class D Load Rating.</p>						

DRAINAGE

In-Line Catch Basin

The NDS Dura Slope™ in-line catch basin is designed to fit all depth ranges of the Dura Slope™ trench drain sections. Catch basin inlets are designed to be sized as required to accept the Dura Slope™ trench drain section. The Dura Slope™ catch basin is 2 feet long and 2 feet deep with an outlet on both sides of the basin. One Universal Adapter Plug, one blank grate insert and two grate screws are included with each Dura Slope™ in-line catch basin. The NDS universal basin outlets are used to adapt the catch basin to 3", 4", 6" and 8" pipe.

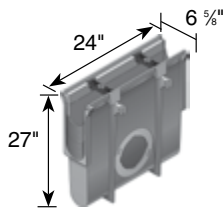

Part No.	Description	Color	Pkg. Qty.	Wt. Ea. (lbs.)	Product Class
DS-340	Dura Slope™ In-Line Catch Basins	Light Gray	1	12.00	25DS
<p>Available for use of one or two outlets. Use #1242, #1243, #1245, #1266, #1206 or #1888 Universal Outlets (see pages 32-33).</p>					

Trash Bucket

Dura Slope™ Trash Bucket is made to fit inside the Dura Slope™ Catch Basin (part number DS-340). It has a handle for easy removal to clean leaves and debris; it requires removal of the grate. Made of zinc plated steel, it is durable to climatic conditions. The Trash Bucket is not intended for use with any of the Dura Slope™ Channels. *Note: DS-240 Trash Bucket is not for use with the DS-200H Ductile Iron Frame.*

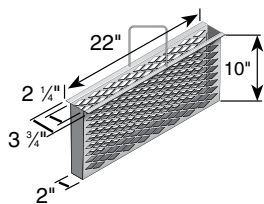

Part No.	Description	Color	Pkg. Qty.	Wt. Ea. (lbs.)	Product Class
DS-240	Dura Slope™ Trash Bucket	Steel Zinc-Plated Steel	1	5.00	25DS

DURA SLOPE™ TRENCH DRAIN – PRE-SLOPED

Accessories

DRAINAGE

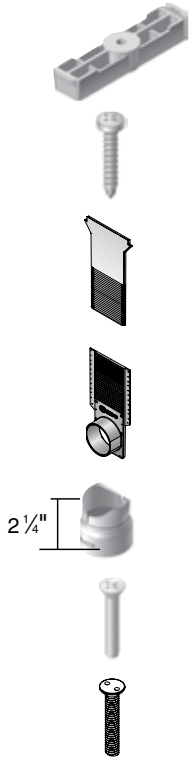

Part No.	Description	Color	Pkg. Qty.	Wt. Ea. (lbs.)	Product Class
DS-122	ProFit™ Grate Lock	Black	8	0.80	25DS
DS-123	Dura Slope Frame & End Cap Screws PH. #6	Steel	12		25DS
	Use on DS-124 Universal End Cap & DS-127 x 3/4". Universal End Outlet downstream for (male) end. Use to attach DS-200 DI Frame to Channel.				
DS-224	Universal End Cap	Gray	8	0.63	25DS
	Replaces DS-124, which will not work with DS-113 or deeper channels. Slides into upstream (female) end. Requires DS-123 screws on downstream (male) end.				
DS-227	Universal End Outlet	Gray	6	0.75	25DS
	Replaces DS-127, which will not work with DS-113 or deeper channels. Requires DS-123 screws for use on downstream (male) end. Fits to 4" S&D Pipe.				
DS-126	Bottom Outlet Adapter	Gray	6	0.53	25DS
	Fits to 4" S&D Pipe. DS-126 not required for Sch. 40 connection.				
629	Grate Screws FH # 1/4 - 20 x 1-1/2"	Steel	40	0.70	25PF
	Use with Grate # DS-231, DS-232, DS-670, DS-226 and 660-665. Use to secure grates in applications without DS-200 DI Frame				
DS-650	Flat Drilled Spanner End Cap Screws #6, 3/4"	Steel	12	1	25DS
	Drill bit included with each package.				

Ductile Iron Frame

Dura Slope Ductile Iron Frame provides a Class D load rating of 326-575 psi and is suitable for heavy-duty hard tire equipment at speeds less than 20 mph. The DS-200H Ductile Iron Frame is recommended for use with pneumatic tire traffic such as fork lifts. The ductile iron frame can be used with the cast and ductile iron grates. *Note: DS-123 screws must be ordered to secure frame to the channel.*

Part No.	Description	Color	Pkg. Qty.	Wt. Ea. (lbs.)	Product Class
DS-200H	Dura Slope™ Ductile Iron Frame	Black	2 ft.	7.50	25DS
	Use with Dura Slope Drains (page 51), Dura Slope Catch Basins (page 53). To be used with DS-231 or DS-232 grates. New Feature: 1/4" Brass Nuts to secure channel inserted. (see page 72). ADA Compliant/Heel-proof when used with DS-231 or DS-232 grates.				

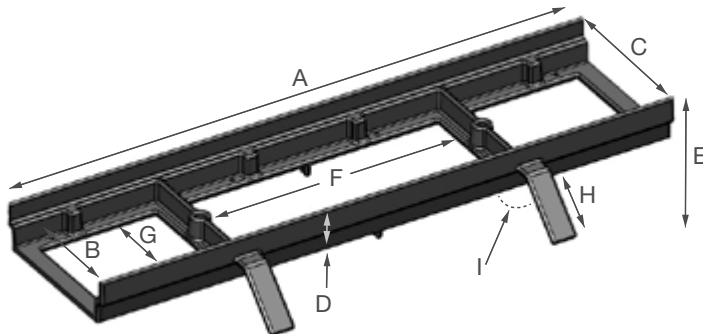

Dimension Key		
A	Length	24"
B	Inner Width	6"
C	Outer Width	6-3/8"
D	Added Profile	1" Height
E	Total Height	2-3/4"
F	Opening Length	10-3/4"
G	Opening Width	4-1/2"
H	Length of Anchor	2-5/8"
I	Angle of Anchor	30°

DURA SLOPE™ TRENCH DRAIN – PRE-SLOPED

EZ-Track™ Radius Coupling & Grates

DRAINAGE



Part No.	Description	Color	Pkg. Qty.	Wt. Ea. (lbs.)	Product Class	Specifications
DSRC-097	6.35" Deep Neutral Dura Slope™ Radius Coupling	Light Gray	6	0.81	25DS	3 degree max. deflection per coupling. Minimum inside radius of 26".
DSRC-100	7.36" Deep Neutral Dura Slope™ Radius Coupling	Light Gray	6	0.82	25DS	
DSRC-103	8.37" Deep Neutral Dura Slope™ Radius Coupling	Light Gray	6	0.83	25DS	
DSRC-106	9.37" Deep Neutral Dura Slope™ Radius Coupling	Light Gray	6	0.84	25DS	



Part No.	Description	Color	Pkg. Qty.	Wt. Ea. (lbs.)	Product Class	Specifications
DS-660MG	1.25" Plastic Slotted Radius Coupling Grate	White	6	0.15	25DS	Structural Foam Polyolefin Radius Coupling Channel Grate with UV inhibitor. Open surface area 1.88 square inches per grate. 5.75 GPM per grate.
DS-661MG	1.25" Plastic Slotted Radius Coupling Grate	Dark Gray	6	0.15	25DS	
DS-661LGMG	1.25" Plastic Slotted Radius Coupling Grate	Light Gray	6	0.15	25DS	
DS-662MG	1.25" Plastic Slotted Radius Coupling Grate	Green	6	0.15	25DS	
DS-663MG	1.25" Plastic Slotted Radius Coupling Grate	Black	6	0.15	25DS	
DS-664MG	1.25" Plastic Slotted Radius Coupling Grate	Sand	6	0.15	25DS	
DS-665MG	1.25" Plastic Slotted Radius Coupling Grate	Brick Red	6	0.15	25DS	



Part No.	Description	Color	Pkg. Qty.	Wt. Ea. (lbs.)	Product Class	Specifications
DS-681LGMG	1.25" Plastic Standard Radius Coupling Grate (no slot)	Light Gray	6	0.16	25DS	Solid Structural Foam Polyolefin Radius Coupling Channel Grate with UV inhibitor.



Part No.	Description	Color	Pkg. Qty.	Wt. Ea. (lbs.)	Product Class	Specifications
DS-232MG	1.25" Ductile Iron Radius Coupling Grate	Black	6	0.93	25DS	Ductile Iron Radius Coupling Channel Grate. Open surface area 1.88 square inches per grate. 5.75 GPM per grate.



Part No.	Description	Color	Pkg. Qty.	Wt. Ea. (lbs.)	Product Class	Specifications
DS-226MG	1.25" Perforated Stainless Steel Radius Coupling Grate	Steel	6	0.25	25DS	Stainless Steel Radius Coupling Channel Grate. Open surface area 0.86 square inches per grate. 2.63 GPM per grate.



Part No.	Description	Color	Pkg. Qty.	Wt. Ea. (lbs.)	Product Class	Specifications
DS-221MG	1.25" Galvanized Steel Radius Coupling Grate	Steel	6	0.33	25DS	Galvanized Steel Coupling Channel Grate. Open surface area 1.31 square inches per grate. 4.01 GPM per grate.

PROFILE CHANNEL DRAINS

Micro Channel™ Drains

Excellent performance at lowest possible cost. Designed for residential applications including swimming pools, spas and patios. Unique design features grate openings parallel to channel length and recessed grate for strength and effective runoff capture.

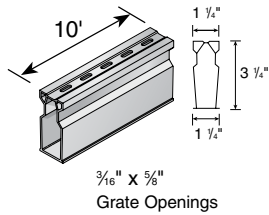

Part No.	Description	Color	Pkg. Qty.	Wt. Ea. (lbs.)	Product Class	Specifications
8001	10' Long Micro Channel	White	100 ft.	5.00	25PF	10 ft. Micro Channel with Recessed Reinforced Grate Area, Parallel Drain Slots with UV inhibitor. Open surface area 1.00 square inch per linear foot. 3.06 GPM per foot. PVC.
8002	10' Long Micro Channel	Sand	100 ft.	5.00	25PF	
8003	10' Long Micro Channel	Gray	100 ft.	5.00	25PF	
 Includes 1 coupling. (see page 72), ADA Compliant/Heel-proof.						

Micro Accessories

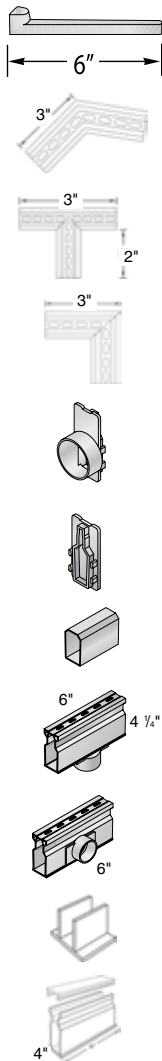

Part No.	Description	Color	Pkg. Qty.	Wt. Ea. (lbs.)	Product Class
230	6" Channel Installation Stake	Gray	24	0.04	25PF
8301	Micro Channel 45° Elbow	White	5	0.30	25PF
8302	Micro Channel 45° Elbow	Sand	5	0.30	25PF
8303	Micro Channel 45° Elbow	Gray	5	0.30	25PF
8371	Micro Channel Tee	White	5	0.40	25PF
8372	Micro Channel Tee	Sand	5	0.40	25PF
8373	Micro Channel Tee	Gray	5	0.40	25PF
8381	Micro Channel 90° Elbow	White	5	0.40	25PF
8382	Micro Channel 90° Elbow	Sand	5	0.40	25PF
8383	Micro Channel 90° Elbow	Gray	5	0.40	25PF
8461	Micro 1 1/2" Sch. 40 Spigot End Outlet	White	10	0.10	25PF
8462	Micro 1 1/2" Sch. 40 Spigot End Outlet	Sand	10	0.10	25PF
8463	Micro 1 1/2" Sch. 40 Spigot End Outlet	Gray	10	0.10	25PF
8471	Micro End Plug	White	20	0.05	25PF
8472	Micro End Plug	Sand	20	0.05	25PF
8473	Micro End Plug	Gray	20	0.05	25PF
8481	Micro Channel Couplings only Fits inside channel	White	20	0.10	25PF
8501	Micro 1 1/2" Sch. 40 Spigot Bottom Outlet	White	10	0.35	25PF
8502	Micro 1 1/2" Sch. 40 Spigot Bottom Outlet	Sand	10	0.35	25PF
8503	Micro 1 1/2" Sch. 40 Spigot Bottom Outlet	Gray	10	0.35	25PF
8511	Micro 1 1/2" Sch. 40 Spigot Side Outlet	White	10	0.35	25PF
8512	Micro 1 1/2" Sch. 40 Spigot Side Outlet	Sand	10	0.35	25PF
8513	Micro 1 1/2" Sch. 40 Spigot Side Outlet	Gray	10	0.35	25PF
8601	Micro Hold-Down Clips Use with Channel Stakes to hold channel in place	White	20	0.10	25PF
8651	Micro Channel Cleanout	White	10	0.30	25PF
8652	Micro Channel Cleanout	Sand	10	0.30	25PF
8653	Micro Channel Cleanout	Gray	10	0.30	25PF

PROFILE CHANNEL DRAINS

Mini Channel™ Drains

Excellent for light-duty applications including residential pools, concrete and paver patios, spas and tennis courts.

DRAINAGE

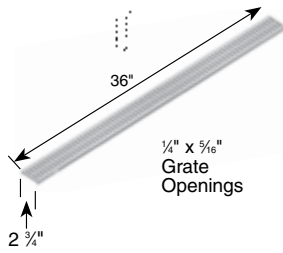

Part No.	Description	Color	Pkg. Qty.	Wt. Ea. (lbs.)	Product Class	Specifications
529	Stainless Steel Screws, FH #4 x 5/8"	Steel	64	0.10	25PF	3 ft. Structural Foam Polyolefin Channel Grate with UV inhibitor. Open surface area 9.90 square inches per foot. 30.29 GPM per foot.
540	3' Channel Grate	White	48 ft.	0.66	25PF	
541	3' Channel Grate	Gray	48 ft.	0.66	25PF	
542	3' Channel Grate	Green	48 ft.	0.66	25PF	
543	3' Channel Grate	Black	48 ft.	0.66	25PF	
544	3' Channel Grate	Sand	48 ft.	0.66	25PF	
551	3' Channel Grate	Brick Red	48 ft.	0.66	25PF	
Requires 4 screws per Grate. (see page 72). ADA Compliant/Heel-proof.						

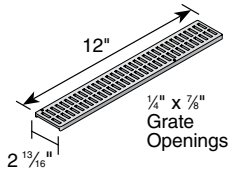

Part No.	Description	Color	Pkg. Qty.	Wt. Ea. (lbs.)	Product Class	Specifications
552B	1' Brass Channel Grate	Satin Brass	12	1.25	25PF	1 ft. Mini Channel Solid Brass Grate with brass screws. Open surface area 9.20 square inches per foot. 28.14 GPM per foot.
553PB	1' Brass Channel Grate	Polished Brass	12	1.25	25PF	
Fits #500 Mini Channel. (see page 72). ADA Compliant/Heel-proof.						

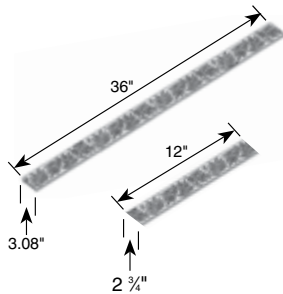

Part No.	Description	Color	Pkg. Qty.	Wt. Ea. (lbs.)	Product Class	Specifications
846	Stainless Steel Screws, FH #4 x 1"	Steel	64	0.10	25PF	3 ft. Structural Foam Polyolefin botanical pattern Channel Grate with UV inhibitor. Open surface area 5.44 square inches per foot. 16.64 GPM per foot.
554S	3' Botanical Channel Grate	Sand	16	0.89		
554GR	3' Botanical Channel Grate	Green	16	0.89		
554GY	3' Botanical Channel Grate	Gray	16	0.89		
554	3' Botanical Channel Grate	Black	16	0.89		1 ft. Mini Channel botanical Cast Iron Channel Grate. Open surface area 5.39 square inches per foot. 16.49 GPM per foot. Class B load rated.
554CI	1' Botanical Cast Iron Channel Grate	Raw Iron	1	1.82	10ND	
629	Stainless Steel Screws, FH #20 x 1-1/2"	Metal	40	n/a	10ND	
Fits #500 Mini Channel. (see page 72). ADA Compliant.						

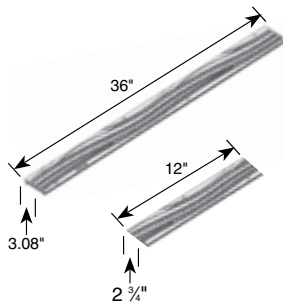

Part No.	Description	Color	Pkg. Qty.	Wt. Ea. (lbs.)	Product Class	Specifications
846	Stainless Steel Screws, FH #4 x 5/8"	Steel	64	0.10	25PF	3 ft. Structural Foam Polyolefin wave pattern Channel Grate with UV inhibitor. Open surface area 5.73 square inches per foot. 17.54 GPM per foot.
555S	3' Wave Channel Grate	Sand	16	0.88		
555GR	3' Wave Channel Grate	Green	16	0.88		
555GY	3' Wave Channel Grate	Gray	16	0.88		
555	3' Wave Channel Grate	Black	16	0.88		1 ft. Mini Channel Wave Cast Iron Channel Grate. Open surface area 4.11 square inches per foot. 12.56 GPM per foot. Class B load rated.
555CI	1' Wave Cast Iron Channel Grate	Raw Iron	1	1.30	10ND	
629	Stainless Steel Screws, FH #20 x 1-1/2"	Metal	40	n/a	10ND	
Fits #500 Mini Channel. (see page 72). ADA Compliant.						

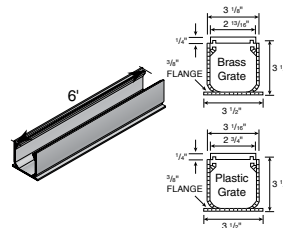

Part No.	Description	Color	Pkg. Qty.	Wt. Ea. (lbs.)	Product Class	Specifications
500	6' Mini Channel Drain	Gray	48 ft.	3.26	25PF	6 ft. PVC Mini Channel Drain with inverse flying-buttruss design, bottom flange, patented honeycomb reinforced walls and UV inhibitor.
Grate should be recessed 1/8" below finish grade in non-traffic applications. Grate should be recessed 1/4" in traffic applications.						

PROFILE CHANNEL DRAINS

Mini Channel™ Accessories

Excellent for light duty applications, including residential pools, concrete and paver patios, spas and tennis courts.

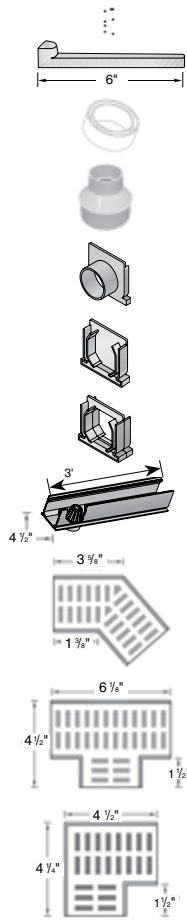

Part No.	Description	Color	Pkg. Qty.	Wt. Ea. (lbs.)	Product Class
529	Stainless Steel Screws, FH #4 x 5/8"	Steel	64	0.10	25PF
230	6" Channel Installation Stake	Gray	24	0.04	25PF
532	2" Sch. 40 Hub to 3" S&D Spigot Adapter	White	20	0.14	30PV
533	2" Sch. 40 Hub to 4" S&D Spigot Adapter	White	20	0.34	30PV
546	Spigot End Outlet for 2" Sch. 40 Pipe Fitting	Gray	10	0.15	25PF
547	3" Channel End Cap	Gray	20	0.12	25PF
548	3" Channel Coupling	Gray	20	0.12	25PF
550	3' Long Channel with 2" Sch. 40 Spigot Bottom Outlet	Gray	6	2.17	25PF
5300	Fabricated 45° Elbow with Grate	Gray	1	0.40	25PF
5303	Fabricated 45° Elbow with Grate	Sand	1	0.40	25PF
5370	Fabricated Tee with Grate	Gray	1	0.50	25PF
5372	Fabricated Tee with Grate	Black	1	0.50	25PF
5374	Fabricated Tee with Grate	Brick Red	1	0.50	25PF
5380	Fabricated 90° Elbow with Grate	Gray	1	0.40	25PF
5383	Fabricated 90° Elbow with Grate	Sand	1	0.40	25PF

DRAINAGE

Mini Channel™ Paver Installation

NDS Mini Channel and grates are dimensionally compatible with standard 2-3/8" clay and concrete paving systems. Both decorative and standard grate options make Mini Channel an ideal choice for drainage on paver parking courts, patios and plazas.



PROFILE CHANNEL DRAINS

Spee-D® Channel Drains

Ideal for commercial as well as residential applications. Effective in everything from patios to light vehicular traffic areas.

DRAINAGE

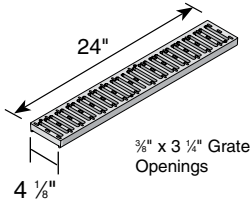

Part No.	Description	Color	Pkg. Qty.	Wt. Ea. (lbs.)	Product Class	Specifications
229	Stainless Steel Screws, FH #8 x 1"	Steel	48	0.06	25PF	2 ft. Structural Foam Polyolefin Secured Channel Grate with UV inhibitor. Open surface area 16.76 square inches per foot. 51.27 GPM per foot.
240	2' Channel Grate	White	24 ft.	1.33	25PF	
241	2' Channel Grate	Gray	24 ft.	1.33	25PF	
242	2' Channel Grate	Green	24 ft.	1.33	25PF	
243	2' Channel Grate	Black	24 ft.	1.33	25PF	
244	2' Channel Grate	Sand	24 ft.	1.33	25PF	
251	2' Channel Grate	Brick Red	24 ft.	1.42	25PF	
(see page 72). ADA Compliant.						

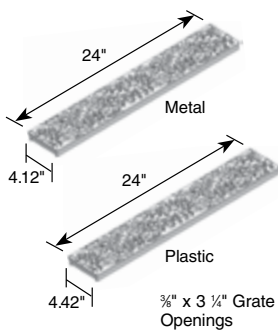

Part No.	Description	Color	Pkg. Qty.	Wt. Ea. (lbs.)	Product Class	Specifications
829	Stainless Steel Screws, FH #8 x 1-1/4"	Steel	48	0.06	25PF	2 ft. Structural Foam Polyolefin decorative botanical Channel Grate with UV inhibitor. Open surface area 7.78 square inches per foot. 23.80 GPM per foot.
252S	2' Channel Botanical Grate	Sand	24 ft.	1.74		
252GR	2' Channel Botanical Grate	Green	24 ft.	1.74		
252GY	2' Channel Botanical Grate	Gray	24 ft.	1.74		
252	2' Channel Botanical Grate	Black	24 ft.	1.74		2 ft. Cast Iron decorative botanical Channel Grate. Open surface area 8.99 square inches per foot. 27.50 GPM per foot. Class B load rated.
252CI	2' Cast Iron Channel Botanical Grate	Raw Iron	2 ft.	7.06		
629	Stainless Steel Screws, FH #20 x 1-1/2"	Metal	40	n/a	10ND	
(see page 72). ADA Compliant.						

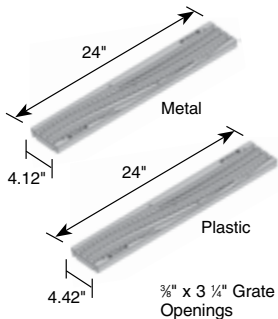

Part No.	Description	Color	Pkg. Qty.	Wt. Ea. (lbs.)	Product Class	Specifications
829	Stainless Steel Screws, FH #8 x 1-1/4"	Steel	48	0.06	25PF	2 ft. Structural Foam Polyolefin decorative wave Channel Grate with UV inhibitor. Open surface area 7.78 square inches per foot. 23.80 GPM per foot.
253S	2' Channel Wave Grate	Sand	24 ft.	1.84		
253GR	2' Channel Wave Grate	Green	24 ft.	1.84		
253GY	2' Channel Wave Grate	Gray	24 ft.	1.84		
253	2' Channel Wave Grate	Black	24 ft.	1.84		2 ft. Cast Iron decorative wave Channel Grate. Open surface area 7.41 square inches per foot. 22.67 GPM per foot. Class B load rated.
253CI	2' Cast Iron Channel Wave Grate	Raw Iron	2 ft.	7.52		
629	Stainless Steel Screws, FH #20 x 1-1/2"	Metal	40	n/a	10ND	
(see page 72). ADA Compliant.						

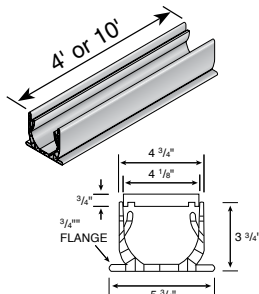

Part No.	Description	Color	Pkg. Qty.	Wt. Ea. (lbs.)	Product Class	Specifications
400	4' Channel Drain	Gray	24 ft.	4.83	25PF	NDS #400, 4 ft. PVC Spee-D® Channel Drain with inverse flying-buttress design, bottom flange, patented honeycomb reinforced walls and UV inhibitor.
400-10	10' Channel Drain	Gray	60 ft.	11.00	25PF	
Grate should be recessed 1/8" below finish grade in non-traffic applications. Grate should be recessed 1/4" in traffic applications.						

PROFILE CHANNEL DRAINS

Spee-D® Accessories

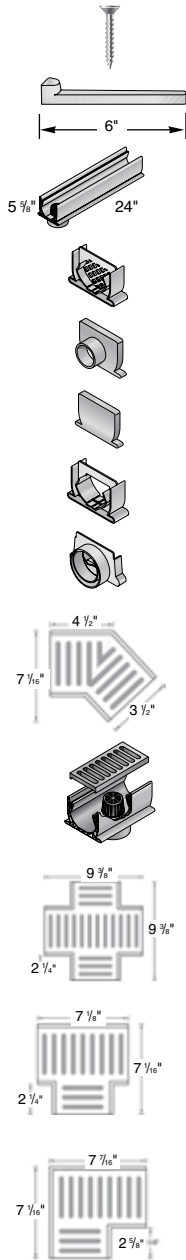

Part No.	Description	Color	Pkg. Qty.	Wt. Ea. (lbs.)	Product Class
229	Stainless Steel Screws, FH #8 x 1"	Steel	48	0.06	25PF
230	6" Channel Installation Stake	Gray	24	0.04	25PF
234	2' long fabricated 3" & 4" Spigot Bottom Outlet with Strainer. Fits 3" or 4" Sewer and Drain Fittings. Grates not included.	Gray	12	2.67	25PF
245	Channel Strainer Coupling	Gray	20	0.35	25PF
246	2" Schedule 40 SPT End Outlet	Gray	10	0.40	25PF
247	Channel End Cap	Gray	10	0.40	25PF
248	Channel Coupling	Gray	20	0.40	25PF
249	3" & 4" Offset End Outlet Connects to 3" S&D Pipe, 4" S&D Fittings	Gray	10	0.50	25PF
2301	Fabricated 45° Elbow with Grate	Gray	1	2.00	25PF
2351	7" Fabricated Grate 4" Bottom Outlet with Grate	Gray	1	1.70	25PF
2361	Fabricated Cross and Grate	Gray	1	3.00	25PF
2370	Fabricated Tee with Grate	White	1	3.00	25PF
2371	Fabricated Tee with Grate	Gray	1	3.00	25PF
2372	Fabricated Tee with Grate	Green	1	3.00	25PF
2381	Fabricated 90° Elbow with Grate	Gray	1	3.00	25PF

DRAINAGE

PRO SERIES CHANNEL DRAINS

3" Pro Series Channel™ Drains

DRAINAGE

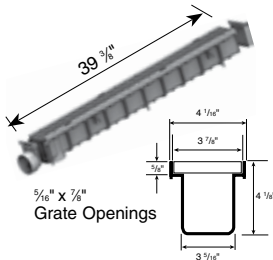

Part No.	Description	Color	Pkg. Qty.	Wt. Ea. (lbs.)	Product Class	Specifications
764	3" x 1 Meter Light Traffic Channel Grate & Channel Drain Kit	Light Gray	10	3.50	25IN	3" wide Light Traffic Channel Grate and Channel Drain with mechanical interlocking joints and UV inhibitors. Open surface area 23.63 square inches per foot. 76.85 GPM per foot.
764DISP	3" Pro Series Channel Display (16 Kits)		1	105.00	25IN	
Includes 1 end outlet (#713) and 1 end cap (#712). Bottom outlet fits 3" S&D fittings. Grate should be recessed 1/8" below finish grade in non-traffic applications. Grate should be recessed 1/4" in traffic applications. (see page 72). ADA Compliant.						

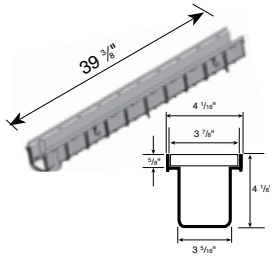

Part No.	Description	Color	Pkg. Qty.	Wt. Ea. (lbs.)	Product Class	Specifications
710	3" x 1 Meter Channel Drain*	Light Gray	12	1.90	25IN	3" wide Light Traffic Channel with mechanical interlocking joints and UV inhibitors. Polypropylene.
Bottom outlet fits 3" S&D fittings. Grate should be recessed 1/8" below finish grade in non-traffic applications. Grate should be recessed 1/4" in traffic applications. *Produced under license of First Plast S.R.L.- Italy. (see page 72). ADA Compliant.						

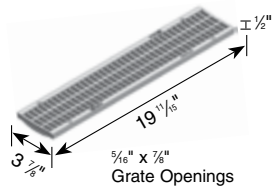

Part No.	Description	Color	Pkg. Qty.	Wt. Ea. (lbs.)	Product Class	Specifications
714	3" x 20" Light Traffic Channel Grate*	Light Gray	24	0.70	25IN	3" wide Light Traffic Channel Grate. Open surface area 23.63 square inches per foot. 72.29 GPM per foot. Polypropylene.
Requires 4 #229 screws. *Produced under license of First Plast S.R.L.- Italy. (see page 72). ADA Compliant.						

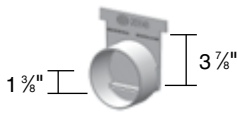

Part No.	Description	Color	Pkg. Qty.	Wt. Ea. (lbs.)	Product Class	Specifications
713	3" End Cap/End Outlet	Light Gray	12	0.10	25IN	3" Channel End Cap/End Outlet. Polypropylene.
Fits 3" Fittings.						

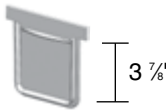

Part No.	Description	Color	Pkg. Qty.	Wt. Ea. (lbs.)	Product Class	Specifications
712	3" End Cap	Light Gray	20	0.05	25IN	3" Channel End Cap. Polypropylene.



Part No.	Description	Color	Pkg. Qty.	Wt. Ea. (lbs.)	Product Class	Specifications
229	Stainless Steel Screws FH H8 x 1"	Steel	48	0.06	25PF	

PRO SERIES CHANNEL DRAINS

5" Pro Series Channel™ Drains

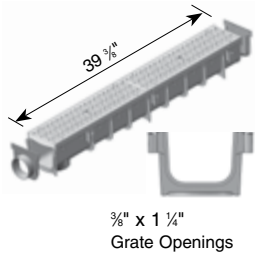

Part No.	Description	Color	Pkg. Qty.	Wt. Ea. (lbs.)	Product Class	Specifications
864	5" x 1 Meter Light Traffic Includes 1 end outlet & 1 end cap	Light Gray	9	5.67	25IN	5" wide Light Traffic Channel Grate and Channel Drain with mechanical interlocking joints and UV inhibitors. Open surface area 23.52 square inches per foot. 71.95 GPM per foot.
864DISP	5" Pro Series Channel Display (20 Kits)		1	113.40	25IN	
 Grate should be recessed 1/8" below finish grade in non-traffic applications. Grate should be recessed 1/4" in traffic applications. Bottom outlet fits 3" and 4" S&D fittings. (see page 72)						

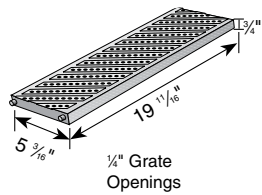

Part No.	Description	Color	Pkg. Qty.	Wt. Ea. (lbs.)	Product Class	Specifications
826	5" x 20" Pedestrian Traffic Channel Grate	Light Gray	10	1.00	25IN	5" wide UV-protected Structural Foam Polyolefin Pedestrian Traffic Channel Grate. Open surface area 4.86 square inches per foot. 24.26 GPM per foot.
 Requires #829 screws. (see page 72). ADA Compliant/Heelproof.						

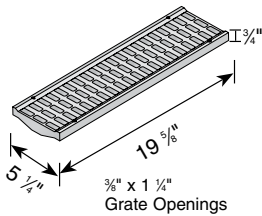

Part No.	Description	Color	Pkg. Qty.	Wt. Ea. (lbs.)	Product Class	Specifications
814	5" x 20" Light Traffic Channel Grate	Light Gray	10	1.16	25IN	5" wide Structural Foam Polyolefin Light Traffic Channel Grate with UV inhibitors. Open surface area 23.52 square inches per foot. 71.95 GPM per foot.
815	5" x 20" Light Traffic Channel Grate	Green	10	1.16	25IN	
816	5" x 20" Light Traffic Channel Grate	Black	10	1.16	25IN	
817	5" x 20" Light Traffic Channel Grate	Sand	10	1.16	25IN	
818	5" x 20" Light Traffic Channel Grate	Brick Red	10	1.16	25IN	
819	5" x 20" Light Traffic Channel Grate	White	10	1.16	25IN	
 Requires #829 screws. (see page 72). ADA Compliant.						

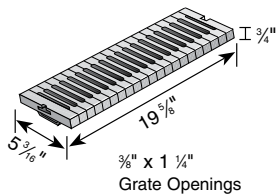

Part No.	Description	Color	Pkg. Qty.	Wt. Ea. (lbs.)	Product Class	Specifications
828	5" x 20" Load Star Heavy Traffic Channel Grate	Gray	10	2.35	25IN	5" wide UV-protected high-impact glass-reinforced nylon Heavy Traffic Channel Grate. Open surface area 15.92 square inches per foot. 48.70 GPM per foot.
 Requires 4 screws per grate. Requires #829 screws. (see page 72)						

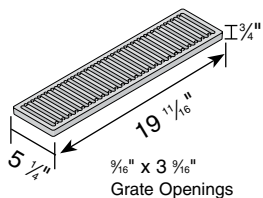

Part No.	Description	Color	Pkg. Qty.	Wt. Ea. (lbs.)	Product Class	Specifications
823	5" x 20" Ductile Channel Grate	Black	1	12.30	25IN	5" wide heavy-duty Ductile Heavy Traffic Channel Grate. Open surface area 22.90 square inches per foot. 70.05 GPM per foot.
 (see page 72). ADA Compliant.						



Part No.	Description	Color	Pkg. Qty.	Wt. Ea. (lbs.)	Product Class	Specifications
829	Stainless Steel Screws FH #6 x 1 1/4"	Steel	40	0.15	25PF	

PRO SERIES CHANNEL DRAINS

5" Pro Series Channel™ Drains (continued)

DRAINAGE

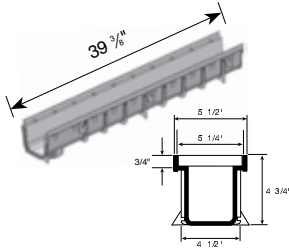

Part No.	Description	Color	Pkg. Qty.	Wt. Ea. (lbs.)	Product Class	Specifications
800	5" x 1 Meter Deep Profile Channel Drain	Light Gray	10	4.00	25IN	5" wide Deep Profile Channel Drain with mechanical interlocking joints, integrated knockout bottom outlet. Polypropylene.
	Integrated knockout bottom outlet fits 3" and 4" S&D fittings. Grate should be recessed 1/8" below finish grade in non-traffic applications. Grate should be recessed 1/4" in traffic applications.					

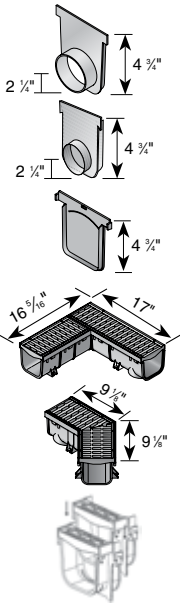

Part No.	Description	Color	Pkg. Qty.	Wt. Ea. (lbs.)	Product Class	Specifications
811	5" Deep Profile 3" S&D Pipe Hub & 4" S&D Fitting SPT End Outlet	Light Gray	10	0.40	25IN	5" wide Deep Profile End Outlet. PVC.
813	5" Deep Profile End Cap/3" S&D Hub & 4" S&D SPT Knockout End Outlet	Light Gray	10	0.40	25IN	5" wide Deep Profile End Cap/End Outlet. PVC.
812	5" Deep Profile End Cap	Light Gray	10	0.13	25IN	5" wide Deep Profile End Cap. PVC.
861	5" Deep Profile Grate & Channel Drain 90° Elbow	Light Gray	1	3.44	25IN	
862	5" Deep Profile Grate & Channel Drain 45° Elbow	Light Gray	1	3.44	25IN	
PSRC-864	Quik-Turn™ 5" Deep Radius Coupling Provides a 6 degree bend left or right	Light Gray	9	0.30	25IN	

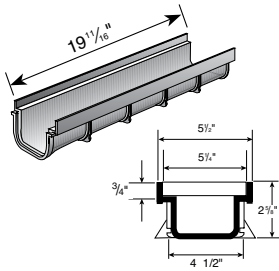

Part No.	Description	Color	Pkg. Qty.	Wt. Ea. (lbs.)	Product Class	Specifications
820	5" x 20" Shallow Profile Channel Drain*	Light Gray	10	1.35	25IN	5" wide Shallow Profile UV-protected high-impact PVC Channel Drain with mechanical interlocking joint.
	Grate should be recessed 1/8" below finish grade in non-traffic applications. Grate should be recessed 1/4" in traffic applications. *Produced under license of First Plast S.R.L. - Italy.					

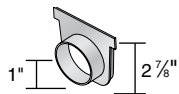

Part No.	Description	Color	Pkg. Qty.	Wt. Ea. (lbs.)	Product Class	Specifications
821	5" Shallow Profile End Cap/1 1/2" Sch. 40 SPT Knockout End Outlet*	Light Gray	10	0.15	25IN	5" wide Shallow Profile high-impact PVC End Cap/End Outlet.
	*Produced under license of First Plast S.R.L. - Italy.					

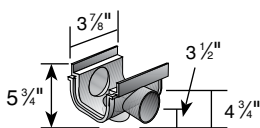

Part No.	Description	Color	Pkg. Qty.	Wt. Ea. (lbs.)	Product Class	Specifications
822	5" Shallow Profile 3" S&D SPT Bottom Outlet/1 1/2" Sch. 40 SPT Side Outlet	Light Gray	10	0.60	25IN	5" wide Shallow Profile high-impact PVC Bottom/Side Outlet.

PRO SERIES CHANNEL DRAINS

8" Pro Series Channel™ Drains

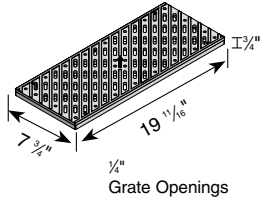

Part No.	Description	Color	Pkg. Qty.	Wt. Ea. (lbs.)	Product Class	Specifications
836	8" x 20" Pedestrian Traffic Channel Grate	Light Gray	1	1.55	25IN	8" wide UV-protected Structural Foam Polyolefin Pedestrian Traffic Channel Grate. Open surface area 13.82 square inches per foot. 42.28 GPM per foot.
 Requires #829 screws. 4 screws per grate. (see page 72). ADA Compliant/Heelproof.						

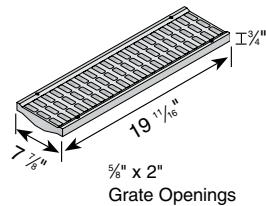

Part No.	Description	Color	Pkg. Qty.	Wt. Ea. (lbs.)	Product Class	Specifications
837	8" x 20" Light Traffic Channel Grate	Light Gray	1	3.00	25IN	8" wide UV-protected Structural Foam Polyolefin Light Traffic Channel Grate. Open surface area 30.28 square inches per foot. 92.63 GPM per foot.
 Requires #829 screws. 4 screws per grate. (see page 72)						

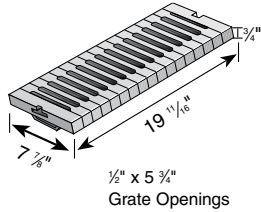

Part No.	Description	Color	Pkg. Qty.	Wt. Ea. (lbs.)	Product Class	Specifications
838	8" x 20" Load Star Heavy Traffic Channel Grate*	Light Gray	1	3.59	25IN	8" wide UV-protected high-impact glass-reinforced nylon Heavy Traffic Channel Grate. Open surface area 30.85 square inches per foot. 94.37 GPM per foot.
 Requires #829 screws. 4 screws per grate. *Produced under license of First Plast S.R.L. - Italy. (see page 72). ADA Compliant.						

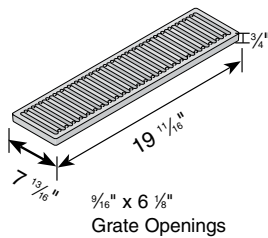

Part No.	Description	Color	Pkg. Qty.	Wt. Ea. (lbs.)	Product Class	Specifications
888	8" x 20" Ductile Channel Grate	Black	1	22.24	25IN	8" wide heavy-duty Ductile Heavy Traffic Channel Grate. Open surface area 23.80 square inches per foot. 71.28 GPM per foot.
 #829 screws may be used. 4 screws per grate. (see page 72)						

PRO SERIES CHANNEL DRAINS

8" Pro Series Channel™ Drains (continued)

DRAINAGE

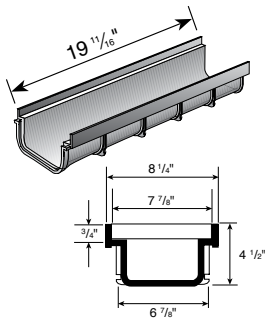

Part No.	Description	Color	Pkg. Qty.	Wt. Ea. (lbs.)	Product Class	Specifications
830	8" x 20" Shallow Profile Channel Drain*	Light Gray	1	2.00	25IN	8" wide Shallow Profile high-impact PVC Channel Drain with mechanical interlocking joints and UV inhibitors.
Grate should be recessed 1/8" below finish grade in non-traffic applications. Grate should be recessed 1/4" in traffic applications. *Produced under license of First Plast S.R.L.- Italy.						

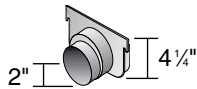

Part No.	Description	Color	Pkg. Qty.	Wt. Ea. (lbs.)	Product Class	Specifications
831	8" Shallow Profile End Cap/ 3" S&D SPT Knockout End Outlet*	Light Gray	1	0.49	25IN	8" wide Shallow Profile high-impact PVC End Cap/ End Outlet.
*Produced under license of First Plast S.R.L.- Italy.						

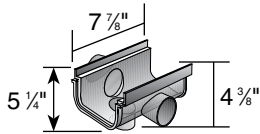

Part No.	Description	Color	Pkg. Qty.	Wt. Ea. (lbs.)	Product Class	Specifications
832	8" Shallow Profile 3" S&D SPT Side Outlet*	Light Gray	1	1.38	25IN	8" wide Shallow Profile high-impact PVC Bottom/Side Outlet.
Bottom outlet fits 4" S&D pipe, 3" S&D fittings. *Produced under license of First Plast S.R.L.- Italy.						

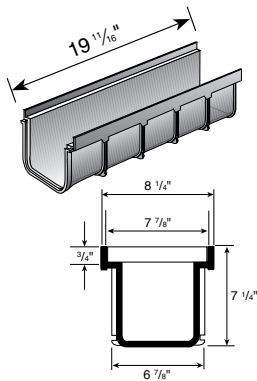

Part No.	Description	Color	Pkg. Qty.	Wt. Ea. (lbs.)	Product Class	Specifications
833	8" x 20" Deep Profile Channel Drain	Light Gray	1	2.80	25IN	8" wide Deep Profile high-impact PVC Channel Drain with mechanical interlocking joints and UV inhibitors.
Grate should be recessed 1/8" below finish grade in non-traffic applications. Grate should be recessed 1/4" in traffic applications.						

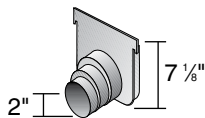

Part No.	Description	Color	Pkg. Qty.	Wt. Ea. (lbs.)	Product Class	Specifications
834	8" Deep Profile End Cap/3" & 4" S&D SPT Knockout End Outlet	Light Gray	10	0.51	25IN	8" wide Deep Profile high-impact PVC End Cap/End Outlet.
*Produced under license of First Plast S.R.L.- Italy.						

PRO SERIES CHANNEL DRAINS

12" Pro Series Channel™ Drains

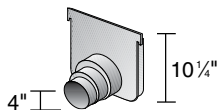
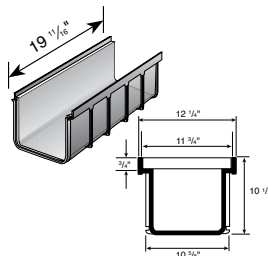
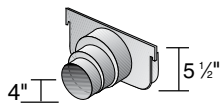
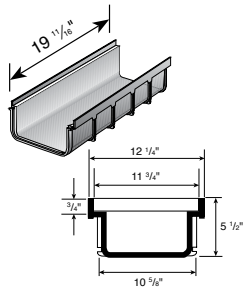
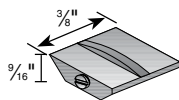
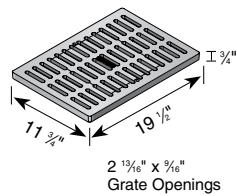
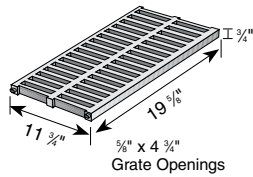

Part No.	Description	Color	Pkg. Qty.	Wt. Ea. (lbs.)	Product Class	Specifications
847	12" x 20" Light Traffic Channel Grate*	Gray	1	4.64	251N	12" wide UV-protected high-impact PVC Light Traffic Channel Grate. Open surface area 48.77 square inches/foot. 149.19 GPM per foot.
	*Produced under license of First Plast S.R.L. - Italy. (see page 74)					

Part No.	Description	Color	Pkg. Qty.	Wt. Ea. (lbs.)	Product Class	Specifications
845	12" x 20" Cast Iron Heavy Traffic Channel Grate	Black	1	28.00	251N	12" Wide Cast Iron Heavy Traffic Channel Grate. Open surface area 46.70 square inches per foot. 142.86 GPM per foot.
	(see page 72)					

Part No.	Description	Color	Pkg. Qty.	Wt. Ea. (lbs.)	Product Class	Specifications
849	Grate Security Clip*	Gray	10	0.40	251N	
	For use with 845 and 847 grates and 840 or 843 channels only (2 per grate). Mounts inside channel drain and secures grate. Screw and nut included.					
	*Produced under license of First Plast S.R.L. - Italy.					

Part No.	Description	Color	Pkg. Qty.	Wt. Ea. (lbs.)	Product Class	Specifications
840	12" x 20" Shallow Profile Channel Drain	Light Gray	1	4.00	251N	12" wide Shallow Profile UV-protected high-impact PVC Channel Drain with mechanical interlocking joints.
	Grate should be recessed 1/8" below finish grade in non-traffic applications. Grate should be recessed 1/4" in traffic applications.					

Part No.	Description	Color	Pkg. Qty.	Wt. Ea. (lbs.)	Product Class	Specifications
841	12" Shallow Profile End Cap/3" & 4" S&D SPT Knockout End Outlet	Light Gray	1	1.00	251N	12" wide Shallow Profile high-impact PVC End Cap/3" & 4" Corrugated S&D Pipe.

Part No.	Description	Color	Pkg. Qty.	Wt. Ea. (lbs.)	Product Class	Specifications
843	12" x 20" Deep Profile Channel Drain*	Light Gray	1	6.00	251N	12" wide Deep Profile UV-protected high-impact PVC Channel Drain with mechanical interlocking joints.
	Grate should be recessed 1/8" below finish grade in non-traffic applications. Grate should be recessed 1/4" in traffic applications.					
	*Produced under license of First Plast S.R.L. - Italy.					

Part No.	Description	Color	Pkg. Qty.	Wt. Ea. (lbs.)	Product Class	Specifications
844	12" Deep Profile End Cap/3" & 4" S&D SPT Knockout End Outlet*	Light Gray	1	1.60	251N	12" wide Deep Profile high-impact PVC End Cap/3" & 4" Corrugated S&D Pipe.
	*Produced under license of First Plast S.R.L. - Italy.					

DRAINAGE