

2025 PRODUCT CATALOG



cast industries, inc.

**CASTING • BUZZBLADES • LURE EYES
HOOKS • POWDER PAINTING • WIRES**

What Can Cast Industries Do For You?

— Quality & Speed Matter —

Largest U.S. manufacturer of lead fishing tackle

Centrifugal Casting

- All jig types, spin & buzz heads, weights, weighted hooks, etc
- Fresh or saltwater

Design and Prototype

- New products from drawings or samples
- Concept to production in as little as 30 days

Painting

- Powder coating
- Liquid painting
- Custom paint schemes

Mold Making

- Custom silicone molds

Buzz Baits

- All sizes and styles
- Shaker Blades

Outsource all or part of your manufacturing to Cast Industries

580 North Street • Springfield, IL 62704 USA

www.castind.com contact: Jim@castind.com 217-522-8292 Fax 217-522-8378
or
Jeremy@castind.com

Why Cast Industries?

Experience

- for 30 years serving over 700 customers on five continents

Largest

- U.S. manufacturer of lead fishing tackle

Reputation

- for Quality and Service - ask around

Speed

- fast turnaround due to our complete control of the production process

Build to order

- select the components you want

Design and mold expertise

- bring new products to market quickly

The best molds make the best lures

- many manufacturers come to Cast Industries for their molds

Huge catalog of standard items

- no design or mold charges

Capacity

- all customers large or small get first class service and quality

We sell components

- hooks, swivels, wires, clam shells, eyes, fibers, etc.

Paint & Flake Colors

Over the years we have determined that most all fishing tackle is painted using the colors listed below. Please note that flake colors must be sprayed over another color and some look better than others. Example - blue flake over black paint or green flake over brown paint. Please give us a call if you have any questions.

Paint Colors

Green Chartreuse – Cht	Camo - Cam
Orange – Orn	Cerise - Cer
Moss Green – Moss	Gloss White - Wht
Yellow Chartreuse – Lyl	Gloss Black - Blk
Yellow – Yel	Silver - Sil
Strike Green – St Grn	Gloss Brown - Brn
Dark Blue – D Blu	Gold - Gld
Light Blue – L Blu	Red - Red
Metallic Purple – Met Pur	Glow - Glo
Fluorescent Red – FRed	Pearl Copper - PCop
Pearl White – Pwt	Fluorescent Pink - Pnk
Copper – Cop	Gray – Gry

Flake Colors

Copper – Cop Fl
Green – Grn Fl
Red – Red Fl
Fire Opal – Opl Fl
Orange – Orn Fl
Purple – Pur Fl
Blue – Blu Fl
Pearl Blue – Pl Blu Fl
Pearl Green – Pl Grn Fl
Holographic – Hol Fl
Silver – Sil Fl
Gold – Gld Fl
Chartreuse – Cht Fl
Black – Blk Fl

Powder Flake Colors

Pearl Green – Grn Pwdr
Pearl Gold – Gld Pwdr
Pearl Blue – Blu Pwdr
Pearl Purple – Pur Pdr

Custom Mold Charges

Mold Size

Price

9"	\$210.00
12"	\$230.00
15"	\$250.00

Replacement Mold

In-House Manufacturing

Price

9"	Our Expense
12"	Our Expense
15"	Our Expense

Mastering charges range from a minimum of \$100.00 to a maximum of \$250.00 per piece. The average is typically \$200.00.

To create a custom lure, simply send us a detailed drawing or prototype including any and all specific information that may apply to your new custom item. For example, hook style and size, wire frame size and diameter and/or any specific fiber guard information that you feel is necessary. Also include your company name and phone number. Next we will generate a "Master" and from it create a cavity from which we can pour a "Production Master" prototype for your approval. Once approved, the master set will be created and a multi cavity silicone mold will be made and production can begin. **Important**, once a master set is created it cannot be altered or modified. This master set will be used to generate additional molds or replace worn out molds to ensure that the product will never change in size or shape. Send us your 3D file in STL format and we can print it with our 3D printer.

Wire Forms

Most spin wires are available in gauge .030, .032, .035, .037, .040, .045 depending on the size.
 Buzz wires are available in .032 and .035 in the B1 and .040, .045 and .051 for the B2 and B3.

R-Bend Wire

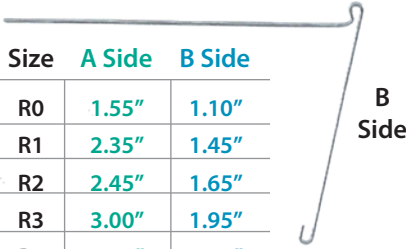

Size	A Side	B Side
R0	1.55"	1.10"
R1	2.35"	1.45"
R2	2.45"	1.65"
R3	3.00"	1.95"
R4	3.50"	2.15"

Twisted Wire

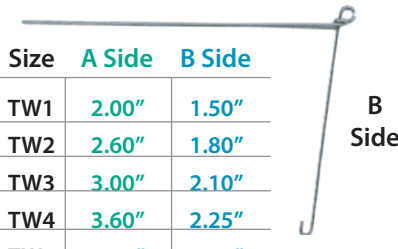

Size	A Side	B Side
TW1	2.00"	1.50"
TW2	2.60"	1.80"
TW3	3.00"	2.10"
TW4	3.60"	2.25"
TW5	5.10"	3.50"

Buzz Wire

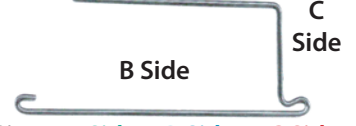

Size	A Side	B Side	C Side
B1	1.45"	1.80"	.70"
B2	1.90"	2.50"	.95"
B3	2.50"	3.00"	1.10"

We can create a custom wire form necessary for any application. However, a one-time fee of up to \$750.00 may apply to cover the cost of a nonstandard machine set up charge.

Ordering Information

- All orders are scheduled for production when received. Due to the variety of combinations of colors, wires, hooks, it is impossible for us to inventory any product. Everything is built to order. Quantities shipped may vary from number ordered.
- Most items in our catalog are priced how they are typically sold. We can in most cases alter the hook, paint and eyes to a certain extent. When doing so the price may change.
- ALL discounting is rounded up to the nearest penny.
- **Spin or buzz** head orders we need to know (1) style of head, (2) size of head, (3) hook size if different from what is listed and (4) wire size and diameter. Spin and buzz molds are the most forgiving and they will accept about any size hook or wire. We can recommend what is most popular.
- **Weedless jig** orders we need to know (1) style of head, (2) size of head, (3) hook style, (4) hook size and (5) fiber size. In some cases, the same jig will take a lot of different style hooks so please ask if you want something different. Jig molds aren't quite as forgiving as spin molds so we can usually only deviate one hook size either way from what is listed. We list the most popular hook and use a .021 fiber guard unless another size is specifically requested. We do stock heavier (.024) fiber guards, in black, brown, green and clear.
- **Freshwater** items will take a lot of different hooks so we list the most popular hooks. A good example is a 1/8 ball with collar which will take a hook from size #4 thru 4/0 from either Mustad, Eagle Claw, VMC or Gamakatsu. Simply let us know what hook you would like and we will check to see if it will fit the mold.
- **Saltwater** items have the least flexibility in hook selection especially in the larger sizes. We can always check to see if the hook size you want will fit.
- Painting first color is usually powder coated with additional colors liquid painted, followed by an epoxy top coat. Please call for more details. See color listing.
- Painted eyes can be put anywhere on any lure. We also offer different colors of flat stick and molded bubble eyes which we recommend only using on lures with sockets to accept them.
- At Cast Industries "Quality and Speed" matter. All of our work is done here in our Springfield, Illinois, USA plant.
- If you ever receive product from us that is damaged from shipping, wrong components or painted incorrectly, please let us know and we will get replacements into production as soon as possible.
- Weight conversion: 1/4 oz. = 7.1 grams, 1 oz = 28.4 grams.

Spin & Buzz Heads

Mustad ultra point **round bend** hook

Size	Hook	Unpainted	Painted
1/16	#1	\$.60	\$1.05
1/8	1/0	.60	1.05
3/16	2/0	.62	1.07
1/4	3/0	.63	1.08
3/8	4/0	.67	1.12
1/2	5/0	.71	1.16
3/4	5/0	.79	1.24
1	6/0	.87	1.33
1 1/2	7/0	1.03	1.51
2	7/0	1.14	1.64
2 1/2	8/0	1.26	1.77

Spin and Buzz Options

- Each additional color add \$.11
- Metal Flake add .11
- Painted single eye add .10
- Painted or Stick-on double eye .15
- Molded bubble eye add .15 to .20
- Buzz Heads add .02
- Painted Clacker Buzz add .14

- Not all styles are available in all sizes
- Please specify wire diameters and frame sizes
- Most molds will accept larger or smaller hooks

- Customer may supply their own hooks and wires
- Prices include **Mustad Ultra Point** hook and wire frame
- We also stock **Gamakatsu, VMC** and **Owner** hooks.



Style A — Spin 1/8 - 1½ oz
Buzz 1/8 - 1/2oz



Style B — Spin 1/8 - 1 oz
Buzz 1/8 - 1/2 oz



Style C — Spin 1/8 - 2½ oz
Buzz 1/8 - 1/2 oz



Style D — Spin 1/4 - 2 oz



Style E — Spin 1/4 - 3/4 oz



Style F — Spin 1/4 - 1/2 oz



Style H — Spin 1/4 - 1 oz



Style V — Spin 1/4 - 1 oz



Style W — Spin 1/4 - 1/2 oz
Buzz 1/4 - 1/2 oz



Banana Spin 1/8 - 1/2 oz



Bullet Spin 1/8 - 1 oz



Crappie Ball Spin 1/8 oz



Crappie Bullet Spin 1/8 - 3/16 oz



Pro Buzz Head 1/8 - 1/2 oz



Torpedo Spin 1/4 - 1/2 oz



Buzz Head 1/8 - 1/2 oz



Clacker Buzz 1/8 - 1/2 oz

Bass Jigs

Finesse Arkey

Mustad **blk nickel** hook



Size	Hook	Unpainted	Painted
1/4	2/0	\$.65	\$.97
3/8	3/0	.68	1.00
1/2	4/0	.71	1.03

Arkey Cross Eye

Mustad **cross eye blk nickel** hook



Size	Hook	Unpainted	Painted
1/8	2/0	\$.64	\$.96
1/4	3/0	.66	.98
3/8	4/0	.70	1.02
1/2	5/0	.73	1.05
3/4	5/0	.77	1.10

D.C. Arkey Lite Wire

Mustad **cross eye blk nickel** hook



Size	Hook	Unpainted	Painted
1/8	3/0	\$.65	\$.97
1/4	3/0	.66	.98
3/8	4/0	.70	1.02
1/2	5/0	.73	1.05
3/4	5/0	.77	1.10
1	5/0	.83	1.16

D.C. Arkey Heavy Wire

Mustad **cross eye blk nickel** hook



Size	Hook	Unpainted	Painted
1/8	3/0	\$.65	\$.97
1/4	3/0	.66	.98
3/8	4/0	.70	1.02
1/2	5/0	.73	1.05
3/4	5/0	.77	1.10
1	6/0	.85	1.18

D.C. Arkey Meg

Mustad **mega bite** hook



Size	Hook	Unpainted	Painted
1/8	2/0	\$.68	\$ 1.00
1/4	3/0	.70	1.02
3/8	4/0	.72	1.04
1/2	5/0	.82	1.14
3/4	5/0	.86	1.19
1	6/0	.96	1.29

Arkey Flat Eye

Mustad **flat eye blk nickel** hook



Size	Hook	Unpainted	Painted
1/8	2/0	\$.64	\$.96
1/4	3/0	.66	.98
3/8	4/0	.70	1.02
1/2	5/0	.73	1.05
3/4	5/0	.77	1.10

D.C. Arkey Flat Eye

Mustad **flat eye blk nickel** hook



Size	Hook	Unpainted	Painted
1/8	2/0	\$.64	\$.96
1/4	3/0	.66	.98
3/8	4/0	.70	1.02
1/2	5/0	.73	1.05
3/4	5/0	.77	1.10

Weedless Rocker

Mustad **blk nickel** hook



Size	Hook	Unpainted	Painted
3/16	2/0	\$.64	\$.96
1/4	3/0	.66	.98
3/8	4/0	.70	1.02
1/2	5/0	.73	1.05
3/4	5/0	.77	1.10
1	6/0	.85	1.18

Weedless Rocker w/Keeper

Mustad **blk nickel** hook



Size	Hook	Unpainted	Painted
1/4	3/0	\$.85	\$ 1.17
3/8	4/0	.89	1.21
1/2	5/0	.92	1.24
3/4	5/0	.96	1.29
1	6/0	1.04	1.37

Pro Weedless Rocker

Mustad **blk nickel** hook



Size	Hook	Unpainted	Painted
1/4	5/0	\$.75	\$ 1.07
3/8	5/0	.77	1.09
1/2	6/0	.81	1.13
3/4	6/0	.85	1.18

Gam Hook add .15

Curved Shank Rocker

Mustad **blk nickel** hook



Size	Hook	Unpainted	Painted
1/4	4/0	\$.73	\$ 1.05
3/8	4/0	.75	1.07
1/2	6/0	.81	1.13
3/4	6/0	.85	1.18

Style H Weedless

Mustad **mega bite** hook



Size	Hook	Unpainted	Painted w/eyes
1/4	3/0	\$.70	\$ 1.30
3/8	4/0	.72	1.32
1/2	5/0	.81	1.41
3/4	6/0	.90	1.51
1	7/0	1.01	1.62

Bass Jigs

Weedless Ball Heavy Wire

Mustad **blk nickel** hook



Size	Hook	Unpainted	Painted
3/16	3/0	\$.65	\$.97
5/16	3/0	.66	.98
7/16	4/0	.70	1.02

Weedless Ball Lite Wire

Mustad **blk nickel** hook



Size	Hook	Unpainted	Painted
3/16	4/0	\$.67	\$.99
5/16	4/0	.68	1.00
7/16	5/0	.71	1.03

Pro Weedless Ball

Mustad **blk nickel** hook



Size	Hook	Unpainted	Painted
3/16	4/0	\$.72	\$ 1.04
5/16	5/0	.75	1.07
7/16	5/0	.77	1.09

Weedless Ball with Eye Jig

Mustad **blk nickel** hook



Size	Hook	Unpainted	Painted w/eyes
3/16	4/0	\$.67	\$ 1.27
5/16	4/0	.68	1.28
7/16	5/0	.71	1.31

Style B Weedless Jig

Mustad **blk nickel** hook



Size	Hook	Unpainted	Painted
1/8	4/0	\$.68	\$ 1.00
1/4	5/0	.69	1.01
3/8	5/0	.71	1.03
1/2	5/0	.73	1.05
3/4	6/0	.79	1.12
1	6/0	.85	1.18

Style B Meg Weedless Jig

Mustad **mega bite** hook



Size	Hook	Unpainted	Painted
1/8	3/0	\$.69	\$ 1.01
1/4	4/0	.70	1.02
3/8	5/0	.80	1.12
1/2	5/0	.82	1.14
3/4	5/0	.86	1.19
1	6/0	.96	1.29

Weedless Football w/Eye Sockets

Mustad **blk nickel** hook



Size	Hook	Unpainted	Painted w/eyes
1/8	2/0	\$.64	\$ 1.24
1/4	2/0	.65	1.25
3/8	3/0	.68	1.28
1/2	4/0	.72	1.32

Weedless Football

Mustad **blk nickel** hook



Size	Hook	Unpainted	Painted
3/16	1/0	\$.63	\$.95
1/4	2/0	.65	.97
3/8	3/0	.68	1.00
1/2	4/0	.71	1.03

Weedless Meg Football

Mustad **mega bite** hook



Size	Hook	Unpainted	Painted
3/16	2/0	\$.68	\$ 1.00
1/4	3/0	.70	1.02
3/8	4/0	.72	1.04
1/2	5/0	.82	1.14

Single Guard Football

Mustad **blk nickel** hook



Size	Hook	Unpainted	Painted
1/4	3/0	\$.54	\$.74
3/8	3/0	.56	.76
1/2	4/0	.59	.79
3/4	4/0	.63	.84

Pit Bull Jig

Heavy Duty VMC **Siwash** hook



Size	Hook	Unpainted	Painted
1/4	5/0	\$ 1.15	\$ 1.47
3/8	5/0	1.17	1.49
1/2	5/0	1.19	1.51
3/4	5/0	1.23	1.56
1	5/0	1.29	1.62

Weedless Football EWG

VMC **EWG blk nickel** hook



Size	Hook	Unpainted	Painted
1/4	4/0	\$.74	\$ 1.06
3/8	5/0	.79	1.11
1/2	5/0	.81	1.13
3/4	5/0	.85	1.18
1	6/0	.94	1.27

Bass Jigs

Weedless Football Heavy Wire

Mustad **blk nickel** hook



Size	Hook	Unpainted	Painted
1/4	3/0	\$.66	\$.98
3/8	4/0	.70	1.02
1/2	5/0	.73	1.05
3/4	5/0	.77	1.10
1	6/0	.85	1.18

Weedless Football Light Wire

Mustad **blk nickel** hook



Size	Hook	Unpainted	Painted
1/4	3/0	\$.66	\$.98
3/8	4/0	.69	1.01
1/2	5/0	.72	1.04
3/4	5/0	.76	1.09
1	5/0	.82	1.15

Curved Shank Football

Mustad **blk nickel** hook



Size	Hook	Unpainted	Painted
1/4	4/0	\$.73	\$ 1.05
3/8	4/0	.75	1.07
1/2	6/0	.81	1.13
5/8	6/0	.83	1.15
3/4	6/0	.85	1.18
1	6/0	.91	1.24

Pro Series Football

Mustad **blk nickel** hook



Size	Hook	Unpainted	Painted
1/4	4/0	\$.48	\$.68
3/8	5/0	.52	.72
1/2	5/0	.54	.74
3/4	6/0	.63	.84
1	6/0	.73	.95

Pro Series Weedless Football

Mustad **blk nickel** hook



Size	Hook	Unpainted	Painted
1/4	4/0	\$.73	\$ 1.05
3/8	5/0	.77	1.09
1/2	5/0	.79	1.11
5/8	6/0	.83	1.15
3/4	6/0	.85	1.18
1	6/0	.91	1.24
1 1/4	6/0	.96	1.30

Pro Weedless Stand-up

Mustad **blk nickel** hook



Size	Hook	Unpainted	Painted
3/16	4/0	\$.72	\$ 1.04
1/4	4/0	.73	1.05
3/8	5/0	.77	1.09
1/2	6/0	.81	1.13
3/4	6/0	.85	1.18
1	6/0	.91	1.24

Style P Weedless Jig

Mustad **blk nickel** hook



Size	Hook	Unpainted	Painted
1/8	3/0	\$.65	\$.97
1/4	4/0	.68	1.00
3/8	5/0	.71	1.03
1/2	5/0	.73	1.05
3/4	6/0	.79	1.12

Spit-n-Fire Jig

Mustad **blk nickel** hook



Size	Hook	Unpainted	Painted w/eyes
1/4	4/0	\$.68	\$ 1.28
3/8	4/0	.70	1.30
1/2	5/0	.73	1.33
3/4	5/0	.77	1.38
1	5/0	.83	1.44

Spit-n-Fire Jig

Mustad **mega bite** hook



Size	Hook	Unpainted	Painted w/eyes
1/4	2/0	\$.69	\$ 1.29
3/8	3/0	.72	1.32
1/2	4/0	.74	1.34
3/4	4/0	.78	1.39
1	5/0	.92	1.53

Grass Jig

Mustad **blk nickel** hook



Size	Hook	Unpainted	Painted
1/4	4/0	\$.68	\$ 1.00
3/8	5/0	.71	1.03
1/2	5/0	.73	1.05
3/4	5/0	.77	1.10
1	5/0	.83	1.16
1 1/2	5/0	.94	1.28

Swim Jig

VMC **blk nickel** hook

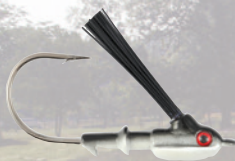

Size	Hook	Unpainted	Painted w/eyes
1/4	5/0	\$.69	\$ 1.29
3/8	5/0	.71	1.31
1/2	5/0	.73	1.33

Single Cable Stand-up

Mustad **blk nickel** hook



Size	Hook	Unpainted	Painted
1/8	3/0	\$.69	\$.89
3/16	3/0	.71	.91
1/4	4/0	.72	.92
5/16	4/0	.74	.94

Bass Jigs

Swing Hook Football

VMC blk nickel hook



Size	Hook	Unpainted	Painted
1/4	3/0	\$.75	\$ 1.03
3/8	4/0	.79	1.07
1/2	5/0	.84	1.12
3/4	5/0	.92	1.21
1	6/0	1.00	1.29

Loose Hook Football

VMC blk nickel hook



Size	Hook	Unpainted	Painted
1/4	3/0	\$.75	\$ 1.03
3/8	4/0	.79	1.07
1/2	5/0	.84	1.12
3/4	5/0	.92	1.21
1	6/0	1.00	1.29

No Hook Football



Size	Unpainted	Painted
1/4	\$.51	\$.83
3/8	.53	.85
1/2	.55	.87
3/4	.60	.93
1	.66	.99

Shaker Jig

Mustad nickel hook



Size	Hook	Unpainted	Painted
1/4	3/0	\$.56	\$.76
3/8	4/0	.59	.79
1/2	5/0	.63	.83
3/4	5/0	.70	.91
1	6/0	.81	1.03

See
Page 17
for
Shaker Blades



cast industries, inc.

Weedless Shaker Jig

Mustad nickel hook



Size	Hook	Unpainted	Painted
1/4	3/0	.81	1.13
3/8	4/0	.84	1.16
1/2	5/0	.88	1.20
3/4	5/0	.92	1.25
1	5/0	.98	1.31

Tail Spin



Size	Unpainted	Painted w/eyes
1/2	\$.51	\$.99
3/4	.59	1.06

Under Spin

Mustad blk nickel hook



Size	Hook	Unpainted	Painted with eyes
1/4	4/0	\$.61	\$ 1.08
3/8	5/0	.64	1.11
1/2	5/0	.66	1.13
3/4	6/0	.74	1.22

Jigging Blade



Size	Brass Blade Unpainted	Nickel Blade Unpainted
1/4	\$.55	\$.70
3/8	.57	.72
1/2	.59	.74
5/8	.62	.77
3/4	.65	.80

DID YOU KNOW WE ALSO SELL

- Clam Shells
- Ball Bearing Swivels
- Fiber Guards
- All Brands of Hooks
- Molded Lure Eyes
- Spin Wires
- Buzz Wires
- Spoon Wires
- Keeper Wires
- Screw Locks

Bulk Pack Only

Bass Jigs

Pro Shakey Head

Mustad **blk nickel** hook



Size	Hook	Unpainted	Painted
1/8	4/0	\$.65	\$.85
3/16	4/0	.66	.86
1/4	4/0	.66	.86
3/8	5/0	.70	.90
1/2	5/0	.72	.92
3/4	6/0	.78	.99

Gam Hook add .15

Shakey Head Mega Bite

Mustad **mega bite blk nickel** hook



Size	Hook	Unpainted	Painted
1/8	4/0	\$.62	\$.82
3/16	4/0	.63	.83
1/4	5/0	.71	.91
3/8	5/0	.73	.93

Shakey Head EWG

Mustad **EWG blk nickel** hook



Size	Hook	Unpainted	Painted
1/16	2/0	\$.60	\$.90
1/8	2/0	.60	.90
3/16	3/0	.63	.83
1/4	4/0	.65	.85
3/8	4/0	.67	.87

Screw Ball

Mustad **blk nickel** hook



Size	Hook	Unpainted	Painted
1/16	3/0	\$.58	\$.78
1/8	3/0	.58	.78
3/16	4/0	.60	.80
1/4	5/0	.61	.81
5/16	5/0	.63	.83

X-Eye Shakey

Mustad **blk nickel** hook



Size	Hook	Unpainted	Painted
1/8	3/0	\$.58	\$.78
3/16	3/0	.59	.79
1/4	4/0	.60	.80
3/8	5/0	.63	.83
1/2	5/0	.65	.85

Heavy Wire Shakey Football

Mustad **blk nickel** hook



Size	Hook	Unpainted	Painted
3/8	5/0	\$.64	\$.84
1/2	5/0	.66	.86
3/4	5/0	.70	.90

Heavy Wire Screwlock Football

Mustad **blk nickel** hook



Size	Hook	Unpainted	Painted w/eyes
3/16	4/0	\$.61	\$ 1.08
1/4	4/0	.61	1.08
3/8	5/0	.64	1.11
1/2	5/0	.66	1.13

Shakey Head Round Bend

Mustad **blk nickel** hook



Size	Hook	Unpainted	Painted
1/16	3/0	\$.58	\$.78
1/8	3/0	.58	.78
3/16	4/0	.60	.80
1/4	4/0	.60	.80
3/8	4/0	.62	.82

Shakey Head Stand-up

Mustad **blk nickel** hook



Size	Hook	Unpainted	Painted
1/8	4/0	\$.76	\$.96
3/16	4/0	.77	.97
1/4	4/0	.77	.97
5/16	5/0	.80	1.00

Bass Jig Options

- Single eye add \$.23
- Double eye add \$.28
- Molded bubble eye add \$.28 and up
- Metal Flake add \$.23
- Additional color add \$.23
- Prices vary depending on color
- We also stock **VMC**, **Gamakatsu** and **Owner** hooks.
- Fiber V-Guard add \$.05

Freshwater Jigs

Ball Head Jig

With or without collars - **bronze** hook



Size	Hook	Unpainted	Painted
1/100	#10	\$.18	\$.49
1/64	#8	.18	.49
1/32	#6	.18	.49
1/16	#4	.18	.49
1/8	#2	.19	.50
1/4	#1	.20	.51
3/8	1/0	.26	.57
1/2	2/0	.28	.59

Swim Bait Jig

Mustad **blk nickel** hook



Size	Hook	Unpainted	Painted
1/8	3/0	\$.40	\$.60
3/16	4/0	.43	.63
1/4	4/0	.43	.63
3/8	5/0	.46	.66
1/2	5/0	.48	.68

X-eye Double Collar Ball

Mustad **blk nickel** hook



Size	Hook	Unpainted	Painted
1/16	3/0	\$.40	\$.60
1/8	3/0	.40	.60
3/16	3/0	.41	.61
1/4	4/0	.42	.62
5/16	4/0	.44	.64
3/8	5/0	.45	.65

Spinner Jig

Mustad **blk nickel** hook



Size	Hook	Unpainted	Painted w/eyes
1/4	4/0	\$.65	\$ 1.12
3/8	5/0	.69	1.16
1/2	5/0	.71	1.18

X-eye Ball Head

Mustad **blk nickel** hook



Size	Hook	Unpainted	Painted
1/8	3/0	\$.40	\$.60
1/4	4/0	.42	.62
3/8	5/0	.45	.65
1/2	5/0	.47	.67

Crappie Swim Bait Jig

Mustad **blk nickel** hook



Size	Hook	Unpainted	Painted
1/16	#2	\$.26	\$.45
3/32	#1	.27	.46
1/8	#1	.27	.46

Spider Jig

Bronze hook



Size	Hook	Unpainted	Painted
1/8	1/0	\$.23	\$.42
1/4	3/0	.24	.43

Swim Bait Weighted Meg Hooks

Mustad **mega bite blk nickel** hook



Size	4/0	5/0	6/0	7/0	8/0
1/16	\$.44	\$.51	\$.55	\$.59	\$.60
1/8	.44	.51	.55	.59	.60
3/16	.45	.52	.56	.60	.61
1/4	.45	.52	.56	.60	.61
3/8	.47	.54	.58	.62	.63

Worm Hook

Gamakatsu hook



Size	Hook	Unpainted
1/32	2/0	\$.50
1/16	2/0	.50
3/32	2/0	.50

Pro Tube Jig

Mustad **blk nickel** hook



Size	Hook	Unpainted
1/16	3/0	\$.35
1/8	3/0	.36
3/16	3/0	.37
1/4	3/0	.37
5/16	4/0	.40
3/8	4/0	.40
1/2	5/0	.43

Tube Jig

Bronze hook



Size	Hook	Unpainted
1/32	#4	\$.18
1/16	#4	.18
1/16	2/0	.23
1/8	3/0	.24
1/4	4/0	.26
3/8	4/0	.28
1/2	4/0	.30

Shad Dart

Gold hook



Size	Hook	Unpainted	Painted
1/64	#6	\$.20	\$.51
1/32	#4	.20	.51
1/16	#2	.20	.51
1/8	#1	.22	.52
3/16	1/0	.26	.56
1/4	2/0	.26	.56

Freshwater Jigs

Bullet Jig

Bronze hook



Size	Hook	Unpainted	Painted
1/32	#6	\$.18	\$.49
1/16	#4	.18	.49
1/8	2/0	.23	.54
1/4	3/0	.24	.55
3/8	3/0	.26	.57
1/2	4/0	.28	.59

Round Nose Jig

Bronze hook



Size	Hook	Unpainted	Painted
1/8	#1	\$.19	\$.50
3/16	1/0	.24	.55
1/4	2/0	.24	.55
5/16	2/0	.26	.57
3/8	3/0	.26	.57

Ned Head

Mustad Black Nickel hook



Size	Hook	Unpainted	Painted
1/16	#4	\$.57	\$.77
1/8	#2	.58	.78
3/16	#1	.52	.72
1/4	#1	.52	.72
5/16	1/0	.55	.75

Football

Mustad blk nickel hook



Size	Hook	Unpainted	Painted
3/16	1/0	\$.32	\$.63
1/4	2/0	.33	.64
3/8	3/0	.36	.67
1/2	4/0	.39	.70

Stand Up

Bronze hook



Size	Hook	Unpainted	Painted
1/8	#1	\$.19	\$.50
1/4	1/0	.24	.55
3/8	2/0	.26	.57

Flat Tri's

Gold hook



Size	Hook	Unpainted	Painted
1/48	#4	\$.20	\$.51
1/32	#4	.20	.51
1/16	#2	.20	.51
1/8	#2	.21	.52

T-Tot

Bronze hook



Size	Hook	Unpainted	Painted
1/16	#6	\$.18	\$.49
1/8	#4	.19	.50
1/4	#2	.20	.51

Drop Shots



Size	Unpainted
1/8	\$.25
3/16	.26
1/4	.26
3/8	.28
1/2	.30
3/4	.34

Ice Ant

Gold hook



Size	Hook	Unpainted	Painted
1/64	#10	\$.21	\$.52
1/32	#8	.21	.52

Freshwater Jig Options

- Single Painted eye add \$.10
- Painted double eye add \$.15 and up
- Metal Flake add \$.09 and up
- Additional color add \$.09 & Up
- Gold hook add \$.03 (if not listed)
- Mustad ultra point black nickel hook add \$.08 (if not listed)
- Prices vary depending on color
- We also stock VMC, Eagle Claw, Gamakatsu & Owner hooks.

Saltwater Jigs

Hot Lips

Mustad hook



Size	Hook	Unpainted	Painted
1/4	2/0	\$.35	\$.67
3/8	3/0	.38	.70
1/2	4/0	.41	.73
3/4	5/0	.50	.83
1	6/0	.62	.96
1 1/2	7/0	.86	1.21
2	8/0	1.06	1.43
3	9/0	1.50	2.23
4	10/0	2.09	2.87
6	10/0	2.70	3.59

Saltwater Ball Head Jig

Saltwater hook



Size	Hook	Unpainted	Painted
1/8	1/0	\$.34	\$.66
1/4	2/0	.35	.67
3/8	3/0	.38	.70
1/2	3/0	.40	.72
3/4	4/0	.48	.81
1	5/0	.60	.94
1 1/2	5/0	.82	1.17
2	6/0	1.01	1.38

Trolling Head



Size	Unpainted	Painted
1/8	\$.26	\$.71
1/4	.27	.72
3/8	.29	.74
1/2	.31	.76
3/4	.38	.84
1	.47	.94
1 1/2	.62	1.12
2	.75	1.28

Buck Tail Jig

Mustad blk nickel hook



Size	Hook	Unpainted	Painted
1/16	1/0	\$.38	\$.70
1/8	1/0	.38	.70
1/4	2/0	.40	.72
3/8	3/0	.43	.75
1/2	4/0	.47	.79
3/4	5/0	.55	.88
1	5/0	.65	.99
1 1/2	6/0	.89	1.24

Buck Tail Jig

Mustad saltwater hook



Size	Hook	Unpainted	Painted
1/16	#2	\$.30	\$.62
1/8	#2	.30	.62
3/16	2/0	.35	.67
1/4	2/0	.35	.67
3/8	3/0	.38	.70
1/2	3/0	.40	.72
3/4	5/0	.50	.83
1	5/0	.60	.94
1 1/2	6/0	.84	1.19
2	7/0	1.03	1.40
3	8/0	1.37	1.85

Barbed Buck Tail Jig

Mustad blk nickel hook



Size	Hook	Unpainted	Painted
1/16	2/0	\$.39	\$.71
1/8	2/0	.39	.71
1/4	3/0	.41	.73
3/8	4/0	.45	.77
1/2	4/0	.47	.79

Fish Jig

Mustad blk nickel hook



Size	Hook	Unpainted	Painted
1/8	2/0	\$.39	\$.71
1/4	2/0	.40	.72
3/8	3/0	.43	.75
1/2	4/0	.47	.79
3/4	5/0	.55	.88
1	6/0	.67	1.01
2	7/0	1.07	1.44

Inhaler Jig

Mustad blk nickel hook



Size	Hook	Unpainted	Painted
1/8	2/0	\$.39	\$.71
3/16	3/0	.41	.73
1/4	3/0	.41	.73
5/16	3/0	.43	.75
3/8	4/0	.45	.77
1/2	5/0	.48	.80

Grub Jig

Mustad saltwater hook



Size	Hook	Unpainted	Painted
1/4	2/0	\$.35	\$.67
3/8	3/0	.39	.70
1/2	5/0	.43	.75
3/4	5/0	.50	.83
1	6/0	.62	.96
1 1/2	7/0	.86	1.21

Bug Eye

Mustad saltwater hook



Size	Hook	Unpainted	Painted
1/4	2/0	\$.35	\$.67
3/8	3/0	.38	.70
1/2	4/0	.41	.73
3/4	5/0	.50	.83
1	6/0	.62	.96
1 1/2	7/0	.86	1.21

Boxing Glove

Mustad saltwater hook



Size	Hook	Unpainted	Painted
3/8	3/0	\$.38	\$.70
3/4	5/0	.50	.83
1 1/2	7/0	.86	1.21
3	10/0	1.76	2.49
6	11/0	2.81	3.80
8	12/0	3.75	4.69

Eight Ball

60 Degree saltwater hook



Size	Hook	Unpainted	Painted
1/4	2/0	\$.35	\$.67
3/8	3/0	.38	.70
1/2	4/0	.41	.73
3/4	5/0	.50	.83
1	6/0	.62	.96

Saltwater Jigs

Style T Jig (Collar)

Mustad **blk nickel** hook

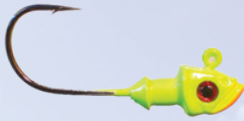

Size	Hook	Unpainted	Painted
1/8	2/0	\$.39	\$.70
1/4	3/0	.41	.73
3/8	4/0	.45	.77
1/2	5/0	.48	.80
3/4	6/0	.57	.90
1	7/0	.68	1.02
2	8/0	1.08	1.45
3	8/0	1.39	2.12
5	10/0	2.40	3.23
7	11/0	3.15	4.06

Manns Head (with or without eye socket)

Saltwater hook



Size	Hook	Unpainted	Painted
1/8	1/0	\$.34	\$.66
1/4	2/0	.35	.67
3/8	3/0	.38	.70
1/2	3/0	.40	.72
3/4	4/0	.48	.81
1	5/0	.60	.94
1 1/2	6/0	.84	1.19
2	7/0	1.03	1.40

Style C Jig

Mustad **blk nickel** hook



Size	Hook	Unpainted	Painted
1/4	2/0	\$.40	\$.72
3/8	3/0	.43	.75
1/2	4/0	.47	.79
3/4	5/0	.55	.88
1	6/0	.67	1.01
1 1/2	6/0	.89	1.24
2	7/0	1.07	1.44
3	8/0	1.39	1.87

Reaper Head

Mustad **saltwater** hook



Size	Hook	Unpainted	Painted
1/4	#2	\$.31	\$.63
3/8	3/0	.38	.70
1/2	3/0	.40	.72
3/4	5/0	.50	.83
1	5/0	.60	.94
1 1/2	6/0	.84	1.19
2	7/0	1.03	1.40

Shad Head

Mustad **blk nickel** hook



Size	Hook	Unpainted	Painted
1/4	4/0	\$.43	\$.75
1/2	4/0	.47	.79
3/4	5/0	.55	.88
1	6/0	.67	1.01
1 1/2	8/0	.91	1.26

Big Eye Jig

Saltwater hook

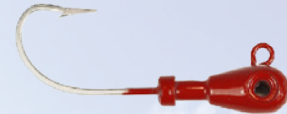

Size	Hook	Unpainted	Painted
2	9/0	\$ 1.34	\$ 1.71
4	9/0	1.98	2.55
6	10/0	2.70	3.59
8	10/0	3.41	4.35
10	10/0	4.09	5.12
12	10/0	4.65	5.76

Saltwater Jig Options

- Metal flake – add \$.11 and up
- Additional color – add \$.11 and up
- Single eye – add \$.10 and up
- Double eye – add \$.15 and up
- Molded bubble eye – add \$.15 and up
- Prices vary depending on color

(Prices may vary on larger items.)

We also stock

VMC, Eagle Claw, Gamakatsu and Owner hooks.

CALL FOR PRICING!

Crank Bait Belly Weight



Size	Diameter	Length	Pricing
2 grams	.235	.275	\$.21
3 grams	.250	.350	.21
4 grams	.250	.480	.22
5 grams	.250	.640	.22
6 grams	.315	.460	.23

Terms & Conditions

- **Terms:** Credit card or cash in advance until credit has been established. Up to net 30 days will be offered to approved accounts.
- **Freight:** All orders will be shipped UPS unless otherwise specified. Larger volume orders may be shipped via truck line. Shipping and handling charges will be billed on your invoice, unless other arrangements have been made. All prices are F.O.B. Springfield, IL
- **Excise Tax:** Any item subject to Federal Excise Tax will have a 10% tax added to the invoice unless a current copy of your company's IRS form 637 is on file in our office.
- **Delivery Time:** All orders are scheduled for production as they are received. Lead-time will vary depending on the specific items, volume of product ordered, and the number of orders already in house.
- **Past Due Accounts:** No product will be manufactured or shipped to any customer with a past due account. Customers who abuse the terms of their account, will lose the privilege of an open account. If payment cannot be made on time, please call us to make arrangements. Any account that is 30 days past due will be charged interest at a rate of 10% per month (18% Annually). Accounts 90 days past due will be turned over to collections. A collection charge will apply on reinstatement of the account.
- **Patents:** When placing an order for products, the purchaser warrants that the finished product is and will not be infringement of any valid patents or trademarks. The purchaser further agrees at his/her own expense to defend any and all actions and suits that may be brought against them and their product.
- **Prices:** Prices are subject to change without notice. A good faith effort will be made on the part of Cast Industries to inform customers of any foreseen price increases.
- **Minimums:** Our minimum order is \$150 per line item. We do accept smaller orders for a \$10 set-up fee.
- **Discounts:** Cast Industries does offer various discounts to high volume customers and large quantity orders.

Office hours: Monday – Thursday 7:00 am to 4:30 pm CST

Buzz Blades

B4 Aluminum Buzz Blade

Requires two per bait

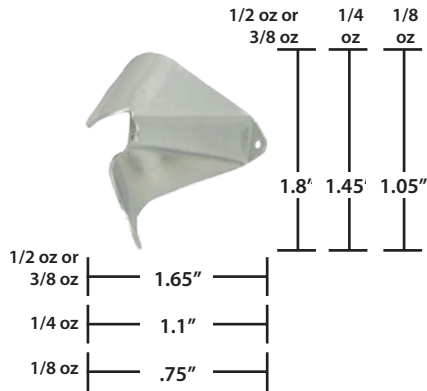

Style	Size (oz)	Per Piece	Pack Size
B4	1/2 or 3/8	\$.22	250
B4	1/4	.21	250
B4	1/8	.20	250

Double Buzz Blade



Style	Size (oz)	Per Piece	Pack Size
(B)	1/2	\$.20	250
(D)	1/4	.19	250

Clacker Blade

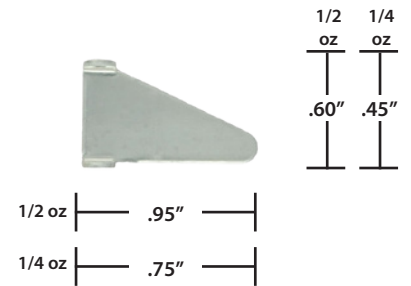

Size (oz)	Per Piece	Pack Size
1/2	\$.05	1000
1/4	.05	1000

The B4 aluminum blades are intended for a use of two per bait. They're also off-center blades with two 45° angles formed parallel to the wire shaft. The higher density of water drives one blade into the other blade, which is in the lower density of air causing a clicking noise. It is intended for the B4 blade to be tuned during the assembly process. Roll the hammering blade to create as much noise as you want. The more you roll it, the more noise up to a point you will make. The fisherman can change the tuning on this blade to meet his circumstances. All B4 aluminum blades are available in CCW only and they will not need a clacker blade.

Blades B & D are our Double Buzz Blades. They are designed to use in tandem with counter-rotating blades. Available in CW or CCW.

An Aluminum Clacker Blade may be used in conjunction with all the Buzz Blades for an increased noise output.

**We can Powder Paint any blade for .42 each! (250 min.)
What color do you want?**

Single Aluminum Buzz Blade

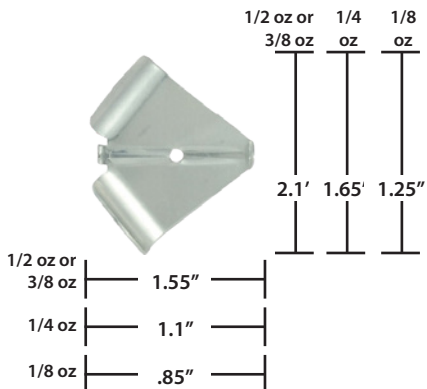

Style	Size (oz)	Per Piece	Pack Size
A	1/2-3/8	\$.22	250
C	1/4	.21	250
E	1/8	.20	250

Off-Center Aluminum Buzz Blade

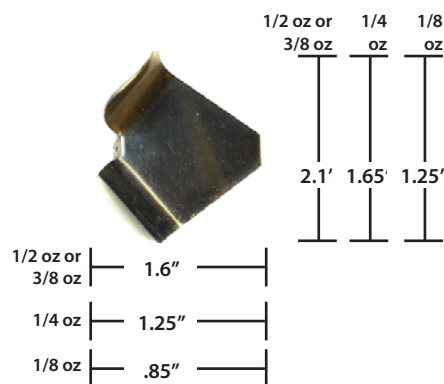

Style	Size (oz)	Per Piece	Pack Size
(F)	1/2	\$.22	250
(G)	1/4	.21	250
(H)	1/8	.20	250

Plastic Buzz Blade

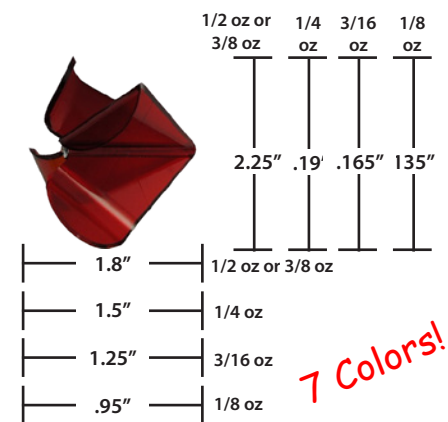

Size (oz)	Per Piece	Pack Size
1/2-3/8	\$.41	100
1/4	.38	100
1/8	.35	100

7 Colors!

We produce several types of aluminum buzz blades. These three blades are single, free spinning blades or on-center blades, meaning that their axis of turning and center of gravity are located at the wire form. This setup will give you excellent lift and a continuous spinning action. Blades A, C, and E turn clockwise (CW) and counter-clockwise (CCW). The A and C blades are also available with two holes. All aluminum blades are made out of high luster aluminum for great trust resistance and better light reflection.

Blades F, G and H are off-center blades. Their axis of turning is around the wire form and their center of gravity is not. This creates a gyrating and spinning motion. Blades F, G and H turn CW and CCW. The F and G blades are also available with two holes. CW or CCW is determined by looking at the blade as it is coming toward you in the water. The F style blade can also be ordered with the center cut out. This allows you to assemble a B4 1/8oz plastic blade inside the F-cutout blade. The cutout blade is CCW and the plastic blade spins CW.

Our Plastic Buzz Blades come in four sizes. The material used is virtually unbreakable. The customer has their choice of seven colors; Black, White, Clear, Chartreuse, Chartreuse with silver flakes, Clear with silver flakes and Ruby Red. Each blade comes with a pop-rivet collar. These are also free spinning blades and are ideal for a slow retrieval. CW ONLY.

Specialty Buzz Blades

F or G Aluminum Buzz Blade with 2 Holes

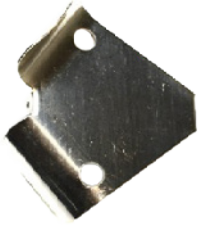

Size	Per Piece	Pack Size
1/2 - 3/8	\$.24	250
1/4	.23	250

A or C Aluminum Buzz Blade with 2 Holes



Style	Size	Per Piece	Pack Size
A	1/2 - 3/8	\$.24	250
C	1/4	.23	250

F Aluminum Buzz Blade with Cut-Out



Style	Per Piece	Pack Size
F (Cut-Out)	\$.25	250

F or J Aluminum Buzz Blade .032 Material

The J blade is the size of the A blade, but is formed as the F blade.



Style	Size	Per Piece	Pack Size
F	.032	\$.24	250
J	.032	.24	250

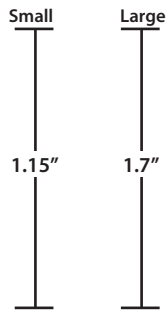

Shaker Blades

Style	Per Piece	Pack Size
Small	\$.19	250
Small (with 2 Holes)	.19	250
Large	.24	250
Large (with 2 Holes)	.24	250

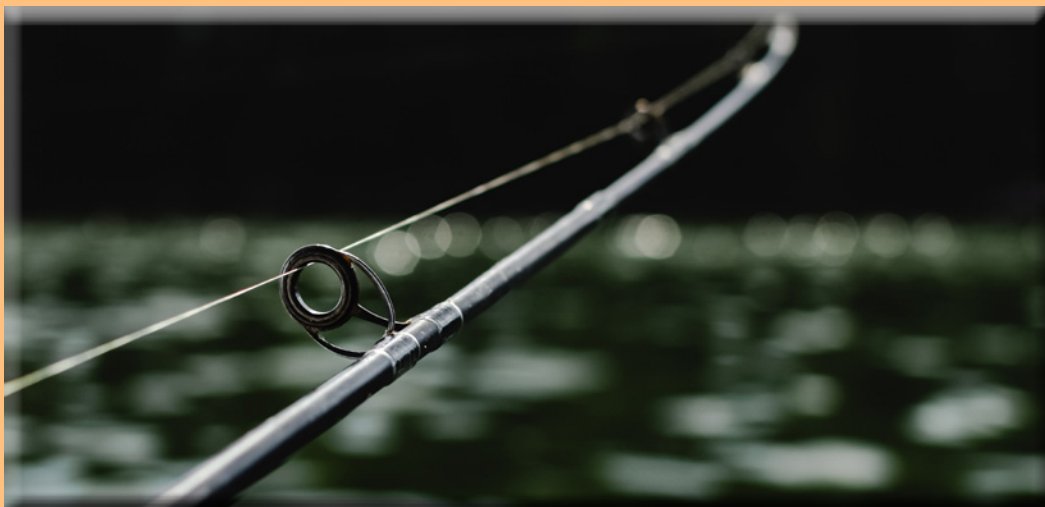
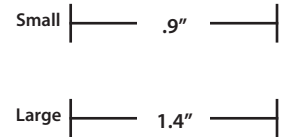

Pop Rivet Collars



Size	Per Pack	Pack Size
Small	\$ 24.00	1000
Medium	24.00	1000
Large	24.00	1000

LurePartsOnline.com AnglersWorkshop.com 2024 Catalog

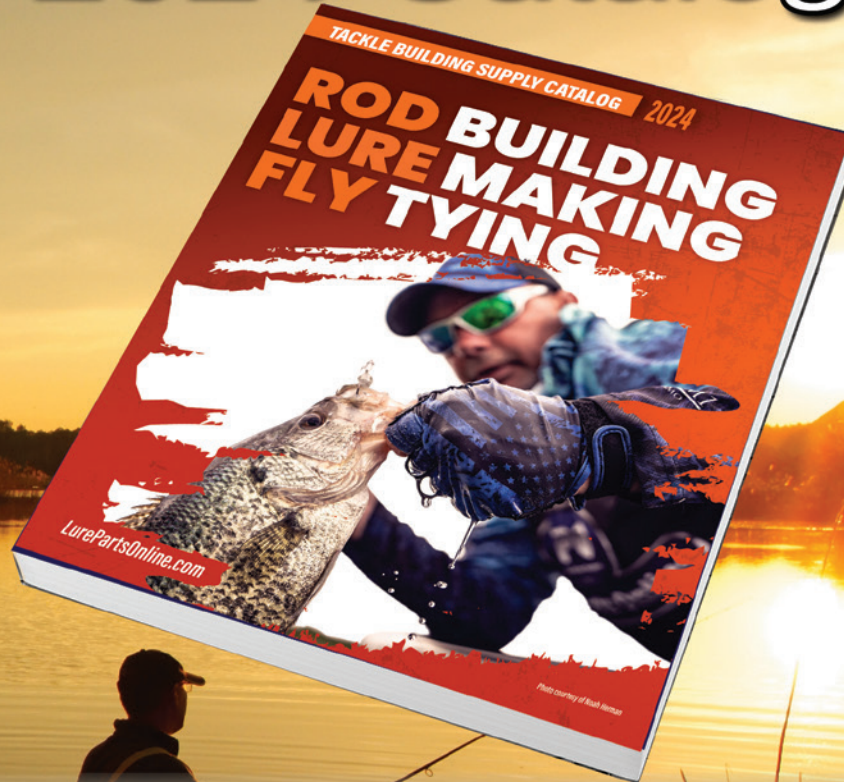

Get yours now at
www.LurePartsOnline.com
In partnership with Cast Industries



cast industries, inc.

where quality and speed matter

580 north street • springfield, illinois 62704

217-522-8292 • fax 217-522-8378

www.castind.com • jim@castind.com