

PTSS TYPE 1 USER MANUAL



PORTABLE
TRAFFIC
SIGNALS

DEVICE DESCRIPTION



This Portable Traffic Signal Set (PTSS) device is approved as a TYPE 1 device under the specification.

- In this manual the Remote Control will be called the "HRC" and the signals will be called "signal/s".
- The PTSS includes 3 modes of operation - Gate and Shuttle and Plant Crossing (for NSW) modes.
- HRC can operate a maximum of 2 signals.
- Can only be operated by a traffic controller using the wireless HRC - there is no wired controller or button operation at the signal head- no auto mode.
- Has been designed for short term / shift use - NOT to be left on site unattended.
- Manual control only - The device can only be manually controlled by an authorised controller. No sensors or timing functions are included.
- Battery powered - This device operates with rechargeable Lithium Ion Phosphate batteries, no mains powered operation is intended.
- Batteries will need to be recharged daily (depending on duration of use) to ensure sufficient power levels to complete the next shift requirement.
- The HRC can be used with any single or pair of signals - The kits you buy can be swapped in / out and all devices will simply work together as intended - No locked pairing for devices.
- HRC is designed for outdoor use in direct sunlight, utilising an OLED display to ensure visibility regardless of the conditions.
- The control system has been designed to force users into operating the PTSS using best practice procedures as outlined in the specification.
- All notices, errors, faults, device condition and current state is reported to the user for easy and intuitive operation via LCD screen.
- The PTSS has been designed as 'plug & play' and the HRC will step the user through the process from system startup and validation to operation.



SPECIFICATIONS & CARE



SPECIFICATIONS & CERTIFICATIONS

Your entire new PTSS kit:
Meets AS4191 (with Variation)

State Approvals Certificate:

Includes the following:

QLD - MRST 264

NSW - RMS TSI-SP-049

WA - REF 16/7622

SA - As AS4191

Mechanical & Physical requirements:

Meets MRTS201

Signal Head:

Certified under AS2144

Ingress Protection of enclosures:

Certified under AS60529

Painted Surface finishes:

Complies with AS2700 and AS4191

Critical Fault Operation:

Meets requirements of AS4191

WARNINGS

Your new PTSS kit is designed to reliably withstand daily use under all expected onsite conditions. While all design considerations have been explored to provide you with the most refined and thoughtful PTSS on the market, some care when installing, stowing and transporting the device is required:

- Avoid dropping the signal head - while the enclosure is made from high impact plastic, dropping may cause breakage of the enclosure or visors.
- Avoid potential water damage - submersion of the signal head or HRC will damage the device. During hose cleaning of the signal head, ensure you use low water pressure and ensure all compartments are closed and snapped into place.
- Avoid excessive overheating - The signal head is designed to be installed and operate in outdoor or full sun conditions. The HRC is a device that should be treated like your phone. Avoid excessive heat exposure and excessive direct sun.
- Do not attempt to disassemble the HRC or signal device electronic components- this will void your warranty and may damage the device.

NOTICE- To ensure a long and trouble free service life: Setup, operate, stow and transport your new PTSS device as directed in this manual.



**PORTABLE
TRAFFIC
SIGNALS**

CONTENTS



WHAT'S IN THE KIT _____	1
DESCRIPTION _____	1
DEVICE SPECIFICATIONS _____	1
CONTENTS _____	2
SAFE TRANSPORTATION & STORAGE _____	3
SUITABLE LOCATIONS FOR INSTALLATION _____	4
ON-SITE INSTALLATION _____	5
QUICK START GUIDE _____	6
SETUP & TURNING ON	
SELECT MODE OF OPERATION & PAIRING START UP PROCEDURE	
OPERATING THE SIGNALS	
TURNING OFF & PACKUP	
USING THE REMOTE CONTROL _____	9
KEYPAD EXPLAINED	
SCREEN EXPLAINED	
SYSTEM TEST EXPLAINED	
ALARMS, NOTIFICATIONS & ERRORS	



WHATS IN THE KIT?



- 1. Australian Standard approved signal head
 - 2. Signal aspect visors
 - 3. Signal head panel
 - Signal on / off switch
 - Backup power connection
 - Charging port socket
 - LED 'RED ASPECT' indicator light
 - 4. Target Board mounted and removable
 - 5. Tripod / Mount
 - 6. Hand Held Remote Control (HRC)
 - 7. HRC & LH Charging pack
 - 8. Robust hard case for HRC and LH Battery/Charger
- Accessories**
- 9. Kit Bag
 - 10. In car charging cradle (HRC)
 - 11. Sandbags - Tripod Ballast
 - 12. Tripod Bag



DEVICE SPECIFICATIONS



DEVICE SPECIFICATIONS



SIGNAL HEAD

- Optical System IP65
- Enclosure IP45
- Aldridge Signal head approved under AS2144
- Wireless communication range tested to 1000m
- Communication frequency 2.4GHz
- Mass: 12kg (with battery and backboard)
- Dimensions: 330x500x1040 (backboard folded)
- 12V DC, Lithium Iron Phosphate (LiFePO4) battery
- Battery life: 20 hours of continuous use from fully charged
- Charge time: 4 hours using supplied charger

Tripod Mount

- Material type: Aluminium grade 6063T5
- Construction: 3 Parts
- Finish: X15 Safety Orange
- Ballast hooks / locations: Base - 3 sandbags - 7kg min each
- Capability: Installed on up to 10 deg slope
- Mass: 3.9kg
- Dimensions:

Collapsed: 1020x200x200mm

Open: 1200x1200x1600mm

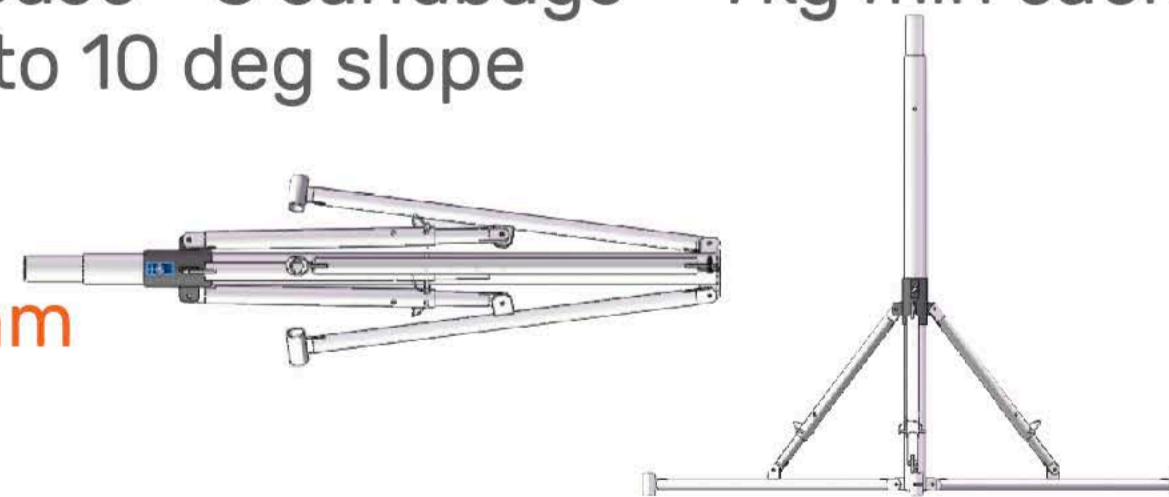

HRC

HRC Case IP65

- 3.7V DC, Lithium Ion battery
- Battery life 28 hours of continuous use
- Charge time: 3.5 hours using Qi wireless charger
- Wireless communication range tested to 1100m
- Communication frequency 2.4GHz
- Mass: 280grams
- Dimensions: 146x88x33mm



PORTABLE
TRAFFIC
SIGNALS

TRANSPORTATION & STORAGE



TRANSPORTATION

- The method of stowing your device kit should always comply with applicable local laws in your region or state in relation to securing your load.
- The use of retainer bars, cage or cabinet in the cargo area of your vehicle is recommended over the use of a ratchet strap directly over the device - this may cause unwanted mechanical stress and potential damage to the signal head.
- We recommend the use of vehicle mounted lockable retainer bars, cages or cabinets to prevent movement during transportation or theft of the kit.
- To ensure the kit remains together and components aren't lost or damaged, we recommend the use of the optional case for your kit when being transported or stored.
- If you choose to use mounting brackets or some other device to stow the signal head for transport, we recommend you have these installations engineer designed to withstand the various dynamic load requirements generated by a moving vehicle.



STORAGE

- Disconnect the battery & Charger pack from the signal while in storage. The external switch on the signal head will disconnect the battery to meet this need. - Ensure remote is OFF
- If longer term storage of the device is required, we recommend that it is stored undercover and out of the elements to avoid any potential damage to the signal head, HRC or charging devices due to water or excessive heat.
- Storage and transportation temperatures should remain between -10 and 48 degrees to avoid damage.

PORTABLE
TRAFFIC
SIGNALS

SUITABLE INSTALLATION LOCATIONS



ENSURE

- Ensure installation is on solid ground. Sealed or compacted road surfaces are recommended for installation while the location remains compliant with your TGS, TMP, internal company SWMS and local device regulation.
- Ensure you adjust the tripod to make the signal head as upright as possible.
- Ensure the use of sandbags or other ballast on tripod legs to ensure stability in windy conditions.
- Ensure you have the required sight distance to the signal for an approaching motorist.
- Ensure the installation of all compliance signs and devices related to the installation of the PTSS as per your TGS

NOTE: PTSS installation should always be as per your approved Traffic Guidance Scheme or Traffic Management Plan. If this is not possible, please refer to your internal company processes for seeking advice and having the TGS or TMP update to ensure compliance of the installation



AVOID

- Avoid muddy or soft ground where the tripod legs could sink over time and topple the signal
- Avoid excessively unlevel ground. However, if after adjustment, the signal is still not upright, then a new location should be identified and the signal moved.
- Avoid using other equipment or devices to pack or chock up legs of the tripod - this creates another point of failure and may result in the signal toppling over
- Avoid installation against a power pole, tree, street sign or any other road sign that may obstruct access and view to the rear of the signal head
- Avoid installation that obstructs motorists or pedestrians, this creates an additional hazard on your site.

A graphic with a colorful, geometric background of orange, red, and yellow shapes. The text 'PORTABLE TRAFFIC SIGNALS' is written in a bold, white, sans-serif font across the center.

**PORTABLE
TRAFFIC
SIGNALS**

ON-SITE INSTALLATION PROCEDURE



1
CLOSED POSITION



2
TO EXTEND - PULL LOCKING PIN



3
SLIDE TO OPEN AND LOCATE PIN
ENSURE CENTER POST REMAINS
OFF THE GROUND FOR STABILITY



4
REMOVE HEAD FROM BAG



5
DETACH SIDE BOARDS FROM STOWED
POSITION AND
INSTALL IN OPERATIONAL POSITION
FOLLOW THE COLOURS



6
ATTACH TRIPOD POST
TO LIGHthead



7
TIGHTEN LOCKING SCREW
TURN POWER TO ON
LED BUTTON WILL ILLUMINATE



9
LIFT LIGHT HEAD
INTO PLACE ON TRIPOD



10
SECURE AND TIGHTEN
ALL LOCKING SCREWS



11
ADJUST ANGLE OF TRIPOD
WITH ADJUSTMENT LEG
- APPLY BALLAST / SANDBAGS
TO STABILISE



12
HANG BATTERY BOX AND
CONNECT BATTERY CABLE



RETRIEVE REMOTE CONTROL
AND FOLLOW INSTRUCTIONS

QUICK START GUIDE



NOTES TO KEEP IN MIND

- The 'MENU' button is also the 'BACK' button.
- Each time you setup and start the PTSS system, you will need to pair the signals - This process is quick and easy.
- When pairing, whichever signal you select as 'Signal #1' will become 'Unit 1' on the HRC keypad.
- If an error is displayed on the screen, all paired signals will turn to RED automatically.
- The HRC will force you into a procedure for mode selection, pairing, startup and position fixing
 - This has been done this way make your experience as easy as possible and so you can't get lost in the menu. Follow the on screen instructions and you can't go wrong.
- The signals and HRC are not exclusive to each other. Any HRC can be used with any unpaired signal/s
 - Ensure you visually confirm the signal serial numbers when pairing.
- The HRC and each signal will keep a log of every button press and action performed
 - This could be useful when investigating incidents or verifying usage times.
- During operation, the HRC will ask you to confirm each button press
 - ie: if you press "Unit 1 GREEN", the HRC will ask you: "Turn Unit 1 to GREEN?", you will need to 'OK' these questions before the system will action the change or press 'MENU' to cancel.
- You can enter the main menu at any stage during operation. This will allow you access to 'Set Position' in the case of a signal being moved and a GPS alarm sounding.
- Accessing 'Mode' from the main menu will generate the question "Do you want to change the MODE?", if you press 'OK', the HRC will show the 'MODE' menu and the existing signals will unpair from the HRC. When you select the new mode, you will then be guided through the pairing process again.
- GPS is automatically enabled for every new session. If you are working underground or in a built up area where GPS signals are weak, you may get 'GPS' errors on the HRC. If this is the case, then you are able to turn OFF the GPS capability for your session from the "GPS" item on the main menu.

QUICK START GUIDE



In this Guide, you will learn:

1. Turning on,
2. Select mode of operation
3. Pairing,
4. Start Up Procedure,
5. Operating the signals in each mode, and
6. Turning off & packup

This Guide assumes you have already followed the instructions for the installation location and assembly of the PTS and have the system ready to start working.

1. Turning On



back button photo

Signals: After setting up tripod and mounting the signal head (see "On Site Installation"), you can activate the on/off switch by moving the toggle to the "ON" position. (for switch position, refer to "What's In The Kit" section at the beginning of this manual)

HRC: On the HRC remote you will see a power button in the top left, press and hold this for 2 seconds, the HRC screen will light up to indicate it is on:



2. Select mode of operation

The HRC will guide you through the setup process, only giving you the options for the next step you need to perform. After the HRC has turned on, you will see the "Mode" screen. Select the mode you want to operate in.



NSW

Shuttle:

Shuttle mode will only allow one signal to be GREEN at a time. Used for 'Stop/Slow' shuttle conditions (2 signals paired with 1 remote).

Gate:

Single mode is used for control of 1 direction of traffic at one time (1 signal paired to 1 remote).

Plant Crossing (NSW):

Gate Mode only allows signals to operate as RED/RED or GREEN/GREEN. This is used where all traffic in both directions needs to stop. Eg: Where plant crossing occurs (2 signals paired with 1 remote).

3. Pairing

After you select the required mode, the pairing screen appears asking you to select Signal #1. All signals turned on and not already paired will be displayed. Confirm the numbers on your signals against the list shown as available on the HRC screen.



PORTABLE
TRAFFIC
SIGNALS

QUICK START GUIDE



3. Pairing - Continued

After you have selected #1 Signal (if 2 signals are required for the MODE selected) the HRC will change and ask you to select the #2 Signal and will indicate which is 'Signal #1'. Automatically after pairing all required signals, the system performs a self test as shown in the screen to the right.

V= verified, O= Establishing, X= NOT verified
 (you may need to troubleshoot if not all 'V' or 'O')
- PRESS OK.



4. Start Up Procedure

After components are verified and the screen to the right shows verifying MODE selected, signals PAIRED and TEST complete, **press and hold for 5 seconds the 'LIGHTHEAD POWER' button** on HRC - this will turn the Signal Aspects ON. The START option now appears. Select it and **PRESS OK.** The system will now lock the GPS, YAW and TILT position at point in time. The HRC will show the status of these locked positions (V= verified, X= NOT verified), **PRESS OK.**

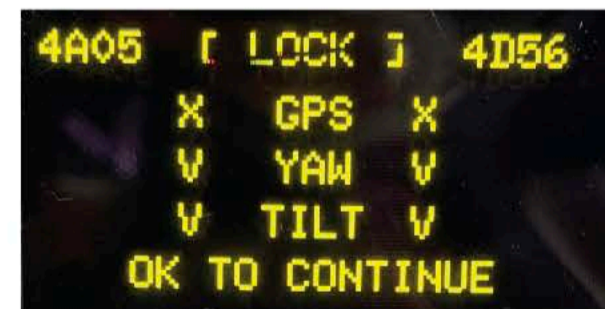
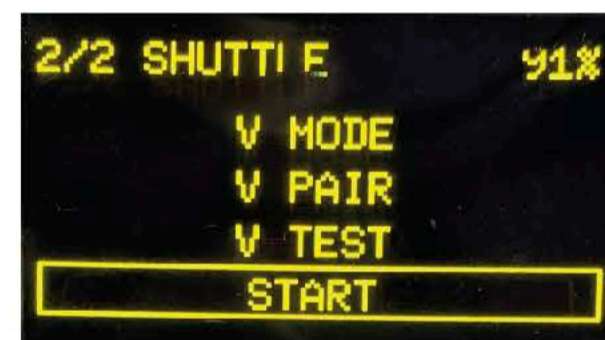

4. Start Up Procedure - Continued

After you press OK, the Signals will go to flashing AMBER for 5 seconds then go ALL RED.

The HRC will show "STARTUP..." to confirm, then the Operating screen. The HRC will count down each time after a signal changes to RED. This is required to allow a minimum RED interval of 5 seconds. When the countdown is complete, you can commence operating the signals.



5. Operating the signals in each mode

Introduction to the Operating Screen

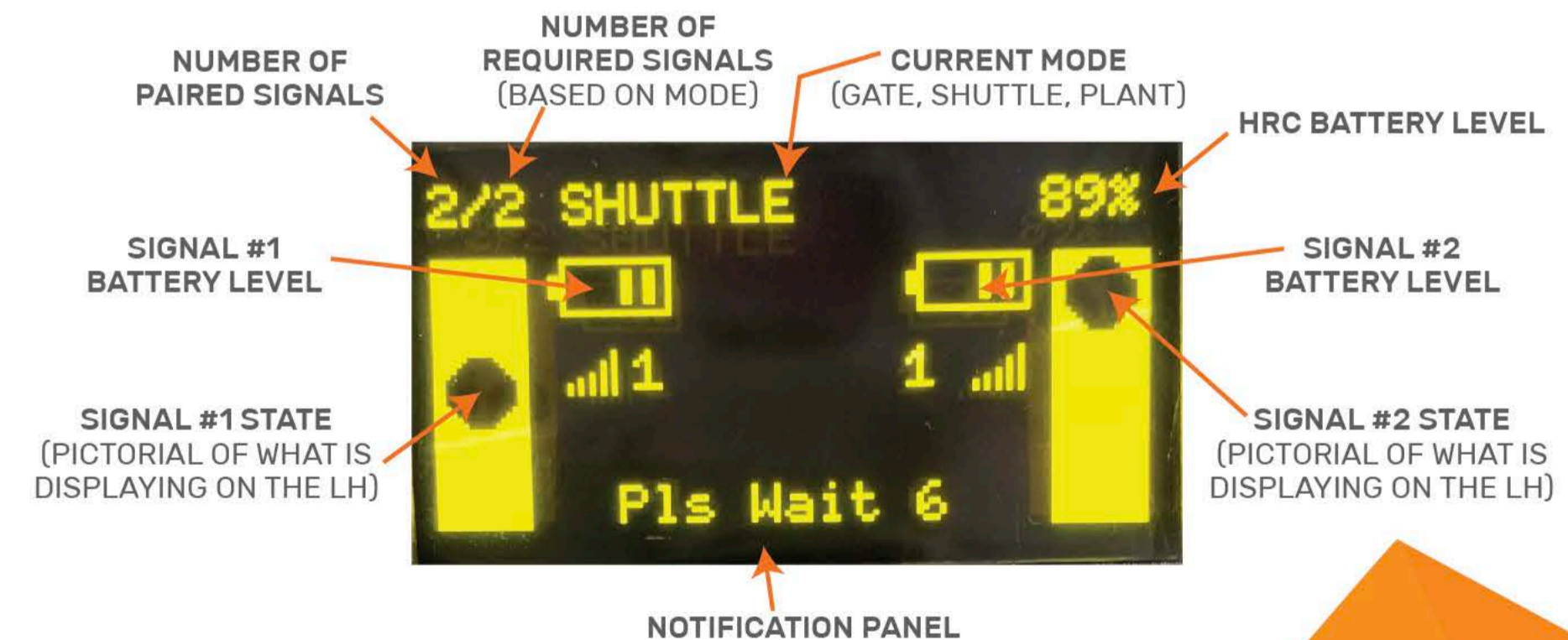

QUICK START GUIDE



5. Operating the signals in each mode - Continued

Introduction to HRC Keypad

Power Buttons:

CONTROLLER POWER - will power down the HRC. If operating signals when you power off the HRC, all will go to AMBER then RED.
LIGHTHEAD POWER - will turn off power to the signal aspects. This means no RED, AMBER or GREEN will display.

Buttons for operation:

Unit 1 GREEN - will turn paired Signal #1 to green (from ALL RED only).
Unit 2 GREEN - will turn paired Signal #2 to green (from ALL RED only).
RED ALL - will turn any green signals to AMBER for 4 seconds, then RED.

Menu Buttons:

MENU - will show the main menu from any screen when pressed. Will also exit menu when pressed while in the menu.
ENTER - to select an item or 'OK' notification
UP & DOWN - Used to navigate menu.



5. Operating the signals in each mode - Continued

NOTES:

- When using in GATE mode, only 'Unit 1 GREEN' button will be operable,
- Pressing 'RED ALL' will generate the on-screen notification "ALL RED?" which requires the user to press 'Enter' to proceed,
- Pressing 'Unit 1 GREEN' or 'Unit 2 GREEN' will generate the on-screen notification "Turn Signal #X to GREEN?" which requires the user to press 'Enter' to proceed,

6. Turning off & packup

Refer to your internal SOP for site shut down & re-opening of the road - this section refers only to the process for turning off the PTSS

- Press & Hold 'LIGHTHEAD POWER' button for 5 seconds until signals are off and not displaying any coloured light,
- When signals are visually confirmed as OFF, Press & Hold the 'CONTROLLER POWER' button for 5 seconds and the HRC will power down,
- Switch the signal head power switch to OFF position,
- Unscrew signal head mounting from tripod,
- Lift the signal head off the tripod and stow as appropriate,
- Remove any ballast & fold down the tripod and stow.

NOTES- Ensure you place the HRC and Signal Heads on charge using the supplied chargers for wall plug or 12V vehicle supply to ensure they are charged for next use.



TROUBLESHOOTING GUIDE

ALARMS, NOTIFICATIONS AND ERRORS

SIGNAL #1 LOW BATTERY Audible alarm, vibration & onscreen	The battery in signal #1 has 60 minutes remaining
TILT ALARM SIGNAL #1 Audible alarm, vibration & onscreen	Signal #1 has tilted greater than 20 degrees. eg: it has been pushed over.
GPS ALARM SIGNAL #1 Audible alarm, vibration & onscreen	Signal #1 has registered that the signal has moved more than 30 meters. This can mean it has been moved, or it can falsely trigger when low GPS signal is being experienced. You can turn GPS off for your session in the Main Menu.
HRC LOW BATTERY Audible alarm, vibration & onscreen	The battery in the HRC has 60 minutes remaining.
SIGNAL #1 DISCONNECTED Audible alarm, vibration & onscreen	Communication has been lost with Signal #1. This could indicate an 'undefined fault or system crash'. Select Mode and then re-pair signals to continue operation. If unable to re- pair and continue, refer to your work instruction for this critical error.
YAW ALARM SIGNAL #1	This indicates that the signal head has been turned from its original facing position. Visually inspect and when positioned, use "LOCK POSITION" from main menu to lock position.
RED ASPECT FAULT	The RED LED aspect is not displaying Refer to your work instruction for this critical failure
AMBER ASPECT FAULT	The AMBERLED aspect is not displaying Refer to your work instruction for this critical failure
GREEN ASPECT FAULT	The GREEN LED aspect is not displaying Refer to your work instruction for this critical failure

BATTERY



SIGNAL HEAD BATTERY

- Battery Chemistry Type: Lithium Iron Phosphate (LiFeP04)
- Capacity: 25 Amp Hour at 12V
- Operating temp. -10 to 55 degrees celsius
- Life Cycles: 1000 charge / discharge cycles
- Depth of Discharge: 80%
- Active usage time of signals (per full charge): 24 hours (min)
- Charging time from completely flat battery: 7.5 hours.
After 10 hour shift will be ~3 hours
- Charging protection: Built in battery management system to ensure overcharging is not possible
- Charging: Supplied 240V wall charger- 14.6V at 4.5 Amps

How to Charge - Simple Process

1. Simply connect charger in battery pack to wall outlet and turn outlet ON (green LED will show RED when charging)
2. When the signal has finished charging, the LED indicator on the charger will change to green,
3. HRC will charger from charging mat provided. Whenever placed in storage

*Providing there is charge in the battery



HRC BATTERY

- Battery Chemistry Type: Lithium Iron Phosphate (LiFeP04)
- Capacity: 1.2 Amp Hour at 3.7V
- Operating temp. -10 to 55 degrees celsius
- Life Cycles: 1000 charge / discharge cycles
- Depth of Discharge: measured to 90% (minimum)
- Active usage time of HRC (per full charge): 86 hours (minimum)
- Charging time from completely flat battery: 1.5 hours (using 2A USB port and supplied Qi charger)
- Charging protection: Built in battery management system to ensure overcharging is not possible
- Charging: Supplied USB Qi wireless charging pad

HRC Charging:

HRC charges on any Qi 10W charging mat. This allows in car or desktop charging when away from the battery pack provided



DEVICE MAINTENANCE



SIGNAL MAINTENANCE

- Batteries in your device are maintenance free.
- Follow the battery charging instructions in the 'Signal Head Battery' and 'HRC Battery' section
 - these can be charged daily.

Signal Head

Signal heads will accumulate dust and minor debris from standard use. Any damage to the signal head should be reported and recorded and advice sought from manufacturer to assess for any required repairs.

- Remove dust or debris wiping with a cloth or small brush,
- Mild cleaning detergents can also be used (no harsh chemicals designed for bathrooms or industrial use),
- Be sure to avoid spraying water or chemicals directly into openings in the signal casing,
- For heavy soiling, you can also use a low pressure hose and water to clean the signals off.
- While cleaning, inspect for cracked casings, or other broken or damaged components,
- After cleaning & Inspection, check for normal operation.

NOTE - The signals are designed to be protected from water coming from above (ie: rain), be sure not to spray water up into any power connections or switch casings. Stand signals in the upright position and spray with water from above (simulate rain).



HRC MAINTENANCE

- The HRC is designed for maintenance free, daily use and is IP65 rated. This means it is protected from dust and water ingress so it can be cleaned.
- Remove dust or debris wiping with a cloth or small brush,
- Mild cleaning detergents can also be used (no harsh chemicals designed for bathrooms or industrial use),
- Avoid scratching or peeling away the keypad overlay on the HRC,
- For heavy soiling, you can use small amounts of water to wash off the HRC,
- While cleaning, inspect for cracked casing, or other damaged components (the overlay),
- After cleaning & Inspection, check for normal operation of the HRC.

NOTE - HRC is not designed to be submerged or subjected to powerful streams of water.



TROUBLESHOOTING GUIDE



HRC is not turning on	Ensure you press the on/off button on the HRC for 2 seconds to activate. Ensure the HRC battery is charged
The signal I want to pair with is not showing up in the HRC list	Ensure the signal is turned ON. Ensure the signal is charged. Go back to 'Mode' list and select again to refresh the available signal list.
After pairing and testing, the signals won't turn on	Ensure you press the 'Lighthouse ON/OFF' button on the HRC for 5 seconds to activate.
HRC LOW BATTERY Audible alarm, vibration & onscreen	The battery in the HRC has 60 minutes remaining.
HRC shows tilt / yaw / movement alarms	Usually this means that the signal has been moved or its facing altered from when the position was fixed. Confirm the position is correct and then FIX position from the HRC menu.
HRC is not charging	Ensure the charging pad is plugged into a wall USB adapter and the HRC is positioned in the centre of the pad.
Signal tilt alarm keeps going off	This means the signal has been tilted over or has been installed on a gradient more than 20 degrees. Straighten the signal tripod.
Signal keeps dropping out of communication (error notice on HRC)	This can happen over long distances in heavily built up areas (eg: over 200m around a corner in the CBD). Ensure you have line of sight to each of the signals - look to change the arrangement as per compliance requirements.
GPS alarm keeps going off	This can happen when in built up areas (or in tunnels etc) and GPS signal is difficult to maintain. Press MENU on HRC and follow items to GPS > OFF. This will disable the GPS alarms until your re-pair signals again.
Aspect fault error (RED, AMBER or GREEN)	Visually inspect the aspects to confirm there is a fault. If a confirmed fault, take action as per your work instruction for this circumstance. Escalate to product service center. If no confirmed fault, select mode again and re-pair the signals and escalate to product service center.
Signal battery is not charging	Ensure the signal on/off switch is in the ON position when charging.

COMPLIANCE REQUIREMENTS



Commencing on 1 July 2018, PTSS should be used, in lieu of Traffic Controllers using STOP / SLOW bats, on roads with AADT exceeding 1000 veh/day and approach speed limit (prior to the works occurring) of 80 km/h or faster.

A PTSS operating under manual mode may be used to control traffic at the approach legs to an intersection (signalised or unsignalised) under the same procedures as Traffic Controllers using STOP / SLOW bats. If all approaches are controlled by PTSUs each approach may be independently controlled by a Traffic Controller (one TC with one HRC controlling a PTSU).

PTSUs, when not in use, shall face away from traffic or be covered and all signs for the device shall be removed or covered.

There may be times where traffic control at a three- or four-leg intersection with a prominent traffic flow path may be managed using a PTSS (two PTSUs paired with a single HRC) under manual control for the prominent traffic flow path (normally the through-leg movements). A TC with a STOP / SLOW bat or a PTSU with an individual HRC is required to control traffic on the terminating or each minor approach legs.

A Type-1 PTSS shall only be used instead of Traffic Controllers manually controlling with STOP / SLOW bats when single-lane operation is required. Type-1 PTSS shall consist of either one or two PTSUs paired with a single HRC operated by a Traffic Controller.

When operating 2 signal units with one HRC and where visibility to both signals is obstructed:

- two Traffic Controllers (one per PTSU) are required
- the operating procedure is as per standard stop / slow arrangements
- only one of the two Traffic Controllers will operate the PTSS with a fully functional HRC: the other Traffic Controller monitors the other PTSU and associated traffic and provides information to the operator
- Each Traffic Controller shall be equipped with radio communication.

A PTSS consisting of two or more PTSUs (not paired) with each PTU being controlled by a single HRC may be used under the following conditions:

- Where visibility to both PTSUs and approaching traffic from both directions by one traffic controller is restricted,
- Where a single HRC cannot communicate effectively with both PTSUs,
- Where traffic control is required at intersections or for plant crossing,

In any of these cases the following will apply:

- traffic controllers (one per PTSU) are required,
- each traffic controller has an HRC controlling a single PTSU,
- the operating procedure is as per standard stop / slow arrangements,
- each traffic controller shall be equipped with radio communication.

NOTE: Refer to the CURRENT MUTCD Part 3 Supplement for full details and DTMR conditions in relation to compliance matters for the selection and operation of these portable signals.

Reference also the Ausroads Guide to Temporary Traffic Management

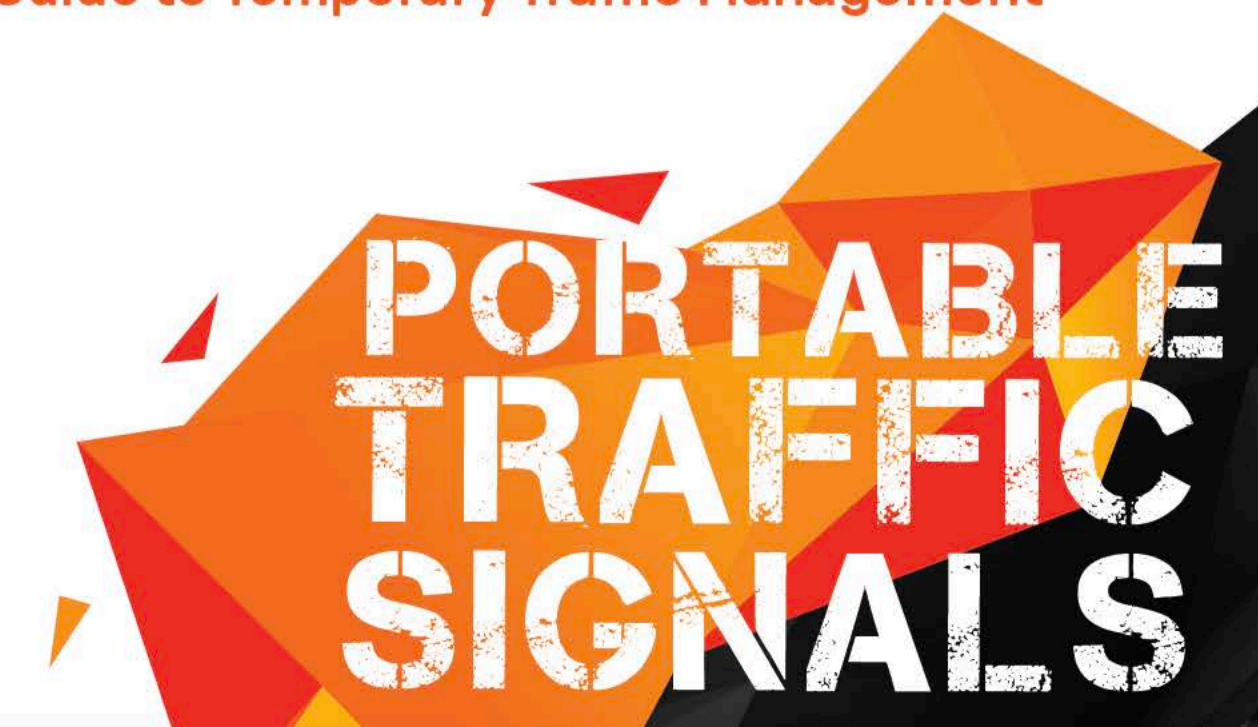

ADDITIONAL EQUIPMENT & DEVICES

SIGNAGE

DO NOT OVERTAKE

R6-6-Q03
1200x600

TC1174
1200x300



TC1216
600x600



TC1947_1
600x600

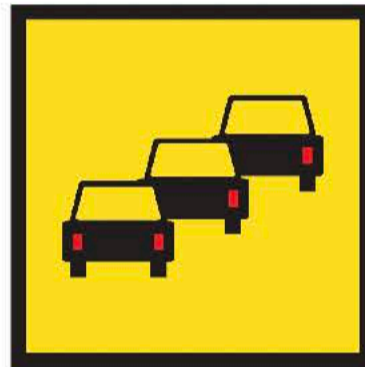

TC1947_2
600x600

AVAILABLE IN CORFLUTE OR ALUMINIUM
TO SUIT MULTIMESSAGE FRAMES

*Whole MUTCD Signage available



R6-6
450x750



AUSTRALIAN MADE
AND OWNED

ACCESSORIES



BALLAST
Sandbags 7kg min



T5-5
Chevron
with Weighted base

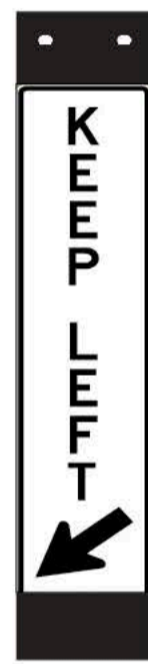

EVO-CONE-700
Weighted 700mm
Cone



BOLLARD
Weighted Bollard

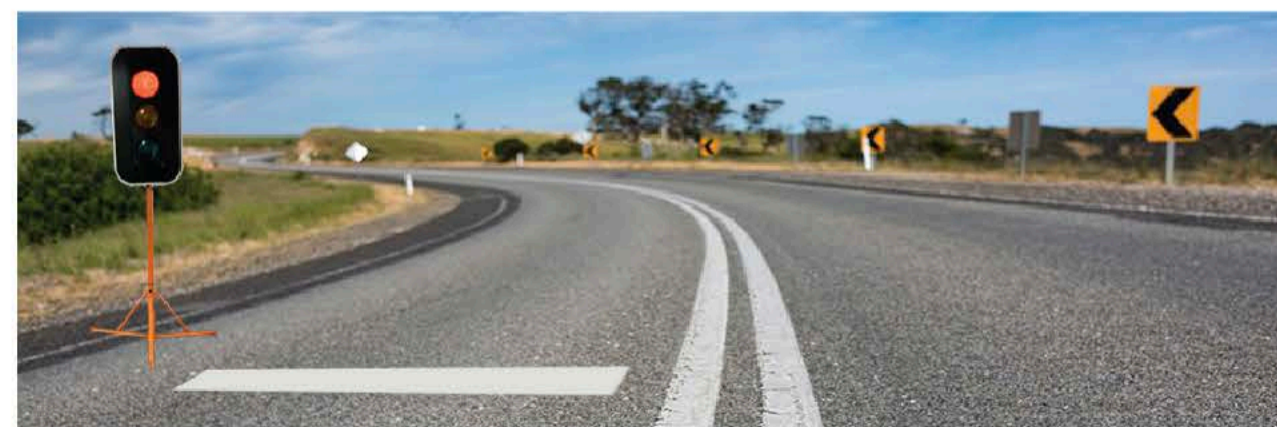

Rubber Stop Bar

SPARE PARTS

Remote Control



Charger



Charging Mat



Lighthouse Battery



Tripod



Light Hoods



REFERENCE DOCUMENTS

- Australian Standard 2144:2014 Traffic Signal Lanterns
- Australian Standard 4191:2015 Portable Traffic Signal Systems
- Manual of Uniform Traffic Control Devices- Part 3 Traffic control for works on roads ; November 2019
- Manual of Uniform Traffic Control Devices- Part 3 Traffic Control for works on roads, Supplement ; November 2019
- Department of Transport and Main Roads - MRTS 264 ; November 2018
- Department of Transport and Main Roads - MRTS 201 ; July 2018
- Australian Communication & Media Authority - Radiocommunications Labelling (Electromagnetic Compatibility) ; Notice 2017

CONTACT US

If you are looking for more information, service information or are experiencing an issue with your PTSS, please scan the QR code below:



PTSS-Support@outsource1.com.au

For service, please return to:
Unit 2, 12-14 Bailey Court, Brendale Queensland 4500

DOWNLOAD MANUAL AND HOW TO VIDEOS

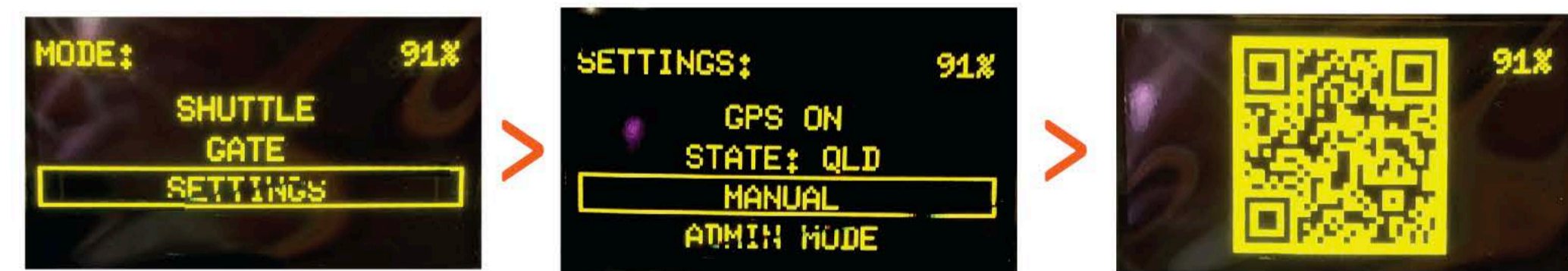

OR GO TO TRILIGHT.COM.AU AND FOLLOW THE PROMPTS

INTENTIONALLY
LEFT BLANK