



IGNITION
PARTS

Motorcycle

APPLICATIONS

2017/18



Jon Jessop Photography



www.ngknk.co.uk

-  facebook.com/ngksparkplugsuk
-  [NGK UK YouTube](#)
-  ngkntk.co.uk

WE'VE GOT HIS BACK

Chrissy Rouse
Mission Racing BMW



IGNITION
PARTS

CONTENTS

SPARK PLUG TECHNICAL INFORMATION

Spark Plug Design _____	2	Spark Plug Installation Tips _____	8
NGK's Copper Core Technology _____	3	Spark Plug Gap Settings _____	8
The Best Spark Plug for every occasion _____	4	Design Symbols _____	9
Fitting the Correct Spark Plug _____	5	New Additions and Part Numbers _____	10-12
The Iridium IX Spark Plug _____	6-7		

2 Wheel

Adly _____	13	Italjet _____	38
AJS _____	13	Jawa-CZ _____	38
Aprilia _____	13-15	Jialing _____	38
Atala _____	15	Jianshe _____	39
Bajaj _____	15	Jinlun _____	39
Baotian _____	15	Jonway _____	39
Barossa _____	15	Kawasaki _____	39-43
Bashan _____	15	Keeway _____	43
Batavus _____	16	Kenos _____	43
Beeline _____	16	Kreidler _____	43
Benelli _____	16	KSR Moto _____	43-44
Benzhou _____	16	KTM _____	44-46
Beta / Betamotor _____	17-18	Kymco _____	46-47
Bimota _____	18	Lambretta _____	47
BMW _____	19-20	Laverda _____	47
BSA _____	20	LEM _____	47
Buell _____	20-21	Lexmoto _____	47-48
Cagiva _____	21	Lifan _____	48
Can-Am (BRP) _____	21-22	LML _____	48
CCM (Armstrong-CCM) _____	22	Magni _____	48
CF Moto _____	22	Maico _____	48
Cossack _____	22	Malaguti _____	48-49
CPI _____	22-23	MBK _____	49
Daelim _____	23	Montesa _____	49
Derbi _____	23-24	Moto Guzzi _____	50
Ducati _____	24-26	Moto Morini _____	51
EBR _____	26	Moto Roma _____	51
Fantic _____	26	Motobecane _____	51
Gas Gas _____	26-27	Motorhispania _____	51
Generic _____	28	MS _____	51
Gilera _____	28-29	MV Agusta _____	52
Harley Davidson _____	29	MZ _____	52
Herald Motor Company _____	29	Neval _____	52
Hero-Puch _____	29	Nipponia _____	52
Hesketh _____	29	Norton _____	53
Honda _____	30-35	Ossa _____	53
Huoniao _____	35	Peugeot _____	53-54
Husaberg _____	35	PGO _____	54
Husqvarna _____	35-37	Piaggio / Vespa _____	54-56
Hymoto _____	37	Pioneer _____	56
Hyosung _____	37-38	Puch _____	56
Indian _____	38	Pulse _____	56

SPARK PLUG APPLICATIONS

Regal Raptor _____	56	Adly _____	74
Regent _____	57	Apache _____	74
Riders _____	57	Arctic Cat _____	74
Rieju _____	57	Blast (LEM) _____	74
Rovigo _____	57	Bombardier (->05) _____	74-75
Royal Enfield (1980->) _____	57	Can-Am (BRP) _____	75
RTX _____	57	Cectek _____	75
Sachs _____	57-58	Club Car _____	75
Scorpa _____	58	CPI _____	75
Sherco _____	58	Cub Cadet _____	75
Simson _____	58	Cushman _____	76
Sinnis _____	59	Dinli _____	76
Skyteam _____	59	E-Ton _____	76
SMC _____	59	E-Z-Go _____	76
Superbyke _____	59	Gas Gas _____	76
Suzuki _____	59-63	Honda _____	76-77
SWM _____	63	Hymoto _____	77
SYM _____	63-64	Hyosung _____	77
Tamoretti _____	64	John Deere _____	77
TGB _____	64	Kawasaki _____	77
The Black Douglas Motorcycle Co. _____	64	Kazuma _____	78
TM Racing _____	64	KTM _____	78
Tomos _____	65	Kubota _____	78
Triumph Pre-1989 _____	65	Kymco _____	78
Triumph 1991-On _____	65-66	LEM _____	78
Uralmoto _____	66	Masai _____	78
Vertemati _____	66	Massey Ferguson _____	78
Vespa (See Piaggio) _____	-	Moto Roma _____	78-79
Victory (Polaris) _____	66	Polaris _____	79
Vixen (See Bashan) _____	-	Puzey _____	79
VOR _____	67	Quadzilla _____	79-80
White Knuckle (See WK) _____	-	Quantum _____	80
WK _____	67	Skyteam _____	80
Wuyang _____	67	Storm _____	80
Xispa _____	67	Suzuki _____	80
Yamaha _____	67-72	SYM _____	80
Yamasaki _____	72	TGB _____	81
Yiying (See Benzhou) _____	-	Yamaha _____	81-82
Zing (See Lifan) _____	-		
Znen _____	72	Conversion Chart _____	83-111
Zongshen _____	73		

ATV Quad

SPARK PLUG COVERS

Cover Symbols Explanation Chart _____	113	Plug Cover Supersessions _____	114
NGK Resistor Plug Covers _____	113	Spark Plug Covers _____	115-117

LAMBDA SENSORS

NTK Lambda Sensors for Motorcycles _____	118	Technical Information _____	118
Aprilia _____	119	Moto Guzzi _____	121
BMW _____	119	Moto Morini _____	121
Ducati _____	120	MV Agusta _____	121
Honda _____	120	Suzuki _____	121
Husqvarna _____	120	Triumph _____	122
Hyosung _____	120		
KTM _____	120	Connector Types _____	123
Kymco _____	120		

This catalogue is intended for vehicles/engines officially imported or manufactured in the UK and supersedes all previous versions, which should be disposed of. Whilst every care is taken in compiling these lists of applications, they are given for general guidance only, and do not constitute any contractual term, representation or warranty and as such NGK Spark Plugs (UK) Ltd. do not accept any responsibility in respect of any claim whatsoever and howsoever caused arising from the publication of this catalogue.

NGK and NTK products are designed solely for use in automotive, motorcycle, marine, horticultural, agricultural, commercial, industrial, and stationary engines.

NGK and NTK products should not be used in aircraft engines.

Resistor spark plugs should always be used where they are recommended by the manufacturer. The use of non-resistor plugs could, in some cases, result in interference with and/or damage to electronic components.

NGK and NTK products listed in the application guides do not apply to racing or modified engines, except where explicitly stated.

SPARK PLUG DESIGN

SPARK PLUG DESIGN

Every year the range of NGK spark plugs grows to accommodate the ever increasing demands of modern engines. Spark plug design must take into consideration many features of an engine including physical dimensions, combustion chamber shape, cooling abilities, fuel and ignition systems. Spark plugs play a vital role in producing the maximum power from an engine whilst keeping fuel consumption and emissions to a minimum. Choosing the correct spark plug type will help a vehicle manufacturer meet legislated emission targets and assists the motorist in getting the best from their engine.

Increases in the size and the requirement to improve the cooling of the inlet and exhaust valves have meant that the space available for the spark plug is severely restricted on some cylinder heads. A change in spark plug design, possibly the adoption of a taper seat and extended reach (threaded portion) or even the use of a smaller diameter is often the answer. Some engines require the use of two spark plugs per cylinder and again due to space restrictions these might be of different sizes.

Changes in fuelling systems and the fuel itself have meant some special features being adopted at the 'firing end' of the spark plug. Extra projected types push the spark position into the heart of the combustion chamber to promote better combustion of the fuel/air mixture, which is weaker than ever in an effort to improve economy. Modern engine manufacturers often require increased spark gaps to allow a longer spark duration, which again aids more efficient combustion.

To combat the 'cold fouling' effect that can occur in some engines using unleaded fuels specially arranged ground electrode arrangements are sometimes used. These can force the spark to discharge across the insulator and thus burn away any built up carbon that could cause poor starting or misfires. It is not uncommon to find two, three or four ground electrode arrangements in new vehicles. The use of precious metals on the tips of the spark plug electrodes is not uncommon especially on higher performance engines. Whilst these spark plugs do have increased service life they are often specified because of their superior ignition qualities.

Our engineering departments work very closely with the engine and vehicle manufacturers to produce the ideal spark plug type for each application. Any change in production is expensive for a manufacturer and therefore new spark plug types are only produced where necessary. NGK employ the very latest production technology to ensure that every aspect is catered for – performance, economy and value.

HEAT RANGE AND HEAT DISSIPATION

Spark plugs do not produce heat in the combustion chamber. One of the functions of the spark plug is to dissipate some of the heat produced during combustion. This is mostly transferred into the cylinder head. The 'Heat Range' indicates the measure of the spark plug's ability to do this.

A 'hot' spark plug is designed to maintain a sufficiently high temperature at the insulator nose to burn off carbon and oil deposits. A 'cold' spark plug is designed to allow a faster transfer of heat to the cylinder head thus preventing overheating and premature failure.

The heat range selection is obviously a complex task with many factors to take into account. NGK engineers therefore make specific recommendations for each engine and the use to which it is put.

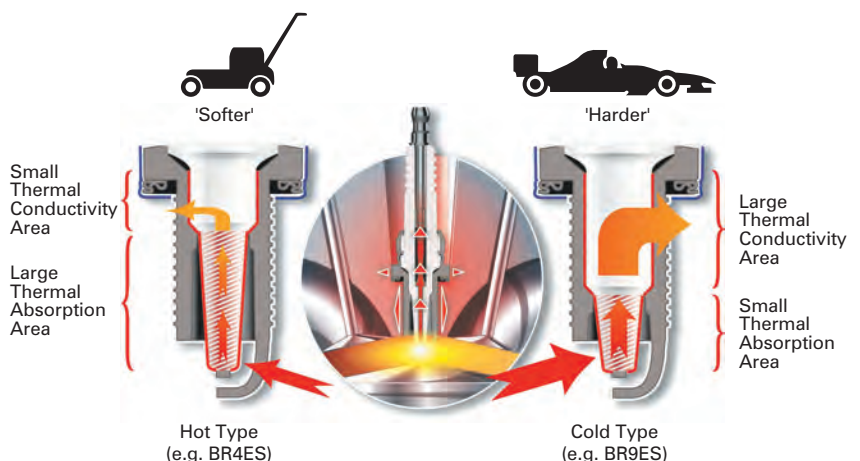
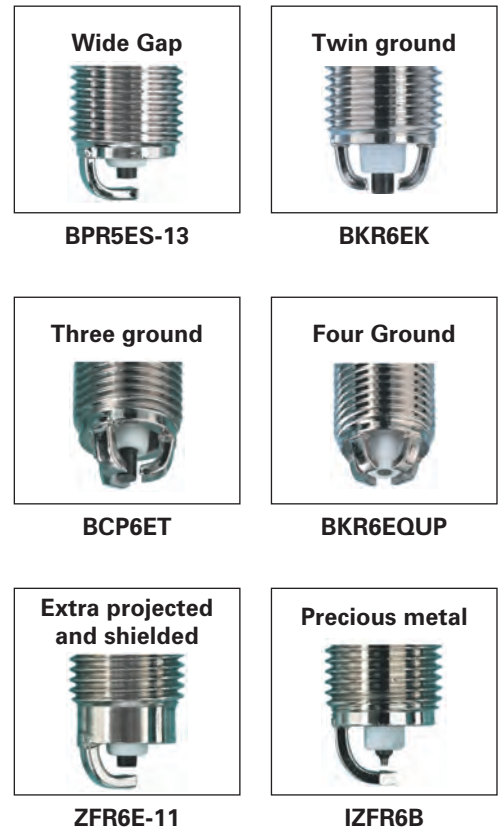

NGK'S COPPER CORE TECHNOLOGY

WIDE HEAT RANGE

A wide range spark plug is more flexible and performs equally well in a hot or cold engine under stop and go city driving or fast motorway cruising. Engines that tend to run hot need cold type plugs. Those that run cold demand a hotter type. The specific plug for any engine is determined by the plug's heat range. That is the minimum and maximum temperatures between which the plug will offer optimum performance.

The heat range of NGK Spark Plugs is wider than ordinary plugs therefore they are suitable for both high speed and low speed driving. Compared with conventional plugs of the same pre-ignition rating they have more resistance to fouling. Compared to ordinary plugs with equal anti-fouling resistance, NGK Spark Plugs have a higher pre-ignition rating.

NGK'S HEART OF COPPER

Copper wire used in place of the iron core in conventional plugs is the secret of NGK's Wide Heat Range. Copper's superior heat conductivity dissipates heat quicker. It cools the electrode tip and insulator tip which prevents hot spots that could cause pre-ignition. Increased heat resistance does not affect fouling resistance, which is primarily determined by the insulator nose length. The longer the nose, the more susceptible it is to heat and the more free from fouling. By raising the pre-ignition rating with the high conduction copper and leaving the insulator nose long, NGK produces the Wide Range Plug. One that meets the broad thermal requirements of engines under high and low RPM conditions. With the exception of a couple of older applications, all the spark plugs in this catalogue employ copper core technology.

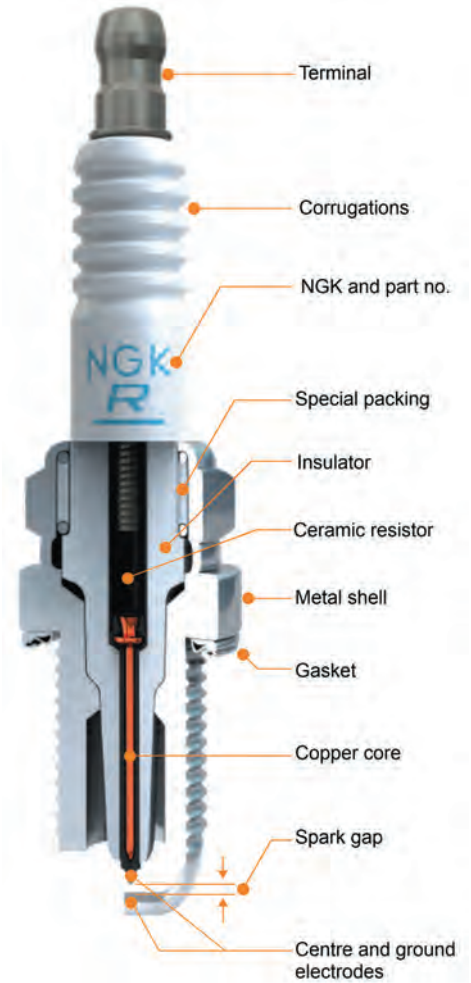

FIRING END APPEARANCE



THE BEST SPARK PLUG FOR EVERY OCCASION

As a result of our policy of continuous research and development NGK can offer special spark plugs designed to give optimum performance under a high range of conditions.

'S' TYPE (e.g. BP6ES)

NGK standard spark plugs with copper cored centre electrodes for wide heat range. Copper's superior heat conductivity dissipates the heat of combustion away from the firing end, preventing hot spots that can lead to pre-ignition. Copper cored electrodes also mean that longer insulator noses can be used to protect against fouling.



'G' TYPE (e.g. B10EG)

These plugs feature a smaller diameter centre electrode tip made of conventional nickel alloy. The smaller diameter centre electrode means the voltage required to produce a spark is reduced. However as the tip is made of conventional nickel alloy the service life is reduced and these plugs are best used in applications where plugs are frequently changed.



'V' TYPE (e.g. B10EV)

The centre electrode of this type is made of gold palladium alloy. These 'V' types have now been discontinued and replaced with 'VX' or 'IX' equivalents.



'GV' TYPE (e.g. B9EGV)

These plugs have a centre electrode of precious metal similar to the V range. In addition the insulator nose is an improved design to allow better gas flow around the firing end. The ground electrode is shorter and stronger, making the GV range more suited for racing applications.



'VX' TYPE (e.g. B8EVX)

These plugs have an even smaller centre electrode (0.8mm) than the V types and this is made of platinum. This combined with a taper cut ground electrode means an even lower required voltage than the V types. The result is better ignitability along with improved starting, idle stability and anti-fouling performance.



'IX' TYPE (e.g. BR8EIX)

Similar in design to the Platinum VX spark plug, the use of the precious metal Iridium allows us to manufacture a spark plug with an even smaller diameter centre electrode (0.6mm) without compromising durability. This extremely small Iridium tip centre electrode concentrates the available electrical energy and combined with the taper cut ground electrode provides the best performance in terms of starting, idling and especially throttle response.



FITTING THE CORRECT SPARK PLUG

NGK spark plugs are designed using the latest technology to give optimum performance over the engine's entire rev. range. Fitting the correct type of spark plug is essential. Many changes in engine technology has meant changes in spark plug design. Some NGK spark plugs may have a similar appearance, however the internal and or external design can differ sufficiently to cause engine damage should the incorrect part be installed. The examples below display some of the different design features employed in typical motorcycle applications and hopefully help to explain the reason for some application specific part numbers.

CR8EH-9

- Used on some Honda designed engines
- Special thread can only be used in specific engines or the cylinder head will be damaged

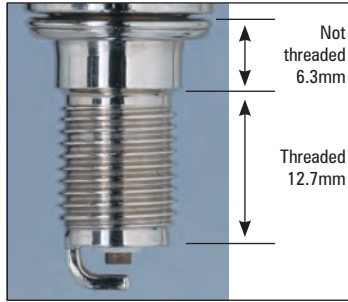

BR10ECM

- Compact style, mainly used by Honda and Suzuki
- For use where space is restricted

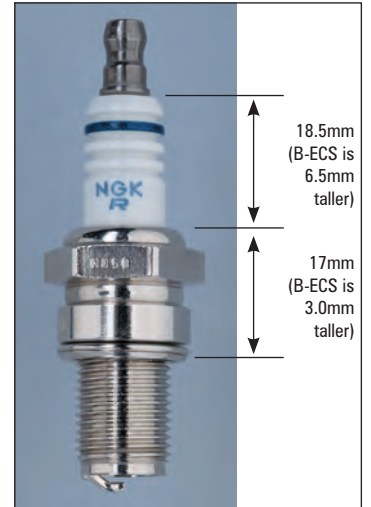

CR6HSA

- Centre electrode is 0.2mm wider than CR6HS for improved durability
- Short metal shell design



CR9EK, JR9C

- Used by Kawasaki and Suzuki
- 2 ground electrodes for improved durability



CR9EK thread diameter Ø 10mm



JR9C thread diameter Ø 12mm

ER9EH

- Used by Honda, Ø 8mm thread with 13mm hex
- Do not exceed the tightening torque of 0.8 - 1.0kg/m

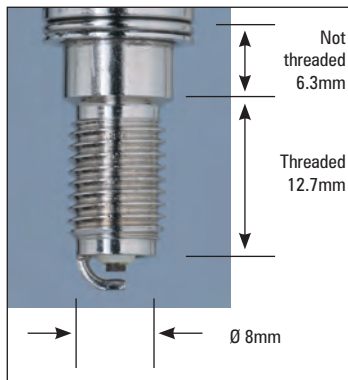

B9ECS

- Short ground electrode for strength and to prevent overheating
- For competition use



THE IRIIDIUM IX SPARK PLUG

The Iridium IX spark plug is similar in design to the Platinum VX type but benefits from the use of the precious metal Iridium on its centre electrode. Iridium is harder than other precious metals used in spark plug manufacture, has an extremely high melting point and offers greater protection from chemical attack. These features allow the use of an extremely small diameter electrode (0.6mm) without compromising the spark plug's service life. Combined with the use of the taper cut ground electrode this spark plug has superior gas flow properties and lower voltage requirements, which offers further improvements in starting, idling and throttle response.



BR8EIX

Iridium spark plugs are used by some of the worlds leading race teams and as original equipment in many high performance road and off road machines. Owners who want the very best performance from their bikes will want the best spark plug and this we can offer with Iridium IX.



Iridium IX

A small diameter electrode that gives good gas flow and less restriction of flame kernel

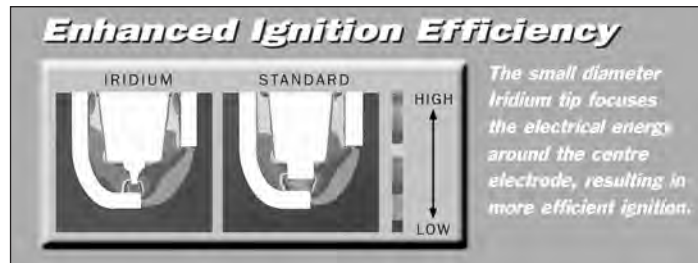

Iridium IX packaging

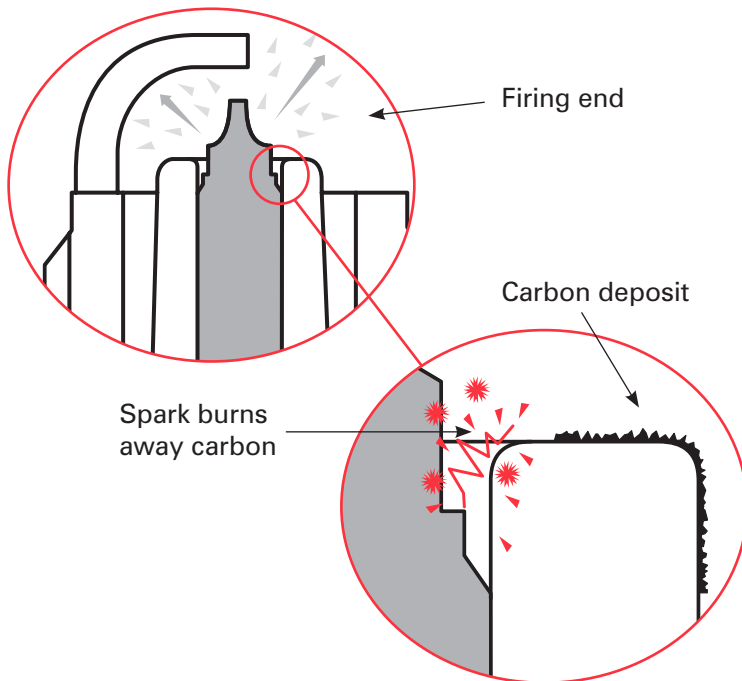

The close up section shows the annular gap between the centre electrode and insulator nose which provides cold fouling protection.

Should current try to leak away across a carbonised insulator a spark can occur between the electrode and the insulator thus burning away the carbon deposit.

THE IRIIDIUM IX SPARK PLUG

The tables below show the Iridium IX upgrade from standard copper core and Platinum VX type. For specific model application refer to the Iridium column in the main data pages.

STANDARD COPPER CORE		PLATINUM VX	IRIDIUM IX	
PART NO.	PART NO.	PART NO.	PART NO.	STOCK NO.
BK6E	BKR6E		BKR6EIX	6418
	BKR6E-11		BKR6EIX-11	3764
	BKR7E		BKR7EIX	2667
BP5ES	BPR5ES		BPR5EIX	6597
BP6ES	BPR6ES		BPR6EIX	6637
	BPR6ES-11		BPR6EIX-11	3903
BP6HS	BPR6HS		BPR6HIX	4085
BP6HS-10	BPR6HS-10			
	BR6HSA			
BP7ES	BPR7ES		BPR7EIX	4055
BP7HS	BPR7HS		BPR7HIX	5944
BP7HS-10	BPR7HS-10			
BP8HS	BPR8HS		BPR8HIX	6742
BP8HS-10	BR8HSA			
B6HS	BR6HS		BR6HIX	3419
B6HS-10	BR6HS-10			
B7ES	BR7ES		BR7EIX	6664
B7HS	BR7HS		BR7HIX	7067
B7HS-10	BR7HS-10			
B8ES	BR8ES		BR8EIX	5044
B8HS	BR8HS		BR8HIX	7001
B8HS-10	BR8HS-10			
B9ES	BR9ES		BR9EIX	3981
	BR10ES		BR10EIX	6801
C6HSA	CR6HSA		CR6HIX	7274
	CR6HS			
	CR7E		CR7EIX	7385

STANDARD COPPER CORE		PLATINUM VX	IRIDIUM IX	
PART NO.	PART NO.	PART NO.	PART NO.	STOCK NO.
C7HSA	CR7HSA		CR7HIX	7544
	CR7HS			
	CR8EH-9		CR8EHIX-9	3797
C8E	CR8E		CR8EIX	4218
	CR8EK			
C8HSA	CR8HSA	CR8HVX	CR8HIX	7669
	CR8HS			
	CR9EH-9		CR9EHIX-9	6216
C9E	CR9E		CR9EIX	3521
	CR10E		CR10EIX	6482
	CR10EK			
	DCPR7E		DCPR7EIX	6046
	DCPR8E		DCPR8EIX	6546
	DCPR8EK			
	DCPR9E	DCPR9EVX	DCPR9EIX	2316
	DPR7EA-9		DPR7EIX-9	7803
DP8EA-9	DPR8EA-9		DPR8EIX-9	2202
	DPR9EA-9		DPR9EIX-9	5545
D8EA	DR8EA	DR8EVX	DR8EIX	6681
	DR8ES-L			
D9EA	DR9EA	DR9EVX	DR9EIX	4772
	DR8ES*			
	JR9B			

*The upgrade from DR8ES to DR9EIX is correct

As the IX range now takes over the premium motorcycle spark plug position from the popular Platinum VX range we will be superseding some current versions of Platinum VX types as volume production allows. This will be treated as a running change and therefore orders placed for certain resistor VX types will be fulfilled by supplying the Iridium IX equivalent. Most contemporary machines demand the use of resistor types and most older machines can and do use them quite happily.

Below is a chart to show the VX plugs currently affected.

Platinum VX		replaced by	Iridium IX	
Platinum VX	Stock No.		Iridium IX	Stock No.
B7EVX	6934	→	BR7EIX	6664
B7HVX	7836	→	BR7HIX	7067
B8EVX	7051	→	BR8EIX	5044
B8HVX	2634	→	BR8HIX	7001
B9EVX	7254	→	BR9EIX	3981
B10EVX	7335	→	BR10EIX	6801
B10HVX	2940	→	BR10HIX	6692
BKR6EVX	3539	→	BKR6EIX	6418
BKR7EVX	3544	→	BKR7EIX	2667
BP5EVX	5470	→	BPR5EIX	6597
BP7EVX	7270	→	BPR7EIX	4055
BPR5EVX	4875	→	BPR5EIX	6597
BPR6EVX	6764	→	BPR6EIX	6637

Platinum VX		replaced by	Iridium IX	
Platinum VX	Stock No.		Iridium IX	Stock No.
BPR9EVX	5576	→	BPR9EIX	6853
BR8EVX	1262	→	BR8EIX	5044
BR9EVX	1265	→	BR9EIX	3981
CR8EHVX-9	4546	→	CR8EHIX-9	3797
CR8EVX	6487	→	CR8EIX	4218
CR9EHVX-9	3872	→	CR9EHIX-9	6216
CR9EVX	5943	→	CR9EIX	3521
D8EVX	2850	→	DR8EIX	6681
D9EVX	2834	→	DR9EIX	4772
DCPR7EVX	1179	→	DCPR7EIX	6046
DPR7EVX-9	7682	→	DPR7EIX-9	7803
DPR8EVX-9	2872	→	DPR8EIX-9	2202
DPR9EVX-9	3854	→	DPR9EIX-9	5545

SPARK PLUG INSTALLATION TIPS

- Refer to current NGK catalogue for correct spark plug selection
- Check condition and cleanliness of threads in cylinder head
- Ensure plug is gapped according to vehicle manufacturers specification (*fig 1*)
- Multi ground electrode and precious metal plugs should not be regapped - visual inspection only
- Install new spark plug *by hand* until it seats - (*fig 2*) a length of rubber tubing pushed over the insulator can be a useful aid for plug installation where access is difficult
- Tighten to specified torque setting as shown in the chart below (*fig 3*)
- If a torque wrench is unavailable then refer to vehicle/engine manufacturers installation instructions or the tightening angle advice which is displayed on current NGK packaging (excluding specialist race plugs). Note that this angle advice can differ between part numbers due to individual spark plug design (e.g. seating type, thread diameter and gasket material)
- It is important not to over or under tighten spark plugs during installation. Over-tightening can lead to distortion of the spark plug. Under-tightening can cause overheating due to poor heat dissipation. *In extreme cases incorrect tightening can cause spark plug breakage and/or engine damage*
- NGK does not recommend the application of lubricant to spark plug threads as the resultant reduction of frictional forces at the thread faces will render the torque charts inaccurate and over tightening could occur
- If a gasket type spark plug is re-installed, it should only require a further 1/12 of a turn after it has been seated
- Always carefully use the correct tools for removal/installation to prevent damage to the spark plug or engine
- Inspect spark plug cover and renew if necessary

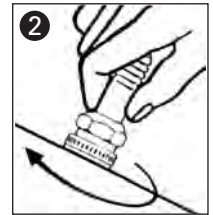
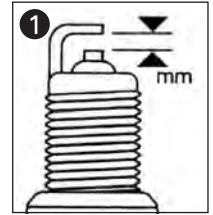

③	FOR FLAT SEAT TYPE (WITH GASKET)					TAPER SEAT TYPE	
	Thread Ø	18 mm	14 mm	12 mm	10 mm	8 mm	18 mm
Cast iron head	35-45Nm	25-35Nm	15-25Nm	10-15Nm	-	20-30Nm	15-25Nm
	(3.5-4.5kgm) (25.3-32.5lbs ft)	(2.5-3.5kgm) (18.0-25.3lbs ft)	(1.5-2.5kgm) (10.8-18.0lbs ft)	(1.0-1.5kgm) (7.2-10.8lbs ft)		(2.0-3.0kgm) (14.5-21.6lbs ft)	(1.5-2.5kgm) (10.8-18.0lbs ft)
Aluminium head	35-40Nm	25-30Nm	15-20Nm	10-12Nm	8-10Nm	20-30Nm	10-20Nm
	(3.5-4.0kgm) (25.3-28.9lbs ft)	(2.5-3.0kgm) (18.0-21.6lbs ft)	(1.5-2.0kgm) (10.8-14.5lbs ft)	(1.0-1.2kgm) (7.2-8.7lbs ft)	(0.8-1.0kgm) (5.8-7.2lbs ft)	(2.0-3.0kgm) (14.5-21.6lbs ft)	(1.0-2.0kgm) (7.2-14.5lbs ft)

Important: Some spark plugs differ in gasket design or material, refer to tightening advice on specific spark plug packaging

SPARK PLUG GAP SETTINGS

Important: Spark plug gap settings are given in millimetres. Practical equivalents are shown below.

mm	0.4	0.5	0.6	0.7	0.8	0.9	1.0	1.1	1.3	1.4	1.5	1.6	1.8	2.0
ins	.016	.020	.024	.028	.032	.035	.039	.043	.051	.055	.059	.063	.071	.079

DESIGN SYMBOLS

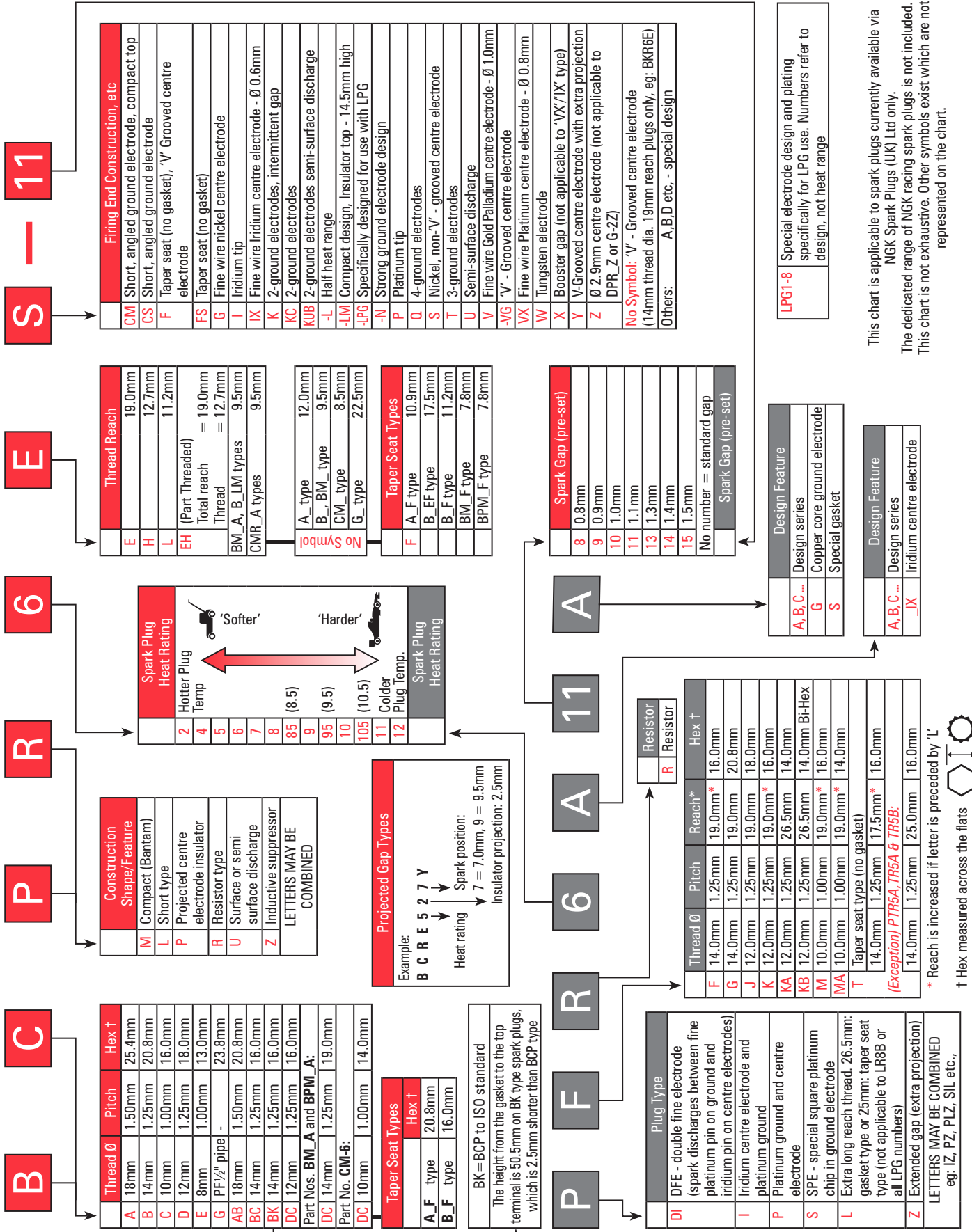

LPG1-8 Special electrode design and plating specifically for LPG use. Numbers refer to design, not heat range

This chart is applicable to spark plugs currently available via NGK Spark Plugs (UK) Ltd only. The dedicated range of NGK racing spark plugs is not included. This chart is not exhaustive. Other symbols exist which are not represented on the chart.

NEW ADDITIONS AND PART NUMBERS

These are new additions to this catalogue that have new part numbers not previously stocked by NGK Spark Plugs (UK) Ltd.

PART NO.	STOCK NO.	APPLICATION	PART NO.	STOCK NO.	APPLICATION
KR8C-G	97516	DUCATI Scrambler Sixty2	MR8C-9N	97985	HONDA NSC110 Vision
LMAR8BI-9	91909	SUZUKI DL1000 L4 V-Strom	SILMAR8C9	90097	HONDA NSS125 Forza
MR7F	95897	POLARIS (Quads) Sportsman 570EFi Ranger RZR 900, 4 XP 900			

PART NO.	STOCK NO.	APPLICATION	PART NO.	STOCK NO.	APPLICATION
Y1021J	97627	CUB CADET (ATV) Volunteer 4x4D JOHN DEERE (ATV) XUV 855D Gator	Y-601J	92785	KAWASAKI (ATV) KAF950 (Mule 4010)

These Spark Plugs and Glow Plugs are now stocked and available to order

Listed below is a selection of new applications for existing spark plugs

MAKE	MODEL	PART NO.	STOCK NO.
APRILIA	Caponord Rally	CR8EKB	4374
	RSV 4 RF	CR9EKB	2305
	Scarabeo 100 4-Stroke	CR9EB	6955
	Scarabeo 125cc 07→10	PMR9B	4717
	Scarabeo 200 07→10	PMR9B	4717
	Scarabeo 50 4T (4-valve)	ER9EH-6N	1673
	Scarabeo 50 Carb 05→11	BR8ES	5422
Tuono V4 1100 RR	CR9EKB	2305	
BENELLI	TnT 125	CR7HSA	4549
BETA / BETAMOTOR	EVO 300 2T	BR7ES	5122
	R10, R12 10→12	BR8ES	5422
	RR 125 Enduro (Liquid Cooled)	CR8E	1275
	RR 250 2-stroke 13→15	BR7ES	5122
	RR 250 2-stroke 16→	BR8ES	5422
	RR 300 2-stroke	BR7ES	5122
	RR 350	LKAR8A-9	4786
	RR 390	LKAR8A-9	4786
	RR 400 4-stroke 10→	LKAR8A-9	4786
	RR 430	LKAR8A-9	4786
	RR 450 4-stroke 10→14	LKAR8A-9	4786
	RR 480	LKAR8A-9	4786
	RR 500	LKAR8A-9	4786
	RR 520 4-stroke	LKAR8A-9	4786
	RS 390	LKAR8A-9	4786
	RS 400	LKAR8A-9	4786
	RS 430	LKAR8A-9	4786
	RS 450	LKAR8A-9	4786
	RS 500	LKAR8A-9	4786
RS 520	LKAR8A-9	4786	
BIMOTA	DB10 bimotard	DCPR8E	4339
	DB8	MAR10A-J	4706
	DB9 Brivido, S	MAR9A-J	6869
	DBx	DCPR8E	4339
	Tesi 3D	DCPR8E	4339

MAKE	MODEL	PART NO.	STOCK NO.
BMW	C650 Sport	LMAR8D-J	93444
	G310 R	LMAR9D-J	1633
	R nineT Pure, Racer	MAR8B-JDS	8765
	R nineT Scrambler	MAR8B-JDS	8765
	R nineT Urban	MAR8B-JDS	8765
CUSHMAN (Quads)	Hauler 800, 1200, 1200X	BPR2ES	2264
	Refresher FS2, FS4, Oasis	BPR2ES	2264
	Shuttle 2, 4, 6, 8	BPR2ES	2264
DUCATI	1198 R Corse	MAR10A-J	4706
	1299 Panigale Anniversario	MAR9A-J	6869
	959 Panigale, R	MAR9A-J	6869
	Hypermotard 939, 939 SP	MAR9A-J	6869
	Hyperstrada 939	MAR9A-J	6869
	Monster 1200 R	MAR9A-J	6869
	Monster 1200, S, Stripe	MAR9A-J	6869
	Monster 821 Stripe	MAR9A-J	6869
	Multistrada 1200 Enduro 16→	MAR9A-J	6869
	Multistrada 1200, D Air, S 15→	MAR9A-J	6869
	Scrambler Flat Track Pro	DCPR8E	4339
	Supersport, S	MAR9A-J	6869
XDiavel, S	MAR9A-J	6869	
E-Z-GO (Quads)	Hauler 800, 1200, 1200X	BPR2ES	2264
	Refresher FS2, FS4, Oasis	BPR2ES	2264
	RXV Golf Kart	BPR2ES	2264
	Shuttle 2, 4, 6, 8	BPR2ES	2264
	TXT Golf Kart	BPR2ES	2264
GENERIC	Cracker SM 50 (12.7mm Thread Reach)	BR8HSA	5539
	Epico 50	BR8HSA	5539
	Evolution 50 11→12	BR8HSA	5539
	Ideo 50 11→12	BR8HSA	5539
	Trigger SM 50 11→12	BR8HSA	5539
	Trigger X 50 11→12	BR8HSA	5539
	XOR 50 11→12	BR8HSA	5539

The above tables are intended as a stock purchase guide.
Refer to the relevant model listing in the main application section for product selection.

NEW ADDITIONS AND PART NUMBERS

MAKE	MODEL	PART NO.	STOCK NO.
HARLEY DAVIDSON	FL1690 Screamin' Eagle Electra Glide	DCPR8E	4339
	FL1690 Screamin' Eagle	DCPR8E	4339
	FLHR Road King	DCPR7E	3932
	FLHTCUSE Screamin' Eagle	DCPR7E	3932
	Forty Eight	DCPR7E	3932
	FXDBi	DCPR7E	3932
	FXSB	DCPR8E	4339
	Switchback	DCPR8E	4339
	VRSCF V-ROD MUSCLE	DCPR9E	2641
	Wide Glide	DCPR8E	4339
	XL1200	DCPR7E	3932
	XL883 Iron	DCPR7EA-9	6651
HERALD MOTOR COMPANY	Classic 125	CR7E	4578
	Classic 250	DR8EA	7162
	Nomad 250 custom	DR8EA	7162
	Rambler 250 custom	DR8EA	7162
	Roamer 250 custom	DR8EA	7162
	Vagabond 250 custom	DR8EA	7162
HONDA	CBR300R	SIMR8A9	91064
	TRX500 FA (Auto) 475cc Quad	BKR5E-11	6953
	TRX680FA Rincon 15 → Quad	CPR6EB-9	5958
KAWASAKI	EN650 (Vulcan S)	CR9EIA-9	6289
	ER650 HHF (Z650)	CR9EIA-9	6289
	EX650 KHf (Ninja 650)	CR9EIA-9	6289
	KLE300 (Versys-X 300)	CR8E	1275
	SC125 (J125)	CR7E	4578
	Z900 (Incl. Performance)	CR9EIA-9	6289
KSR MOTO	Code 125	DR8EA	7162
	Epico 50	BR8HSA	5539
	GSR 125	DR8EA	7162
	Onyx 50	BR8HSA	5539
	Sirion 50	BR8HSA	5539
	Soho 125	CR8E	1275
	TR 125	CR8E	1275
	TW 125	DR8EA	7162
	Vertigo 125	CR7HSA	4549
	Worx 125	DR8EA	7162
Zion 125	CR8E	1275	
KTM	690 Enduro R (Twin Spark) 14 →	LMAR7A-9	4908
	690 Enduro R (Twin Spark) 14 →	LKAR8BI9	1553
	690 SMC R 12 → 13	LKAR8AI-9	6706
	690 SMC R (Twin Spark) 14 →	LMAR7A-9	4908
	690 SMC R (Twin Spark) 14 →	LKAR8BI9	1553
KUBOTA (Quads)	RTV400Ci	BR6HS	3922
	RTV500	BKR4EIX	5693
	RTV1140 Diesel	YE01	2649
KYMCO	Like 200i (4-Stroke)	CR7HSA	4549
LIFAN	Aero 50 2-Stroke	BPR7HS	6422
	Aero 50 4-Stroke	CR7HSA	4549
	Aero 125	C7HSA	4629
MONTESA	4Ride	CR6EH-9	2688
	Cota 300RR	CR6EH-9	2688
	Cota 4RT	CR6EH-9	2688

MAKE	MODEL	PART NO.	STOCK NO.	
MOTO GUZZI	Audace	LMAR8F-9	90894	
	Eldorado	LMAR8F-9	90894	
	Griso	CR8EKB	4374	
	MGX-21	LMAR8F-9	90894	
	Norge 1200 GT 8V	CR8EKB	4374	
	Stelvio 1200 8V	CR8EKB	4374	
	Stelvio 1200 8V NTX	CR8EKB	4374	
	V7 II Racer, Special	CPR8EB-9	6607	
	V7 III Anniversario, Racer	CPR8EB-9	6607	
	V9 Bobber	CPR8EB-9	6607	
	V9 Roamer	CPR8EB-9	6607	
	NIPPONIA	Brio	CR7HSA	4549
	PEUGEOT	Citystar 200i	CR8EB	7784
Django 125		CR7HSA	4549	
Django 150		CR7HSA	4549	
Django 50		BR7HS	4122	
Satelis 2 125		CR8EB	7784	
Satelis 2 300		CR7EKB	4455	
Satelis 2 400		CPR8EB-9	6607	
Satelis 2 400RS		CPR8EB-9	6607	
Speedfight 3		CR7HSA	4549	
Tweet 125		CR7HSA	4549	
PIAGGIO / VESPA		MP3 500 LT Sport	CR7EKB	4455
		Primavera 3V (4-Stroke)	CR8EB	7784
	Primavera 50	BR9ES	5722	
	Sprint 3V	CR8EB	7784	
	Typhoon 125 10 →	CR7EB	4663	
	Typhoon 50 06 → 15	BR9ES	5722	
	Vespa GTV 300	CR8EKB	4374	
	Vespa LX50 (2-Stroke) 98 → 05	BR9ES	5722	
	Vespa PX125 (2-Stroke, Euro 3)	BR6HS	3922	
	Vespa PX150 (2-Stroke, Euro 3)	BR6HS	3922	
	Vespa Zafferano 125	CR7EB	4663	
	Vespa Zafferano 50	BR9ES	5722	
	X10 125cc	CR8EKB	4374	
	X10 500cc	CR7EKB	4455	
	POLARIS (Quads)	RZR 800 EFI	BKR7E	6097
RZR S 800 EFI		BKR7E	6097	
Sportsman XP 850 12 →		LKAR8A-9	4786	
PUZEY (Quads)	Madix 125	DR8EA	7162	
SHERCO	125 ST	BP5ES	6511	
	250 ST	BP5ES	6511	
STORM (Quads)	Panther	CR7HSA	4549	
SUPERBYKE	RSP125	DR8EA	7162	
SUZUKI	GSX1400 FE - K7	CR8EK	3478	
	GSX-S1000	CR9EIA-9	6289	
	LT-A500XP KingQuad 15 →	LMAR6A-9	5946	
	LT-A750X 14 → (Quad)	LMAR7A-9	4908	
	RMX450Z L4 →	CR8EIB-10	4948	
	UK110 Address	CPR7EA-9	3901	
TAMORETTI	Retro 125 TN125-E	CR7HSA	4549	
	Retro 50 ZN50QT-E	CR7HSA	4549	
	Stealth 125	CR7HSA	4549	
TGB	Bellavita 125i	CR7E	4578	
	Bellavita 300i	CR8E	1275	
	X-Motion 125	CR8E	1275	

The above tables are intended as a stock purchase guide.
Refer to the relevant model listing in the main application section for product selection.

NEW ADDITIONS AND PART NUMBERS

MAKE	MODEL	PART NO.	STOCK NO.
THE BLACK DOUGLAS MOTORCYCLE CO.	Various models 125cc	DR8EA	7162
	Various models 230cc	DR8EA	7162
TM RACING	EN 250 (2-stroke)	BR8EG	3130
	EN 300 (2-stroke)	BR8EG	3130
	EN 450Fi	CR9EIX	3521
	EN 530F	CR8E	1275
	MX 125	BR9EG	3230
	MX 144	BR9EG	3230
	MX 250 (2-stroke)	BR8EG	3130
	MX 300 (2-stroke)	BR8EG	3130
	MX 450Fi	CR9EIX	3521
	MX 530F	CR8E	1275
	SMM, SMR 250 (2-stroke)	BR8EG	3130
	SMM, SMR 300 (2-stroke)	BR8EG	3130
	SMM, SMR, SMX 450Fi	CR9EIX	3521
	SMM, SMR, SMX 530F	CR8E	1275
	SMM/SMR 125	BR9EG	3230
	TRIUMPH	Bonneville T100 16→	LMAR8A-9
Bonneville T120, Black 15→		LMAR8A-9	4313
Speed Triple 750		DPR8EA-9	4929
Speed Triple R, S		CR8EIA-9	4286
Street Cup		LMAR8A-9	4313
Street Triple R, RS, S		CR9EIA-9	6289
Street Triple S (A2 Licence)		CR9EIA-9	6289
Street Twin		LMAR8A-9	4313
Thruxton, Thruxton R		LMAR8A-9	4313
Thunderbird 1700cc option		DPR6EA-9	5531
Tiger Sport 16→		CR8EIA-9	4286

MAKE	MODEL	PART NO.	STOCK NO.
VICTORY	High Ball	DCPR6E	3481
WK	GP125	CR7HSA	4549
	RT125	CR6HSA	2983
YAMAHA	GPD125A N-Max	CPR8EA-9	2306
	MT-03	CR8E	1275
	MT-10	LMAR9E-J	6884
	NS50 Aerox R	BR8HS	4322
	Tracer 700	LMAR8A-9	4313
	Tracer 900	CPR9EA-9	2308
	XC125R Majesty S	CPR8EA-9	2306
	XJR1300 Racer	DPR8EA-9	4929
	XSR900	CPR9EA-9	2308
	XV950, R	CPR7EA-9	3901



CC	MODEL	DATE	STANDARD COPPER CORE	STOCK NUMBER	PLATINUM OR GOLD PALLADIUM	STOCK NUMBER	IRIDIUM	STOCK NUMBER	GAP MM
ADLY									
50	Citybird, Crosser, Fox, Jet X1, Pista, Predator	97→	BPR7HS	6422			BPR7HIX	5944	0.6
100	Cat, Predator, Jet, X1	97→	BPR7HS	6422			BPR7HIX	5944	0.6
125	Activator 125	99→	CR7HSA	4549			CR7HIX	7544	0.5
	AJP 125 PR4	03→	DPR7EA-9	5129			DPR7EIX-9	7803	0.9
	Cat 125	97→	CR7HSA	4549			CR7HIX	7544	0.5

AJS									
50	Chipmunk 50	03→	BP4HS	3611					0.6
	DD50 Regal Raptor	03→	CR7HS	7223			CR7HIX	7544	0.7
	JSM 50 Motard	11→	BR8ES	5422			BR8EIX	5044	0.6
80	Coyote 80	03→	BP6HS	4511			BPR6HIX	4085	0.6
100	Cougar 100 (Jincheng)	03→	BP7HS	5111			BPR7HIX	5944	0.6
	DD100 Regal Raptor	03→	CR7HS	7223			CR7HIX	7544	0.7
125	CR3-125 Super Sports	08→	DR8EA	7162	DR8EVX	6354	DR8EIX	6681	0.6
	JS125Y Tiger	03→	DR8ES	5423			DR9EIX	4772	0.7
	JSM125 Motard / Trail	10→	CR6HSA	2983			CR6HIX	7274	0.6

APRILIA									
50	AF1 50	88→92	B8ES	2411			BR8EIX	5044	0.5
	Amico 50	92→94	BR7HS	4122			BR7HIX	7067	0.6
	Area 51 (Liquid Cooled 2-Stroke)	98→	BR8HS	4322			BR8HIX	7001	0.5
	Extrema 50	93→	B8ES	2411			BR8EIX	5044	0.5
	Gulliver	97→99	BR7HS	4122			BR7HIX	7067	0.6
	Habana 50, Custom & Retro	99→05	BPR8HS	3725			BPR8HIX	6742	0.6
	Mojito Custom 50	05→08	BR9ES	5722			BR9EIX	3981	0.7
	MX50	03→07	BR9ES	5722			BR9EIX	3981	0.7
	Rally 50 (Air Cooled)	95→99	BR7HS	4122			BR7HIX	7067	0.7
	Rally 50 (Liquid Cooled)	97→03	BR8HS	4322			BR8HIX	7001	0.5
	Red Rose 50	93→00	B8ES	2411			BR8EIX	5044	0.5
	RS 50 (Minarelli engine)	93→00	B8ES	2411			BR8EIX	5044	0.6
	RS 50 (Minarelli engine)	01→05	BR9ES	5722			BR9EIX	3981	0.7
	RS 50 (Derbi engine)	06→	BR9ES	5722			BR9EIX	3981	0.5
	RS4 50	11→13	BR8ES	5422			BR8EIX	5044	0.6
	RX 50 (Minarelli engine)	97→10	B9ES	2611			BR9EIX	3981	0.6
	Scarabeo 50 Carb (Minarelli engine) 12.7mm Thread Reach	93→04	BR7HS	4122			BR7HIX	7067	0.6
	Scarabeo 50 Carb (Piaggio engine) 19mm Thread Reach	05→11	BR8ES	5422			BR8EIX	5044	0.6
	Scarabeo 50 Di Tech (Injection) 2-Stroke	01→04	CPR8E	7411			CR8EIX	4218	0.8
	Scarabeo 50 4T (4-Stroke) 2-valve Ø10mm Plug	06→09	CR9EB	6955			CR9EIX	3521	0.6
	Scarabeo 50 4T (4-Stroke) 4-valve Ø8mm Plug	08→12	ER9EH-6N	1673					0.6
	Sonic FT 50 (Air Cooled 2-Stroke)	98→01	BR8HS	4322			BR8HIX	7001	0.5
	Sonic GP 50 (Liquid Cooled 2-Stroke)	98→05	BR8HS	4322			BR8HIX	7001	0.5
	Sportcity One (4-Stroke)	08→11	CR8EB	7784			CR8EIX	4218	0.7
	Sportcity One Street (2-Stroke)	08→11	BR9ES	5722			BR9EIX	3981	0.6
	SR 50 (Air Cooled)	94→	BR7HS	4122			BR7HIX	7067	0.7
	SR 50 Stealth / LC / Racing (Liquid Cooled)	96→	BR7HS	4122			BR7HIX	7067	0.7
	SR 50 Carb (19mm Thread Reach)	04→	BR9ES	5722			BR9EIX	3981	0.6
	SR 50 Di Tech Injection	01→04	CPR8E	7411			CR8EIX	4218	0.8
	SR 50 Di Tech Injection	05→				ZMR7AP	6914		0.8
	SR 50 i.e. Pure Jet	04→				ZMR7AP	6914		0.8
	SR 50 WWW	01→02	BR7HS	4122			BR7HIX	7067	0.6
	SR 50R	05→	BR9ES	5722			BR9EIX	3981	0.6
SR Motard 50 (2-Stroke)	12→	BR9ES	5722			BR9EIX	3981	0.5	
SX 50	06→10	BR9ES	5722			BR9EIX	3981	0.6	
100	Scarabeo 100 2-Stroke (12.7mm Thread Reach)	99→01	BR8HS	4322			BR8HIX	7001	0.6
	Scarabeo 100 4-Stroke (19mm Thread Reach)	01→12	CR9EB	6955			CR9EIX	3521	0.5
125	AF1 125	88→93	BR10EG	3830			BR10EIX	6801	0.5
	AF1 Futura	90→93	BR10EG	3830			BR10EIX	6801	0.5
	Atlantic 125	03→13	CR8EB	7784			CR8EIX	4218	0.8
	Classic 125	99→06	BR10EG	3830			BR10EIX	6801	0.6
	ETX 125 (Liquid Cooled 2-Stroke)	98→01	BR8ES	5422			BR8EIX	5044	0.5
	Europa 125	90→92	BR10EG	3830			BR10EIX	6801	0.5



CC	MODEL	DATE	STANDARD COPPER CORE	STOCK NUMBER	PLATINUM OR GOLD PALLADIUM	STOCK NUMBER	IRIDIUM	STOCK NUMBER	GAP MM
APRILIA (CONTINUED)									
125	Habana 125 Custom & Retro (4-Stroke)	99→	CR8E	1275			CR8EIX	4218	0.6
	Leonardo 125	95→98	CR8E	1275			CR8EIX	4218	0.6
	Leonardo 125 & ST	99→04					CR8EIX	4218	0.6
	Mojito Custom 125	05→	CR7EB	4663			CR7EIX	7385	0.6
	MX125	04→07	BR8ES	5422			BR8EIX	5044	0.6
	Pegaso 125	92→96	BR10EG	3830			BR10EIX	6801	0.5
	Rally 125	89→90	B10EG	3630	B10EGV	5927	BR10EIX	6801	0.5
	Red Rose 125	88→94	BR10EG	3830			BR10EIX	6801	0.5
	RS 125 (12BHP Restricted)	93→12	BR8ES	5422			BR8EIX	5044	0.5
	RS 125 (35BHP Unrestricted)	93→12	BR10EG	3830			BR10EIX	6801	0.5
	RS 125R Extrema (12BHP Restricted)	93→12	BR8ES	5422			BR8EIX	5044	0.5
	RS 125R Extrema (35BHP Unrestricted)	93→12	BR10EG	3830			BR10EIX	6801	0.5
	RS125 Tuono	03→12	BR8ES	5422			BR8EIX	5044	0.6
	RS4 125	11→	CR9EB	6955			CR9EIX	3521	0.5
	RX125	94→96	BR10EG	3830			BR10EIX	6801	0.5
	RX125 (15BHP Restricted)	08→	BR8ES	5422			BR8EIX	5044	0.7
	RX125 (22BHP Unrestricted)	08→	BR10EG	3830			BR10EIX	6801	0.7
	Scarabeo 125cc (4-Stroke)	99→06	CR8E	1275			CR8EIX	4218	0.6
	Scarabeo 125cc (4-Stroke)	07→10			PMR9B	4717	CR9EIX	3521	0.7
	Sport City 125	04→08	CR8E	1275			CR8EIX	4218	0.6
	Sportcity Cube 125	08→11	CR7EB	4663			CR7EIX	7385	0.7
	Sportcity One 125	08→11	CR7EB	4663			CR7EIX	7385	0.7
	Sport Pro 125	92→93	BR10EG	3830			BR10EIX	6801	0.5
	SR 125	04/99→	BR8ES	5422			BR8EIX	5044	0.5
	SR 125AC	00→	BR8ES	5422			BR8EIX	5044	0.5
	SR MAX 125	11→	CR8EKB	4374			CR8EIX	4218	0.7
	SR Motard 125	12→	CR7EB	4663			CR7EIX	7385	0.7
	SX125 (15BHP Restricted)	08→	BR8ES	5422			BR8EIX	5044	0.7
SX125 (22BHP Unrestricted)	08→	BR10EG	3830			BR10EIX	6801	0.7	
Tuareg Wind 125	89→91	B10EG	3630	B10EGV	5927	BR10EIX	6801	0.5	
150	Leonardo 150	98→01	CR8E	1275			CR8EIX	4218	0.6
	Leonardo 150 ST	02→04					CR8EIX	4218	0.6
	Scarabeo 150 (4-Stroke)	99→	CR8E	1275			CR8EIX	4218	0.6
200	Atlantic 200	03→07	CR8EB	7784			CR8EIX	4218	0.8
	Scarabeo 200 (4-Stroke)	00→06	CR8E	1275			CR8EIX	4218	0.6
	Scarabeo 200 (4-Stroke)	07→10			PMR9B	4717	CR9EIX	3521	0.7
	Sportcity 200	04→08	CR7EB	4663			CR7EIX	7385	0.6
	Sportcity Cube 200	08→	CR7EB	4663			CR7EIX	7385	0.7
250	Atlantic 250	04→08	CR8EB	7784			CR8EIX	4218	0.7
	Leonardo 250	99→03	DR8EA	7162	DR8EVX	6354	DR8EIX	6681	0.6
	RS 250	94→04	BR9ECM	3252			BR9ECMIX	2707	0.7
	Scarabeo 250	04→06	CR8EB	7784			CR8EIX	4218	0.7
	Scarabeo 250	07→09			PMR8B	6378			0.7
	Sport City 250	04→10	CR8EB	7784			CR8EIX	4218	0.7
280	Climber trials bike	89→					BPR6EIX	6637	0.6
300	Leonardo 300	04→	DR8EA	7162	DR8EVX	6354	DR8EIX	6681	0.6
	Sportcity Cube	08→	CR8EKB	4374			CR8EIX	4218	0.7
	SR MAX 300	11→	CR8EKB	4374			CR8EIX	4218	0.7
400	Atlantic 400 Sprint	06→10	CR7EKB	4455			CR7EIX	7385	0.8
450	MXV 450	09→10	CR8EKB	4374			CR8EIX	4218	0.7
	RXV 4.5	06→08	CR8EB	7784			CR8EIX	4218	0.7
	RXV 4.5	09→	CR8EKB	4374			CR8EIX	4218	0.7
	SXV 4.5	06→08	CR8EB	7784			CR8EIX	4218	0.7
	SXV 4.5	09→	CR8EKB	4374			CR8EIX	4218	0.7
500	Atlantic 500	01→10	CR7EKB	4455			CR7EIX	7385	0.8
	Atlantic 500 Sprint	05→10	CR7EKB	4455			CR7EIX	7385	0.8
	Scarabeo 500	03→08	CR7EKB	4455			CR7EIX	7385	0.8
550	RXV 5.5	06→08	CR8EB	7784			CR8EIX	4218	0.7
	RXV 5.5	09→	CR8EKB	4374			CR8EIX	4218	0.7
	SXV 5.5	06→08	CR8EB	7784			CR8EIX	4218	0.7
	SXV 5.5	09→	CR8EKB	4374			CR8EIX	4218	0.7
600	Pegaso 600	92→94	D8EA	2120	DR8EVX	6354	DR8EIX	6681	0.6
	Tuareg 600	88→92	D8EA	2120	DR8EVX	6354	DR8EIX	6681	0.6



CC	MODEL	DATE	STANDARD COPPER CORE	STOCK NUMBER	PLATINUM OR GOLD PALLADIUM	STOCK NUMBER	IRIDIUM	STOCK NUMBER	GAP MM
APRILIA (CONTINUED)									
650	Moto 6.5 (650)	95→03	D8EA	2120	DR8EVX	6354	DR8EIX	6681	0.7
	Pegaso 650 (Carburettor)	93→00	D8EA	2120	DR8EVX	6354	DR8EIX	6681	0.6
	Pegaso 650 (Injection) Ø12mm Plug	01→04	DR8EB	4855	DR8EVX	6354	DR8EIX	6681	0.7
	Pegaso Strada & Trail 650 Ø10mm Plug	05→09	CR7E	4578			CR7EIX	7385	0.7
	Pegaso Factory	02/07→09	CR7E	4578			CR7EIX	7385	0.7
750	Shiver GT (Half faired) (Incl. ABS)	09→	CR7EKB	4455			CR7EIX	7385	0.8
	SL 750 Shiver (Incl. ABS)	07→	CR7EKB	4455			CR7EIX	7385	0.8
	SMV 750 Dorsoduro / Factory	07→	CR7EKB	4455			CR7EIX	7385	0.8
839	Mana GT ABS (Twin Spark)	09→	CR7EKB	4455			CR7EIX	7385	0.8
	NA 850 Mana (Incl. ABS) (Twin Spark)	08→	CR7EKB	4455			CR7EIX	7385	0.8
	SRV850 (Twin Spark)	12→	CR7EKB	4455			CR7EIX	7385	0.8
1000	ETV 1000 Caponord	01→	DCPR9E	2641			DCPR9EIX	2316	0.6
	RST 1000 Futura	01→03	DCPR9E	2641			DCPR9EIX	2316	0.6
	RSV 1000 R Factory	04→	DCPR9E	2641			DCPR9EIX	2316	0.6
	RSV 4 Factory	09→14	CR9EB	6955			CR9EIX	3521	0.7
	RSV 4 R	09→14	CR9EB	6955			CR9EIX	3521	0.7
	RSV 4 RF	15→	CR9EKB	2305			CR9EIX	3521	0.8
	RSV Mille	98→	DCPR9E	2641			DCPR9EIX	2316	0.6
	RSV Mille R	98→03	DCPR9E	2641			DCPR9EIX	2316	0.6
	RSV Mille R	04→	DCPR9E	2641			DCPR9EIX	2316	0.6
	RSV Mille SP (Sport Production)	00→03	R0045J-10	7400					1.1
	RSV Mille Tuono	02→	DCPR9E	2641			DCPR9EIX	2316	0.6
	SL 1000 Falco	99→06	DCPR9E	2641			DCPR9EIX	2316	0.6
	Tuono 1000	04→	DCPR9E	2641			DCPR9EIX	2316	0.6
	Tuono 1000 R	05→	DCPR9E	2641			DCPR9EIX	2316	0.6
Tuono V4R	05/11→14	CR9EKB	2305			CR9EIX	3521	0.8	
1077	Tuono V4 1100 RR	15→	CR9EKB	2305			CR9EIX	3521	0.8
1197	1200 Dorsoduro	11→	CR8EKB	4374			CR8EIX	4218	0.7
	Caponord (Twin Spark)	13→	CR8EKB	4374			CR8EIX	4218	0.7
	Caponord Rally (Twin Spark)	15→	CR8EKB	4374			CR8EIX	4218	0.7

ATALA

50	Byte	97→98	B7HS	5110			BR7HIX	7067	0.5
	Carosello	97→00	B7HS	5110			BR7HIX	7067	0.5
	Hacker AT 12, Hacker Racing	97→98	BPR6HS	7022			BPR6HIX	4085	0.6
	Master	98→99	B6HS	4510			BR6HIX	3419	0.6
	Skeggia	99→00	BPR6HS	7022			BPR6HIX	4085	0.6

BAJAJ

50	Sunny, Bonnie 50	93→	B6HS	4510			BR6HIX	3419	0.5
100	KB100	93→	B8ES	2411			BR8EIX	5044	0.5
125	Vespa, Chetak (Scooter)	93→	B6HS	4510			BR6HIX	3419	0.5
150	Chetak 150	01→	BPR6HS	6222					0.7

BAOTIAN

50	BT49QT-9 / -11 / -12 Ø10mm Plug	04→	CR7HSA	4549			CR7HIX	7544	0.6
110	BT110-2	04→	CR7HSA	4549			CR7HIX	7544	0.6
125	Citibike 125	04→	CR7HSA	4549			CR7HIX	7544	0.6
	Monza 125	11→	CR7HSA	4549			CR7HIX	7544	0.6
	Tanco 125	04→	CR7HSA	4549			CR7HIX	7544	0.6

BAROSSA

125	XS125T-13	12/07→	CR7HSA	4549			CR7HIX	7544	0.6
-----	-----------	--------	--------	------	--	--	--------	------	-----

BASHAN

110	BS110 GY	01→	C7HSA	4629			CR7HIX	7544	0.6
125	BS125 GY	01→	D8EA	2120	DR8EVX	6354	DR8EIX	6681	0.6
200	BS200 GY	01→	D8EA	2120	DR8EVX	6354	DR8EIX	6681	0.6
250	Vixen VX250	06→	DR8EA	7162	DR8EVX	6354	DR8EIX	6681	0.7



CC	MODEL	DATE	STANDARD COPPER CORE	STOCK NUMBER	PLATINUM OR GOLD PALLADIUM	STOCK NUMBER	IRIDIUM	STOCK NUMBER	GAP MM
BATAVUS									
50	Mondial	80→	B6HS	4510			BR6HIX	3419	0.4
	Starglo	76→	B7HS	5110			BR7HIX	7067	0.5

BEELINE									
50	Veloce GT 50	09→	C7HSA	4629			CR7HIX	7544	0.6
	Veloce Racing	09→	C7HSA	4629			CR7HIX	7544	0.6

BENELLI									
50	491 Sport, ST GP, Rage, RR SBK, RR GP	98→	BR8HS	4322			BR8HIX	7001	0.5
	49X Quattro Nove	08→	BR8HSA	5539			BR8HIX	7001	0.8
	49X Road	08→	BR8HSA	5539			BR8HIX	7001	0.8
	49X Trek	08→	BR8HSA	5539			BR8HIX	7001	0.8
	50 Cross	64→	B6ES	7310					0.5
	G2	75→80	B6ES	7310					0.5
	G2 Elle	75→80	B6ES	7310					0.5
	K2, K2 Air	98→	BR8HS	4322			BR8HIX	7001	0.5
	Motorella	65→	B6ES	7310					0.5
	Namur 50	98→01	BR8HS	4322			BR8HIX	7001	0.5
	Pepe	00→	BR8HS	4322			BR8HIX	7001	0.5
100	K2 100	99→	BR8HS	4322			BR8HIX	7001	0.5
125	125 Roadster/Cross	71→	B7ES	1111			BR7EIX	6664	0.5
	Adiva	01→06	CR8EB	7784			CR8EIX	4218	0.8
	TnT 125	17→	CR7HSA	4549			CR7HIX	7544	0.6
	Velvet 125	99→	CR8E	1275			CR8EIX	4218	0.6
150	Adiva 150	01→06	CR8E	1275			CR8EIX	4218	0.6
230	254 & 304	80→	B7HS	5110			BR7HIX	7067	0.5
250	250 (4-cyl.)		C7HSA	4629			CR7HIX	7544	0.5
	250 Super	72→	B8ES	2411			BR8EIX	5044	0.5
	Adiva 250	08→	CR8EB	7784			CR8EIX	4218	0.8
	Cafénero 250	12→	CR8E	1275			CR8EIX	4218	0.6
	Velvet 250	00→	CR8E	1275			CR8EIX	4218	0.6
300	BN 302	14→	CR9EB	6955			CR9EIX	3521	0.7
350	354 Sei	80→	D8EA	2120	DR8EVX	6354	DR8EIX	6681	0.5
400	Velvet 400	03→04	CR9E	6263			CR9EIX	3521	0.7
500	Quattro 500	73→83	D8EA	2120	DR8EVX	6354	DR8EIX	6681	0.5
600	BN 600 GT	14→	CR9E	6263			CR9EIX	3521	0.7
	BN 600 I	14→	CR9E	6263			CR9EIX	3521	0.7
	BN 600 R	14→	CR9E	6263			CR9EIX	3521	0.7
650	654 Sei	80→	D8EA	2120	DR8EVX	6354	DR8EIX	6681	0.5
750	750 Sei	72→78	D8EA	2120	DR8EVX	6354	DR8EIX	6681	0.5
900	900 Sei	79→	D8EA	2120	DR8EVX	6354	DR8EIX	6681	0.5
	TNT 899/S/T (Tornado Naked Tre)	08→	CR9E	6263			CR9EIX	3521	0.7
	Tornado Tre 900/903 RS	02→	CR9E	6263			CR9EIX	3521	0.7
	Tornado Tre 903	08→	CR9E	6263			CR9EIX	3521	0.7
	Tre-K 899	09→	CR9EB	6955			CR9EIX	3521	0.7
1130	TNT R160	10→	CR9EB	6955			CR9EIX	3521	0.7
	TNT 1130, K	04→	CR9E	6263			CR9EIX	3521	0.7
	TNT 1130 Titanium	06→	CR9E	6263			CR9EIX	3521	0.8
	TNT 1130 Sport Evo (Tornado Naked Tre)	07→	CR9E	6263			CR9EIX	3521	0.8
	TNT Café Racer 1130	01/06→	CR9E	6263			CR9EIX	3521	0.8
	Tornado Tre 1130	06→	CR9E	6263			CR9EIX	3521	0.7
	Tornado Tre K	06→	CR9E	6263			CR9EIX	3521	0.7
	Tre-K 1130K (Incl. Amazonas)	07→	CR9EB	6955			CR9EIX	3521	0.7

BENZHOU									
50	YY50QT	08→	CR7HSA	4549			CR7HIX	7544	0.6
125	YY125T		CR7HSA	4549			CR7HIX	7544	0.6
150	YY150		CR7HSA	4549			CR7HIX	7544	0.6
250	YY250	07→	DR8EA	7162	DR8EVX	6354	DR8EIX	6681	0.6



CC	MODEL	DATE	STANDARD COPPER CORE	STOCK NUMBER	PLATINUM OR GOLD PALLADIUM	STOCK NUMBER	IRIDIUM	STOCK NUMBER	GAP MM
BETA / BETAMOTOR									
50	Ark (Air Cooled)	98→	BR7HS	4122			BR7HIX	7067	0.6
	Ark (Liquid Cooled)	97→	BR8HS	4322			BR8HIX	7001	0.7
	Eikon 50	99→	BR8HS	4322			BR8HIX	7001	0.7
	Enduro 50		BR10ES	4832			BR10EIX	6801	0.7
	Mini Cross 10/10, 12/13, 12/15 & Mini Trial	05→07	B7HS	5110			BR7HIX	7067	0.6
	Quadra	97→	BR7HS	4122			BR7HIX	7067	0.6
	R10 (12.7mm Thread Reach)	08→09	B7HS	5110			BR7HIX	7067	0.6
	R12 (12.7mm Thread Reach)	08→09	B7HS	5110			BR7HIX	7067	0.6
	R10, R12 (19mm Thread Reach)	10→12	BR8ES	5422			BR8EIX	5044	0.6
	Rev 50	03→	B9ES	2611			BR9EIX	3981	0.5
	RR Enduro 50	98→05	BR10ES	4832			BR10EIX	6801	0.7
	RR Enduro 50, Racing 50 (Euro 2)	04→	BR9ES	5722			BR9EIX	3981	0.6
	RR 50 Motard	08→	BR9ES	5722			BR9EIX	3981	0.6
	Supermotard 50	02→05	BR10ES	4832			BR10EIX	6801	0.7
	Supermoto 50		BR10ES	4832			BR10EIX	6801	0.7
Tempo		BR7HS	4122			BR7HIX	7067	0.6	
Zero		B8ES	2411			BR8EIX	5044	0.5	
70	Supermoto 72, Enduro 72						BR10HIX	6692	0.6
80	EVO 80, Junior	09→	BR8ES	5422			BR8EIX	5044	0.6
	Rev 80	03→	B9ES	2611			BR9EIX	3981	0.5
107	R107-4T		C7HSA	4629			CR7HIX	7544	0.7
125	125 E6G		B7HS	5110			BR7HIX	7067	0.5
	125 Enduro		B7HS	5110			BR7HIX	7067	0.5
	125 Trial		B6ES	7310					0.5
	Alp 4T 125	00→	DR8EA	7162	DR8EVX	6354	DR8EIX	6681	0.6
	Eikon 125	99→	DPR7EA-9	5129			DPR7EIX-9	7803	0.9
	Euro 125		DR8EA	7162	DR8EVX	6354	DR8EIX	6681	0.6
	EVO 125 2T	09→16	BR7ES	5122			BR7EIX	6664	0.6
	Minicross R 125 4T	08→	C7HSA	4629			CR7HIX	7544	0.7
	RE 125 4T	08→09	CR7HSA	4549			CR7HIX	7544	0.6
	REV 3 125 Trials	00→07	BP7ES	2412			BPR7EIX	4055	0.6
	REV 3 125 Trials	08→	BR7ES	5122			BR7EIX	6664	0.7
	RR 125 4-Stroke Enduro, Motard (Air Cooled)	08→11	CR7HSA	4549			CR7HIX	7544	0.6
	RR 125 4-Stroke Enduro, Motard (Liquid Cooled)	10→	CR8E	1275			CR8EIX	4218	0.6
	Synt	92→	B8ES	2411			BR8EIX	5044	0.5
	TR32	85→	B8ES	2411			BR8EIX	5044	0.5
	TR34	87→	B8ES	2411			BR8EIX	5044	0.5
	TR35	90→	B8ES	2411			BR8EIX	5044	0.5
	Urban 125	08→	CR7HSA	4549			CR7HIX	7544	0.6
Zero	92→	B8ES	2411			BR8EIX	5044	0.5	
150	Eikon 150	99→	DPR7EA-9	5129			DPR7EIX-9	7803	0.9
200	Alp 4T 200	00→	DR8EA	7162	DR8EVX	6354	DR8EIX	6681	0.6
	EVO 200 2T	09→16	BR7ES	5122			BR7EIX	6664	0.6
	REV 3 200 Trials	00→07	BP7ES	2412			BPR7EIX	4055	0.6
	REV 3 200 Trials	08→	BR7ES	5122			BR7EIX	6664	0.7
	Techno 200 Trial	→96	BR8ES	5422			BR8EIX	5044	0.6
	Techno 200 Trial	96→	BP7ES	2412			BPR7EIX	4055	0.6
	Urban 200	08→	DR8EA	7162	DR8EVX	6354	DR8EIX	6681	0.6
240	Super Trial	92→93	B8ES	2411			BR8EIX	5044	0.5
	TR33	86→	B6ES	7310					0.5
	Trial	85→	B6ES	7310					0.5
250	EVO 250 2T	09→16	BR7ES	5122			BR7EIX	6664	0.6
	EVO 250 4T	09→	CR7EB	4663			CR7EIX	7385	0.6
	GS Enduro	77→	B7HS	5110			BR7HIX	7067	0.5
	REV 3 250 2T Trials	00→07	BP7ES	2412			BPR7EIX	4055	0.6
	REV 3 250 2T Trials	08→	BR7ES	5122			BR7EIX	6664	0.7
	REV 4T 250 Trials	07→	CR7EB	4663			CR7EIX	7385	0.6
	RR 250 2-stroke	13→15	BR7ES	5122			BR7EIX	6664	0.6
	RR 250 2-stroke	16→	BR8ES	5422			BR8EIX	5044	0.6
RR 250 4T	05→06	DCPR8E*	4339			DCPR8EIX	6546	0.7	



* Please note DCPR8E 4339 has a removable terminal nut, whereas DCPR8E 4179 has a fixed terminal nut





CC	MODEL	DATE	STANDARD COPPER CORE	STOCK NUMBER	PLATINUM OR GOLD PALLADIUM	STOCK NUMBER	IRIDIUM	STOCK NUMBER	GAP MM
BETA / BETAMOTOR (CONTINUED)									
250	Techno 250 Trial	→96	BR8ES	5422			BR8EIX	5044	0.6
	Techno 250 Trial	96→	BP7ES	2412			BPR7EIX	4055	0.6
	TR32	85→	B8ES	2411			BR8EIX	5044	0.5
260	Synt	92→	B8ES	2411			BR8EIX	5044	0.5
	TR34	87→	B8ES	2411			BR8EIX	5044	0.5
	TR35	90→	B8ES	2411			BR8EIX	5044	0.5
	Zero Gara	93→	B8ES	2411			BR8EIX	5044	0.5
270	REV 3 270 Trials	00→07	BP7ES	2412			BPR7EIX	4055	0.6
	REV 3 270 Trials	08→	BR7ES	5122			BR7EIX	6664	0.7
	Techno 270 Trial	→96	BR8ES	5422			BR8EIX	5044	0.6
	Techno 270 Trial	96→	BP7ES	2412			BPR7EIX	4055	0.6
290	EVO 290 2T	09→	BR7ES	5122			BR7EIX	6664	0.6
300	EVO 300 2T	11→16	BR7ES	5122			BR7EIX	6664	0.6
	EVO 300 4T	09→	CR7EB	4663			CR7EIX	7385	0.6
	RR 300 2-stroke	13→	BR7ES	5122			BR7EIX	6664	0.6
350	Alp 4.0 (Suzuki engine)	08→	CR9EK	4548			CR9EIX	3521	0.7
	Euro 350	01→	CR9EK	4548			CR9EIX	3521	0.7
	Jonathan 350	99→06	CR9EK	4548			CR9EIX	3521	0.7
	Motard 4.0, M4	08→14	CR9EK	4548			CR9EIX	3521	0.7
	RR 350	11→	LKAR8A-9	4786			LKAR8AI-9	6706	0.9
386	RR 390	15→	LKAR8A-9	4786			LKAR8AI-9	6706	0.9
	RS 390	15→	LKAR8A-9	4786			LKAR8AI-9	6706	0.9
400	RR 400 4T	05→09	DCPR8E*	4339			DCPR8EIX	6546	0.7
	RR 400 4-stroke	10→	LKAR8A-9	4786			LKAR8AI-9	6706	0.9
	RS 400	11→14	LKAR8A-9	4786			LKAR8AI-9	6706	0.9
430	RR 430	15→	LKAR8A-9	4786			LKAR8AI-9	6706	0.9
	RS 430	15→	LKAR8A-9	4786			LKAR8AI-9	6706	0.9
450	RR 450 4T	05→09	DCPR8E*	4339			DCPR8EIX	6546	0.7
	RR 450 4-stroke	10→14	LKAR8A-9	4786			LKAR8AI-9	6706	0.9
	RS 450	11→14	LKAR8A-9	4786			LKAR8AI-9	6706	0.9
480	RR 480	15→	LKAR8A-9	4786			LKAR8AI-9	6706	0.9
500	RR 500	13→14	LKAR8A-9	4786			LKAR8AI-9	6706	0.9
	RS 500	15→	LKAR8A-9	4786			LKAR8AI-9	6706	0.9
	RR 520 4-stroke	10→14	LKAR8A-9	4786			LKAR8AI-9	6706	0.9
	RS 520	11→14	LKAR8A-9	4786			LKAR8AI-9	6706	0.9
525	RR 525 4T	05→09	DCPR8E*	4339			DCPR8EIX	6546	0.7

BIMOTA									
500	500 V-Due		BR9ES	5722			BR9EIX	3981	0.7
600	YB9 SRi		CR9E	6263			CR9EIX	3521	0.7
900	DB3 Mantra		DPR8EA-9	4929			DPR8EIX-9	2202	0.6
	DB4		DPR8EA-9	4929			DPR8EIX-9	2202	0.6
	Mantra		DPR7EA-9	5129			DPR7EIX-9	7803	0.9
992	DB5	05→	DCPR8E*	4339			DCPR8EIX	6546	0.9
	DB6 Delirio	06→	DCPR8E*	4339			DCPR8EIX	6546	0.9
1000	BB3	08/14→16	LMAR9D-J	1633					0.8
	Mono, Biposto	91→93	D8EA	2120	DR8EVX	6354	DR8EIX	6681	0.6
	SB8R/S	99→00	CR9EK	4548			CR9EIX	3521	0.7
	YB11 Superleggera	00→	DR8EA	7162	DR8EVX	6354	DR8EIX	6681	0.7
1078	DB5R/S	07→	DCPR8E*	4339			DCPR8EIX	6546	0.9
	DB6R/S	08→	DCPR8E*	4339			DCPR8EIX	6546	0.9
	DB10 bimotard	12→16	DCPR8E*	4339			DCPR8EIX	6546	0.9
	DBx	13→16	DCPR8E*	4339			DCPR8EIX	6546	0.9
	Tesi 3D	07→16	DCPR8E*	4339			DCPR8EIX	6546	0.9
1098	DB7	09→	MAR10A-J	4706					0.8
1100	SB6, SB6R	97→	CR9E	6263			CR9EIX	3521	0.7
1198	DB8	10→16	MAR10A-J	4706					0.8
	DB9 Brivido, S	12→16	MAR9A-J	6869					0.8



* Please note DCPR8E 4339 has a removable terminal nut, whereas DCPR8E 4179 has a fixed terminal nut





CC	MODEL	DATE	STANDARD COPPER CORE	STOCK NUMBER	PLATINUM OR GOLD PALLADIUM	STOCK NUMBER	IRIDIUM	STOCK NUMBER	GAP MM	
BMW										
125	C1	00→04	CR8EB	7784			CR8EIX	4218	0.7	
175	C1 200	01→04	CR8EB	7784			CR8EIX	4218	0.7	
313	G310 R	17→	LMAR9D-J	1633					0.8	
450	G450X	08→11	CR9EKB	2305			CR9EIX	3521	0.8	
	R45	78→85	BP7ES	2412			BPR7EIX	4055	0.6	
600	R60/7	76→78	BP7ES	2412			BPR7EIX	4055	0.6	
650	C600 Sport	12→15	LMAR8D-J	93444					0.8	
	C650 GT	12→	LMAR8D-J	93444					0.8	
	C650 Sport	16→	LMAR8D-J	93444					0.8	
	F650	94→99	D8EA	2120	DR8EVX	6354	DR8EIX	6681	0.7	
	F650ST Strada	97→99	D8EA	2120	DR8EVX	6354	DR8EIX	6681	0.7	
	F650GS, GSD	00→02	DR8EB	4855	DR8EVX	6354	DR8EIX	6681	0.7	
	F650CS, GS, GS Dakar	02→05	DR8EB	4855	DR8EVX	6354	DR8EIX	6681	0.7	
	F650GS, GS Dakar (Single cylinder Twin Spark)	11/05→11/07	DR8EB	4855	DR8EVX	6354	DR8EIX	6681	0.7	
	G650GS (Twin Spark)	03/11→	DR8EB	4855	DR8EVX	6354	DR8EIX	6681	0.7	
	G650GS Sertão (Twin Spark)	03/12→	DR8EB	4855	DR8EVX	6354	DR8EIX	6681	0.7	
	G650 Xchallenge, Xcountry, Xmoto (Twin Spark)	07→09	DR8EB	4855	DR8EVX	6354	DR8EIX	6681	0.7	
	R65	78→93	BP7ES	2412			BPR7EIX	4055	0.6	
	R65/GS	87→92	BP6ES	7811			BPR6EIX	6637	0.6	
	R65LS	81→85	BP7ES	2412			BPR7EIX	4055	0.6	
	750	K75	85→97	D7EA	7912					0.6
		R75/7	76→79	BP7ES	2412			BPR7EIX	4055	0.6
800	F650GS (Twin cylinder 798cc)	11/07→12	DCPR8E*	4339			DCPR8EIX	6546	0.7	
	F 700 GS	13→	DCPR8E*	4339			DCPR8EIX	6546	0.8	
	F800S/ST	05/06→12	DCPR8E*	4339			DCPR8EIX	6546	0.8	
	F 800 GT	13→	DCPR8E*	4339			DCPR8EIX	6546	0.8	
	F800GS	11/07→	DCPR8E*	4339			DCPR8EIX	6546	0.8	
	F800R	05/09→	DCPR8E*	4339			DCPR8EIX	6546	0.8	
	R80GS	80→94	BP6ES	7811			BPR6EIX	6637	0.6	
	R80RT	82→95	BP6ES	7811			BPR6EIX	6637	0.6	
	R80ST	82→85	BP6ES	7811			BPR6EIX	6637	0.6	
R80TIC	80→85	BP6ES	7811			BPR6EIX	6637	0.6		
850	R850C, R850GS, R850R	→04/99	BCPR7ET	2164			BKR7EIX	2667	0.8	
	R850C, R850GS, R850R	04/99→00	BKR7EKC	7354			BKR7EIX	2667	0.8	
900	R90/6	73→76	BP6ES	7811			BPR6EIX	6637	0.6	
	R90S	73→76	BP6ES	7811			BPR6EIX	6637	0.6	
1000	K1	89→93	D7EA	7912					0.6	
	K100, C, LT, R, RS, RT 8 Valve	83→90	D7EA	7912					0.6	
	K100, C, LT, R, RS, RT 16 Valve	91→92	D7EA	7912					0.6	
	R100/7	76→79	BP7ES	2412			BPR7EIX	4055	0.6	
	R100RS, S	76→85	BP7ES	2412			BPR7EIX	4055	0.6	
	R100RT	79→85	BP7ES	2412			BPR7EIX	4055	0.6	
	R100GS, RS, RT (Re-introduced)	87→93	BP6ES	7811			BPR6EIX	6637	0.6	
	S1000R	11/13→	LMAR9D-J	1633					0.8	
	S1000RR (Incl. HP4)	12/09→	LMAR9D-J	1633					0.8	
	S1000 XR	06/15→	LMAR9D-J	1633					0.8	
1100	K1100LT/SE	92→99	DR7EA	7839					0.6	
	K1100RS	92→96	DR7EA	7839					0.6	
	R1100GS	→04/99	BCPR7ET	2164			BKR7EIX	2667	0.8	
	R1100GS	04/99→99	BKR7EKC	7354			BKR7EIX	2667	0.8	
	R1100R	95→03	BCPR7ET	2164			BKR7EIX	2667	0.8	
	R1100RS/RT	93→01	BCPR7ET	2164			BKR7EIX	2667	0.8	
	R1100S	→04/99	BCPR7ET	2164			BKR7EIX	2667	0.8	
	R1100S	04/99→03	BKR7EKC	7354			BKR7EIX	2667	0.8	
	R1100S (Twin Spark)	Ø12mm Plug 03→05 Ø14mm Plug	DCPR8EKC BKR7EKC	7168 7354			DCPR8EIX BKR7EIX	6546 2667	0.9 0.9	
	1130	R1150GS/R/RS/RT	99→03	BKR7EKC	7354			BKR7EIX	2667	0.9
R1150GS/R/S (Twin Spark)		Ø12mm Plug 03→05 Ø14mm Plug	DCPR8EKC	7168			DCPR8EIX	6546	0.9	
			BKR7EKC	7354			BKR7EIX	2667	0.9	
1157	K1200R	01/05→08					KR9CI	7795	0.8	
	K1200R Sport	11/07→09					KR9CI	7795	0.8	
	K1200S	09/04→09					KR9CI	7795	0.8	



* Please note DCPR8E 4339 has a removable terminal nut, whereas DCPR8E 4179 has a fixed terminal nut





CC	MODEL	DATE	STANDARD COPPER CORE	STOCK NUMBER	PLATINUM OR GOLD PALLADIUM	STOCK NUMBER	IRIDIUM	STOCK NUMBER	GAP MM
BMW (CONTINUED)									
1170	HP2 Enduro (Twin Spark)	Ø12mm Plug Ø14mm Plug	05→08	DCPR8EKC	7168		DCPR8EIX	6546	0.9
				BKR7EKC	7354		BKR7EIX	2667	0.9
	HP2 Megamoto (Twin Spark) Ø12mm Plug		07→08	DCPR8EKC	7168		DCPR8EIX	6546	0.9
	HP2 Sport		08→12	MAR9B-JDS	1316				0.8
	K1200GT		03→11/05	DCPR7E	3932		DCPR7EIX	6046	0.8
	K1200GT		01/06→08				KR9CI	7795	0.8
	K1200RS/LT		97→05	DCPR7E	3932		DCPR7EIX	6046	0.8
	R1200C Classic, Avantgarde, Independent		97→04	BKR7EKC	7354		BKR7EIX	2667	0.9
	R1200GS (Twin Spark) Ø12mm Plug		04→09	DCPR8EKC	7168		DCPR8EIX	6546	0.9
	R1200GS (Twin Spark) Ø10mm Plug (19mm Thread Reach)		10→02/13	MAR8B-JDS	8765				0.8
	R1200GS (Liquid Cooled) (26.5mm Thread Reach)		03/13→	LMAR8D-J	93444				0.8
	R1200GS Adventure (Liquid Cooled) (26.5mm Thread Reach)		10/13→	LMAR8D-J	93444				0.8
	R1200R SOHC (Twin Spark) Ø12mm Plug		06→10	DCPR8EKC	7168		DCPR8EIX	6546	0.9
	R1200R, Classic DOHC (Twin Spark) Ø10mm Plug (19mm Thread Reach)		03/11→14	MAR8B-JDS	8765				0.8
	R1200 R (26.5mm Thread Reach)		02/15→	LMAR8D-J	93444				0.8
	R1200 RS (26.5mm Thread Reach)		06/15→	LMAR8D-J	93444				0.8
	R1200RT (Twin Spark) Ø12mm Plug		03/05→09	DCPR8EKC	7168		DCPR8EIX	6546	0.9
	R1200RT (Twin Spark) Ø10mm Plug (19mm Thread Reach)		09→10/13	MAR8B-JDS	8765				0.8
	R1200RT (Liquid Cooled) (26.5mm Thread Reach)		11/13→	LMAR8D-J	93444				0.8
	R1200S (Twin Spark)		06→07	DCPR8EKC	7168		DCPR8EIX	6546	0.9
R1200ST (Twin Spark)		03/05→11/07	DCPR8EKC	7168		DCPR8EIX	6546	0.9	
R nineT (Twin Spark)		14→	MAR8B-JDS	8765				0.8	
R nineT Pure, Racer (Twin Spark)		16→	MAR8B-JDS	8765				0.8	
R nineT Scrambler (Twin Spark)		16→	MAR8B-JDS	8765				0.8	
R nineT Urban (Twin Spark)		16→	MAR8B-JDS	8765				0.8	
1293	K1300GT (Incl. Exclusive Edition)		09→13				KR9CI	7795	0.8
	K1300R		09→15				KR9CI	7795	0.8
	K1300S (Incl. HP)		09→16				KR9CI	7795	0.8
1640	K1600GT, GTL		11→				LMAR8AI-8	92288	0.8

BSA										
50	Beaver, Brigand, Boxer			B6HS	4510			BR6HIX	3419	0.5
	ER1K, Junior, Easy Rider ER1/ER2		80→	BP6ES	7811			BPR6EIX	6637	0.5
	NVT Models: Easy Rider ER1/2/4, Ranger		80→	BP6ES	7811			BPR6EIX	6637	0.5
125	Rambler 125, Tracker 125		79→	B9ES	2611			BR9EIX	3981	0.5
175	Rambler 175, Tracker 175, Trials 175		79→	B8ES	2411			BR8EIX	5044	0.5
400	Gold SR 400		99→03	BPR6ES	7822			BPR6EIX	6637	0.7
500	Gold SR 500		99→	BPR7ES	2023			BPR7EIX	4055	0.7
	Victor, B50 Moto-Cross		66→67	B8EG	3430	B8EGV	5627	BR8EIX	5044	0.5
650	Golden Flash (A10) (1/2", 12.7mm Thread Reach)		50→54	B6HS	4510			BR6HIX	3419	0.5
	Road Rocket (3/4", 19mm Thread Reach)		54→56	B7ES	1111			BR7EIX	6664	0.5
	Rocket Gold Star		62→63	B7ES	1111			BR7EIX	6664	0.5
	Super Rocket		57→62	B7ES	1111			BR7EIX	6664	0.5
750	A75 and Rocket 3		→75	B8ES	2411			BR8EIX	5044	0.6

BUELL										
984	Firebolt XB9R		02→	DCPR9E	2641			DCPR9EIX	2316	0.9
	Lightning CityX XB9SX		05→	DCPR9E	2641			DCPR9EIX	2316	0.9
	Lightning XB9S		02→	DCPR9E	2641			DCPR9EIX	2316	0.9
	XB9X (City X)		09→10	DCPR9E	2641			DCPR9EIX	2316	0.9
1125	1125R		08→10	CR9EKB	2305			CR9EIX	3521	0.8
	1125CR (Café Racer)		09→10	CR9EKB	2305			CR9EIX	3521	0.8
1200	Firebolt XB12R		03→	DCPR9E	2641			DCPR9EIX	2316	0.9
	Lightning XB12S/Ss		04→10	DCPR9E	2641			DCPR9EIX	2316	0.9
	Lightning XB12Scg		06→10	DCPR9E	2641			DCPR9EIX	2316	0.9
	Lightning XB12STT		07→10	DCPR9E	2641			DCPR9EIX	2316	0.9
	M2 Cyclone		97→03	DCPR9E	2641			DCPR9EIX	2316	0.9
	S1 Lightning		97→99	DCPR9E	2641			DCPR9EIX	2316	0.9
	S1W White Lightning		1998	DCPR9E	2641			DCPR9EIX	2316	0.9
S3 Thunderbolt		97→99	DCPR9E	2641			DCPR9EIX	2316	0.9	



CC	MODEL	DATE	STANDARD COPPER CORE	STOCK NUMBER	PLATINUM OR GOLD PALLADIUM	STOCK NUMBER	IRIDIUM	STOCK NUMBER	GAP MM
BUELL (CONTINUED)									
1200	Ulysses XB12X	05→	DCPR9E	2641			DCPR9EIX	2316	0.9
	X1 Lightning	99→03	DCPR9E	2641			DCPR9EIX	2316	0.9

CAGIVA									
50	City 50	94→	BPR8HS	3725			BPR8HIX	6742	0.5
	Mito 50 (Standard)	98→	B9ES	2611			BR9EIX	3981	0.5
	Prima 50	92→	B8ES	2411			BR8EIX	5044	0.5
	Supercity 50	92→	B8ES	2411			BR8EIX	5044	0.5
	W4 50	92→	B8ES	2411			BR8EIX	5044	0.5
75	Prima 80	92→	B8ES	2411			BR8EIX	5044	0.5
	Supercity 80	92→	B8ES	2411			BR8EIX	5044	0.5
	W4 80	92→	B8ES	2411			BR8EIX	5044	0.5
125	Blues 125	91→93			B95EGV	2145			0.5
	Freccia C12/C12R	89→	B9ES	2611			BR9EIX	3981	0.5
	K7	90→			B95EGV	2145			0.5
	Mito 125	91→	BR9EG	3230			BR9EIX	3981	0.6
	Mito 125 (Race)				B95EGV	2145			0.7
	Mito (Le Lawson)	92→			B95EGV	2145			0.5
	Mito 525SP	04/08→	BR9EG	3230			BR9EIX	3981	0.6
	Planet 125	98→			B95EGV	2145			0.6
	Raptor (2-Stroke)	04→	BR9EG	3230			BR9EIX	3981	0.6
	Roadster 125	92→	B9ES	2611			BR9EIX	3981	0.6
	Super City 125	→02/95	B9EG	3530	B9EGV	5827	BR9EIX	3981	0.5
	Super City 125	06/98→			B95EGV	2145			0.6
	W8 125	→12/92	B9EG	3530	B9EGV	5827	BR9EIX	3981	0.6
	W8 125	07/98→	B9ES	2611			BR9EIX	3981	0.6
	WMX 125		B10EG	3630	B10EGV	5927	BR10EIX	6801	0.5
WSXT 125	82→	B9EG	3530	B9EGV	5827	BR9EIX	3981	0.5	
250	SST 250	81→	B8ES	2411			BR8EIX	5044	0.5
	WMX 250				B95EGV	2145			0.5
350	Indiana 350	78→89	BP7HS	5111			BPR7HIX	5944	0.5
	W12 350	93→	DPR8EA-9	4929			DPR8EIX-9	2202	0.6
500	Canyon 500	02/98→	DCPR8E*	4179			DCPR8EIX	6546	0.6
	River 500	99→	DCPR8E*	4179			DCPR8EIX	6546	0.6
600	Canyon 600	→03/97	BCP7ES	5030			BCPR7EIX	5690	0.8
	River 600	95→	BCP7ES	5030			BCPR7EIX	5690	0.8
	W16 600	→95	C7E	5096			CR7EIX	7385	0.6
	W16 600	95→	BCP7ES	5030			BCPR7EIX	5690	0.8
650	Alazzurra 650	85→88	BP7HS	5111			BPR7HIX	5944	0.5
	Indiana 650		BP7HS	5111			BPR7HIX	5944	0.5
	Raptor	00→	CR8E	1275			CR8EIX	4218	0.7
	V Raptor	00→	CR8E	1275			CR8EIX	4218	0.7
750	Elefant 750	87→	DPR8EA-9	4929			DPR8EIX-9	2202	0.6
	Indiana 750		BP7HS	5111			BPR7HIX	5944	0.5
900	900GT	91→	DR9EA	3437			DR9EIX	4772	0.5
	900 i.e.	91→	DR9EA	3437			DR9EIX	4772	0.5
	Elefant 900	91→	DPR8EA-9	4929			DPR8EIX-9	2202	0.9
	Gran Canyon	99→	DCPR8E*	4179			DCPR8EIX	6546	0.6
1000	Navigator/T	00→	CR8EK	3478			CR8EIX	4218	0.7
	Raptor	00→	CR8EK	3478			CR8EIX	4218	0.7
	V Raptor	00→	CR8EK	3478			CR8EIX	4218	0.7
	Xtra Raptor	02→	CR8EK	3478			CR8EIX	4218	0.7

CAN-AM (BRP)									
998	Spyder RS	08→12	DCPR9E	2641			DCPR9EIX	2316	0.7
	Spyder RS Ø12mm Plug	13→					KR8BI	4347	0.7
	Spyder RT Ø12mm Plug	10→11	DCPR9E	2641			DCPR9EIX	2316	0.7
	Spyder RT Ø12mm Plug	12→13					KR8BI	4347	0.7
	Spyder ST Ø12mm Plug	13→					KR8BI	4347	0.7



* Please note DCPR8E 4339 has a removable terminal nut, whereas DCPR8E 4179 has a fixed terminal nut





CC	MODEL	DATE	STANDARD COPPER CORE	STOCK NUMBER	PLATINUM OR GOLD PALLADIUM	STOCK NUMBER	IRIDIUM	STOCK NUMBER	GAP MM
CAN-AM (BRP) (CONTINUED)									
1330	Spyder RT Ø10mm Plug	14→					MR7BI-8	90982	0.8
	Spyder F3	15→					MR7BI-8	90982	0.8

CCM (ARMSTRONG-CCM)									
125	CMX 125 L/C	83→85	B9EG	3530	B9EGV	5827	BR9EIX	3981	0.5
	Moto-X Hiro 125	79→80	B10EG	3630	B10EGV	5927	BR10EIX	6801	0.5
240	Trials CMT 240		BP5ES	6511			BPR5EIX	6597	0.5
250	CMT 250 Trials		BP5ES	6511			BPR5EIX	6597	0.5
	CMX 250 1982	1982	B8EG	3430	B8EGV	5627	BR8EIX	5044	0.5
	CMX 250, 250 L/C	83→85	B9EG	3530	B9EGV	5827	BR9EIX	3981	0.5
	Moto-X Hiro 250	79→81	B9EG	3530	B9EGV	5827	BR9EIX	3981	0.5
310	CMT 310 Trials		BP5ES	6511			BPR5EIX	6597	0.5
320	CMT 320 Trials		BP5ES	6511			BPR5EIX	6597	0.5
350	350 Trials	1978	B6ES	7310					0.5
	CMT 350 Trials		BP5ES	6511			BPR5EIX	6597	0.5
400	404E/DS	03→	CR8E	1275			CR8EIX	4218	0.7
	404XC-Trail		CR8E	1275			CR8EIX	4218	0.7
	FT35	05→	CR8E	1275			CR8EIX	4218	0.7
	R35	06→	CR8E	1275			CR8EIX	4218	0.7
	SR40	07→	CR8E	1275			CR8EIX	4218	0.7
434	R35 Factory Big Bore Conversion	06→	CR8E	1275			CR8EIX	4218	0.7
450	CMX 450	82→	B8EG	3430	B8EGV	5627	BR8EIX	5044	0.5
490	CMX 490		B8EG	3430	B8EGV	5627	BR8EIX	5044	0.5
500	CMX 500 (4-Stroke)		D8EA	2120	DR8EVX	6354	DR8EIX	6681	0.5
	Moto-X (4-Stroke) 2 valve models	72→79	B8EG	3430	B8EGV	5627	BR8EIX	5044	0.5
	Moto-X (4-Stroke) 4 valve models	79→81					CR8EIX	4218	0.5
	MTT 500		D8EA	2120	DR8EVX	6354	DR8EIX	6681	0.5
560	CCM 560		D8EA	2120	DR8EVX	6354	DR8EIX	6681	0.5
	CMX 560 (4-Stroke)		D8EA	2120	DR8EVX	6354	DR8EIX	6681	0.5
600	604E Sport & Supermoto	98→02	D8EA	2120	DR8EVX	6354	DR8EIX	6681	0.5
	604R / RS / R30	98→02	D8EA	2120	DR8EVX	6354	DR8EIX	6681	0.5
640	640 RS (Rotax engine)	99→00	D8EA	2120	DR8EVX	6354	DR8EIX	6681	0.5
644	644 (Suzuki engine)	02→07	CR10E	6264			CR10EIX	6482	0.7
	R30 (Suzuki engine)	05→07	CR10E	6264			CR10EIX	6482	0.7
710	R30 (Suzuki engine)	05→07	CR10E	6264			CR10EIX	6482	0.7

CF MOTO									
250	V3 Auto 250T-3	07→	DPR8EA-9	4929			DPR8EIX-9	2202	0.9
	V5 Auto 250T-5		DPR8EA-9	4929			DPR8EIX-9	2202	0.9

COSSACK									
350	Jupiter	73→79	BR6HS	3922			BR6HIX	3419	0.6
	Planeta	73→79	BR6HS	3922			BR6HIX	3419	0.6
650	Dnepr, Ural	73→79	BR6HS	3922			BR6HIX	3419	0.6

CPI									
50	Aragon 50	06→	BR7ES	5122			BR7EIX	6664	0.7
	Aragon GP50	06→	BR7ES	5122			BR7EIX	6664	0.7
	Formula R (Euro 1, 12.7mm Thread Reach)	→05	BR7HS	4122			BR7HIX	7067	0.7
	Formula R (Euro 2, 19mm Thread Reach)	06→	BR7ES	5122			BR7EIX	6664	0.7
	GTR 50 (12.7mm Thread Reach)	03→04	BR7HS	4122			BR7HIX	7067	0.7
	GTR 50 (19mm Thread Reach)	05→	BR10EG	3830			BR10EIX	6801	0.6
	GTS 50 (12.7mm Thread Reach)	03→04	BR7HS	4122			BR7HIX	7067	0.7
	GTS 50 (19mm Thread Reach)	05→	BR10EG	3830			BR10EIX	6801	0.6
	Hussar 50, Mars JP50, Baby J 50 (Euro 1)		BR8HSA	5539			BPR8HIX	6742	0.6
	Hussar 50 (Euro 2)	03→	BR7ES	5122			BR7EIX	6664	0.7
	Oliver 50 (Euro 2)	03→	BR7ES	5122			BR7EIX	6664	0.7
	Popcorn 50 (Euro 2)	03→	BR7ES	5122			BR7EIX	6664	0.7
	Supercross 50 (Euro 1, 12.7mm Thread Reach)		BR7HS	4122			BR7HIX	7067	0.7



CC	MODEL	DATE	STANDARD COPPER CORE	STOCK NUMBER	PLATINUM OR GOLD PALLADIUM	STOCK NUMBER	IRIDIUM	STOCK NUMBER	GAP MM
CPI (CONTINUED)									
50	Supercross 50 (Euro 2, 19mm Thread Reach)	03→05	BR7ES	5122			BR7EIX	6664	0.7
	Supercross 50 SX	06→07	BR7ES	5122			BR7EIX	6664	0.7
	Supermoto 50 (Euro 1, 12.7mm Thread Reach)		BR7HS	4122			BR7HIX	7067	0.7
	Supermoto 50 (Euro 2, 19mm Thread Reach)	03→	BR7ES	5122			BR7EIX	6664	0.7
125	GTS 125	02→03	BR7HS	4122			BR7HIX	7067	0.7
	Hussar JU 125	04→	CR7HSA	4549			CR7HIX	7544	0.6
	Oliver City 125	06→	CR7HSA	4549			CR7HIX	7544	0.6
	QT4A ARN 125		CR7HSA	4549			CR7HIX	7544	0.6
	X-Large 125		BR7HS	4122			BR7HIX	7067	0.7
150	GTS 150		BR7HS	4122			BR7HIX	7067	0.7
	X-Large 150		BR7HS	4122			BR7HIX	7067	0.7
200	GTS 200		BR7HS	4122			BR7HIX	7067	0.7
	X-Large 200		BR7HS	4122			BR7HIX	7067	0.7

DAELIM									
50	Cordi	04→	BPR6HS	7022			BPR6HIX	4085	0.6
	E Five	03→	B8HS	5510			BR8HIX	7001	0.7
	Message 49	98→	BR8HSA	5539			BPR8HIX	6742	0.7
	S Five	02→	B8HS	5510			BR8HIX	7001	0.7
100	Delfino 100	99→	BR8HS	4322			BR8HIX	7001	0.7
110	Citi Ace 110	03→	C7HSA	4629			CR7HIX	7544	0.7
125	Altino NF125ES	03→	CR8EH-9	5666			CR8EHIX-9	3797	0.9
	History 125	04→	CR8EH-9	5666			CR8EHIX-9	3797	0.9
	NS125 Trans Eagle	98→	CR8EH-9	5666			CR8EHIX-9	3797	0.9
	Roadwin (Incl. R)	04→	CR8EH-9	5666			CR8EHIX-9	3797	0.9
	VEE125		CR8EH-9	5666			CR8EHIX-9	3797	0.9
	VL125 Daystar		CR8EH-9	5666			CR8EHIX-9	3797	0.9
	VS125	97→	CR8EH-9	5666			CR8EHIX-9	3797	0.9
250	Roadsport	12→	CR9EH-9	7502			CR9EHIX-9	6216	0.9
	VJF250 (Roadwin)	12→	CR9EH-9	7502			CR9EHIX-9	6216	0.9

DERBI									
50	Atlantis 50 (4-Stroke)	04→	CR8EB	7784			CR8EIX	4218	0.7
	Atlantis 50 (Air Cooled, 12.7mm Thread Reach)	99→02	B8HS	5510			BR8HIX	7001	0.5
	Atlantis 50 (Air Cooled, 19mm Thread Reach)	03→	BR9ES	5722			BR9EIX	3981	0.6
	Atlantis 50 (Liquid Cooled)	00→	BR9ES	5722			BR9EIX	3981	0.6
	Black Devil	03→	B8ES	2411			BR8EIX	5044	0.6
	Black Edition	03→	B8ES	2411			BR8EIX	5044	0.6
	Black Mini	03→	CR9E	6263			CR9EIX	3521	0.6
	Dirt Boy, Dirt Kid	03→	CR9E	6263			CR9EIX	3521	0.6
	DRD 50 Supermoto	02→	B8ES	2411			BR8EIX	5044	0.5
	GP1	03→	BR10ES	4832			BR10EIX	6801	0.7
	GPR 50-R	97→	B8ES	2411			BR8EIX	5044	0.5
	GPR 50 (Standard power)	02→09	B8ES	2411			BR8EIX	5044	0.5
	GPR 50 (Full power)	02→	B9ES	2611			BR9EIX	3981	0.6
	GPR 50	10→	BR8ES	5422			BR8EIX	5044	0.6
	Hunter	96→98	B8HS	5510			BR8HIX	7001	0.5
	Predator LC	98→	B8ES	2411			BR8EIX	5044	0.5
	Senda 50 / R / SM (Standard power)	95→	B8ES	2411			BR8EIX	5044	0.5
	Senda 50 / R / SM (Full power)	95→	B9ES	2611			BR9EIX	3981	0.6
	Sonar 50 2T	09→	BR8ES	5422			BR8EIX	5044	0.6
	Vamos	95→97	B8HS	5510			BR8HIX	7001	0.5
85	Atlantis 100	00→	BR9ES	5722			BR9EIX	3981	0.7
	Senda 100	97→	B9ES	2611			BR9EIX	3981	0.6
125	Boulevard 125 4T	03→	CPR8E	7411			CR8EIX	4218	0.6
	Cross City 125	07→	D8EA	2120	DR8EVX	6354	DR8EIX	6681	0.8
	GP1 125	06→	CR9EB	6955			CR9EIX	3521	0.6
	GPR 125 (Yamaha engine)	04→09	BR8ES	5422			BR8EIX	5044	0.7
	GPR 125	10→	CR8EB	7784			CR8EIX	4218	0.7
	HDR Cabriolet 125	00→	CR7E	4578			CR7EIX	7385	0.5
	Mulhacén Café 125	07→	CR8EB	7784			CR8EIX	4218	0.7
Rambla 125	08→	CR8EB	7784			CR8EIX	4218	0.7	



CC	MODEL	DATE	STANDARD COPPER CORE	STOCK NUMBER	PLATINUM OR GOLD PALLADIUM	STOCK NUMBER	IRIDIUM	STOCK NUMBER	GAP MM
DERBI (CONTINUED)									
125	Senda 125 4T (Honda engine)	03→	DPR8EA-9	4929			DPR8EIX-9	2202	0.7
	Senda Baja R 125	07→	D8EA	2120	DR8EVX	6354	DR8EIX	6681	0.8
	Sonar 125 (4-Stroke)	09→11	CR7EB	4663			CR7EIX	7385	0.6
	Terra 125	07→09	CR8EB	7784			CR8EIX	4218	0.7
150	Boulevard 150 4T	03→	CPR8E	7411			CR8EIX	4218	0.6
250	GP1 250	06→	CR9EB	6955			CR9EIX	3521	0.6
	Rambla 250	08→09	CR9EB	6955			CR9EIX	3521	0.6
300	Rambla 300i	10→	CR8EKB	4374			CR8EIX	4218	0.7
660	Mulhacen 659 / Café	06→	CR7E	4578			CR7EIX	7385	0.5

DUCATI									
250	250 Desmo, Monza, Sebring		B6HS	4510			BR6HIX	3419	0.5
350	350 Desmo, Sebring		B6HS	4510			BR6HIX	3419	0.5
	350 Sport	91→	BP7HS	5111			BPR7HIX	5944	0.6
399	Scrambler Sixty2	16→	KR8C-G	97516					0.7
400	400 SS, Junior	91→94	BP7HS	5111			BPR7HIX	5944	0.6
450	450 Desmo, Sebring		B6HS	4510			BR6HIX	3419	0.5
500	500 Desmo	78→83	B6HS	4510			BR6HIX	3419	0.5
	500 Pantah	80→84	BP7HS	5111			BPR7HIX	5944	0.6
600	600 Monster, Monster S, Monster Dark	94→01	DCPR8E*	4339			DCR8EIX	3606	0.7
	600 Pantah	80→85	BP7HS	5111			BPR7HIX	5944	0.6
	600 SS	→94	DCPR8E*	4339			DCR8EIX	3606	0.7
	600 SS	94→98	DCPR8E*	4339			DCR8EIX	3606	0.7
620	620 i.e., S i.e. & i.e. Dark	02→06	DCPR8E*	4339			DCR8EIX	3606	0.7
	Multistrada 620	04→06	DCPR8E*	4339			DCR8EIX	3606	0.7
650	Indiana 650	86→88	BP7HS	5111			BPR7HIX	5944	0.6
695	Monster 695	06→08	DCPR8E*	4339			DCR8EIX	3606	0.7
696	Monster 696	08→14	DCPR8E*	4339			DCR8EIX	3606	0.7
748	748, 748 Biposto	95→04					DCR9EIX	6650	0.6
	Dark	04→06	CR9EB	6955			CR9EIX	3521	0.6
	748 R	00→04	R2349-10	6839					0.6
	748 S	00→04					DCR9EIX	6650	0.6
	748 SP	95→98	R2349-10	6839					0.6
	748 SPS	98→00	R2349-10	6839					0.6
	749 (‡ Socket Ø <20.5mm)	02→06	CR9EB	6955			CR9EIX	3521	0.6
	749, R, S (‡ Socket Ø <20.5mm)	03→06	CR9EB	6955			CR9EIX	3521	0.6
	750 Sport	00→02	DCPR8E*	4339			DCR8EIX	3606	0.7
750	750 F1	86→88	BP7HS	5111			BPR7HIX	5944	0.6
	750 F1	89→	DCPR8E*	4339			DCR8EIX	3606	0.7
	750 GT		B7HS	5110			BR7HIX	7067	0.5
	750 Monster	96→02	DCPR8E*	4339			DCR8EIX	3606	0.7
	750 Montjuich		BP7HS	5111			BPR7HIX	5944	0.6
	750 Paso	86→90	DCPR8E*	4339			DCR8EIX	3606	0.7
	750 SS	→90	B7HS	5110			BR7HIX	7067	0.5
	750 SS	91→01	DCPR8E*	4339			DCR8EIX	3606	0.7
	750 SS i.e.	98→02	DCPR8E*	4339			DCR8EIX	3606	0.7
803	800 Sport	03→04	DCPR8E*	4339			DCR8EIX	3606	0.7
	800 i.e. Monster	03→05	DCPR8E*	4339			DCR8EIX	3606	0.7
	Hypermotard 796 (Twin Spark)	10→12	DCPR8E*	4339			DCR8EIX	3606	0.7
	Monster 796	10→14	DCPR8E*	4339			DCR8EIX	3606	0.7
	S2R 800	05→08	DCPR8E*	4339			DCR8EIX	3606	0.7
	Scrambler Classic, Full Throttle, Icon, Urban Enduro	15→	DCPR8E*	4339			DCR8EIX	3606	0.7
	Scrambler Flat Track Pro	16→	DCPR8E*	4339			DCR8EIX	3606	0.7
	SS 800	03→04	DCPR8E*	4339			DCR8EIX	3606	0.7
821	Hypermotard	13→15	MAR9A-J	6869					0.8
	Hyperstrada	13→15	MAR9A-J	6869					0.8

‡ Early Ducati Testastretta bikes (749, 998, 999 models) can have very little clearance between the plug hex and the cylinder head that may require a thin walled socket, no larger than 20.5mm OD to allow the plug to be fitted.



* Please note DCPR8E 4339 has a removable terminal nut, whereas DCPR8E 4179 has a fixed terminal nut





CC	MODEL	DATE	STANDARD COPPER CORE	STOCK NUMBER	PLATINUM OR GOLD PALLADIUM	STOCK NUMBER	IRIDIUM	STOCK NUMBER	GAP MM
DUCATI (CONTINUED)									
821	Monster 821, Monster 821 Dark	14→	MAR9A-J	6869					0.8
	Monster 821 Stripe	15→	MAR9A-J	6869					0.8
849	848	08→13	MAR10A-J	4706					0.8
	848 Evo, Evo Dark Stealth, Corse SE	07/10→13	MAR10A-J	4706					0.8
	Streetfighter 848	11/11→15	MAR10A-J	4706					0.8
851	851						DR9EIX	4772	0.6
	851 Strada	89→92					DR9EIX	4772	0.6
860	860 GT, GTS		B5HS	4210					0.6
888	851 SP (Sport Production)	90→92					DR9EIX	4772	0.6
	888 SP (Sport Production)	92→94					DCR9EIX	6650	0.8
	888 Strada	→93					DR9EIX	4772	0.6
	888 Strada	94→	DR9EA	3437			DR9EIX	4772	0.6
898	899 Panigale	13→15	MAR9A-J	6869					0.8
900	900 Darmah SS, SD		B6HS	4510			BR6HIX	3419	0.5
	900 i.e. Monster, Monster Dark	99→02	DCPR8E*	4339			DCR8EIX	3606	0.9
	900 Injection		DCPR8E*	4339			DCR8EIX	3606	0.9
	900 Monster, Monster S	97→	DCPR8E*	4339			DCR8EIX	3606	0.9
	900 SS, SSD, S2, Hailwood Replica	79→	B7HS	5110			BR7HIX	7067	0.6
	900 SS	91→	DCPR8E*	4339			DCR8EIX	3606	0.9
	900 Superlight	92→	DCPR8E*	4339			DCR8EIX	3606	0.9
	900 Supersport, FE	97→02	DCPR8E*	4339			DCR8EIX	3606	0.9
	906 Paso	88→94	DCPR8E*	4339			DCR8EIX	3606	0.9
	907 I.E.	91→	DCPR8E*	4339			DCR8EIX	3606	0.9
916	916 (All models except SP)	94→01					DCR9EIX	6650	0.8
	916 SP	94→	R2349-10	6839					0.6
	S4 Monster	01→02					DCR9EIX	6650	0.8
	ST4	98→03					DCR9EIX	6650	0.7
937	Hypermotard 939, 939 SP	16→	MAR9A-J	6869					0.8
	Hyperstrada 939	16→	MAR9A-J	6869					0.8
	Supersport, S	17→	MAR9A-J	6869					0.8
944	ST2	97→03	DCPR8E*	4339			DCR8EIX	3606	0.9
955	959 Panigale, R	16→	MAR9A-J	6869					0.8
989	Desmosedici RR	07→08	MAR10A-J	4706					0.8
992	GT1000 (Twin Spark)	06→10	DCPR8E*	4339			DCR8EIX	3606	0.9
	Monster 1000 i.e. (Twin Spark)	03→05	DCPR8E*	4339			DCR8EIX	3606	0.9
	Multistrada 1000DS, MTS 1000DS (Twin Spark)	03→06	DCPR8E*	4339			DCR8EIX	3606	0.9
	Paul Smart 1000 Limited Edition (Twin Spark)	05→06	DCPR8E*	4339			DCR8EIX	3606	0.9
	Monster S2R, Dark 1000 (Twin Spark)	10/05→07	DCPR8E*	4339			DCR8EIX	3606	0.9
	Sport 1000 (Twin Spark)	05→09	DCPR8E*	4339			DCR8EIX	3606	0.9
	SS 1000 DS (Twin Spark)	03→06	DCPR8E*	4339			DCR8EIX	3606	0.9
	ST3, S (Twin Spark)	03→07	CR9EB	6955			CR9EIX	3521	0.6
996	916 SPS Fogarty Replica	1998	R2349-10	6839					0.6
	996 B/S, Biposto	98→01					DCR9EIX	6650	0.8
	996 S	00→02					DCR9EIX	6650	0.8
	996 SPS	97→02	R2349-10	6839					0.6
	S4R Monster	03→06					DCR9EIX	6650	0.8
	ST4S	00→05					DCR9EIX	6650	0.8
998	996 R (‡ Socket Ø <20.5mm)	00→02	CR9EB	6955			CR9EIX	3521	0.6
	998 Biposto, R, S (‡ Socket Ø <20.5mm)	01→03	CR9EB	6955			CR9EIX	3521	0.6
	998 Matrix (‡ Socket Ø <20.5mm)	2003	CR9EB	6955			CR9EIX	3521	0.6
	999, R, S (‡ Socket Ø <20.5mm)	02→06	CR9EB	6955			CR9EIX	3521	0.6
	S4RS Monster (‡ Socket Ø <20.5mm)	06→08	CR9EB	6955			CR9EIX	3521	0.6
	S4R Monster (‡ Socket Ø <20.5mm)	07→08	CR9EB	6955			CR9EIX	3521	0.6
1078	Hypermotard, S, Evo, Evo SP	07→12	DCPR8E*	4339			DCR8EIX	3606	0.9
	Monster 1100, S, Evo, Diesel	09→13	DCPR8E*	4339			DCR8EIX	3606	0.9
	Multistrada 1100, S	06→09	DCPR8E*	4339			DCR8EIX	3606	0.9
1098	1098, 1098S / Tricolore	07→08	MAR10A-J	4706					0.8
	Streetfighter S	09→13	MAR10A-J	4706					0.8

‡ Early Ducati Testastretta bikes (749, 998, 999 models) can have very little clearance between the plug hex and the cylinder head that may require a thin walled socket, no larger than 20.5mm OD to allow the plug to be fitted.



* Please note DCPR8E 4339 has a removable terminal nut, whereas DCPR8E 4179 has a fixed terminal nut





CC	MODEL	DATE	STANDARD COPPER CORE	STOCK NUMBER	PLATINUM OR GOLD PALLADIUM	STOCK NUMBER	IRIDIUM	STOCK NUMBER	GAP MM
DUCATI (CONTINUED)									
1198	1098R (Incl. Bayliss LE)	2008	MAR10A-J	4706					0.8
	1198 R Corse	2010	MAR10A-J	4706					0.8
	1198, S, SP	09→11	MAR10A-J	4706					0.8
	1199 Panigale, R, S, S Tricolore (Incl. Senna)	12→14	MAR9A-J	6869					0.8
	Diavel (Incl. AMG, Carbon, Cromo & Diesel)	11→	MAR9A-J	6869					0.8
	Monster 1200, S, Stripe	14→	MAR9A-J	6869					0.8
	Monster 1200 R (Twin Spark)	16→	MAR9A-J	6869					0.8
	Multistrada 1200, S (Incl. Pikes Peak, Sport & Touring)	10→12	MAR9A-J	6869					0.8
	Multistrada 1200, S (Incl. Pikes Peak, Sport & Touring) Twin Spark	13→14	MAR10A-J	4706					0.8
	Multistrada 1200, D Air, S (Twin Spark)	15→	MAR9A-J	6869					0.8
	Multistrada 1200 Enduro, Pikes Peak, Pro (Twin Spark)	16→	MAR9A-J	6869					0.8
1199 Superleggera	2014	MAR9A-J	6869					0.8	
1262	XDiavel, S	16→	MAR9A-J	6869					0.8
1285	1299 Panigale, R, S (Incl. Anniversario)	15→	MAR9A-J	6869					0.8

EBR									
1190	1190RX	04/14→	CR9EKB	2305			CR9EIX	3521	0.8
	1190SX	07/14→	CR9EKB	2305			CR9EIX	3521	0.8

FANTIC									
50	Caballero 50	06→	BR9ES	5722			BR9EIX	3981	0.7
	Gran Turismo, Lei 50, Issimo (all models)		B6HS	4510			BR6HIX	3419	0.5
	Trial 50		B7HS	5110			BR7HIX	7067	0.5
80	Caballero 80		B8EG	3430	B8EGV	5627	BR8EIX	5044	0.5
	Enduro 80		B8EG	3430	B8EGV	5627	BR8EIX	5044	0.5
	RSX 80		B8EG	3430	B8EGV	5627	BR8EIX	5044	0.5
	Section	95→97	BCP7ES	5030			BCPR7EIX	5690	0.5
125	Caballero 125		B9EG	3530	B9EGV	5827	BR9EIX	3981	0.5
	Cross 125		B9EG	3530	B9EGV	5827	BR9EIX	3981	0.5
	Professional 125		B6HS	4510			BR6HIX	3419	0.5
	RSX 125		B9EG	3530	B9EGV	5827	BR9EIX	3981	0.5
	Trial 125		B6HS	4510			BR6HIX	3419	0.5
160	TX160		B8EG	3430	B8EGV	5627	BR8EIX	5044	0.5
175	Enduro 175		B8EG	3430	B8EGV	5627	BR8EIX	5044	0.5
200	Trial 200		B6HS	4510			BR6HIX	3419	0.5
240	Trial 240		B6HS	4510			BR6HIX	3419	0.5
250	K Roo	91→94	BL-6H	6921					0.5
	Section	95→97	BCP7ES	5030			BCPR7EIX	5690	0.5
	TX250		B8EG	3430	B8EGV	5627	BR8EIX	5044	0.5
260	TX260		B8EG	3430	B8EGV	5627	BR8EIX	5044	0.5
300	Professional 300		B8EG	3430	B8EGV	5627	BR8EIX	5044	0.5
330	TX330		B8EG	3430	B8EGV	5627	BR8EIX	5044	0.5

GAS GAS									
50	Contact, Endurocross		B8HS	5510			BR8HIX	7001	0.5
	EC 50 Boy (12.7mm Thread Reach)		B8HS	5510			BR8HIX	7001	0.5
	EC Boy, Rookie 50 (19mm Thread Reach)	04→	B9ES	2611			BR9EIX	3981	0.6
	SM 50 Supermotard	04→	B9ES	2611			BR9EIX	3981	0.6
	TXT Boy	06→	BPR5ES	7422			BPR5EIX	6597	0.5
65	MC65	06→	BR10ES	4832			BR10EIX	6801	0.7
75	Husqvarna (TM)		B10EG	3630	B10EGV	5927	BR10EIX	6801	0.5
80	TXT 80	06→07	BPR5ES	7422			BPR5EIX	6597	0.5
	TXT PRO Racing	15→	BPR5ES	7422			BPR5EIX	6597	0.5
125	Contact T12	1993	BP5ES	6511			BPR5EIX	6597	0.5
	EC 125 Endurocross	97→	B9EG	3530	B9EGV	5827	BR9EIX	3981	0.7
	EC 125 Racing, EC 125 SIX	10→	BR9EG	3230			BR9EIX	3981	0.7
	Enduro 125	02→	BR8EG	3130			BR8EIX	5044	0.5
	Endurocross TT125, Cross TT125	→00			B10EGV	5927	BR10EIX	6801	0.5
	GT12 (Liquid Cooled)	1993	BP5ES	6511			BPR5EIX	6597	0.5
	Halley 125	2009	BR9ES	5722			BR9EIX	3981	0.7



CC	MODEL	DATE	STANDARD COPPER CORE	STOCK NUMBER	PLATINUM OR GOLD PALLADIUM	STOCK NUMBER	IRIDIUM	STOCK NUMBER	GAP MM
GAS GAS (CONTINUED)									
125	Husqvarna (TM)		B10EG	3630	B10EGV	5927	BR10EIX	6801	0.5
	Pampera 125	02→05	BPR5ES	7422			BPR5EIX	6597	0.5
	SM 125 Supermotard	03→07	BR9EG	3230			BR9EIX	3981	0.7
	Trial 125	→91	BP5ES	6511			BPR5EIX	6597	0.5
	TX, TXT 125 Ø14mm Plug	99→	BPR5ES	7422			BPR5EIX	6597	0.5
	TX Randonne Ø10mm Plug	11→	CR6HSA	2983			CR6HIX	7274	0.6
	TXT Pro, Racing	11→	BPR5ES	7422			BPR5EIX	6597	0.6
143	Contact T16	1993	BP5ES	6511			BPR5EIX	6597	0.5
160	GT16 (Liquid Cooled)	1993	BP5ES	6511			BPR5EIX	6597	0.5
200	EC 200 Endurocross	99→			B10EGV	5927	BR10EIX	6801	0.6
	EC 200 Endurocross (2002 models)	02→	BR8EG	3130			BR8EIX	5044	0.5
	EC 200 Racing	11→	BR8EG	3130			BR8EIX	5044	0.7
	Trial 200	→91	BP5ES	6511			BPR5EIX	6597	0.5
	TX, TXT 200	99→	BPR5ES	7422			BPR5EIX	6597	0.5
238	Contact JT25	94→95	BP5ES	6511			BPR5EIX	6597	0.5
249	TX, TXT 249	99→	BPR5ES	7422			BPR5EIX	6597	0.5
250	Contact 250	15→	BPR5ES	7422			BPR5EIX	6597	0.6
	Delta 25 GT	→91	BP5ES	6511			BPR5EIX	6597	0.5
	EC 250 Endurocross	1997	B8EG	3430	B8EGV	5627	BR8EIX	5044	0.5
	EC 250 Racing, EC 250 SIX (Incl. Replica) (2-Stroke)	10→	BR8EG	3130			BR8EIX	5044	0.7
	ECF250 4T, ECF250 SIX (4-Stroke)	10→11	CR8E	1275			CR8EIX	4218	0.7
	ECF250 4T, ECF250 SIX (4-Stroke)	12→	CR9E	6263			CR9EIX	3521	0.6
	Enduro 250	02→	BR8EG	3130			BR8EIX	5044	0.5
	Endurocross 250	→00			B10EGV	5927	BR10EIX	6801	0.5
	Husqvarna (TM)		B10EG	3630	B10EGV	5927	BR10EIX	6801	0.5
	Pampera 250	02→05	BPR5ES	7422			BPR5EIX	6597	0.5
	Supermotard SM 250	03→05	BR8EG	3130			BR8EIX	5044	0.5
	Trial 250 (Air & Liquid Cooled models)	→91	BP5ES	6511			BPR5EIX	6597	0.5
	TXT Pro, Raga Replica	03→	BPR5ES	7422			BPR5EIX	6597	0.6
270	TX, TXT 270	98→	BPR5ES	7422			BPR5EIX	6597	0.5
280	Pampera 280	02→05	BPR5ES	7422			BPR5EIX	6597	0.5
	Trial 280	→91	BP5ES	6511			BPR5EIX	6597	0.5
	TX, TXT 280	00→	BPR5ES	7422			BPR5EIX	6597	0.5
	TXT Pro, Racing, Raga Replica	11→	BPR5ES	7422			BPR5EIX	6597	0.6
300	EC 300 Endurocross	03→09			B10EGV	5927	BR10EIX	6801	0.6
	EC 300 F (4-Stroke)	13→	CR9E	6263			CR9EIX	3521	0.6
	EC 300 Racing, EC 300 SIX (Incl. Replica) (2-Stroke)	10→	BR8EG	3130			BR8EIX	5044	0.7
	Enduro 300	02→	BR8EG	3130			BR8EIX	5044	0.5
	Trial 300	→91	BP5ES	6511			BPR5EIX	6597	0.5
	TXT 300	04→	BPR5ES	7422			BPR5EIX	6597	0.5
	TXT Pro, Racing, Raga Replica	11→	BPR5ES	7422			BPR5EIX	6597	0.6
321	TX, TXT 321	99→	BP5ES	6511			BPR5EIX	6597	0.5
325	Trial Halley PXC 325	→91	B9ES	2611			BR9EIX	3981	0.5
327	Trial 327	→91	BP5ES	6511			BPR5EIX	6597	0.5
330	Delta 32 GT	→91	BP5ES	6511			BPR5EIX	6597	0.5
400	Pampera 400	06→	CR8E	1275			CR8EIX	4218	0.7
	SM 400FSE-4T	02→	CR8E	1275			CR8EIX	4218	0.7
450	EC 450 (4-Stroke)	08→10	CR8E	1275			CR8EIX	4218	0.7
	EC 450 F (4-Stroke)	13→	CR8E	1275			CR8EIX	4218	0.7
	FSE 450	03→	CR8E	1275			CR8EIX	4218	0.7
	Halley 450 R	08→	CR8E	1275			CR8EIX	4218	0.7
	SM 450	04→	CR8E	1275			CR8EIX	4218	0.7
	SM Halley 450	2009	CR8E	1275			CR8EIX	4218	0.7
492	EC 515 FSR	08→10	CR8E	1275			CR8EIX	4218	0.7
	SM 515	08→10	CR8E	1275			CR8EIX	4218	0.7
500	Normada 500		D8EA	2120	DR8EVX	6354	DR8EIX	6681	0.5



CC	MODEL	DATE	STANDARD COPPER CORE	STOCK NUMBER	PLATINUM OR GOLD PALLADIUM	STOCK NUMBER	IRIDIUM	STOCK NUMBER	GAP MM
GENERIC									
50	Cracker 50 (19mm Thread Reach)	07→11	BR7ES	5122			BR7EIX	6664	0.7
	Cracker SM 50 (12.7mm Thread Reach)	11→12	BR8HSA	5539			BPR8HIX	6742	0.7
	Epico 50	11→12	BR8HSA	5539			BPR8HIX	6742	0.7
	Evolution 50 (19mm Thread Reach)	07→11	BR7ES	5122			BR7EIX	6664	0.7
	Evolution 50 (12.7mm Thread Reach)	11→12	BR8HSA	5539			BPR8HIX	6742	0.7
	Ideo 50 (19mm Thread Reach)	07→11	BR7ES	5122			BR7EIX	6664	0.7
	Ideo 50 (12.7mm Thread Reach)	11→12	BR8HSA	5539			BPR8HIX	6742	0.7
	Race 50 (19mm Thread Reach)	→11	BR7ES	5122			BR7EIX	6664	0.7
	Race 50 (12.7mm Thread Reach)	11→12	BR8HSA	5539			BPR8HIX	6742	0.7
	ROC 50 (19mm Thread Reach)	→11	BR7ES	5122			BR7EIX	6664	0.7
	Trigger SM 50 (19mm Thread Reach)	07→11	BR7ES	5122			BR7EIX	6664	0.7
	Trigger SM 50 (12.7mm Thread Reach)	11→12	BR8HSA	5539			BPR8HIX	6742	0.7
	Trigger SM Competition (Restricted)	→11	BR7ES	5122			BR7EIX	6664	0.7
	Trigger SM Competition (Unrestricted)	→11	BR9ES	5722			BR9EIX	3981	0.7
	Trigger X 50 (19mm Thread Reach)	07→11	BR7ES	5122			BR7EIX	6664	0.7
	Trigger X 50 (12.7mm Thread Reach)	11→12	BR8HSA	5539			BPR8HIX	6742	0.7
	Trigger X Competition (Restricted)	→11	BR7ES	5122			BR7EIX	6664	0.7
	Trigger X Competition (Unrestricted)	→11	BR9ES	5722			BR9EIX	3981	0.7
	XOR 50 (19mm Thread Reach)	07→11	BR7ES	5122			BR7EIX	6664	0.7
	XOR 50 (12.7mm Thread Reach)	11→12	BR8HSA	5539			BPR8HIX	6742	0.7
XOR 50 Competition (19mm Thread Reach)	07→11	BR7ES	5122			BR7EIX	6664	0.7	
XOR Stroke 50 (2-Stroke)	07→11	BR7ES	5122			BR7EIX	6664	0.7	
XOR 50 Williams (19mm Thread Reach)	→11	BR7ES	5122			BR7EIX	6664	0.7	
125	Soho 125	09→11	CR8E	1275			CR8EIX	4218	0.7
	XOR 125	07→11	CR7HSA	4549			CR7HIX	7544	0.7
	XOR 125 Williams	08→11	CR7HSA	4549			CR7HIX	7544	0.7

GILERA									
50	DNA 50 (2-Stroke catalyst)	00→	BR9ES	5722			BR9EIX	3981	0.7
	DNA 50 GP	02→	BR9ES	5722			BR9EIX	3981	0.6
	GSM 50 (Gilera 2-Stroke)	00→	BR9ES	5722			BR9EIX	3981	0.7
	H@K 50 (Gilera 2-Stroke)	00→	BR9ES	5722			BR9EIX	3981	0.7
	ICE 50 (Gilera 2-Stroke)	01→	BR9ES	5722			BR9EIX	3981	0.7
	Jetrunner	03→	CPR8E	7411			CR8EIX	4218	0.8
	Pure Jet 50 Direct Injection (2-Stroke)	04→	CPR8E	7411			CR8EIX	4218	0.8
	RCR 50 (2-Stroke Derbi engine)	04→	BR9ES	5722			BR9EIX	3981	0.5
	Runner 50 (2-Stroke)	97→02	BR9ES	5722			BR9EIX	3981	0.6
	Runner 50 (4-Stroke)	04→	CPR8E	7411			CR8EIX	4218	0.8
	SKP 50	97→	BR9ES	5722			BR9EIX	3981	0.5
	SMT 50	05→	BR9ES	5722			BR9EIX	3981	0.6
	Stalker 50	03→	BR9ES	5722			BR9EIX	3981	0.5
	Storm 50	09/07→	BR9ES	5722			BR9EIX	3981	0.6
	125	125T G1,125GR1		B8ES	2411			BR8EIX	5044
Cougar 125		00→03	DPR8EA-9	4929			DPR8EIX-9	2202	0.8
Crono			B10EG	3630	B10EGV	5927	BR10EIX	6801	0.6
CX 125 Apache			B10EG	3630	B10EGV	5927	BR10EIX	6801	0.6
DNA 125 (4-Stroke)		01→	CR9EB	6955			CR9EIX	3521	0.7
Freestyle (2-Stroke)			B10EG	3630	B10EGV	5927	BR10EIX	6801	0.6
GFR125					B10EGV	5927	BR10EIX	6801	0.6
Nexus 125		07→	CR8EB	7784			CR8EIX	4218	0.7
Runner ST 125 (4-Stroke)		09→	CR9E	6263			CR9EIX	3521	0.6
Runner FX125 (2-Stroke)		97→01	BR9ES	5722			BR9EIX	3981	0.6
Runner VX 125 (4-Stroke)		01→08	CR9EB	6955			CR9EIX	3521	0.7
RV 125		86→90	B10EG	3630	B10EGV	5927	BR10EIX	6801	0.6
SC125 (2-Stroke)		06→	BR8ES	5422			BR8EIX	5044	0.7
SC125 (4-Stroke Yamaha engine)	07→	BR8ES	5422			BR8EIX	5044	0.7	
180	DNA 180 (4-Stroke)	01→	CR9EB	6955			CR9EIX	3521	0.7
	Runner FXR180 (2-Stroke)	98→00	BR9ES	5722			BR9EIX	3981	0.6
	Runner VXR 180 (4-Stroke)	01→08	CR9EB	6955			CR9EIX	3521	0.7
200	Runner ST 200	08→	CPR8E	7411			CR8EIX	4218	0.7
	Runner VXR 200 (4-Stroke)	02→08	CPR8E	7411			CR8EIX	4218	0.7
250	Nexus 250 SP	06→	CR8EB	7784			CR8EIX	4218	0.6

2 Wheel



CC	MODEL	DATE	STANDARD COPPER CORE	STOCK NUMBER	PLATINUM OR GOLD PALLADIUM	STOCK NUMBER	IRIDIUM	STOCK NUMBER	GAP MM
GILERA (CONTINUED)									
300	Nexus 300		CR8EKB	4374			CR8EIX	4218	0.7
350	Dakota 350 (4-Stroke)		DPR8EA-9	4929			DPR8EIX-9	2202	0.6
	Saturno 350 (4-Stroke)	90→	DPR8EA-9	4929			DPR8EIX-9	2202	0.6
460	Nexus 500	04→	CR7EKB	4455			CR7EIX	7385	0.8
500	Dakota 500 (4-Stroke)		DPR8EA-9	4929			DPR8EIX-9	2202	0.6
	Fuoco 500	07→	CR7EKB	4455			CR7EIX	7385	0.8
	Saturno 500 (4-Stroke)	90→93	DPR8EA-9	4929			DPR8EIX-9	2202	0.6
560	Nordwest 600 (4-Stroke)	91→95	DPR9EA-9	5329			DPR9EIX-9	5545	0.6
	RC600 (4-Stroke)		DPR8EA-9	4929			DPR8EIX-9	2202	0.6
600	Supersport 600	02→	CR9E	6263			CR9EIX	3521	0.6
839	GP800 (Twin Spark)	08→	CR7EKB	4455			CR7EIX	7385	0.8

HARLEY DAVIDSON									
883	XL53C, Sportster 883 (All Models)	86→	DCPR7EA-9	6651			DCPR7EIX	6046	0.9
	XL883 Iron	09→	DCPR7EA-9	6651			DCPR7EIX	6046	0.9
1000	XL, XLH, XLCH	→78	B-6L	3212					0.7
	XLCR	→79	B-6L	3212					0.7
	XLH, XLS, XLCH	79→	BP6HS	4511			BPR6HIX	4085	1.0
	XR1000	83→85	BPR6ES-11	4824			BPR6EIX-11	3903	1.0
1100	Sportster 1100	86/87	DCPR7E	3932			DCPR7EIX	6046	1.0
1130	VRSC V-Rod, Night Rod, Street Rod	02→	DCPR8E*	4339			DCR8EIX	3606	0.9
1200	FL, FLH, FX, FXE, Super Glide	48→74	BP5S	3011					0.7
	FLH, FLHR, FX, FXE, FXEF, FXS	75→81	BPR5ES-11	4424			BPR5EIX	6597	1.0
	Forty Eight	10→	DCPR7E	3932			DCPR7EIX	6046	1.0
	Sportster 1200 (All Models)	88→	DCPR7E	3932			DCPR7EIX	6046	1.0
	XL1200	88→	DCPR7E	3932			DCPR7EIX	6046	1.0
	XR1200	08→12	DCPR9E	2641			DCPR9EIX	2316	0.9
1250	V-Rod Anniversary	11→	DCPR9E	2641			DCPR9EIX	2316	0.6
	VRSC Screamin' Eagle V-Rod	04→	DCPR9E	2641			DCPR9EIX	2316	0.6
	VRSCF V-ROD MUSCLE	09→14	DCPR9E	2641			DCPR9EIX	2316	0.6
1340	All Evolution engines	84→98	BPR5ES-11	4424			BPR5EIX	6597	1.0
	All Shovel Head engines	82→84	ZGR5C	6334					1.0
1450	All 1450cc Models	99→	DCPR7E	3932			DCPR7EIX	6046	1.0
	FXDBi	06→	DCPR7E	3932			DCPR7EIX	6046	1.0
1584	Blackline	11→	DCPR8E*	4339			DCR8EIX	3606	0.9
	FLST Fat Boy	08/06→	DCPR8E*	4339			DCR8EIX	3606	0.9
	Twin Cam 96B Models	06/06→	DCPR8E*	4339			DCR8EIX	3606	0.9
	Wide Glide	10→	DCPR8E*	4339			DCR8EIX	3606	0.9
1690	FL1690 Screamin' Eagle Electra Glide	04→	DCPR8E*	4339			DCR8EIX	3606	0.9
	FL1690 Screamin' Eagle, Fat Boy	04→	DCPR8E*	4339			DCR8EIX	3606	0.9
	FXSB	13→	DCPR8E*	4339			DCR8EIX	3606	0.9
	Switchback	11→	DCPR8E*	4339			DCR8EIX	3606	0.9
1800	FLHR Road King	13→	DCPR7E	3932			DCPR7EIX	6046	1.0
	FLHTCUSE Screamin' Eagle, Ultra Classic Electra Glide	06/06→	DCPR7E	3932			DCPR7EIX	6046	1.0

HERALD MOTOR COMPANY									
125	Classic 125	06/12→	CR7E	4578			CR7EIX	7385	0.5
250	Classic 250	06/12→	DR8EA	7162			DR8EIX	6681	0.5
	Nomad 250 custom	04/16→	DR8EA	7162			DR8EIX	6681	0.5
	Rambler 250 custom	04/16→	DR8EA	7162			DR8EIX	6681	0.5
	Roamer 250 custom	04/16→	DR8EA	7162			DR8EIX	6681	0.5
	Vagabond 250 custom	04/16→	DR8EA	7162			DR8EIX	6681	0.5

HERO-PUCH									
50	Blinker, Stark, Turbo Sport	94→	BP5ES	6511			BPR5EIX	6597	0.5

HESKETH									
1000	V1000	82→	DR8ES	5423			DR9EIX	4772	0.7



* Please note DCPR8E 4339 has a removable terminal nut, whereas DCPR8E 4179 has a fixed terminal nut





CC	MODEL	DATE	STANDARD COPPER CORE	STOCK NUMBER	PLATINUM OR GOLD PALLADIUM	STOCK NUMBER	IRIDIUM	STOCK NUMBER	GAP MM
HONDA									
50	C50	66→78	C7HSA	4629			CR7HIX	7544	0.7
	C50C	82→86	CR7HS	7223			CR7HIX	7544	0.7
	C50-E Super Cub	84→85	CR7HS	7223			CR7HIX	7544	0.7
	C50L, C50LA-C, C50LA-E	82→88	CR7HS	7223			CR7HIX	7544	0.7
	C50ZZ, C50ZZ	77→83	CR7HS	7223			CR7HIX	7544	0.7
	CB50J	77→86	CR6HS	7023			CR6HIX	7274	0.7
	CR50R-E/F/G	84→86	BR9ES	5722			BR9EIX	3981	0.7
	CRF50F	04→	CR6HSA	2983			CR6HIX	7274	0.6
	MB50A-B	80→82	BR7HS	4122			BR7HIX	7067	0.7
	MBX50S-D	83→86	BR6ES	4922					0.7
	Melody, Mini Melody, Vision	83→85	BPR6HSA	4632			BPR6HIX	4085	0.7
	MT50A-B, MT50S-L	80→93	BR7HS	4122			BR7HIX	7067	0.7
	MTX50S-C	82→85	BR7HS	4122			BR7HIX	7067	0.7
	NC50 Express	77→84	BPR4HS	7823					0.7
	ND50M-C	83→85	BPR6HSA	4632			BPR6HIX	4085	0.7
	NE50	85→90	BPR6HSA	4632			BPR6HIX	4085	0.7
	NPS50 Zoomer	06→12	ER8EH-N	5606					0.7
	NS50MS	81→85	BPR6HSA	4632			BPR6HIX	4085	0.7
	NSC50 Vision	12→	CR7HSA-9	5147			CR7HIX	7544	0.9
	NSC50R	13→	CR7HSA-9	5147			CR7HIX	7544	0.9
	NT50-H	87→94	BPR6HSA	4632			BPR6HIX	4085	0.7
	NU50M-C	82→85	BPR5HS	6222					0.7
	NV50MS-D	82→87	BPR5HS	6222					0.7
	NX50M	80→83	BPR5HS	6222					0.7
	PA50VC	86→91	BPR6HS	7022			BPR6HIX	4085	0.7
	PC50 (OHC)	→69	C6HSA	3228			CR6HIX	7274	0.6
	PC50K (OHV)	70→79	C7HSA	4629			CR7HIX	7544	0.6
	PF50MR2	75→78	B6HS	4510			BR6HIX	3419	0.7
	PX50	81→86	BPR5HS	6222					0.7
	PXR50	85→87	BPR4HS	7823					0.7
	QR50-D, QR50-F/R	82→03	BPR4HS	7823					0.7
	SA50-J, SA50M/N/P	88→95	BPR6HSA	4632			BPR6HIX	4085	0.7
	SFX50 S, T, V, W, X, Y	95→03	BR6HSA	4296			BPR6HIX	4085	0.6
	SGX50 V, W, X, Y (Sky)	97→03	BR6HSA	4296			BPR6HIX	4085	0.6
	SH50E-S	84→96	BPR6HS	7022			BPR6HIX	4085	0.7
	SH50T-X-Y Bali	96→03	BR6HSA	4296			BPR6HIX	4085	0.6
	SJ50 PR, S, V, W	93→99	BR6HSA	4296			BPR6HIX	4085	0.6
	SRX50 Shadow	2003	BR6HSA	4296			BPR6HIX	4085	0.6
	SS50	67→80	C7HSA	4629			CR7HIX	7544	0.6
	ST50J DAX, ST50J/K	88→93	CR6HSA	2983			CR6HIX	7274	0.7
	SZX-50 (X8R-S, X8R-X)	98→04	BR6HSA	4296			BPR6HIX	4085	0.6
	TLM50	85→86	B8ES	2411			BR8EIX	5044	0.7
	X8R S/X	98→03	BR6HSA	4296			BPR6HIX	4085	0.6
XR50	96→02	CR6HSA	2983			CR6HIX	7274	0.7	
XR50R	00→03	CR6HSA	2983			CR6HIX	7274	0.7	
XR50 Motard	05→06	CR6HSA	2983			CR6HIX	7274	0.9	
Z50R-D	79→99	CR6HS	7023			CR6HIX	7274	0.7	
60	CR60R-G	83→86	BR9ES	5722			BR9EIX	3981	0.7
70	C70C/E	82→86	CR7HS	7223			CR7HIX	7544	0.7
	CRF70F	04→12	CR6HSA	2983			CR6HIX	7274	0.6
	CZ70ZZ, CZ70Z2, C70/C, CF70/C	77→83	CR7HS	7223			CR7HIX	7544	0.7
	XR70V, XR70R	97→03	CR6HSA	2983			CR6HIX	7274	0.6
80	CR80RB	81→82	B9EG	3530	B9EGV	5827	BR9EIX	3981	0.7
	CR80R-D/E/F/2F/G/2G	83→86	BR9ES	5722			BR9EIX	3981	0.7
	CR80RH-RS/T/V	87→99	BR10EG	3830			BR10EIX	6801	0.5
	CR80R, CR80R2	00→02	BR10EG	3830			BR10EIX	6801	0.5
	MBX80FWD-D	83→86	BR9ES	5722			BR9EIX	3981	0.7
	MTX80R-E	83→86	BR8ES	5422			BR8EIX	5044	0.7
	NH80MD/H-P	82→96	BPR6HS	7022			BPR6HIX	4085	0.7
	XR80R-J	79→03	CR7HS	7223			CR7HIX	7544	0.7
85	CR85R/R2	03→06	BR10EG	3830			BR10EIX	6801	0.5
90	C90 ZZ (Step Thru)	79→83	D6HA	6512					0.7
	C90E-C/E/G, C90MF-T (Step Thru)	84→96	CR7HS	7223			CR7HIX	7544	0.7



CC	MODEL	DATE	STANDARD COPPER CORE	STOCK NUMBER	PLATINUM OR GOLD PALLADIUM	STOCK NUMBER	IRIDIUM	STOCK NUMBER	GAP MM
HONDA (CONTINUED)									
90	C90MT (Step Thru)	96→03	CR6HSA	2983			CR6HIX	7274	0.6
	CM90, CM91	67→69	D6HA	6512					0.7
	EZ90-M	90→96	BR7HS	4122			BR7HIX	7067	0.7
	S90	64→69	D6HA	6512					0.7
	SRX90 Joker	96→00	BR6HSA	4296			BPR6HIX	4085	0.6
100	CB100 (N/NA/NB)	78→86	DR8ES-L	2923	DR8EVX	6354	DR8EIX	6681	0.7
	CRF100F	04→13	CR7HSA	4549			CR7HIX	7544	0.6
	H100A/B/S2G	80→92	BR7HS	4122			BR7HIX	7067	0.7
	H100SE/J	86→93	BR8HS	4322			BR8HIX	7001	0.7
	SCV100 Lead	03→06	CR6HSA	2983			CR6HIX	7274	0.6
	SJ100T-V-W (Bali)	97→99	BR6HSA	4296			BPR6HIX	4085	0.6
	XR100 Motard	05→06	CR7HSA	4549			CR7HIX	7544	0.9
	XR100R	85→03	CR7HSA	4549			CR7HIX	7544	0.6
108	NHX110 Lead (Fi)	08→10	CR8EH-9	5666			CR8EHIX-9	3797	0.9
	NSC110 Vision	11→16	CPR8EA-9	2306			CR8EIX	4218	0.9
	NSC110 Vision	17→	MR8C-9N	97985					0.9
109	AFS110 Wave 110i	12→	CPR6EA-9S	1582					0.9
	CRF110F	12→13	CPR6EA-9S	1582					0.9
125	ANF125 Innova	03→06	CPR6EA-9	6899					0.9
	ANF125i Innova	07→	CPR6EA-9	6899					0.9
	CA125S	95→99	CR6HSA	2983			CR6HIX	7274	0.6
	CB92 Ø10mm Plug	59→64	CR7HS	7223			CR7HIX	7544	0.7
	CB92 Ø12mm Plug	59→64	D8HA	7112					0.7
	CB125 (S/S1/J)	71→79	D8EA	2120	DR8EVX	6354	DR8EIX	6681	0.7
	CB125F	15→	CPR7EA-9	3901			CR7EIX	7385	0.9
	CB125RS-D/E	83→86	DR8ES-L	2923	DR8EVX	6354	DR8EIX	6681	0.7
	CB125T (2/B/D-C/D/D-E)	82→88	CR8HS	7423	CR8HVX	7236	CR8HIX	7669	0.7
	CBF125	08→14	CPR7EA-9	3901			CR7EIX	7385	0.9
	CBR125R	04→	CR8E	1275			CR8EIX	4218	0.7
	CD125 Benly	82→85	CR7HS	7223			CR7HIX	7544	0.7
	CG125 C→T	76→96	DR8ES-L	2923	DR8EVX	6354	DR8EIX	6681	0.7
	CG125 W→	97→08	DPR8EA-9	4929			DPR8EIX-9	2202	0.9
	CH125-D/E	83→87	DPR7EA-9	5129			DPR7EIX-9	7803	0.9
	CLR125 City Fly	98→03	DPR8EA-9	4929			DPR8EIX-9	2202	0.8
	CM125C-C	82→86	CR7HS	7223			CR7HIX	7544	0.7
	CR125/RB	80→82	B9EG	3530	B9EGV	5827	BR9EIX	3981	0.5
	CR125R D-Y	83→00	BR9EG	3230			BR9EIX	3981	0.5
	CRF125F	14→	CPR6EA-9	6899					0.9
	CT125C	82→85	DR8ES-L	2923	DR8EVX	6354	DR8EIX	6681	0.7
	FES 125 Pantheon (2-Stroke)	98→02	BR8ES	5422			BR8EIX	5044	0.6
	FES 125 Pantheon (4-Stroke)	03→07	CR8EH-9	5666			CR8EHIX-9	3797	0.9
	FES 125 S-Wing 125	07→12	CR8EH-9	5666			CR8EHIX-9	3797	0.9
	MBX125FE/RW-F/H/L	84→86	BR8ES	5422			BR8EIX	5044	0.7
	MSX125	13→	CPR6EA-9	6899					0.9
	MTX125R-D/E/F	83→94	BR8ES	5422			BR8EIX	5044	0.7
	NES125 @	00→03	CR8EH-9	5666			CR8EHIX-9	3797	0.9
	NH125MD-D	83→87	BPR6HS	7022			BPR6HIX	4085	0.7
	NS125FG/FH/RK-RP	86→93	BR7ES	5122			BR7EIX	6664	0.7
	NSR125 F R/S	88→89	BR9ECS	3570					0.7
	NSR125R-R-S-V	90→03	BR9ECS	3570					0.7
	NSS125 Forza	15→					SILMAR8C9	90097	0.9
	PCX125 (WW)	10→	CPR7EA-9	3901			CR7EIX	7385	0.9
	PS125i (PES125i)	07→13	CR8EH-9	5666			CR8EHIX-9	3797	0.9
	SES125 Dylan	02→07	CR8EH-9	5666			CR8EHIX-9	3797	0.9
	SH125	01→08	CR8EH-9	5666			CR8EHIX-9	3797	0.9
	SH125i	09→12	CR8EH-9	5666			CR8EHIX-9	3797	0.9
	SH125i	13→	CPR7EA-9	3901			CR7EIX	7385	0.9
	SH Mode 125	14→	CPR7EA-9	3901			CR7EIX	7385	0.9
	SS125	67→69	D8HA	7112					0.7
	VT125 /C2 Shadow	98→07	CR8EH-9	5666			CR8EHIX-9	3797	0.8
XL125 (S/SA/SB/RO/RF)	75→87	DR8ES-L	2923	DR8EVX	6354	DR8EIX	6681	0.7	
XL125V Varadero	01→	CR8EH-9	5666			CR8EHIX-9	3797	0.9	
XLR125R	97→99	DPR8EA-9	4929			DPR8EIX-9	2202	0.8	
XR125L	03→13	DPR8EA-9	4929			DPR8EIX-9	2202	0.8	



CC	MODEL	DATE	STANDARD COPPER CORE	STOCK NUMBER	PLATINUM OR GOLD PALLADIUM	STOCK NUMBER	IRIDIUM	STOCK NUMBER	GAP MM
HONDA (CONTINUED)									
150	FES150 Pantheon	05→09	CR8EH-9	5666			CR8EHIX-9	3797	0.9
	CRF150R/R2	07→	CR8EH-9	5666			CR8EHIX-9	3797	0.9
	CRF150R/B	09→	CR8EH-9	5666			CR8EHIX-9	3797	0.9
185	CD185T	78→82	CR7HS	7223			CR7HIX	7544	0.7
	XL185S (2/A/B)	79→84	DR8ES-L	2923	DR8EVX	6354	DR8EIX	6681	0.7
200	CB200	76→79	D8EA	2120	DR8EVX	6354	DR8EIX	6681	0.7
	CD200T (A/B), CM200T (A/B)	80→85	CR7HS	7223			CR7HIX	7544	0.7
	MTX200RW-D	83→86	BR9ES	5722			BR9EIX	3981	0.7
	TLR200R-E/F	83→87	DR8ES-L	2923	DR8EVX	6354	DR8EIX	6681	0.7
	XR200 (A/R-C)	80→83	DR8ES-L	2923	DR8EVX	6354	DR8EIX	6681	0.7
230	CRF230F	03→12	DPR8EA-9	4929			DPR8EIX-9	2202	0.8
250	CB250 K2,K3,K4,G5	73→77	B8ES	2411			BR8EIX	5044	0.7
	CB250N A/B/DXB	78→83	DR8ES	5423			DR9EIX	4772	0.7
	CB250N/T/W	92→03	CR6HSA	2983			CR6HIX	7274	0.7
	CB250RS (A/B)	80→83	DR8ES-L	2923	DR8EVX	6354	DR8EIX	6681	0.7
	CB250RSD-C	82→84	DR8ES	5423			DR9EIX	4772	0.7
	CB250T Dream	77→81	DR8ES-L	2923	DR8EVX	6354	DR8EIX	6681	0.7
	CBF250	04→06	CR8EH-9S	7750			CR8EHIX-9	3797	0.9
	CBR250R	11→14					SIMR8A9	91064	0.9
	CBX250RSE	84→86	DPR8EA-9	4929			DPR8EIX-9	2202	0.9
	CD250U-J/K	88→93	CR6HSA	2983			CR6HIX	7274	0.7
	CH250F/G (Spacy)	85→87	DPR6EA-9	5531					0.9
	CL250S-C	82→84	DR8ES-L	2923	DR8EVX	6354	DR8EIX	6681	0.7
	CM250T	82→84	DR8ES	5423			DR9EIX	4772	0.7
	CMX250C-T	95→99	CR6HSA	2983			CR6HIX	7274	0.6
	CN250-L/M/N	90→92	DPR6EA-9	5531					0.9
	CR250 R3/R-D/E/F/G/H		BR8EG	3130			BR8EIX	5044	0.5
	CR250R-J		BR9EG	3230			BR9EIX	3981	0.5
	CR250R-S/T/V		BR8EG	3130			BR8EIX	5044	0.5
	CR250R K5	05→	BR9EG-N-8	2689					0.8
	CRF250L	12→					SIMR8A9	91064	0.9
	CRF250M	13→					SIMR8A9	91064	0.9
	CRF250R K5/K6 (19mm Thread Reach)	04→09					R0409B-8	7791	0.7
	CRF250R (26.5mm Thread Reach)	10→					R0451B-8	9356	0.7
	CRF250X K5-L4	04→					IMR8C-9H	3653	0.9
	FES250 W-X-Y (Foresight)	97→03	DPR7EA-9	5129			DPR7EIX-9	7803	0.9
	RTL250		D6EA	7512					0.7
	TL250		D7EA	7912					0.7
	TLR250F		DR8ES-L	2923	DR8EVX	6354	DR8EIX	6681	0.7
	VT250F-D	83→87	DPR8EA-9	4929			DPR8EIX-9	2202	0.9
	XL250/K3		D8EA	2120	DR8EVX	6354	DR8EIX	6681	0.7
	XL250R-C	82→84	DR8ES-L	2923	DR8EVX	6354	DR8EIX	6681	0.7
	XL250RE	84→86	DPR9Z	4830					0.7
	XL250S (A/B/Z)	73→82	DR8ES-L	2923	DR8EVX	6354	DR8EIX	6681	0.7
XR250	→84	D8EA	2120	DR8EVX	6354	DR8EIX	6681	0.7	
XR250RE	84→95	DPR9Z	4830					0.7	
XR250RT/V	96→01	CR9EH-9	7502			CR9EHIX-9	6216	0.9	
280	SH300i	07→	LMAR8A-9	4313					0.9
	NSS300 Forza	13→	LMAR8A-9	4313					0.9
286	CBR300R	15→				SIMR8A9	91064	0.9	
350	CB350SG	86→88	DR8ES-L	2923	DR8EVX	6354	DR8EIX	6681	0.7
	XR350R-D		DPR8EA-9	4929			DPR8EIX-9	2202	0.9
	XR350R-E		DPR7EA-9	5129			DPR7EIX-9	7803	0.9
360	CB360G		B8ES	2411			BR8EIX	5044	0.7
400	CB400 (N/NA/NC/T)	78→85	DR8ES	5423			DR9EIX	4772	0.7
	CB400F1, F2	89→91	D8EA	2120	DR8EVX	6354	DR8EIX	6681	0.7
	NS400RF	85→88	BR9ES	5722			BR9EIX	3981	0.7
	VF400F-D	83→86	DPR8EA-9	4929			DPR8EIX-9	2202	0.9
	VFR400 R3-L-P	90→93	ER9EH	5869					0.7
	XR400RT/V		DPR8Z	4730					0.6
450	CB450DX-K	89→92	DR8ES	5423			DR9EIX	4772	0.7
	CRF450R (19mm Thread Reach)	02→08					IFR8H11	5068	1.1
	CRF450R (26.5mm Thread Reach)	09→					SILMAR9A9S	6213	0.9
	CRF450X	05→					IFR8H11	5068	1.1



CC	MODEL	DATE	STANDARD COPPER CORE	STOCK NUMBER	PLATINUM OR GOLD PALLADIUM	STOCK NUMBER	IRIDIUM	STOCK NUMBER	GAP MM
HONDA (CONTINUED)									
480	CR480R-D		B8EG	3430	B8EGV	5627	BR8EIX	5044	0.5
500	CB500F	03/13→	CPR8EA-9	2306			CR8EIX	4218	0.9
	CB500 T	75→80	B8ES	2411			BR8EIX	5044	0.7
	CB500 R, T, V, W, X, Y	94→	CR8EH-9	5666			CR8EHIX-9	3797	0.9
	CB500S-W (Half Fairing)	98→	CR8EH-9	5666			CR8EHIX-9	3797	0.9
	CB500X	05/13→	CPR8EA-9	2306			CR8EIX	4218	0.9
	CBF500	04→	CR8EH-9S	7750			CR8EHIX-9	3797	0.9
	CBR500R	03/13→	CPR8EA-9	2306			CR8EIX	4218	0.9
	CR500R-E S, T, V, W, X	93→	BR8EG	3130			BR8EIX	5044	0.5
	CX500 (Z, A, B, CA, DA, CB, EC)	78→84	DR8ES-L	2923	DR8EVX	6354	DR8EIX	6681	0.7
	CX500 TURBO	82→84					DPR8EIX-9	2202	0.9
	FT500-C	82→84	DR8ES	5423			DR9EIX	4772	0.7
	GL500 Silverwing	82→84	DR8ES-L	2923	DR8EVX	6354	DR8EIX	6681	0.6
	VF500F 2E/2F	84→87	DPR8EA-9	4929			DPR8EIX-9	2202	0.9
	VT500E-D/F	83→88	DPR8EA-9	4929			DPR8EIX-9	2202	0.9
	XBR500F/H/SJ	85→89	DPR8EA-9	4929			DPR8EIX-9	2202	0.9
	XL500 (SA,RC)	79→84	DR8ES-L	2923	DR8EVX	6354	DR8EIX	6681	0.7
	XR500		DR8ES-L	2923	DR8EVX	6354	DR8EIX	6681	0.7
550	CB550		DR7ES	3123					0.7
	CBX550F (C,2-C)	82→86	DR8ES	5423			DR9EIX	4772	0.7
600	CB600F (Hornet)	98→06	CR9EH-9	7502			CR9EHIX-9	6216	0.9
	CB600F (Hornet)	07→	CR9EH-9	7502			CR9EHIX-9	6216	0.9
	CB600FA (Hornet with ABS)	08→	CR9EH-9	7502			CR9EHIX-9	6216	0.9
	CBF600 N/S (Incl. ABS)	04→07	CR9EH-9	7502			CR9EHIX-9	6216	0.9
	CBF600 N/S (Incl. ABS)	08→	CR8EH-9	5666			CR8EHIX-9	3797	0.9
	CBR600F H, J	87→88	DPR8EA-9	4929			DPR8EIX-9	2202	0.9
	CBR600F K, L	89→90	DPR9EA-9	5329			DPR9EIX-9	5545	0.9
	CBR600F M, N, P, R, S, T, V, W	91→98	CR9EH-9	7502			CR9EHIX-9	6216	0.9
	CBR600F X, Y	99→00	CR9EH-9	7502			CR9EHIX-9	6216	0.9
	CBR600FI / FSI Injection	2001					IMR9A-9H	6966	0.9
	CBR600F Injection	02→07					IMR9C-9H	6777	0.9
	CBR600F Sport	02→07					IMR9C-9H	6777	0.9
	CBR600F	03/11→	CR9EH-9	7502			CR9EHIX-9	6216	0.9
	CBR600RR	03/03→08					IMR9C-9HES	5766	0.9
	CBR600RR (Incl. ABS)	09→					IMR9E-9HES	7556	0.9
	FJS600 Silverwing (Incl. ABS)	01→	CR8EH-9	5666			CR8EHIX-9	3797	0.9
	NTV600K/M Revere	88→93	DPR8EA-9	4929			DPR8EIX-9	2202	0.9
	VT600C N, P, R, S, T, V, W	92→01	DPR8EA-9	4929			DPR8EIX-9	2202	0.9
	XL600LM-F	84→86	DPR8EA-9	4929			DPR8EIX-9	2202	0.9
	XL600R D, E	84→86	DPR8EA-9	4929			DPR8EIX-9	2202	0.9
XL600VH-VX (Transalp)	87→00	DPR8EA-9	4929			DPR8EIX-9	2202	0.9	
XR600R-V		DPR8EA-9	4929			DPR8EIX-9	2202	0.8	
650	CB650 Z, 2, B	78→82	DR8ES-L	2923	DR8EVX	6354	DR8EIX	6681	0.7
	CB650 SC-C (Nighthawk)	82→84	DR8ES-L	2923	DR8EVX	6354	DR8EIX	6681	0.7
	CB650FA	14→	CR9EH-9	7502			CR9EHIX-9	6216	0.9
	CBR650FA	14→	CR9EH-9	7502			CR9EHIX-9	6216	0.9
	CX650E-D	83→86	DPR8EA-9	4929			DPR8EIX-9	2202	0.9
	CX650TC-D	83→85	DPR8EA-9	4929			DPR8EIX-9	2202	0.9
	FMX650	05→08	DPR8EA-9	4929			DPR8EIX-9	2202	0.9
	FX650 Vigor	99→03	DPR8EA-9	4929			DPR8EIX-9	2202	0.9
	GL650 Silverwing	83→87	DPR8EA-9	4929			DPR8EIX-9	2202	0.9
	NT650V-W-X-Y (Deauville)	98→05	DPR8EA-9	4929			DPR8EIX-9	2202	0.9
	NTV650P-T/V	92→97	DPR8EA-9	4929			DPR8EIX-9	2202	0.9
	NX650K-T-V-W-X Dominator	88→03	DPR8EA-9	4929			DPR8EIX-9	2202	0.9
	SLR650	96→99	DPR8EA-9	4929			DPR8EIX-9	2202	0.8
	XL650 /V (Transalp)	00→07	DPR8EA-9	4929			DPR8EIX-9	2202	0.9
	XR650R, R-2		BKR7E-11	1283					1.0
670	NC700D Integra	12→13					IFR6G-11K	1314	1.1
	NC700S/X	12→13					IFR6G-11K	1314	1.1
680	DN-01	08→11					SIMR8A9	91064	0.9
	NT700V Deauville (Incl. ABS)	06→	CPR8EA-9	2306			CR8EIX	4218	0.9
	XL700V Transalp (Incl. ABS)	08→	CPR8EA-9	2306			CR8EIX	4218	0.9



CC	MODEL	DATE	STANDARD COPPER CORE	STOCK NUMBER	PLATINUM OR GOLD PALLADIUM	STOCK NUMBER	IRIDIUM	STOCK NUMBER	GAP MM
HONDA (CONTINUED)									
745	NC750 Integra	14→					IFR6G-11K	1314	1.1
	NC750S/X	14→					IFR6G-11K	1314	1.1
	NM4 Vultus	14→					IFR6G-11K	1314	1.1
750	CB750 (SOHC)	70→78	D8EA	2120	DR8EVX	6354	DR8EIX	6681	0.7
	CB750 (DOHC)	79→84	DR8ES	5423			DR9EIX	4772	0.7
	CB Seven Fifty	92→02	DPR8EA-9	4929			DPR8EIX-9	2202	0.9
	CBX750FE	84→86	DPR8EA-9	4929			DPR8EIX-9	2202	0.9
	NR (750)	1992	ER9EH	5869					0.7
	RVF750R-S (RC45)	94→98					CR9EHIX-9	6216	0.9
	VF750 (C/F/S)		DPR8EA-9	4929			DPR8EIX-9	2202	0.9
	VF750CP-S		CR8EH-9	5666			CR8EHIX-9	3797	0.9
	VFR750F G, F, K	86→88	DPR9EA-9	5329			DPR9EIX-9	5545	0.9
	VFR750F L-V	89→97	CR8EH-9	5666			CR8EHIX-9	3797	0.9
	VFR750R-K/L (RC30)	88→92	CR9EH-9	7502			CR9EHIX-9	6216	0.9
	VT750C2 VT750 V/W Shadow	97→00	DPR8EA-9	4929			DPR8EIX-9	2202	0.8
	VT750DC Shadow	01→06	DPR8EA-9	4929			DPR8EIX-9	2202	0.8
	VT750C NEC Shadow Spirit	07→09	DPR7EA-9	5129			DPR7EIX-9	7803	0.9
	VT750DC Shadow Spirit	07→09	DPR7EA-9	5129			DPR7EIX-9	7803	0.9
	VT750C Shadow Black Spirit	10→	DPR7EA-9	5129			DPR7EIX-9	7803	0.9
	VT750S	10→	DPR7EA-9	5129			DPR7EIX-9	7803	0.9
XRV750L V, W, X, Y (Africa Twin)	90→03	DPR8EA-9	4929			DPR8EIX-9	2202	0.9	
800	VFR800F-W Fi X-Y (781cc)	97→01	CR9EH-9	7502			CR9EHIX-9	6216	0.8
	VFR800F-W K2→ Fi VTEC (Incl. ABS) (782cc)	02→					IMR9B-9H	4888	0.9
	VFR800X Crossrunner (782cc)	05/11→					IMR9D-9H	6544	0.9
900	CB900F/F2 (Z, D, 2-D)	79→85	DR8ES	5423			DR9EIX	4772	0.7
	CB900F Hornet	02→08	CR8EH-9	5666			CR8EHIX-9	3797	0.9
	CBR900RR-N-S Fireblade (893cc)	92→95	CR9EH-9	7502			CR9EHIX-9	6216	0.9
	CBR900RR T, V, W, X Fireblade (918cc)	96→99	CR9EH-9	7502			CR9EHIX-9	6216	0.9
	CBR900RR Y Fireblade (929cc Injection Model)	00→01					CR9EHI-9	6419	0.9
	CBR900RR K2 Fireblade (954cc '02 model)	02→03					IMR9C-9H	6777	0.9
1000	CB1000 F-V	92→97	DPR9EA-9	5329			DPR9EIX-9	5545	0.9
	CB1000R/RA	08→					IMR9E-9HES	7556	0.9
	CBF1000 (Incl. ABS)	06→10	CR8EH-9	5666			CR8EHIX-9	3797	0.9
	CBF1000A (Incl. ABS)	10→					IMR8C-9HES	5990	0.9
	CBF1000F (Incl. ABS & GT)	10→					IMR8C-9HES	5990	0.9
	CBR1000FH-FX	87→99	DPR9EA-9	5329			DPR9EIX-9	5545	0.9
	CBR1000RR Fireblade	04→07					IMR9C-9HES	5766	0.9
	CBR1000RR Fireblade (Incl. ABS)	08→13					IMR9E-9HES	7556	0.9
	CBR1000RR Fireblade	14→16					IMR9E-9HES	7556	0.9
	CBR1000RR Fireblade SP	14→16					IMR9E-9HES	7556	0.9
	GL1000 (Gold Wing)	75→79	DR8ES-L	2923	DR8EVX	6354	DR8EIX	6681	0.7
	VF1000F2F Bol d'Or	85→86	DPR9EA-9	5329			DPR9EIX-9	5545	0.9
	VF1000FE	84→85	DPR8EA-9	4929			DPR8EIX-9	2202	0.9
	VF1000FF	85→87	DPR9EA-9	5329			DPR9EIX-9	5545	0.9
	VF1000RE-Standard	84→85	DPR8EA-9	4929			DPR8EIX-9	2202	0.9
	VF1000RE-High Speed	84→85	DPR9EA-9	5329			DPR9EIX-9	5545	0.9
	VF1000RF	85→88	DPR9EA-9	5329			DPR9EIX-9	5545	0.9
	VTR1000 F W-Y (Firestorm)	97→08					DPR9EIX-9	5545	0.9
	VTR1000 SP1	00→01					FR9BI-11	4709	1.1
	VTR1000 SP2	02→07					IFR9H11	6588	1.1
XL1000V-Y (Varadero)	98→02					DPR8EIX-9	2202	0.8	
XL1000V Varadero (Incl. ABS)	03→12					IJR8B9	4873	0.9	
1050	CBX1000B,C (6-cyl.)	78→84	DR8ES-L	2923	DR8EVX	6354	DR8EIX	6681	0.7
1100	CB1100 (RB,RC,RD) Road Use	82→84	DR8ES	5423			DR9EIX	4772	0.7
	CB1100SF-Y (X11)	99→02					CR8EHIX-9	3797	0.9
	CBR1100 XX V-Y (Super Blackbird)	96→00					CR9EHIX-9	6216	0.9
	CBR1100 XX K1 (Super Blackbird)	2001					IMR9A-9H	6966	0.9
	CBR1100 XX K2 (Super Blackbird) 3405930→	02→07					IMR9C-9H	6777	0.9
	GL1100B (Gold Wing)	80→83	DR8ES-L	2923	DR8EVX	6354	DR8EIX	6681	0.7
	ST1100 ABS/TCS/T/V	95→03	CR8EH-9	5666			CR8EHIX-9	3797	0.9
	ST1100/L S-Y (Pan European)	89→03	CR8EH-9	5666			CR8EHIX-9	3797	0.9
1140	CB1100	13→	LMAR8A-9S	6817					0.9
	CB1100EX	14→	LMAR8A-9S	6817					0.9



CC	MODEL	DATE	STANDARD COPPER CORE	STOCK NUMBER	PLATINUM OR GOLD PALLADIUM	STOCK NUMBER	IRIDIUM	STOCK NUMBER	GAP MM
HONDA (CONTINUED)									
1200	GL1200-EDE/IE/AE/AF/AH (Gold Wing)	84→88	DPR7EA-9	5129			DPR7EIX-9	7803	0.9
1237	VFR1200F/FD	10→					IMR9E-9HES	7556	0.9
	VFR1200X Crosstourer (Incl. Highlander-T)	04/12→					IMR8E-9HES	95397	0.9
1260	CTX1300	14→	CR8EH-9	5666			CR8EHIX-9	3797	0.9
	ST1300 Pan European (Incl. ABS)	02→14	CR7EH-9	3486			CR7EIX	7385	0.9
1300	CB1300 (Incl. ABS)	03→13	DPR8EA-9	4929			DPR8EIX-9	2202	0.9
	CB1300S (Incl. ABS)	05→13	DPR8EA-9	4929			DPR8EIX-9	2202	0.9
	VTX1300, VT1300CX	03→09	DCPR6E	3481					0.9
1500	GL1500 J-L, GL1500 SE M-Y (Gold Wing)	88→01	DPR6EA-9	5531					0.9
	GL1500CT (Gold Wing)	97→00	DPR7EA-9	5129			DPR7EIX-9	7803	0.9
	GL1500C-V-W-(F6C) (Gold Wing)	96→03	DPR7EA-9	5129			DPR7EIX-9	7803	0.9
1800	GL1800 (Gold Wing) (Incl. ABS)	01→	BKR6E-11	2756			BKR6EIX-11	3764	1.1
	GL1800 F6B (Gold Wing Bagger)	14→	BKR6E-11	2756			BKR6EIX-11	3764	1.1
	GL1800 F6C (Gold Wing)	14→	BKR6E-11	2756			BKR6EIX-11	3764	1.1
	VTX1800/C	01→08					IFR6L11	3678	1.1

HUONIAO

50	HN50-QT8	07→	C7HSA	4629			CR7HIX	7544	0.7
125	HN125-8	06→	D8EA	2120			DR8EIX	6681	0.7

HUSABERG

125	TE125	12→					BR9ECMIX	2707	0.6
250	FE250 (19mm Thread Reach)	2013	CR9EKB	2305			CR9EIX	3521	0.8
	FE250 (26.5mm Thread Reach)	14→					LMAR9AI-10	93188	1.0
	TE250	11→	BR7ES	5122			BR7EIX	6664	0.7
300	TE300	11→	BR7ES	5122			BR7EIX	6664	0.7
350	FE350	13→					LMAR9AI-8	97225	0.8
390	FE390	10→					LKAR8AI-9	6706	0.9
400	FE, FS 400E/C	00→	DCPR8E*	4179			DCR8EIX	3606	0.6
450	FE450	09→					LKAR8AI-9	6706	0.9
470	FC, FX 470/6, E	00→	DCPR8E*	4179			DCR8EIX	3606	0.6
510	FE501	13→					LKAR8AI-9	6706	0.9
550	FC550/4/6	00→	DCPR8E*	4179			DCR8EIX	3606	0.6
565	FE570	09→					LKAR8AI-9	6706	0.9
	FS570	10→					LKAR8AI-9	6706	0.9
650	FE, FS, FX 650 Supermoto	00→	DCPR8E*	4179			DCR8EIX	3606	0.6

HUSQVARNA

50	CR50	11→	BR8ECM	3035			BR8ECMIX	3520	0.7
	Husky Boy Basic	00→04	B8HS	5510			BR8HIX	7001	0.5
	Husky Boy Junior (12.7mm Thread Reach)	99→02	B6HS	4510			BR6HIX	3419	0.5
	Husky Boy Junior (19mm Thread Reach)	03→			B10EGV	5927	BR10EIX	6801	0.6
	Husky Boy Racing	01→	B6HS	4510			BR6HIX	3419	0.5
	Husky Boy Senior (12.7mm Thread Reach)	99→02	B6HS	4510			BR6HIX	3419	0.5
	Husky Boy Senior (19mm Thread Reach)	03→			B10EGV	5927	BR10EIX	6801	0.6
	SM50	02→10	BR9ES	5722			BR9EIX	3981	0.7
	SM50	11→	BR8ECM	3035			BR8ECMIX	3520	0.7
	WRS 50 (Scooter)		B9ES	2611			BR9EIX	3981	0.7
	WSM 50	03→	BR9ES	5722			BR9EIX	3981	0.7
	WXE 50	03→	BR9ES	5722			BR9EIX	3981	0.7
65	CR65	06/11→	BR8ECM	3035			BR8ECMIX	3520	0.6
125	CR125	→91	B9EG	3530	B9EGV	5827	BR9EIX	3981	0.5
	CR125	92→01			B95EGV	2145		0.5	
	CR125	02→05	BR9EG	3230			BR9EIX	3981	0.5
	CR125	10→	BR9EG	3230			BR9EIX	3981	0.6
	SM125/S	98→	BR9EG	3230			BR9EIX	3981	0.5
	SMS4 125	11→	CR8E	1275			CR8EIX	4218	0.7
	TE125 Ø10mm Plug	11→13	CR8E	1275			CR8EIX	4218	0.7
	TE125 Ø14mm Plug	14→					BR9ECMIX	2707	0.6



* Please note DCPR8E 4339 has a removable terminal nut, whereas DCPR8E 4179 has a fixed terminal nut





CC	MODEL	DATE	STANDARD COPPER CORE	STOCK NUMBER	PLATINUM OR GOLD PALLADIUM	STOCK NUMBER	IRIDIUM	STOCK NUMBER	GAP MM
HUSQVARNA (CONTINUED)									
125	WR125	→91	B9EG	3530	B9EGV	5827	BR9EIX	3981	0.5
	WR125	92→			B95EGV	2145			0.5
	WR125	02→	BR9EG	3230			BR9EIX	3981	0.5
	WRE125	94→97	B10EG	3630	B10EGV	5927	BR10EIX	6801	0.5
	WRE125 (Restricted)	98→	BR9EG	3230			BR9EIX	3981	0.5
	WRE125 (Restricted)	09→	BR9EG	3230			BR9EIX	3981	0.6
	WRK125	→89			B10EGV	5927	BR10EIX	6801	0.5
	WSM125	04→	CR7HSA	4549			CR7HIX	7544	0.7
WXE125	04→	CR7HSA	4549			CR7HIX	7544	0.7	
240	WR240		B8EG	3430	B8EGV	5627	BR8EIX	5044	0.5
250	CR250	92→00			B95EGV	2145			0.5
	CR250	01→04	B8EG	3430	B8EGV	5627	BR8EIX	5044	0.5
	CR250	04→	BR8EG	3130			BR8EIX	5044	0.6
	FE250	14→					LMAR9AI-10	93188	1.0
	TC250	02→05	CR8EB	7784			CR8EIX	4218	0.7
	TC250 (4-Stroke) Ø10mm Plug	10→	CR9EB	6955			CR9EIX	3521	0.7
	TE250	02→	CR8EB	7784			CR8EIX	4218	0.7
	TE250 i.e (4-Stroke) Ø10mm Plug	10→12	CR9EB	6955			CR9EIX	3521	0.7
	TE250 (4-Stroke) Ø10mm Plug	2013					CR9EIA-9	6289	0.9
	TE250 (2-Stroke) Ø14mm Plug	14→	BR7ES	5122			BR7EIX	6664	0.6
	TXC250	10→	CR9EB	6955			CR9EIX	3521	0.7
	WR250	92→01			B9EGV	5827	BR9EIX	3981	0.5
	WR250	02→	BR8EG	3130			BR8EIX	5044	0.6
WRK250	→89			B10EGV	5927	BR10EIX	6801	0.5	
260	WRK260	→89			B10EGV	5927	BR10EIX	6801	0.5
300	TE300 (2-Stroke) Ø14mm Plug	14→	BR7ES	5122			BR7EIX	6664	0.6
	WR300	09→	BR8EG	3130			BR8EIX	5044	0.6
302	TE310 (4-Stroke) Ø10mm Plug	09→10	CR8EB	7784			CR8EIX	4218	0.7
	TE310 (4-Stroke) Ø10mm Plug	11→12	CR9EB	6955			CR9EIX	3521	0.7
	TE310 (4-Stroke) Ø10mm Plug	2013					CR9EIA-9	6289	0.9
350	FE350	14→					LMAR9AI-8	97225	0.8
	TE350	90→95	C8E	7471			CR8EIX	4218	0.5
	WR350	92→02			B9EGV	5827	BR9EIX	3981	0.5
360	CR360	92→94			B8EGV	5627	BR8EIX	5044	0.5
	WR360	02→	B8EG	3430	B8EGV	5627	BR8EIX	5044	0.5
390	CR390		B8EG	3430	B8EGV	5627	BR8EIX	5044	0.5
400	SM400	02→05	CR8EB	7784			CR8EIX	4218	0.7
	TE400	01→	CR8EB	7784			CR8EIX	4218	0.7
	WR400		B8EG	3430	B8EGV	5627	BR8EIX	5044	0.5
410	TE410	96→00	C8E	7471			CR8EIX	4218	0.5
	TE410e	99→00	CR7E	4578			CR7EIX	7385	0.6
430	CR430		B8EG	3430	B8EGV	5627	BR8EIX	5044	0.5
	WR430		B8EG	3430	B8EGV	5627	BR8EIX	5044	0.5
435	CR435		B8EG	3430	B8EGV	5627	BR8EIX	5044	0.5
450	FE450	14→					LKAR8AI-9	6706	0.9
	SM450R	03→07	CR8EB	7784			CR8EIX	4218	0.7
	SM450RR	08→	CR9EKB	2305			CR9EIX	3521	0.8
	TC449	11→	CR9EKB	2305			CR9EIX	3521	0.8
	TC450	04→	CR8EB	7784			CR8EIX	4218	0.7
	TE449	11→	CR9EKB	2305			CR9EIX	3521	0.8
	TE450	03→	CR8EB	7784			CR8EIX	4218	0.7
478	SMR511	11→	CR9EKB	2305			CR9EIX	3521	0.8
	TE511	11→	CR9EKB	2305			CR9EIX	3521	0.8
500	CR500		B8EG	3430	B8EGV	5627	BR8EIX	5044	0.5
	WR500		B8EG	3430	B8EGV	5627	BR8EIX	5044	0.5
	TC500 (Air Cooled)	→5/86	D8EA	2120	DR8EVX	6354	DR8EIX	6681	0.5
510	FE501	14→					LKAR8AI-9	6706	0.9
	SM510 R i.e	10→	CR8EB	7784			CR8EIX	4218	0.7
	TC510 (Liquid Cooled)	06/86→90	C7E	5096			CR7EIX	7385	0.5
	TE510 (Air Cooled)	→5/86	D8EA	2120	DR8EVX	6354	DR8EIX	6681	0.5
	TE510 (Liquid Cooled)	06/86→90	C7E	5096			CR7EIX	7385	0.6
TE510	04→	CR8EB	7784			CR8EIX	4218	0.7	
530	SM530RR	09→	CR9EKB	2305			CR9EIX	3521	0.8



CC	MODEL	DATE	STANDARD COPPER CORE	STOCK NUMBER	PLATINUM OR GOLD PALLADIUM	STOCK NUMBER	IRIDIUM	STOCK NUMBER	GAP MM
HUSQVARNA (CONTINUED)									
570	SM570	01→04	CR7EB	4663			CR7EIX	7385	0.6
	SM570R	02→04	C7E	5096			CR7EIX	7385	0.6
	SM570R 2004 (Competition Plug)	04→	C8E	7471			CR8EIX	4218	0.5
	TC570	01→02	CR7EB	4663			CR7EIX	7385	0.6
	TE570	01→03	CR7EB	4663			CR7EIX	7385	0.6
600	SMS630 i.e	11→	CR8EB	7784			CR8EIX	4218	0.7
	TE630 i.e	11→	CR8EB	7784			CR8EIX	4218	0.7
610	SM610 S (Std. Plug)	98→05	CR7E	4578			CR7EIX	7385	0.6
	SM610 S (Competition Plug)	03→	C8E	7471			CR8EIX	4218	0.5
	SM610	06→	CPR8E	7411			CR8EIX	4218	0.8
	TC610	91→00	C7E	5096			CR7EIX	7385	0.5
	TE610	91→00	C8E	7471			CR8EIX	4218	0.5
	TE610e	98→05	CR7E	4578			CR7EIX	7385	0.6
630	SMR630	04→	R0045J-10	7400					1.1
650	TR650 Strada (Twin Spark)	10/12→	MAR9A-J	6869					0.8
	TR650 Terra (Twin Spark)	10/12→	MAR9A-J	6869					0.8
900	Nuda 900, 900R	12→	LMAR8C-9	93833					0.9

HYMOTO									
50	HY50		C7HSA	4629			CR7HIX	7544	0.7
	MP DB701 2-Stroke		BPM7A	7321					0.7
70	HY70		C7HSA	4629			CR7HIX	7544	0.7
90	HY90		C7HSA	4629			CR7HIX	7544	0.7
110	HY110		C7HSA	4629			CR7HIX	7544	0.7
125	HY125		C7HSA	4629			CR7HIX	7544	0.7
	HY125S		C7HSA	4629			CR7HIX	7544	0.7

HYOSUNG									
50	SD50, Sense50	99→05	BP6HS	4511			BPR6HIX	4085	0.7
	SF50	99→05	BR8HSA	5539			BPR8HIX	6742	0.7
100	EZ100	99→	BP7HS	5111			BPR7HIX	5944	0.7
110	FX110		C6HSA	3228			CR6HIX	7274	0.7
	Midas DLX 110	99→	C6HSA	3228			CR6HIX	7274	0.7
125	Cruise 1 125	96→	D8EA	2120	DR8EVX	6354	DR8EIX	6681	0.7
	Cruise 2 125	99→	CR8EH-9	5666			CR8EHIX-9	3797	0.9
	GA125 Cruise III	00→	CR8EH-9	5666			CR8EHIX-9	3797	0.9
	GF125	99→	CR8EH-9	5666			CR8EHIX-9	3797	0.9
	Grand Prix 125, GP-Plus	99→	DR8EA	7162	DR8EVX	6354	DR8EIX	6681	0.7
	GT125	03→	CR8E	1275			CR8EIX	4218	0.6
	GT125R	06→	CR8E	1275			CR8EIX	4218	0.6
	GV125 Aquila	00→	CR8E	1275			CR8EIX	4218	0.6
	GV125C	08→	CR8E	1275			CR8EIX	4218	0.8
	HD125 Hyper	04→06	DR8EA	7162	DR8EVX	6354	DR8EIX	6681	0.8
	MS3-125	07→	CR8E	1275			CR8EIX	4218	0.8
	RT125 (SOHC engine)	04→07	CR8EH-9	5666			CR8EHIX-9	3797	0.9
	RT125D (DOHC engine)	07→	CR8E	1275			CR8EIX	4218	0.8
	RX125 (SOHC engine)	00→07	CR8EH-9	5666			CR8EHIX-9	3797	0.9
RX125D-E (DOHC engine)	07→	CR8E	1275			CR8EIX	4218	0.8	
RX125D SM (DOHC engine)	07→	CR8E	1275			CR8EIX	4218	0.8	
XR125 (SOHC engine)	→07	CR8EH-9	5666			CR8EHIX-9	3797	0.8	
250	GT250, Comet	03→	CR8E	1275			CR8EIX	4218	0.8
	GT250 EFI, Comet	08→	CR8E	1275			CR8EIX	4218	0.8
	GT250R	06→08	CR8E	1275			CR8EIX	4218	0.8
	GT250R EFI	08→	CR8E	1275			CR8EIX	4218	0.8
	GV250, Aquila	00→	CR8E	1275			CR8EIX	4218	0.8
	GV250 EFI, Aquila	08→	CR8E	1275			CR8EIX	4218	0.8
MS3-250	07→	CR8E	1275			CR8EIX	4218	0.8	
650	GT650, Comet	03→	CR8E	1275			CR8EIX	4218	0.8
	GT650 EFI, Comet	08→	CR8E	1275			CR8EIX	4218	0.8
	GT650N	12→	CR8E	1275			CR8EIX	4218	0.8
	GT650R	06→08	CR8E	1275			CR8EIX	4218	0.8



CC	MODEL	DATE	STANDARD COPPER CORE	STOCK NUMBER	PLATINUM OR GOLD PALLADIUM	STOCK NUMBER	IRIDIUM	STOCK NUMBER	GAP MM
HYOSUNG (CONTINUED)									
650	GT650R EFI	08→	CR8E	1275			CR8EIX	4218	0.8
	GT650S	06→08	CR8E	1275			CR8EIX	4218	0.8
	GV650, Aquila	06→08	CR8E	1275			CR8EIX	4218	0.8
	GV650 EFI, Aquila	08→	CR8E	1275			CR8EIX	4218	0.8
680	GV700C EFI	10→	CR8E	1275			CR8EIX	4218	0.8

INDIAN									
1850	Dakota 4 - Classic, Highway, 4 si (Carb)		BPR6HS	7022			BPR6HIX	4085	0.6
	Dakota 4 - Classic, Highway, 4 si (Injection)		BPR7HS	6422			BPR7HIX	5944	0.6

ITALJET									
50	Dragster D50 LC (Liquid Cooled)	98→04	BR8HS	4322			BR8HIX	7001	0.6
	Formula 50, 50 A, Formula 50 Williams (Air Cooled)	96→04	BPR6HS	7022			BPR6HIX	4085	0.6
	Formula 50 LC	98→04	BR7HS	4122			BR7HIX	7067	0.6
	Jetset 50 2T	01→04	BR9ES	5722			BR9EIX	3981	0.7
	Torpedo 50/T50	97→04	BPR6HS	7022			BPR6HIX	4085	0.6
	Velocifero 50/V50	96→	BPR6HS	7022			BPR6HIX	4085	0.6
100	Millennium 100	00→04	BR7HS	4122			BR7HIX	7067	0.6
125	Dragster D125LC (2-Stroke Liquid Cooled)	99→04	BR9ES	5722			BR9EIX	3981	0.7
	Formula 125 LC (Liquid Cooled)	97→04	BR7HS	4122			BR7HIX	7067	0.6
	Jetset 125 4T	01→04	CR7E	4578			CR7EIX	7385	0.6
	Millennium (4-Stroke Liquid Cooled)	00→04	CR8E	1275			CR8EIX	4218	0.7
	Torpedo T125 4T		CR8E	1275			CR8EIX	4218	0.6
150	Jetset 150 4T	01→04	CR7E	4578			CR7EIX	7385	0.6
	Millennium 150	00→04	CR7E	4578			CR7EIX	7385	0.6
176	Dragster D180LC (2-Stroke Liquid Cooled)	99→04	BR9ES	5722			BR9EIX	3981	0.7
250	Jupiter 250	01→04	DR8EA	7162	DR8EVX	6354	DR8EIX	6681	0.7

JAWA-CZ									
50	Jawa Economy, Jive, Jazz		B6HS	4510			BR6HIX	3419	0.5
	MJ50, Korado Basic/K'start, Lux		B6HS	4510			BR6HIX	3419	0.5
125	CZ125	→84	B8HS	5510			BR8HIX	7001	0.5
	CZ125 Oilmaster	84→	B8HS	5510			BR8HIX	7001	0.5
175	CZ175	→84	B8HS	5510			BR8HIX	7001	0.5
	CZ175	84→	B8HS	5510			BR8HIX	7001	0.5
180	CZ180	84→	B8HS	5510			BR8HIX	7001	0.5
250	CZ250 Single/DeLuxe	→84	B8HS	5510			BR8HIX	7001	0.5
	CZ250	84→	B8HS	5510			BR8HIX	7001	0.5
350	CZ350	→84	B8HS	5510			BR8HIX	7001	0.5
	CZ350 Classic/Style/Sport/Chopper	84→	B8HS	5510			BR8HIX	7001	0.7
500	Jawa 500R	86→90	D8EA	2120	DR8EVX	6354	DR8EIX	6681	0.5

JIALING									
50	CJ50F/K		BPR6HS	7022			BPR6HIX	4085	0.7
	JD 50, JL 50	97→00	BPR6HSA	4632			BPR6HIX	4085	0.6
	JH 50	95→	C7HSA	4629			CR7HIX	7544	0.7
	LX50		BPR6HSA	4632			BPR6HIX	4085	0.7
	QM 50		BPR4HS	7823					0.7
	TA 55		BPR6HSA	4632			BPR6HIX	4085	0.7
70	CJ70		CR7HSA	4549			CR7HIX	7544	0.7
	JD 70, JH 70	94→00	C7HSA	4629			CR7HIX	7544	0.7
90	JH 90	94→96	C6HSA	3228			CR6HIX	7274	0.7
	K 90		BP7HS	5111			BPR7HIX	5944	0.7
100	K100		BP7HS	5111			BPR7HIX	5944	0.7
	QM100		BP7HS	5111			BPR7HIX	5944	0.7
125	JH125	94→02	DR8ES-L	2923	DR8EVX	6354	DR8EIX	6681	0.7
	Sanyang Duke 125		DPR7EA-9	5129			DPR7EIX-9	7803	0.9
	Sanyang Wolf 125		DR8ES-L	2923	DR8EVX	6354	DR8EIX	6681	0.7



CC	MODEL	DATE	STANDARD COPPER CORE	STOCK NUMBER	PLATINUM OR GOLD PALLADIUM	STOCK NUMBER	IRIDIUM	STOCK NUMBER	GAP MM
JIANSHE									
125	JS125Y Tiger	03→	DR8ES	5423			DR9EIX	4772	0.7

JINLUN									
50	JL50QT	04→	CR7HSA	4549			CR7HIX	7544	0.7
125	Hornet 125	08→	CR7HSA	4549			CR7HIX	7544	0.7
	JL125-11/13	06→	CR7HSA	4549			CR7HIX	7544	0.7
	JL125-C/Y	05→	CR7HSA	4549			CR7HIX	7544	0.7
	JL125T	05→	CR7HSA	4549			CR7HIX	7544	0.7
150	JL150	05→	D8EA	2120	DR8EVX	6354	DR8EIX	6681	0.7
250	JL250	06→	CR7HSA	4549			CR7HIX	7544	0.7

JONWAY									
50	Madness 50		C7HSA	4629			CR7HIX	7544	0.7
125	Adventure	09→	C7HSA	4629			CR7HIX	7544	0.7

KAWASAKI									
50	AE50 A1/A2, AR50 A1/C1-C10	81→97	B6ES	7310					0.7
60	KX60 A, B1-B13	83→97	B9EG	3530	B9EGV	5827	BR9EIX	3981	0.7
	KX60 B14-B17	98→01	BR9EG	3230			BR9EIX	3981	0.5
65	KX65 A1-A6	00→05	BR10EG	3830			BR10EIX	6801	0.7
80	AE80 A, AR80 A	81→82	BP8ES	2912			BPR8EIX	6684	0.7
	AE80 B, AR80 C1-C8	83→93	BPR8ES	3923			BPR8EIX	6684	0.7
	KX80 A, B	79→80	B8EG	3430	B8EGV	5627	BR8EIX	5044	0.5
	KX80 C-R1	81→91	BR9EG	3230			BR9EIX	3981	0.5
	KX80 R2-R7	92→97	R6252K-105	2741					0.7
	KX80 W1, W2	98→99	R6252K-105	2741					0.7
	KX80 W3	00→	R6252K-105	2741					0.7
85	KX85 A1-A5/B1-B5	01→05	R6252K-105	2741					0.7
	KX85 A6F/B6F	06→13	R6252K-105	2741					0.7
	KX85 II	14→	R6252K-105	2741					0.7
90	KM90A	73→80	B7HS	5110			BR7HIX	7067	0.5
100	G7TA	73→76	B8HS	5510			BR8HIX	7001	0.6
	KC100 C1-C4	79→86	B8ES	2411			BR8EIX	5044	0.7
	KE100 A7-A10, B1-B15	78→99	BR8ES	5422			BR8EIX	5044	0.7
	KH100 A1-A4 (KH100EL)	77→81	B8ES	2411			BR8EIX	5044	0.7
	KH100 G2-G8 (KH100EX)	81→93	B8ES	2411			BR8EIX	5044	0.7
	KM100 A1-A4, A6-A7	76→81	B7HS	5110			BR7HIX	7067	0.6
	KX100 A1-A2, B1	89→91	BR9EG	3230			BR9EIX	3981	0.5
	KX100 B2-B7	92→97	R6252K-105	2741					0.7
	KX100 C1-C3	98→00	R6252K-105	2741					0.7
	KX100 D1-D5, D6F-D9F	01→09	R6252K-105	2741					0.7
110	KLX110 A1/A2	02→	CR6HSA	2983			CR6HIX	7274	0.6
	KSR110	03→	CR6HSA	2983			CR6HIX	7274	0.6
125	AR125 A1, A1A, A1B, A2-A7, B1-B8	82→94	BR8ES	5422			BR8EIX	5044	0.7
	BN125 A1-A8 (Eliminator)	98→05	CR7E	4578			CR7EIX	7385	0.7
	BN125 A6F-A7F, A9F (Eliminator)	06→	CR7E	4578			CR7EIX	7385	0.7
	D-Tracker	10→	CR7HSA	4549			CR7HIX	7544	0.7
	KDX125 A1/A2, B1/B2	90→94	BR8ES	5422			BR8EIX	5044	0.7
	KE125 A3-A6	76→79	B8HS	5510			BR8HIX	7001	0.6
	KE125 A7-A8	80→81	B8ES	2411			BR8EIX	5044	0.7
	KE125 A9-A12	82→87	B9ES	2611			BR9EIX	3981	0.7
	KH125 A/L/K/K4/K7-K9	82→99	BR8ES	5422			BR8EIX	5044	0.7
	KLX125	10→	CR7HSA	4549			CR7HIX	7544	0.7
	KMX125 A1-A5/B1-B12	86→02	BR8ES	5422			BR8EIX	5044	0.7
	KX125 A1-A5	74→79	B9EG	3530	B9EGV	5827	BR9EIX	3981	0.6
	KX125 A6-A7, B1	80→82					BR9EIX	3981	0.6
	KX125 B2, D-G, H1	83→90	BR10EG	3830			BR10EIX	6801	0.6
	KX125 H2	1991	R6252E-105	2396					0.6
	KX125 J1, J2	92→93	R6252K-105	2741					0.7
	KX125 K1-K5, L1-L4	94→02					BR9EIX	3981	0.6



CC	MODEL	DATE	STANDARD COPPER CORE	STOCK NUMBER	PLATINUM OR GOLD PALLADIUM	STOCK NUMBER	IRIDIUM	STOCK NUMBER	GAP MM
KAWASAKI (CONTINUED)									
125	KX125 M1	2003					BR9EIX	3981	0.6
	KX125 M2-M3	04→05			R6918B-9	2954			0.8
	KX125 M6, M7F	06→					BR9ECMIX	2707	0.8
	SC125 (J125)	16→	CR7E	4578			CR7EIX	7385	0.7
175	KDX175 A1-A2	80→81	B9ES	2611			BR9EIX	3981	0.7
	KDX175 A3, B1-B2	82→83					BR9EIX	3981	0.6
	KE175 B1-B3	76→79	B9HS	5810			BR9HIX	5687	0.6
	KE175 D1	1979	B9ES	2611			BR9EIX	3981	0.6
	KE175 D2-D5	80→84	B7ES	1111			BR7EIX	6664	0.7
200	KDX200 E1-E6	89→94	BR9ES	5722			BR9EIX	3981	0.7
	KDX200 H1-H10	95→04	BR8ES	5422			BR8EIX	5044	0.7
	KMX200 A2-A4	88→90	BR8ES	5422			BR8EIX	5044	0.7
	Z200 A1-A4	77→81	B7ES	1111			BR7EIX	6664	0.7
	Z200 A5-A6	82→88	BR7ES	5122			BR7EIX	6664	0.7
220	KDX220 A4-A7	97→00	BR8ES	5422			BR8EIX	5044	0.7
	KDX220 A8-A12	01→05	BR8ES	5422			BR8EIX	5044	0.7
250	A1 (Samurai)	67→71	B8HS	5510			BR8HIX	7001	0.6
	BR250 (Z250SL)	15→					MR8CI-8	96973	0.8
	BX250 (Ninja 250SL)	15→					MR8CI-8	96973	0.8
	EL250 D4-D5	93→96	CR8HSA	2086	CR8HVX	7236	CR8HIX	7669	0.7
	EL250 F2 (EL252)	97→99	CR8HSA	2086	CR8HVX	7236	CR8HIX	7669	0.7
	ER250 B1-B3 (Z250T)	83→90	DPR9EA-9	5329			DPR9EIX-9	5545	0.9
	EX250 F2-F8 (GPX250), H1-H2 (ZZ-R250)	88→92	CR8HSA	2086	CR8HVX	7236	CR8HIX	7669	0.6
	EX250 F9 (GPX250R)	1995	CR8HSA	2086	CR8HVX	7236	CR8HIX	7669	0.6
	EX250 K8F (Ninja 250R)	08→12	CR8E	1275			CR8EIX	4218	0.7
	F11	72→75	B9HS	5810			BR9HIX	5687	0.6
	KDX250 B2-B4, C1-C3	82→85	BR8ES	5422			BR8EIX	5044	0.7
	KDX250 D1-D5, E1-E2	91→95	BR9ES	5722			BR9EIX	3981	0.7
	KH250 B1-B5	76→82	B9HS	5810			BR9HIX	5687	0.6
	KL250 A1-A4	77→83	B7ES	1111			BR7EIX	6664	0.7
	KL250 C1-C2	83→85	BR8ES	5422			BR8EIX	5044	0.7
	KL250 D2-D11, D16 (KLR250)	85→01	DPR9EA-9	5329			DPR9EIX-9	5545	0.9
	KLX250 B1-B2	81→82	BR7ES	5122			BR7EIX	6664	0.7
	KLX250 D1-D2	93→94	CR8E	1275			CR8EIX	4218	0.7
	KLX250 G1	94→97	CR8E	1275			CR8EIX	4218	0.7
	KLX250 T9F, TAF	09→	CR8E	1275			CR8EIX	4218	0.7
	KR250 B1, B2, B3 (KR-1)	89→90	BR9ES	5722			BR9EIX	3981	0.7
	KR250 C2, C3 (KR-1S)	90→92	BR10ES	4832			BR10EIX	6801	0.7
	KX250 A1-A7, B1	75→82	BR9EG	3230			BR9EIX	3981	0.7
	KX250 C1-C2, D1	83→85	BR8EG	3130			BR8EIX	5044	0.6
	KX250 D2, E1, F1, G1, H1-H2	86→91	BR9EG	3230			BR9EIX	3981	0.7
	KX250 J1-J2	92→93	R6252E-9	4741					0.6
	KX250 K1-K5, L1-L4	94→02					BR8EIX	5044	0.6
	KX250 M1-M2	03→04					BR8EIX	5044	0.6
	KX250 R1, R6F-R7F	05→07					BR8ECMIX	3520	0.6
	KX250 N1-N2 (KX250F 4-Stroke)	04→05	CR8EB	7784			CR8EIX	4218	0.7
	KX250 T6F-XAF (KX250F 4-Stroke)	06→10	CR8E	1275			CR8EIX	4218	0.7
	KX250 YBF Fi (KX250F 4-Stroke)	11→	CPR8EB-9	6607					0.9
	S1 A, B, C (Mach 1)	72→75	B9HS	5810			BR9HIX	5687	0.6
Z250 A1-A3, B1-B2	79→82	DR8ES	5423			DR9EIX	4772	0.6	
Z250 C1-C2, G1-G2 (Z50LTD)	80→83	B7ES	1111			BR7EIX	6664	0.7	
300	KLE300 (Versys-X 300)	17→	CR8E	1275			CR8EIX	4218	0.7
	KLX300 A2-A8, B1-B3	97→03	CR8E	1275			CR8EIX	4218	0.7
	ER300 (Z300)	15→	CR8E	1275			CR8EIX	4218	0.7
	EX300 (Ninja 300)	13→	CR8E	1275			CR8EIX	4218	0.7
	SC300 (J300)	14→	CR7E	4578			CR7EIX	7385	0.7
305	EX305 A1 (GPz305)	83→84	DPR9EA-9	5329			DPR9EIX-9	5545	0.9
	EX305 B2-B10 (GPz305)	84→96	DPR9EA-9	5329			DPR9EIX-9	5545	0.9
350	A7 (Avenger)	67→71	B9HS	5810			BR9HIX	5687	0.6
	S2, S2A (Mach II)	72→73	B9HS	5810			BR9HIX	5687	0.6
400	KH400 A3-A5	76→78	B8HS	5510			BR8HIX	7001	0.7
	KX400 A	75→76	B9EG	3530	B9EGV	5827	BR9EIX	3981	0.6
	S3, S3A	74→75	B9HS	5810			BR9HIX	5687	0.7



CC	MODEL	DATE	STANDARD COPPER CORE	STOCK NUMBER	PLATINUM OR GOLD PALLADIUM	STOCK NUMBER	IRIDIUM	STOCK NUMBER	GAP MM
KAWASAKI (CONTINUED)									
400	Z400 D3-D4	76→77	B8ES	2411			BR8EIX	5044	0.7
	Z400 B1-B2, G1	78→79	B7ES	1111			BR7EIX	6664	0.7
	Z400 J1-J2	80→81	D8EA	2120	DR8EVX	6354	DR8EIX	6681	0.7
	Z400 J3	82→83	DR8EA	7162	DR8EVX	6354	DR8EIX	6681	0.7
	ZR400 A (A400F)	83→84	DR8ES	5423			DR9EIX	4772	0.7
	ZR400 B1	84→85	DPR9EA-9	5329			DPR9EIX-9	5545	0.9
	ZX400 C2-C3	85→87	DPR9EA-9	5329			DPR9EIX-9	5545	0.9
	ZX400 L1-L9 (ZXR400)	91→99	CR9EK	4548			CR9EIX	3521	0.7
420	KX420A	80→81	B9EG	3530	B9EGV	5827	BR9EIX	3981	0.6
440	Z440 A2-A3 (LTD), C1-C2	80→82	BR7ES	5122			BR7EIX	6664	0.6
	Z440 H1-H2, D4-D6 (LTD Belt Drive)	82→84	BR7ES	5122			BR7EIX	6664	0.6
450	EN450 A1-A5 (LTD Belt Drive)	85→90	DR8ES	5423			DR9EIX	4772	0.7
	KLX450 A8F	07→	CPR8EB-9	6607					0.9
	KX450 D6F	06→08	CPR8EB-9	6607					0.9
	KX450F	09→	CPR8EB-9	6607					0.9
500	EN500 A1-A3	90→93	DR8ES	5423			DR9EIX	4772	0.7
	EN500 B2	94→	DR9EA	3437			DR9EIX	4772	0.7
	EN500 C1	96→99	DR9EA	3437			DR9EIX	4772	0.7
	ER500 A1-A4, C3, C4P (ER-5)	97→	DR9EA	3437			DR9EIX	4772	0.7
	ER500 C5P (ER-5)	06→07	DR9EA	3437			DR9EIX	4772	0.7
	EX500 A1-A6 (GPz500S)	87→93	DR8ES	5423			DR9EIX	4772	0.7
	EX500 D1-D3, D5-D7 (GPz500S)	94→00	DR9EA	3437			DR9EIX	4772	0.7
	EX500 E10	02→04	DR9EA	3437			DR9EIX	4772	0.7
	H1 (Mach III), H1A-H1F, KH500A8	69→76	B9HS-10	3626			BR9HIX	5687	1.0
	KLE500 A1-A13	91→03	DR9EA	3437			DR9EIX	4772	0.7
	KLE500 B6F, B7F	05→	DR9EA	3437			DR9EIX	4772	0.7
	KX500 A1-A2	83→84	BR9EG	3230			BR9EIX	3981	0.6
	KX500 B, C, D, E1-E16	85→04	BR8EG	3130			BR8EIX	5044	0.5
	Z500 B1-B4	79→82	D8EA	2120	DR8EVX	6354	DR8EIX	6681	0.7
550	Z550 A1-A3	80→83	DR8ES	5423			DR9EIX	4772	0.7
	Z550 C1-C2 (LTD)	81→83	D8EA	2120	DR8EVX	6354	DR8EIX	6681	0.7
	Z550 D1 (GPz550)	81→82	D8EA	2120	DR8EVX	6354	DR8EIX	6681	0.7
	Z550 G1-G9 (GT550)	83→01	DR8ES	5423			DR9EIX	4772	0.7
	Z550 H1-H2 (GPz550), ZR550 A1 (Z550F)	82→85	DR8ES	5423			DR9EIX	4772	0.7
	ZR550 B2-B6 (Zephyr 550)	91→98	DR9EA	3437			DR9EIX	4772	0.6
	ZX550 A2-A4 (GPz550)	85→91	DPR9EA-9	5329			DPR9EIX-9	5545	0.9
	600	KL600 A1	84→85	D8EA	2120	DR8EVX	6354	DR8EIX	6681
KL600 B1-B2, B4		85→90	DPR8EA-9	4929			DPR8EIX-9	2202	0.9
ZL600 B1 (Eliminator 600)		95→97	DR9EA	3437			DR9EIX	4772	0.7
ZX600 A1-A5 (GPZ600R)		85→90	DR9EA	3437			DR9EIX	4772	0.7
ZX600 C1-C7 (GPX600R)		88→96	DR9EA	3437			DR9EIX	4772	0.7
ZX600 D1-D3, E1-E12 (ZZ-R600)		90→04	CR9E	6263			CR9EIX	3521	0.7
ZX600 E6F (ZZR600)		06→	CR9E	6263			CR9EIX	3521	0.7
ZX600 F1-F3 (Ninja ZX6R)		95→97	CR9E	6263			CR9EIX	3521	0.7
ZX600 G1-G2 (ZX-6R)		98→99	CR9E	6263			CR9EIX	3521	0.7
ZX600 J1-J2 (ZX-6R)		00→01	CR9E	6263			CR9EIX	3521	0.7
ZX600 K1H-N6F (Ninja ZX-6RR)		03→06	CR9E	6263			CR9EIX	3521	0.7
ZX600 P7F-P8F, R9F-RCF (Ninja ZX-6R)		07→	CR9E	6263			CR9EIX	3521	0.7
636		ZX636 A1P, B1H-B2H (Ninja ZX-6R)	02→04	CR9E	6263			CR9EIX	3521
	ZX636 C1H-C6F (Ninja ZX-6R)	05→06	CR9E	6263			CR9EIX	3521	0.7
	ZX636 (Ninja ZX-6R 636)	13→	CR9E	6263			CR9EIX	3521	0.7
650	EJ650 A1-A2, C1, C5, C6P (W650)	99→05	CR8E	1275			CR8EIX	4218	0.7
	EN650 (Vulcan S)	15→					CR9EIA-9	6289	0.9
	ER650 A7F-C9F (ER-6n)	06→16					CR9EIA-9	6289	0.9
	ER650 HHF (Z650)	17→					CR9EIA-9	6289	0.9
	EX650 A7F-A8F, B7F-B8F (ER-6f)	06→16					CR9EIA-9	6289	0.9
	EX650 KHf (Ninja 650)	17→					CR9EIA-9	6289	0.9
	KL650 A1-A3	87→90	DPR8EA-9	4929			DPR8EIX-9	2202	0.9
	KL650 B1-B3 (Tengai)	89→92	DPR8EA-9	4929			DPR8EIX-9	2202	0.9
	KL650 C1-C5 (KLR 650)	94→02	DPR8EA-9	4929			DPR8EIX-9	2202	0.9
	KLE650 A7F-FGF (Versys)	07→					CR9EIA-9	6289	0.9
	KLX650 C1-C2	93→96	DPR8EA-9	4929			DPR8EIX-9	2202	0.9
	W650 (EJ650 A1-A2, C1, C5, C6P)	99→05	CR8E	1275			CR8EIX	4218	0.7



CC	MODEL	DATE	STANDARD COPPER CORE	STOCK NUMBER	PLATINUM OR GOLD PALLADIUM	STOCK NUMBER	IRIDIUM	STOCK NUMBER	GAP MM
KAWASAKI (CONTINUED)									
650	Z650 B1-B3, C2-C3 (Custom)	77→79	B7ES	1111			BR7EIX	6664	0.7
	Z650 D2-D3 (SR)	79→82	B7ES	1111			BR7EIX	6664	0.7
	Z650 F1-F4	82→84	B7ES	1111			BR7EIX	6664	0.7
750	H2 (Mach IV), H2A, H2B, H2C	72→75	B9HS-10	3626			BR9HIX	5687	1.0
	VN750 A2-A10 (Vulcan)	86→94	DPR7EA-9	5129			DPR7EIX-9	7803	0.9
	Z750 B1-B2	76→77	B8ES	2411			BR8EIX	5044	0.7
	Z750 E1, H1-H2 (LTD), L1-L4	80→85	BR8ES	5422			BR8EIX	5044	0.7
	Z750 P1-P5 (GT750)	82→92	BR8ES	5422			BR8EIX	5044	0.7
	Z750 P7-P9 (GT750)	91→96	DR8ES	5423			DR9EIX	4772	0.6
	Z750 R1 (GP)	82→83	BR8ES	5422			BR8EIX	5044	0.7
	Z750 Y1 (LTD Twin)	82→83	BPR6ES	7822			BPR6EIX	6637	0.7
	ZR750 C1-C4 (Zephyr 750)	91→94	DR8ES	5423			DR9EIX	4772	0.6
	ZR750 C5 (Zephyr 750)	1995	DR9EA	3437			DR9EIX	4772	0.7
	ZR750 D1 (Zephyr 750)	96→99	DR9EA	3437			DR9EIX	4772	0.7
	ZR750 F1-F5 (ZR-7), H1-H3 (ZR-7S)	05/99→03	DR9EA	3437			DR9EIX	4772	0.7
	ZR750 J1H (Z750)	04→	CR9EK	4548			CR9EIX	3521	0.7
	ZR750 J6F (Z750)	05→	CR9EK	4548			CR9EIX	3521	0.7
	ZR750 K6F (Z750s)	06→	CR9EK	4548			CR9EIX	3521	0.7
	ZR750 L7F, L8F, L9F, LAF, M7F, M8F (Z750)	03/07→10	CR9EK	4548			CR9EIX	3521	0.7
	ZR750 N (Z750R)	11→	CR9EK	4548			CR9EIX	3521	0.7
	ZX750 A1-A3, A5 (GPz750)	83→89	BR9ES	5722			BR9EIX	3981	0.7
	ZX750 E1-E2 (Turbo)	83→87					BR9EIX	3981	0.6
	ZX750 F1-F5 (GPX750R)	87→91	DR8ES	5423			DR9EIX	4772	0.7
	ZX750 G2-G3 (GPz750R)	84→87	D8EA	2120	DR8EVX	6354	DR8EIX	6681	0.7
	ZX750 H1-H2 (ZXR750)	89→91	CR9E	6263			CR9EIX	3521	0.7
	ZX750 J1-J2 (ZXR750)	91→93	CR9E	6263			CR9EIX	3521	0.7
	ZX750 M1-M2 (ZXR750R)	92→94	CR9E	6263			CR9EIX	3521	0.7
	ZX750 L3 (ZXR750)	94→96	CR9E	6263			CR9EIX	3521	0.7
	ZX750 N1 (Ninja ZX-7RR)	96→99	CR9E	6263			CR9EIX	3521	0.7
ZX750 P1-P7 (Ninja ZX-7R)	96→03	CR9E	6263			CR9EIX	3521	0.7	
773	EJ800A (W800)	11→	CR8E	1275			CR8EIX	4218	0.7
800	VN800 A1-3	95→98	CR7E	4578			CR7EIX	7385	0.7
	VN800 B2-B8 (Classic), C1-C2, E1-E2 (Drifter)	96→	CR7E	4578			CR7EIX	7385	0.8
	Z800 (Incl. Sugomi)	14→	CR9EK	4548			CR9EIX	3521	0.7
	Z800E	14→	CR9EK	4548			CR9EIX	3521	0.7
900	VN900 A6F, B7F (Classic)	06→	CPR7EA-9	3901			CR7EIX	7385	0.9
	VN900 C7F (Custom)	07→	CPR7EA-9	3901			CR7EIX	7385	0.9
	Z1, Z1A, Z1B, Z900 A4	73→76	B8ES	2411			BR8EIX	5044	0.7
	ZX900 A1-A8 (GPZ900R)	84→96	DR8ES	5423			DR9EIX	4772	0.7
	ZX900 B1-B4 (ZX9R Ninja)	94→98	CR9EK	4548			CR9EIX	3521	0.7
	ZX900 C1-C2, E1-E2 (ZX9R Ninja)	98→	CR9EK	4548			CR9EIX	3521	0.7
	ZX900 F1/H/P, F2/H/P (ZX9R)	02→04	CR9EK	4548			CR9EIX	3521	0.7
950	Z900 (Incl. Performance)	17→					CR9EIA-9	6289	0.9
1000	KLV1000	05→	CR8EK	3478			CR8EIX	4218	0.7
	Z1000 A1-A3, A4 (Mark II), D1 (Z1-R), E1-E2 (ST), H1 (Fi)	77→81	B8ES	2411			BR8EIX	5044	0.7
	Z1000 J1-J3, R1-R2, K1 (LTD)	81→84	B8ES	2411			BR8EIX	5044	0.7
	ZG1000 A1-A7 (1000GTR)	86→94	DR8ES	5423			DR9EIX	4772	0.7
	ZG1000 A9-A14 (1000GTR)	94→99	DR9EA	3437			DR9EIX	4772	0.7
	ZL1000 A1 (ZL1000)	87→90	DR8ES	5423			DR9EIX	4772	0.7
	ZR1000 A1H-A3H (Z1000)	03→05	CR9EK	4548			CR9EIX	3521	0.7
	ZR1000 A6F (Z1000)	06→07	CR9EK	4548			CR9EIX	3521	0.7
	ZR1000 B7F-B8F, C7F-C8F, DAF (Z1000)	07→09					CR9EIA-9	6289	0.9
	ZX1000 A1-A3 (GPZ1000RX)	85→89	DR8ES	5423			DR9EIX	4772	0.7
	ZX1000 B1-B3 (ZX-10)	88→91	CR9E	6263			CR9EIX	3521	0.7
	ZX1000 C1H (ZX10R)	04→					CR9EIA-9	6289	0.9
	ZX1000 D6F-D7F, E8F-JFF (Ninja ZX-10R)	06→15					CR9EIA-9	6289	0.9
	ZX1000 RGF (Ninja ZX-10R)	16→					SILMAR9B9	95399	0.9
	ZX1000NF, PF (Ninja H2, H2R)	15→					SILMAR9B9	95399	0.9
1043	KLZ1000 ACF (Versys 1000)	12→					CR9EIA-9	6289	0.9
	ZR1000 DAF-FGF (Z1000 Incl. Sugomi)	10→					CR9EIA-9	6289	0.9
	ZX1000G, H (Z1000SX, Tourer)	11→					CR9EIA-9	6289	0.9
1100	Z1100 A1-A3 (Shaft drive)	81→85	BR8ES	5422			BR8EIX	5044	0.7
	Z1100 B1-B2 (GPz1100)	81→83	BR8ES	5422			BR8EIX	5044	0.7

2 Wheel



CC	MODEL	DATE	STANDARD COPPER CORE	STOCK NUMBER	PLATINUM OR GOLD PALLADIUM	STOCK NUMBER	IRIDIUM	STOCK NUMBER	GAP MM
KAWASAKI (CONTINUED)									
1100	Z1100 R1	84→85	BR8ES	5422			BR8EIX	5044	0.7
	ZR1100 A1-A4 (Zephyr) Twin Spark	92→95	CR9E	6263			CR9EIX	3521	0.7
	ZR1100 B1 (Zephyr) Twin Spark	96→97	CR9E	6263			CR9EIX	3521	0.7
	ZR1100 C1-C4 (ZRX 1100)	97→01	CR9EK	4548			CR9EIX	3521	0.7
	ZX1100 A1-A3 (GPz1100)	83→88	BR8ES	5422			BR8EIX	5044	0.7
	ZX1100 C1-C3, D1-D9 (ZZ-R1100)	90→01	CR9E	6263			CR9EIX	3521	0.7
	ZX1100 E1-E5 (GPZ1100)	95→99	CR9EK	4548			CR9EIX	3521	0.7
ZX1100 F1 (GPZ1100 ABS)	96→98	CR9EK	4548			CR9EIX	3521	0.7	
1200	ZR1200 A1-A4H, B1-B3P (ZRX 1200)	01→05	CR9EK	4548			CR9EIX	3521	0.7
	ZR1200 A6F (ZRX1200R)	05→	CR9EK	4548			CR9EIX	3521	0.7
	ZX1200 A1-A2 (ZX-12R)	99→01			CR9EKPA	7785	CR9EIX	3521	0.8
	ZX1200 B1H-B3H (Ninja ZX-12R)	02→07			CR9EKPA	7785	CR9EIX	3521	0.8
	ZX1200-C1H/C2H (ZZ-R1200)	02→04	CR9E	6263			CR9EIX	3521	0.7
1300	Z1300 A1	78→79	BR8ES	5422			BR8EIX	5044	0.7
	Z1300 A2-A5	80→83	BPR6ES	7822			BPR6EIX	6637	0.7
	ZG1300 A1-A3 Fuel Injection	84→90	BPR6ES	7822			BPR6EIX	6637	0.7
1352	ZG1400 A8F-CCF (1400GTR)	07→					CR9EIA-9	6289	0.9
	ZX1400 A6F-D8F (ZZ-R1400)	06→11					CR9EIA-9	6289	0.9
1441	ZX1400 ECF (ZZ-R1400)	12→					CR9EIA-9	6289	0.9
1500	VN1500 B2-B6, C1-C2	88→95	DPR7EA-9	5129			DPR7EIX-9	7803	0.9
	VN1500 D1-D2 (VN1500 Classic)	96→98	DPR5EA-9	2887					0.9
	VN1500 E1-E2 (Classic)	98→99	DPR5EA-9	2887					0.8
	VN1500 G2 (Nomad)	1999	DPR5EA-9	2887					0.8
	VN1500 J1-J2 Drifter	99→00	DPR6EA-9	5531					0.9
	VN1500 L1-L4 Fi (Classic Tourer Fi)	99→03	DPR6EA-9	5531					0.9
	VN1500 N1-N3H	99→04	DPR6EA-9	5531					0.9
	VN1500 P1H-P2H (Mean Streak)	01→04	DPR6EA-9	5531					0.9
1552	VN1600 A1H-A7F Classic	03→07	DPR6EA-9	5531					0.9
	VN1600 B1H-B7F Mean Streak	04→07	DPR6EA-9	5531					0.9
	VN1600 D1H-D8F Classic Tourer	05→08	DPR6EA-9	5531					0.9
1700	VN1700 Classic, Classic Tourer, Voyager	09→					ILZKAR7B11	1654	1.1
2050	VN2000 A1H-A6F	04→					IZFR6F11	4095	1.1

KEEWAY

50	Hurricane (2-Stroke) Ø14mm Plug	08→	BPR7HS	6422			BPR7HIX	5944	0.6
	Hurricane (4-Stroke) Ø10mm Plug	08→	C7HSA	4629			CR7HIX	7544	0.7
	Matrix Sport 50	06→	BPR7HS	6422			BPR7HIX	5944	0.6
125	ARN 125	08→	DPR7EA-9	5129			DPR7EIX-9	7803	0.9
	Hacker 125	08→	DPR7EA-9	5129			DPR7EIX-9	7803	0.9
	Speed 125	08→	DPR7EA-9	5129			DPR7EIX-9	7803	0.9
	Superlight 125	08→	DPR7EA-9	5129			DPR7EIX-9	7803	0.9
250	Cruiser	06→	D7EA	7912					0.7

KENOS

125	125-12B	12/07→	CR8E	1275			CR8EIX	4218	0.7
-----	---------	--------	------	------	--	--	--------	------	-----

KREIDLER

50	Florett (RM, RMS, RMC), GS50		B7HS	5110			BR7HIX	7067	0.5
	MC-5-50		B7HS	5110			BR7HIX	7067	0.5

KSR MOTO

50	Epico 50	12→	BR8HSA	5539			BPR8HIX	6742	0.7
	Onyx 50	13→	BR8HSA	5539			BPR8HIX	6742	0.7
	Sirion 50	12→	BR8HSA	5539			BPR8HIX	6742	0.7
125	Code 125	12→	DR8EA	7162	DR8EVX	6354	DR8EIX	6681	0.6
	GSR 125	15→	DR8EA	7162	DR8EVX	6354	DR8EIX	6681	0.6
	Soho 125	12→	CR8E	1275			CR8EIX	4218	0.7
	TR 125	12→	CR8E	1275			CR8EIX	4218	0.7



CC	MODEL	DATE	STANDARD COPPER CORE	STOCK NUMBER	PLATINUM OR GOLD PALLADIUM	STOCK NUMBER	IRIDIUM	STOCK NUMBER	GAP MM
KSR MOTO (CONTINUED)									
125	TW 125	14→	DR8EA	7162	DR8EVX	6354	DR8EIX	6681	0.6
	Vertigo 125	12→	CR7HSA	4549			CR7HIX	7544	0.7
	Worx 125	12→	DR8EA	7162	DR8EVX	6354	DR8EIX	6681	0.6
	Zion 125	12→	CR8E	1275			CR8EIX	4218	0.7

KTM										
50	50 Pro-Junior, Senior (12.7mm Thread Reach)	2000	B8HS	5510			BR8HIX	7001	0.6	
	50 Adventure Mini, Junior & Senior (12.7mm Thread Reach)	→02	BR8HS	4322			BR8HIX	7001	0.6	
	50 Adventure Mini, Junior & Senior (19mm Thread Reach)	03→08	BR8ECM	3035			BR8ECMIX	3520	0.6	
	50 SX Junior/Senior LC (19mm Thread Reach)	2002	BR10EG	3830			BR10EIX	6801	0.6	
	50 SX Pro-Junior LC (Beta engine)	2003	BR8ECM	3035			BR8ECMIX	3520	0.6	
	50 SX	09→	LR8B	6208	CR8HVX	7236	CR8HIX	7669	0.6	
60	60 SX	98→				R7436-10	4900	0.6		
65	65 SX	→03	BR10EG	3830			BR10EIX	6801	0.6	
	65 SX Beta engine (19mm Thread Reach)	03→07	BR8ECM	3035			BR8ECMIX	3520	0.6	
	65 SX KTM engine (12.7mm Thread Reach)	08/08→	LR8B	6208	CR8HVX	7236	CR8HIX	7669	0.6	
80	Moto-X models with 1/2", 12.7mm Thread Reach	→85					BR8HIX	7001	0.6	
	80 MX	1986	B10EG	3630	B10EGV	5927	BR10EIX	6801	0.6	
85	85 SX	03→06					BR10ECMIX	3006	0.7	
	85 SX	07→					BR9ECMIX	2707	0.6	
125	Moto-X models with 1/2", 12.7mm Thread Reach (Not GP)	→85					BR8HIX	7001	0.6	
	125 Duke	11→	LKAR8A-9	4786			LKAR8AI-9	6706	0.9	
	125 SX	96→97			B10EGV	5927	BR10EIX	6801	0.6	
	125 EXC, EGS, SX	98→00			R6918B-8	4492			0.8	
	125 EXC, SX	01→07					BR9EIX	3981	0.6	
	125 EXC, EXC, SX, Six Days	08→					BR9ECMIX	2707	0.6	
	125 GS	1986	B10EG	3630	B10EGV	5927	BR10EIX	6801	0.6	
	125 LC/LCPA	→85	B9EG	3530	B9EGV	5827	BR9EIX	3981	0.6	
	125 MX	1986	B10EG	3630	B10EGV	5927	BR10EIX	6801	0.6	
	125 MX	87/88	B9EG	3530	B9EGV	5827	BR9EIX	3981	0.6	
	125 MX	89/90					BR10EIX	6801	0.6	
	125 SM			BR8HS	4322			BR8HIX	7001	0.6
	LC125, LC 2 125 (Duke 125)	96→98	BR9ES	5722			BR9EIX	3981	0.6	
SX 125 (2001)	01→					BR9ECMIX	2707	0.6		
144	144 SX	08→					BR9ECMIX	2707	0.6	
	150 SX	09→					BR9ECMIX	2707	0.6	
175	Moto-X models with 1/2", 12.7mm Thread Reach	→85					BR8HIX	7001	0.6	
200	200 Duke	11→	LKAR8A-9	4786			LKAR8AI-9	6706	0.9	
	200 EGS, EXC, MXC	98→	BR8EG	3130			BR8EIX	5044	0.6	
	200 EXC, SX	03→					BR9EIX	3981	0.6	
	200 EXC	06→	BR8EG	3130			BR8EIX	5044	0.6	
	200 XC, XC-W	07→	BR8EG	3130			BR8EIX	5044	0.6	
250	Moto-X models with 1/2", 12.7mm Thread Reach	→85					BR8HIX	7001	0.6	
	250 EXC (2-Stroke) Ø14mm Plug	97→02	BR8ECM	3035			BR8ECMIX	3520	0.6	
	250 EXC (2-Stroke) Ø14mm Plug	03→	BR7ES	5122			BR7EIX	6664	0.7	
	250 EXC Racing (4-Stroke) Ø10mm Plug	01→02	CR8EK	3478			CR8EIX	4218	0.7	
	250 EXC Racing (4-Stroke) Ø12mm Plug	03→06	DCPR8E*	4179			DCR8EIX	3606	0.6	
	250 EXC-F Incl. Fi (4-Stroke) Ø10mm Plug (19mm Thread Reach)	07→13	CR9EKB	2305			CR9EIX	3521	0.8	
	250 EXC-F Incl. Fi (4-Stroke) Ø10mm Plug (26.5mm Thread Reach)	14→					LMAR9AI-10	93188	1.0	
	250 GS	1986	B10EG	3630	B10EGV	5927	BR10EIX	6801	0.6	
	250 LCPA	→85	B10EG	3630	B10EGV	5927	BR10EIX	6801	0.6	
	250 MC/GS	→85	B9EG	3530	B9EGV	5827	BR9EIX	3981	0.6	
	250 MX	1986	B10EG	3630	B10EGV	5927	BR10EIX	6801	0.6	
	250 MX	87/88	B9EG	3530	B9EGV	5827	BR9EIX	3981	0.6	
	250 MX	89/90					BR9EIX	3981	0.6	
	250 SX	97→	BR8ECM	3035			BR8ECMIX	3520	0.6	
	250 SX (2-Stroke) Ø14mm Plug	03→05	BR8ECM	3035			BR8ECMIX	3520	0.6	
	250 SX	06→	BR8ECM	3035			BR8ECMIX	3520	0.6	
	250 SX-F (4-Stroke) Ø10mm Plug (19mm Thread Reach)	06→12	CR9EKB	2305			CR9EIX	3521	0.8	
	250 SX-F (4-Stroke) Ø10mm Plug (26.5mm Thread Reach)	13→					LMAR9AI-8	97225	0.8	
	Freeride 250	13→	BR7ES	5122			BR7EIX	6664	0.7	



* Please note DCPR8E 4339 has a removable terminal nut, whereas DCPR8E 4179 has a fixed terminal nut





CC	MODEL	DATE	STANDARD COPPER CORE	STOCK NUMBER	PLATINUM OR GOLD PALLADIUM	STOCK NUMBER	IRIDIUM	STOCK NUMBER	GAP MM
KTM (CONTINUED)									
300	300 EXC	97→02	BR8ECM	3035			BR8ECMIX	3520	0.6
	300 EXC	03→06	BR7ES	5122			BR7EIX	6664	0.7
	300 EXC	07→16	BR7ES	5122			BR7EIX	6664	0.7
	300 GS	1986	B10EG	3630	B10EGV	5927	BR10EIX	6801	0.6
	300 MXC	97→02	BR8ECM	3035			BR8ECMIX	3520	0.6
	300 MXC	03→	BR7ES	5122			BR7EIX	6664	0.7
	300 XC	06→	BR7ES	5122			BR7EIX	6664	0.7
350	350 EXC-F, Six Days (4-Stroke)	11→					LMAR9AI-8	97225	0.8
	350 MX	87→95	B9EG	3530	B9EGV	5827	BR9EIX	3981	0.6
	350 SX-F	10→					LMAR9AI-8	97225	0.8
	Freeride 350	12→					LMAR9AI-10	93188	1.0
380	380 EXC, 380 SX		BR8ECM	3035			BR8ECMIX	3520	0.6
390	390 GS	→85	B9EG	3530	B9EGV	5827	BR9EIX	3981	0.6
400	Moto-X models with ½", 12.7mm Thread Reach	→85	B9HS	5810			BR9HIX	5687	0.7
	400 EGS-E	97→	DR8EA	7162	DR8EVX	6354	DR8EIX	6681	0.6
	400 EXC, MXC, SX Ø10mm Plug	99→02	CR8EK	3478			CR8EIX	4218	0.7
	400 EXC Ø12mm Plug (19mm Thread Reach)	02→08	DCPR8E*	4179			DCR8EIX	3606	0.6
	400 EXC Ø12mm Plug (26.5mm Thread Reach)	09→					LKAR8AI-9	6706	0.9
	400 LSE		DR8EA	7162	DR8EVX	6354	DR8EIX	6681	0.6
	LC4 400		DR8EA	7162	DR8EVX	6354	DR8EIX	6681	0.7
420	420 AC	→85	B9EG	3530	B9EGV	5827	BR9EIX	3981	0.6
450	450 EXC Racing, SX Racing (4-Stroke)	03→	DCPR8E*	4179			DCR8EIX	3606	0.6
	450 EXC-R (26.5mm Thread Reach)	2008	LKAR8A-9	4786			LKAR8AI-9	6706	0.9
	450 EXC-R, Six Days (26.5mm Thread Reach)	09→					LKAR8AI-9	6706	0.9
	450 RALLY Replica	14→	CR9EKB	2305			CR9EIX	3521	0.8
	450 SMR Ø12mm Plug	04→07	DCPR8E*	4179			DCR8EIX	3606	0.6
	450 SMR Ø10mm Plug	08→	CR9EKB	2305			CR9EIX	3521	0.8
	450 SX-F	07→12	CR9EKB	2305			CR9EIX	3521	0.8
	450 SX-F	13→				LKAR8AI-9	6706	0.9	
480	505 SX-F	07→	CR9EKB	2305			CR9EIX	3521	0.8
495	495 AC	→85	B9EG	3530	B9EGV	5827	BR9EIX	3981	0.6
500	500 MX, 500 MXC	1986	B9EG	3530	B9EGV	5827	BR9EIX	3981	0.6
	500 MX	87/88	B9EG	3530	B9EGV	5827	BR9EIX	3981	0.6
	500 MX	89/90					BR9EIX	3981	0.6
510	500 EXC, Six Days	12→					LKAR8AI-9	6706	0.9
	530 EXC-R	07→08	LKAR8A-9	4786			LKAR8AI-9	6706	0.9
	530 EXC-R	09→11					LKAR8AI-9	6706	0.9
520	520 EXC, MXC, SX	99→	CR8EK	3478			CR8EIX	4218	0.7
525	525 EXC Racing, MXC, SX	03→	DCPR8E*	4179			DCR8EIX	3606	0.6
560	560-4S	→85	D8EA	2120	DR8EVX	6354	DR8EIX	6681	0.6
600	600-C4S	→85	D8EA	2120	DR8EVX	6354	DR8EIX	6681	0.6
	600 4S	86→88	D8EA	2120	DR8EVX	6354	DR8EIX	6681	0.6
	600 EGS-E		DR8EA	7162	DR8EVX	6354	DR8EIX	6681	0.6
	LC4 640		DR8EA	7162	DR8EVX	6354	DR8EIX	6681	0.7
620	620 Adventure, 620LSE, 620 Duke	96→	DR8EA	7162	DR8EVX	6354	DR8EIX	6681	0.6
625	625 Enduro, Super Moto	02→	DPR8EA-9	4929			DPR8EIX-9	2202	0.9
	625 SMC	03→06	DCPR8E*	4179			DCR8EIX	3606	0.6
	625 SXC	03→	DCPR8E*	4179			DCR8EIX	3606	0.6
	640 LC4, Duke, Duke II	03→	DCPR8E*	4179			DCR8EIX	3606	0.6
	640 Super Moto	02→	DCPR8E8	4179			DCR8EIX	3606	0.6
	R640 Adventure	03→	DCPR8E*	4179			DCR8EIX	3606	0.6
654	660 SMC	03→06	DCPR8E*	4179			DCR8EIX	3606	0.6
	690 Duke	07→11					LKAR8AI-9	6706	0.9
	690 Enduro R	09→11					LKAR8AI-9	6706	0.9
	690 LC4 Supermoto / Prestige	07→					LKAR8AI-9	6706	0.9
	690 SMC	08→11					LKAR8AI-9	6706	0.9
	690 SM R	08→11					LKAR8AI-9	6706	0.9
690	690 Duke R	10→11					LKAR8AI-9	6706	0.9
	690 Duke, R (Twin spark)	12→		LMAR7A-9	4908				0.9
							LKAR8BI9	1553	0.9
	690 Enduro R	12→13					LKAR8AI-9	6706	0.9



* Please note DCPR8E 4339 has a removable terminal nut, whereas DCPR8E 4179 has a fixed terminal nut





CC	MODEL	DATE	STANDARD COPPER CORE	STOCK NUMBER	PLATINUM OR GOLD PALLADIUM	STOCK NUMBER	IRIDIUM	STOCK NUMBER	GAP MM
KTM (CONTINUED)									
690	690 Enduro R (Twin spark)	Ø10mm Plug Ø12mm Plug	14→	LMAR7A-9	4908		LKAR8BI9	1553	0.9
	690 SMC R		12→13				LKAR8AI-9	6706	0.9
	690 SMC R (Twin spark)	Ø10mm Plug Ø12mm Plug	14→	LMAR7A-9	4908		LKAR8BI9	1553	0.9
950	950 Adventure / Rally		03→05	CR8EK	3478		CR8EIX	4218	0.7
	950 Supermoto / Super Enduro R		05→08	CR8EK	3478		CR8EIX	4218	0.7
1000	990 Adventure / Supermoto		06→08	DCPR8E*	4339		DCPR8EIX	6546	0.9
	990 Adventure / R		09→12				LKAR8BI9	1553	0.9
	990 SM-R		09→11				KR8DI	4742	0.8
	990 SM-R		12→13				LKAR8BI9	1553	0.9
	990 SM-T		09→10				KR8DI	4742	0.8
	990 SM-T ABS		11→13				LKAR8BI9	1553	0.9
	990 Super Duke		04→06	DCPR8E*	4339		DCPR8EIX	6546	0.9
	990 Super Duke (19mm Thread Reach)		07→11				KR8DI	4742	0.8
	990 Super Duke R (19mm Thread Reach)		07				KR8DI	4742	0.8
	990 Super Duke R (26.5mm Thread Reach)		08→11				LKAR8AI-9	6706	0.9
	990 Super Duke R (19mm Thread Reach)		12→13				KR8DI	4742	0.8
1148	1190 RC8		08→10				LKAR9BI9	6205	0.9
1195	1190 Adventure, R (Twin spark)	Ø10mm Plug Ø12mm Plug	13→	LMAR7A-9	4908		LKAR9BI9	6205	0.9
	RC8R (Incl. Track model)		09→11				LKAR9BI9	6205	0.9
	RC8R (Incl. Track model) Twin spark	Ø10mm Plug Ø12mm Plug	11→	LMAR7A-9	4908		LKAR9BI9	6205	0.9
1301	1290 Super Duke R (Twin spark)	Ø10mm Plug Ø12mm Plug	14→	LMAR7A-9	4908		LKAR9BI9	6205	0.9

KYMCO										
50	Agility 50		05→	CR7HSA	4549		CR7HIX	7544	0.7	
	Cobra 50			BR8HSA	5539		BPR8HIX	6742	0.6	
	Fever 50			BR8HSA	5539		BPR8HIX	6742	0.6	
	Filly 50		98→	CR7HSA	4549		CR7HIX	7544	0.7	
	Filly LX 50		99→	CR7HSA	4549		CR7HIX	7544	0.7	
	Like 50 (2-Stroke)		10→	BR8HSA	5539		BPR8HIX	6742	0.6	
	People 50		04→06	BR8HSA	5539		BPR8HIX	6742	0.6	
	Scout 50		97→	BR8HSA	5539		BPR8HIX	6742	0.6	
	Spacer 50			BR8HSA	5539		BPR8HIX	6742	0.6	
	Super 8 50 (2-Stroke) Ø14mm Plug		07→	BR8HSA	5539		BPR8HIX	6742	0.6	
	Super 8 50 (4-Stroke) Ø10mm Plug		11→	CR7HSA	4549		CR7HIX	7544	0.7	
	Super 9 50 (Liquid Cooled)		99→	BR8HSA	5539		BPR8HIX	6742	0.6	
	Super 9 50 (Air Cooled)		01→	BR8HSA	5539		BPR8HIX	6742	0.6	
	Super 9 50 (Air Cooled) (Euro 2)		01→	BR8HSA	5539		BPR8HIX	6742	0.6	
	Vitality 50 (2-Stroke)		04→	BR8HSA	5539		BPR8HIX	6742	0.6	
	Vitality 50 (4-Stroke)			CR7HSA	4549		CR7HIX	7544	0.7	
	Yup 50		00→	BR8HSA	5539		BPR8HIX	6742	0.6	
	ZX 50			BR8HSA	5539		BPR8HIX	6742	0.6	
	100	Cobra 100		99→03	BR6HSA	4296		BPR6HIX	4085	0.7
	125	Agility 125		05→	CR7HSA	4549		CR7HIX	7544	0.7
CK125			05→	DR8EA	7162	DR8EVX	6354	DR8EIX	6681	0.7
Cruiser 125			03→	CR8E	1275		CR8EIX	4218	0.7	
Downtown 125i			13→	CR7E	4578		CR7EIX	7385	0.7	
Ego 125				DPR7EA-9	5129		DPR7EIX-9	7803	0.9	
Heroism 125				C7HSA	4629		CR7HIX	7544	0.7	
Hipster 125 (2 Valve)			01→	DR8EA	7162	DR8EVX	6354	DR8EIX	6681	0.7
Hipster 125 (4 Valve)				CR8E	1275		CR8EIX	4218	0.7	
Hipster 125 (4 Valve) (Euro 2)				CR8E	1275		CR8EIX	4218	0.7	
Miller 125 (Grand Dink)			03→	DPR7EA-9	5129		DPR7EIX-9	7803	0.9	
Movie XL125			02→	CR7HSA	4549		CR7HIX	7544	0.7	
People One 125i			13→	CR7E	4578		CR7EIX	7385	0.7	
People S 125 (Euro 3)			05→	CR7HSA	4549		CR7HIX	7544	0.7	



* Please note DCPR8E 4339 has a removable terminal nut, whereas DCPR8E 4179 has a fixed terminal nut



2 Wheel



CC	MODEL	DATE	STANDARD COPPER CORE	STOCK NUMBER	PLATINUM OR GOLD PALLADIUM	STOCK NUMBER	IRIDIUM	STOCK NUMBER	GAP MM
KYMCO (CONTINUED)									
125	Pulsar 125		DR8EA	7162	DR8EVX	6354	DR8EIX	6681	0.7
	Sector 125		DR8EA	7162	DR8EVX	6354	DR8EIX	6681	0.7
	Spacer 125 (Liquid Cooled)		DPR7EA-9	5129			DPR7EIX-9	7803	0.9
	Stryker 125		DR8EA	7162	DR8EVX	6354	DR8EIX	6681	0.7
	Super 8 125 Ø12mm Plug	07→	DPR7EA-9	5129			DPR7EIX-9	7803	0.9
	Super 8 125 (4-Stroke) Ø10mm Plug		CR7HSA	4549			CR7HIX	7544	0.7
	Vivio 125		CR7HSA	4549			CR7HIX	7544	0.7
	Yager GT125	08→	DPR7EA-9	5129			DPR7EIX-9	7803	0.9
	Zing 125	97→	DR8EA	7162	DR8EVX	6354	DR8EIX	6681	0.7
163	Like 200i (4-Stroke)	11→	CR7HSA	4549			CR7HIX	7544	0.7
200	Yager 200i		DPR6EA-9	5531					0.9
250	Dink 250		DPR7EA-9	5129			DPR7EIX-9	7803	0.9
	Ego 250		DPR7EA-9	5129			DPR7EIX-9	7803	0.9
	Grand Dink 250	01→	DPR7EA-9	5129			DPR7EIX-9	7803	0.9
	People 250	05→	DPR7EA-9	5129			DPR7EIX-9	7803	0.9
	Venox 250	03→	CR8E	1275			CR8EIX	4218	0.7
	Xciting 250 (Carb)	→08	DPR7EA-9	5129			DPR7EIX-9	7803	0.9
	Xciting 250i	06→08	DPR6EA-9	5531					0.9
	Xciting 250i, 250Ri	08→	DPR6EA-9	5531					0.9
	300	Downtown 300i	11→	CR7E	4578			CR7EIX	7385
400	Xciting 400i	13→	CR7E	4578			CR7EIX	7385	0.7
500	Xciting 500 (Carb)	05→06	CR8E	1275			CR8EIX	4218	0.7
	Xciting 500i	07→	CR7E	4578			CR7EIX	7385	0.7

LAMBRETTA

125	LI 125, SL125, SI 125		B7ES	1111			BR7EIX	6664	0.5
150	GP 150	76→98	B7ES	1111			BR7EIX	6664	0.5
200	GP 200, SXJet 200, SX200, Links 200	78→	B7ES	1111			BR7EIX	6664	0.5

LAVERDA

500	500 Alpino S, Montjuic	78→84	D9EA	2420			DR9EIX	4772	0.7
650	650 i.e, Sport, Formula, Ghost, Diamante	94→98	DCPR9E	2641			DCPR9EIX	2316	0.6
	650, GT, GTL, American Eagle	94→98	B9ES	2611			BR9EIX	3981	0.7
668	668, Ghost, Ghost Strike	96→98	DCPR9E	2641			DCPR9EIX	2316	0.6
750	750, GT, GTL, American Eagle		B8ES	2411			BR8EIX	5044	0.7
	750 S, Ghost 750 Strike, Diamante 750, 750 S Formula	97→02	DCPR9E	2641			DCPR9EIX	2316	0.6
	SF, SFL, SF2, SF3, SFC Twins	68→78	B8ES	2411			BR8EIX	5044	0.7
1000	1000EC, 3C(E), 1000 2CL, Jota, Jarama	76→82	B8ES	2411			BR8EIX	5044	0.7
	RGA, RGS	82→87	B8ES	2411			BR8EIX	5044	0.7
	SFC	85→89	B9ES	2611			BR9EIX	3981	0.7
1200	1200, T, Mirage, TS, Jota American	78→83	B8ES	2411			BR8EIX	5044	0.7

LEM

50	LX 1,2,3,4 Super & Sport 50 (12.7mm Thread Reach)		B7HS	5110			BR7HIX	7067	0.6
	LX4 (19mm Thread Reach)		BR9ES	5722			BR9EIX	3981	0.7
	S6 Racer (Reed valve engine) 50				B105EGV	2171			0.6

LEXMOTO

50	Flash ZN50QT-15A		C7HSA	4629			CR7HIX	7544	0.7
	LSM 50	12→	BR8ES	5422			BR8EIX	5044	0.6
	Milano FT50QT-27	07/15→	C7HSA	4629			CR7HIX	7544	0.7
	Tornado SB50QT-16(B08)		C7HSA	4629			CR7HIX	7544	0.7
	Tommy ZN50QT-A		C7HSA	4629			CR7HIX	7544	0.7
	Tommy II ZN50QT-E		C7HSA	4629			CR7HIX	7544	0.7
125	Adrenaline XFLM125GY-2B	05/15→	CR8E	1275			CR8EIX	4218	0.7
	Arizona ZS125-30		D8EA	2120			DR8EIX	6681	0.7
	Arrow HT125-4F		D8EA	2120			DR8EIX	6681	0.7
	Firenze ZN125T-F		C7HSA	4629			CR7HIX	7544	0.7
	FMS125 ZN125T-7H	15→	CR7HSA	4549			CR7HIX	7544	0.6



CC	MODEL	DATE	STANDARD COPPER CORE	STOCK NUMBER	PLATINUM OR GOLD PALLADIUM	STOCK NUMBER	IRIDIUM	STOCK NUMBER	GAP MM
LEXMOTO (CONTINUED)									
125	FMX125 WY125T-108	15→	CR7HSA	4549			CR7HIX	7544	0.6
	Gladiator SB125T-23B		C7HSA	4629			CR7HIX	7544	0.7
	Ranger ZS125-50		D8EA	2120			DR8EIX	6681	0.7
	Street DFE125-8A		CR7E	4578			CR7EIX	7385	0.7
	Tommy ZN125T-E		C7HSA	4629			CR7HIX	7544	0.7
	Tornado SB125T-21(B08)		C7HSA	4629			CR7HIX	7544	0.7
	Valencia	12→	C7HSA	4629			CR7HIX	7544	0.7
	Valiant XF125R	07/15→	CR8E	1275			CR8EIX	4218	0.7
	Venom SK125-22	03/15→	CPR6EA-9	6899					0.9
	Vixen HT125-8		D8EA	2120			DR8EIX	6681	0.7
	XTR KS125-23		D8EA	2120			DR8EIX	6681	0.7
	XTR S KS125-24		D8EA	2120			DR8EIX	6681	0.7
	Zoom II SB125T-21(B10)		C7HSA	4629			CR7HIX	7544	0.7

LIFAN									
50	Aero 50 (LF50QT-26A) 2-Stroke		BPR7HS	6422			BPR7HIX	5944	0.6
	Aero 50 (LF50QT-26) 4-Stroke		CR7HSA	4549			CR7HIX	7544	0.6
	Echo (LF50QT-8D)		C7HSA	4629			CR7HIX	7544	0.6
	Jet 50		C7HSA	4629			CR7HIX	7544	0.7
110	Wacky 110		C7HSA	4629			CR7HIX	7544	0.7
125	Aero 125		C7HSA	4629			CR7HIX	7544	0.7
	Beat 125 (LF125-9A)		C7HSA	4629			CR7HIX	7544	0.6
	Blaze (LF125-30)		D8EA	2120			DR8EIX	6681	0.7
	Earth Dragon		D8EA	2120			DR8EIX	6681	0.7
	Mirage 125 (LF125-J)		D8EA	2120	DR8EVX	6354	DR8EIX	6681	0.6
	Samurai (LF125-30)		D8EA	2120			DR8EIX	6681	0.7
Sprint (LF125-30)		D8EA	2120			DR8EIX	6681	0.7	

LML									
125	Star CVT Automatica 4-Stroke	06/13→	CR8EH-9	5666			CR8EHIX-9	3797	0.7
	Star Deluxe 2-Stroke		BP8HS	2630			BPR8HIX	6742	0.7
	Star Deluxe 4-Stroke	11/09→	CR8EH-9	5666			CR8EHIX-9	3797	0.7
	Via Toscana 2-Stroke	09→	BP8HS	2630			BPR8HIX	6742	0.7
150	Star Deluxe 2-Stroke		BPR6ES	7822			BPR6EIX	6637	0.7
	Star Deluxe 4-Stroke	11/09→	CR8EH-9	5666			CR8EHIX-9	3797	0.7
200	Star Deluxe 4-Stroke	11→	CR8EH-9	5666			CR8EHIX-9	3797	0.7

MAGNI									
1000	Australia		D9EA	2420			DR9EIX	4772	0.7
	Sfida 1000		BP6ES	7811			BPR6EIX	6637	0.5
	Sfida Ottovolvole						DR9EIX	4772	0.6

MAICO									
Various	Moto-X models with 1/2", 12.7mm Thread Reach						BR9HIX	5687	0.5
	Moto-X models with 3/4", 19mm Thread Reach		B9EG	3530	B9EGV	5827	BR9EIX	3981	0.5

MALAGUTI									
50	Ciak 50	00→02	BR8HS	4322			BR8HIX	7001	0.6
	Crosser	99→01	BPR6HS	7022			BPR6HIX	4085	0.5
	Drakon 50	04→06	BR9ES	5722			BR9EIX	3981	0.7
	F-10 Jetline	96→06	BR7HS	4122			BR7HIX	7067	0.5
	F-12 Dragon	96→	BR7HS	4122			BR7HIX	7067	0.5
	F-12 Phantom	96→06	BR7HS	4122			BR7HIX	7067	0.5
	F-15 Firefox	97→	BR8HS	4322			BR8HIX	7001	0.5
	F-15 GSE Replica		BR8HS	4322			BR8HIX	7001	0.5
	Foggy Replica		BR8HS	4322			BR8HIX	7001	0.5
	RCX10 (50cc Franco Morini)		B7HS	5110			BR7HIX	7067	0.5
	RCX12 (50cc Franco Morini)		B7HS	5110			BR7HIX	7067	0.5



CC	MODEL	DATE	STANDARD COPPER CORE	STOCK NUMBER	PLATINUM OR GOLD PALLADIUM	STOCK NUMBER	IRIDIUM	STOCK NUMBER	GAP MM
MALAGUTI (CONTINUED)									
50	Wild Attack F12		BR8HS	4322			BR8HIX	7001	0.5
	XSM 50	04→06	BR9ES	5722			BR9EIX	3981	0.7
	XTM 50	04→06	BR9ES	5722			BR9EIX	3981	0.7
	Yesterday 50	98→00	BR8HS	4322			BR8HIX	7001	0.5
70	F-69 Phantom	97→99	BR7HS	4122			BR7HIX	7067	0.5
100	Ciak 100	00→04	BR8HS	4322			BR8HIX	7001	0.6
	F-12 Phantom 100TD	99→03	BR7HS	4122			BR7HIX	7067	0.6
125	Ciak 125	01→04	BR7HS	4122			BR7HIX	7067	0.6
	Madison 125	99→04	CR8E	1275			CR8EIX	4218	0.7
	X3M Motard 125	10→	CR7HSA	4549			CR7HIX	7544	0.6
150	F-18 Warrior	01→	DPR7EA-9	5129			DPR7EIX-9	7803	0.9
250	Madison 250cc	99→04	DPR9EA-9	5329			DPR9EIX-9	5545	0.9
400	Madison K400	02→04	CR9E	6263			CR9EIX	3521	0.7
500	Spidermax 500 GT	04→06	CR7EKB	4455			CR7EIX	7385	0.8

MBK									
50	Booster 50 NG	99→02	BR8HS	4322			BR8HIX	7001	0.5
	Flipper 50		BR8HS	4322			BR8HIX	7001	0.5
	Mach-G (Air Cooled)		BR8HS	4322			BR8HIX	7001	0.6
	Mach-G (Liquid Cooled)		BR8HS	4322			BR8HIX	7001	0.6
	Nitro 50	99→	BR8HS	4322			BR8HIX	7001	0.5
	Nitro-Jaguar F1		BR8HS	4322			BR8HIX	7001	0.5
	Ovetto 50	99→	BR7HS	4122			BR7HIX	7067	0.6
	Stunt 50	00→	BR9HS	4522			BR9HIX	5687	0.6
	X-Limit 50 Supermotard, Enduro	05→	BR9ES	5722			BR9EIX	3981	0.7
	X-Power 50	03→	BR9ES	5722			BR9EIX	3981	0.7
100	Nitro 100	01→	BR8HS	4322			BR8HIX	7001	0.5
	Ovetto 100	01→	BR8HS	4322			BR8HIX	7001	0.6
125	Doodo 125	01→	CR8E	1275			CR8EIX	4218	0.7
	Flame X 125		CR7E	4578			CR7EIX	7385	0.8
	Skycruiser 125	06→	CPR9EA-9	2308			CR9EIX	3521	0.9
	Skyliner 125	01→	CR8E	1275			CR8EIX	4218	0.7
	Thunder 125	01→	CR8E	1275			CR8EIX	4218	0.7
260	Kilibre 300	03→	DR8EA	7162	DR8EVX	6354	DR8EIX	6681	0.7

MONTESA									
123	Cota 123		B6ES	7310					0.5
125	MH123 (Honda engine)		BR7ES	5122			BR7EIX	6664	0.7
175	Cota 172		B6ES	7310					0.5
	Cota 200		B6ES	7310					0.5
200	MH200 (Honda engine)		BPR7ES	2023			BPR7EIX	4055	0.5
250	310		BPR7ES	2023			BPR7EIX	4055	0.5
	4Ride	16→	CR6EH-9	2688			CR6EIA-9	7967	0.9
	Cota 242		BP6ES	7811			BPR6EIX	6637	0.5
	Cota 247		B6HS	4510			BR6HIX	3419	0.6
	Cota 248		BP5ES	6511			BPR5EIX	6597	0.5
	Cota 315 (Honda engine)	97→99	BR6ES	4922					0.6
	Cota 4T (Honda engine)	05→07	CR6EH-9	2688			CR6EIA-9	7967	0.9
260	304, 307, 309		BPR5ES	7422			BPR5EIX	6597	0.5
	311		BPR5ES	7422			BPR5EIX	6597	0.5
	314		BR6ES	4922					0.6
	Cota 4RT	08→14	CR6EH-9	2688			CR6EIA-9	7967	0.9
289	Cota 300RR	15→	CR6EH-9	2688			CR6EIA-9	7967	0.9
310	348		BPR5ES	7422			BPR5EIX	6597	0.5
330	330		BPR5ES	7422			BPR5EIX	6597	0.5
350	335		BPR5ES	7422			BPR5EIX	6597	0.5
	Cota 349		BP5ES	6511			BPR5EIX	6597	0.5



CC	MODEL	DATE	STANDARD COPPER CORE	STOCK NUMBER	PLATINUM OR GOLD PALLADIUM	STOCK NUMBER	IRIDIUM	STOCK NUMBER	GAP MM	
MOTO GUZZI										
350	V35	84→87	B8ES	2411			BR8EIX	5044	0.5	
500	V50	79→86	B8ES	2411			BR8EIX	5044	0.5	
650	V65	84→93	B8ES	2411			BR8EIX	5044	0.5	
750	Breva 750 i.e.	04→09	BR8ES	5422			BR8EIX	5044	0.6	
	Nevada 750 NT/Nevada club (with Digiplex)	90→03	BR8ES	5422			BR8EIX	5044	0.6	
	V7 Classic	07/08→12	BR8ES	5422			BR8EIX	5044	0.6	
	V7 Café Classic	09→13	BR8ES	5422			BR8EIX	5044	0.6	
	V7 Café Racer Ø14mm Plug	11/10→11	BR8ES	5422			BR8EIX	5044	0.6	
	V7 Café Racer Ø10mm Plug	12→13	CPR8EB-9	6607					0.9	
	V7 Special, Stone Ø10mm Plug	12→13	CPR8EB-9	6607					0.9	
	V7 II Racer, Special, Stone, Stornello	14→	CPR8EB-9	6607					0.9	
	V7 III Anniversario, Racer, Special, Stone	17→	CPR8EB-9	6607					0.9	
750	V75	86→88	B8ES	2411			BR8EIX	5044	0.5	
850	Le Mans II & III	78→82	BP6ES	7811			BPR6EIX	6637	0.7	
	Series V850	82→85	BP6ES	7811			BPR6EIX	6637	0.7	
	V9 Bobber	16→	CPR8EB-9	6607					0.9	
	V9 Roamer	16→	CPR8EB-9	6607					0.9	
940	Bellagio 940 (Twin Spark)	Ø10mm Plug Ø14mm Plug	07→13	BPR6ES	7822	PMR8B	6378	BPR6EIX	6637	0.7
1000	California III I.E.	87→93	BP7ES	2412			BPR7EIX	4055	0.5	
	California III with Digiplex	91→93	BP7ES	2412			BPR7EIX	4055	0.5	
	Centaurio V10, Centaurio Sport/GT	97→00	DR9EA	3437			DR9EIX	4772	0.6	
	Daytona 1000	92→98	D9EA	2420			DR9EIX	4772	0.7	
	Daytona 1000 RS	96→00	DR9EA	3437			DR9EIX	4772	0.6	
	Le Mans IV 1000	82→03/85	BP7ES	2412			BPR7EIX	4055	0.5	
	Le Mans V (Le Mans 1000)	85→94	BP7ES	2412			BPR7EIX	4055	0.5	
	Quota 1000	92→97	BP7ES	2412			BPR7EIX	4055	0.5	
	Series 1000	84→93	BP6ES	7811			BPR6EIX	6637	0.7	
1100	Breva V 1100 (Twin Spark)	Ø10mm Plug Ø14mm Plug	05→07	BPR6ES	7822	PMR8B	6378	BPR6EIX	6637	0.7
	California 1100 Carb		94→96	BPR6ES	7822			BPR6EIX	6637	0.6
	California 1100 Inj (Inc. EV, Jackal, Special, Stone & Touring)		94→12	BPR6ES	7822			BPR6EIX	6637	0.7
	California Vintage (Twin Spark)	Ø10mm Plug Ø14mm Plug	06→10	BPR6ES	7822	PMR8B	6378	BPR6EIX	6637	0.7
	Griso 1100 (Twin Spark)	Ø10mm Plug Ø14mm Plug	05→07	BPR6ES	7822	PMR8B	6378	BPR6EIX	6637	0.7
	Quota 1100 ES		98→01	BPR6ES	7822			BPR6EIX	6637	0.5
	Sport 1100 (Carb)		94→08/96	BP6ES	7811			BPR6EIX	6637	0.7
	Sport 1100 (Injection)		96→99	BPR6ES	7822			BPR6EIX	6637	0.6
	V11 (Twin Spark)	Ø10mm Plug Ø14mm Plug	2005	BPR6ES	7822	PMR8B	6378	BPR6EIX	6637	0.7
	V11 1100cc		01→05	BPR6ES	7822			BPR6EIX	6637	0.6
	V11 Le Mans		03→05	BPR6ES	7822			BPR6EIX	6637	0.6
	1150	Breva V 1200 (Twin Spark)	Ø10mm Plug Ø14mm Plug	08→11	BPR6ES	7822	PMR8B	6378	BPR6EIX	6637
Griso 8V			08→13			PMR8B	6378			0.7
Griso 8V SE			09→13			PMR8B	6378			0.7
Griso			14→16	CR8EKB	4374			CR8EIX	4218	0.7
Norge 1200 (Twin Spark)		Ø10mm Plug Ø14mm Plug	06→08	BPR6ES	7822	PMR8B	6378	BPR6EIX	6637	0.7
Norge 1200 GT 8V			09→15	CR8EKB	4374			CR8EIX	4218	0.7
Sport 1200 (Twin Spark)		Ø10mm Plug Ø14mm Plug	07→08	BPR6ES	7822	PMR8B	6378	BPR6EIX	6637	0.7
Sport 1200 4V			09→13			PMR8B	6378			0.7
Stelvio 1200 4V			08→10			PMR8B	6378			0.7
Stelvio 1200 8V			11→16	CR8EKB	4374			CR8EIX	4218	0.7
Stelvio 1200 TT (NTX)			09→10			PMR8B	6378			0.7
Stelvio 1200 8V NTX			11→16	CR8EKB	4374			CR8EIX	4218	0.7
1225	MGS-01 Corsa	05→07					DCR9EIX	6650	0.6	
1380	Audace (Twin Spark)	15→	LMAR8F-9	90894					0.9	
	California (Twin Spark)	13→	LMAR8F-9	90894					0.9	
	Eldorado (Twin Spark)	15→	LMAR8F-9	90894					0.9	
	MGX-21 (Twin Spark)	17→	LMAR8F-9	90894					0.9	

2 Wheel



CC	MODEL	DATE	STANDARD COPPER CORE	STOCK NUMBER	PLATINUM OR GOLD PALLADIUM	STOCK NUMBER	IRIDIUM	STOCK NUMBER	GAP MM
MOTO MORINI									
250	250, Sport	80→85	BP7ES	2412			BPR7EIX	4055	0.7
350	350 3½ Sport/Strada	74→84	BP7ES	2412			BPR7EIX	4055	0.7
	Kanguro 350	82→87	BP7ES	2412			BPR7EIX	4055	0.7
500	Excaliber 500/501	86→93	BP8ES	2912			BPR8EIX	6684	0.5
	Maestro	81→	BP7ES	2412			BPR7EIX	4055	0.7
	Sahara 500	81→89	BP7ES	2412			BPR7EIX	4055	0.7
1187	9½	06→	CR9E	6263			CR9EIX	3521	0.7
	Corsaro	06→	CR9E	6263			CR9EIX	3521	0.7

MOTO ROMA									
50	Bee 50		BPR7HS	6422			BPR7HIX	5944	0.6
	GoGo 50	02→	BPR7HS	6422			BPR7HIX	5944	0.6
	Grand Prix 50		BPR7HS	6422			BPR7HIX	5944	0.6
	MRX1		B8HS	5510			BR8HIX	7001	0.6
	MRX2		B8HS	5510			BR8HIX	7001	0.6
	MRX2 Sprint	02→	B7HS	5110			BR7HIX	7067	0.6
	MRX3	02→	B6HS	4510			BR6HIX	3419	0.6
	MRX3 Sprint	02→	B7HS	5110			BR7HIX	7067	0.6
	MRX4	03→	BR10ES	4832			BR10EIX	6801	0.7
	Roadrunner 50		BP7HS	5111			BPR7HIX	5944	0.6
	RT 50 (2-Stroke)	02→	BPR7HS	6422			BPR7HIX	5944	0.6
	Scrambler 50		BPR7HS	6422			BPR7HIX	5944	0.6
	Stinger, Stinger II		BPR7HS	6422			BPR7HIX	5944	0.6
	Wasp		BPR7HS	6422			BPR7HIX	5944	0.6
Wasp II		BPR7HS	6422			BPR7HIX	5944	0.6	
90	RT 90 (4-Stroke)	02→	BPR7HS	6422			BPR7HIX	5944	0.6
100	Grand Prix 100		BPR7HS	6422			BPR7HIX	5944	0.6
	Roadrunner 100		BPR7HS	6422			BPR7HIX	5944	0.6
110	GoGo 110	02→	CR7HS	7223			CR7HIX	7544	0.6
125	Grand Prix 125		CR7HS	7223			CR7HIX	7544	0.6
	MRX125	02→03	D8EA	2120	DR8EVX	6354	DR8EIX	6681	0.6
	MRX125B	04→05	CR7HSA	4549			CR7HIX	7544	0.6
	Road Runner 125	02→	C7HSA	4629			CR7HIX	7544	0.6
	SK125	10→	DR8EA	7162	DR8EVX	6354	DR8EIX	6681	0.6
	SMX125		CR7HSA	4549			CR7HIX	7544	0.6
	Virage 125		D8EA	2120	DR8EVX	6354	DR8EIX	6681	0.6

MOTOBECANE									
50	All Models		B5HS	4210					0.4

MOTORHISPANIA									
50	Furia 50, Furia Cross (½", 12.7mm Thread Reach)		BPR7HS	6422			BPR7HIX	5944	0.6
	Furia 50, Furia Cross (¾", 19mm Thread Reach)	99→	BR9ES	5722			BR9EIX	3981	0.6
	RX50	00→	BR9ES	5722			BR9EIX	3981	0.6
	RYZ 50 Cross, Supermoto	02→	BR9ES	5722			BR9EIX	3981	0.6
125	Duna SM125	07→	CR6HSA	2983			CR6HIX	7274	0.7
	Duna SX125	07→	CR6HSA	2983			CR6HIX	7274	0.7
	MH7	10→	CR6HSA	2983			CR6HIX	7274	0.7
	RYZ 125 (Yamaha engine)	05→	CR7HSA	4549			CR7HIX	7544	0.6

MS									
50	Sprite		BP6ES	7811			BPR6EIX	6637	0.7
	Steward		BP6ES	7811			BPR6EIX	6637	0.7



CC	MODEL	DATE	STANDARD COPPER CORE	STOCK NUMBER	PLATINUM OR GOLD PALLADIUM	STOCK NUMBER	IRIDIUM	STOCK NUMBER	GAP MM
MV AGUSTA									
675	Brutale 675 Trepistone	02/12→	CR9EKB	2305			CR9EIX	3521	0.8
	F3 (Incl. Serie Oro)	11/11→	CR9EKB	2305			CR9EIX	3521	0.8
750	Brutale S	02→06	CR9EKB	2305			CR9EIX	3521	0.8
	F4, F4S 1+1, F4 SPR	99→04	CR9EKB	2305			CR9EIX	3521	0.8
	F4 Senna	02→04	CR9EKB	2305			CR9EIX	3521	0.8
	F4 all models, track/race use only.	99→04	R0045J-10	7400					1.1
800	Brutale 800	13→					CR9EIB-9	92579	0.9
	Dragster 800	14→					CR9EIB-9	92579	0.9
	F3	13→					CR9EIB-9	92579	0.9
	Rivale 800	13→					CR9EIB-9	92579	0.9
	Turismo Veloce 800	14→					CR9EIB-9	92579	0.9
910	Brutale 910, 910 R, 910 S	05→08	CR9EKB	2305			CR9EIX	3521	0.8
921	Brutale 920	04/11→	CR9EB	6955			CR9EIX	3521	0.7
982	Brutale 989 R	08→09	CR9EB	6955			CR9EIX	3521	0.7
1000	Brutale 990 R	09→12	CR9EB	6955			CR9EIX	3521	0.7
	F4 1000 S	04→09	CR9EKB	2305			CR9EIX	3521	0.8
	F4 1000 R (Incl. Senna)	06→09	CR9EB	6955			CR9EIX	3521	0.7
	F4 AGO	04→05	CR9EB	6955			CR9EIX	3521	0.7
	F4 R 312	07→08	CR9EB	6955			CR9EIX	3521	0.7
	F4	10→	CR9EB	6955			CR9EIX	3521	0.7
	F4 R	12→	CR9EB	6955			CR9EIX	3521	0.7
	F4 RR	11→	CR9EB	6955			CR9EIX	3521	0.7
	F4 all models, track/race use only.	04→	R0045J-10	7400					1.1
1078	Brutale 1078 RR	08→	CR9EB	6955			CR9EIX	3521	0.7
	Brutale 1090 R	12→	CR9EB	6955			CR9EIX	3521	0.7
	Brutale 1090 RR	10→	CR9EB	6955			CR9EIX	3521	0.7
	F4 RR 312	08→09	CR9EB	6955			CR9EIX	3521	0.7

MZ									
50	Moskito 50		BR7HS	4122			BR7HIX	7067	0.7
	Moskito SX 50		BR7HS	4122			BR7HIX	7067	0.9
125	ETZ 125	86→99	B8HS	5510			BR8HIX	7001	0.6
	Moskito 125		C7HSA	4629			CR7HIX	7544	0.6
	RT/SX/SM 125		CR8E	1275			CR8EIX	4218	0.7
	Saxon Sportstar 125		B8HS	5510			BR8HIX	7001	0.7
	TS125	76→86	B8HS	5510			BR8HIX	7001	0.6
150	ETZ 150	86→95	B8HS	5510			BR8HIX	7001	0.6
	TS150	75→86	B8HS	5510			BR8HIX	7001	0.6
250	ETZ 250/251	81→97	B8HS	5510			BR8HIX	7001	0.6
	TS250-1	76→83	B8HS	5510			BR8HIX	7001	0.6
300	ETZ 300/301 Series	87→97	B8HS	5510			BR8HIX	7001	0.6
500	MZ500, 500R	92→96	D8EA	2120	DR8EVX	6354	DR8EIX	6681	0.7
	Saxon (494cc Rotax engine) Country, Silver Star, Tour	93→98	D8EA	2120	DR8EVX	6354	DR8EIX	6681	0.7
650	Baghira, Black Panther, Mastiff, Supermoto	98→	DPR8EA-9	4929			DPR8EIX-9	2202	0.9
659	Skorpion 659 Replica, Sport, Tour, Traveller	94→	DPR8EA-9	4929			DPR8EIX-9	2202	0.9
	Skorpion Cup 659cc		DPR9EA-9	5329			DPR9EIX-9	5545	0.9
1000	1000S, SF, ST	04→	BCPR6ET	2197			BKR6EIX	6418	0.8

NEVAL									
650	Dnepr Classic, Roadster, Phoenix, Soviet, Soviet Knight	78→	B7HS	5110			BR7HIX	7067	0.5
	Ural 650cc	85→	B6HS	4510			BR6HIX	3419	0.6

NIPPONIA									
50	Neon	12→	BPR7HS	6422			BPR7HIX	5944	0.6
125	Brio	12→	CR7HSA	4549			CR7HIX	7544	0.6
	Dion	12→	CR7HSA	4549			CR7HIX	7544	0.6
	Miro	12→	CR7HSA	4549			CR7HIX	7544	0.6



CC	MODEL	DATE	STANDARD COPPER CORE	STOCK NUMBER	PLATINUM OR GOLD PALLADIUM	STOCK NUMBER	IRIDIUM	STOCK NUMBER	GAP MM
NORTON									
750	Atlas	62→68	BP8ES	2912			BPR8EIX	6684	0.5
	Commando	67→73	BP7ES	2412			BPR7EIX	4055	0.6
850	Commando	73→78	BP7ES	2412			BPR7EIX	4055	0.6
961	Commando SE	10→	CR9EB	6955			CR9EIX	3521	0.8
	Commando Café Racer	11→	CR9EB	6955			CR9EIX	3521	0.8
	Commando Sport	10→	CR9EB	6955			CR9EIX	3521	0.8
Rotary	F1, Commander	88→93	C8E	7471			CR8EIX	4218	0.6

OSSA									
272	TR280i	11→	BPR5ES	7422			BPR5EIX	6597	0.5

PEUGEOT									
50	Buxy / Buxy RS 50 (Air Cooled)	95→97	B7HS	5110			BR7HIX	7067	0.6
	Django 50	15→	BR7HS	4122			BR7HIX	7067	0.6
	Elyseo 50 (Air Cooled)	98→	BR7HS	4122			BR7HIX	7067	0.6
	Elystar 50P	02→05	CPR8E	7411			CR8EIX	4218	0.8
	Jet Force 50	03→	CPR8E	7411			CR8EIX	4218	0.8
	Jet Force C-Tech	06→	CR7EB	4663			CR7EIX	7385	0.6
	Jet Force TSDI	05→	CR7EKA	1462			CR7EIX	7385	0.7
	Looxor 50	01→04	BR7HS	4122			BR7HIX	7067	0.6
	Looxor 50 TSDI Inj. (2-Stroke)	02→	CPR8E	7411			CR8EIX	4218	0.8
	Ludix 50 Blaster, Elegance, Snake Ø14mm Plug	04→07	BR7HS	4122			BR7HIX	7067	0.6
	Ludix Blaster Ø10mm Plug	08→	CR7EB	4663			CR7EIX	7385	0.6
	Ludix Blaster RS12 Ø10mm Plug	06→	CR7EB	4663			CR7EIX	7385	0.6
	Metal-X	02→	BR7HS	4122			BR7HIX	7067	0.6
	Speedake 50 (Air Cooled)	95→97	BR7HS	4122			BR7HIX	7067	0.6
	Speedfight 50 (All models Air Cooled)	96→00	BR7HS	4122			BR7HIX	7067	0.6
	Speedfight 50 LCD/P (Liquid Cooled)	96→00	BR7HS	4122			BR7HIX	7067	0.6
	Speedfight 2 50 (Air Cooled)	00→	BR7HS	4122			BR7HIX	7067	0.6
	Speedfight 2 50 (Liquid Cooled)	01→	BR7HS	4122			BR7HIX	7067	0.6
	Speedfight 2 Motorsport 50 LC	07→	BR7HS	4122			BR7HIX	7067	0.6
	Speedfight 3 Air (Air Cooled)	09→	BR7HS	4122			BR7HIX	7067	0.6
	Speedfight 3 Darkside, Iceblade, Liquid, Team (Liquid Cooled)	09→14	CR7EB	4663			CR7EIX	7385	0.6
	Squab (Air Cooled)	96→97	BR7HS	4122			BR7HIX	7067	0.6
	TKR 50	02→	BR7HS	4122			BR7HIX	7067	0.6
	TKR 50 307 WRC	05→	BR7HS	4122			BR7HIX	7067	0.6
	Trekker 50 Road, Off Road	97→04	BR7HS	4122			BR7HIX	7067	0.6
	Tweet 50	12→	CR6HSA	2983			CR6HIX	7274	0.7
	Vivacity 50, Vivacity 50P	99→10	BR7HS	4122			BR7HIX	7067	0.6
	Vivacity 50 Sportline	00→10	BR7HS	4122			BR7HIX	7067	0.6
	Vivacity 3 Sixties	11→	CR6HSA	2983			CR6HIX	7274	0.7
	V-Clic	07→	CR7HSA	4549			CR7HIX	7544	0.6
	XPS 50 Enduro, Trail, Supermotard 50	03→	BR9ES	5722			BR9EIX	3981	0.7
	XR6 50	03→	BR9ES	5722			BR9EIX	3981	0.7
	Zenith 50 L, M, LS, N	95→00	BR7HS	4122			BR7HIX	7067	0.6
100	Elyseo 100	98→	BR8ES	5422			BR8EIX	5044	0.6
	Looxor 100	01→04	BR8ES	5422			BR8EIX	5044	0.6
	Metal X 100	02→	BR8ES	5422			BR8EIX	5044	0.6
	Speedfight 100 (Air Cooled)	97→	BR8ES	5422			BR8EIX	5044	0.6
	Speedfight WRC 206 (Air Cooled)	01→	BR8ES	5422			BR8EIX	5044	0.6
	Speedfight 2	00→08	BR8ES	5422			BR8EIX	5044	0.6
	Trekker 100 (Air Cooled)	97→00	BR8ES	5422			BR8EIX	5044	0.6
	Vivacity 100, Vivacity 100 Sportline	99→08	BR8ES	5422			BR8EIX	5044	0.6
125	Citystar	11→	CR8EB	7784			CR8EIX	4218	0.8
	Django 125	15→	CR7HSA	4549			CR7HIX	7544	0.7
	Elyseo 125 (Liquid Cooled)	99→	CR7E	4578			CR7EIX	7385	0.6
	Elystar 125	02→05	CR7EB	4663			CR7EIX	7385	0.6
	Elystar 125 Injection	05→11	CR7EB	4663			CR7EIX	7385	0.6
	Geopolis Executive 125	07→	CR9EB	6955			CR9EIX	3521	0.6
	Jet Force F.I.	03→	CR7EB	4663			CR7EIX	7385	0.6
	Jet Force EFI Compressor	05→	CR8EK	3478			CR8EIX	4218	0.7



CC	MODEL	DATE	STANDARD COPPER CORE	STOCK NUMBER	PLATINUM OR GOLD PALLADIUM	STOCK NUMBER	IRIDIUM	STOCK NUMBER	GAP MM
PEUGEOT (CONTINUED)									
125	Looxor 125	02→	CR7EB	4663			CR7EIX	7385	0.6
	Satelis 125	05→10	CR9EB	6955			CR9EIX	3521	0.6
	Satelis 125 Compressor	07→10	CR9EB	6955			CR9EIX	3521	0.6
	Satelis 125 Executive	06→10	CR9EB	6955			CR9EIX	3521	0.6
	Satelis 2 125	15→	CR8EB	7784			CR8EIX	4218	0.8
	Satelis LFE 125i	13→	CR8EB	7784			CR8EIX	4218	0.8
	Speedfight 3	14→	CR7HSA	4549			CR7HIX	7544	0.7
	Sum Up 125	08→	CR7HSA	4549			CR7HIX	7544	0.7
	SV125	91→94	BP6HS	4511			BPR6HIX	4085	0.6
	Tweet 125	10→	CR7HSA	4549			CR7HIX	7544	0.7
	XPS CT125	06→08	CR7HSA	4549			CR7HIX	7544	0.7
150	Django 150	15→	CR7HSA	4549			CR7HIX	7544	0.7
	Elyseo 150 (Liquid Cooled)	00→02	CR7E	4578			CR7EIX	7385	0.6
	Elystar 150	02→	CR7EB	4663			CR7EIX	7385	0.6
	Looxor 150	02→	CR7EB	4663			CR7EIX	7385	0.6
200	Citystar 200i	16→	CR8EB	7784			CR8EIX	4218	0.8
250	Geopolis Executive 250	07→	CR9EB	6955			CR9EIX	3521	0.6
	Satelis 250	07→	CR9EB	6955			CR9EIX	3521	0.6
300	Satelis 2 300	15→	CR7EKB	4455			CR7EIX	7385	0.8
400	Metropolis 400i LFE	13→	CPR9EB-9	6508			CR9EIX	3521	0.9
	Satelis 2 400	15→	CPR8EB-9	6607					0.9
	Satelis 2 400RS	15→	CPR8EB-9	6607					0.9
500	Satelis 500	08→	CR7EKB	4455			CR7EIX	7385	0.8

PGO									
50	Big Max, Galaxy 50, G-Max, Mega, Tornado	98→	BPR7HS	6422			BPR7HIX	5944	0.6
	Comet 50, PMX Sport 50, Rodoshow 50, T-Rex 50	98→	BPR7HS	6422			BPR7HIX	5944	0.6
	Libra 50	08→	BPR7HS	6422			BPR7HIX	5944	0.6
	Ligero 50	08→	BPR7HS	6422			BPR7HIX	5944	0.6
	PMX Naked 50	07→	BPR7HS	6422			BPR7HIX	5944	0.6
125	G-Max 125	05→	CR7HSA	4549			CR7HIX	7544	0.6
	Libra 125	08→	C7HSA	4629			CR7HIX	7544	0.6
	Ligero 125	08→	C7HSA	4629			CR7HIX	7544	0.6
	T-Rex 125	98→	CR7HSA	4549			CR7HIX	7544	0.6
250	G-Max 250	05→07	DPR7EA-9	5129			DPR7EIX-9	7803	0.7

PIAGGIO / VESPA									
50	50 Special	83→	B6HS	4510			BR6HIX	3419	0.5
	Fly 50 (2-Stroke)	04→	BR9ES	5722			BR9EIX	3981	0.6
	Fly 50 (4-Stroke) 2V Ø10mm Plug	06→13	CR8EB	7784			CR8EIX	4218	0.8
	Fly 50 (4-Stroke) 4V Ø8mm Plug	14→	ER9EH-6N	1673					0.6
	Free 50 (All versions)	93→97	BR9ES	5722			BR9EIX	3981	0.5
	Liberty 50 (2-Stroke)	97→	BR9ES	5722			BR9EIX	3981	0.5
	Liberty 50 (4-Stroke)	02→	CR9EB	6955			CR9EIX	3521	0.7
	NRG 50, NRG Power DD/DT Ø14mm Plug	97→	BR9ES	5722			BR9EIX	3981	0.6
	NRG mc3 Pure Jet Ø10mm Plug	02→05	CPR8E	7411			CR8EIX	4218	0.8
	NRG mc3 Pure Jet Ø10mm Plug	06→			ZMR7AP	6914			0.8
	PK50S	83→87	B6HS	4510			BR6HIX	3419	0.5
	Primavera 50	13→	BR9ES	5722			BR9EIX	3981	0.5
	Sfera 50	91→97	BR9ES	5722			BR9EIX	3981	0.5
	Typhoon 50	93→05	B9ES	2611			BR9EIX	3981	0.5
	Typhoon 50	06→15	BR9ES	5722			BR9EIX	3981	0.5
	Velofax, Quartz, Zip, Zip SP (2-Stroke)	93→	BR9ES	5722			BR9EIX	3981	0.5
	Vespa ET2 (2-Stroke)	97→05	BR9ES	5722			BR9EIX	3981	0.5
	Vespa ET4 50 (4-Stroke)	01→05	CR9EB	6955			CR9EIX	3521	0.6
	Vespa LX50 (2-Stroke)	98→05	BR9ES	5722			BR9EIX	3981	0.6
	Vespa LX50 (2-Stroke)	05→13	BR9ES	5722			BR9EIX	3981	0.6
	Vespa LX50 (4-Stroke) Ø10mm Plug	06→09	CR8EB	7784			CR8EIX	4218	0.8
	Vespa LX50 4V (4-Stroke) Ø8mm Plug	10→	ER9EH-6N	1673					0.6
	Vespa LXV 50 (2-Stroke)	06→	BR9ES	5722			BR9EIX	3981	0.6
	Vespa S 50 (2-Stroke) Ø14mm Plug	07→	BR9ES	5722			BR9EIX	3981	0.6



CC	MODEL	DATE	STANDARD COPPER CORE	STOCK NUMBER	PLATINUM OR GOLD PALLADIUM	STOCK NUMBER	IRIDIUM	STOCK NUMBER	GAP MM
PIAGGIO / VESPA (CONTINUED)									
50	Vespa S 50 (4-Stroke) Ø8mm Plug	08→	ER9EH-6N	1673					0.6
	Vespa Zafferano 50	08→09	BR9ES	5722			BR9EIX	3981	0.6
	Zip 50 (2-Stroke)	93→	BR9ES	5722			BR9EIX	3981	0.7
	Zip 50 (4-Stroke)	02→	CR8EB	7784			CR8EIX	4218	0.7
80	Sfera 80	93→98	BR9ES	5722			BR9EIX	3981	0.5
	Typhoon 80	94→00	B9ES	2611			BR9EIX	3981	0.5
100	Diesis 100	02→03	BR9ES	5722			BR9EIX	3981	0.6
	Fly 100 (4-Stroke)	08→	CR8EB	7784			CR8EIX	4218	0.7
	PK 100 S	83→93	B6HS	4510			BR6HIX	3419	0.5
	Zip 100 (4-Stroke)	06→08	CR9EB	6955			CR9EIX	3521	0.7
125	Ape		BR7HS	4122			BR7HIX	7067	0.7
	B 125 Beverly (Liquid Cooled 4-Stroke)	02→	CR8EB	7784			CR8EIX	4218	0.8
	Camaby 125	07→	CR8EB	7784			CR8EIX	4218	0.8
	Cosa, Cosa II (125)	90→95	BR9ES	5722			BR9EIX	3981	0.6
	Fly 125 (4-Stroke)	05→13	CR7EB	4663			CR7EIX	7385	0.6
	Fly 125 (4-Stroke) 3V	14→	CR8EB	7784			CR8EIX	4218	0.7
	Hexagon 125	94→98	BR9ES	5722			BR9EIX	3981	0.5
	Hexagon GTX 125	00→02	CR9EB	6955			CR9EIX	3521	0.7
	Hexagon LX 125	98→00	BR9ES	5722			BR9EIX	3981	0.6
	Liberty 125 (4-Stroke)	98→	CR9E	6263			CR9EIX	3521	0.6
	Liberty 125 Leader		CR8EB	7784			CR8EIX	4218	0.7
	MP3 125	06→	CR8EB	7784			CR8EIX	4218	0.8
	P125X		B6HS	4510			BR6HIX	3419	0.5
	Primavera & PK 125		B6HS	4510			BR6HIX	3419	0.5
	Primavera ET3		B7HS	5110			BR7HIX	7067	0.5
	Primavera 3V (4-Stroke)	13→15	CR8EB	7784			CR8EIX	4218	0.8
	Sfera 125 (4-Stroke)	96→98	CR9E	6263			CR9EIX	3521	0.6
	Skipper	93→98	B9ES	2611			BR9EIX	3981	0.5
	Skipper 125 (2-Stroke)	98→01	BR9ES	5722			BR9EIX	3981	0.5
	Skipper ST 125 (4-Stroke)	00→04	CR7EB	4663			CR7EIX	7385	0.6
	Sprint 3V	14→	CR8EB	7784			CR8EIX	4218	0.8
	Typhoon 125	95→03	B9ES	2611			BR9EIX	3981	0.5
	Typhoon 125	10→	CR7EB	4663			CR7EIX	7385	0.6
	Vespa 946	13→	CR8EB	7784			CR8EIX	4218	0.8
	Vespa ET4 125 (4-Stroke)	96→05	CR8EB	7784			CR8EIX	4218	0.8
	Vespa GT 125 Granturismo	03→07	CR8EB	7784			CR8EIX	4218	0.8
	Vespa GT V 125	06→	CR8EB	7784			CR8EIX	4218	0.8
	Vespa GTS 125	07→	CR8EB	7784			CR8EIX	4218	0.8
	Vespa GTS 125 Super i.e.	09→	CR8EKB	4374			CR8EIX	4218	0.7
	Vespa LX 125 (4-Stroke)	05→11	CR7EB	4663			CR7EIX	7385	0.6
	Vespa LX 125 3V (4-Stroke)	12→	CR8EB	7784			CR8EIX	4218	0.8
	Vespa LX V 125	06→	CR7EB	4663			CR7EIX	7385	0.6
	Vespa PX125E (Electric Start)	82→93	BR7HS	4122			BR7HIX	7067	0.5
	Vespa PX125T5, T5 Classic (2-Stroke)	85→99	B9ES	2611			BR9EIX	3981	0.5
	Vespa PX125 (2-Stroke, Euro 1)	00→08	B6HS	4510			BR6HIX	3419	0.5
	Vespa PX125 (2-Stroke, Euro 3)	11→16	BR6HS	3922			BR6HIX	3419	0.6
	Vespa S 125	07→12	CR7EB	4663			CR7EIX	7385	0.6
	Vespa Zafferano 125	08→09	CR7EB	4663			CR7EIX	7385	0.6
	X7 125	2008	CR8EB	7784			CR8EIX	4218	0.6
	X7 125	09→	CR8EKB	4374			CR8EIX	4218	0.7
X8 125	06→08	CR8EB	7784			CR8EIX	4218	0.6	
X9 125 (Piaggio 4-Stroke)	01→07	CR8EB	7784			CR8EIX	4218	0.6	
X10	14→	CR8EKB	4374			CR8EIX	4218	0.7	
Xevo 125 (Incl. Sport)	07→	CR8EB	7784			CR8EIX	4218	0.7	
Zip 125	01→04	CR7EB	4663			CR7EIX	7385	0.6	
150	Cosa 150		BR9ES	5722			BR9EIX	3981	0.6
	Vespa PX150	83→08	B6HS	4510			BR6HIX	3419	0.5
	Vespa PX150 (2-Stroke, Euro 3)	11→16	BR6HS	3922			BR6HIX	3419	0.6
180	Hexagon 180LXT	98→00	BR9ES	5722			BR9EIX	3981	0.6
190	Ape		BR7HS	4122			BR7HIX	7067	0.7
200	Beverly 200 (4-Stroke)		CR8EB	7784			CR8EIX	4218	0.8
	Cosa 200, P200E		B6ES	7310					0.5
	Cosa II 200	88→98	B7ES	1111			BR7EIX	6664	0.5



CC	MODEL	DATE	STANDARD COPPER CORE	STOCK NUMBER	PLATINUM OR GOLD PALLADIUM	STOCK NUMBER	IRIDIUM	STOCK NUMBER	GAP MM
PIAGGIO / VESPA (CONTINUED)									
200	Vespa 200 Rally	72→79	B7ES	1111			BR7EIX	6664	0.5
	Vespa GT 200 Granturismo	03→07	CR7EB	4663			CR7EIX	7385	0.6
	Vespa PX200	86→97	B7ES	1111			BR7EIX	6664	0.5
	Vespa PX200 E Disc	98→05	BR6ES	4922					0.6
	X8 200	05→	CR7EKB	4455			CR7EIX	7385	0.8
220	Ape		BR7HS	4122			BR7HIX	7067	0.7
250	Hexagon GT 250, GTX 250 (Honda 4-Stroke)	98→01	DPR6EA-9	5531					0.9
	MP3 250	06→			PMR8A	5851	CR8EIX	4218	0.6
	Super Hexagon GTX250	00→	CR9E	6263			CR9EIX	3521	0.7
	Vespa GTS 250i.e.	05→			PMR8A	5851	CR8EIX	4218	0.6
	Vespa GTV 250i.e.	06→			PMR8A	5851	CR8EIX	4218	0.6
	X7 250	08→			PMR8A	5851	CR8EIX	4218	0.6
	X8 250	06→08	CR8EB	7784			CR8EIX	4218	0.6
	X9 250cc (Honda 4-Stroke)	00→03	DPR7EA-9	5129			DPR7EIX-9	7803	0.9
	X9 250cc Evolution (Quasar 4-Stroke + carb)	04→07	CR8EB	7784			CR8EIX	4218	0.6
	XEvo 250	07→			PMR8A	5851	CR8EIX	4218	0.6
300	MP3 300 (Incl. LT)	10→	CR8EKB	4374			CR8EIX	4218	0.7
	Vespa GTS 300 (Incl. Super, Touring)	08→	CR8EKB	4374			CR8EIX	4218	0.7
	Vespa GTV 300	09→15	CR8EKB	4374			CR8EIX	4218	0.7
350	Beverly 350 Sport Touring	12→	CR8EKB	4374			CR8EIX	4218	0.7
	X10	12→	CR7EKB	4455			CR7EIX	7385	0.8
400	MP3 400	07→10	CR7EKB	4455			CR7EIX	7385	0.8
	X8 400	06→08	CR7EKB	4455			CR7EIX	7385	0.8
	Xevo 400	07→	CR7EKB	4455			CR7EIX	7385	0.8
460	B500	03→	CR7EKB	4455			CR7EIX	7385	0.8
	X9 500 (Fuel Injection 4-Stroke)	02→	CR7EKB	4455			CR7EIX	7385	0.8
	X9 500 Evolution (Fuel Injection 4-Stroke)	04→08	CR7EKB	4455			CR7EIX	7385	0.8
500	MP3 500 LT Sport	11→	CR7EKB	4455			CR7EIX	7385	0.8
	X10	14→	CR7EKB	4455			CR7EIX	7385	0.8

PIONEER									
125	Nevada 125	08→	D8EA	2120			DR8EIX	6681	0.7
	Torro 125	08→	D8EA	2120			DR8EIX	6681	0.7

PUCH									
50	Magnum		B-4H	4110					0.5
	Maxi: 1.0 HP Models		B-4H	4110					0.5
	Maxi: 1.5 HP Models		B5HS	4210					0.5
	Maxi: 2.0 HP Models		B6HS	4510			BR6HIX	3419	0.5
	Monza 50, Ranger 50, X40		B7HS	5110			BR7HIX	7067	0.5

PULSE									
50	Evo SM	11→	BR8ES	5422			BR8EIX	5044	0.6
	HT50QT-36 Force 50 (2-valve)		CR7HS	7223			CR7HIX	7544	0.7
	Advert, Ghost		BPR7HS	6422			BPR7HIX	5944	0.6
	Force 50 (2-Stroke)	08→	BPR7HS	6422			BPR7HIX	5944	0.6
	Lightspeed 2 WY50QT-58	08→	CR7HS	7223			CR7HIX	7544	0.7
	Rhythm, Scout		CR7HS	7223			CR7HIX	7544	0.7
125	Adrenaline 125 XF125GY-2B	08→	CR8E	1275			CR8EIX	4218	0.7
	HT125T-9 Vijo 125		D8EA	2120			DR8EIX	6681	0.7
	Lightspeed 2 WY125T-74	12→	CR7HS	7223			CR7HIX	7544	0.7
	LK125GY-2 Rage 125		CR7HS	7223			CR7HIX	7544	0.7
	Phantom ZN125T-32A		CR7HS	7223			CR7HIX	7544	0.7
	Zoom		CR7HSA	4549			CR7HIX	7544	0.6
250	Adrenaline 250 XF250GY	08→	DR8EA	7162			DR8EIX	6681	0.7

REGAL RAPTOR									
50	DD50QE-2	03→	CR7HS	7223			CR7HIX	7544	0.7
100	DD100E	03→	CR7HS	7223			CR7HIX	7544	0.7

2 Wheel



CC	MODEL	DATE	STANDARD COPPER CORE	STOCK NUMBER	PLATINUM OR GOLD PALLADIUM	STOCK NUMBER	IRIDIUM	STOCK NUMBER	GAP MM
REGENT									
125	Roadster, Deluxe, Sports Tourer, Super RT125		B7HS	5110			BR7HIX	7067	0.6
150	Roadster, Trail, Deluxe	95→97	B7HS	5110			BR7HIX	7067	0.6
175	Roadster, Trail, Deluxe, Sports Tourer, Super RT175	95→97	B7HS	5110			BR7HIX	7067	0.6

RIDERS									
50	Riders Super Cub	11→	CR7HSA	4549			CR7HIX	7544	0.6
110	Riders Super Cub	11→	CR7HSA	4549			CR7HIX	7544	0.6

RIEJU									
50	MRT 50 (Incl. Pro, SM)		BR9ES	5722			BR9EIX	3981	0.6
	MRX 50 (Minarelli engine)	03→	BR9ES	5722			BR9EIX	3981	0.8
	MRX 50 Pro	03→	BR9ES	5722			BR9EIX	3981	0.8
	MX50 (Morini S5 engine)	03→	B6HS	4510			BR6HIX	3419	0.5
	RR50 / Spike / Supermotard / RR50 Castrol	97→	BR9ES	5722			BR9EIX	3981	0.8
	RRX Spike 50 Supermoto	07→	BR8ES	5422			BR8EIX	5044	0.5
	RS1 Evolution	98→04	BR9ES	5722			BR9EIX	3981	0.8
	RS2 50 Matrix (Incl. Pro)	03→	BR9ES	5722			BR9EIX	3981	0.7
	RS2 50 NKD		BR9ES	5722			BR9EIX	3981	0.7
	RS3	11→	BR9ES	5722			BR9EIX	3981	0.7
	RS3 NKD	13→	BR9ES	5722			BR9EIX	3981	0.7
	SMX (Minarelli engine)	03→	BR9ES	5722			BR9EIX	3981	0.8
	SMX Pro 50	04→	BR9ES	5722			BR9EIX	3981	0.7
	Spike 50		BR9ES	5722			BR9EIX	3981	0.7
Tango 50, Tango0! 50	07→	BR9ES	5722			BR9EIX	3981	0.7	
125	Marathon (Endura / SM)		CR8E	1275			CR8EIX	4218	0.7
	MRX (Yamaha 4-Stroke)	03→	CR7HSA	4549			CR7HIX	7544	0.6
	RS2 125 Matrix	06→	CR7HSA	4549			CR7HIX	7544	0.6
	RS2 125 NKD	06→07	CR7HSA	4549			CR7HIX	7544	0.6
	RS2 125 Pro	07→11	CR7HSA	4549			CR7HIX	7544	0.6
	RS3	11→	CR8E	1275			CR8EIX	4218	0.7
	RS3 NKD	13→	CR8E	1275			CR8EIX	4218	0.7
	SMX (Yamaha 4-Stroke)	03→	CR7HSA	4549			CR7HIX	7544	0.6
Tango 125	07→	CR7HSA	4549			CR7HIX	7544	0.6	
250	Marathon	10→	CR8E	1275			CR8EIX	4218	0.7
	Tango 250		D8EA	2120			DR8EIX	6681	0.7
450	Marathon	10→	CR8E	1275			CR8EIX	4218	0.7

ROVIGO									
50	Spoletto 50, Tempesta 50	99→	BPR7HS	6422			BPR7HIX	5944	0.6

ROYAL ENFIELD (1980→)									
350	Bullet Classic models	80→	B7HS	5110			BR7HIX	7067	0.5
500	Bullet Classic models	80→08	BR8ES	5422			BR8EIX	5044	0.5
	Bullet Electra X Lean Burn engine models	04→08	BR9ES	5722			BR9EIX	3981	0.8

RTX									
125	Cross C125, Trials T125		B7HS	5110			BR7HIX	7067	0.6
212	Cross C212, Trials T212		B8HS	5510			BR8HIX	7001	0.6

SACHS									
50	Dirty Devil	04→	BP5HS	4111					0.6
	MadAss 50	04→	CR7HSA	4549			CR7HIX	7544	0.6
	Speedjet R	05/09→	BPR7HS	6422			BPR7HIX	5944	0.7
	Speedjet RS	06/11→	BPR7HS	6422			BPR7HIX	5944	0.7
110	Dirty Devil	04→	C7HSA	4629			CR7HIX	7544	0.6
125	MadAss 125	06→	C7HSA	4629			CR7HIX	7544	0.6
	Roadster 125	00→05	CR6HSA	2983			CR6HIX	7274	0.8



CC	MODEL	DATE	STANDARD COPPER CORE	STOCK NUMBER	PLATINUM OR GOLD PALLADIUM	STOCK NUMBER	IRIDIUM	STOCK NUMBER	GAP MM
SACHS (CONTINUED)									
125	XTC 125, ZX Enduro 125, ZZ 125 (Ø14mm Plug)	00→01	BR9ES	5722			BR9EIX	3981	0.8
	XTC 125 (Ø10mm Plug) 4-Stroke	02→07	CR8E	1275			CR8EIX	4218	0.7
650	Roadster 650	00→06	CR10E	6264			CR10EIX	6482	0.8
805	B 805	02→	DPR8EA-9	4929			DPR8EIX-9	2202	0.9
	Roadster 800	00→05	DPR8EA-9	4929			DPR8EIX-9	2202	0.9

SCORPA									
70	4-Tricks	06→07	CR7HSA	4549			CR7HIX	7544	0.7
125	SR125R	11→	BP5ES	6511			BPR5EIX	6597	0.5
	SY 125 FR	03→09	CR7HSA	4549			CR7HIX	7544	0.7
	TY-S 125F	04→06	CR7HSA	4549			CR7HIX	7544	0.7
	TY 125F	12→	CR6HSA	2983			CR6HIX	7274	0.7
175	SY 175 F	03→09	CR7HSA	4549			CR7HIX	7544	0.7
	TY-S 175 F	03→09	CR7HSA	4549			CR7HIX	7544	0.7
250	SY 250						BPR6EIX	6637	0.7
	SY 250 FR	07→	CR8E	1275			CR8EIX	4218	0.7
	SY 250 Long Ride	06→09			BKR5EVX	2546	BKR5EIX	6341	0.6
	SY 250 Racing	01→09			BKR5EVX	2546	BKR5EIX	6341	0.6
	T-Ride 250F	08→	CR8E	1275			CR8EIX	4218	0.7
	TY 250 / E						BKR6EIX	6418	0.7
272	SR280R	11→	BP5ES	6511			BPR5EIX	6597	0.5
300	294, 295		BP5ES	6511			BPR5EIX	6597	0.5

SHERCO									
50	0.5 Kid	03→	B9ES	2611			BR9EIX	3981	0.6
	Base		BR9ES	5722			BR9EIX	3981	0.7
	Champion Replica 50		BR9ES	5722			BR9EIX	3981	0.7
	Enduro 50	03→	BR9ES	5722			BR9EIX	3981	0.7
	HRD50	03→	BR9ES	5722			BR9EIX	3981	0.7
	Ipone Replica		BR9ES	5722			BR9EIX	3981	0.7
	Supermotard 50	03→	BR9ES	5722			BR9EIX	3981	0.7
80	ST 0.8	04→	BP5ES	6511			BPR5EIX	6597	0.5
125	Academy 125	2009	BP5ES	6511			BPR5EIX	6597	0.6
	City Corp 125	04→	CR7HSA	4549			CR7HIX	7544	0.6
	ST 1.25	99→	BP5ES	6511			BPR5EIX	6597	0.6
	125 ST	14→	BP5ES	6511			BPR5EIX	6597	0.6
200	2.0	99→	BP5ES	6511			BPR5EIX	6597	0.6
250	2.5i-F	08→11	CR8EK	3478			CR8EIX	4218	0.7
	Access 2.5 (2-Stroke)	2010	BP5ES	6511			BPR5EIX	6597	0.6
	SE 250i	12→	CR8EK	3478			CR8EIX	4218	0.7
	ST 2.5	99→10	BP5ES	6511			BPR5EIX	6597	0.6
	ST 2.5	11→13	BP5ES	6511			BPR5EIX	6597	0.6
	250 ST	14→	BP5ES	6511			BPR5EIX	6597	0.6
272	290 X-Ride	12→	BPR5ES	7422			BPR5EIX	6597	0.6
290	3.0i-F	10→11	CR8EK	3478			CR8EIX	4218	0.7
	Access 2.9 (2-Stroke)	2010	BP5ES	6511			BPR5EIX	6597	0.6
	ST 2.9	99→10	BP5ES	6511			BPR5EIX	6597	0.6
	ST 2.9	11→	BP5ES	6511			BPR5EIX	6597	0.6
	SE 300i	12→	CR8EK	3478			CR8EIX	4218	0.7
320	3.2 4T	05→			PFR6B	3500		0.6	
450	4.5i-F 4T	04→	CR8EK	3478			CR8EIX	4218	0.7
	4.5i Enduro	05→	CR8EK	3478			CR8EIX	4218	0.7
510	5.1i	05→	CR8EK	3478			CR8EIX	4218	0.7

SIMSON									
50	S51 Series SR50		B7HS	5110			BR7HIX	7067	0.5
70	S70 C&E	83→	B7HS	5110			BR7HIX	7067	0.5



CC	MODEL	DATE	STANDARD COPPER CORE	STOCK NUMBER	PLATINUM OR GOLD PALLADIUM	STOCK NUMBER	IRIDIUM	STOCK NUMBER	GAP MM
SINNIS									
50	Eagle, Hawk (2-Stroke)	06/06→	BPR7HS	6422			BPR7HIX	5944	0.6
	Falcon, Jet (4-Stroke)	06/06→	CR7HSA	4549			CR7HIX	7544	0.6
	Flair	05/12→	CR7HSA	4549			CR7HIX	7544	0.6
	Ghost, Nitro, Pioneer, Strike (2-Stroke)	06/06→09	BPR7HS	6422			BPR7HIX	5944	0.6
	Phoenix	05/12→	BPR7HS	6422			BPR7HIX	5944	0.6
110	Breeze	06/06→09	CR7HSA	4549			CR7HIX	7544	0.6
125	Apache, Blade, Max, Stealth, Vista	12/07→	CR8E	1275			CR8EIX	4218	0.7
	Eagle, Matrix, Matrix II, Nitro, Pioneer, Sublime (4-Stroke)	01/07→	CR7HSA	4549			CR7HIX	7544	0.6
	Eco City	01/10→	CR7HSA	4549			CR7HIX	7544	0.6
	Spirit	05/12→	CR7HSA	4549			CR7HIX	7544	0.6
	Trackstar	05/10→	CR8E	1275			CR8EIX	4218	0.7
200	Apache, Blade	12/07→09	DR8ES-L	2923	DR8EVX	6354	DR8EIX	6681	0.7

SKYTEAM									
125	Wacky ST125/Y		C7HSA	4629			CR7HIX	7544	0.7

SMC									
50	NAF 50 Navigator		BPR7HS	6422			BPR7HIX	5944	0.6
	NGF 50 Sports Force		BPR7HS	6422			BPR7HIX	5944	0.6
	NKF 50 on/off road		BPR7HS	6422			BPR7HIX	5944	0.6
	NLFR 50 Caprillio		BPR7HS	6422			BPR7HIX	5944	0.6
	PAF 50 Partner		BPR7HS	6422			BPR7HIX	5944	0.6
	SBF 50 Super		BPR7HS	6422			BPR7HIX	5944	0.6
90	NGN 90 Sports Force		BPR7HS	6422			BPR7HIX	5944	0.6
	SBN 90 Super		BPR7HS	6422			BPR7HIX	5944	0.6
100	NKO 100 on/off road		BPR7HS	6422			BPR7HIX	5944	0.6
	SBO 100 Super		BPR7HS	6422			BPR7HIX	5944	0.6
125	CHP 125 Chopper		DR8EA	7162	DR8EVX	6354	DR8EIX	6681	0.7

SUPERBYKE									
50	M-PED 50	06→	CR7HSA	4549			CR7HIX	7544	0.6
	Powerband 50 (2-Stroke) Ø14mm Plug	06→	BPR7HS	6422			BPR7HIX	5944	0.6
	Powermax 50 (2-Stroke) Ø14mm Plug	08→	BPR7HS	6422			BPR7HIX	5944	0.6
125	Powerband 125	06→	CR7HSA	4549			CR7HIX	7544	0.6
	RBP125	06→	D8EA	2120			DR8EIX	6681	0.7
	RMR125		CR8E	1275			CR8EIX	4218	0.7
	RSP125	10→	DR8EA	7162			DR8EIX	6681	0.7
	SMax125	08→	CR7HSA	4549			CR7HIX	7544	0.6

SUZUKI									
50	AE50 L, M, N, P, R, T	90→99	BPR6HS	7022			BPR6HIX	4085	0.6
	AH50	93→96	BPR6HS	7022			BPR6HIX	4085	0.6
	AP50 T, V, W	96→02	BPR6HS	7022			BPR6HIX	4085	0.7
	AY50 Katana (Incl. R) Air cooled (Ø14mm Plug)	97→04	BPR6HS	7022			BPR6HIX	4085	0.8
	AY50W, WR Katana (Incl. R) Liquid cooled (Ø14mm Plug)	98→04	BPR6HS	7022			BPR6HIX	4085	0.8
	AY50A Katana (Incl. R) Liquid cooled (Ø10mm Plug)	05→06	CPR8E	7411			CR8EIX	4218	0.8
	CL50D, CS50D Roadie, FS50 Snip	82→88	BPR4HS	7823					0.7
	CP50	85→92	BPR6HS	7022			BPR6HIX	4085	0.6
	DR50	86→94	BR7HS	4122			BR7HIX	7067	0.6
	FR50	81→86	BPR4HS	7823					0.7
	FZ50 Suzy	80→86	BPR4HS	7823					0.7
	JR50	85→06	BPR4HS	7823					0.7
	RM50	78→99	B7HS	5110			BR7HIX	7067	0.6
	RMX 50	96→01	BPR8ES	3923			BPR8EIX	6684	0.7
	SMX 50	96→02	BPR8ES	3923			BPR8EIX	6684	0.7
	TR50S	97→00	BPR6HS	7022			BPR6HIX	4085	0.6
	TS50	71→78	BP6HS	4511			BPR6HIX	4085	0.6
	TS50ER (½", 12.7mm Thread Reach)	79→83	BP6HS	4511			BPR6HIX	4085	0.7
	TS50ER (¾", 19mm Thread Reach)	79→83	BPR6ES	7822			BPR6EIX	6637	0.7



CC	MODEL	DATE	STANDARD COPPER CORE	STOCK NUMBER	PLATINUM OR GOLD PALLADIUM	STOCK NUMBER	IRIDIUM	STOCK NUMBER	GAP MM	
SUZUKI (CONTINUED)										
50	TS50X	84→00	BPR6ES	7822			BPR6EIX	6637	0.7	
	UF 50 Estilete	99→01	BPR7HS	6422			BPR7HIX	5944	0.6	
	UX50W-X-Y Zillion	99→01	BPR6HS	7022			BPR6HIX	4085	0.6	
	ZR50	83→99	BP6ES	7811			BPR6EIX	6637	0.7	
65	RM65 K3-K5	03→05	B10EG	3630	B10EGV	5927	BR10EIX	6801	0.6	
70	DR-Z70	08→	CR7HSA	4549			CR7HIX	7544	0.6	
80	CP80	85→94	BPR6HS	7022			BPR6HIX	4085	0.7	
	CS80CD	83→87	BPR6HS	7022			BPR6HIX	4085	0.7	
	FR80D	84→87	BPR6HS	7022			BPR6HIX	4085	0.7	
	RM80T	78→85	B10EG	3630	B10EGV	5927	BR10EIX	6801	0.6	
	RM80X G, H, J, K, L	86→90	B9EG	3530	B9EGV	5827	BR9EIX	3981	0.7	
	RM80X M, N, P, R, S, T, V	91→99	B10EG	3630	B10EGV	5927	BR10EIX	6801	0.7	
	RM80 K1	00→01	BR10ES	4832			BR10EIX	6801	0.8	
85	RM85 /L K3-K9, L0-L6	02→	BR10ES	4832			BR10EIX	6801	0.8	
100	AH100	94→97	BPR7HS	6422			BPR7HIX	5944	0.6	
	GP100 All models	78→92	B8HS	5510			BR8HIX	7001	0.7	
	RM100	76→81			B9EGV	5827	BR9EIX	3981	0.7	
	RM100 K4	03→04	R6252K-105	2741					0.7	
	TS100ER, TS100ERZ	78→89	B8ES	2411			BR8EIX	5044	0.7	
110	UG 110 Hokuto	99→02	BPR7HS	6422			BPR7HIX	5944	0.6	
	UK110 Address	15→	CPR7EA-9	3901			CR7EIX	7385	0.9	
125	AN125 S	95→96	CR8E	1275			CR8EIX	4218	0.6	
	AN125 T,V,W	96→11/98	CR7E	4578			CR7EIX	7385	0.6	
	AN125 X	11/98→	CR8E	1275			CR8EIX	4218	0.7	
	CS125D	83→87	D8EA	2120	DR8EVX	6354	DR8EIX	6681	0.7	
	DR125 SEX-SEY	99→01	DR8EA	7162	DR8EVX	6354	DR8EIX	6681	0.7	
	DR125S D/F/H/J	82→94	DR8ES-L	2923	DR8EVX	6354	DR8EIX	6681	0.7	
	DR125SM	08→12	CR8E	1275			CR8EIX	4218	0.7	
	DR-Z125L	10→	DR8EA	7162	DR8EVX	6354	DR8EIX	6681	0.7	
	FL125 S Address	07→14	CR8E	1275			CR8EIX	4218	0.7	
	GN125 W-X	93→01	DR8EA	7162	DR8EVX	6354	DR8EIX	6681	0.7	
	GP125 All models	78→89	B8HS	5510			BR8HIX	7001	0.7	
	GS125ES, D All models	82→00	DR8ES-L	2923	DR8EVX	6354	DR8EIX	6681	0.7	
	GT125	74→80	B8HS	5510			BR8HIX	7001	0.6	
	GZ125 W, X, Y, K1-K3 Marauder	98→03	DR8EA	7162	DR8EVX	6354	DR8EIX	6681	0.6	
	GZ125 K4-L1	04→11	CR8E	1275			CR8EIX	4218	0.7	
	RG125 UC, G, H, J, J2	85→94	BR8ES	5422			BR8EIX	5044	0.6	
	RG125FU-N, P, R	91→95	BR9ECM	3252			BR9ECMIX	2707	0.7	
	RG125U Wolf	91→95	BR9ECM	3252			BR9ECMIX	2707	0.6	
	RM125 E, F, G, H, J	84→88	BR9EG	3230			BR9EIX	3981	0.5	
	RM125 K, L, M	89→91	B9EG	3530	B9EGV	5827	BR9EIX	3981	0.5	
	RM125 N, R, S	92→95			R4118S-9	3245			0.6	
	RM125 T, V, W, K1-K8	96→08			R6918B-8	4492			0.6	
	RV125 Van Van K4-K5	03→05	CR8E	1275			CR8EIX	4218	0.7	
	TS125 (A/B)	76→77	B8HS	5510			BR8HIX	7001	0.7	
	TS125 (C,ER/X/Z/D/XUE/XE)	78→88	B8ES	2411			BR8EIX	5044	0.7	
	TS125R K, L, M, N, P, R	89→96	BR9ES	5722			BR9EIX	3981	0.7	
	UC125 X Epicuro	99→02	CR8E	1275			CR8EIX	4218	0.7	
	UH125 K2-K9, L0-L5 Burgman	02→	CR8E	1275			CR8EIX	4218	0.7	
	UX125 Sixteen 125	07→11	CR8E	1275			CR8EIX	4218	0.7	
	VL125 Y, K1-K5 Intruder	99→08	CR8E	1275			CR8EIX	4218	0.7	
	200	AN200 K7 Burgman	07→	CR8EK	3478			CR8EIX	4218	0.7
		DR200S	86→	DR8ES-L	2923	DR8EVX	6354	DR8EIX	6681	0.6
GT200X5		79→82	B8ES	2411			BR8EIX	5044	0.7	
SB200		79→83	B8ES	2411			BR8EIX	5044	0.7	
250	AN250 W, X, Y, K1-K3 Burgman	→03	CR8EK	3478			CR8EIX	4218	0.7	
	AN250 K4-K6 Burgman	04→06	CR7EK	7546			CR7EIX	7385	0.7	
	GN250 F, J, K, L, M, N, P, R, T	87→97	DR8EA	7162	DR8EVX	6354	DR8EIX	6681	0.6	
	GS250T, T/X	80→84	DR8ES	5423			DR9EIX	4772	0.7	
	GSX250E T, X, Z	80→85	DR8ES	5423			DR9EIX	4772	0.7	
	GT250K, L, M	73→75	B8ES	2411			BR8EIX	5044	0.7	
	GT250A/B/C (½", 12.7mm Thread Reach)	76→78	B8HS	5510			BR8HIX	7001	0.7	
	GT250A/B/C (¾", 19mm Thread Reach)	76→78	B9ES	2611			BR9EIX	3981	0.7	



CC	MODEL	DATE	STANDARD COPPER CORE	STOCK NUMBER	PLATINUM OR GOLD PALLADIUM	STOCK NUMBER	IRIDIUM	STOCK NUMBER	GAP MM
SUZUKI (CONTINUED)									
250	GT250X7 EN/EX	78→83	B9ES	2611			BR9EIX	3981	0.7
	GW250 L2-L5 Inazuma, Z	12→	CR7E	4578			CR7EIX	7385	0.7
	PE250 B/C	77→78	B8EG	3430	B8EGV	5627	BR8EIX	5044	0.5
	PE250 N/T/X/Z	79→82	BR10EG	3830			BR10EIX	6801	0.6
	RG250 Gamma	83→89	BR9ES	5722			BR9EIX	3981	0.7
	RGV250K, L	89→90	BR9ES	5722			BR9EIX	3981	0.7
	RGV250M, N, P, R	90→97	BR9ECM	3252			BR9ECMIX	2707	0.6
	RM250 Z/D	82→83	B8EG	3430	B8EGV	5627	BR8EIX	5044	0.5
	RM250 E, F, G, H, J, K, L, M	84→91	B8EG	3430	B8EGV	5627	BR8EIX	5044	0.5
	RM250 N, P, R, S	92→95			R4118S-8	3236			0.6
	RM250 T, V, W	96→99			R6918B-7	6259			0.6
	RM250 K1-K5	01→05	BR8EG	3130			BR8EIX	5044	0.6
	RMX250 K, L, M, N	89→92			B8EGV	5627	BR8EIX	5044	0.5
	RMX250 P, R, S	93→95					BR9EIX	3981	0.5
	RMX250 T, V, W, X	96→99					BR9EIX	3981	0.5
	RM-Z250 K4-K5 (4-Stroke)	04→06	CR8EB	7784			CR8EIX	4218	0.7
	RM-Z250 K7-K9, L0-L3 (4-Stroke)	07→13					CR8EIA-10	4708	1.0
	RM-Z250 L4→	14→					CR8EIB-10	4948	1.0
	TS250 X	85→89	BR8ES	5422			BR8EIX	5044	0.6
	TS250ER N/T/X	79→83	BP7ES	2412			BPR7EIX	4055	0.7
TU250 X, V, W	97→00	DR8EA	7162	DR8EVX	6354	DR8EIX	6681	0.6	
350	DR350S L, M, N, P, R	91→94	DPR9EA-9	5329			DPR9EIX-9	5545	0.9
	DR350SE R, S, V, W, X	94→99	CR9EK	4548			CR9EIX	3521	0.7
380	GT380	72→78	B8ES	2411			BR8EIX	5044	0.7
400	AN400 X, Y, K1-K6 Burgman	99→07	CR7E	4578			CR7EIX	7385	0.7
	AN400 K7-K9, L0-L6 Burgman, Z	10/07→	CR7E	4578			CR7EIX	7385	0.7
	DR400	80→82	DR8ES-L	2923	DR8EVX	6354	DR8EIX	6681	0.7
	DR-Z400E Y, K1-K5, DR-Z400S Y, K1-K5	99→07	CR8E	1275			CR8EIX	4218	0.7
	DR-Z400SM K5-K7	05→07	CR8E	1275			CR8EIX	4218	0.7
	GN400T	80→82	DR8ES-L	2923	DR8EVX	6354	DR8EIX	6681	0.7
	GS400 B/C	76→78	B8ES	2411			BR8EIX	5044	0.7
	GSF400M/N	91→92	CR8EK	3478			CR8EIX	4218	0.7
	GSF400P-R	93→95	CR9EK	4548			CR9EIX	3521	0.7
	GSX400E T/X, GSX400F, X/Z/D	80→84	DR8ES-L	2923	DR8EVX	6354	DR8EIX	6681	0.7
	GSX-R400H	86→89	C8HSA	6821	CR8HVX	7236	CR8HIX	7669	0.6
	PE400 T, X, Z	80→82	BR9EG	3230			BR9EIX	3981	0.7
	SP400	80→82	DR8ES-L	2923	DR8EVX	6354	DR8EIX	6681	0.7
	450	GS450	85→88	B8ES	2411			BR8EIX	5044
RMX450Z L0, L1		10→11					CR8EIB-10	4948	1.0
RMX450Z L4→		14→					CR8EIB-10	4948	1.0
RM-Z450 K4-K6 (4-Stroke)		04→06					CR8EIB-10	4948	1.0
RM-Z450/Z K7-K9, L0-L6 (4-Stroke)		07→					DIMR8A10	5066	1.0
500	GS500E K, L, M, N, P, R, S, T, V, W, X, Y, K1-K3	89→05	DPR8EA-9	4929			DPR8EIX-9	2202	0.9
	GS500E / F K4-K9	04→09	DPR8EA-9	4929			DPR8EIX-9	2202	0.9
	GT500	75→77	B7HS	5110			BR7HIX	7067	0.6
	RG500 Gamma	85→89	BR9ES	5722			BR9EIX	3981	0.6
	RM500D	83→85	B8EG	3430	B8EGV	5627	BR8EIX	5044	0.6
	T500	68→75	B8HS	5510			BR8HIX	7001	0.6
550	GS550 All models	77→85	B8ES	2411			BR8EIX	5044	0.7
	GSX550 EE/ESD/ESE/EFE	83→88	DR8ES	5423			DR9EIX	4772	0.7
600	GSF600 S, T, V, W, Y, K1-K4 Bandit Naked (Unfaired)	95→05	CR9EK	4548			CR9EIX	3521	0.7
	GSF600S T, V, W, Y, K1-K4 Bandit (Faired)	95→05	CR9EK	4548			CR9EIX	3521	0.7
	GSR600/S K6-K9, L0	06→10	CR9E	6263			CR9EIX	3521	0.7
	GSX600F J, K, L, M, N, P, R, S, V	88→97	DR8ES	5423			DR9EIX	4772	0.7
	GSX600F T, V, W, X, Y, K1-K4	97→04	CR9EK	4548			CR9EIX	3521	0.7
	GSX-R600 V, W, X, K1-K7	97→07	CR9E	6263			CR9EIX	3521	0.7
	GSX-R600 K8-K9, L0-L6 (Incl. Tyco)	08→					CR9EIA-9	6289	0.9
	RF600R P/R/S/V	93→97	CR9E	6263			CR9EIX	3521	0.7
	VS600 GLS	95→97	DPR8EA-9	4929			DPR8EIX-9	2202	0.9
650	AN650 K3-K5 Burgman	03→05	CR8E	1275			CR8EIX	4218	0.7
	AN650A K4-K9, L1-L6 Burgman	04→	CR8E	1275			CR8EIX	4218	0.7
	DL650 K4-K6 V-Strom	03→06	CR8E	1275			CR8EIX	4218	0.7
	DL650 K7-K9, L0 V-Strom (Twin Spark)	07→10	CR8E	1275			CR8EIX	4218	0.7



CC	MODEL	DATE	STANDARD COPPER CORE	STOCK NUMBER	PLATINUM OR GOLD PALLADIUM	STOCK NUMBER	IRIDIUM	STOCK NUMBER	GAP MM
SUZUKI (CONTINUED)									
650	DL650A V-Strom XP (Twin Spark)	2010	CR8E	1275			CR8EIX	4218	0.7
	DL650AL1 V-Strom 650 ABS (Twin Spark)	2011	CR8E	1275			CR8EIX	4218	0.7
	DL650AL2-AL5 V-Strom 650 ABS (Twin Spark)	12→					CR8EIA-9	4286	0.9
	DR650RSE Models and RE models	91→95	DPR9EA-9	5329			DPR9EIX-9	5545	0.9
	DR650SET	95→97	CR10E	6264			CR10EIX	6482	0.7
	GS650 All models (Incl. Katana)	81→84	DR8ES-L	2923	DR8EVX	6354	DR8EIX	6681	0.7
	GSF650 K5, K6 Bandit	05→06	CR8EK	3478			CR8EIX	4218	0.7
	GSF650 K7 Bandit (Liquid Cooled)	2007	CR9E	6263			CR9EIX	3521	0.6
	GSF650 K8-K9, L0 Bandit (Liquid Cooled)	08→10	CR8E	1275			CR8EIX	4218	0.7
	GSX650F	2007	CR9E	6263			CR9EIX	3521	0.6
	GSX650F	08→16	CR8E	1275			CR8EIX	4218	0.7
	LS650 All models	87→98	DPR8EA-9	4929			DPR8EIX-9	2202	0.9
	SFV650 Gladius (Twin Spark)	09→15					CR8EIA-9	4286	0.9
	SV650, SV650S X/Y/K1-K6	99→06	CR8E	1275			CR8EIX	4218	0.7
	SV650, SV650S K7-K9, L0-L5	07→15	CR8E	1275			CR8EIX	4218	0.7
	XF650 V-W-X-Y Freewind	97→02	CR10E	6264			CR10EIX	6482	0.7
670	XN85 650 Turbo	83→86	DR8ES	5423			DR9EIX	4772	0.7
750	DR750 SJ/SK	88→90	DPR9EA-9	5329			DPR9EIX-9	5545	0.9
	GS750 DB, EC, EN, GL	76→81	B8ES	2411			BR8EIX	5044	0.7
	GSR750 (Incl. GSR750Z)	11→					CR9EIA-9	6289	0.9
	GSX750 W, X, Y, K1	97→01	CR9EK	4548			CR9EIX	3521	0.7
	GSX750E T/EX/ESD/ESE/ESF/ESG	83→89	DR8ES-L	2923	DR8EVX	6354	DR8EIX	6681	0.7
	GSX750F K/L/M/N/P/R/S/T	89→96	JR9C	6193					0.7
	GSX750F W, X, Y, K1-K5	97→05	CR9EK	4548			CR9EIX	3521	0.7
	GSX750SZ,SD Katana	82→83	D7EA	7912					0.7
	GSX750SE,SF Katana	84→85	DR8ES-L	2923	DR8EVX	6354	DR8EIX	6681	0.7
	GSX-R750 F, G, H	85→88	DR8ES	5423			DR9EIX	4772	0.7
	GSX-R750 J, K	88→89	JR9C	6193					0.7
	GSX-R750 L, M	89→92	CR10EK	2360			CR10EIX	6482	0.7
	GSX-R750 WN, WP, WR, WS	91→96	CR9E	6263			CR9EIX	3521	0.7
	GSX-R750 T, V, W, X, Y, K1-K7	96→07	CR9E	6263			CR9EIX	3521	0.7
	GSX-R750 K8-K9, L0-L6	08→					CR9EIA-9	6289	0.9
VS750GLP F, G, H, J, K, L, M	85→91	DPR8EA-9	4929			DPR8EIX-9	2202	0.9	
800	DR800 SL, SM	90→92	DPR9EA-9	5329			DPR9EIX-9	5545	0.9
	VL800 K1-K5	01→05	DPR7EA-9	5129			DPR7EIX-9	7803	0.9
	VL800 K6 C800 Intruder	06→09	DPR7EA-9	5129			DPR7EIX-9	7803	0.9
	VL800 L0 Intruder C800	10→	DR7EA	7839					0.7
	VS800GL M, P, R, S, T, V	91→97	DPR8EA-9	4929			DPR8EIX-9	2202	0.9
	VX800 L/M/R	90→96	DPR8EA-9	4929			DPR8EIX-9	2202	0.9
	VZ800 V, W, X, Y, K1 Marauder	97→01	DPR8EA-9	4929			DPR8EIX-9	2202	0.9
	VZ800 K5→ Intruder M800	05→09	DPR7EA-9	5129			DPR7EIX-9	7803	0.9
	VZ800 L0 Intruder M800	10→	DR7EA	7839					0.7
	850	GS850 GN/GT/GX/GZ/GD/GE/GG	79→88	B8ES	2411			BR8EIX	5044
900	RF900R R, S, T, V, W	94→99	CR9E	6263			CR9EIX	3521	0.7
1000	DL1000 K2-K9 V-Strom	02→09	CR8EK	3478			CR8EIX	4218	0.7
1036	DL1000 L4 V-Strom (Twin Spark)	14→					LMAR8BI-9	91909	0.9
1000	GS1000 EC/EN/ET/GT/GX/SN	80→82	B8ES	2411			BR8EIX	5044	0.7
	GSX1000 SZ/SD Katana	81→85	DR8ES-L	2923	DR8EVX	6354	DR8EIX	6681	0.7
	GSX-R1000 K1-K6	00→06	CR9E	6263			CR9EIX	3521	0.7
	GSX-R1000 K6 Phantom	2006	CR9E	6263			CR9EIX	3521	0.7
	GSX-R1000 K7-K9, L0-L6	07→					CR9EIA-9	6289	0.9
	GSX-R1000ZSE	2014					CR9EIA-9	6289	0.9
	GSX-S1000	15→					CR9EIA-9	6289	0.9
	SV1000/S K3-K5	03→05	CR8EK	3478			CR8EIX	4218	0.7
	SV1000 Classic	07→08	CR8EK	3478			CR8EIX	4218	0.7
	TL1000R W, Y, K1-K3	98→03	CR9EK	4548			CR9EIX	3521	0.7
	TL1000S V, W, X, Y	97→01	CR8EK	3478			CR8EIX	4218	0.7
	1100	GS1100GZ	82→86	B8ES	2411			BR8EIX	5044
GSX1100 ET/X/Z/S/ESD,SZ ,SD (Katana)		79→85	DR8ES-L	2923	DR8EVX	6354	DR8EIX	6681	0.7
GSX1100 EFE/EF/EF/EG/EF/G		84→88	DR8ES	5423			DR9EIX	4772	0.7
GSX1100 FJ, FK, FL, FM, FN, FP, FR, FS		87→96	JR9B	3188			DR9EIX	4772	0.6
GSX1100 GM, GN, GP, GR		91→94	JR9B	3188			DR9EIX	4772	0.6
GSX-R1100 G, H, J		86→89	JR9B	3188			DR9EIX	4772	0.6

2 Wheel



CC	MODEL	DATE	STANDARD COPPER CORE	STOCK NUMBER	PLATINUM OR GOLD PALLADIUM	STOCK NUMBER	IRIDIUM	STOCK NUMBER	GAP MM
SUZUKI (CONTINUED)									
1100	GSX-R1100 K, L, M, N	89→93	JR9B	3188			DR9EIX	4772	0.6
	GSX-R1100 W-P, R, S, T	93→96	CR9E	6263			CR9EIX	3521	0.7
1200	GSF1200S T, V, W, X, Y, K1-K6 Bandit (Faired)	96→06	JR9B	3188			DR9EIX	4772	0.6
	GSF1200 T, V, W, X, Y, K1-K6 Bandit Naked (Unfaired)	96→06	JR9B	3188			DR9EIX	4772	0.6
1250	GSF1250/SA Bandit K7-K9, L0→	07→	CR7E	4578			CR7EIX	7385	0.8
1255	GSX1250FA Bandit (Incl. GSX1250FA Z)	10→	CR7E	4578			CR7EIX	7385	0.7
1300	GSX1300 B-King	07→12					CR9EIA-9	6289	0.9
	GSX1300R X, Y, K1-K5 Hayabusa	99→07	CR9E	6263			CR9EIX	3521	0.7
1340	GSX1300R Hayabusa	08→					CR9EIA-9	6289	0.9
1400	GSX1400 K2-K6	01→06	CR8EK	3478			CR8EIX	4218	0.7
	GSX1400 FE - K7	06→09	CR8EK	3478			CR8EIX	4218	0.7
	VS1400GLP-H, J, R, S, T, V, W (Intruder)	87→99	DPR8EA-9	4929			DPR8EIX-9	2202	0.9
1500	C1500T Intruder	13→	CPR6EA-9	6899					0.9
	VL1500 LC/X	98→03	DPR7EA-9	5129			DPR7EIX-9	7803	0.9
	VL1500 →K5	→05	DPR7EA-9	5129			DPR7EIX-9	7803	0.9
	VZ1500 L0 Intruder M1500	10→	CR6E	6965					0.7
1600	VZ1600 K4-K5	03→04	DPR6EA-9	5531					0.9
1800	VLR1800 C1800R/RT Intruder	08→12	CR8EK	3478			CR8EIX	4218	0.7
	VZR1800 M1800R Intruder K6-K9, L0→	06→	CR8EK	3478			CR8EIX	4218	0.7

SWM

125	125TLM	77→84	BP5ES	6511			BPR5EIX	6597	0.4
200	TL200	→84	BP5ES	6511			BPR5EIX	6597	0.4
240	TL240	82→84	BP5ES	6511			BPR5EIX	6597	0.4
320	320TLM	77→84	BP5ES	6511			BPR5EIX	6597	0.4
350	TL350	83→84	BP5ES	6511			BPR5EIX	6597	0.4

SYM

50	City Hopper	98→03	BR8HSA	5539			BPR8HIX	6742	0.6
	DD50 City Trek / Sport	02→	BR8HSA	5539			BPR8HIX	6742	0.6
	Fiddle	98→	BR8HSA	5539			BPR8HIX	6742	0.6
	Fiddle II 50	08→13	BR8HSA	5539			BPR8HIX	6742	0.7
	Jet 50	98→	BR8HSA	5539			BPR8HIX	6742	0.6
	Jet 50 Sport X S/SE/SR/XS	06→	BR8HSA	5539			BPR8HIX	6742	0.7
	Jungle	98→02	BR8HSA	5539			BPR8HIX	6742	0.6
	Mask	98→	BR8HSA	5539			BPR8HIX	6742	0.6
	Mio 50	06→	CR6HSA	2983			CR6HIX	7274	0.7
	Red Devil	98→	BR8HSA	5539			BPR8HIX	6742	0.6
	Simply 50	08→10	CR7HSA	4549			CR7HIX	7544	0.7
	Super Fancy	98→03	BR8HSA	5539			BPR8HIX	6742	0.6
	100	Jet 100	99→	BR8HSA	5539			BPR8HIX	6742
Jet 100 Sport X S/SR Jet			BR8HSA	5539			BPR8HIX	6742	0.6
Mio 100			CR6HSA	2983			CR6HIX	7274	0.7
125	Attila, Super Duke	98→00	CR7HSA	4549			CR7HIX	7544	0.6
	Euro MX 125	05→	CR8E	1275			CR8EIX	4218	0.7
	Fiddle II 125	08→13	CR7HSA	4549			CR7HIX	7544	0.6
	GTS Voyager 125	05→07	CR8E	1275			CR8EIX	4218	0.8
	HD Orbit 125	04→	CR8E	1275			CR8EIX	4218	0.7
	Husky	98→	DR8EA	7162	DR8EVX	6354	DR8EIX	6681	0.6
	Joyride 125 (12.7mm Thread Reach)	02→04	CR7HSA	4549			CR7HIX	7544	0.6
	Joyride 125 (19mm Thread Reach)	05→	CR8E	1275			CR8EIX	4218	0.7
	Megalo 125	01→	CR7HSA	4549			CR7HIX	7544	0.6
	Shark 125 / R	99→05	CR8E	1275			CR8EIX	4218	0.8
	Simply 125	08→	CR7HSA	4549			CR7HIX	7544	0.7
	Symphony SR125	09→	CR7HSA	4549			CR7HIX	7544	0.7
	Voyager 125		CR8E	1275			CR8EIX	4218	0.7
	VS 125	06→	CR8E	1275			CR8EIX	4218	0.7
	Wolf 125		DR7EA	7839					0.7
	XS 125		DR7EA	7839					0.7
150	Symphony SR150	09→	CR7HSA	4549			CR7HIX	7544	0.7
180	HD Orbit 180	04→	CR8E	1275			CR8EIX	4218	0.7
	Joyride 180	02→	CR8E	1275			CR8EIX	4218	0.7



CC	MODEL	DATE	STANDARD COPPER CORE	STOCK NUMBER	PLATINUM OR GOLD PALLADIUM	STOCK NUMBER	IRIDIUM	STOCK NUMBER	GAP MM
SYM (CONTINUED)									
200	HD Orbit 200		CR8E	1275			CR8EIX	4218	0.7
	Joyride 200	09→	CR8E	1275			CR8EIX	4218	0.7
250	GTS Voyager 250	05→	CR8E	1275			CR8EIX	4218	0.7
300	Citycom 300	08→	CR8E	1275			CR8EIX	4218	0.7
	GTS 300		CR8E	1275			CR8EIX	4218	0.7
500	500 GT/XP	04→	CR7EKB	4455			CR7EIX	7385	0.8

TAMORETTI									
50	Retro 50 ZN50QT-E	05→	CR7HSA	4549			CR7HIX	7544	0.7
125	Retro 125 TN125-E	09→	CR7HSA	4549			CR7HIX	7544	0.7
	Stealth 125	08→	CR7HSA	4549			CR7HIX	7544	0.7

TGB									
50	202 Classic	02→	BPR7HS	6422			BPR7HIX	5944	0.5
	302 Sport	02→	BPR7HS	6422			BPR7HIX	5944	0.5
	303R Hawk	04→10	BPR7HS	6422			BPR7HIX	5944	0.5
	AKROStec	03→05	BPR7HS	6422			BPR7HIX	5944	0.5
	Delivery 50	03→	BPR7HS	6422			BPR7HIX	5944	0.5
	R50X	05→	BPR7HS	6422			BPR7HIX	5944	0.5
125	204 Classic	02→07	CR7HSA	4549			CR7HIX	7544	0.7
	303R Hawk	07→10	CR7HSA	4549			CR7HIX	7544	0.7
	304 Sport	02→	CR7HSA	4549			CR7HIX	7544	0.7
	404 Executive	02→07	CR7HSA	4549			CR7HIX	7544	0.7
	Bellavita 125i	13→	CR7E	4578			CR7EIX	7385	0.7
	Delivery 125	05→	CR7HSA	4549			CR7HIX	7544	0.7
	R125X	08→	CR7HSA	4549			CR7HIX	7544	0.7
	X-Motion 125	09→	CR8E	1275			CR8EIX	4218	0.7
300	Bellavita 300i	13→	CR8E	1275			CR8EIX	4218	0.7

THE BLACK DOUGLAS MOTORCYCLE CO.									
125	Claret Classic	13→	DR8EA	7162	DR8EVX	6354	DR8EIX	6681	0.8
	Countryman Deluxe	13→	DR8EA	7162	DR8EVX	6354	DR8EIX	6681	0.8
	Jade Wonder	13→	DR8EA	7162	DR8EVX	6354	DR8EIX	6681	0.8
	Original Drayton	13→	DR8EA	7162	DR8EVX	6354	DR8EIX	6681	0.8
	Silent Grey	13→	DR8EA	7162	DR8EVX	6354	DR8EIX	6681	0.8
	Sport Imperial	13→	DR8EA	7162	DR8EVX	6354	DR8EIX	6681	0.8
230	Claret Classic	13→	DR8EA	7162	DR8EVX	6354	DR8EIX	6681	0.8
	Countryman Deluxe	13→	DR8EA	7162	DR8EVX	6354	DR8EIX	6681	0.8
	Jade Wonder	13→	DR8EA	7162	DR8EVX	6354	DR8EIX	6681	0.8
	Original Drayton	13→	DR8EA	7162	DR8EVX	6354	DR8EIX	6681	0.8
	Silent Grey	13→	DR8EA	7162	DR8EVX	6354	DR8EIX	6681	0.8
	Sport Imperial	13→	DR8EA	7162	DR8EVX	6354	DR8EIX	6681	0.8

TM RACING									
125	MX 125	12→	BR9EG	3230			BR9EIX	3981	0.6
	SMM/SMR 125	12→	BR9EG	3230			BR9EIX	3981	0.6
144	MX 144	12→	BR9EG	3230			BR9EIX	3981	0.6
250	EN 250 (2-stroke)	12→	BR8EG	3130					0.6
	MX 250 (2-stroke)	12→	BR8EG	3130					0.6
	SMM, SMR 250 (2-stroke)	12→	BR8EG	3130					0.6
300	EN 300 (2-stroke)	12→	BR8EG	3130					0.6
	MX 300 (2-stroke)	14→	BR8EG	3130					0.6
	SMM, SMR 300 (2-stroke)	12→	BR8EG	3130					0.6
450	EN 450Fi	14→					CR9EIX	3521	0.8
	MX 450Fi	14→					CR9EIX	3521	0.8
	SMM, SMR, SMX 450Fi	14→					CR9EIX	3521	0.8
530	EN 530F	14→	CR8E	1275			CR8EIX	4218	0.8
	MX 530F	14→	CR8E	1275			CR8EIX	4218	0.8
	SMM, SMR, SMX 530F	14→	CR8E	1275			CR8EIX	4218	0.8



CC	MODEL	DATE	STANDARD COPPER CORE	STOCK NUMBER	PLATINUM OR GOLD PALLADIUM	STOCK NUMBER	IRIDIUM	STOCK NUMBER	GAP MM
TOMOS									
50	A3/A5K	84→96	B6HS	4510			BR6HIX	3419	0.5
	AT50, ATX50, NTX50	86→91	B6HS	4510			BR6HIX	3419	0.5

TRIUMPH PRE-1989									
250-500	Twins with 3/4", 19mm Thread Reach		B8ES	2411			BR8EIX	5044	0.6
650	T120, R, V Bonneville	→68	B7ES	1111			BR7EIX	6664	0.6
	T120, R, V Bonneville	68→74	B8ES	2411			BR8EIX	5044	0.6
	TR6 (12.7mm Thread Reach)	56→60	B7HS	5110			BR7HIX	7067	0.6
	TR6 Thunderbird/Daytona	67→73	B6ES	7310					0.6
	TR6C Trophy (19mm Thread Reach)	67→73	B8ES	2411			BR8EIX	5044	0.6
	TR65 Thunderbird	81→83	B6ES	7310					0.6
	TR65T Tiger Trail	1982	B6ES	7310					0.6
750	T140E, T140D Bonneville, TSX4	78→	B6ES	7310					0.6
	T140V Bonneville	73→88	B8ES	2411			BR8EIX	5044	0.6
	T150/160 Trident (Incl. BSA, A75 and Rocket 3)	→75	B8ES	2411			BR8EIX	5044	0.6
	TR7T Tiger Trail	81→82	B6ES	7310					0.6
	TSX8, TSS		C8E	7471			CR8EIX	4218	0.6

TRIUMPH 1991-ON									
600	Daytona 600	03→04	CR9EK	4548			CR9EIX	3521	0.7
	TT 600	99→03	CR9EK	4548			CR9EIX	3521	0.7
	Speed Four	02→	CR9EK	4548			CR9EIX	3521	0.7
650	Daytona 650	04→05	CR9EK	4548			CR9EIX	3521	0.7
660	Street Triple S (A2 Licence)	17→					CR9EIA-9	6289	0.9
675	Daytona 675 Triple	05→08	CR9EK	4548			CR9EIX	3521	0.7
	Daytona 675 Triple	12/08→12	CR9EK	4548			CR9EIX	3521	0.7
	Daytona 675 (Incl R)	13→					CR9EIA-9	6289	0.9
	Street Triple	07→16	CR9EK	4548			CR9EIX	3521	0.7
	Street Triple R, RX	08→16	CR9EK	4548			CR9EIX	3521	0.7
750	Speed Triple 750	1997	DPR8EA-9	4929			DPR8EIX-9	2202	0.9
	Trident, Daytona	91→98	DPR8EA-9	4929			DPR8EIX-9	2202	0.9
765	Street Triple R, RS, S	17→					CR9EIA-9	6289	0.9
790	America	04→06	DPR8EA-9	4929			DPR8EIX-9	2202	0.9
	Bonneville (Incl. Black)	00→06	DPR8EA-9	4929			DPR8EIX-9	2202	0.9
	Bonneville America	01→06	DPR8EA-9	4929			DPR8EIX-9	2202	0.9
	Bonneville T100	02→04	DPR8EA-9	4929			DPR8EIX-9	2202	0.9
	Speedmaster	02→	DPR8EA-9	4929			DPR8EIX-9	2202	0.9
799	Tiger 800, Tiger 800 XC (Incl. ABS & SE)	11→	CR9EK	4548			CR9EIX	3521	0.7
865	America 900	06→	DPR8EA-9	4929			DPR8EIX-9	2202	0.9
	America LT	14→	DPR8EA-9	4929			DPR8EIX-9	2202	0.9
	Bonneville 900 (Incl. Black)	06→15	DPR8EA-9	4929			DPR8EIX-9	2202	0.9
	Bonneville SE	12/08→15	DPR8EA-9	4929			DPR8EIX-9	2202	0.9
	Bonneville T100 (Incl. all special editions)	04→15	DPR8EA-9	4929			DPR8EIX-9	2202	0.9
	Bonneville T100 50th SE	07/2014	DPR8EA-9	4929			DPR8EIX-9	2202	0.9
	Scrambler	05→	DPR8EA-9	4929			DPR8EIX-9	2202	0.9
	Speedmaster	05→	DPR8EA-9	4929			DPR8EIX-9	2202	0.9
	Thrupton 900	03→	DPR8EA-9	4929			DPR8EIX-9	2202	0.9
	Thrupton SE (Incl. Ace)	10→	DPR8EA-9	4929			DPR8EIX-9	2202	0.9
885	Adventurer	96→01	DPR8EA-9	4929			DPR8EIX-9	2202	0.9
	Daytona, Daytona Super III	91→96	DPR8EA-9	4929			DPR8EIX-9	2202	0.9
	Legend TT	98→01	DPR8EA-9	4929			DPR8EIX-9	2202	0.9
	Speed Triple	94→96	DPR8EA-9	4929			DPR8EIX-9	2202	0.9
	Sprint	91→96	DPR8EA-9	4929			DPR8EIX-9	2202	0.9
	T509 Speed Triple	96→10/98	DPR8EA-9	4929			DPR8EIX-9	2202	0.9
	T709 Tiger	98→	DPR8EA-9	4929			DPR8EIX-9	2202	0.9
	Thunderbird	95→04	DPR8EA-9	4929			DPR8EIX-9	2202	0.9
	Thunderbird Sport	98→04	DPR8EA-9	4929			DPR8EIX-9	2202	0.9
	Tiger	91→98	DPR8EA-9	4929			DPR8EIX-9	2202	0.9
	Trident	91→98	DPR8EA-9	4929			DPR8EIX-9	2202	0.9
	Trophy	91→01	DPR8EA-9	4929			DPR8EIX-9	2202	0.9



CC	MODEL	DATE	STANDARD COPPER CORE	STOCK NUMBER	PLATINUM OR GOLD PALLADIUM	STOCK NUMBER	IRIDIUM	STOCK NUMBER	GAP MM
TRIUMPH 1991-ON (CONTINUED)									
900	Bonneville T100	16→	LMAR8A-9	4313					0.9
	Street Cup	15→	LMAR8A-9	4313					0.9
	Street Twin	15→	LMAR8A-9	4313					0.9
955	Daytona 955i (Ø12mm Plug)	98→01	DPR8EA-9	4929			DPR8EIX-9	2202	0.9
	Daytona 955i (Ø10mm Plug)	01→06	CR9EK	4548			CR9EIX	3521	0.7
	Speed Triple (Ø12mm Plug)	10/98→01	DPR8EA-9	4929			DPR8EIX-9	2202	0.9
	Speed Triple (Ø10mm Plug)	01→04	CR9EK	4548			CR9EIX	3521	0.7
	Sprint RS (Ø12mm Plug)	99→00	DPR8EA-9	4929			DPR8EIX-9	2202	0.9
	Sprint RS (Ø10mm Plug)	01→05	CR9EK	4548			CR9EIX	3521	0.7
	Sprint ST (Ø12mm Plug)	98→00	DPR8EA-9	4929			DPR8EIX-9	2202	0.9
	Sprint ST (Ø10mm Plug)	01→	CR9EK	4548			CR9EIX	3521	0.7
	T595 Daytona	97→98	DPR8EA-9	4929			DPR8EIX-9	2202	0.9
	Tiger EFI	00→07	DPR8EA-9	4929			DPR8EIX-9	2202	0.9
1000	Daytona	91→93	DPR8EA-9	4929			DPR8EIX-9	2202	0.9
1050	Speed 94, 94R	04/15→	CR8EK	3478			CR8EIX	4218	0.7
	Speed Triple (Incl. R)	05→15	CR8EK	3478			CR8EIX	4218	0.7
	Speed Triple R, S	16→					CR8EIA-9	4286	0.9
	Sprint GT	10→	CR8EK	3478			CR8EIX	4218	0.7
	Sprint ST (Incl. ABS)	04→	CR8EK	3478			CR8EIX	4218	0.7
	Tiger (Incl. ABS)	06→	CR8EK	3478			CR8EIX	4218	0.7
	Tiger Sport	13→15	CR8EK	3478			CR8EIX	4218	0.7
	Tiger Sport	16→					CR8EIA-9	4286	0.9
1180	Daytona 1200	91→00	DPR8EA-9	4929			DPR8EIX-9	2202	0.9
	Trophy 1200	91→03	DPR8EA-9	4929			DPR8EIX-9	2202	0.9
1200	Bonneville T120, T120 Black	15→	LMAR8A-9	4313					0.9
	Thruxton, Thruxton R	15→	LMAR8A-9	4313					0.9
1215	Tiger Explorer	12→	CR8EK	3478			CR8EIX	4218	0.7
	Trophy (Incl. SE)	11/12→	CR8EK	3478			CR8EIX	4218	0.7
1600	Thunderbird (Twin Spark)	09→	DPR6EA-9	5531					0.9
1700	Thunderbird (Twin Spark) 1700cc option engine	09→	DPR6EA-9	5531					0.9
	Thunderbird Commander (Twin Spark)	03/14→	DPR6EA-9	5531					0.9
	Thunderbird LT (Twin Spark)	03/14→	DPR6EA-9	5531					0.9
	Thunderbird Storm (Twin Spark)	11→	DPR6EA-9	5531					0.9
2300	Rocket III Incl. X (Twin Spark)	04→	DPR7EA-9	5129			DPR7EIX-9	7803	0.9
	Rocket III Classic (Twin Spark)	06→	DPR7EA-9	5129			DPR7EIX-9	7803	0.9
	Rocket III Touring (Twin Spark)	07→	DPR7EA-9	5129			DPR7EIX-9	7803	0.9

URALMOTO									
650	Cobra, Red Star, Voyage	→00	BP7HS	5111			BPR7HIX	5944	0.8
750	Classic, Wolf	00→07	BP6HS	4511			BPR6HIX	4085	0.6

VERTEMATI									
500	S501		CR9EK	4548			CR9EIX	3521	0.7
	SR501		CR9EK	4548			CR9EIX	3521	0.7
570	S570	03→	CR9EK	4548			CR9EIX	3521	0.7

VESPA (SEE PIAGGIO)

VICTORY (POLARIS)									
1507	V92C and all 92 cu.inch models	99→01	DCPR6E	3481					1.0
	V92C and all 92 cu.inch models	02→04	CPR6EB-9	5958					0.8
1634	Hammer, Kingpin, Touring Cruiser	05→08	CPR6EB-9	5958					0.9
	Hammer 8-Ball, Kingpin 8-Ball, Vegas, Vegas 8-Ball, Vegas Jackpot	05→	CPR6EB-9	5958					0.9
1731	Arlen Ness Vision, Cory Ness Jackpot	10→	DCPR6E	3481					0.8
	Broadwalk	13→	DCPR6E	3481					0.8
	Cross Country, Cross Country Tour, Cross Roads, Jackpot, Vision 8-Ball	10→	DCPR6E	3481					0.8
	Hammer/S, Vegas Jackpot, Vision Street/Tour	08→	DCPR6E	3481					0.8
	High Ball	12→	DCPR6E	3481					0.8



CC	MODEL	DATE	STANDARD COPPER CORE	STOCK NUMBER	PLATINUM OR GOLD PALLADIUM	STOCK NUMBER	IRIDIUM	STOCK NUMBER	GAP MM
VIXEN (SEE BASHAN)									

VOR

400	EN, MX, SM	00→	CR8EK	3478			CR8EIX	4218	0.7
503	EN, MX, SM	99→	CR8EK	3478			CR8EIX	4218	0.7
530	530 (2002)	02→	CR8EK	3478			CR8EIX	4218	0.7

WHITE KNUCKLE (SEE WK)**WK**

50	Bellissima	13→	CR7HSA	4549			CR7HIX	7544	0.7
	Go 50	13→	CR7HSA	4549			CR7HIX	7544	0.7
	GP50 (Air Cooled)	10→	BPR7HS	6422			BPR7HIX	5944	0.6
	Mii 50	14→	CR7HSA	4549			CR7HIX	7544	0.7
	WASP R50	14→	CR7HSA	4549			CR7HIX	7544	0.7
125	Bellissima	14→	CR7HSA	4549			CR7HIX	7544	0.7
	GP125	13→	CR7HSA	4549			CR7HIX	7544	0.7
	RT125	14→	CR6HSA	2983			CR6HIX	7274	0.7

WUYANG

50	WY50QT Scooter	06→	C7HSA	4629			CR7HIX	7544	0.6
125	WY125-12	06→	DPR8EA-9	4929			DPR8EIX-9	2202	0.9
	WY125-16C	06→	DPR8EA-9	4929			DPR8EIX-9	2202	0.9
	WY125-24B Cub	06→	C7HSA	4629			CR7HIX	7544	0.6

XISPA

125	X125R	07→08	BP5ES	6511			BPR5EIX	6597	0.6
250	X250R	07→08	BP5ES	6511			BPR5EIX	6597	0.6
273	X280R	07→08	BP5ES	6511			BPR5EIX	6597	0.6

YAMAHA

50	CA50 (Salient)	84→87	BP6HS	4511			BPR6HIX	4085	0.6
	CG50E Jog	88→92	BPR7HS	6422			BPR7HIX	5944	0.6
	CS50 Jog R (Air Cooled)	02→07	BR8HS	4322			BR8HIX	7001	0.6
	CS50 Jog-RR (Liquid Cooled 2-Stroke)	03→07	BR8HS	4322			BR8HIX	7001	0.7
	CS50Z Jog RR	07→12	BR8HS	4322			BR8HIX	7001	0.7
	CW50 RSP (Spy)	96→98	BR8HS	4322			BR8HIX	7001	0.6
	CW50/BW50 NG Bi-Wizz, Booster, Rocket	90→95	BPR7HS	6422			BPR7HIX	5944	0.6
	CW50/BW50 NG Bi-Wizz, Booster, Rocket	96→13	BR8HS	4322			BR8HIX	7001	0.6
	CW50T/BW	90→95	BPR7HS	6422			BPR7HIX	5944	0.6
	CW50T/BW	96→13	BR8HS	4322			BR8HIX	7001	0.6
	CY50 Jog-in	90→98	BPR7HS	6422			BPR7HIX	5944	0.5
	DT50	2004	BR7HS	4122			BR7HIX	7067	0.6
	DT50M/MX	86→95	BR7HS	4122			BR7HIX	7067	0.6
	DT50R	03→06	BR9ES	5722			BR9EIX	3981	0.7
	DT50SM	2004	BR9ES	5722			BR9EIX	3981	0.7
	EW 50 Slider / Stunt	00→02	BR9HS	4522			BR9HIX	5687	0.6
	FS1	87→91	BR7HS	4122			BR7HIX	7067	0.6
	FS1E	77→78	B7HS	5110			BR7HIX	7067	0.6
	LC50 Bop 2	80→81	BP4HS	3611					0.7
	MA50 M	86→93	BP4HS	3611					0.7
	MS50	85→87	BPR6HS	7022			BPR6HIX	4085	0.6
	NS50 Aerox R	13→	BR8HS	4322			BR8HIX	7001	0.6
	PW50 H/J/K/L	81→87	BP4HS	3611					0.6
	PW50S	88→	BPR4HS	7823					0.6
	QT50	86→93	BP4HS	3611					0.7
	RD50M/MX	86→89	B7HS	5110			BR7HIX	7067	0.6
	SA50 Pasola	82→86	BP4HS	3611					0.7



CC	MODEL	DATE	STANDARD COPPER CORE	STOCK NUMBER	PLATINUM OR GOLD PALLADIUM	STOCK NUMBER	IRIDIUM	STOCK NUMBER	GAP MM
YAMAHA (CONTINUED)									
50	T50	86→89	CR6HS	7023			CR6HIX	7274	0.6
	TT-R50E	06→	CR7HSA	4549			CR7HIX	7544	0.6
	TY50M	77→80	B7HS	5110			BR7HIX	7067	0.6
	TZR50 X-Power	03→04	BR9ES	5722			BR9EIX	3981	0.7
	U50/AD/C/E	65→71	B7HS	5110			BR7HIX	7067	0.6
	V50	83→86	BR6ES	4922					0.6
	V50FM	80→85	B7HS	5110			BR7HIX	7067	0.6
	V50MA	80→85	B6HS	4510			BR6HIX	3419	0.6
	XF50 Giggle	07→09	CR7E	4578			CR7EIX	7385	0.8
	YH50 WHY	99→03	BR8HS	4322			BR8HIX	7001	0.6
	YN50 Neo's, Ovetto	98→08	BR7HS	4122			BR7HIX	7067	0.6
	YN50 Neo's Easy (2-Stroke)	13→	BR8HS	4322			BR8HIX	7001	0.6
	YN50 Neo's 4s	09→	CR7E	4578			CR7EIX	7385	0.8
	YQ50 Aerox, Nitro	98→07	BR8HS	4322			BR8HIX	7001	0.6
	YQ50 Aerox R	04→	BR8HS	4322			BR8HIX	7001	0.6
	YZ50H	80→81	B9ES	2611			BR9EIX	3981	0.6
	ZE50 (Zest)	93→96	BR7HS	4122			BR7HIX	7067	0.6
70	V70	71→80	B7HS	5110			BR7HIX	7067	0.6
80	CV80	82→86	BPR6HS	7022			BPR6HIX	4085	0.6
	DT80MX	82→85	B8HS	5510			BR8HIX	7001	0.6
	DT80MXS	86→87	BP8HS	2630			BPR8HIX	6742	0.6
	LB2-80 Chappy	81→85	B6HS	4510			BR6HIX	3419	0.6
	PW80K	82→95	BP6HS	4511			BPR6HIX	4085	0.6
	PW80S	96→11	BPR6HS	7022			BPR6HIX	4085	0.6
	RD80LC11A	82→84	B8ES	2411			BR8EIX	5044	0.6
	T80 Townmate	83→97	CR7HS	7223			CR7HIX	7544	0.6
	TY80B	73→84	B6HS	4510			BR6HIX	3419	0.6
	V80	79→87	BPR6HS	7022			BPR6HIX	4085	0.6
	YZ80 (1/2", 12.7mm Thread Reach)	1974	B7HS	5110			BR7HIX	7067	0.5
	YZ80 B (1/2", 12.7mm Thread Reach)	1975	B8HS	5510			BR8HIX	7001	0.6
	YZ80 (3/4", 19mm Thread Reach)	76→80	B8ES	2411			BR8EIX	5044	0.6
	YZ80 (3/4", 19mm Thread Reach)	81→83	B9ES	2611			BR9EIX	3981	0.6
	YZ80 (3/4", 19mm Thread Reach)	84→92	BR9EG	3230			BR9EIX	3981	0.5
YZ80	93→99	B10EG	3630	B10EGV	5927	BR10EIX	6801	0.5	
YZ80	00→01	BR10EG	3830			BR10EIX	6801	0.6	
85	YZ85	03→	BR10EG	3830			BR10EIX	6801	0.6
90	TT90-R	03→07	CR6HSA	2983			CR6HIX	7274	0.7
	V90	71→80	B7HS	5110			BR7HIX	7067	0.5
100	DT100 A/B (1/2", 12.7mm Thread Reach)	74→75	B8HS	5510			BR8HIX	7001	0.5
	DT100 C (3/4", 19mm Thread Reach)	1976	B7ES	1111			BR7EIX	6664	0.5
	DT100	77→83	B8ES	2411			BR8EIX	5044	0.5
	RS100 (B/X/DX/S)	75→76	B8HS	5510			BR8HIX	7001	0.5
	RS100P	1978	BP6HS	4511			BPR6HIX	4085	0.5
	RT100	92→00	B7ES	1111			BR7EIX	6664	0.6
	RXS100	83→97	BR8HS	4322			BR8HIX	7001	0.6
	YB100	87→92	B7HS	5110			BR7HIX	7067	0.5
	YN100 Neos, Ovetto	11/99→03	BR8HS	4322			BR8HIX	7001	0.5
	YQ100 Aerox, Nitro	00→04	BR8HS	4322			BR8HIX	7001	0.5
	YZ100H	76→82					BR10EIX	6801	0.5
YZ100K	1983	B9EG	3530	B9EGV	5827	BR9EIX	3981	0.5	
YZ100L	1984	BR9EG	3230			BR9EIX	3981	0.6	
114	XC115S D'elight	14→	CR6HSA	2983			CR6HIX	7274	0.6
125	AS3	71→76	B8HS	5510			BR8HIX	7001	0.6
	BL125 Beluga	85→87	BPR8HS	3725			BPR8HIX	6742	0.6
	Black X-max 125	09→	CPR9EA-9	2308			CR9EIX	3521	0.9
	BW's 125	10→11	CR7E	4578			CR7EIX	7385	0.8
	DT125 (E/ED/MX)	74→83	B8ES	2411			BR8EIX	5044	0.5
	DT125LC	84→87	BR8ES	5422			BR8EIX	5044	0.6
	DT125R	88→04	BR9ES	5722			BR9EIX	3981	0.6
	DT125RE	04→07	BR8ES	5422			BR8EIX	5044	0.7
	DT125X	04→07	BR8ES	5422			BR8EIX	5044	0.6
	GPD125A N-Max	15→	CPR8EA-9	2306			CR8EIX	4218	0.9
	HW125 Xenter	12→	CPR9EA-9	2308			CR9EIX	3521	0.9



CC	MODEL	DATE	STANDARD COPPER CORE	STOCK NUMBER	PLATINUM OR GOLD PALLADIUM	STOCK NUMBER	IRIDIUM	STOCK NUMBER	GAP MM
YAMAHA (CONTINUED)									
125	IT125 G, H, J	80→84	B9EG	3530	B9EGV	5827	BR9EIX	3981	0.6
	MT-125	14→	CR9E	6263			CR9EIX	3521	0.8
	MW125 Tricity	14→	CR7E	4578			CR7EIX	7385	0.8
	NXC125 Cygnus X	04→	CR7E	4578			CR7EIX	7385	0.8
	RD125 (½", 12.7mm Thread Reach)	1975	B8HS	5510			BR8HIX	7001	0.6
	RD125 C-DX, DX, D-DX (¾", 19mm Thread Reach)	76→84	B8ES	2411			BR8EIX	5044	0.6
	RD125LC	85→86	BR9ES	5722			BR9EIX	3981	0.7
	RDZ125	87→89	BR9ES	5722			BR9EIX	3981	0.7
	RS125 (Z/DX)	76→84	B8HS	5510			BR8HIX	7001	0.5
	RS125E	74→80	B7HS	5110			BR7HIX	7067	0.6
	SR125	81→85	D8EA	2120	DR8EVX	6354	DR8EIX	6681	0.7
	SR125	89→03	DR8EA	7162	DR8EVX	6354	DR8EIX	6681	0.6
	TDR 125	93→97	BR9ES	5722			BR9EIX	3981	0.7
	TT-R125/LW	00→	CR7HSA	4549			CR7HIX	7544	0.7
	TT-R125E	05→	CR7HSA	4549			CR7HIX	7544	0.7
	TW125	98→04	DR8EA	7162	DR8EVX	6354	DR8EIX	6681	0.6
	TY125	75→89	B7ES	1111			BR7EIX	6664	0.6
	TZR125	87→93	BR9ES	5722			BR9EIX	3981	0.7
	TZR125R	93→97	BR9ECM	3252			BR9ECMIX	2707	0.7
	VP125 X-City	07→12	CPR9EA-9	2308			CR9EIX	3521	0.9
	WR125R	09→	CR8E	1275			CR8EIX	4218	0.7
	WR125X	09→	CR8E	1275			CR8EIX	4218	0.7
	XC125	92→96	CR6HSA	2983			CR6HIX	7274	0.6
	XC125 Cygnus	95→99	CR7E	4578			CR7EIX	7385	0.8
	XC125 Vity 125	08→	CR7E	4578			CR7EIX	7385	0.6
	XC125R Majesty S	14→	CPR8EA-9	2306			CR8EIX	4218	0.9
	XN125 Teos, Doodo	00→03	CR8E	1275			CR8EIX	4218	0.5
	XQ125 Maxster, Thunder	01→03	CR8E	1275			CR8EIX	4218	0.7
	XT125	82→85	D8EA	2120	DR8EVX	6354	DR8EIX	6681	0.7
	XT125R	05→	CR7HSA	4549			CR7HIX	7544	0.7
	XT125X	05→	CR7HSA	4549			CR7HIX	7544	0.7
	XV125 Virago	97→01	CR6HSA	2983			CR6HIX	7274	0.6
	XVS125 Drag Star	99→04	CR7HSA	4549			CR7HIX	7544	0.7
	YA6	64→67	B7HS	5110			BR7HIX	7067	0.6
	YBR125	05→	CR6HSA	2983			CR6HIX	7274	0.6
	YBR125 Custom	09→	CR6HSA	2983			CR6HIX	7274	0.6
	YP125 Majesty, Skyliner	99→13	CR8E	1275			CR8EIX	4218	0.7
	YP125R X-Max 125	00→05	CR8E	1275			CR8EIX	4218	0.7
	YP125R X-Max 125	06→13	CPR9EA-9	2308			CR9EIX	3521	0.9
	YP125RA X-MAX 125	14→	CPR9EA-9	2308			CR9EIX	3521	0.9
	YZ125 (Air Cooled)	74→80	B9EG	3530	B9EGV	5827	BR9EIX	3981	0.5
YZ125 (Liquid Cooled)	81→91	B9EG	3530	B9EGV	5827	BR9EIX	3981	0.5	
YZ125	91→96	BR9EG	3230			BR9EIX	3981	0.5	
YZ125	96→98	B9EG	3530	B9EGV	5827	BR9EIX	3981	0.5	
YZ125	98→05	BR9EG	3230			BR9EIX	3981	0.5	
YZ125	05→					BR9EIX	3981	0.5	
YZF-R125	08→	CR8E	1275			CR8EIX	4218	0.7	
175	DT175 (E/MX)	78→85	B8ES	2411			BR8EIX	5044	0.5
	IT175H	81→83	B9EG	3530	B9EGV	5827	BR9EIX	3981	0.5
	TY175 (E/JC)	74→81	B7ES	1111			BR7EIX	6664	0.5
200	CS5E	72→73	B8HS	5510			BR8HIX	7001	0.6
	RD200 (All models except B)	76→83	B8ES	2411			BR8EIX	5044	0.6
	RD200B (½", 12.7mm Thread Reach)	1976	B8HS	5510			BR8HIX	7001	0.6
	RD200B (¾", 19mm Thread Reach)	1976	B8ES	2411			BR8EIX	5044	0.6
	RS200	79→81	B8ES	2411			BR8EIX	5044	0.6
	WR200E	91→92	BR9ES	5722			BR9EIX	3981	0.6
250	Black X-max 250	09→	DR8EA	7162	DR8EVX	6354	DR8EIX	6681	0.7
	DT250 (E/MX)	75→79	B8EG	3430	B8EGV	5627	BR8EIX	5044	0.6
	IT250 D-K	77→83	B9EG	3530	B9EGV	5827	BR9EIX	3981	0.6
	MX250	1975	B8EG	3430	B8EGV	5627	BR8EIX	5044	0.6
	RD250 (D)	1977	B8ES	2411			BR8EIX	5044	0.6
	RD250 (E/F)	78→79	B9ES	2611			BR9EIX	3981	0.7
	RD250 (LC)	80→85	BR8ES	5422			BR8EIX	5044	0.6



CC	MODEL	DATE	STANDARD COPPER CORE	STOCK NUMBER	PLATINUM OR GOLD PALLADIUM	STOCK NUMBER	IRIDIUM	STOCK NUMBER	GAP MM
YAMAHA (CONTINUED)									
250	SR250	80→82	BP7ES	2412			BPR7EIX	4055	0.7
	SR250S	93→95	BP7ES	2412			BPR7EIX	4055	0.7
	TDR250	88→92	BR9ES	5722			BR9EIX	3981	0.7
	TT250R	03→05	CR9E	6263			CR9EIX	3521	0.8
	TY250 A-D	73→77	B7ES	1111			BR7EIX	6664	0.5
	TY250N	84→85	BR8ES	5422			BR8EIX	5044	0.6
	TY250R	86→91	BR6ES	4922					0.6
	TY250Z	93→96					BPR6EIX	6637	0.7
	TZR250	87→91	BR9ES	5722			BR9EIX	3981	0.6
	VP250 X-City	07→	DPR8EA-9	4929			DPR8EIX-9	2202	0.9
	WR250F	01→03	CR8E	1275			CR8EIX	4218	0.7
	WR250F (S)	04→06	CR8E	1275			CR8EIX	4218	0.7
	WR250F (S)	07→	CR9E	6263			CR9EIX	3521	0.8
	WR250R	08→	CR9EK	4548			CR9EIX	3521	0.7
	WR250X	08→	CR9EK	4548			CR9EIX	3521	0.7
	WR250Z	93→98	B8EG	3430	B8EGV	5627	BR8EIX	5044	0.5
	XS250 (E/CW/SE/C)	77→80	BP7ES	2412			BPR7EIX	4055	0.7
	XT250	80→83	BP7ES	2412			BPR7EIX	4055	0.7
	XV250 Virago	95→00	CR6HS	7023			CR6HIX	7274	0.6
	XVS250 Drag Star	01→04	CR6HSA	2983			CR6HIX	7274	0.7
	YBR250	09→11	DR8EA	7162	DR8EVX	6354	DR8EIX	6681	0.7
	YP250 Majesty	96→04	DR8EA	7162	DR8EVX	6354	DR8EIX	6681	0.8
	YP250R X-Max	05→11	DR8EA	7162	DR8EVX	6354	DR8EIX	6681	0.8
	YP250RA X-MAX 250	12→	DPR8EA-9	4929			DPR8EIX-9	2202	0.9
	YZ250	74→77	B8EG	3430	B8EGV	5627	BR8EIX	5044	0.6
	YZ250	78→81	B9EG	3530	B9EGV	5827	BR9EIX	3981	0.6
	YZ250 (2-Stroke)	82→	BR8EG	3130			BR8EIX	5044	0.6
	YZ250F (4-Stroke)	01→13	CR8E	1275			CR8EIX	4218	0.7
YZ250F	14→	LMAR8G	95627					0.8	
YZ250WR	93→04	B8EG	3430	B8EGV	5627	BR8EIX	5044	0.6	
264	VP300 Versity	03→04	DR8EA	7162	DR8EVX	6354	DR8EIX	6681	0.7
321	MT-03	16→	CR8E	1275			CR8EIX	4218	0.7
	YZF-R3	15→	CR8E	1275			CR8EIX	4218	0.7
350	RD350 (Air Cooled) (1/2", 12.7mm Thread Reach)	73→74	B8HS	5510			BR8HIX	7001	0.6
	RD350 (Air Cooled) (3/4", 19mm Thread Reach)	1975	B8ES	2411			BR8EIX	5044	0.6
	RD350LC-YPVS (Liquid Cooled)	83→85	BR8ES	5422			BR8EIX	5044	0.6
	RD350 (Liquid Cooled)	86→95	BR9ES	5722			BR9EIX	3981	0.6
	XT350	85→92	DR8ES-L	2923	DR8EVX	6354	DR8EIX	6681	0.6
400	DT400 (E/MX)	75→79	B9ES	2611			BR9EIX	3981	0.6
	FZR400 Genesis	86→87	CR8E	1275			CR8EIX	4218	0.7
	FZR400 EXUP	88→90	CR8E	1275			CR8EIX	4218	0.7
	FZR400 RR/SP	91→95	CR8E	1275			CR8EIX	4218	0.7
	IT400	76→79	B8EG	3430	B8EGV	5627	BR8EIX	5044	0.6
	MX400	1975	B8EG	3430	B8EGV	5627	BR8EIX	5044	0.6
	RD400 (C/D)	76→77	B8ES	2411			BR8EIX	5044	0.6
	RD400 (E/F)	78→79	B9ES	2611			BR9EIX	3981	0.6
	SR400	14→	BPR6ES	7822			BPR6EIX	6637	0.8
	WR400	98→00	CR8E	1275			CR8EIX	4218	0.7
	XS400 (E/2-E/F) (Ø14mm Plug)	77→82	BP7ES	2412			BPR7EIX	4055	0.6
	XS400 (Ø12mm Plug)	82→83	D8EA	2120	DR8EVX	6354	DR8EIX	6681	0.7
	YP400 Majesty	04→11	CR7E	4578			CR7EIX	7385	0.8
	YP400R X-MAX	13→	CR7E	4578			CR7EIX	7385	0.8
	YZ400 (C/E)	76→79	B8EG	3430	B8EGV	5627	BR8EIX	5044	0.6
YZ400F	98→99	CR8E	1275			CR8EIX	4218	0.7	
426	WR426F Enduro	01→02	CR8E	1275			CR8EIX	4218	0.7
	YZ426F Motocross	00→03	CR8E	1275			CR8EIX	4218	0.7
450	WR450F (S)	04→11	CR8E	1275			CR8EIX	4218	0.7
	WR450F Injection	12→	CR8E	1275			CR8EIX	4218	0.8
	YZ450F	03→	CR8E	1275			CR8EIX	4218	0.7
465	IT465H	81→82	B8EG	3430	B8EGV	5627	BR8EIX	5044	0.6
	YZ465H	80→82	B8EG	3430	B8EGV	5627	BR8EIX	5044	0.6
490	YZ490 (J/K/L/N/S/T/U)	82→90	B8EG	3430	B8EGV	5627	BR8EIX	5044	0.6



CC	MODEL	DATE	STANDARD COPPER CORE	STOCK NUMBER	PLATINUM OR GOLD PALLADIUM	STOCK NUMBER	IRIDIUM	STOCK NUMBER	GAP MM
YAMAHA (CONTINUED)									
500	HL500	78→79	BP7ES	2412			BPR7EIX	4055	0.6
	RD500LC	84→87	BR9HS	4522			BR9HIX	5687	0.6
	SR500/E	78→83	BP7ES	2412			BPR7EIX	4055	0.6
	XP500 TMAX	01→11	CR7E	4578			CR7EIX	7385	0.7
	XS500/E	75→78	D9EA	2420			DR9EIX	4772	0.6
	XT500 (C/E)	77→83	BP7ES	2412			BPR7EIX	4055	0.6
530	XP500 TMAX	12→	CR7E	4578			CR7EIX	7385	0.7
535	XV535/S/DX (Virago)	88→04	BPR7ES	2023			BPR7EIX	4055	0.7
550	XJ550	81→85	D8EA	2120	DR8EVX	6354	DR8EIX	6681	0.6
	XT550	82→84	DR7ES	3123					0.7
	XZ550	82→85	DR8ES	5423			DR9EIX	4772	0.7
600	FZ600 (Air Cooled)	86→88	DR8ES-L	2923	DR8EVX	6354	DR8EIX	6681	0.7
	FZ6-S / Fazer	04→06	CR9EK	4548			CR9EIX	3521	0.7
	FZ6-S S2 / Fazer S2	07→	CR9EK	4548			CR9EIX	3521	0.7
	FZR600 (Liquid Cooled)	89→94	CR9E	6263			CR9EIX	3521	0.8
	FZR600R	94→96	CR9E	6263			CR9EIX	3521	0.8
	FZS600 Fazer	98→04	CR8E	1275			CR8EIX	4218	0.6
	SRX600	86→89	DPR7EA-9	5129			DPR7EIX-9	7803	0.9
	TT600	86→03	DPR8EA-9	4929			DPR8EIX-9	2202	0.9
	TT600RE	2004	DPR8EA-9	4929			DPR8EIX-9	2202	0.9
	XJ6 (Incl. ABS)	08→	CR9E	6263			CR9EIX	3521	0.8
	XJ6 Diversion (Incl. ABS)	08→	CR9E	6263			CR9EIX	3521	0.8
	XJ6 Diversion F ABS	10→	CR9E	6263			CR9EIX	3521	0.8
	XJ600	84→91	DR8ES-L	2923	DR8EVX	6354	DR8EIX	6681	0.7
	XJ600S/N (Diversion)	92→02	CR8E	1275			CR8EIX	4218	0.6
	XT600	84→88	DPR7EA-9	5129			DPR7EIX-9	7803	0.9
	XT600E	90→02	DPR8EA-9	4929			DPR8EIX-9	2202	0.9
	XT600Z Tenere	84→90	DPR7EA-9	5129			DPR7EIX-9	7803	0.9
	XT600ZE	86→91	DPR7EA-9	5129			DPR7EIX-9	7803	0.9
	YZF600R Thunder Cat	96→03	CR9E	6263			CR9EIX	3521	0.8
	YZF-R6	99→05	CR10EK	2360			CR10EIX	6482	0.7
	YZF-R6	06→	CR10EK	2360			CR10EIX	6482	0.7
650	XJ650	80→84	BP7ES	2412			BPR7EIX	4055	0.7
	XJ650T	82→85	BPR8ES	3923			BPR8EIX	6684	0.7
	XS2	72→73	B8ES	2411			BR8EIX	5044	0.6
	XS650 (E, SE, Special)	78→82	BP7ES	2412			BPR7EIX	4055	0.7
	XVS650 Drag Star	97→02	DPR7EA-9	5129			DPR7EIX-9	7803	0.9
	XVS650A Drag Star	98→06	DPR7EA-9	5129			DPR7EIX-9	7803	0.9
660	MT-03	05→12	CR7E	4578			CR7EIX	7385	0.8
	SZR660	95→97	DPR9EA-9	5329			DPR9EIX-9	5545	0.9
	XT660 R/X	04→14	CR7E	4578			CR7EIX	7385	0.8
	XT660Z Tenere	08→15	CR7E	4578			CR7EIX	7385	0.8
	XTZ660 Tenere	91→99	DPR8EA-9	4929			DPR8EIX-9	2202	0.9
689	MT-07	14→	LMAR8A-9	4313					0.9
	Tracer 700	16→	LMAR8A-9	4313					0.9
	XSR700	15→	LMAR8A-9	4313					0.9
750	FZ750	85→91	DR8ES-L	2923	DR8EVX	6354	DR8EIX	6681	0.6
	FZR750R	87→89	DR8ES-L	2923	DR8EVX	6354	DR8EIX	6681	0.6
	FZR750R OW01	89→91	DR9EA	3437			DR9EIX	4772	0.6
	FZX750	87→89	DR8ES-L	2923	DR8EVX	6354	DR8EIX	6681	0.6
	XJ750 (SECA)	82→84	BPR7ES	2023			BPR7EIX	4055	0.7
	XS750 (C, D, E, SE)	80→82	BPR7ES	2023			BPR7EIX	4055	0.7
	XTZ750 Super Tenere	89→95	DPR8EA-9	4929			DPR8EIX-9	2202	0.9
	XV750 SE	81→83	BPR7ES	2023			BPR7EIX	4055	0.7
	XV750 Virago	92→96	BPR7ES	2023			BPR7EIX	4055	0.7
	YZF750R	93→96	CR9E	6263			CR9EIX	3521	0.7
	YZF750-R7 OW02	1999			R0256R-10	7641	R0373A-10	4940	0.8
	YZF750SP	93→96	CR9E	6263			CR9EIX	3521	0.7
779	FZ8, Fazer8	10→	CR9E	6263			CR9EIX	3521	0.7
850	MT-09	13→	CPR9EA-9	2308			CR9EIX	3521	0.9
	TDM850	91→95	DPR9EA-9	5329			DPR9EIX-9	5545	0.9
	TDM850	96→01	DPR8EA-9	4929			DPR8EIX-9	2202	0.9
	Tracer 900	16→	CPR9EA-9	2308			CR9EIX	3521	0.9



CC	MODEL	DATE	STANDARD COPPER CORE	STOCK NUMBER	PLATINUM OR GOLD PALLADIUM	STOCK NUMBER	IRIDIUM	STOCK NUMBER	GAP MM
YAMAHA (CONTINUED)									
850	TRX850	96→99	DPR8EA-9	4929			DPR8EIX-9	2202	0.9
	XS850	80→85	BP7ES	2412			BPR7EIX	4055	0.7
	XSR900	02/16→	CPR9EA-9	2308			CR9EIX	3521	0.9
900	TDM 900	02→10	DPR8EA-9	4929			DPR8EIX-9	2202	0.9
	XJ900F/S	83→94	BPR8ES	3923			BPR8EIX	6684	0.7
	XJ900S Diversion	95→04	DPR8EA-9	4929			DPR8EIX-9	2202	0.8
950	XV950, R	14→	CPR7EA-9	3901			CR7EIX	7385	0.9
	XVS950A Midnight Star	09→12	CPR7EA-9	3901			CR7EIX	7385	0.9
1000	FZR1000	87→88	DR8ES-L	2923	DR8EVX	6354	DR8EIX	6681	0.7
	FZR1000 EXUP	89→93	DR8ES-L	2923	DR8EVX	6354	DR8EIX	6681	0.7
	FZR1000 EXUP	93→95	DR8EA	7162	DR8EVX	6354	DR8EIX	6681	0.8
	FZS1000 Fazer	01→05	CR9E	6263			CR9EIX	3521	0.7
	FZ-1 / Fazer	06→12	CR9EK	4548			CR9EIX	3521	0.7
	GTS1000A	93→96	DPR8EA-9	4929			DPR8EIX-9	2202	0.9
	MT-10	05/16→	LMAR9E-J	6884					0.7
	TR1	81→85	BP7ES	2412			BPR7EIX	4055	0.7
	XV1000SE	86→88	BPR7ES	2023			BPR7EIX	4055	0.7
	YZF1000R Thunderace	96→02	DR8EA	7162	DR8EVX	6354	DR8EIX	6681	0.8
	YZF-R1	98→01	CR9E	6263			CR9EIX	3521	0.7
	YZF-R1	02→03					CR9EIA-9	6289	0.9
	YZF-R1 (19mm Thread Reach)	04→08	CR9EK	4548			CR9EIX	3521	0.7
	YZF-R1SP (19mm Thread Reach)	2006	CR9EK	4548			CR9EIX	3521	0.7
YZF-R1 (Incl. Anniversary) (26.5mm Thread Reach)	09→	LMAR9E-J	6884					0.7	
1100	BT1100 Bulldog	02→06	BPR7ES	2023			BPR7EIX	4055	0.7
	FJ1100	84→85	DPR8EA-9	4929			DPR8EIX-9	2202	0.9
	XS1100 (E/S)	81→84	BP6ES	7811			BPR6EIX	6637	0.7
	XV1100 Virago	89→98	BPR7ES	2023			BPR7EIX	4055	0.7
	XVS1100/A Drag Star / Classic	99→06	BPR7ES	2023			BPR7EIX	4055	0.7
1200	FJ1200/A, XVZ12TD	86→96	DPR8EA-9	4929			DPR8EIX-9	2202	0.9
	V-Max 1200	91→02	DPR8EA-9	4929			DPR8EIX-9	2202	0.9
	XJR1200	95→98	DPR8EA-9	4929			DPR8EIX-9	2202	0.8
	XT1200Z Super Tenere (Twin Spark)	10→	CPR8EB-9	6607					0.9
	XT1200Z World Crosser (Twin Spark)	12→	CPR8EB-9	6607					0.9
	XVZ12TD Venture	85→86	DPR8EA-9	4929			DPR8EIX-9	2202	0.8
1300	FJR1300/A	01→05	CR8E	1275			CR8EIX	4218	0.7
	FJR1300A/AS	06→12	CR8E	1275			CR8EIX	4218	0.7
	FJR1300A/AS	13→	CPR8EA-9	2306			CR8EIX	4218	0.9
	XJR1300/SP	99→	DPR8EA-9	4929			DPR8EIX-9	2202	0.9
	XJR1300 Racer	15→	DPR8EA-9	4929			DPR8EIX-9	2202	0.9
	XVS1300A Midnight Star	07→	LMAR7A-9	4908					0.9
	XVS1300CU Custom	14→	LMAR7A-9	4908					0.9
	XVZ1300 TF Venture Star	99→01	DPR8EA-9	4929			DPR8EIX-9	2202	0.8
	XVZ13A Royal Star	96→98	DPR7EA-9	5129			DPR7EIX-9	7803	0.9
1600	XV1600/A Wild Star	99→02	DPR7EA-9	5129			DPR7EIX-9	7803	0.9
1670	MT-01 1600 (Twin Spark)	05→08	DPR7EA-9	5129			DPR7EIX-9	7803	0.9
1679	VMAX 1700	08→					CR9EIA-9	6289	0.9
1700	XV1700 Road Star	03→08	DPR7EA-9	5129			DPR7EIX-9	7803	0.9
1900	XV1900 Midnight Star (Twin Spark)	06→13	DPR8EA-9	4929			DPR8EIX-9	2202	0.8

YAMASAKI

125	YM125-3	11→	D8EA	2120	DR8EVX	6354	DR8EIX	6681	0.6
-----	---------	-----	------	------	--------	------	--------	------	-----

YIYING (SEE BENZHOU)

ZING (SEE LIFAN)

ZNEN

125	ZN125F Firenze 125		C7HSA	4629			CR7HIX	7544	0.6
-----	--------------------	--	-------	------	--	--	--------	------	-----

2 Wheel



CC	MODEL	DATE	STANDARD COPPER CORE	STOCK NUMBER	PLATINUM OR GOLD PALLADIUM	STOCK NUMBER	IRIDIUM	STOCK NUMBER	GAP MM
ZONGSHEN									
125	Arktix, Predator ZS125-GY10		DR8EA	7162	DR8EVX	6354	DR8EIX	6681	0.7
250	Storm ZS250GS		D8EA	2120	DR8EVX	6354	DR8EIX	6681	0.6



CC	MODEL	DATE	STANDARD COPPER CORE	STOCK NUMBER	PLATINUM OR GOLD PALLADIUM	STOCK NUMBER	IRIDIUM	STOCK NUMBER	GAP MM
ADLY									
103	ATV-110 Fun bike	10→	BP7HS	5111			BPR7HIX	5944	0.7
300	ATV-300XS	07→11	DR8EA	7162	DR8EVX	6354	DR8EIX	6681	0.7
320	ATV-320S, ATV-320U	07→	CR8E	1275			CR8EIX	4218	0.7

APACHE									
50	RLX 50	08→	BR8HSA	5539			BPR8HIX	6742	0.7
	Tomahawk Mini 50 (4-Stroke)	→07	CR7HSA	4549			CR7HIX	7544	0.6
	Tomahawk Mini 50 (2-Stroke)	08→	BR8HSA	5539			BPR8HIX	6742	0.7
100	Army 100	05→	BR8HSA	5539			BPR8HIX	6742	0.6
	RLX 100	05→	BR8HSA	5539			BPR8HIX	6742	0.6
	SX 100	04→09	BR8HSA	5539			BPR8HIX	6742	0.6
	ZX100	08→09	BR8HSA	5539			BPR8HIX	6742	0.7
150	RLX 150 H	06→	CR7HSA	4549			CR7HIX	7544	0.6
	RLX 150	06→	CR7HSA	4549			CR7HIX	7544	0.6
	Superbug 150	06→	CR7HSA	4549			CR7HIX	7544	0.6
170	RLX 170 S	06→	DR8EA	7162	DR8EVX	6354	DR8EIX	6681	0.6
250	RLX 250 AX	06→08	DR8EA	7162	DR8EVX	6354	DR8EIX	6681	0.6
	RLX 250 S	06→07	CR8HS	7423	CR8HVX	7236	CR8HIX	7669	0.7
	RLX 250 SX	06→07	CR8HS	7423	CR8HVX	7236	CR8HIX	7669	0.7
280	RLX 320	07→	DPR7EA-9	5129			DPR7EIX-9	7803	0.9
360	RLX 400	10→	CR8E	1275			CR8EIX	4218	0.7
450	RLX 450	08→	CR8E	1275			CR8EIX	4218	0.7
500	RLX F500	10→	DPR7EA-9	5129			DPR7EIX-9	7803	0.9

ARCTIC CAT									
50	50	06→	CR7HSA	4549			CR7HIX	7544	0.6
90	90	06→	CR7HSA	4549			CR7HIX	7544	0.6
150	150	09→	DR8EA	7162	DR8EVX	6354	DR8EIX	6681	0.7
250	250	01→	DR7EA	7839					0.6
300	300	05→	DR7EA	7839					0.6
	DVX 300	08→	DPR7EA-9	5129			DPR7EIX-9	7803	0.9
366	400 H1	08→	CR7E	4578			CR7EIX	7385	0.7
400	400	03→	CR7E	4578			CR7EIX	7385	0.7
	DVX 400	04→08	CR7E	4578			CR7EIX	7385	0.7
500	500	97→	CR6E	6965					0.8
550	550	09→	CPR8E	7411			CR8EIX	4218	0.8
650	650	04→05	CR7E	4578			CR7EIX	7385	0.7
	650 H1	05→	CPR8E	7411			CR8EIX	4218	0.8
700	700 H1	09→	CPR8E	7411			CR8EIX	4218	0.8
	Wildcat Trail	14→	CR8EB	7784			CR8EIX	4218	0.7
950	1000 Thundercat H2	09→	CPR8E	7411			CR8EIX	4218	0.8

BLAST (LEM)									
50	50		B7HS	5110			BR7HIX	7067	0.6
100	100		B7HS	5110			BR7HIX	7067	0.6

BOMBARDIER (→05)									
50	DS 50 (Rotax)	02→03	BPR7HS	6422			BPR7HIX	5944	0.6
	DS 50	04→05	BR9ECS	3570					0.7
90	DS 90 (Rotax 2-Stroke)	02→03	BPR7HS	6422			BPR7HIX	5944	0.6
	DS 90 (Rotax 2-Stroke)	04→05	BR9ECS	3570					0.7
	DS 90 (Rotax 4-Stroke)	02→	CR7HSA	4549			CR7HIX	7544	0.6
200	Rally (Rotax)	03→05	CR8E	1275			CR8EIX	4218	0.7
330	Outlander 330 HO (Rotax 4-TEC)	04→05	BR9ECS	3570					0.7
400	Outlander 400 HO (Rotax 4-TEC) Ø12mm Plug	03→	DCPR8E*	4179			DCPR8EIX	6546	0.6
	Outlander 400 Ø14mm Plug	04→	BR9ECS	3570					0.7



* Please note DCPR8E 4339 has a removable terminal nut, whereas DCPR8E 4179 has a fixed terminal nut





CC	MODEL	DATE	STANDARD COPPER CORE	STOCK NUMBER	PLATINUM OR GOLD PALLADIUM	STOCK NUMBER	IRIDIUM	STOCK NUMBER	GAP MM
BOMBARDIER (→05) (CONTINUED)									
500	Traxter (Rotax) Ø12mm Plug	98→02	DR8EA	7162	DR8EVX	6354	DR8EIX	6681	0.7
	Traxter (Rotax) Ø14mm Plug	03→	BR9ECS	3570					0.7
	Traxter CVT	2005	DCPR8E*	4179			DCPR8EIX	6546	0.7
650	DS 650 (Rotax) Ø12mm Plug	00→05	DR8EA	7162	DR8EVX	6354	DR8EIX	6681	0.7
	Quest 650 (Rotax 4-TEC) Ø12mm Plug	02→03	DR8EA	7162	DR8EVX	6354	DR8EIX	6681	0.7
	Quest 650 Ø14mm Plug	03→	BR9ECS	3570					0.7
	Traxter CVT	2005	DCPR8E*	4179			DCPR8EIX	6546	0.7

CAN-AM (BRP)									
50	DS 50	2006	BR9ECS	3570					0.7
70	DS 7	08→	CR7HSA	4549			CR7HIX	7544	0.7
90	DS 90 (Rotax 2-Stroke)	2006	BR9ECS	3570					0.7
	DS 90 (Rotax 4-Stroke)	06→	CR7HSA	4549			CR7HIX	7544	0.6
200	Rally (Rotax)	06→07	CR8E	1275			CR8EIX	4218	0.7
250	DS 250	06→	CR8E	1275			CR8EIX	4218	0.7
400	Outlander 400 HO (Rotax 4-TEC) Ø12mm Plug	06→	DCPR8E*	4179			DCPR8EIX	6546	0.6
	Outlander 400 Ø14mm Plug	06→	BR9ECS	3570					0.7
	Outlander MAX	13→	DCPR8E*	4179			DCPR8EIX	6546	0.7
450	DS 450	08→	DCPR9E	2641			DCR9EIX	6650	0.7
	Outlander L, L MAX	15→	LMAR8D-J	93444					0.8
500	Outlander 500	07→14	DCPR8E*	4179			DCPR8EIX	6546	0.7
	Outlander L, L MAX	15→	DCPR8E*	4179			DCPR8EIX	6546	0.7
	Renegade 500	08→	DCPR8E*	4179			DCPR8EIX	6546	0.7
	Traxter (Rotax) Ø14mm Plug	06→	BR9ECS	3570					0.7
570	Outlander L MAX	15→	DCPR8E*	4179			DCPR8EIX	6546	0.7
650	DS 650 (Rotax) Ø12mm Plug	06→07	DR8EA	7162	DR8EVX	6354	DR8EIX	6681	0.7
	Outlander 650	06→	DCPR8E*	4179			DCPR8EIX	6546	0.7
	Outlander 6x6	15→	DCPR8E*	4179			DCPR8EIX	6546	0.7
	Quest 650 Ø14mm Plug	06→	BR9ECS	3570					0.7
800	Commander 800	11→	DCPR8E*	4179			DCPR8EIX	6546	0.7
	Outlander 800 (Incl. R, X & XC models)	06→	DCPR8E*	4179			DCPR8EIX	6546	0.7
	Renegade 800	07→	DCPR8E*	4179			DCPR8EIX	6546	0.7
1000	Commander 1000	11→	DCPR8E*	4179			DCPR8EIX	6546	0.7
	Maverick	13→	LMAR8C-9	93833					0.9
	Outlander 6x6	15→	DCPR8E*	4179			DCPR8EIX	6546	0.7

CECTEK									
497	Gladiator	09→	CR7E	4578			CR7EIX	7385	0.7
	Quadrift	09→	CR7E	4578			CR7EIX	7385	0.7

CLUB CAR									
719	Carryall 294, 295 (Kubota D722 diesel engine)	04→	YE01	2649					-

CPI									
50	ATV 50	09→	BPR7HS	6422			BPR7HIX	5944	0.7
	XT50R	09→	BR7HS	4122			BR7HIX	7067	0.7
100	ATV 100	03→	BPR7HS	6422			BPR7HIX	5944	0.7
200	ATV 200		BR7HS	4122			BR7HIX	7067	0.7

CUB CADET									
624	Volunteer 4x4 (Kohler CH640 engine)	09→	BCPR5ES	6130			BCPR5EIX	5688	0.7
747	Volunteer 4x4 EFI (Kohler Aegis LH775 engine)	12→	BPR5E	7075			BPR5EIX	6597	0.7
854	Volunteer 4x4D (Yanmar diesel engine)		Y1021J	97627					-



* Please note DCPR8E 4339 has a removable terminal nut, whereas DCPR8E 4179 has a fixed terminal nut





CC	MODEL	DATE	STANDARD COPPER CORE	STOCK NUMBER	PLATINUM OR GOLD PALLADIUM	STOCK NUMBER	IRIDIUM	STOCK NUMBER	GAP MM
CUSHMAN									
400	Hauler 800, 1200, 1200X	16→	BPR2ES	2264					0.7
	Refresher FS2, FS4, Oasis	16→	BPR2ES	2264					0.7
	Shuttle 2, 4, 6, 8	16→	BPR2ES	2264					0.7

DINLI									
50	JP 502	04→	BPR7HS	6422			BPR7HIX	5944	0.7
110	Diablo 110	04→	BPR7HS	6422			BPR7HIX	5944	0.7
150	Diablo 150	05→07	C7HSA	4629			CR7HIX	7544	0.7
265	270 Sport	06→	DPR7EA-9	5129			DPR7EIX-9	7803	0.7
450	450 Sport	07→	DCPR8E*	4339			DCPR8EIX	6546	0.8

E-TON									
40	JXL40 Viper	03→	BPM7A	7321					0.6
	RXL40E	01→07	BPM7A	7321					0.6
50	RXL50 Viper	02→	BPR7HS	6422			BPR7HIX	5944	0.7
70	RXL70	05→	BPR7HS	6422			BPR7HIX	5944	0.7
90	DXL90 Sierra	03→	BPR7HS	6422			BPR7HIX	5944	0.7
	RXL90 R	03→07	BPR7HS	6422			BPR7HIX	5944	0.7
	RXL90 Viper	02→	BPR7HS	6422			BPR7HIX	5944	0.7
150	CXL150 Challenger	99→	C7HSA	4629			CR7HIX	7544	0.7
	EXL ST150	04→11	C7HSA	4629			CR7HIX	7544	0.7
	RXL150 Viper	09→	C7HSA	4629			CR7HIX	7544	0.7
	YXL150 Yukon	99→	C7HSA	4629			CR7HIX	7544	0.7
250	VXL250 Vector	07→	CR8E	1275			CR8EIX	4218	0.6
300	VXL-300ST Vector	10→	CR8E	1275			CR8EIX	4218	0.6

E-Z-GO									
400	Hauler 800, 1200, 1200X	16→	BPR2ES	2264					0.7
	Refresher FS2, FS4, Oasis		BPR2ES	2264					0.7
	Shuttle 2, 4, 6, 8	16→	BPR2ES	2264					0.7
	RXV Golf Kart (FJ400D engine)	16→	BPR2ES	2264					0.7
	TXT Golf Kart (FJ400D engine)	14→	BPR2ES	2264					0.7

GAS GAS									
50	Quad 50	04→07	B9ES	2611			BR9EIX	3981	0.6
250	Quad 250	07→	DPR7EA-9	5129			DPR7EIX-9	7803	0.7
300	Wild HP	03→	BR8EG	3130			BR8EIX	5044	0.5
450	Wild HP	03→	CR8E	1275			CR8EIX	4218	0.7

HONDA									
70	ATC70, ATC70-D	78→85	CR7HS	7223			CR7HIX	7544	0.7
90	TRX90 Sportrax	94→	CR6HSA	2983			CR6HIX	7274	0.6
110	ATC110	79→85	DR8HS	5123					0.7
125	ATC125M	84→87	DR8ES-L	2923	DR8EVX	6354	DR8EIX	6681	0.7
	TRX125 All variants	85→88	DR8ES-L	2923	DR8EVX	6354	DR8EIX	6681	0.7
185	ATC185S-D	79→82	DR8ES-L	2923	DR8EVX	6354	DR8EIX	6681	0.7
200	ATC200 (EC/XD/ESE)	81→84	DR8ES-L	2923	DR8EVX	6354	DR8EIX	6681	0.7
	TRX200 All variants	84→97	DR8ES-L	2923	DR8EVX	6354	DR8EIX	6681	0.7
250	ATC250R-D	81→83	BR8ES	5422			BR8EIX	5044	0.7
	ATC250R-F/G	85→86	BR9ES	5722			BR9EIX	3981	0.7
	TRX250 RH, RJ, RK	86→89	BR9ES	5722			BR9EIX	3981	0.7
	TRX250 EX Sportrax	01→08	DPR8EA-9	4929			DPR8EIX-9	2202	0.9
	TRX250 TM/TE Fourtrax S/ES	02→	DPR8EA-9	4929			DPR8EIX-9	2202	0.9
300	TRX300FW-V	94→99	DPR8EA-9	4929			DPR8EIX-9	2202	0.9
	TRX300EX	00→01	DR8ES-L	2923	DR8EVX	6354	DR8EIX	6681	0.7



* Please note DCPR8E 4339 has a removable terminal nut, whereas DCPR8E 4179 has a fixed terminal nut





CC	MODEL	DATE	STANDARD COPPER CORE	STOCK NUMBER	PLATINUM OR GOLD PALLADIUM	STOCK NUMBER	IRIDIUM	STOCK NUMBER	GAP MM
HONDA (CONTINUED)									
350	TRX350-H, J, K, L, M, N, P	86→93	DR8ES-L	2923	DR8EVX	6354	DR8EIX	6681	0.7
	TRX350 TM/TE Fourtrax S/ES	01→06	DPR7EA-9	5129			DPR7EIX-9	7803	0.9
400	TRX400AT Fourtrax	05→07	DPR8EA-9	4929			DPR8EIX-9	2202	0.9
	TRX400EX Sportrax	05→	DPR8Z	4730					0.9
420	TRX420 FE/FM/FPM/TE/TM Fourtrax ES	07→	BKR5E-11	6953			BKR5EIX-11	5464	1.1
450	TRX450 FE/FM ES/S	97→04	DPR7EA-9	5129			DPR7EIX-9	7803	0.9
	TRX450R Sportrax	04→05					IFR8H11	5068	1.1
475	TRX500 ES/FM/FE Foreman Ø14mm Plug (Manual) 475cc	05→	BKR5E-11	6953			BKR5EIX-11	5464	1.1
	TRX500 FA Foreman Ø14mm Plug (Auto) 475cc	15→	BKR5E-11	6953			BKR5EIX-11	5464	1.1
500	TRX500 FA1, FA2, FA3 Foreman AT Ø12mm Plug (Auto) 499cc	01→14					IJR7A9	7901	0.9
650	TRX650FA Rincon AT	03→05					IFR5L11	6502	1.1
675	TRX680FA Rincon Ø14mm Plug	05→14					IFR5L11	6502	1.1
	TRX680FA Rincon (Twin Spark) Ø10mm Plug	15→	CPR6EB-9	5958			CR6EIA-9	7967	0.9

HYMOTO

70	HQ70		C7HSA	4629			CR7HIX	7544	0.7
110	HQ110	09→	C7HSA	4629			CR7HIX	7544	0.7
200	HQ200SRL	10→	DR8EA	7162	DR8EVX	6354	DR8EIX	6681	0.7
300	HQ300 4x4 / SRL	07→	DR8EA	7162	DR8EVX	6354	DR8EIX	6681	0.7

HYOSUNG

50	TE50	07→	BPR6HS	7022			BPR6HIX	4085	0.7
90	TE90	07→	BPR7HS	6422			BPR7HIX	5944	0.7
100	TE100R	04→	BPR7HS	6422			BPR7HIX	5944	0.7
450	TE450 Rapier	07→	CR8E	1275			CR8EIX	4218	0.7

JOHN DEERE

854	XUV 855D Gator (Yanmar 3-cyl. diesel)		Y1021J	97627					-
-----	---------------------------------------	--	--------	-------	--	--	--	--	---

KAWASAKI

50	KFX50 A	03→	BPR4HS	7823					0.7
220	KLF220 A	88→02	DR8ES	5423			DR9EIX	4772	0.7
250	KLF250	03→	DR8ES	5423			DR9EIX	4772	0.6
300	KAF300 A-C (Mule 500/550)	91→04	BPR5ES	7422			BPR5EIX	6597	0.8
	KLF300 (Ø14mm Plug)	86→88	BR8ES	5422			BR8EIX	5044	0.6
	KLF300 (Ø12mm Plug)	89→	DR8EA	7162	DR8EVX	6354	DR8EIX	6681	0.7
	KVF300	99→04	DR8EA	7162	DR8EVX	6354	DR8EIX	6681	0.7
	KVF300 Brute Force 300	12→	DPR7EA-9	5129			DPR7EIX-9	7803	0.9
360	KVF360	02→	DPR8EA-9	4929			DPR8EIX-9	2202	0.9
400	KAF400 A, B (Mule 600/610)	05→	BPR5ES	7422			BPR5EIX	6597	0.8
	KFX400	03→	CR7E	4578			CR7EIX	7385	0.7
	KLF400 B	93→99	DPR8EA-9	4929			DPR8EIX-9	2202	0.9
	KVF400	99→	DPR8EA-9	4929			DPR8EIX-9	2202	0.9
450	KAF450 (Mule 1000)	88→	D6EA	7512					0.7
	KFX450R	08→	CPR8EB-9	6607			CR8EIX	4218	0.9
540	KAF540 C (Mule 2010)	02→05	BP5ES	6511			BPR5EIX	6597	0.5
620	KAF620-A (Mule 2510 - 4 Wheel drive)	92→00	BMR2A	7677					0.7
	KAF620-C (Mule 2500 - 2 Wheel drive)	93→00	BMR2A	7677					0.7
	KAF620-D (Mule 2500E - 2 Wheel drive) Road version	93→96	BMR4A	5728					0.7
	KAF620-E (Mule 3010 - 4 Wheel drive)	01→06	BPR2ES	2264					0.7
	KAF620-G (Mule 3000 - 2 Wheel drive)	01→06	BPR2ES	2264					0.7
650	KVF650	02→	CR7E	4578			CR7EIX	7385	0.7
700	KFX700 V Force	04→	CR7E	4578			CR7EIX	7385	0.7
	KVF700 A	04→	CR7E	4578			CR7EIX	7385	0.7
750	KVF750 A-D	05→	CR7E	4578			CR7EIX	7385	0.7
950	KAF950 A-D Diesel (Mule 2510, 3010)	98→08	Y-706R	3041					-
	KAF950 F-H Diesel (Mule 4010)	09→	Y-601J	92785					-



* Please note DCPR8E 4339 has a removable terminal nut, whereas DCPR8E 4179 has a fixed terminal nut





CC	MODEL	DATE	STANDARD COPPER CORE	STOCK NUMBER	PLATINUM OR GOLD PALLADIUM	STOCK NUMBER	IRIDIUM	STOCK NUMBER	GAP MM
KAZUMA									
50	Meerkat	08→	C7HSA	4629			CR7HIX	7544	0.6
90	Falcon	05→	C7HSA	4629			CR7HIX	7544	0.6
110	Baby Falcon, Falcon, Panda Lacoste	05→	C7HSA	4629			CR7HIX	7544	0.6
150	Dingo, Falcon	03→	C7HSA	4629			CR7HIX	7544	0.6
500	Jaguar	07→	BKR6E	6962			BKR6EIX	6418	0.7
800	Mammoth	07→	BPR6ES	7822			BPR6EIX	6637	0.6

KTM									
450	450 SX (Ø10mm Plug)	09→	CR9EKB	2305			CR9EIX	3521	0.8
	450 XC (Ø12mm Plug)	08→	DCPR8E*	4179			DCPR8EIX	6546	0.6
477	505 SX (Ø10mm Plug)	09→	CR9EKB	2305			CR9EIX	3521	0.8
510	525 XC (Ø12mm Plug)	08→	DCPR8E*	4179			DCPR8EIX	6546	0.6

KUBOTA									
400	RTV400Ci	13→	BR6HS	3922			BR6HIX	3419	0.6
500	RTV500	13→					BKR4EIX	5693	0.7
898	RTV900 Diesel	04→	YE01	2649					-
1123	RTV1100 Diesel	07→	YE01	2649					-
	RTV1140 Diesel	09→	YE01	2649					-

KYMCO									
50	KXR 50		BR8HSA	5539			BPR8HIX	6742	0.6
90	KXR 90		C7HSA	4629			CR7HIX	7544	0.7
150	MXer 150 /RL	01→	DR8EA	7162	DR8EVX	6354	DR8EIX	6681	0.7
	MXU 150 RL	05→	DR8EA	7162	DR8EVX	6354	DR8EIX	6681	0.7
250	KXR 250 /RL	01→	DPR7EA-9	5129			DPR7EIX-9	7803	0.9
	MXU 250 RL, Maxxer 250		DPR7EA-9	5129			DPR7EIX-9	7803	0.9
300	MXU 300 RL, Maxxer 300	05→	DPR7EA-9	5129			DPR7EIX-9	7803	0.9
400	MXU 400		CR8E	1275			CR8EIX	4218	0.7
443	MXU 450i	12→	CR7E	4578			CR7EIX	7385	0.6
500	MXU 500	→11	CR7E	4578			CR7EIX	7385	0.6
	MXU 500i IRS	12→	CR7E	4578			CR7EIX	7385	0.6
	UXV 500		CR7E	4578			CR7EIX	7385	0.9

LEM									
50	Beetlebug, Cayman, Condor	97→	B7HS	5110			BR7HIX	7067	0.6

MASAI									
265	A300	05→	DCPR7E	3932			DCPR7EIX	6046	0.8
450	A450	05→	DCPR8E*	4179			DCPR8EIX	6546	0.6

MASSEY FERGUSON									
250	MF250 2WD	06→08	DR7EA	7839					0.6
350	MF350MRP 4WD Manual 5 Speed	06→08	DR7EA	7839					0.6
400	MF400MRP 4WD Manual 5 Speed	06→08	CR6E	6965					0.8
450	MF450MRP 4WD Automatic	06→08	CR6E	6965					0.8
500	MF500MRP 4WD Automatic & Manual 5 Speed	06→08	CR6E	6965					0.8
	MF500TBX 4WD Automatic	06→08	CR6E	6965					0.8

MOTO ROMA									
50	Blazer 50		B8HS	5510			BR8HIX	7001	0.5
	Blazer 50DL		BP7HS	5111			BPR7HIX	5944	0.6
90	Sport 90		BP7HS	5111			BPR7HIX	5944	0.7



* Please note DCPR8E 4339 has a removable terminal nut, whereas DCPR8E 4179 has a fixed terminal nut





CC	MODEL	DATE	STANDARD COPPER CORE	STOCK NUMBER	PLATINUM OR GOLD PALLADIUM	STOCK NUMBER	IRIDIUM	STOCK NUMBER	GAP MM
MOTO ROMA (CONTINUED)									
100	Blazer 100		BP7HS	5111			BPR7HIX	5944	0.5
	Roadrunner 4	04→	BP7HS	5111			BPR7HIX	5944	0.6
	Sport 100		BP7HS	5111			BPR7HIX	5944	0.6
125	Sportsman 125	03→	C7HSA	4629			CR7HIX	7544	0.6
	SS Buggy (AB125E,R)		C7HSA	4629			CR7HIX	7544	0.6
150	DS Buggy (AB150IIR)		C7HSA	4629			CR7HIX	7544	0.6
	Sport/Sportsman 150		C7HSA	4629			CR7HIX	7544	0.6
	X Machine		C7HSA	4629			CR7HIX	7544	0.6
250	Sport 250		C7HSA	4629			CR7HIX	7544	0.6
	Sportsman 250		C7HSA	4629			CR7HIX	7544	0.6
282	Geko 300	05→	DR8EA	7162	DR8EVX	6354	DR8EIX	6681	0.7

POLARIS									
50	Predator 50	03→	BPR7HS	6422			BPR7HIX	5944	0.6
90	Predator 90	03→	BPR7HS	6422			BPR7HIX	5944	0.6
	Sportsman 90		BPR7HS	6422			BPR7HIX	5944	0.6
200	Phoenix 200	05→	CR6HSA	2983			CR6HIX	7274	0.7
	Sawtooth	06→	CR7HSA	4549			CR7HIX	7544	0.7
250	Trail Blazer 250		BR8ES	5422			BR8EIX	5044	0.7
300	Hawkeye 300 2x4, 4x4	06→	CR8EB	7784			CR8EIX	4218	0.8
330	Magnum 330		BKR6E	6962			BKR6EIX	6418	0.9
	Trail Boss 330		BKR6E	6962			BKR6EIX	6418	0.9
400	Sportsman 400 H.O.	09→	BKR6E	6962			BKR6EIX	6418	0.9
450	Sportsman 450		BKR6E	6962			BKR6EIX	6418	0.9
500	Predator 500	05→	DCPR8E*	4339			DCPR8EIX	6546	0.9
	Predator Troy Lee	06→	DCPR8E*	4339			DCPR8EIX	6546	0.9
	Ranger 4x4 EFI		BKR6E	6962			BKR6EIX	6418	0.9
	Scrambler 500		BKR6E	6962			BKR6EIX	6418	0.9
	Sportsman 500 EFI		BKR6E	6962			BKR6EIX	6418	0.9
	Sportsman 500 H.O. EFI (Incl. Touring)	09→	BKR6E	6962			BKR6EIX	6418	0.9
570	Sportsman 570EFi	13→	MR7F	95897					0.8
650	Ranger TM	06→	BPR5ES	7422			BPR5EIX	6597	0.9
680	Ranger 6x6 EFI		BKR7E	6097			BKR7EIX	2667	0.9
	Ranger XP		BKR7E	6097			BKR7EIX	2667	0.9
700	Sportsman 700 EFI		BKR7E	6097			BKR7EIX	2667	0.9
	Sportsman 700 Twin		BKR7E	6097			BKR7EIX	2667	0.9
800	RZR 800 EFI	07→14	BKR7E	6097			BKR7EIX	2667	0.9
	RZR S 800 EFI	09→14	BKR7E	6097			BKR7EIX	2667	0.9
	Sportsman 800 EFI	05→14	BKR7E	6097			BKR7EIX	2667	0.9
850	Sportsman XP 850	→09	LKAR8A-9	4786					0.9
	Sportsman XP 850	12→	LKAR8A-9	4786					0.9
875	Ranger RZR 900	14→	MR7F	95897					0.8
	Ranger RZR 4 XP 900	14→	MR7F	95897					0.8

PUZEY									
125	Madix 125	13→	DR8EA	7162			DR8EIX	6681	0.7

QUADZILLA									
50	Buzz	03→07	BPR7HS	6422			BPR7HIX	5944	0.6
	PGO 50E Bugrider		BPR7HS	6422			BPR7HIX	5944	0.6
100	M100		BP7HS	5111			BPR7HIX	5944	0.7
	ProShark	04→	BP8ES	2912			BPR8EIX	6684	0.6
	ProShark E		BR8HSA	5539			BPR8HIX	6742	0.6
	ProShark Type R		BP8ES	2912			BPR8EIX	6684	0.6
	R100		BPR7HS	6422			BPR7HIX	5944	0.6
	X100 Single piece head (12.7mm Thread Reach)		BR8HSA	5539			BPR8HIX	6742	0.6
	X100 Twin piece head (19mm Thread Reach)		BP8ES	2912			BPR8EIX	6684	0.6
150	PGO 150E Bugrider		CR7HSA	4549			CR7HIX	7544	0.6



* Please note DCPR8E 4339 has a removable terminal nut, whereas DCPR8E 4179 has a fixed terminal nut





CC	MODEL	DATE	STANDARD COPPER CORE	STOCK NUMBER	PLATINUM OR GOLD PALLADIUM	STOCK NUMBER	IRIDIUM	STOCK NUMBER	GAP MM
QUADZILLA (CONTINUED)									
165	R170E Stinger	03→06	DR8EA	7162	DR8EVX	6354	DR8EIX	6681	0.7
200	200E 4 Cross		DR8EA	7162	DR8EVX	6354	DR8EIX	6681	0.7
	ST200E	06→07	CR7HSA	4549			CR7HIX	7544	0.6
250	PGO 250E Bugrider		DPR7EA-9	5129			DPR7EIX-9	7803	0.9
	R250E Stinger		CR8HS	7423	CR8HVX	7236	CR8HIX	7669	0.7
	R250E Triple Disc		CR8HS	7423	CR8HVX	7236	CR8HIX	7669	0.7
	XRV 250	06→07	DPR7EA-9	5129			DPR7EIX-9	7803	0.9
300	300E SUV 4 Valve		DR8EA	7162	DR8EVX	6354	DR8EIX	6681	0.7
500	XLC500	08→	DCPR8E*	4339			DCPR8EIX	6546	0.9
700	RS7	10→	CR6E	6965					0.8
750	RS8	11→	CR6E	6965					0.8

QUANTUM

150	Dingo, Falcon		C7HSA	4629			CR7HIX	7544	0.6
500	NF500L		BKR6E	6962			BKR6EIX	6418	0.7

SKYTEAM

50	LX50ST-C		CR7HSA	4549			CR7HIX	7544	0.6
200	ST200 Quad		DR8EA	7162	DR8EVX	6354	DR8EIX	6681	0.7

STORM

110	Panther	12→	CR7HSA	4549			CR7HIX	7544	0.6
-----	---------	-----	--------	------	--	--	--------	------	-----

SUZUKI

50	LT50 →K4/K5 (Ø14mm Plug)	→05	BPR4HS	7823					0.7
	LT-A50 →K4/K5 (Ø14mm Plug)	→05	BPR4HS	7823					0.7
	LT-Z50 K5/K6 (Ø10mm Plug)	05→	CR6HSA	2983			CR6HIX	7274	0.7
80	LT80 P-R-S		BP7HS	5111			BPR7HIX	5944	0.7
	LT80 T-V-W-X-Y K1-K5		BPR7HS	6422			BPR7HIX	5944	0.7
90	LT-Z90	06→	CR6HSA	2983			CR6HIX	7274	0.7
250	LT-4WD	87→98	DR7ES	3123					0.7
	LT-F250F Ozark	99→02	DR7EA	7839					0.6
	LT-F250	03→	DR7EA	7839					0.6
	LT-Z250 K4-K5	04→	DR7EA	7839					0.6
300	LT-F300F	99→02	DR7EA	7839					0.7
400	LT-A400F K2 (Eiger)	02→	CR7E	4578			CR7EIX	7385	0.7
	LT-F400 Eiger 2WD		CR7E	4578			CR7EIX	7385	0.7
	LT-F400F Eiger 4WD	02→09	CR7E	4578			CR7EIX	7385	0.7
	LT-F400FSi KingQuad	10→13	CR7E	4578			CR7EIX	7385	0.7
	LT-Z400	03→13	CR7E	4578			CR7EIX	7385	0.7
450	LT-A450X	07→10	CR6E	6965			CR6EIA-9	7967	0.8
	LT-R450	06→	CR8EB	7784			CR8EIX	4218	0.7
500	LT-A500XP KingQuad (19mm Thread Reach)	10→14	CR6E	6965			CR6EIA-9	7967	0.8
	LT-A500XP KingQuad (Twin Spark) (26.5mm Thread Reach)	15→	LMAR6A-9	5946					0.9
	LT-F500F	98→07	CR7E	4578			CR7EIX	7385	0.7
700	LT700A K5-K6	05→06	CR6E	6965					0.8
	LT-A700X K7	2007	CR6E	6965			CR6EIA-9	7967	0.8
722	LT-A750X (19mm Thread Reach)	08→13	CR6E	6965			CR6EIA-9	7967	0.8
	LT-A750X (Twin Spark) (26.5mm Thread Reach)	14→	LMAR7A-9	4908					0.9

SYM

200	TrackRunner 200	06→	CR8HSA	2086	CR8HVX	7236	CR8HIX	7669	0.6
250	QuadLander 250	06→	BR8HSA	5539			BPR8HIX	6742	0.6



* Please note DCPR8E 4339 has a removable terminal nut, whereas DCPR8E 4179 has a fixed terminal nut





CC	MODEL	DATE	STANDARD COPPER CORE	STOCK NUMBER	PLATINUM OR GOLD PALLADIUM	STOCK NUMBER	IRIDIUM	STOCK NUMBER	GAP MM
TGB									
90	Hornet 90		BPR7HS	6422			BPR7HIX	5944	0.6
250	Blade 250		CR8E	1275			CR8EIX	4218	0.8
287	Blade 325 SL 2WD		CR8E	1275			CR8EIX	4218	0.8
	Target 325 SL 2WD		CR8E	1275			CR8EIX	4218	0.8
403	Blade 425 SL 4WD	10→	CR7E	4578			CR7EIX	7385	0.7
	Blade 450 SE IRS 4WD	10→	CR7E	4578			CR7EIX	7385	0.7
460	Blade 460 R 2WD	12→	CR7E	4578			CR7EIX	7385	0.7
503	Blade 550 LT 4WD	11→	CR7E	4578			CR7EIX	7385	0.7
	Blade 550 SE IRS 4WD	11→	CR7E	4578			CR7EIX	7385	0.7
	Target 550 IRS 4WD	11→	CR7E	4578			CR7EIX	7385	0.7

YAMAHA										
50	YFM50 Mini Raptor	03→05	CR7HS	7223			CR7HIX	7544	0.6	
	YFM50 Mini Raptor	06→	CR7HSA	4549			CR7HIX	7544	0.7	
60	YT60L (Tri-Moto)		BP6HS	4511			BPR6HIX	4085	0.6	
80	YFM80	92→03	CR7HS	7223			CR7HIX	7544	0.7	
	YFM80 Badger	04→	CR7HSA	4549			CR7HIX	7544	0.7	
	YFM80 Raptor	06→	CR7HSA	4549			CR7HIX	7544	0.7	
125	YFA1 Breeze	90→03	CR7HS	7223			CR7HIX	7544	0.7	
	YFA1 Breeze	04→	CR7HSA	4549			CR7HIX	7544	0.7	
	YFM125S Grizzly	04→	CR7HSA	4549			CR7HIX	7544	0.7	
200	YTM200EL Yamahauler	1984	D7EA	7912					0.7	
	YFM200N (Moto-4)	85→90	D7EA	7912					0.6	
	YFS200 Blaster	88→	BR8ES	5422			BR8EIX	5044	0.6	
	YTM200EK (Tri-Moto)		D7EA	7912					0.6	
215	G1A Utility/Golf Kart	79→	BP5HS	4111					0.7	
225	YFM225		DR7ES	3123					0.6	
230	YFU1 Pro Hauler	89→90	DR7EA	7839					0.7	
250	YFB250 Timberwolf 2WD/4WD	92→97	DR7EA	7839					0.6	
	YFM250	88→90	DR7EA	7839					0.7	
	YFM250X Bear Tracker	99→04	DR7EA	7839					0.7	
	YFM250 Bear Tracker	05→	DR7EA	7839					0.6	
	YFM250B Bruin/Big Bear	05→	DR7EA	7839					0.6	
	YFM250R Raptor	08→	DR7EA	7839					0.6	
	YTZ250	85→88	B8ES	2411			BR8EIX	5044	0.7	
285	G2A, G5A, G8A, G9A Utility/Golf Kart	85→	BR4ES	1097					0.8	
	G3A Utility/Golf Kart	86→	BP5HS	4111					0.7	
287	YFM30GB Grizzly	12→	CR8E	1275			CR8EIX	4218	0.8	
350	G23A Utility/Golf Kart	03→06	BPR2ES	2264					0.7	
	YFM350 Big Bear 2WD		DR8ES-L	2923	DR8EVX	6354	DR8EIX	6681	0.6	
	YFM350 Big Bear 4WD	87→93	DR8ES-L	2923	DR8EVX	6354	DR8EIX	6681	0.6	
	YFM350 Big Bear 4WD	94→97	DR8EA	7162	DR8EVX	6354	DR8EIX	6681	0.8	
	YFM350A, FWA Bruin 2WD/4WD	03→	DR8EA	7162	DR8EVX	6354	DR8EIX	6681	0.8	
	YFM350ER	93→95	DR8ES	5423			DR9EIX	4772	0.7	
	YFM350FWB	97→01	DR8EA	7162	DR8EVX	6354	DR8EIX	6681	0.7	
	YFM350FX Wolverine	95→99	DR8EA	7162	DR8EVX	6354	DR8EIX	6681	0.7	
	YFM350R Raptor	05→	DR8EA	7162	DR8EVX	6354	DR8EIX	6681	0.8	
	YFM350U	96→01	DR8EA	7162	DR8EVX	6354	DR8EIX	6681	0.7	
	YFM350X Warrior	87→04	DR8EA	7162	DR8EVX	6354	DR8EIX	6681	0.8	
	YFZ350 Banshee	87→	BR8ES	5422			BR8EIX	5044	0.6	
	360	G27A U-Max Utility/Golf Kart	04→06	BPR2ES	2264					0.7
		G29A	10→	BPR2ES	2264					0.7
YDR-A (The DRIVE)		07→	BPR2ES	2264					0.7	
YTF2		10→	BPR2ES	2264					0.7	
400	YFM400 Big Bear Professional Manual	00→06	DR8EA	7162	DR8EVX	6354	DR8EIX	6681	0.7	
	YFM400 Big Bear Manual	07→	DR8EA	7162	DR8EVX	6354	DR8EIX	6681	0.7	
	YFM400FWE Kodiak	1993	DR8ES-L	2923	DR8EVX	6354	DR8EIX	6681	0.7	
	YFM400 Kodiak Manual	94→99	DR8EA	7162	DR8EVX	6354	DR8EIX	6681	0.7	
	YFM400 Kodiak Auto	00→05	DR8EA	7162	DR8EVX	6354	DR8EIX	6681	0.7	
	YFM4FAV Kodiak Auto	2006	DR8EA	7162	DR8EVX	6354	DR8EIX	6681	0.7	



CC	MODEL	DATE	STANDARD COPPER CORE	STOCK NUMBER	PLATINUM OR GOLD PALLADIUM	STOCK NUMBER	IRIDIUM	STOCK NUMBER	GAP MM
YAMAHA (CONTINUED)									
450	YFM450F Kodiak	03→05	DR8EA	7162	DR8EVX	6354	DR8EIX	6681	0.8
	YFM45 Kodiak	2006	DR8EA	7162	DR8EVX	6354	DR8EIX	6681	0.8
	YFM45 Grizzly	07→	DR8EA	7162	DR8EVX	6354	DR8EIX	6681	0.8
	YFM45 Grizzly EPS	10→	DR8EA	7162	DR8EVX	6354	DR8EIX	6681	0.8
	YFZ450	03→	CR8E	1275			CR8EIX	4218	0.8
	YFZ450R	09→	CR8E	1275			CR8EIX	4218	0.8
558	YFM550FWAD Grizzly	08→	LMAR6A-9	5946					0.9
600	YFM600FWA Grizzly	98→01	DPR8EA-9	4929			DPR8EIX-9	2202	0.9
660	YFM660FWA Grizzly	02→	DPR8EA-9	4929			DPR8EIX-9	2202	0.9
	YFM660R Raptor	01→05	DPR8EA-9	4929			DPR8EIX-9	2202	0.9
	YXR660 Rhino	04→07	DPR8EA-9	4929			DPR8EIX-9	2202	0.9
686	YXM700PE Viking	14→	CPR7EA-9	3901			CR7EIX	7385	0.8
700	YXR70FX Rhino Fi	08→	CPR7EA-9	3901			CR7EIX	7385	0.8
	YFM700R Raptor	06→07	CR8E	1275			CR8EIX	4218	0.6
	YFM700 Grizzly Fi (19mm Thread Reach)	07→08	CPR7EA-9	3901			CR7EIX	7385	0.9
	YFM700FWAD Grizzly Fi (26.5mm Thread Reach)	09→	LMAR6A-9	5946					0.9

CONVERSION CHART

IMPORTANT:

This chart is furnished as a guide only. Certain design differences may exist between our spark plugs and another manufacturers; heat ratings can also vary. Always refer to the main application data to select the recommended spark plug for specific engines.

AC DELCO	NGK → STOCK No.	AC DELCO	NGK → STOCK No.	AC DELCO	NGK → STOCK No.	AC DELCO	NGK → STOCK No.	
12620540	ILTR5D	5476	B43	B6S	3510	FR4LE	ZFR4F-11	4043
40TS	BP7FS	3612	B44S	BP5S	3011	FR5LS	BCPR5ES	6130
41-108	ILTR5D	5476	B45	B4	3210	LM46	B4LM	3410
41-2XLS	BP7ES	2412	C42-1	B6S	3510	LM49	B4LM	3410
41-4XLS	BP6ES	7811	C42CFS	BP6HS	4511	M40FFX	B9HS-10	3626
41-932	PTR5D-13	6644	C42CLTS	BP6EFS	3812	M41FF	B8HS	5510
41-933	PTR4B-15	5146	C42CXLS	BP6ES	7811	M41K	B8S	3810
41-950	PTR5C-13	7740	C42LTS	BP6EFS	3812	M42FF	B7HS	5110
41-983	PZTR5A-15	7862	C42N	B7ES	1111	M42K	B7S	3710
41-993	PTR4B-15	5146	C42XLS	BP5ES	6511	M43FF	B6HS	4510
41TS	BP6FS	3512	C43	B6S	3510	M44C	B6S	3510
41XL	B9ES	2611	C43CXLS	BP6ES	7811	M44L	B6L	3212
41XLS	BP7ES	2412	C43L	B6L	3212	M45	B4	3210
420Z	B4H	4110	C43N	B6ES	7310	M45FF	B5HS	4210
422Z	B5HS	4210	C44	B6S	3510	M47	B4	3210
425Z	B6HS	4510	C44N	B6ES	7310	MB42K	B6S	3510
426FS	BP6HS	4511	C44NS	BP5ES	6511	MR42K	BR6S	3522
42F	B6HS	4510	C44S	BP5S	3011	MR43LTS	BPR6EFS	3623
42FS	BP6HS	4511	C44XL	B6ES	7310	MR43T	BR6FS	4323
42TS	BP6FS	3512	C45	B4	3210	MR44C	BR6S	3522
42XL	B8ES	2411	C45L	B4L	3112	MR44T	BR5FS	4123
42XLS	BP6ES	7811	C49	B2	3110	R41-5TS	BPR6FS	2623
42Z	B6HS	4511	C73	G2Z	3320	R41CF	BR7HS	4122
430Z	B7HS	5110	C75	G2Z	3320	R41CXL	BR9ES	5722
436XLS	BP9ES	7526	C81	AB8	7909	R41CXLS	BPR7ES	2023
438XL	B8ES	2411	C82	AB7	3010	R41TS	BPR6FS	2623
438XLS	BP8ES	2912	C83	AB7	3010	R42-5LTS	BPR6EFS	3623
43FS	BP6HS	4511	C86	AB6	2910	R42-5TS	BPR6FS	2623
43N	B7ES	1111	C87	AB6	2910	R42-6FS	BPR6HS	7022
43TS	BP6FS	3512	C88	AB2	3020	R42CF	BR6HS	3922
43XL	B7ES	1111	C88L	AB2	3020	R42CFS	BPR6HS	7022
43XLS	BP6ES	7811	CFR1CLS	BCPR7ES	3330	R42CLTS	BPR6EFS	3623
44	B6S	3510	CFR2CLS	BKR6E	6962	R42CT	BR6FS	4323
440T	B7FS	3027	CR42CFS	BPR6FS	2623	R42CTS	BPR6FS	2623
440XLS	BP8ES	2912	CR42CXLS	BPR6ES	7822	R42CXL	BR8ES	5422
445Z	B8HS	5510	CR42N	BR7ES	5122	R42CXLS	BPR6ES	7822
44F	B5HS	4210	CR43	BR6S	3522	R42FS	BPR6HS	7022
44FF	B5HS	4210	CR43CXLS	BPR6ES	7822	R42LTS	BPR6EFS	3623
44FFS	BP5HS	4111	CR43K	BR6S	3522	R42T	BR6FS	4323
44N	B6ES	7310	CR43N	BR6ES	4922	R42TS	BPR6FS	2623
44NS	BP5ES	6511	CR43TS	BPR5FS-11	2924	R42TSM	BPR6FS	2623
44S	BP5S	3011	CR43TSM	BPR5FS-11	2924	R42XL	BR8ES	5422
44TS	BP5FS	3412	CR44N	BR6ES	4922	R42XLS	BPR6ES	7822
44XL	B6ES	7310	CR44NS	BPR5ES	7422	R42XLSM	ZGR5C	6334
44XLO	BP5ES	6511	CR44TS	BPR5FS-11	2924	R43	BR6S	3522
44XLS	BP5ES	6511	CR45TS	BPR5FS	2423	R43C	BR6S	3522
45	B4	3210	CS40	BM7A	6521	R43CFS	BPR6HS	7022
45F	B5HS	4210	CS41	BM7A	6521	R43CT	BR6FS	4323
45FFS	BP5HS	4111	CS41T	BM7F	6421	R43CTS	BPR6FS	2623
45L	B4L	3112	CS42	BM7A	6521	R43CTS6	BPR6FS	2623
45NS	BP5ES	6511	CS42S	BM7A	6521	R43CXL	BR7ES	5122
45S	BP5S	3011	CS42T	BM6F	6221	R43CXLS	BPR6ES	7822
45XL	B6ES	7310	CS45	BM6A	5921	R43FS	BPR6HS	7022
45XLS	BP5ES	6511	CS45T	BM6F	6221	R43LTS	BPR6EFS	3623
46	B4	3210	CS49	BM4A	5628	R43N	BR7ES	5122
46F	B5HS	4210	CSR45	BMR6A	7421	R43T	BR6FS	4323
46FFS	BP5HS	4111	FR2LS	BKR6E	6962	R43TS	BPR6FS	2623
46N	B5ES	6410	FR2LSK	BKR6E	6962	R43TSK	BPR6FS	2623
46S	BP5S	3011	FR3CLS	BKR5E	7938	R43TSX	BPR6FS	2623
46XL	B5ES	6410	FR3CLS6	BKR5E-11	6953	R43XL	BR7ES	5122
47XL	B4ES	4129	FR3LM	ZFR5A-11	5084	R43XLS	BPR6ES	7822
83CTS	AP6FS	2710	FR3LS	BKR5E	7938	R44	BR6S	3522
83TS	AP6FS	2710	FR3LS6	BKR5E-11	6953	R44CF	B5HS	3722
B4031	B4	3210	FR3LSK	BKR5E	7938	R44CXL	BR6ES	4922
R44CXLS	BPR5ES	7422						
R44F	BR5HS	3722						
R44LTS	BPR5EFS	2223						
R44N	BR6ES	4922						
R44NS	BPR5ES	7422						
R44S	BP5S	3011						
R44T	BR5FS	4123						
R44TS	BPR5FS	2423						
R44TSX	BPR5FS-15	3124						
R44XL	BR6ES	4922						
R44XLS	BPR5ES	7422						
R44XLSE	ZGR5C	6334						
R44XLSM	ZGR5C	6334						
R45NS	BPR5ES	7422						
R45NSX	BPR5ES-13	3154						
R45S	BP5S	3011						
R45T	BR5FS	4123						
R45TS	BPR4FS	1127						
R45TSX	BPR4FS-15	2727						
R45XL	BR6ES	4922						
R45XLS	BPR5ES	7422						
R46	BR6S	3522						
R46LTS	BPR5EFS	2223						
R46N	BR5ES	4722						
R46S	BP4	2911						
R46T	BR5FS	4123						
R46TS	BPR4FS	1127						
R46TSX	BPR4FS-15	2727						
R46XL	BR5ES	4722						
R46XLS	BPR4ES	7222						
R47S	BP4	2911						
R83CTS	APR6FS	2922						
R83TS	APR6FS	2922						
R84TS	APR5FS	3122						
R85TS	APR5FS	3122						
S102F	C7HSA	4629						
S104F	C6HSA	3228						
S121F	D8HA	7112						
S121XL	D8EA	2120						
S122F	D8HA	7112						
S123XL	D7EA	7912						
S124FS	D6HA	6512						
S404XLG	B10EG	3630						
S408XLG	B9EG	3530						
S40F	B9HS	5810						
S40FR	BR9HS	4522						
S40XLG	B9ECS	7058						
S40XLR	BR8ES	5422						
S41F	B8HS	5510						
S41FR	BR8HS	4322						
S41XL	B9ES	2611						
S41XLG	B8ECS	2821						
S41XLR	BR9ES	5722						
S42	B7S	3710						
S42F	B7HS	5110						
S42FR	BR7HS	4122						
S42XL	B8ES	2411						
S42XLR	BR8ES	5422						
S43XL	B7ES	1111						
S43XLR	BR7ES	5122						
S44	B6S	3510						
S44F	B5HS	4210						
S44XL	B6ES	7310						
S45F	B5HS	4210						

AC DELCO	NGK → STOCK No.	
S46	B4	3210
S81F	AB8	7909
S82F	AB8	7909
S83F	AB7	3010
S85F	AB6	2910
SB41	B7S	3710
SV41XL	BUE	2322
V40FFK	BUHW-2	5626
V40FFM	BUHW	2622
V40FFS	BUH	2422
VB4OFFM	BUHXW-1	5526
VR40FFK	BUZHW-2	2173
VR40FFM	BUZHW	2147

ACTIVE	NGK → STOCK No.	
AX80	BM6A	5921
AX70	BPM6A	7021
RAX90	BR2LM	5798
RAX80	BMR6A	7421
MR80	CMR5H	7599

ALFA ROMEO	NGK → STOCK No.	
4644 9690	BKR6EKPA	2513
5518 2623	FR5CP	6368
5519 0788	ZKR7A-10	1691
5521 0685	IKR9J8	93311
5521 7232	ILKAR7D6G	93607
5524 9868	IKR9J8	93311
6056 9086	PGR6A	4984
6056 9957	PFR6B	3500
6057 9903	PFR6B	3500
6059 9495	PMR7A	4259
7173 6281	CR7EB	4663
7173 6282	BKR6EKC	2848

ALLIS CHALMERS	NGK → STOCK No.	
232560	AB-6	2910
45NS	BPR4ES	7222
4513315	AB-6	2910
4516333	BPR4ES	7222
4516353	BPR4ES	7222
4613261	AB-6	2910
4660976	AB-6	2910
4810105	AB-6	2910
4905798	B6ES	7310
4905800	AB-6	2910
4907334	BMR6A	7421
4908597	AB-6	2910
4910105	AB-6	2910
4916015	AB-6	2910
4920323	BP5EY	7327
4933394	BPR4ES	7222
4948894	BMR6A	7421
8762050	BP2ES	3467
9001652	BMR6A	7421
DCR42CLTS	BPR6EFS	3623
DLM46	B4LM	3410
DLM49	B4LM	3410
DR42CLTS	BPR6EFS	3623
DR42LTS	BPR6EFS	3623

ALM	NGK → STOCK No.	
8	BM6A	5921
19	B2LM	1147
ALM 8	BM6A	5921
ALM 19	B2LM	1147

APRILIA	NGK → STOCK No.	
0297542	DR8EA	7162
0297830	BR10EG	3830
0297921	CR8E	1275
0297942	DCPR9E	2641
0297945	R0045J-10	7400
0897055	BR8ES	5422

APRILIA	NGK → STOCK No.	
2BEN000088	BPR8HS	3725
2BEN000181	CPR8E	7411
8122586	DR7EA	7839
8206870	BR7HS	4122
8206871	BR8HS	4322
8550352	CR7E	4578
8600008	BR9ECM	3252

ASTON MARTIN	NGK → STOCK No.	
021-007-0145	C7HSA	4549
048-007-0149	BPR6ES	7822
07-14641	BPR5EIX	6597
07-20987	BPR6EY	6427
07-21106	BPR7EIX	4055
07-21300	BPR8EIX	6684
07-22846	BPR8ES	3923
07-23116	BCPR6E	1269
07-26330	BP6ES	7811
07-38800	BCPR7E	1272
07-70920	BCR8ES	5430

AUDI - See VW GROUP

AUTOLITE	NGK → STOCK No.	
12	BP7FS	3612
13	BP6FS	3512
14	BP6FS	3512
15	BP5FS	3412
23	BPR6FS	2623
24	BPR6FS	2623
25	BPR5FS	2423
26	BPR4FS-15	2727
27	BPR4FS-15	2727
34	AP6FS	2710
43	APR6FS	2922
44	APR6FS	2922
45	APR5FS	3122
46	APR5FS	3122
52	BP7ES	2412
53	BP6ES	7811
54	BP6ES	7811
55	BP5ES	6511
56	BP5ES	6511
62	BP7ES	2412
63	BPR6ES	7822
64	BPR6ES	7822
65	BPR5ES	7422
66	BPR5ES	7422
67	BPR4ES	7222
75	BP5S	3011
76	BP5S	3011
77	BP4	2911
85	BP5S	3011
86	BP4	2911
87	BP4	2911
94	BP7EFS	3526
102	BP7EFS	3526
103	BPR6EFS	3623
104	BPR6EFS	3623
105	BPR5EFS	2223
106	BPR5EFS	2223
135	B7FS	3027
143	BR6FS	4323
144	BR6FS	4323
145	BR6FS	4323
146	BR5FS	4123
147	BR5FS	4123
166	APR5FS	3122
175	BP5S	3011
203	BPR6FS	2623
215	B6L	3212
216	B6L	3212
217	B4L	3112
218	B4L	3112

AUTOLITE	NGK → STOCK No.	
235	BM6A	5921
245	BMR6A	7421
253	BM7A	6521
254	BM6A	5921
255	BM6A	5921
258	BM4A	5628
273	BP6HS	4511
274	BP6HS	4511
275	BP5HS	4111
276	BP5HS	4111
283	BPR7HS	6422
284	BPR6HS	7022
292	B8S	3810
294	B6S	3510
295	B4	3210
297	B4	3210
298	B2	3110
302	BR6S	3522
303	BR6S	3522
304	BR6S	3522
306	B4	3210
308	B2	3110
312	B8S	3810
313	B7S	3710
314	B6S	3510
315	B6S	3510
316	B6S	3510
317	B4	3210
318	B2	3110
353	B8S	3810
354	B6S	3510
355	B6S	3510
356	B4	3210
357	B4	3210
358	B2	3110
363	BR6S	3522
372	AB8	7909
373	AB7	3010
374	AB7	3010
375	AB6	2910
376	AB6	2910
377	AB6	2910
378	AB6	2910
379	AB2	3020
386	AB6	2910
393	B7ES	1111
394	B6ES	7310
395	B5ES	6410
396	B5ES	6410
397	B5ES	6410
398	B4ES	4129
402	BR8ES	5422
403	BR6ES	4922
404	BR6ES	4922
405	BR5ES	4722
406	BR5ES	4722
411	B9HS	5810
413	B7HS	5110
414	B6HS	4510
415	B5HS	4210
416	B5HS	4210
417	B4H	4110
424	B6HS	4510
425	BR5HS	3722
426	BR5HS	3722
436	B6L	3212
437	B4L	3112
456	B4LM	3410
458	B2LM	1147
483	BR7EFS	1094
494	B6L	3212
495	B6L	3212
497	B4L	3112
517	BP4HS	3611

AUTOLITE	NGK → STOCK No.	
536	B4H	4110
664	BPR6FS	2623
665	BPR5FS-15	3124
666	BPR4FS-15	2727
667	BPR4FS-15	2727
723	BPR6FS	2623
724	BPR6FS	2623
725	BPR5FS-11	2924
726	BPR4FS	1127
727	BPR4FS-11	2527
744	APR5FS	3122
746	APR5FS	3122
747	APR5FS	3122
764	BPR6EFS	3623
765	BPR5EFS	2223
766	BPR5EFS	2223
865	BPR5EFS	2223
915	ZGR5C	6334
925	ZGR5C	6334
935	BPR5ES	7422
945	BPR5ES	7422
996	B6L	3212
2413	B10EGP	5224
2414	B10EG	3630
2415	B9EG	3530
2416	B8EG	3430
2417	B7ECS	2528
2585	BPR5ES	7422
2593	B9ES	2611
2594	B9ES	2611
2612	B9ES	2611
2613	B9ES	2611
2614	B8ES	2411
2615	B7ES	1111
2616	B6ES	7310
2634	B9HS-10	3626
2635	B8HS	5510
2636	B7HS	5110
2652	B9HS-10	3626
2653	B7HS	5110
2654	B7HS	5110
2655	B6HS	4510
2656	B5HS	4210
2675	B6L	3212
2676	B6L	3212
2695	AB8	7909
2696	AB7	3010
2697	AB6	2910
2715	D8HA	7112
2716	D6HA	6512
2735	D6HA	6512
2755	D8EA	2120
2772	AB8	7909
2775	AB6	2910
2794	C8HSA	6821
2795	C7HSA	4629
2796	C6HSA	3228
2852	BUH	2422
2872	BUHW	2622
2892	BUHX	2522
2932	BUE	2322
2954	BM7F	6421
2956	BM6F	6221
2974	BPM7A	7321
2976	BPMR7A	4626
3013	B7S	3710
3014	B6S	3510
3035	AB6	2910
3036	BPR4FS-15	2727
3074	G2Z	3320
3075	G2Z	3320
3116	AB6	2910
3203	BPR6ES	7822
3204	BPR6ES	7822

AUTOLITE	NGK → STOCK No.	AUTOLITE	NGK → STOCK No.	BERU	NGK → STOCK No.	BERU	NGK → STOCK No.
3205	BPR5ES 7422	4162	DPR9EA-9 5329	14-5DTU	BP6ET 1263	14FR-5DU	BCPR7ES 3330
3206	BPR5ES 7422	4163	DR8ES-L 2923	14-5DU	BP7ES 2412	14FR-6DU	BKR6E 6962
3207	BPR5ES 7422	4164	D7EA 7912	14-5DUO	BP7ES 2412	14FR-6DUX	BCPR6ES-11 7121
3225	BP5S 3011	4173	D8HA 7112	14-5E	B7S 3710	14FR-6LDU3	BKR6EKE 5649
3226	BP5S 3011	4193	CP7HSA 4629	14-6B	BP6HS 4511	14FR-7DU	BKR6E 6962
3227	BP5S 3011	4203	CR7HS 7223	14-6BU	BP6HS 4511	14FR-7DU2	BKR6EZ 4619
3243	BPR6EFS 3623	4251	BP8ES 2912	14-6C	B6ES 7310	14FR-7DUX	BKR6E-11 2756
3244	BPR6EFS 3623	4252	BP7ES 2412	14-6D	BP6ES 7811	14FR-7KPU	BKR6EP-8 2215
3245	BPR5EFS 2223	4253	BP6ES 7811	14-6D1	BP6ES 7811	14FR-7KPUV	BCPR6EP-11 3350
3246	BPR5EFS 2223	4263	BPR6ES 7822	14-6DPO	BP6ES 7811	14FR-7KPUX	BCPR6EP-11 3350
3264	B7FS 3027	4265	BPR5ES 7422	14-6DTU	BP6ET 1263	14FR-7KU	BKR6EY 3696
3265	BR6FS 4323	4275	BP5S 3011	14-6DU	BP6ES 7811	14FR-7KUO	BKR6EYA 2249
3266	BR5FS 4123	9062	BP6ET 1263	14-6DUO	BP6ESZ 7639	14FR-7KUOX	BKR6EYA-11 4073
3267	BR5FS 4123	9063	BP6ET 1263	14-7A	B6HS 4510	14FR-7LDU	BKR6EKC 2848
3286	APR6FS 2922	9064	BP5ET 2287	14-7AU	B6HS 4510	14FR-7LUX	ZFR6F-11 4291
3303	BPR6FS 2623	9921	BCPR6ET 2197	14-7B	BP6HS 4511	14FR-8DU	BKR5E 7938
3325	B6L 3212	AE6	B5HS 4210	14-7BU	BP6HS 4511	14FR-8DUX	BCPR5ES-11 3524
3327	B4L 3112			14-7C	B6ES 7310	14FR-8HU	BCRE527Y 2074
3345	BMR7A 4226			14-7CU	B6ES 7310	14FR-8KU	BKR5EY 7390
3364	BPR6HS 7022	BAKER NGK → STOCK No.		14-7D	BP6ES 7811	14FR-8KUO	BKR5EYA 2087
3382	BR6S 3522	101359	AB-6 2910	14-7DTU	BP6ET 1263	14FR-8KUOU	BKR5EYA-11 2526
3383	BR6S 3522	101527	AB-6 2910	14-7DU	BP6ES 7811	14G-8DTU	BP6ET 1263
3384	BR6S 3522	115923	AB-6 2910	14-7DUO	BP6ESZ 7639	14GH-7DTUR	BUR6ET 3172
3386	BR6S 3522	116251	AB-6 2910	14-7E	B6S 3510	14GH-8DTUR	BUR5ET 3377
3388	BR6S 3522	716D1	AB-6 2910	14-7E	B6S 3510	14GH-8DTURX	BUR5ET-10 7264
3423	B8S 3810	716J1	AB-6 2910	14-8A	B5HS 4210	14GR-8DTU	BPR5EKEU 5685
3426	BR6S 3522	716G1	BMR6A 7421	14-8AU	B5HS 4210	14K-5DU	BP7EFS 3526
3462	BR7ES 5122	BENTLEY NGK → STOCK No.		14-8B	BP5HS 4111	14K-5DUO	BP7EFS 3526
3463	BR6ES 4922	101905600B	PZFR6Q-11 5965	14-8BU	BP5HS 4111	14K-6D	BP6EFS 3812
3464	BR6ES 4922	SP3087	BPR5ES 7422	14-8C	B5ES 6410	14K-6DU	BP6EFS 3812
3465	BR5ES 4722	SP3087P	BPR5ES 7422	14-8C1	B6ES 7310	14K-6DUO	BP6EFS 3812
3466	BR5ES 4722			14-8D	BP5ES 6511	14K-7D	BP6EFS 3812
3485	BR5HS 3722	BERU NGK → STOCK No.		14-8DTU	BP5ET 2287	14K-7DU	BP6EFS 3812
3486	BR5HS 3722	125/14/3	B5ES 6410	14-8DTU EA1,0	BP5ET-10 5156	14K-7DUO	BP6EFS 3812
3507	B6L 3212	125/14/3A	BP5ES 6511	14-8DU	BP5ES 6511	14K-8DU	BP5EFS 3712
3565	BPR5EFS 2223	12-5DU	D7EA 7912	14-8DUO	BP5ES 6511	14K-8DUO	BP5EFS 3712
3604	BPR5FS-15 3124	12ZR6SP03	PLZKBR7B8DG 90223	14-8E	B4 3210	14K-9DU	BP5EFS 3712
3605	BPR4FS-15 2727	12ZR6SPP2	PLZKBR7B8DG 90223	14-8F	BP5S 3011	14K-9DUO	BP5EFS 3712
3606	BPR4FS-15 2727	14-10A	B4H 4110	14-8LUR	ZGR5A 5839	14KGR-6KQU	BUR6EFSZ 6837
3607	BPR4FS-15 2727	14-10B	BP4HS 3611	14-9C	B5ES 6410	14KR-6BU	BPR6FS 2623
3624	BR6FS 4323	14-10C	B4ES 4129	14-9D	BP5ES 6511	14KR-6DU	BPR6EFS 3623
3666	B4LM 3410	14-10E	B4 3210	14-9DTU	BP5ET 2287	14KR-6ZPPV	PTR5A-10 5055
3684	BR7HS 4122	14-10F	BP4 2911	14-9DUO	BP5ES 6511	14KR-7DUX	BPR6EFS 3623
3686	BR6HS 3922	14-3A1	B8HS 5510	14-9EUO	B4LM 3410	14KR-8MPX	TR5A-10 0005
3702	BR9ES 5722	14-3AS1	BR8HIX 7001	14F-03DAR	BKR6EK 2288	14KR-8MUV	PTR5A-10 5055
3703	BR9ES 5722	14-3AU	B8HS 5510	14F-5DPUR02	PFR7S8EG 1675	14R-11F	BP4 2911
3704	BR8ES 5422	14-3CS1	BR8EIX 5044	14F-5DPURS2	PFR7S8EG 1675	14R-5DU	BPR7ES 2023
3705	BR6ES 4922	14-3DP2	BR8EIX 5044	14F-5DU	BCP7ES 5030	14R-6B	BPR6HS 7022
3706	BR6ES 4922	14-4A1	B8HS 5510	14F-6DSR	BKR6E 6962	14R-6BU	BPR6HS 7022
3724	BPR5EFS 2223	14-4A2	B7HS 5110	14F-6DTU	BCP6ET 4563	14R-6D	BPR6ES 7822
3885	ZGR5C 6334	14-4AS1	BR8HIX 7001	14F-6DUO	BCP6ES 4930	14R-6DU	BPR6ES 7822
3896	ZGR5C 6334	14-4AU	B7HS 5110	14F-6DUOR	BKR6E 6962	14R-7B	BPR6HS 7022
3922	BCPR7ES 3330	14-4B2	BP7HS 5111	14F-6DPUR021	PFR7B 4853	14R-7BU	BPR6HS 7022
3924	BKR6E 6962	14-4C1	B8ES 2411	14F-7DPURX2	IFR6D10 5344	14R-7CU	BR6ES 4922
3926	BKR5E 7938	14-4C2	B7ES 1111	14F-7DU	BCP6ES 4930	14R-7D	BPR6ES 7822
3954	D8EA 2120	14-4CS1	BR8EIX 5044	14F-7DUO	BCP6ES 4930	14R-7DU	BPR6ES 7822
3964	DR8ES-L 2923	14-4DPO	BP7ES 2412	14F-7DUOR	BKR6E 6962	14R-7DUX	BPR6EY-11 4228
3985	BPR5FS-15 3124	145/14	B5HS 4210	14F-7HUR2	ZFR5P-G 6893	14R-8DU	BPR5EY 2828
4043	BPR6ES-11 4824	145/14/3	B5ES 6410	14F-7LDUR	BKR6EK 2288	14R-8DUX	BPR5ES-11 4424
4052	B9ES 2611	145/14/3A	BP5ES 6511	14F-7LDUR4	BKR6EK 2288	14R-9DU	BPR5ES 7422
4053	B9ES 2611	145/14/5	B4 3210	14F-8DU	BCP5ES 7496	14R-9EUO	BR6S 3522
4054	B8ES 2411	145/14/5A	BP5S 3011	14F-8DUO	BCP5ES 7496	14S-5A	BL-6H 6921
4055	B7ES 1111	145/14/5AMX	BPM6A 7021	14F-8LDUSR	BKR6EK 2288	14S-5F	BPM7A 7321
4056	B6ES 7310	145/18	AB6 2910	14F-8LUR	ZFR5F 5165	14S-7A	BL-6H 6921
4062	BR9ES 5722	145/1A	BP5HS 4111	14F-9DUO	BCP5ES 7496	14S-7E	BM6A 5921
4063	BR9ES 5722	14-5A	B7HS 5110	14FGH-6DTUR	BKUR7ET 7873	14S-7F	BPM6A 7021
4092	B7HS 5110	14-5AU	B7HS 5110	14FGH-7DTURX	BKUR6ET-10 2397	14S-8F	BPM6A 7021
4093	B7HS 5110	14-5B	BP7HS 5111	14FGH-8DPURX2	PFR5G-11 2647	14SR-6F	BPMR6A 6726
4113	BP6HS 4511	14-5BU	BP7HS 5111	14FGH-8DTURX0	BKUR5ET 2789	14-XAU	B6HS 4510
4114	BP6HS 4511	14-5C	B7ES 1111	14FGR-6DDU	BKR6EKUB 3584	14Z-2C1	BR9EIX 3981
4123	BPR6HS 7022	14-5CS	B7ECS 2528	14FGR-7CTU	BCPR7ET 2164	14Z-3A1	B9HS 5810
4132	D8EA 2120	14-5D	BP7ES 2412	14FGR-8DQU7	BKR5EQUB 1567	14Z-3AU	B8HS 5510
4143	DR8ES-L 2923	14-5D1	BP7ES 2412	14FLR-8LDUX	BKR5EK 7956	14Z-3C1	B9ES 2611
4153	DPR8EA-9 4929	14-5DP1	BP7ES 2412	14FR-5DTU	BCPR7ET 2164	14Z-3CU	B8ES 2411

BOSCH	NGK → STOCK No.	BOSCH	NGK → STOCK No.	BOSCH	NGK → STOCK No.	BOSCH	NGK → STOCK No.				
0 241 229 560	BM6A	5921	0 242 135 501	DCPR8E-N	5692	0 242 229 798	BKR5EYA-11	2526	0 242 245 550	BCPR7ES-11	1095
0 241 229 561	BPM6A	7021	0 242 135 502	DPR7EA-9	5129	0 242 229 883	BKR5E	7938	0 242 245 552	BPR7ES	2023
0 241 229 580	B6S	3510	0 242 135 509	PLKR7A	4288	0 242 229 902	TR5B-13	4559	0 242 245 559	BKR7EQUP	4285
0 241 229 604	B5HS	4210	0 242 135 510	IZKR7B	7563	0 242 229 983	BKR5EK	7956	0 242 245 576	PF7S8EG	1675
0 241 229 673	BCPR5ES	6130	0 242 135 515	DCPR7E-N-10	4983	0 242 229 984	BPR5ES	7422	0 242 250 503	BR8ES	5422
0 241 229 712	BCP5ES	7496	0 242 135 518	PLZKBR7B8DG	90223	0 242 229 985	TR5B-13	4559	0 242 250 506	BR8HS	4322
0 241 229 714	BP5HS	4111	0 242 135 524	PLZKAR6A-11	5118	0 242 230 500	PF5G-11	2647	0 242 255 501	BR9ET	4528
0 241 229 715	BP5ES	6511	0 242 135 527	LKR7B-9	5847	0 242 230 506	IZFR5B	4080	0 242 255 502	BR9ES	5722
0 241 229 716	BP5ET	2287	0 242 135 529	ILKAR7B11	4912	0 242 230 519	IFR5E13	6903	0 242 265 500	BR10ES	4832
0 241 235 089	B6ES	7310	0 242 140 504	DCPR8EKC	7168	0 242 230 528	BPR6EFIX-10	94658	0 242 268 500	BR9HS	4522
0 241 235 607	B6HS	4510	0 242 140 512	PLKR7B8E	94716	0 242 230 534	IFR5N10	7866	0 242 335 504	APR6FS	2922
0 241 235 715	PZFR5D-11	7968	0 242 140 519	DCPR7EA-9	6651	0 242 235 529	BPR6ES	7822	D10BC	APR5FS	3122
0 241 235 718	PZFR6J-11	3586	0 242 140 528	ILZKR7A	1961	0 242 235 532	BR6ES	4922	D6B	AP6FS	2710
0 241 235 730	ZFR5P-G	6893	0 242 140 530	LZKAR7B	5942	0 242 235 533	BR6HS	3922	D6BC	AP6FS	2710
0 241 235 750	BCP6ES	4930	0 242 145 500	DR7EA	7839	0 242 235 541	PF6B	3500	D6BP	AP6FS	2710
0 241 235 752	BKUR6ET-10	2397	0 242 145 523	LKAR8A-9	4786	0 242 235 547	BKR6E-11	2756	D7B	AP6FS	2710
0 241 235 753	BP6EFS	3812	0 242 145 541	SILZKBR8D8S	97506	0 242 235 556	BKR6E	6962	D7BC	AP6FS	2710
0 241 235 754	BP6HS	4511	0 242 150 500	DR8HS	5123	0 242 235 567	ZFR6F-11	4291	D7BP	AP6FS	2710
0 241 235 755	BP6ES	7811	0 242 150 501	DR8ES	5423	0 242 235 642	BKR6EKUB	3584	D8BC	APR5FS	3122
0 241 235 756	BP6ET	1263	0 242 150 505	DPR8EA-9	5129	0 242 235 661	BPR6EFS	3623	D9BC	APR5FS	3122
0 241 235 757	BUR6ET	3172	0 242 160 501	DR8ES	5423	0 242 235 663	BPR6ES	7822	DR10B	APR5FS	3122
0 241 236 834	BPM6A	7021	0 242 160 502	JR9C	6193	0 242 235 664	BUR6ET	3172	DR10BC	APR5FS	3122
0 241 240 575	BPR6EIX-11	3903	0 242 160 503	DR9EA	3437	0 242 235 665	BPR6HS	7022	DR6BC	APR6FS	2922
0 241 240 585	BKR6EIX	6418	0 242 215 502	BR4LM	4133	0 242 235 666	BKR6E	6962	DR6BP	APR6FS	2922
0 241 240 609	BCP6ET	4563	0 242 219 004	BR4HS	3322	0 242 235 667	BCPR6ES-11	7121	DR7BC	APR6FS	2922
0 241 245 539	BM7F	6421	0 242 219 512	BP4	2911	0 242 235 668	BKR6EKC	2848	DR7BP	APR6FS	2922
0 241 245 554	BM7A	6521	0 242 219 514	BR5FS	4123	0 242 235 690	PF6N-11	3546	DR8B	APR5FS	3122
0 241 245 555	BPM7A	7321	0 242 219 517	BPR4FS-11	2527	0 242 235 715	BKR6EQUP	3199	DR8BC	APR5FS	3122
0 241 245 580	B7HS	5110	0 242 225 523	BR5ES	4722	0 242 235 725	BMR6A	7421	DR8BP	APR5FS	3122
0 241 245 581	B7ES	1111	0 242 225 526	BP5S	3011	0 242 235 740	PF6Q	6458	DR9B	APR5FS	3122
0 241 245 592	B7S	3710	0 242 225 528	ZGR5C	6334	0 242 235 743	ILFR6B	6481	DR9BC	APR5FS	3122
0 241 245 636	BP7EFS	3526	0 242 225 537	ZFR4F-11	4043	0 242 235 746	PTR5A-10	5055	F04DAR	BKR6EK	2288
0 241 245 641	PF7B	4853	0 242 225 553	BPR5ES	7422	0 242 235 748	BKR6EKUB	3584	F5DC	BCP7ES	5030
0 241 245 655	BCP7ES	5030	0 242 225 571	BPR6EFIX-10	94658	0 242 235 749	PF6B	3500	F5DP	BCP7ES	5030
0 241 245 872	BP7ES	2412	0 242 225 573	BPR4FS	1127	0 242 235 756	ILZFR6C-K	6645	F5DPOR	PF7B	4853
0 241 248 538	B8ES	2411	0 242 225 580	ZFR6V-G	8894	0 242 235 758	LF6C-11	5788	F5DTC	BCP7ET	2078
0 241 252 522	BR8EIX	5044	0 242 225 622	BPR4FS	1127	0 242 235 776	IZFR6H11	4294	F6DC	BCP6ES	4930
0 241 255 505	B8EFS	1049	0 242 225 641	BPR4FS-15	2727	0 242 235 918	BKR6E	6962	F6DCO	BCP6ES	4930
0 241 256 503	BP8ES	2912	0 242 225 659	TR5AI-13	90813	0 242 235 948	BUR6ET	3172	F6DCOR	BKR6E	6962
0 241 256 512	B8HS	5510	0 242 229 514	BPMR6A	6726	0 242 235 953	BPR6HS	7022	F6DCX	BCPR6ES-11	7121
0 241 256 514	BR8HIX	7001	0 242 229 524	BR6S	3522	0 242 236 530	ZFR6T-11G	5960	F6DP	BCP6ES	4930
0 241 256 515	BR9EIX	3981	0 242 229 528	BPR5FS	2423	0 242 236 541	BCPR6EY-11	3720	F6DPOR	PF6Q	6458
0 241 256 517	BPR8EIX	6684	0 242 229 529	BPR5FS-15	3124	0 242 236 542	ZFR6F-11	4291	F6DSR	BKR6EIX	6418
0 241 256 522	B9ES	2611	0 242 229 533	BR5ES	4722	0 242 236 561	BKR5EYA	2087	F6DTC	BCP6ET	4563
0 241 260 507	B9HS	5810	0 242 229 534	BR5HS	3722	0 242 236 562	BKR6EQUP	3199	F6KPP332S	PF7S8EG	1675
0 241 260 508	BR10ES	4832	0 242 229 537	BPR5EIX	6597	0 242 236 563	PTR6F-13	7569	F6LTCR	BKUR7ET	7873
0 241 260 510	B9EFS	1085	0 242 229 544	ZFR5F-11	2262	0 242 236 576	IGR6A11	5743	F6MPP332	ILFR6A	3588
0 241 262 505	BR9HIX	5687	0 242 229 549	BPR5FS-11	2924	0 242 236 653	LZFR6AP11GS	95712	F7DC	BCP6ES	4930
0 241 262 506	BR10EIX	6801	0 242 229 555	BPR5ES	7422	0 242 240 506	BPMR6A	6726	F7DCO	BCP6ES	4930
0 241 268 506	BR10EIX	6801	0 242 229 556	BR5ES	4722	0 242 240 520	BPR6FS	2623	F7DCOR	BKR6E	6962
0 241 274 504	BR10HIX	6692	0 242 229 576	ZFR6F-11	4291	0 242 240 530	BKR6EP-8	2215	F7DCR4	BKR6E	6962
0 241 274 505	BR10EIX	6801	0 242 229 598	BKR5EVX	2546	0 242 240 533	BCPR6ES-11	7121	F7DCX	BCPR6ES-11	7121
0 241 280 503	B11EGV	5831	0 242 229 630	LF5B	7113	0 242 240 561	BPR6HS	7022	F7DP	BCP6ES	4930
0 241 325 509	APR5FS	3122	0 242 229 643	BMR6A	7421	0 242 240 564	BKR7EKC-N	2095	F7DPER	IFR6D10	5344
0 241 329 525	AB-6	2910	0 242 229 648	BKR5EQUB	1567	0 242 240 590	ZFR6S-Q	6449	F7DTC	BCP6ET	4563
0 241 340 503	AP6FS	2710	0 242 229 654	BKR5EK	7956	0 242 240 591	BPR6EFS	3623	F7HER02	ZFR6T-11G	5960
0 242 035 500	CMR6H	3365	0 242 229 655	BPR5EFS	2223	0 242 240 592	BPR6ES	7822	F7HER2	ZFR5P-G	6893
0 242 040 003	CPR7EA-9	3901	0 242 229 656	BPR5ES	7422	0 242 240 593	BKR6E	6962	F7HPP22	PZFR5D-11	7968
0 242 050 500	CR6HS	7023	0 242 229 657	BPR5HS	6222	0 242 240 618	BKUR7ET	7873	F7HPPRX	PZFR5D-11	7968
0 242 055 500	CR7HS	7223	0 242 229 658	BUR5ET	3377	0 242 240 619	ILFR6A	3588	F7KPP332U	PF6X-11	5757
0 242 055 501	CR7HS	7223	0 242 229 659	BKR5E	7938	0 242 240 620	ITR6F13	4477	F7KTCR	BKUR6ET	6437
0 242 060 501	CR8E	1275	0 242 229 660	BKR5E-11	6953	0 242 240 628	PF6B	3500	F7LCOR2	ZFR6F-11	4291
0 242 060 505	CR8EK	3478	0 242 229 661	LTR6B-10T	5948	0 242 240 648	BKR6EK	2288	F7LCR	ZFR6A-11	1041
0 242 065 502	IMR9C-9H	6777	0 242 229 671	BKR5EKB-11	3967	0 242 240 665	PZFR6R	5758	F7LDCR	BKR6EK	2288
0 242 068 501	CR9EH-9	7502	0 242 229 687	BPR5ES-11	4424	0 242 240 852	BKR6E	6962	F7LTCR	BKUR6ET-10	2397
0 242 074 500	CR9EK	4548	0 242 229 699	ZFR5F	5165	0 242 240 853	BPR6ES	7822	F8DC	BCP5ES	7496
0 242 080 500	CR10EK	2360	0 242 229 706	BKR5ET-10	7553	0 242 245 018	BKR7EKC	7354	F8DCO	BCP5ES	7496
0 242 129 503	LZKAR7A	6799	0 242 229 708	PLFR5A-11	6240	0 242 245 514	BPR7EIX	4055	F8DCOR	BCPR5ES	6130
0 242 129 508	LZKAR7A	6799	0 242 229 713	PF5G-11	2647	0 242 245 517	BR7HS	4122	F8DC4	BCP5ES	7496
0 242 129 510	LZKAR7A	6799	0 242 229 724	BKR6EZB	4293	0 242 245 521	BR7ES	5122	F8DCX	BCPR5ES-11	3524
0 242 129 512	PLZKBR7B8DG	90223	0 242 229 739	PTR5A-10	5055	0 242 245 531	BPR7HS	6422	F8DPER	PF5G-11	2647
0 242 129 514	DILKAR6A11	9029	0 242 229 779	ZGR5A	5839	0 242 245 533	BPMR7A	4626	F8KTCR	BKUR5ET	2789
0 242 129 515	LZKR6B-10E	1578	0 242 229 785	TR5B-13	4559	0 242 245 536	BCPR7ES	3330	F8LCR	ZFR5F	5165
0 242 129 521	LKR6D-10E	96569	0 242 229 797	LF6B	6677	0 242 245 539	BCPR7ET	2164	F8LCR2	ZFR5F	5165

BOSCH	NGK → STOCK No.	BOSCH	NGK → STOCK No.	BOSCH	NGK → STOCK No.	BOSCH	NGK → STOCK No.				
F8LDCR	BKR6EK	2288	FR7KTC	BKUR6ET-10	2397	H8DC	BP5EFS	3712	M12B	AB6	2910
F9LCR	ZFR4F-11	4043	FR7LC2	BKR6E	6962	H8DCO	BP5EFS	3712	M145T1	AB6	2910
FGR5KQE0	BKR7EQUP	4285	FR7LCX	ZFR6F-11	4291	H8DP	BP5EFS	3712	M145T5	AB6	2910
FGR6HQE0	ZFR6S-Q	6449	FR7LCX+	ZFR6F-11	4291	H9BC	BPR4FS	1127	M175T1	AB6	2910
FGR6KQC	BKR6EQUP	3199	FR7LD	BKR6EK	2288	H9BCY	BPR4FS-15	2727	M225T1	AB7	3010
FGR7DQE	BKR6EKUB	3584	FR7LD+	BKR6EK	2288	H9DC	BP5EFS	3712	M240T1	AB7	3010
FGR7DQE+	BKR6EKUB	3584	FR7LDC	BKR6EKC	2848	H9DCO	BP5EFS	3712	M280T1	AB8	7909
FGR7DQE0	BKR6EKUB	3584	FR7LDC+	BKR6EKC	2848	H9HP	BP5EFS	3712	M45T1	AB6	2910
FGR7DQP	BKR6EQUP	3199	FR7ME	LF6B	6677	HLR8STEX	LTR6B-10T	5948	M4A	AB7	3010
FGR7DQP+	BKR6EQUP	3199	FR7MPP10	ILFR6B	6481	HR10A	BR5FS	4123	M4A1	AB8	7909
FGR7KQC	BKR6EQUP	3199	FR7NI33	ILFR6B	6481	HR10AC	BR5FS	4123	M4A2	AB7	3010
FGR7KQE	BKR6EQUP	3199	FR7NPP33	ILZFR6C-K	6645	HR10B	BPR4FS	1127	M4AC	AB7	3010
FGR7KQE0	BKR6EQUP	3199	FR7SE	LF6C-11	5788	HR10BC	BPR4FS	1127	M5A	AB7	3010
FGR8KQE0	BKR5EQUB	1567	FR7SI30	ILZFR6C-K	6645	HR10BCX	BPR4FS-11	2527	M5AC	AB7	3010
FLR7HTCO	BKUR6ET-10	2397	FR7SPP302U	LZFR6AP11GS	95712	HR10BCY	BPR4FS-15	2727	M7A	AB6	2910
FLR8LDCU	BKR5EK	7956	FR8D+	BKR5E	7938	HR10BX	BPR4FS-11	2527	M7AC	AB7	3010
FLR8LDCU+	BKR5EK	7956	FR8D+X	BKR5E-11	6953	HR10BY	BPR4FS-15	2727	M8A	AB6	2910
FLR8LDU+	BKR5EK	7956	FR8DC	BKR5E	7938	HR6B	BPR6FS	2623	M8A0	AB6	2910
F03DAR	BKR6EK	2288	FR8DC+	BKR5E	7938	HR6BC	BPR6FS	2623	M8AC	AB6	2910
FQR8DE	BKR6EZB	4293	FR8DCO	BKR5E	7938	HR6BP	BPR6FS	2623	M95T1	AB6	2910
FQR8LE2	ZFR5F	5165	FR8DCX	BKR5E-11	6953	HR6D	BPR6EFS	3623	M95T5	AB6	2910
FQR8LEU2	ZFR5F	5165	FR8DCX+	BKR5E-11	6953	HR6D+	BPR6EFS	3623	MA145TR7	APR5FS	3122
FR5DC	BCPR7ES	3330	FR8DE	BKR5EZ	7642	HR6DC	BPR6EFS	3623	MA175T7	AP6FS	2710
FR5DC+	BCPR7ES	3330	FR8DI33X	IFR5N10	7866	HR6DC+	BPR6EFS	3623	MA200T7	AP6FS	2710
FR5DCX	BCPR7ES-11	1095	FR8DPP33	PFR5G-11	2647	HR6DP	BPR6EFS	3623	U3AC	CR7HS	7223
FR5DP	BCPR7ES	3330	FR8DPP33+	PFR5G-11	2647	HR6DPP33V	ITR6F13	4477	U3CC	C7E	5096
FR5DTC	BCPR7ET	2164	FR8DPX	BKR5E-11	6953	HR6DS	BPR6EFS	3623	UR07CDC	CR9EK	4548
FR5KPP332S	PFR7S8EG	1675	FR8DS	BKR5EVX	2546	HR7D+	BPR6EFS	3623	UHR08CC	CR9EH-9	7502
FR5LDC	BKR7EKC	7354	FR8DX	BKR5E-11	6953	HR7DC	BPR6EFS	3623	UHR09CI30	IMR9C-9H	6777
FR6D+	BKR6ES	3783	FR8HDC	BKR5EKB-11	3967	HR7DC+	BPR6EFS	3623	UR06CDC	CR10EK	2360
FR6DC	BKR6E	6962	FR8HDC+	BKR5EKB-11	3967	HR7KPP33	PTR6F-13	7569	UR2AS	CR8HS	7423
FR6DC+	BKR6E	6962	FR8HP	ZFR5F-11	2262	HR7KPP33+	TR6F-13	7569	UR2CC	CR8E	1275
FR6DC2	BKR6E	6962	FR8KC	BKR5EYA-11	2526	HR7MEV	TR5B-13	4559	UR2CDC	CR8EK	3478
FR6DCX	BCPR6ES-11	7121	FR8KC+	BKR5EYA-11	2526	HR7MPP	PTR5A-10	5055	UR3AC	CR7HS	7223
FR6DDC	BKR7EKC-N	2095	FR8KCU	BKR5EYA-11	2526	HR7MPP+	PTR5A-10	5055	UR3AS	CR7HS	7223
FR6DP	BKR6EP-8	2215	FR8KI33V	IFR5E13	6903	HR7MPP+V	PTR5A-10	5055	UR4AS	CR6HS	7023
FR6DP1X	BKR6EP-11	2978	FR8KII33X	BPR6EFIX-10	94658	HR8A	BR5FS	4123	UR5	CR7HSA	4549
FR6DPP332	PFR6B	3500	FR8KTC	BKUR5ET-10	7553	HR8AC	BR5FS	4123	UR6DC	CPR7EA-9	3901
FR6DPX	BCPR6ES-11	7121	FR8KTC+	BKUR5ET-10	7553	HR8AP	BR5FS	4123	USR4AC	CMR6H	3365
FR6DTC	BCPR6ET	2197	FR8KTCR	BKUR5ET	2789	HR8B	BPR5FS	2423	USR7AC	CMR6H	3365
FR6DTCW	BCPR6ET	2197	FR8LCX	ZFR6F-11	4291	HR8BC	BPR5FS	2423	V6SII332S	SILZKFR8D7S	95875
FR6KDC	BKR6EK	2288	FR8LDC	BKR5EK	7956	HR8BCY	BPR5FS-15	3124	V6SII3328	SILZKFR8E7S	90654
FR6KDC+	BKR6EK	2288	FR8LDC4	BKR5EK	7956	HR8BP	BPR5FS	2423	VR5NC	LKAR8A-9	4786
FR6KPP332S	PFR6Q	6458	FR8LI332S	IZFR5B	4080	HR8BPX	BPR5FS-11	2924	VR6NE	LZKAR7B	5942
FR6LDC	BKR6EKC	2848	FR8ME	LF6B	7113	HR8BPY	BPR5FS-15	3124	VR7NI33X	ILKAR7B11	4912
FR6LTC	BKUR7ET	7873	FR8NEU	LF6C-11	5788	HR8BY	BPR5FS-15	3124	VR7SPP33	PLZKAR6A-11	5118
FR6MPP10	ILFR6B	6481	FR8SC	LF6B	6677	HR8D+	BPR5EFS	2223	VR8NI35U	DILKAR6A11	9029
FR6MPP332	ILFR6A	3588	FR8SC+	LF6B	6677	HR8DC+	BPR5EFS	2223	VR8SC	LZKAR7A	6799
FR7DII35V	DIFR6D13	94167	FR8SEO	LF6B	6677	HR8MCV	TR5B-13	4559	VR8SC+	LZKAR7A	6799
FR7D+	BKR6ES	3783	FR8SPP332	PLFR5A-11	6240	HR8MCV+	TR5B-13	4559	VR8SE	LZKAR7A	6799
FR7D+X	BKR6E-11	2756	FR9HC	ZFR4F-11	4043	HR8MEV	TR5B-13	4559	VR8SEW	LZKAR7A	6799
FR7DC	BKR6E	6962	FR9LCX	ZFR6V-G	8894	HR8NPP302	PTR5A-10	5055	W06AS	BR10HIX	6692
FR7DC+	BKR6E	6962	H10BC	BPR4FS	1127	HR9A	BR5FS	4123	W06CS	B11EGV	5831
FR7DCO	BKR6E	6962	H2CS	B9EFS	1085	HR9AC	BR5FS	4123	W07AS	BR10HIX	6692
FR7DC2	BKR6E	6962	H3CS	B8EFS	1049	HR9AP	BR5FS	4123	W07CS	BR10EIX	6801
FR7DC9	BKR6E	6962	H5D	BP7EFS	3526	HR9B	BPR4FS	1127	W08AS	BR9HIX	5687
FR7DCX	BCPR6ES-11	7121	H5DC	BP7EFS	3526	HR9BC	BPR4FS	1127	W08CS	BR10EIX	6801
FR7DCX+	BCPR6ES-11	7121	H5DCO	BP7EFS	3526	HR9BC+	BPR4FS	1127	W10A	B4H	4110
FR7DE	BKR6EZ	4619	H5DP	BP7EFS	3526	HR9BCY	BPR4FS-15	2727	W10AC	B4H	4110
FR7DP	BKR6E	6962	H6B	BP6FS	3512	HR9BCY+	BPR4FS-15	2727	W10C	B4ES	4129
FR7DP1X	PFR6B-11	4014	H6BC	BP6FS	3512	HR9BP	BPR4FS	1127	W10CC	B4ES	4129
FR7DPP+	PFR6B	3500	H6D	BP6EFS	3812	HR9BPX	BPR4FS-11	2527	W10DC	BPR4ES	7222
FR7DPP10	BKR6EIX	6418	H6DC	BP6EFS	3812	HR9BPY	BPR4FS-15	2727	W10E	B4	3210
FR7DPP22U	PFR6N-11	3546	H6DCO	BP6EFS	3812	HR9BY	BPR4FS-15	2727	W10F	BP4	2911
FR7DPP33	PFR6Q	6458	H6DP	BP6EFS	3812	HR9D	BPR5EFS	2223	W10FC	BP4	2911
FR7DPX	BKR6E-11	2756	H7CC	BR6EF	3177	HR9DC	BPR5EFS	2223	W11E0	B4LM	3410
FR7DTC	BCPR6ET	2197	H7CP	BR6EF	3177	HR9DPX	BPR6EFIX-10	94658	W125T1	B4H	4110
FR7HE02	ZFR6T-11G	5960	H7D	BP6EFS	3812	HR9KII33Y	TR5AI-13	90813	W125T2	B4ES	4129
FR7HPP332	PZFR5N-11T	7742	H7DC	BP6EFS	3812	HS5E	BM7F	6421	W125T3	B4	3210
FR7KC	BKR5EYA	2087	H7DCO	BP6EFS	3812	HS8E	BM6F	6221	W125T30	BP5ES	6511
FR7KC+	BKR5EYA	2087	H7DP	BP6EFS	3812	M10A	AB6	2910	W125T4	B4H	4110
FR7KCV	BKR5EYA	2087	H8B	BP5FS	3412	M10A0	AB6	2910	W125TR2	BR5ES	4722
FR7KDC	BKR6EKC	2848	H8BC	BP5FS	3412	M10AC	AB6	2910	W125TR3	BR6S	3522
FR7KPP332	IZFR6H11	4294	H8BP	BP5FS	3412	M10AC0	AB6	2910	W125TR30	BPR5ES	7422

BOSCH	NGK → STOCK No.	BOSCH	NGK → STOCK No.	BOSCH	NGK → STOCK No.	BOSCH	NGK → STOCK No.				
W12A	B4H	4110	W310S1S	BR9HIX	5687	W7E	B6S	3510	WR10F	BP4	2911
W12E	B2	3110	W310S2S	BR10EIX	6801	W7EC	B6S	3510	WR10FC	BP4	2911
W145T1	B5HS	4210	W45T1	B4H	4110	W7EP	B6S	3510	WR11E0	BR4LM	4133
W145T1.1	B5HS	4210	W4A	B8HS	5510	W7LTR	BUR6ET	3172	WR240T1	BR8HS	4322
W145T2	B5ES	6410	W4A1	B8HS	5510	W8A	B5HS	4210	WR3CC	BR9ES	5722
W145T3	B6S	3510	W4A2	B8HS	5510	W8A0	B5HS	4210	WR3CTC	BR9ET	4528
W145T30	BP5ES	6511	W4A5	B8HS	5510	W8AC	B5HS	4210	WR4AC	BR8HS	4322
W145T35	BP5HS	4111	W4AC	B8HS	5510	W8AP	B5HS	4210	WR4CC	BR8ES	5422
W145TR2	BR5ES	4722	W4AP	B8HS	5510	W8B	BP5HS	4111	WR4CP	BR8EIX	5044
W145TR3	BR6S	3522	W4AS	BR8HIX	7001	W8BC	BP5HS	4111	WR5A	BR7HS	4122
W145TR30	BPR5ES	7422	W4C	B8ES	2411	W8BP	BP5HS	4111	WR5AC	BR7HS	4122
W175T1	B6HS	4510	W4C1	B8ES	2411	W8C	B5ES	6410	WR5BC	BPR7HS	6422
W175T2	B6ES	7310	W4C2	B7ES	1111	W8CO	B5ES	6410	WR5CC	BR7ES	5122
W175T3	B6S	3510	W4C3	B7HS	5110	W8CC	B5ES	6410	WR5CP	BR7ES	5122
W175T30	BP6ES	7811	W4CC	B8ES	2411	W8CCX	B5ES	6410	WR5D	BPR7ES	2023
W175T35	BP6HS	4511	W4CP	BR8EIX	5044	W8CP	B5ES	6410	WR5D+	BPR7ES	2023
W175TR1	BR6HS	3922	W4CS	BR8EIX	5044	W8D	BP5ES	6511	WR5DC	BPR7ES	2023
W175TR30	BPR6ES	7822	W4DP	BPR7EIX	4055	W8DC	BP5ES	6511	WR5DC+	BPR7ES	2023
W175Z1	B6HS	4510	W4DP0	BPR7EIX	4055	W8DC0	BP5ES	6511	WR5DP	BPR7ES	2023
W2A	B9HS	5810	W4E2	B7S	3710	W8DP	BP5ES	6511	WR5DS	BPR7EIX	4055
W2AC	B9HS	5810	W5A	B7HS	5110	W8DTC	BP5ET	2287	WR6BC	BPR6HS	7022
W2AP	BR9HIX	5687	W5AC	B7HS	5110	W8E	B6S	3510	WR6D	BPR6ES	7822
W2AS	BR9HIX	5687	W5AP	B7HS	5110	W8EC	B6S	3510	WR6D+	BPR6ES	7822
W2CS	BR10EIX	6801	W5AS	BR7HIX	7067	W8F	BP5S	3011	WR6DC	BPR6ES	7822
W2D	BP9ES	7526	W5B	BP7HS	5111	W8FC	BP5S	3011	WR6DC+	BPR6ES	7822
W200T30	BP6ES	7811	W5BC	BP7HS	5111	W8LCR	ZGR5A	5839	WR6DCX	BPR6ES-11	4824
W200T35	BP6HS	4511	W5BP	BP7HS	5111	W8LDCR	BUR6ET	3172	WR6DP	BPR6ES	7822
W200TR30	BPR6ES	7822	W5C	B7ES	1111	W8LPR	ZGR5A	5839	WR6DP0	BPR6ES	7822
W215T30	BP6ES	7811	W5CC	B7ES	1111	W8LTR	BUR5ET	3377	WR6DPX	BPR6ES-11	4824
W225T1	B7HS	5110	W5CP	B7ES	1111	W95T1	B4H	4110	WR6DS	BPR6EIX	6637
W225T2	B7ES	1111	W5CS	BR7EIX	6664	W95T2	B4ES	4129	WR6DTC	BP6ET	1263
W225T3	B7S	3710	W5D	BP7ES	2412	W95T3	B4	3210	WR7A	BR6HS	3922
W225T35	BP7HS	5111	W5D1	BP7ES	2412	W95T6	BP4	2911	WR7AC	BR6HS	3922
W225TR30	BPR7ES	2023	W5DC	BP7ES	2412	W9A	B4H	4110	WR7B	BPR6HS	7022
W230T30	BP7ES	2412	W5DC0	BP7ES	2412	W9A0	B4H	4110	WR7B+	BPR6HS	7022
W240M1	B8HS	5510	W5DP	BP7ES	2412	W9AC	B5HS	4210	WR7BC	BPR6HS	7022
W240MZ1	B8HS	5510	W5DP0	BPR7EIX	4055	W9AC0	B5HS	4210	WR7BC+	BPR6HS	7022
W240T1	B8HS	5510	W5DTC	BP6ET	1263	W9C	B4ES	4129	WR7BP	BPR6HS	7022
W240T2	B8ES	2411	W5E	B7S	3710	W9CC	B4ES	4129	WR7C	BR6ES	4922
W240T3	B7S	3710	W5EC	B7S	3710	W9D	BP5ES	6511	WR7CC	BR6ES	4922
W250P21	BP7ES	2412	W5EP	B7S	3710	W9DC	BP5ES	6511	WR7CP	BR6ES	4922
W250T1	B8HS	5510	W6B	BP6HS	4511	W9DP	BP5ES	6511	WR7D	BPR6ES	7822
W250T2	B8ES	2411	W6BC	BP6HS	4511	W9DTC	BP5ET	2287	WR7D+	BPR6ES	7822
W255T30	BP7ES	2412	W6BP	BP6HS	4511	W9E	B4	3210	WR7DC	BPR6ES	7822
W260M1	B8HS	5510	W6D	BP6ES	7811	W9EO	B4LM	3410	WR7DC+	BPR6ES	7822
W260MZ1	B8HS	5510	W6D1	BP6ES	7811	W9EC	B4	3210	WR7DCX	BPR6ES-11	4824
W260MZ2	B9ES	2611	W6DC	BP6ES	7811	W9ECO	B4LM	3410	WR7DCX+	BPR6ES-11	4824
W260S1S	BR8HIX	7001	W6DC	BP6ES	7811	W9F	BP5S	3011	WR7DP	BPR6EIX	6637
W260T1	B8HS	5510	W6DC0	BP6ES	7811	W9FC	BP5S	3011	WR7DS	BPR6EIX	6637
W260T2	B9ES	2611	W6DC0	BP6ESZ	7639	W9LC	ZGR5A	5839	WR7KI33S	IGR6A11	5743
W260T20	B8ES	2411	W6DP	BPR6EIX	6637	WA125TR30	BPR5EFS	2223	WR7LTC	BUR6ET	3172
W275T1	B8HS	5510	W6DP0	BPR6EIX	6637	WA200T30	BP6EFS	3812	WR7LTC+	BUR6ET	3172
W275T2	B9ES	2611	W6DPX	BPR6EIX-11	3903	WA200TR30	BPR6EFS	3623	WR8AC	BR5HS	3722
W280MZ1	B8HS	5510	W6DTC	BP6ET	1263	WA225T30	BP7EFS	3526	WR8AC+	BR5HS	3722
W280MZ2	B9ES	2611	W7A	B6HS	4510	WAK145T3	BM6F	6221	WR8B+	BPR5HS	6222
W280S1S	BR9HIX	5687	W7A0	B6HS	4510	WAK225T3	BM7F	6421	WR8BC+	BPR5HS	6222
W280S2S	BR9EIX	3981	W7AC	B6HS	4510	WEA	BUH	2422	WR8C	BR5ES	4722
W280T30	BP8ES	2912	W7AP	B6HS	4510	WEC	BUE	2322	WR8CC	BR5ES	4722
W3A	B8HS	5510	W7B	BP6HS	4511	WET1	BUH	2422	WR8CP	BR5ES	4722
W3A0	B8HS	5510	W7BC	BP6HS	4511	WET2	BUE	2322	WR8D	BPR5ES	7422
W3AC	B8HS	5510	W7BP	BP6HS	4511	WKA145T3	BM6A	5921	WR8D+	BPR5ES	7422
W3AP	B8HS	5510	W7C	B6ES	7310	WKA145T6	BPM6A	7021	WR8DC	BPR5ES	7422
W3AS	BR8HIX	7001	W7CC	B6ES	7310	WKA175T3	BM6A	5921	WR8DC+	BPR5ES	7422
W3C	B9ES	2611	W7CC0	B6ES	7310	WKA175T6	BPM6A	7021	WR8DC0	BPR5ES	7422
W3C0	B9ES	2611	W7CP	B6ES	7310	WKA200TR6	BPMR6A	6726	WR8DC4	BPR6ES	7822
W3CC	B9ES	2611	W7D	BP6ES	7811	WKA225T3	BM7A	6521	WR8DCX	BPR5ES-11	4424
W3CP	B9ES	2611	W7D0	BP6ES	7811	WKA225T6	BPM7A	7321	WR8DCX+	BPR5ES-11	4424
W3CS	BR9EIX	3981	W7D0	BP6ES	7811	W06CS	B11EGV	5831	WR8DP	BPR5ES	7422
W3D	BP8ES	2912	W7DC	BP6ES	7811	WR08AC	BR9HS	4522	WR8DPX	BPR5ES-11	4424
W3DP	BPR8EIX	6684	W7DC0	BP6ESZ	7639	WR09CC	BR10ES	4832	WR8E	BR6S	3522
W3DP0	BPR8EIX	6684	W7DCR	BPR6ES	7822	WR10A	BR4HS	3322	WR8EC	BR6S	3522
W3DP2	BP8ES	2912	W7DCX	BPR6ES-11	4824	WR10AC	BR4HS	3322	WR8EP	BR6S	3522
W300T1	B9HS	5810	W7DP	BP6ES	7811	WR10DC	BPR4ES	7222	WR8F	BP5S	3011
W300T30	BP9ES	7526	W7DTC	BP6ET	1263	WR10E	BR6S	3522	WR8FC	BP5S	3011

BOSCH	NGK → STOCK No.	
WR8FP	BP5S	3011
WR8HP	ZGR5C	6334
WR8LC	ZGR5A	5839
WR8LC+	ZGR5A	5839
WR8LTC+	BUR5ET	3377
WR9A0	BR5HS	3722
WR9C	BR5ES	4722
WR9CC	BR5ES	4722
WR9D	BPR5ES	7422
WR9D+	BPR5ES	7422
WR9DC	BPR5ES	7422
WR9DC+	BPR5ES	7422
WR9DCX	BPR6ES-11	4824
WR9DCX+	BPR6ES-11	4824
WR9DP	BPR5ES	7422
WR9DPX	BPR5ES-11	4424
WR9E	BR6S	3522
WR9E0	BR6S	3522
WR9EC	BR6S	3522
WR9ECO	BM6	2027
WR9F	BP5S	3011
WR9FC	BP5S	3011
WR9FP	BP5S	3011
WR9HC	ZGR5C	6334
WR9HP	ZGR5C	6334
WR9LE	ZGR5A	5839
WR9LS	ZGR5A	5839
WS5E	BM7A	6521
WS5F	BPM7A	7321
WS7E	BM6A	5921
WS7F	BPM6A	7021
WS8E	BM6A	5921
WS8F	BPM6A	7021
WSR5F	BPMR7A	4626
WSR6E	BMR6A	7421
WSR6F	BPMR6A	6726
WSR7E	BMR6A	7421
WSR8E	BMR6A	7421
WSR8F	BPMR6A	6726
WSR9E	BMR4A	5728
X3CPO	D9EA	2420
X4CC	D8EA	2120
X4CS	D8EA	2120
X5DC	D7EA	7912
XR2AS	DR8HS	5123
XR2CEO	DR9EA	3437
XR2CS	DR8ES	5423
XR2DDC	JR9C	6193
XR4AS	DR8HS	5123
XR4CS	DR8ES	5423
XR4DC	DPR8EA-9	4929
XR5DC	DPR7EA-9	5129
XR7DC	DPR7EA-9	5129
Y5KPP332S	PZKER7A8EGS	94968
Y6NPP332	PLKR7B8E	94716
Y6LER	ZKER6A-10EG	96596
Y7MPP33	PLKR7A	4288
YR5DDE	KR9CI	7795
YR5LDE	DCPR8EKC	7168
YR6DES	DCPR7EA-9	6651
YR6KI332S	DCPR8EIX	6546
YR6LDE	DCPR8EKC	7168
YR6NI332S	LKAR8AI-9	6707
YR6NPP332	PLKR7B8E	94716
YR8SEU	LZKR6B-10E	1578
YR6TII330T	ILZKR7A	1961
YR7DC	DCPR7E-N-10	4983
YR7DC+	DCPR7E-N-10	4983
YR7DE	DCPR8E-N	5692
YR7LPP332W	IZKR7B	7563
YR7MPP33	PLKR7A	4288
YR7NE	LKR7B-9	5847
YR8MEU	LKR6D-10E	96569
YR8SEU	LZKR6B-10E	1578

BOSCH	NGK → STOCK No.	
ZQR8SI302	PLZKBR7B8DG	90223
ZR5TPP330	SILZKBR8D8S	97506
ZR7SI332S	PLZKBR7B8DG	90223
BRIGGS & STRATTON NGK → STOCK No.		
BS19LM	B2LM	1147
BS19LMR	BR2LM	5798
BS-SV	BR2LM	5798
BS-OHV	BCPR5ES	6130
BS-OHV-HT	BCPR5ES	6130
491043	BCPR5ES	6130
491055E	BCPR5ES	6130
491055S	BCPR5ES	6130
492167	BR2LM	5798
496018E	BCPR5ES	6130
496018S	BCPR5ES	6130
591868	BR2LM	5798
6093E	BCPR5ES	6130
6099E	BR2LM	5798
696202	BKR5EVX	2546
692720	BCPR5ES	6130
691043	BCPR5ES	6130
692051	BCPR5ES	6130
692720	BCPR5ES	6130
694385	BKR5EVX	2546
697451	BR2LM	5798
711252	BCPR5ES	6130
796112S	BR2LM	5798
797434	BCPR5ES	6130
799876	BPMR6A	6726
802592S	BR2LM	1147
992039	BR2LM	5798
992041	BR2LM	5798
992300	BR2LM	5798
992301	BR2LM	5798
992302	BR2LM	5798
992304	BCPR5ES	6130
992305	BCPR5ES	6130
992306	BCPR5ES	6130
BRISK NGK → STOCK No.		
77-300	BPM7A	7321
77-301	BR2LM	5798
77-302	BM6A	5921
77-303	BCPR5ES	6130
77-304	BM6F	6221
77-305	BR2LM	5798
77-306	BMR6A	7421
77-307	BPMR7A	4626
77-308	BM7A	6521
77-309	BPM6A	7021
77-310	BP5ES	6511
77-311	BPM7A	7321
77-312	BPR6ES	7822
77-313	B4LM	3410
77-314	BPR5ES	7422
77-315	BP6ES	7811
77-316	BM7F	6421
77-317	B6S	3510
77-318	BPM6F	5950
77-319	BPMR4A	6028
77-320	BP4HS	3611
77-321	B6HS	4510
77-323	B8ES	2411
77-324	BPMR7A	4626
77-325	BPR6ES	7022
77-350	BR4LM	4133
77-351	B6S	3510
77-352	BP5HS	4111
77-354	BMR7A	4226
B12YC	DPR9EA-9	5329
B14YC	DPR8EA-9	4929
B15YC	DPR7EA-9	5129
D12YC	BCP7ES	5030

BRISK	NGK → STOCK No.	
D14Y	BKR6E	6962
D14YC	BCP7ES	5030
D15Y	BKR6E	6962
D15YC	BCP6ES	4930
D17Y	BKR5E	7938
D17YC	BCP5ES	7496
DOX15LE	ZFR6T-11G	5960
DR12YC	BKR7E	6097
DR14YC	BCPR7ES	3330
DR14ZC	ZFR7F-11	2975
DR14ZC-1	BCPR7ES-11	1095
DR15TC	BKUR5ET-10	7553
DR15YC	BKR6E	6962
DR15Z	BKR6E	6962
DR15Z-1	BCPR6ES-11	7121
DR17YC	BCPR5ES	6130
F14YC	AP7FS	2127
F15YC	AP6FS	2710
FR14YC	APR6FS	2922
FR15YC	APR6FS	2922
G12YC	BP7EFS	3526
G14Y	BP7EFS	3526
G14YC	BP7EFS	3526
G15Y	BP6EFS	3812
G15YC	BP6EFS	3812
G17Y	BP5EFS	3712
G17YC	BP5EFS	3712
GR15YC	BPR6EFS	3623
GR17YC	BPR5EFS	2223
J17	B4LM	3410
J19	B2LM	1147
JR17	BR4LM	4133
JR19	BR2LM	5798
K17C	B6S	3510
K17Y	BP5S	3011
K19	B4	3210
L08JW	BR10EIX	6801
L08W	B11EGV	5831
L10JW	BR8EIX	5044
L12W	BR9EIX	3981
L12Y	BP9ES	7526
L12YC	BP9ES	7526
L14	B8ES	2411
L14C	B8ES	2411
L14Y	BP6ES	7811
L14YC	BP7ES	2412
L15	B7ES	1111
L15C	B7ES	1111
L15W	BR8EIX	5044
L15Y	BP6ES	7811
L15YC	BP6ES	7811
L17	B6ES	7310
L17C	B6ES	7310
L17W	BR7EIX	6664
L17Y	BP5ES	6511
L17YC	BP5ES	6511
L19C	B5ES	6410
LR12YC	BPR8ES	3923
LR12ZC	BPR8ES	3923
LR14TXS	BUR6ET	3172
LR14YC	BPR7ES	2023
LR14ZC	BPR7ES	2023
LR14ZC-1	BPR7ES-11	7226
LR15TXS	BP5ET	2287
LR15YC	BPR6ES	7822
LR15Z	BPR6ES	7822
LR15Z-1	BPR6ES-11	4824
LR17YC	BPR5ES	7422
N08W	BR10HIX	6692
N12W	BR9HIX	5687
N12Y	BP8HS	2630
N12YC	BP8HS	2630
N14	B8HS	5510
N14C	B9HS	5810

BRISK	NGK → STOCK No.	
N14Y	BP6HS	4511
N14YC	BP7HS	5111
N15	B6HS	4510
N15C	B7HS	5110
N15W	BR8HIX	7001
N15Y	BP6HS	4511
N15YC	BP6HS	4511
N17	B5HS	4210
N17C	B6HS	4510
N17W	BR7HIX	7067
N17Y	BP4HS	3611
N17YC	BP5HS	4111
N19	B5HS	4210
N19C	B5HS	4210
NR12YC	BPR8HS	3725
NR15YC	BPR6HS	7022
P15	BM7A	6521
P15Y	BPM7A	7321
P17	BM6A	5921
P17Y	BPM6A	7021
PR15	BMR7A	7321
PR15Y	BPMR7A	4626
PR17	BMR6A	7421
PR17Y	BPMR6A	6726
P18Y	BPM7A	7321
PR18Y	BPMR7A	4626
U15	BM7F	6421
U17	BM6F	6221

CAN-AM - See BOMBARDIER

CARLTON	NGK → STOCK No.	
71010	BM7F	6421
71015	BM6F	6221
71020	BM7A	6521
71025	BPM7A	7321
71030	BM7A	6521
71035	BPM7A	7321
71040	BM6A	5921
71045	BPM6A	7021
71050	B6HS	4510
71055	B5HS	4210
71060	B4	3210
71065	B4H	4110
71070	BPMR6A	6726
C10S	B4H	4110
C7S	B6HS	4510
C8S	B5HS	4210
C9	B4	3210
CA5E	BM7A	6521
CA5Y	BPM7A	7321
CA6	BPMR6A	4626
CA7E	BM7A	6521
CA7Y	BPM7A	7321
CA8E	BM6A	5921
CA8Y	BPM6A	7021
CN6E	BM7F	6421
CN8E	BM6F	6221

CATERPILLAR NGK → STOCK No.

0007954	AB-6	2910
0041663	AB-6	2910
0099476	BMR6A	7421
0631202	AB-6	2910
0676637	AB-6	2910
0971353	BP2ES	3467
0972385	AB-6	2910
0973283	AB-6	2910
1017268	BPR4ES	7222
1038083	BPR5ES	7422
141267	BMR6A	7421
2A3643	AB-6	2910
216460	BPR5FS	2423
2W9486	BP5EY	7327

CATERPILLAR NGK → STOCK No.			CHAMPION NGK → STOCK No.			CHAMPION NGK → STOCK No.			CHAMPION NGK → STOCK No.		
353706	AB-6	2910	C6YCX	BCP7ES	5030	J13Y	BP5S	3011	L81	B7HS	5110
8N2236	BMR6A	7421	C61	R7436-8	4898	J14J	B2	3110	L81Y	BP7HS	5111
8N2630	AB-6	2910	C61C	R7436-8	4898	J14Y	BP5S	3011	L82	B6HS	4510
851101	BMR6A	7421	C7	AB6	2910	J14YC	BP5S	3011	L82C	B6HS	4510
90420-01620	PTR5D-10	3784	C7Y	BCP7ES	5030	J17LM	B4LM	3410	L82Y	BP6HS	4511
91220-00400	BPR4ES	7222	C7YC	BCP7ES	5030	J18Y	BP4	2911	L82YC	BP6HS	4511
91H20-02860	BCPR5E-11	1273	C7YCC	BCP7ES	5030	J18YC	BP4	2911	L82YCC	BP6HS	4511
997476	BMR6A	7421	C7YCX	BCP7ES	5030	J19LM	B2LM	1147	L85	B6HS	4510
99476	BMR6A	7421	C9MCC	ZFR5F	5165	J4	B7S	3710	L85Y	BP6HS	4511
A0000-14416	BPR6EFS	3623	C9Y	BCP6ES	4930	J4C	B7S	3710	L86	B6HS	4510
MD851101	BMR6A	7421	C9YC	BCP6ES	4930	J4J	B7S	3710	L86C	B6HS	4510
MD997476	BMR6A	7421	C9YCC	BCP6ES	4930	J5	B7S	3710	L86CC	B6HS	4510
MS851101	BP5EY	7327	C9YCX	BCP6ES	4930	J6	B6S	3510	L87C	B6HS	4510
			CJ11	BM6A	5921	J6C	B6S	3510	L87Y	BP6HS	4511
			CJ14	BM4A	5628	J6J	B6S	3510	L87YC	BP6HS	4511
			CJ17LM	B4LM	3410	J7	B6S	3510	L87YCC	BP6HS	4511
			CJ3	BM7A	6521	J7J	B6S	3510	L88A	B6HS	4510
			CJ4	BM7A	6521	J8	B6S	3510	L89CM	BP5HS	4111
			CJ6	BM7A	6521	J8C	B6S	3510	L9J	B6HS	4510
			CJ6Y	BPM7A	7321	J8J	B6S	3510	L90	B5HS	4210
			CJ7Y	BPM7A	7321	K11	AB6	2910	L90C	B5HS	4210
			CJ8	BM6A	5921	K13	AB6	2910	L92Y	BP5HS	4111
			CJ8Y	BPM6A	7021	K15J	AB6	2910	L92YC	BP5HS	4111
			CJ86	BM6A	5921	K3G	AB8	7909	L95Y	BP4HS	3611
			D10	AB6	2910	K5G	AB8	7909	N1	BR10ES	4832
			D14	AB6	2910	K7	AB8	7909	N1C	BR10ES	4832
			D16	AB6	2910	K8	AB8	7909	N10PY	BPR6EIX	6637
			D16J	AB6	2910	K8G	AB8	7909	N10Y	BP6ES	7811
			D21	AB6	2910	K9	AB7	3010	N10Y4	BPR6ES-11	4824
			D23	AB6	2910	KA6ZPHPB-1	PZKER7A8EGS	94968	N11Y	BP5ES	6511
			D6	AB8	7909	KA8ZYCC-1	ZKER6A-10EG	96596	N11YC	BP5ES	6511
			D9	AB6	2910	KC10PYPB4	PFR5G-11	2647	N11YCC	BP5ES	6511
			D9J	AB6	2910	KC6PYPBX	PFR7Q	7963	N12Y	BP5ES	6511
			D9JM	AB7	3010	KC7PYPB	PFR7W-TG	5592	N12YC	BP5ES	6511
			DJ6J	BM7F	6421	KC7ZPMPBX4	PZFR5N-11T	7742	N12YCC	BP5ES	6511
			DJ6Y	BPM7F	1268	KC7ZPYPB4	PZFR6R	5758	N13L	ZGR5C	6334
			DJ7J	BM6F	6221	KC7ZTMC4	BKUR6ET-10	2397	N13Y	BP5ES	6511
			DJ7Y	BPM6F	5950	KC8PYP4	PFR5G-11	2647	N14LY	ZGR5C	6334
			DJ8J	BM6F	6221	KC8WYP4	IFR6D10	5344	N14Y	BP5ES	6511
			E82	A7FS	2976	KC8ZMCC	ZFR5P-G	6893	N19V	BUE	2322
			F62Y	AP8FS	2227	KC8ZPYPB4	PZFR5N-11T	7742	N2	B9ES	2611
			F7Y	AP7FS	2127	KEC6PYPB-1	PLFER7A8EG	94833	N21	B4ES	4129
			F7YC	AP7FS	2127	KEC6WYPB-1	PLFER7A8EG	94833	N2C	B9ES	2611
			F7YCC	AP7FS	2127	KER4PYPB	PLKR7A	4288	N2G	BR9EIX	3981
			F81Y	AP8FS	2227	L10	B6HS	4510	N279YC	BP7ES	2412
			F82	A8FS	4489	L10S	B6HS	4510	N281YC	BP6ES	7811
			F83Y	AP8FS	2227	L11S	B7HS	5110	N288	B5ES	6410
			F9Y	AP6FS	2710	L12Y	BP5HS	4111	N3	B8ES	2411
			F9YC	AP6FS	2710	L14	B4H	4110	N3C	B8ES	2411
			FN507Y	BCP7ES	5030	L15Y	BP4HS	3611	N3G	BR8EIX	5044
			G1	C9E	7499	L19V	BUH	2422	N4	B7ES	1111
			G2	C8E	7471	L2G	BR9HIX	5687	N4C	B7ES	1111
			G54V	R0045J-10	7400	L20V	BUH	2422	N4G	BR7EIX	6664
			G55	C9E	7499	L288	B5HS	4210	N4YC	BP9ES	7526
			G56R	R0373A-10	4940	L3G	BR8HIX	7001	N5	B6ES	7310
			G58	C9E	7499	L4G	BR7HIX	7067	N5C	B6ES	7310
			G61	C8E	7471	L4J	B7HS	5110	N52R	B11EGP	2191
			G63	C8E	7471	L5	B7HS	5110	N54R	B10EGP	5224
			H03	B6S	3510	L55G	BR10HIX	6692	N55G	B105EGV	2171
			H10	B6L	3212	L6G	BR7HIX	7067	N56R	B11EGP	2191
			H10C	B6L	3212	L61Y	BP8HS	2630	N57	BR10ES	4832
			H10J	B6L	3212	L64Y	BP7HS	5111	N57G	B105EGV	2171
			H11	B4L	3112	L66Y	BP6HS	4511	N57R	B10EGP	5224
			H12	B4L	3112	L7	B6HS	4510	N58R	B10EGP	5224
			H8	B6L	3212	L7J	B6HS	4510	N59G	BR10EIX	6801
			H8C	B6L	3212	L76V	BUHW	2622	N6	B6ES	7310
			H8J	B6L	3212	L77J	B7HS	5110	N6BYC	BP6ET	1263
			J11	B4	3210	L77J4	B7HS-10	2129	N6GY	BPR8EIX	6684
			J11C	B4	3210	L77JC	B7HS	5110	N6Y	BP8ES	2912
			J11J	B4	3210	L77JC4	B7HS-10	2129	N6YC	BP8ES	2912
			J11Y	BP5S	3011	L77V	BUHW	2622	N6YCC	BP8ES	2912
			J12J	B2	3110	L78	B7HS	5110	N60	B9ES	2611
			J12Y	BP5S	3011	L78C	B7HS	5110	N60R	B8EGP	2046
			J12YC	BP5S	3011	L78V	BUHW-2	5626	N62R	B8EGP	2046

CHAMPION	NGK → STOCK No.	CHAMPION	NGK → STOCK No.	CHAMPION	NGK → STOCK No.	CHAMPION	NGK → STOCK No.				
N63Y	BP9ES	7526	OE036	BP6EFS	3812	OE115	FR5-1	7252	OE226	IKR6G11	7980
N64Y	BP8ES	2912	OE037	B6HS	4510	OE116	BPR8ES	3923	OE227	IZFR6B	3116
N65Y	BP7ES	2412	OE038	BP6HS	4511	OE117	BPR7ES-11	7226	OE228	PFR5G-11	2647
N66Y	BP6ES	7811	OE039	BCPR6ES-11	7121	OE118	BCPR6ET	2197	OE229	PLKR7A	4288
N7	B7ES	1111	OE040	B9ES	2611	OE119	BKR6E	6962	OE230	DCPR8E	4179
N7BMC	BP6ET	1263	OE041	FR5-1	7252	OE121	BKR5E	7938	OE231	LKAR8A-9	4786
N7BYC	BP6ET	1263	OE042	BPR5ES	7422	OE122	PMR8A	5851	OE232	ILKR9G8	97168
N7GY	BPR7EIX	4055	OE043	BCPR7ES	3330	OE125	BR9EIX	3981	OE233	ILZKAR7A10	6043
N7Y	BP7ES	2412	OE044	BP6ET	1263	OE126	PFR7B	4853	OE234	PZFR5N-11T	7742
N7YC	BP7ES	2412	OE045	BPR5ES	7422	OE127	BKR6E	6962	OE235	BKUR6ET-10	2397
N7YCC	BP7ES	2412	OE046	BP7ES	2412	OE128	ZFR5F-11	2262	OE236	LF6D	4704
N7YCX	BP7ES	2412	OE047	BPR6ES-11	4824	OE129	BKR7EIX	2667	OE238	PLZFR6A11S	5987
N79Y	BP6ES	7811	OE048	BPR6ES-11	4824	OE130	LZKAR7A	6799	OE239	IZFR6K-11S	5266
N8	B6ES	7310	OE049	BPR5ES-11	4424	OE131	PTR5D-10	3784	OE240	LZKAR6AP-11	6643
N8B	B6ES	7310	OE050	BP7EFS	3526	OE134	BKR6EP-13	2550	OE241	CR9EB	6955
N8GY	BPR6EIX	6637	OE051	BPR5ES	7422	OE135	LF4AP-11	5613	OE243	SILZKBR8D8S	97506
N8L	ZGR5C	6334	OE052	DCPR8E-N	5692	OE136	PFR6J-11	2743	OE244	PZKER7A8EGS	94968
N8Y	BP6ES	7811	OE053	APR6FS	2922	OE137	BKR5E-11	6953	OE245	SILZKGR8B8S	94201
N80	B10EG	3630	OE054	APR6FS	2922	OE138	PFR6N-11	3546	OE246	PLFER7A8EG	94833
N80G	B11EGV	5831	OE055	BP5ES	6511	OE141	BKR6EIX	6418	OE247	ZKER6A-10EG	96596
N82	B10EG	3630	OE056	BKR7E-11	1283	OE143	PFR6G-9	4377	OE253	ILKAR7A11	94124
N82G	B105EGV	2171	OE057	BCP5ES	7496	OE144	BKR6EIX	6418	OE255	LTR6B-10T	5948
N84	B9EG	3530	OE058	BCP7ES	5030	OE145	BKR6EIX	6418	OJ12Y	BP5S	3011
N84G	BR10EIX	6801	OE059	BP5HS	4111	OE146	PFR6N-11	3546	OJ13Y	BP5S	3011
N86	B9EG	3530	OE060	ZGR5B	7345	OE147	ZFR6F-11	4291	ON11Y	BPR5ES	7422
N86G	BR9EIX	3981	OE061	AP7FS	2127	OE148	LF5A-11	6376	ON12Y	BPR5ES	7422
N87	B8EG	3430	OE062	BKR6E-11	2756	OE150	PMR8A	5851	ON3	BR8ES	5422
N87G	BR8EIX	5044	OE063	BKR6E-11	2756	OE151	BPR5EFS	2223	P10Y	D6HA	6512
N9BMC	BPR5EKU	5685	OE064	BPR6HS	7022	OE152	BKR6E-11	2756	P7	D8HA	7112
N9BYC	BP6ET	1263	OE065	BP5ES	6511	OE153	BKR5EZ	7542	P8Y	D6HA	6512
N9BYC4	BP5ET-10	5156	OE066	ZFR6F-11	4291	OE154	ZFR5F-11	2262	PG2PHP	PMR8A	5851
N9Y	BP6ES	7811	OE067	BP7EFS	3526	OE155	APR6FS	2922	PG4PHP	PMR7A	4259
N9YC	BP6ES	7811	OE068	B8ES	2411	OE156	ZGR5C	6334	P-G7C	C7E	5096
N9YC4	BPR6ES-11	4824	OE069	BCP6ES	4930	OE157	BCR8ES	5430	P-RG7C	CR7E	4578
N9YCC	BP6ES	7811	OE070	BP6HS	4511	OE162	BR6ES	4922	P-RZ9HC	CR7HSA	4549
N9YCX	BP6ES	7811	OE071	BPR6HS	7022	OE163	LZTR4A-11	5444	PZ7HC	CR7HSA	4549
NA10	B8ES	2411	OE072	BP5EFS	3712	OE167	LZTR5AIX-13	2314	Q504V	R2349-10	6839
NA8	B6ES	7310	OE073	DCPR9E	2641	OE168	PTR5D-10	3784	QC12PEP	PZFR6H	7696
OBL9Y	BPR6FS	2623	OE074	B6ES	7310	OE171	BPR6FS	2623	QC12YC	BKR5E	7938
OE001	BP6ES	7811	OE075	BCP7ES	5030	OE175	LF5AP-11	4775	QC501V	R7434-10	4894
OE002	BKR6E	6962	OE076	BCP7ET	2078	OE176	PZFR5D-11	7968	QC59C	BCR8ES	5430
OE003	BCP6ES	4930	OE077	BCPR6ET	2197	OE178	LF5B	7113	QC9MC4	ZFR6F-11	4291
OE004	BPR6ES	7822	OE078	BR8EIX	5044	OE179	IFR6J11	7658	QCJ8Y	BPMR6A	6726
OE005	BKR6E	6962	OE079	B7ES	1111	OE181	IFR6D10	5344	QJ19LM	BR2LM	5798
OE006	BPR6ES	7822	OE080	BKR7E-11	1283	OE182	IFR6T11	4589	QL16V	BUZ8H	7447
OE007	BP6HS	4511	OE081	BKR6E-11	2756	OE183	IFR6F13	4477	QL7J5	BR6HS	3922
OE008	BPR7ES	2023	OE082	BP7EFS	3526	OE184	IZFR5B	4080	QL76V	BUZHW	2147
OE009	BP6EFS	3812	OE084	BP8ES	2912	OE185	IZFR6B	3116	QL77CC	BZ7HS-10	3579
OE010	BP7ES	2412	OE085	BKR5EKU	3964	OE186	DCPR7E-N-10	4983	QL77J4	BZ7HS-10	3579
OE011	BPR6EFS	3623	OE086	BR6HS	3922	OE188	IFR6T11	4589	QL77JC4	BZ7HS-10	3579
OE012	BP6ET	1263	OE087	BP8ES	2912	OE190	ILFR6B	6481	QL78C	BZ7HS-10	3579
OE013	BKR5E	7938	OE088	BCPR6ES	2330	OE191	IFR6D10	5344	QL78V	BUZHW-2	2173
OE014	BKR7E	6097	OE089	ZFR6F-11	4291	OE192	PGR5C-11	5760	QL82C	BR6HS	3922
OE015	BP5ES	6511	OE090	BP7EFS	3526	OE195	IGR7A	6687	QL82YC	BPR6HS	7022
OE016	BKR6E	6962	OE091	BR9ES	5722	OE196	DCPR7E-N-10	4983	QL86	BR6HS	3922
OE017	BCP7ES	5030	OE092	CR9E	6263	OE197	LKR6D-10E	96569	QL86C	BR6HS	3922
OE018	BPR7ES	2023	OE093	BKR6ES	3783	OE198	ZFR6U-G	8894	QL87YC	BPR6HS	7022
OE019	BKR5EK	7956	OE094	BCPR7ES	3330	OE199	DCPR8E	4339	QN2	BR9ES	5722
OE020	BPR6EFS	3623	OE095	BP6ET	1263	OE201	LZKR6B-10E	1578	QN2C	BR9ES	5722
OE021	BCPR6ET	2197	OE096	B6HS	4510	OE204	PLZKBR7B8DG	90223	QN2G	BR9EIX	3981
OE022	BP6ES	7811	OE098	BR7ES	5122	OE205	PLZKBR7B8DG	90223	QN3	BR8ES	5422
OE023	BCP6ES	4930	OE099	BP5EFS	3712	OE206	ILFR6B	6481	QN3C	BR8ES	5422
OE024	BCPR6ES-11	7121	OE100	BPR5EKU	5685	OE207	PLZKAR6A-11	5118	QN84	BR9EG	3230
OE025	BUR6ET	3172	OE101	BPR5ES-11	4424	OE208	IKR9J8	93311	QN86	BR8EG	3130
OE026	BKR6EK	2288	OE102	BKR6EKE	5649	OE209	PFR7W-TG	5592	R10	D6EA	7512
OE027	BUR5ET-10	7264	OE104	BP6HS	4511	OE211	LKR8A	5214	R6	D8EA	2120
OE028	BP5ET-10	5156	OE106	BP5ES	6511	OE212	LKR7B-9	5847	R6G	DR8EIX	6681
OE029	PTR5A-10	5055	OE107	BPR7ES-11	7226	OE213	PZFR6R	5758	R8	D7EA	7912
OE030	BKR6EKC	2848	OE108	BR8ES	5422	OE217	BKR6EKE	5649	RA2HC	DPR9EA-9	5329
OE031	TR5A-10	0005	OE109	BP6ES	7811	OE221	PLFER7A8EG	94833	RA2PYPB	IKR9J8	93311
OE032	BKUR6ET-10	2397	OE110	BCPR7ES	3330	OE222	PFR7Q	7963	RA4HC	DCPR8E	4339
OE033	BKR6EZ	4619	OE111	BPR6ES	7822	OE223	BKR6EQUIP	3199	RA4HCC	DCPR8E	4179
OE034	BKR6EZ	4619	OE112	DR8EIX	6681	OE224	ILFR6A	3588	RA4HCX	DCPR8E-N	5692
OE035	LF5B	7113	OE113	BPR6ES-11	4824	OE225	ILKAR7A7	91432	RA4YC	DCPR8E	4179

CHAMPION	NGK → STOCK No.	CHAMPION	NGK → STOCK No.	CHAMPION	NGK → STOCK No.	CHAMPION	NGK → STOCK No.
RA59GC	DCR9EIX 6650	RC7BYC	BKR6EKUB 3584	REA8PMPB5	PLZKAR6A-11 5118	RL19	BR5HS 3722
RA6	DR8E5-L 2923	RC7BYC4	BCPR6ET 2197	REA8WYPB4	ILKAR7A11 94124	RL4J	BR7HS 4122
RA6HC	DCPR8E 4339	RC7GYC	BKR7EIX 2667	REA12WMB4	LZKAR6AP-11 6643	RL7J	BR6HS 3922
RA6Y	DPR8EA-9 4929	RC7PYCB	BKR6EIX 6418	REC10PYC4	LF5A-11 4775	RL77J	BR7HS 4122
RA6YC	DPR8EA-9 4929	RC7PYCB4	PFR6B-11 4014	REC10WYPB4	ILFR6B 6481	RL78	BR7HS 4122
RA7PYPB4	IKR6G11 7980	RC7Y	BCPR7ES 3330	REC10YC4	LF5A-11 6376	RL78C	BR7HS 4122
RA7YC	DCPR8E 4339	RC7YC	BCPR7ES 3330	REC14PLP5	LZTR5AIX-13 2314	RL82	BR6HS 3922
RA8HC	DCPR7E 3932	RC7YC3	BKR7E 6097	REC14PYC	LF4AP-11 5613	RL82C	BR6HS 3922
RA8MCX4	DCPR7E-N-10 4983	RC7YC4	BKR7E-11 1283	REC6TMC	LF6D 4704	RL82Y	BPR6HS 7022
RA8Y	DPR7EA-9 5129	RC7YCC	BCPR7ES 3330	REC7PMPB4	PLZFR6A11S 5987	RL82YC	BPR6HS 7022
RA8YC	DPR7EA-9 5129	RC7YCC4	BKR7E-11 1283	REC8PYB	ILFR6B 6481	RL82YCC	BPR6HS 7022
RA8YCX4	DCPR7E-N-10 4983	RC78PYP	PFR7G-11S 7772	REC8PYPB	ILFR6A 3588	RL85	BR6HS 3922
RAX92C	DR9EA 3437	RC8BYC	BKR6EKC 2848	REC9MCLX	LF5B 7113	RL85C	BR6HS 3922
RAX92DC	JR9C 6193	RC8DMC	BKR6EK 2288	REC9YCL	LF5B 7113	RL86	BR6HS 3922
RAX92YC	DPR9EA-9 5329	RC8PMP8	IZFR6B 3116	RER2PYPB	ILKR9G8 97168	RL86C	BR6HS 3922
RAX94C	DR8EA 7162	RC8PYCB	PFR6G-9 4377	RER6YC	LKR7B-9 5847	RL87Y	BPR6HS 7022
RAX94YC	DPR8EA-9 4929	RC8PYP	PFR6J-11 2743	RER8DMC	LKR8A 5214	RL87YC	BPR6HS 7022
RAX96C	DR7EA 7839	RC8PYPB4	PFR6N-11 3546	RER8MC	LZKR6B-10E 1578	RL90	BR5HS 3722
RAX96YC	DPR7EA-9 5129	RC8PYX	BKR6EIX 6418	RERX4ZWYPB	SILZKGR8B8S 94201	RL95YC	BPR5HS 6222
RBL11Y	BPR5FS 2423	RC8VTYC4	BKUR6ET-10 2397	RERX5ZPYPB	SILZKBR8D8S 97506	RN1C	BR10ES 4832
RBL11Y6	BPR5FS-15 3124	RC8WMP2	IZFR6B 3116	RERX6PMCB4	PLZKBR7B8DG 90223	RN10GY	BPR6EIX 6637
RBL12	BR5FS 4123	RC8WMP4	IFR6T11 4589	RER8YC	LKR6D-10E 96569	RN10PYP4	PGR5C-11 5760
RBL13Y	BPR5FS 2423	RC8WYP4	IFR6J11 7658	RES9PYP4	PTR5A-10 5055	RN10VTYC	BUR5ET 3377
RBL13Y6	BPR5FS-15 3124	RC8YC	BKR6E 6962	RES9YCC4	TR5A-10 0005	RN10VTYC4	BUR5ET-10 7264
RBL15Y	BPR4FS 1127	RC8YC4	BKR6E-11 2756	RES10TMC4	LTR6B-10T 5948	RN10Y	BPR6ES 7822
RBL15Y4	BPR4FS-11 2527	RC8YCC	BKR6E 6962	RF11Y	APR6FS 2922	RN10YC	BPR6ES 7822
RBL15Y6	BPR4FS-15 2727	RC8YCC4	BKR6E-11 2756	RF11YC	APR6FS 2922	RN10Y4	BPR6ES-11 4824
RBL16Y	BPR4FS 1127	RC8YCL	BKR6EZ 4619	RF14Y	APR5FS 3122	RN11Y	BPR5ES 7422
RBL17Y	BPR4FS 1127	RC8ZPYPB4	IZFR6K-11S 5266	RF14YC	APR5FS 3122	RN11YC	BPR5ES 7422
RBL17Y6	BPR4FS-15 2727	RC87LYC	BKR6E 6962	RF7YC	APR6FS 2922	RN11YC4	BPR5ES-11 4424
RBL8	BR6FS 4323	RC87PYC	BKR6EIX 6418	RF7YCC	APR6FS 2922	RN11YCC	BPR5ES 7422
RBL9Y	BPR6FS 2623	RC87YCC	BKR6ES 3783	RF9Y	APR6FS 2922	RN11YCC4	BPR5ES-11 4424
RBN12Y	BPR5EFS 2223	RC87YCL	BKR6EZ 4619	RF9Y5	APR6FS 2922	RN12Y	BPR5ES 7422
RBN13Y	BPR5EFS 2223	RC89PYC	BKR6EIX 6418	RF9YC	APR6FS 2922	RN12YC	BPR5ES 7422
RBN14Y	BPR5EFS 2223	RC89WYP4	IFR6T11 4589	RFN14LY	ZFR4F-11 4043	RN12YC4	BPR5ES-11 4424
RBN9Y	BPR6EFS 3623	RC89YCC	BKR6ES 3783	RG2PHP	CR8EIX 4218	RN12YC6	BPR5ES-13 3154
RC10DMC	BKR5EK 7956	RC9BMC	BKR5EJU 3964	RG4HC	CR9EB 6955	RN12YCC	BPR5ES 7422
RC10ECC	ZFR6F-11 4291	RC9MC4	ZFR5F-11 2262	RG4HCX	CR9EB 6955	RN13L	ZGR5C 6334
RC10MCC	ZFR6V-G 8894	RC9MCC4	ZFR6F-11 4291	RG4PHP	PMR8A 5851	RN13LYC	ZGR5C 6334
RC10MCC6	ZFR6V-G 8894	RC9QMP	BKR6EQUP 3199	RG6PP	PMR8A 5851	RN14LY	ZGR5C 6334
RC10MCCR6	ZFR6V-G 8894	RC9Y	BKR6E 6962	RG6YC	CPR8E 7411	RN14MC5	BPR5EY-11 3028
RC10PYC	BKR6EIX 6418	RC9YC	BKR6E 6962	RG6YCA	CPR8E 7411	RN14PMP5	BPR5EP-11 3971
RC10PYP4	PFR5J-11 4642	RC9YC4	BCPR6ES-11 7121	RG6YCH	CPR8E 7411	RN14Y	BPR5ES 7422
RC10PYPB4	PFR5G-11 2647	RC9YC5	BCPR6ES-11 7121	RG92C	CR9E 6263	RN14Y6	BPR5ES-13 3154
RC10VTYC4	BKUR5ET-10 7553	RC9YCC	BKR6E 6962	RG92DC	CR9EK 4548	RN14YC	BPR5ES 7422
RC10WMP2	IZFR5B 4080	RC9YCC4	BCPR6ES-11 7121	RG94C	CR8E 1275	RN16Y	BPR4ES 7222
RC10WYP4	IFR5N10 7866	RCJ4	BMR7A 4226	RGU92C	CR9EH-9 7502	RN2	BR9ES 5722
RC10YC	BCPR6ES 2330	RCJ501H	BPMR4A 6028	RGU94C	CR8EH-9 5666	RN2C	BR9ES 5722
RC10YC4	BKR6E-11 2756	RCJ6	BMR7A 4226	RH10C	B6L 3212	RN2G	BR9EIX 3981
RC10YCC	BKR6E 6962	RCJ6Y	BPMR7A 4626	RH18Y	B-4L 3112	RN3	BR8ES 5422
RC10YCC4	BKR6E-11 2756	RCJ6YC	BPMR7A 4626	RJ11	BR6S 3522	RN3C	BR8ES 5422
RC10YCL	BKR5EZ 7642	RCJ7Y	BPMR7A 4626	RJ11Y	BP5S 3011	RN3G	BR8EIX 5044
RC11PYPB4	PFR6N-11 3546	RCJ7YC	BPMR7A 4626	RJ12	BR6S 3522	RN4	BR7ES 5122
RC11ZYC4	ZFR5E-11 4435	RCJ8	BMR6A 7421	RJ12C	BR6S 3522	RN4C	BR7ES 5122
RC12ECC	FR5-1 7252	RCJ8Y	BPMR6A 6726	RJ12Y	BP5S 3011	RN5	BR6ES 4922
RC12LC	ZFR5F 5165	RCJ8YC	BPMR6A 6726	RJ12YC	BP5S 3011	RN5C	BR6ES 4922
RC12LC4	ZFR5F-11 2262	RD14	AB6 2910	RJ14Y	BP5S 3011	RN57YC	BR10EG 3830
RC12LYC	FR5-1 7252	RD16	AB6 2910	RJ14YC	BP5S 3011	RN57YCC	BR10EG 3830
RC12MC4	ZFR5F-11 2262	RD16J	AB6 2910	RJ17LM	BR4LM 4133	RN6	BR6ES 4922
RC12MC5	ZFR5F-11 2262	RD9	AB6 2910	RJ18Y	BP4 2911	RN6Y	BPR8ES 3923
RC12MCC4	ZFR5F-11 2262	RDJ7J	BMR6F 2144	RJ18YC	BP4 2911	RN6YC	BPR8ES 3923
RC12PYC	PFR6B 3500	RDJ7Y	BPMR6F 1270	RJ19HX	BR2LM 5798	RN7GY	BPR7EIX 4055
RC12PYP	BKR6EP-13 2550	RDJ8J	BMR6F 2144	RJ19LM	BR2LM 5798	RN7Y	BPR7ES 2023
RC12YC	BKR5E 7938	RE14MCC4	LZTR4A-11 5444	RJ19LMC	BR2LM 5798	RN7YC	BPR7ES 2023
RC12YC5	BKR5E-11 6953	RE14MCC5	LZTR4A-11 5444	RJ2YLE	BPMR6A 6726	RN7YC4	BPR7ES-11 7226
RC12YCC	BKR5E 7938	RE14PLP5	LZTR5AIX-13 2314	RJ20Y	BP4 2911	RN7YCC	BPR7ES 2023
RC12YCC4	BKR5E-11 6953	RE7PYC5	TR5A-10 5055	RJ6	BR6S 3522	RN7YCC4	BPR7ES-11 7226
RC14YC	BKR5E 7938	RE7YCC	TR5A-10 0005	RJ6C	BR6S 3522	RN8	BR5ES 4722
RC6PYP	PFR7B 4853	REA4PMPB4	ILZKAR7A10 6043	RJ6J	BR6S 3522	RN8L	ZGR5C 6334
RC6VPYC	BKR7EIX 2667	REA6PYPB	ILKAR7A7 91432	RJ7	BR6S 3522	RN8VTYC4	BUR6ET 3172
RC6YC	BCPR7ES 3330	REA6YCL	LKAR8A-9 4786	RJ8	BR6S 3522	RN8WYP	IGR7A 6687
RC6YCC	BCPR7ES 3330	REA8MCL	LZKAR7A 6799	RJ8C	BR6S 3522	RN9GY	BPR6EIX 6637
RC61YC	BCR8ES 5430	REA8MCX	LZKAR7B 5942	RJ8J	BR6S 3522	RN9LCC	ZGR5B 7345
RC7BMC	BCPR6ET 2197	REA8MX	LZKAR7B 5942	RL12Y	BPR6HS 7022	RN9Y	BPR6ES 7822

CHAMPION	NGK → STOCK No.	
RN9YC	BPR6ES	7822
RN9YC4	BPR6ES-11	4824
RN9YCC	BPR6ES	7822
RN9YCC4	BPR6ES-11	4824
RP10HC	DR5HS	4623
RP7	DR8HS	5123
RS12YC	BPR5EFS	2223
RS14YC	BPR5EFS	2223
RS5C	BR7EFS	1094
RS8WYP5	ITR6F13	4477
RS9PYP4	PTR5D-10	3784
RS9YC	BPR6EFS	3623
RS9YCC	BPR6EFS	3623
RV12C	BR5FS	4123
RV12YC	BPR5FS	2423
RV12YC6	BPR5FS-15	3124
RV15YC	BPR4FS	1127
RV15YC4	BPR4FS-11	2527
RV15YC6	BPR4FS-15	2727
RV17YC	BPR4FS	1127
RV17YC6	BPR4FS-15	2727
RV19YC	BPR4FS	1127
RV8C	BR6FS	4323
RV9YC	BPR6FS	2623
RZ7C	CMR7H	3066
RZ94C	CR8HS	7423
RZ98C	CR6HS	7023
RZN12Y	BPR5EFS	2223
RZN12Y5	BPR5EFS	2223
S10YCC	BP5EFS	3712
S12YC	BP5EFS	3712
S279YC	BP6EFS	3812
S281YC	BP6EFS	3812
S379YC	BP7EFS	3526
S6YC	BP7EFS	3526
S6YCC	BP7EFS	3526
S7YC	BP7EFS	3526
S7YCC	BP7EFS	3526
S9YC	BP6EFS	3812
S9YCC	BP6EFS	3812
UD16	AB6	2910
UF-11Y	APR5FS	3122
UF-14Y	APR5FS	3122
UF-9Y	APR6FS	2922
UJ12	B2	3110
UJ18Y	BP4	2911
UJ2J	B8S	3810
UJ4J	B7S	3710
UJ6	B6S	3510
UJ8	B6S	3510
UJ81C	B7S	3710
UJ81J	B7S	3710
UK10	AB6	2910
UL17V	BUHXW-1	5526
UL18V	BUHX	2522
UL4J	B7HS	5110
UL77V	BUHXW-1	5526
UL81C	B7HS	5110
UL81J	B7HS	5110
UN12Y	BP5ES	6511
UN19V	BUE	2322
UN79Y	BP6ES	7811
V12YC	BP5FS	3412
V4C	B7FS	3027
V59C	R5673-9	3856
V9YC	BP6FS	3512
XC10YC	BCPR6ES	2330
XC12YC	BCPR5ES	6130
XC92YC	BCPR5ES	6130
XJ4J	B7S	3710
XJ-8	BR6S	3522
XL-10	BR6HS	3922
XN-8	BR6ES	4922
Y82	CM-6	5812

CHAMPION	NGK → STOCK No.	
Z10	C6HSA	3228
Z12	C6HSA	3228
Z6	C8HSA	6821

CHINESE BRANDS NGK → STOCK No.		
A5RC	CR5HS	2874
A5RTC	CR5HS	2874
A6C	C6HSA	3228
A6RTC	CR6HSA	2983
A6RC	CR6HSA	2983
A6TC	C6HSA	3228
A7C	C7HSA	4629
A7RC	CR7HSA	4549
A7RTC	CR7HSA	4549
A7TC	C7HSA	4629
A7TCI	CR7HIX	7544
A8C	C8HSA	6821
A8RC	CR8HSA	2086
A8RTC	CR8HSA	2086
A8TC	C8HSA	6821
B7	C7E	5096
B7R	CR7E	4578
B7RD	CR7EK	7546
B8	C8E	7471
B9	C9E	7499
B9R	CR9E	6263
B9RD	CR9EK	4548
BM6A	BM6A	5921
CMR7H	CMR7H	3066
D7C	D7EA	7912
D7RC	DR7EA	7839
D8C	D8EA	2120
D8RC	DR8EA	7162
D8RTC	DR8EA	7162
D8TC	D8EA	2120
D9C	D9EA	2420
D9RC	DR9EA	3437
DK6RTC	DCPR6E	3481
DK7RTC	DCPR7E	3932
DK8RTC	DCPR8E	4339
E5C	B5HS	4210
E5RC	BR5HS	3722
E5RTC	BPR5HS	6222
E5T	BP5HS	4111
E5TC	BP5HS	4111
E6C	B6HS	4510
E6RC	BR6HS	3922
E6RTC	BPR6HS	7022
E6T	BP6HS	4511
E6TC	BP6HS	4511
E7C	B7HS	5110
E7RC	BR7HS	4122
E7RTC	BPR7HS	6422
E7TC	BP7HS	5111
E8C	B8HS	5510
E8RC	BR8HS	4322
E8RTC	BPR8HS	3725
E8TC	BP8HS	2630
F5TC	BP5ES	6511
F6C	B6ES	7310
F6RC	BR6ES	4922
F6RJY	BUR6ET	3172
F6RTC	BPR6ES	7822
F6TC	BP6ES	7811
F6TJC	BP6ET	1263
F7C	B7ES	1111
F7RC	BR7ES	5122
F7RTC	BPR7ES	2023
F7T	BP7ES	2412
F7TC	BP7ES	2412
F8C	B8ES	2411
F8RC	BR8ES	5422
GL4	B4LM	3410
K5RF	BKR5E	7938

CHINESE BRANDS NGK → STOCK No.		
K5RF-11	BKR5E-11	6953
K5RTC	BKR5E	7938
K5RTC-11	BKR5E-11	6953
K6RF	BKR6E	6962
K6RF-11	BKR6E-11	2756
K6RTC	BKR6E	6962
K6RTC-11	BKR6E-11	2756
L4C	BM4A	5628
L4RTC	BPMR4A	6028
L6C	BM6A	5921
L6RTC	BPMR6A	6726
L6TC	BPM6A	7021
L7C	BM7A	6521
L7RTC	BPMR7A	4626
L7TC	BPM7A	7321
L8RTC	BPMR8Y	2218
LR4C	BMR4A	5728
LR6C	BMR6A	7421
LR7C	BMR7A	4226
T1137C	C7HSA	4629
T4197JC	BP7ES	2412

CHRYSLER GROUP NGK → STOCK No.		
04606402AB	LZTR4A-11	5444
04606591AB	ZFR5LP-13G	7781
SPZFR5LP13G	ZFR5LP-13G	7781
SPO00ZFR5N	ZFR5N	7917
SPLZTR5A13	LZTR5AIX-13	2314

CITROEN NGK → STOCK No.		
1607577680	DILFR5A11	93759
5960.57	LF6B	6677
5960.F0	BKR6EZ	4619
5960.G1	LZKAR7A	6799
5960.G4	PLZKBR7B8DG	90223
5960.H9	PLZKBR7B8DG	90223
5960.L0	PLZKBR7B8DG	90223
5960.L2	LF6C-11	5788
5960.L5	ILZKBR7B8DG	95770
59622A	BPR6ES	7822
59622T	BKR6EKC	2848
59622X	BKR6E	6962
59625G	BKR6EZ	4619
59627S	BKR6EZ	4619
5962IA	BP5ET	2287
5962IK	BKR6EK	2288
5962IL	BKR5EK	7956
59620E	BKR6EK	2288
5962S7	BP5ES	6511
5962TO	BKR6E	6962
5962W1	BCPR5ES	6130
5962X8	BCP6ES	4930
5962Z1	BKR6EK	2288
5962Z6	BKR5EK	7956
95 496 692	BP6HS	4511
95 605 398	B6HS	4510
95 611 941	BP6EFS	3812
95 619 043	BP6ES	7811
96 000 090	BCP5ES	7496
96 037 952	BCP5ES	7496
96 039 962	BCP6ET	4563
96 064 890	BCPR5ES	6130
96 097 486	BCP7ET	2078
96 145 071	BCPR6ET	2197
96 762 881 80	LZKR6AI-10G	97999
97 533 994	BP7EFS	3526
AM212207A	B6HS	4510
MKP00073	BP7ES	2412
ZC9862090U	BP5ES	6511
ZCT000011	BP6HS	4511
ZCT000012	BP7ES	2412

CLARK NGK → STOCK No.		
444771	BP2ES	3467

CLARK NGK → STOCK No.		
446323	BPR5FS	2423
446583	BMR6A	7421
742159	AB-6	2910
784250	AB-6	2910
890210	BMR6A	7421
890215	AB-6	2910
890217	AB-6	2910
890219	BMR6A	7421
890220	BMR6A	7421
890221	AB-6	2910
890222	AB-6	2910
890225	BMR6A	7421
890227	AB-6	2910
890236	BMR6A	7421
890245	AB-6	2910
890246	AB-6	2910
890247	AB-6	2910
890252	BMR6A	7421
890253	BMR6A	7421
890256	AB-6	2910
890264	AB-6	2910
890265	BMR6A	7421
890267	BMR6A	7421
890271	AB-6	2910
890272	AB-6	2910
890273	AB-6	2910
890274	AB-6	2910
890276	AB-6	2910
907621	AB-6	2910
909377	BPR4ES	7222
909378	BP5EY	7327
912703	BPR4ES	7222
913628	AB-6	2910
913633	AB-6	2910
913638	AB-6	2910
913639	BPR4ES	7222
913831	AB-6	2910
922786	BPR4FS	1127
923702	PTR5D-10	3784
925049	BPR5FS	2423
940328	AB-6	2910
1332679	BPR4ES	7222
2385639	BPR4ES	7222
3739054	AB-6	2910
4338827	BPR4ES	7222

CROWN NGK → STOCK No.		
380013-001-02	B6ES	7310
380013-002-02	BCPR5E-11	1273
380013-004-02	BPR4ES	7222
380013-005-02	BPR2ES	2264
380013-006-02	BP5EY	7327
380013-007-02	BP2ES	3467
380013-008-02	BPR5FS	2423
380013-009-02	BPR5ES	7422
380013-010-02	BPR5EY	2828
300013-012-02	AB-6	2910
380013-013-02	BCPR6E	1269
300013-014-02	PTR5D-10	3784
380013-016-02	BPR4FS	1127
380013-017-02	BMR6A	7421
380013-018-01	BPR6EFS	3623
380013-019-01	BPR4ES	7222
380105-051	B4LM	3410

DAEWOO NGK → STOCK No.		
A218756	BPR5FS	2423
A219024	BPR5FS	2423
A218377	BPR5ES	7422
A223103	BCPR6E	1269
D141267	BMR6A	7421
D700699	BMR6A	7421
8N2236	BMR6A	7421

DENSO	NGK → STOCK No.	DENSO	NGK → STOCK No.	DENSO	NGK → STOCK No.	DENSO	NGK → STOCK No.	
4116	DR8ES	5423	5309	DCPR8EIX	6546	5749	R7438-8	4905
4117	DPR9Z	4830	5310	BKR7EIX	2667	5750	R7438-9	4656
4123	B11EGV	5831	5311	BKR8EIX	2668	5752	R7440B-10T	5009
4126	CR8E	1275	5312	BKR9EIX	2669	5753	R7440B-11T	5495
4127	CR8EH-9	5666	5316	BR8EIX	5044	5754	R7440A-9L	3795
4128	C9E	7499	5317	BR9EIX	3981	5755	R7440A-10L	4282
4129	CR9EH-9	7502	5319	BR10EIX	6801	6000	BUHX	2522
4131	CR9E	6263	5321	R7434-10	4894	6001	BUHW	2622
4135	CR10EK	2360	5326	BPR6EFIX-10	94658	6002	BUHW-2	5626
4137	C7E	5096	5336	FR9BI-11	4709	6004	B2	3110
4155	CR9EK	4548	5337	DCPR9EIX	2316	6005	BP2ES	3467
4158	CR8EK	3478	5338	LTR5IX-11	4344	6009	B4ES	4129
4159	BR9ECM	3252	5339	PLTR6A-10G	3587	6011	BPR4ES	7222
4160	BR10ECS	5880	5345	ILFR7H	5245	6013	B4L	3112
4161	BPR6HSA	4632	5348	BKR7EIX	2667	6015	BM4A	5628
4162	ER9EH	5869	5349	LZTR5AIX-13	2314	6018	BPMR4A	6028
4168	BP7HS-10	7829	5351	BKR5EIX-11	5464	6019	BMR4A	5728
4169	CR10EIX	6482	5352	BKR6EIX-11	3764	6021	BP4	2911
4171	CR5HS	2874	5361	CR7EIX	7385	6023	BPM6A	7021
4172	DR9EIX	4772	5362	CR8EIX	4218	6025	BMR6A	7421
4174	CR7E	4578	5363	CR9EIX	3521	6028	B9HS-10	3626
4175	BR8EIX	5044	5368	CR8EHIX-9	3797	6033	B4	3210
4176	BR10ES	4832	5369	CR9EHIX-9	6216	6034	BM4A	5628
4178	BP8HS	2630	5372	DR8EIX	6681	6035	B4LM	3410
4185	ER8EH	4011	5373	DR9EIX	4772	6036	BM6A	5921
4186	ER10EH	2862	5375	DPR7EIX-9	7803	6039	BM6F	6221
4187	CR10E	6264	5376	DPR8EIX-9	2202	6040	BPM6F	5950
4188	BPR8HS	3725	5377	DPR9EIX-9	5545	6041	BM7F	6421
4189	CR8EIX	4218	5378	BPR6HIX	4085	6042	BPM7F	1268
4191	CR9EIX	3521	5379	BR7HIX	7067	6043	BPMR7A	4626
4192	BPR5HS	6222	5380	BR8HIX	7001	6044	BPR2ES	2264
4196	C8E	7471	5383	CR7HIX	7544	6047	B8HS-10	5126
4203	CR9EHIX-9	6216	5384	CR8HIX	7669	6048	BM7A	6521
4206	CR8HSA	2086	5388	CR9EHI-9	6419	6049	BPM7A	7321
4222	CR5EH-9	6689	5390	CR9EIA-9	6289	6050	CR5HSB	6535
4223	CR8EB	7784	5391	BR8ECMIX	3520	6051	B7HS	5110
4224	CR9EB	6955	5392	BR9ECMIX	2707	6052	B7HS-10	2129
5008	APR5FS	3122	5393	BR10ECMIX	3006	6053	BR6HS	3922
5009	APR5FS	3122	5502	BPR6EIX-LPG	2347	6054	B6HS	4510
5010	APR5FS	3122	5603	IFR5J11	7418	6057	B2LM	1147
5012	AP6FS	2710	5607	BPR7EIX	4055	6060	B8HS	5510
5013	APR6FS	2922	5614	IJR7A9	7901	6068	BR8ES	5422
5018	FR5-1	7252	5615	IFR6L11	3678	6069	BR9ES	5722
5020	BPR4FS	1127	5616	IFR8H11	5068	6070	CR4HSB	4695
5021	BPR4FS-15	2727	5618	ILFR6J-11K	4458	6071	BR2LM	5798
5022	BPR5EFS	2223	5619	ILFR7H	5245	6073	B8HS-10	5126
5024	BP5FS	3412	5623	HB6AIX-11P	5703	6076	LF85A-11	6376
5025	BPR5FS	2423	5625	HB6BIX-11P	5705	6079	CM-6	5812
5026	BPR5FS-11	2924	5628	IFR5L11	6502	90919-01217	IFR5T11	4996
5027	BPR5FS-15	3124	5630	IFR9H11	6588	90919-01218	IFR5T11	4996
5029	BR5FS	4123	5631	IMR9B-9H	4888	90919-01240	IFR5T11	4996
5031	BP6EFS	3812	5633	IZFR6F11	4095	9807B-5615P	ZFR6K-11	6711
5032	BPR6EFS	3623	5642	IMR9C-9HES	5766	9807B-5615W	IZFR6K11	6994
5034	BP6FS	3512	5701	R7434-8	4892	DK20PR-D13	DIFR6D13	94167
5035	BPR6FS	2623	5702	R7434-9	4658	FK16HR11	DILFR5A11	93759
5038	BR6FS	4323	5703	R7434-10	4894	FK16HQR11	DILFR5A11	93759
5040	BP7EFS	3526	5704	R7434-8	4892	FK20HBR-11	DFH6B-11A	6858
5060	BKUR6ET	6437	5705	R7434-9	4658	FXE20HR11	PLZKAR6A-11	5118
5062	BKUR7ET	7873	5706	R7434-10	4894	FXE22HR11	DF7H-11B	1317
5065	BP6ET	1263	5707	R7436-8	4898	FXE24HR11	DF8H-11B	1305
5067	BUR6ET	3172	5708	R7436-9	4899	IA01-32	R7282A-105	4614
5068	PTR5A-10	5055	5709	R7436-10	4900	IA01-34	R7282A-11	4754
5069	BCP7ET	2078	5710	R7436-8	4898	IAE01-32	R7282-105	4985
5070	PTR5D-10	3784	5711	R7436-9	4899	IAE01-34	R7282-11	2001
5086	TR5A-10	0005	5712	R7436-10	4900	IK01-24	R7434-8	4892
5087	ITR6F13	4477	5714	R7376-9	7763	IK01-27	R7434-9	4658
5093	PTR5A-10	5055	5716	R7376-10	4457	IK01-31	R7434-10	4894
5301	BCPR5EIX-11	3306	5724	R7282A-105	4614	IK02-24	R7434-8	4892
5302	BCPR6EIX-11	4919	5725	R7282A-11	4754	IK02-27	R7434-9	4658
5303	BKR5EIX-11	5464	5735	R0373A-9	3388	IK02-31	R7434-10	4894
5304	BKR6EIX-11	3764	5736	R0373A-10	4940	IK16	BKR5EIX-11	5464
5306	BPR6EIX-11	3903	5737	R0373A-11	5566	IK16G	BKR5EIX-11	5464
5307	BPR7EIX	4055	5747	R7282-105	4985	IK16L	ZFR5FIX-11	2477
5308	DCPR7EIX	6046	5748	R7282-11	2001	IK20	BKR6EIX-11	3764
IK20G	BKR6EIX-11	3764						
IK20L	ZFR6FIX-11	6441						
IK22	BKR7EIX	2667						
IK22G	BKR7EIX	2667						
IK24	BKR8EIX	2668						
IK27	BKR9EIX	2669						
IK27C11	FR9BI-11	4709						
IK31	R7434-10	4894						
IKBH20TT	DFH6B-11A	6858						
IKH01-24	R7438-8	4905						
IKH01-27	R7438-9	4656						
IKH22	ILFR7H	5245						
IQ01-24	R7436-8	4898						
IQ01-27	R7436-9	4899						
IQ01-31	R7436-10	4900						
IQ02-24	R7436-8	4898						
IQ02-27	R7436-9	4899						
IQ02-31	R7436-10	4900						
IQ16	BCPR5EIX-11	3306						
IQ20	BCPR6EIX-11	4919						
IQ22	BCPR7EIX	5690						
IRE01 27	R7420-9	6448						
IRE01 31	R7420-10	5501						
IRE01 34	R7420-11	7756						
IRL01-27	R7440A-9L	3795						
IRL01-31	R7440A-10L	4282						
IRT01-31	R7440B-10T	5009						
IRT01-34	R7440B-11T	5495						
IT20	BPR6EFIX-10	94658						
IT22	TR7IX	3690						
ITL16	LZTR5AIX-13	2314						
ITV16	LTR5IX-11	4344						
IU01-27	R0373A-9	3388						
IU01-31	R0373A-10	4940						
IU01-34	R0373A-11	5566						
IU22	CR7EIX	7385						
IU24	CR8EIX	4218						
IU27	CR9EIX	3521						
IU27D	CR9EIA-9	6289						
IU31	CR10EIX	6482						
IUF22	CR7HIX	7544						
IUF24	CR8HIX	7669						
IUH24	CR8EHIX-9	3797						
IUH27	CR9EHIX-9	6216						
IUH27D	CR9EHI-9	6419						
IW01-27	R7376-9	7763						
IW01-31	R7376-10	4457						
IW06-27	R7376-9	7763						
IW06-31	R7376-10	4457						
IW20	BPR6EIX-11	3903						
IW22	BPR7EIX	4055						
IW24	BR8EIX	5044						
IW27	BR9EIX	3981						
IW31	BR10EIX	6801						
IWF20	BPR6HIX	4085						
IWF22	BR7HIX	7067						
IWF24	BR8HIX	7001						
IWM24	BR8ECMIX	3520						
IWM27	BR9ECMIX	2707						
IWM31	BR10ECMIX	3006						
IX22B	DPR7EIX-9	7803						
IX24	DR8EIX	6681						
IX24B	DPR8EIX-9	2202						
IX27	DR9EIX	4772						
IX27B	DPR9EIX-9	5545						
IXU22	DCPR7EIX	6046						
IXU24	DCPR8EIX	6546						
IXU27	DCPR9EIX	2316						
K14P-U11	BKR5E-11	6953						
K16GPR-U11	ZFR5E-11	4435						
K16HR-U11	LF86C-11	5788						
K16HPR-U11	LF85A-11	6376						
K16PRP11	BKR5EVX	2546						
K16PR-TP11	BKR5EIX-11	5464						

DENSO	NGK → STOCK No.	DENSO	NGK → STOCK No.	DENSO	NGK → STOCK No.	DENSO	NGK → STOCK No.				
K16PR-U	BKR5E	7938	PK20R8	BKR6EP-8	2215	T14PR-U	BPR4FS	1127	VK24PR-Z11	IFR8H11	5068
K16PR-U11	BKR5E-11	6953	PK20TR11	BKR6EKP-11	3452	T14PR-U15	BPR4FS-15	2727	VK27PR-Z11	IFR9H11	6588
K16PU	BKR5E	7938	PK22PR11	PFR7G-11S	7772	T16EPR-U	BPR5EFS	2223	VKA20	HB6AIX-11P	5703
K16PU11	BKR5E-11	6953	PK22PR8	PFR7B	4853	T16EX-U	BP5EFS	3712	BK20	HB6BIX-11P	5705
K16R-U	BKR5EYA	2087	PK22PR-L11	PFR7G-11S	7772	T16PR-U	BPR5FS	2423	VFKH16	DILFR5A11	93759
K16R-U11	BKR5EYA-11	2526	PK22PR-L11S	PFR7G-11S	7772	T16PR-U11	BPR5FS-11	2924	VKH20	ILFR6J-11K	4458
K16RZ-U11	BKR5EIX-11	5464	PK22PR-TP	PFR7M	4877	T16PR-U15	BPR5FS-15	3124	VKH20Y	ILFR6B	6481
K16TNR-S9	BKR5EKC	5216	PKJ16CR-L11	PZFR5F-11	4363	T16P-U	BP5FS	3412	VKH22	ILFR7H	5245
K16TR-11	BKR5EKB-11	3967	PKJ20CR8	PZFR6F	7550	T16R-U	BR5FS	4123	VKJ20RZ-M11	IZFR6F11	4095
K20BR-S10	BKUR6ETB-10	5742	PKJ20CR-L11	PZFR6F-11	3271	T16VR-U10	TR5A-10	0005	VNH27Z	IMR9B-9H	4888
K20HR-U11	LFRR6C-11	5788	PKJ20CR-M11	PZFR6F-11	3271	T20EPR-U	BPR6EFS	3623	VUH24D	IMR8C-9H	3653
K20PBR	BKUR6ET	6437	PQ16R	BCPR5EP-11	2097	T20EP-U	BP6EFS	3812	VUH27D	IMR9C-9H	6777
K20PR-L11	BKR6E-N-11	5724	PQ16R8	BCPR5EP-8	2950	T20EX-U	BP6EFS	3812	VUH27ES	IMR9C-9HES	5766
K20PR-TP11	BKR6EIX-11	3764	PQ20R	BCPR6EP-11	3350	T20MP-U	BPM6F	5950	VUH27Z	IMR9A-9H	6966
K20PR-U	BKR6E	6962	PQ20R8	BCPR6EP-N-8	5275	T20M-U	BM6F	6221	VW20T	BPR6EIX-LPG	2347
K20PR-U11	BKR6E-11	2756	PQ20R-P11	BCPR6EP-N-11	4497	T20PR-U	BPR6FS	2623	VW22	BPR7EIX	4055
K20PR-ZU11	BKR6EIX-11	3764	PQ20R-P8	BCPR6EP-N-8	5275	T20PR-U15	BPR6FS	2623	VX22BC	IJR7A9	7901
K20PSR-B8	IFR6S	99404	PT16EPR10	PTR5D-10	3784	T20P-U	BP6FS	3512	VX22BZ	IJR7A9	7901
K20P-U	BK6E	3536	PT16EPR13	PTR5D-10	3784	T20R-U	BR6FS	4323	W14	B4	3210
K20P-U11	BKR6E-11	2756	PT16EPR13	PTR5D-10	3784	T22EP-U	BP7EFS	3526	W14E	B4ES	4129
K20R-U	BKR6EYA	2249	PT16VR10	PTR5A-10	5055	T22MP-U	BPM7F	1268	W14EPR-U	BPR4ES	7222
K20R-U11	BKR6EYA-11	4073	PT16VR-13	PTR5A-10	5055	T22M-U	BM7F	6421	W14ER-U	BR4ES	1097
K20R-ZU11	BKR6EP-11	2978	PTJ16R15	PZTR5A-15	7862	TR20	B6HS	4510	W14F	B4H	4110
K20TNR	BKR6EKC	2848	Q16PR-U	BCPR5E	1145	TR22	B7HS	5110	W14FP	BP4HS	3611
K20TNR-S	BKUR6EK	2213	Q20PR-U	BCPR6E	1269	TR22-10	B7HS-10	2129	W14FP-L	BP4HS	3611
K20TR-11	BKR6EKB-11	3583	Q20PR-U11	BCPR6E-11	3132	TR24	B8HS	5510	W14FPR	BPR4HS	7823
K20TRX	BKR6EKU	6993	Q20PR-ZU11	BCPR6EIX-11	4919	TR24-10	B8HS-10	5126	W14FPR-L	BPR4HS	7823
K20TXR	BKR6EKC	2848	Q20P-U	BCP6ES	4930	U14FSR-UB	CR4HSB	4695	W14FPR-U	BPR4HS	7823
K22PB	BCP7ET	2078	Q20P-U11	BCPR6E-11	3132	U16FER-9	CR5EH-9	6689	W14FPR-UL	BPR4HS	7823
K22PBR-S	BKUR7ET	7873	Q20R-U11	BCPR6EY-11	3720	U16FSR-L	CR5HS	2874	W14FPR-UL10	BPR4HS-10	5024
K22PR-U	BKR7E	6097	Q22PR-U	BCPR7ES	3330	U16FSR-U	CR5HS	2874	W14FP-U	BP4HS	3611
K22PR-U11	BKR7E-11	1283	Q22PR-U11	BCPR7ES-11	1095	U16FSR-UB	CR5HSB	6535	W14FP-UL	BP4HS	3611
K22PR-ZU	BKR7EIX	2667	Q22PR-ZU	BKR7EIX	2667	U16FS-UB	CR5HSB	6535	W14FR-U	BR4HS	3322
K22TMR	BKR7EKC-N	2095	Q22P-U	BCP7ES	5030	U20EPR-U	CPR6EA-9	6899	W14F-U	B4H	4110
K22TMR11	BKR7EKC-N	2095	Q22P-U11	BCPR7ES-11	1095	U20ESR-N	CR6E	6965	W14L	B4L	3112
K22TNR	BKR7EKC	7354	Q27A-Z	R7435-9	4896	U20FS	C6HSA	3228	W14LMR-US	BR4LM	4133
K22TNR-S	BKR7EKC	7354	Q27PR-ZU	BKR9EIX	2669	U20FS-L	C6HSA	3228	W14LM-U	B4LM	3410
KJ14CR-L11	ZFR4F-11	4043	QJ16AR-U	BCRE527Y	2074	U20FSR-U	CR6HSA	2983	W14LM-US	B4LM	3410
KJ16CR	ZFR5F	5165	QJ16CR11	ZFR5A-11	5084	U20FS-U	C6HSA	3228	W14MPR-U10	BP4MR4A	6028
KJ16CR-11	ZFR5F-11	2262	QJ16HR-U	FR5-1	7252	U20M-U	CM-6	5812	W14MR-U	BMR4A	5728
KJ16CR-L11	ZFR5J-11	5584	QJ16HR-U9	FR5-1	7252	U22ES-N	C7E	5096	W14M-U	BM4A	5628
KJ16CR-U11	ZFR5F-11	2262	QJ20C11	ZFR6F-11	4291	U22ESR-N	CR7E	4578	W14M-US	BM4A	5628
KJ20CR-11	ZFR6F-11	4291	QJ20CR-11	ZFR6A-11	1041	U22FS	C7HSA	4629	W14P	BP5S	3011
KJ20CR-L11	ZFR6J-11	5585	RU01-31	R0045Q-10	4216	U22FS-L	C7HSA	4629	W14PR-U	BP4	2911
KJ20CR-U11	ZFR6F-11	4291	RU01-34	R0045Q-11	5957	U22FSR-L	CR7HS	7223	W14-U	B4	3210
KJ20DR-M11	ZFR6K-11	6711	S22PR-A7	IGR7A	6687	U22FSR-U	CR7HSA	4549	W14-US	B4	3210
KJ20SR-11	ZFR6FIX-11	6441	SC20HR11	ILKAR7B11	4912	U22FS-U	C7HSA	4629	W16EP-GU	BPR5EIX	6597
KJ22CR-L11	ZFR7F-11	2975	SF-10	BUHX	2522	U24ES-N	C8E	7471	W16EPR-U	BPR5ES	7422
L14-U	AB6	2910	SF-50	BUHW	2622	U24ESR-N	CR8E	1275	W16EPR-U11	BPR5ES-11	4424
M17	AB6	2910	SF-51	BUHW-2	5626	U24ESR-NB	CR8EB	7784	W16EP-U	BP5ES	6511
M22	AB7	3010	SK16HR11	ILFR5T11	96779	U24ESR-NZU	CR8EIX	4218	W16EP-ZU	BPR5EIX	6597
M24S	AB8	7909	SK16PR11	IFR5G-11K	3107	U24ETR	CR8EK	3478	W16ES	B5ES	6410
MA16PR-U	APR5FS	3122	SK16PR-A11	IFR5E11	7994	U24FER9	CR8EH-9	5666	W16ES-L	BR5ES	4722
MA16PR-U11	APR5FS	3122	SK16PR-E11	IFR5E11	7994	U24FS	C8HSA	6821	W16ESR-U	BR5ES	4722
MA16PR-U15	APR5FS	3122	SK16PR-L11	IFR5G-11K	3107	U24FS-C	C8HSA	6821	W16ES-U	B5ES	6410
MA17P-U	AP6FS	2710	SK16R11	IFR5T11	4996	U24FS-L	C8HSA	6821	W16EXR-U	BPR5EY	2828
MA20PR-U	APR6FS	2922	SK16R-P8	IFR5T-8N	3508	U24FSR-C	CR8HSA	2086	W16EXR-U11	BPR5EY-11	3028
MA20P-U	AP6FS	2710	SK20BGR11	HB6AIX-11P	5703	U24FSR-U	CR8HS	7423	W16EX-U	BP5EY	7327
P16PR11	PGR5A-11	3573	SK20HPR11	ILFR6J-11K	4458	U24FS-U	C8HSA	6821	W16FP	BP5HS	4111
P16PR8	PGR5A	3987	SK20PR-A11	IFR6E11	6741	U27ES-N	C9E	7499	W16FPR	BPR5HS	6222
P16R	BPR5EP-11	3971	SK20PR-L11	IFR6G11K	1314	U27ESR-N	CR9E	6263	W16FPR-U	BPR5HS	6222
P20PR8	PGR6A	4984	SK20PR-L9	IFR6D10	5344	U27ESR-NB	CR9EB	6955	W16FP-U	BP5HS	4111
P22PR8	PGR7A	3200	SK20R11	IFR6T11	4589	U27ESR-NZU	CR9EIX	3521	W16FS	B5HS	4210
PK16PR11	PFR5B-11	2300	SK20R-P11	IFR6T11	4589	U27ETR	CR9EK	4548	W16FSR	BR5HS	3722
PK16PR-L11	PFR5G-11	2647	SK22PR-M11	IFR7G-11KS	7746	U27FER-9	CR9EH-9	7502	W16FS-U	B5HS	4210
PK16PR-P11	PFR5J-11	4642	SK22PR-M11S	IFR7G-11KS	7746	U27FER-ZU9	CR9EHIX-9	6216	W16LS	B6L	3212
PK16R11	BKR5EP-11	3440	SKJ16CR-A8	IFR5G	5887	U31ESR-N	CR10E	6264	W16P-U	BP5S	3011
PK20PR11	PFR6B-11	4014	SKJ20DR-M11	IZFR6K11	6994	U31ESR-NZU	CR10EIX	6482	W16S-U	BMR6A	7421
PK20PR-L11	PFR6G-11	5555	SKJ20DR-M11S	IZFR6K-11S	5266	U31ETR	CR10EK	2360	W17ES	B6ES	7310
PK20PR-P	PFR6B	3500	SKJ20DR-M13	IZFR6K13	6774	VFXEH20	ILKAR7C10	94940	W20EPB	BP6ET	1263
PK20PR-P11	PFR6J-11	2743	SVK20R-Z11	IFR6J11	7658	VK16	IFR5J11	7418	W20EPBRS	BUR6ET	3172
PK20PR-P8	PFR6B	3500	SVK20R-Z8	BKR6EP-8	2215	VK16PR-Z11	IFR5L11	6502	W20EP-GU	BPR6EIX	6637
PK20R-11	BKR6EP-11	2978	SXU22HCR11S	SILZKR7C11S	92932	VK20PR-Z11	IFR6L11	3678	W20EPR-U	BPR6ES	7822
PK20R-13	BKR6EP-13	2550	SXU22PR9	IKR7D	4759	VK20T	BKR6EIX-LPG	3356	W20EPR-U10	BPR6ES-11	4824

DENSO	NGK → STOCK No.	DENSO	NGK → STOCK No.	DENSO	NGK → STOCK No.	DUCATI	NGK → STOCK No.				
W20EPR-U11	BPR6ES-11	4824	W24ESR-U	BR8ES	5422	W9LM-US	B2LM	1147	6704038A1	MAR10A-J	4706
W20EPR-ZU	BPR6EIX	6637	W24ESRV	BR8EG	3130	W9P	BP4	2911	67040491	KR8C-G	97516
W20EP-U	BP6ES	7811	W24ESR-ZU	BR8EIX	5044	W9P-U	BP-4	2911	ENKER / BOSNA NGK → STOCK No.		
W20EP-ZU	BPR6EIX	6637	W24ES-U	B8ES	2411	W9-U	B2	3110	F100C	B8HS	5510
W20ES	B6ES	7310	W24ES-V	B8EG	3430	WA20M	BM6F	6221	F45CP	BP4HS	3611
W20ES-L	BR6ES	4922	W24ES-ZU	BR8EIX	5044	WA20M-U	BM6F	6221	F50C	B5HS	4210
W20ESR	BR6ES	4922	W24FPR	BPR8HS	3725	WA22M	BM7F	6421	F55CP	BP5HS	4111
W20ESR-L	BR6ES	4922	W24FP-U	BP8HS	2630	WA22M-U	BM7F	6421	F65CP	BP6HS	4511
W20ESR-U	BR6ES	4922	W24FR-L	BR8HSA	5539	X16EPR-U9	DPR5EA-9	2887	F75C	B6HS	4510
W20ES-U	B6ES	7310	W24FS	B8HS	5510	X16EPR-U9	DPR5EA-9	2887	F80C	B7HS	5110
W20ETR-L	BPR6EKN	1128	W24FS-GU	BR8HIX	7001	X16FSR-U	DR5HS	4623	F85CP	BP7HS	5111
W20EXR-U	BPR6EY	6427	W24FSR	BR8HS	4322	X16FS-U	DR5HS	4623	FA50	B4L	3112
W20EXR-U11	BPR6EY-11	4228	W24FSR-U10	BR8HS-10	1134	X20EPR-U9	DPR6EA-9	5531	FA70	B6L	3212
W20EX-U	BP6EY	7727	W24FS-U	B8HS	5510	X20ES-U	D6EA	7512	FE100C	B9ES	2611
W20FP	BP6HS	4511	W24FS-U10	B8HS-10	5126	X20FSR-U	DR6HS	4823	FE30C	B4ES	4129
W20FPR	BPR6HS	7022	W24FS-ZU	BR8HIX	7001	X22EPR-U9	DPR7EA-9	5129	FE45CP	BP5ES	6511
W20FPR-U	BPR6HS	7022	W24S	B8S	3810	X22EPR-U9	DPR7EA-9	5129	FE50C	B5ES	6410
W20FP-U	BP6HS	4511	W24S-U	B8S	3810	X22EPR-ZU9	DPR7EA-9	7803	FE55CP	BP5ES	6511
W20FP-U10	BP6HS-10	6326	W25EB	BR8ET	4221	X22EP-U9	DPR7EA-9	5129	FE55CPD	BP5ET	2287
W20FR-L	BPR6HSA	4632	W25EBR	BR8ET	4221	X22EP-ZU9	DPR7EA-9	7803	FE65CP	BP6ES	7811
W20FS	B6HS	4510	W25EDR	BR8EQ	3328	X24EPR-U9	DPR8EA-9	4929	FE65CPD	BP6ET	1263
W20FSR	BR6HS	3922	W25EN	B8EG	3430	X24EPR-U9	DPR8EA-9	4929	FE70C	B6ES	7310
W20FSR-U	BR6HS	3922	W25EPT	B8EGP	2046	X24EP-U9	DPR8EA-9	4929	FE75C	B7ES	1111
W20FS-U	B6HS	4510	W25FN	BR8HIX	7001	X24EP-ZU9	DPR8EA-9	4929	FE80C	B8ES	2411
W20M	BM6A	5921	W27AZ	BR9HIX	5687	X24EP-U9	DPR8EA-9	4929	FE85CP	BP7ES	2412
W20MP-U	BPM6A	7021	W27EBR	BR9ET	4528	X24EP-U9	DPR8EA-9	4929	FE95CP	BP8ES	2912
W20MR-U	BMR6A	7421	W27EMR-C	BR9ECM	3252	X24EP-U9	DPR8EA-9	4929	FET65CP	BP5EFS	3712
W20M-U	BM6A	5921	W27EMR-ZU	BR9ECMIX	2707	X24EP-ZU9	DPR8EA-9	2202	FET75CP	BP6EFS	3812
W20M-US	BM6A	5921	W27EN	B9EG	3530	X24ES-GU	DR8EIX	6681	FS20	B2	3110
W20S	B6S	3510	W27ES	B9ES	2611	X24ESR-U	DR8ES-L	2923	FS30	B4	3210
W20SR-U	BR6S	3522	W27ESC	B9ECS	7058	X24ESR-ZU	DR8EIX	6681	FS50CP	BP5S	3011
W20S-U	B6S	3510	W27ES-GU	BR9EIX	3981	X24ES-U	D8EA	2120	FS70	B6S	3510
W22EB	BR7ET	4121	W27ESR	BR9ES	5722	X24ES-ZU	DR8EIX	6681	FS75C	B7S	3710
W22EBR	BR7ET	4121	W27ESR-U	BR9ES	5722	X24FSR-U	DR8HS	5123	FS80	B8S	3810
W22EDR	BR7EQ	5128	W27ESRV	BR9EG	3230	X24FS-U	D8HA	7112	FSC50C	BM6A	5921
W22EP	BP7ES	2412	W27ESR-ZU	BR9EIX	3981	X24GPR-U	DPR8Z	4730	FSC50P	BPM6A	7021
W22EP-GU	BPR7EIX	4055	W27ES-U	B9ES	2611	X24GP-U	DPR8Z	4730	FSC70P	BPM6A	7021
W22EPR-U	BPR7ES	2023	W27ES-V	B9EG	3530	X27EPR-U9	DPR9EA-9	5329	FSC75CP	BPM7A	7321
W22EP-U	BP7ES	2412	W27ES-ZU	BR9EIX	3981	X27EPR-ZU9	DPR9EIX-9	5545	FT45CP	BP5FS	3412
W22EP-ZU	BPR7EIX	4055	W27FS	B9HS	5810	X27EP-U9	DPR9EA-9	5329	FT55CP	BP6FS	3512
W22ES	B7ES	1111	W27FS-GU	BR9HIX	5687	X27ESR-U	DR8ES	5423	FT85CP	BP7FS	3612
W22ES-GU	BR7EIX	6664	W27FSR	BR9HS	4522	X27ESR-ZU	DR9EIX	4772	M30	AB2	3020
W22ESR	BR7ES	5122	W27FSR-U10	BR9HS-10	4551	X27ES-U	D9EA	2420	M60	AB6	2910
W22ESR-U	BR7ES	5122	W27FS-U	B9HS	5810	X27GPR-U	DPR9Z	4830	M75	AB7	3010
W22ES-U	B7ES	1111	W27FS-U10	B9HS-10	3626	XE20HR-U9	LZKAR7A	6799	M80	AB8	7909
W22ES-ZU	BR7EIX	6664	W27FS-ZU	BR9HIX	5687	XU20EPR-U	DCPR6E	3481	MT55CP	AP6FS	2710
W22FP	BP7HS	5111	W29AZ	BR10EIX	6801	XU20EPR-ZU	DCPR7EIX	6046	MT65CP	AP7FS	2127
W22FPR	BPR7HS	6422	W29EBR	BR10ET	7480	XU20EP-U	DCPR6E	3481	SFE55CP	BCPR5ES	6130
W22FPR-U	BPR7HS	6422	W29ES-GU	BR10EIX	6801	XU22EPR-U	DCPR7E	3932	SFE65CP	BCPR6ES	2330
W22FP-U	BP7HS	5111	W29ES-ZU	BR10EIX	6801	XU22EPR-ZU	DCPR7EIX	6046	SFE65CPD	BCP6ET	4563
W22FP-U10	BP7HS-10	7829	W31AZ	BR10EIX	6801	XU22EP-U	DCP7E	2363	SFE85CP	BCPR7ES	3330
W22FS	B7HS	5110	W31EMR-C	BR10ECS	5880	XU22EP-ZU	DCPR7EIX	6046	SFE85CPD	BCP7ET	2078
W22FS-GU	BR7HIX	7067	W31EMR-ZU	BR10ECMIX	3006	XU22HDR-9	LKR7B-9	5847	T70	C6HSA	3228
W22FSR	BR7HS	4122	W31EN	B10EG	3630	XU22PR-9	DCPR7EA-9	6651	T90	C7HSA	4629
W22FS-U	B7HS	5110	W31EPT	B10EGP	5224	XU24EPR-U	DCPR8E	4339	EVINRUDE NGK → STOCK No.		
W22FS-U10	B7HS-10	2129	W31ES	BR10ES	4832	XU24EPR-ZU	DCPR8EIX	6546	204470091	BR7ES	5122
W22FS-ZU	BR7HIX	7067	W31ES-GU	BR10EIX	6801	XU24EP-U	DCPR8E	4339	278000237	BR7ES	5122
W22M	BM7A	6521	W31ESR-U	BR10ES	4832	XU24EP-ZU	DCP8EVX	6546	278000608	BR7ES	5122
W22MPR-U	BPMR7A	4626	W31ESR-ZU	BR10EIX	6801	XU27EPR-U	DCPR9E	2641	278000609	BR8ES	5422
W22MP-U	BPM7A	7321	W31ES-U	BR10ES	4832	XU27EPR-ZU	DCPR9EIX	2316	MCBR10EG	BR10EG	3830
W22MP-US	BPM7A	7321	W31ES-ZU	BR10EIX	6801	Y24FER-C	ER8EH	4011	MCBR8EG	BR8EG	3130
W22M-U	BM7A	6521	W31FS	B10HVX	2940	Y27FER	ER9EH	5869	MCBR8HS	BR8HS	4322
W22M-US	BM7A	6521	W31FS-GU	BR10HIX	6692	Y27FER-C	ER9EH	5869	MCBR9EG	BR9EG	3230
W22S	B7S	3710	W31FS-ZU	BR10HIX	6692	Y31FER-C	ER10EH	2862	MCBR9ES	BR9ES	5722
W22S-U	B7S	3710	W32EPT	B11EGP	2191	Z20ES-U	D6EA	7512	EYQUEM NGK → STOCK No.		
W24EMRC	BR8ECM	3035	W34ES-ZU	B11EGV	5831	ZT20EPR11	ITR6F13	4477	1000	B8HS	5510
W24EP	BP8ES	2912	W9	B2	3110	ZXU20PR11	IKR6G11	7980	1000 MOTO	B8HS	5510
W24EP-11	BP8ES	2912	W9EP	BP2ES	3467	DODGE - See CHRYSLER GROUP			1000CM	B7S	3710
W24EPR-U	BPR8ES	3923	W9EXR-U	BPR2ES	2264	DREXEL NGK → STOCK No.			1000L	B8ES	2411
W24EPR-ZU	BPR8EIX	6684	W9EX-U	BP2ES	3467	1411740	BPR5FS	2423	1000L MOTO	B8HS	5510
W24EP-U	BP8ES	2912	W9FP	BP2HS	7926				1000M	B8HS	5510
W24ES	B8ES	2411	W9FP-L	BP2HS	7926						
W24ES-GU	BR8EIX	5044	W9FP-UL	BP2HS	7926						
W24ESR	BR8ES	5422	W9LMR-US	BR2LM	5798						

FORD	NGK → STOCK No.	
AYFS32CJ	TR5B-13	4559
AYFS32BB	ILTR5A-13G	3811
BM5G-124505-CA	ILZTR6A8G	94769
CA6G 12405 AB	LZNAR7AI-8G	97576
CB5E 12405 AA	LTR6DI-8	96588
CM5G 12405 CE	SILZNAR8C7H	93593
CV6E 12405 AA	ILTR5K13	90607
CYFS13YRC	ILZTR6A8G	94769
DJA1535	IFR5N10	7866
CJ5E 12405 AA	LTR6DI-8	96588
XSF6 12405 BA	TR5A-10	0005
YM21 12405 AA	PZFR5D-11	7968
YN2F 12405 A2A	TR5B-13	4559
YN2J 12405 AA	TR5B-13	4559

FOMOCO - See FORD

FUJI	NGK → STOCK No.	
065-01400-10	B4	3210
065-01400-20	B4H	4110
065-01400-31	B6HS	4510
065-01400-41	B7HS	5110
065-01400-50	B7ES	1111
065-01400-60	B6HS	4510
065-01400-80	B4	3210
065-01400-90	B7HS	5110
065-01401-00	B6ES	7310
065-01401-10	B4H	4110
065-01401-30	B7ES	1111
065-01401-40	B8ES	2411
065-01401-50	BR6HS	3922
065-01401-60	B9ES	2611
065-01401-70	BP4HS	3611
065-01401-80	BR7HS	4122
065-01401-90	BP4HS	3611
065-01402-10	BP6HS	4511
065-01402-20	BR10EIX	6801
065-01402-30	BP5ES	6511
065-01402-40	BR8ES	5422
065-01402-50	BR9ES	5722
065-01402-60	BP5HS	4111
065-01402-70	BPR4HS	7823
065-01402-80	BPR5ES	7422
065-01403-00	BP6ES	7811
065-01403-10	BR4HS	3322
065-01403-20	BPR4HS-10	5024
065-01403-30	BPR4ES	7222
065-01403-40	BP2HS	7926
065-01403-60	BP2HS	7926
065-01403-70	BM4A	5628
065-01403-80	BMR4A	5728
065-01403-90	BP4HS	3611
065-01404-20	BPR6HS	7022
065-01404-30	BPM6A	7021
065-01404-60	BM6A	5921
065-01404-70	BMR6A	7421
065-01405-00	B9HS	5810
065-01405-10	BR6HS	3922
932-05410-00	B5ES	6410
982-05486-00	B6ES	7310

GUTBROD	NGK → STOCK No.	
000.80.071	B6HS	4510
000.81.345	B4LM	3410
090.33.668	B4H	4110
090.50.805	BPR6ES	7822
092.05.406	BR2LM	5798
092.05.900	B6S	3510
092.13.609	BR4LM	4133
092.25.081	BP5ES	6511
092.32.278	BCPR5ES	6130
092.38.072	BPR5ES	7422
092.38.467	BM6A	5921
092.40.182	BPR5EFS	2223

HARLEY-DAVIDSON	NGK → STOCK No.	
10R12A	DCPR9E	2641
10R12X	DCPR9E	2641
3	B6L	3212
3-4	BP5S	3011
4	B6L	3212
4-5	BP7HS	5111
4R	B6L	3212
4R5	BPR7HS-10	1092
5	B6S	3510
5A6	BP5ES	6511
5R6	BPR5ES	7422
5R6A	BPR5ES-11	4424
5RL	ZGR5C	6334
6R12	DCPR7EA-9	6651
8	BR10EIX	6801

HONDA	NGK → STOCK No.	
12290-PNE-0030	ZFR6K-11	6711
12290-PRB-A01	IFR7G-11KS	7746
12290-R1A-A01	DILZKR7B11GS	95710
12290-R1A-H01	SILZKR7C11S	92932
12290-R1A-H011	SILZKR7C11S	92932
12290-R1A-H011-M1	SILZKR7C11S	92932
12290-R41-L010-M1	DILZKR7B11GS	95710
12290-R71-L01	DILZKR7B11GS	95710
12290-RB0-J01	DIFR6D13	94167
12290-RB0-J010	DIFR6D13	94167
12290-RB0-J11	DIFR6D13	94167
12290-RB0-J110	DIFR6D13	94167
12290-RB0-J110-M1	DIFR6D13	94167
12290-RBJ-003	DILFR6J11	92491
12290-RB1-0031	IZFR6K13	6774
12290-RMX-003	ILFR6J-11K	4458
12290-RMX-013	ILFR6J-11K	4458
12290-RSH-003	IFR6G11K	1314
12290-RWO-003	DILFR6J11	92491
31908-MGC-003	LMA8A-9S	6817
31909-MEN-A310-M1	SILMAR9A9S	6213
31911-KRN-731	R0409B-8	7791
31911-MBW-E11	IMR8C-9H	3653
31911-MEE-J01	IMR8C-9HES	5990
31911-MKFA-D710-M1	SILMAR10C9S	-
31912-KRN-731	R0409B-9	7792
31912-MBW-E110	IMR9C-9H	6777
31912-MCW-0030	IMR9B-9H	4888
31912-MEL-003	IMR9C-9HES	5766
31912-MGH-641	IMR8E-9HES	95397
31915-Z0H-003	CMR5H	7599
31916-KRM-841	CPR8EA-9	2306
31916-KWB-601	CPR6EA-9S	1582
31916-MEH-003	SIMR8A9	91064
31916-Z0H-003	CMR6H	3365
31917-K40-F01	SILMAR8C9	90097
31918-K44-V01	MR8C-9N	97985
31918-MEB-671	IFR8H11	5068
31922-MGH-642	IMR8E-9HES	95397
31988-GEV-761	ER8EH-N	5606
94701-00408	CR9EIA-9	6289
98049-58716	ER8EH	4011
98049-59716	ER9EH	5869
98049-60716	ER10EH	2862
98052-56471	CM-6	5812
98056-17U	IFR6L11	3678
98056-55718	CR5HS	2874
98056-55777	CR5HSB	6535
98056-56713	C6HSA	3228
98056-56716	CR6HS	7023
98056-56718	CR6HSA	2983
98056-57713	C7HSA	4629
98056-57716	CR7HS	7223
98056-57718	CR7HSA	4549
98056-57918	CR7HSA-9	5147
98056-58713	C8HSA	6821
98056-58716	CR8HS	7423

HONDA	NGK → STOCK No.	
98056-58718	CR8HSA	2086
98059-55916	CR5EH-9	6689
98059-55918	CR7HSA	5147
98059-57916	CR7EH-9	3486
98056-57918	CR7HSA-9	5147
98059-58916	CR8EH-9	5666
98059-59916	CR9EH-9	7502
98059-5991U	IMR9A-9H	6966
98059-599U	CR9EH-9	6419
98061-58616	DPR8Z	4730
98061-59616	DPR9Z	4830
98066-54716	DR4HS	3326
98066-55716	DR5HS	4623
98066-56716	DR6HS	4823
98066-56717	D6HA	6512
98066-58716	DR8HS	5123
98066-58717	D8HA	7112
98069-38716	DR8ES-L	2923
98069-55916	DPR5EA-9	2887
98069-56717	D6EA	7512
98069-56916	DPR6EA-9	5531
98069-57716	DR7ES	3123
98069-57717	D7EA	7912
98069-5771P	DR7EA	7839
98069-57911	DPR7EA-9	5129
98069-57912	DPR7EIX-9	7803
98069-57912	DPR7EIX-9	7803
98069-57916	DPR7EA-9	5129
98069-5791U	IJR7A9	7901
98069-58716	DR8ES	5423
98069-58717	D8EA	2120
98069-58912	DPR8EIX-9	2202
98069-58916	DPR8EA-9	4929
98069-59717	D9EA	2420
98069-59912	DPR9EIX-9	5545
98069-59916	DPR9EA-9	5329
98069-5991F	DPR9EIX-9	5545
98073-52710	B2	3110
98073-54710	B4	3210
98073-54740	BM4A	5628
98073-54744	BMR4A	5728
98073-54776	BPMR4A	6028
98073-54944	BPMR4A-10	6328
98073-56740	BM6A	5921
98073-56741	BPM6A	7021
98073-56744	BMR6A	7421
98073-56944	BPMR6A-10	1029
98076-52711	BP2HS	7926
98076-54710	B4H	4110
98076-54711	BP4HS	3611
98076-54716	BR4HS	3322
98076-54717	BPR4HS	7823
98076-54746	BR4HS	3322
98076-54747	BPR4HS	7823
98076-54914	BPR4HS-10	5024
98076-54944	BPR4HS-10	5024
98076-55711	BP5HS	4111
98076-55716	BR5HS	3722
98076-55717	BPR5HS	6222
98076-55719	BP5HS	4111
98076-55747	BPR5HS	6222
98076-56711	B6HS	4510
98076-56715	BPR6HSA	4632
98076-56716	BR6HS	3922
98076-56717	BPR6HS	7022
98076-56719	BP6HS	4511
98076-5671G	BR6HSA	4296
98076-56741	B6HS	4510
98076-56747	BPR6HS	7022
98076-56917	BPR6HS-10	2623
98076-57710	B7HS	5110
98076-57711	BP7HS	5111
98076-57716	BR7HS	4122
98076-57717	BPR7HS	6422

HONDA	NGK → STOCK No.	
98076-57740	B7HS	5110
98076-58710	B8HS	5510
98076-58711	BP8HS	2630
98076-58716	BR8HS	4322
98076-58717	BPR8HS	3725
98076-5871G	BR8HSA	5539
98076-58740	B8HS	5510
98076-58747	BPR8HS	3725
98076-59710	B9HS	5810
98076-59716	BR9HS	4822
98079-5414G	ZFR4F-11	4043
98079-54817	BPR4ES	7222
98079-54846	BPR4ES	7222
98079-55145	BPR5ES-11	4424
98079-55146	BPR5EY-11	3028
98079-55147	BCPR5ES-11	3524
98079-55148	BCPR5E-11	1273
98079-5514E	BKR5E-11	6953
98079-5514H	PFR5G-11	2647
98079-5514P	ZFR5J-11	5584
98079-5515G	ZFR6F-11	4291
98079-5515U	IFR5L11	6502
98079-5517U	FR9BI-11	4709
98079-5517V	IFR5G-11K	3107
98079-55810	B5ES	6410
98079-55811	BP5ES	6511
98079-55816	BR5ES	4722
98079-55817	BPR5ES	7422
98079-55840	B5ES	6410
98079-55841	BP5ES	6511
98079-55844	BPR5EIX	6597
98079-55846	BPR5ES	7422
98079-55847	BR5ES	4722
98079-55941	BP5EY	7327
98079-55946	BPR5EY	2828
98079-56145	BPR6ES-11	4824
98079-56146	BPR6EY-11	4228
98079-56147	BCPR6ES-11	7121
98079-56148	BCPR6E-11	3132
98079-56149	BCPR6EY-11	3720
98079-5614E	BKR6E-11	2756
98079-5614G	ZFR6F-11	4291
98079-5614H	PFR6G-11	5555
98079-5614J	BKR6E-N-11	5724
98079-5614N	ZFR6F-11	3271
98079-5614P	ZFR6J-11	5585
98079-5615G	ZFR6F-11	4291
98079-5615N	PZFR6F-11	3271
98079-5617U	IFR6L11	3678
98079-56810	B6ES	7310
98079-56811	BP6ES	7811
98079-56817	BR6ES	4922
98079-56840	B6ES	7310
98079-56841	BP6ES	7811
98079-56844	BPR6EIX	6637
98079-56846	BPR6ES	7822
98079-56847	BR6ES	4922
98079-56941	BP6EY	7727
98079-56946	BPR6EY	6427
98079-57145	BKR7ES-11	7226
98079-5714E	BPRT7E-11	1283
98079-5714G	ZFR7F-11	2975
98079-5714H	PFR7G-11S	7772
98079-5715H	PFR7G-11S	7772
98079-571BV	IFR7G-11KS	7746
98079-57614	BR7EIX	6664
98079-57810	B7ES	1111
98079-57811	BP7ES	2412
98079-57816	BR7ES	5122
98079-57840	B7ES	1111
98079-57841	BP7ES	2412
98079-57846	BPR7ES	2023
98079-57847	BR7ES	5122
98079-57876	BR7ES	5122

HONDA	NGK → STOCK No.	HYSTER	NGK → STOCK No.	ISKRA	NGK → STOCK No.	ISUZU	NGK → STOCK No.				
98079-57877	BR7ES	5122	3001585	AB-6	2910	FS70	B6S	3510	9-82513105-0	B6ES	7310
98079-57946	BPR7EIX	4055	3001586	AB-6	2910	FS70C	BPM6A	7021	9-82513106-0	BP5ES	6511
98079-58644	BR8EIX	5044	3001588	BMR6A	7421	FS75	B7S	3710	9-82513107-0	B5ES	6410
98079-58646	BR8EIX	5044	3001590	AB-6	2910	FS75C	BPM7A	7321	9-82513113-0	B7ES	1111
98079-58648	B8EG	3430	3002287	AB-6	2910	FT65PS	BP6FS	3512			
98079-58649	BR8EG	3130	3002288	BP2ES	3467	FUT55PRP-13	PTR5A-10	5055			
98079-58678	B8EG	3430	3002289	BMR6A	7421	M60	AB6	2910	ITALJET	NGK → STOCK No.	
98079-58679	BR8EG	3130	3002290	BPR4ES	7222	M75	AB7	3010	94004	BR7HS	4122
98079-58810	B8ES	2411	3002347	BPR4ES	7222	M80	AB8	7909	94015	DR8EA	7162
98079-58816	BR8ES	5422	3002348	AB-6	2910	MT65PRS	APR6FS	2922	94025	BR8HS	4322
98079-58819	BR8ECS	3972	3002349	AB-6	2910	MT65PS	AP6FS	2710	94029	BR9ES	5722
98079-58840	B8ES	2411	3002575	AB-6	2910	SFE55LRS	ZFR5F	5165	94032	CR7E	4578
98079-58842	B8ECS	2821	3002577	AB-6	2910	SFE55LXS	ZFR5F	5165			
98079-58845	BR8ECM	3035	3040014	AB-6	2910	SFE55PRS	BCPR5ES	6130	JAGUAR	NGK → STOCK No.	
98079-58846	BR8ES	5422	3050408	AB-6	2910	SFE55PRS	BKR5E	7938	02AJ812988	SILZKAR7E8S	93476
98079-58847	BPR8ES	3923	3051151	AB-6	2910	SFE55PS	BCP5ES	7496	2W93 12405 CAA	IFR5N10	7866
98079-58870	B8ES	2411	3051322	AB-6	2910	SFE65LDRS	BKR5EK	7956	96JV12405 EAA	PPR5G-11E	3000
98079-58876	BR8ES	5422	3057352	BPR4ES	7222	SFE65LRS	ZFR6A-11	1041	96JV12405 FAA	BKR5EVXA-13	1188
98079-59644	BR9EIX	3981	326827	BP2ES	3467	SFE65LTXS	BKUR6ET	6437	96JV12405 HAA	PPR5G-13E	2761
98079-59646	BR9EIX	3981	360046	BMR6A	7421	SFE65LXS	ZFR6A-11	1041	96JV12405 HBA	PPR6G-13E	2341
98079-59648	B9EG	3530	388361	BPR5FS	2423	SFE65PDRS	BKR6EKC	2848	AB3850DA	BR6EF	3177
98079-59649	BR9EG	3230				SFE65PRS	BKR6E	6962	AJ812146	ILKAR7C10	94940
98079-59678	B9EG	3530	HYUNDAI	NGK → STOCK No.		SFE65PRS	BKR6ES	3783	AJ812988	SILZKAR7E8S	93476
98079-59679	BR9EG	3230	18 827 090 80	LKR6D-10E	96569	SFE65PS	BCP6ES	4930	AJ813092	ILTR6G8G	96621
98079-59810	B9ES	2611	18 843 100 62	LKR6D-10E	96569	SFE65PTRS	BCPR6ET	2197	AJ84575	IFR5N10	7866
98079-59811	B9ES	2611	18 846 100 60	SILZKR6B10E	93815	SFE65PTS	BCP6ET	4563	C2A1535	IFR5N10	7866
98079-59816	BR9ES	5722	18 854 100 80	LZKR6B-10E	1578	SFE85LDRS	BKR6EK	2288	C2P23089	ILKAR7C10	94940
98079-59819	BR9ECS	3570	18 855 100 60	LZKR6B-10E	1578	SFE85LTRS	BKUR7ET	7873	C2S46895	TR6AP-13E	4968
98079-59842	B9ECS	7058				SFE85PR5	BKR7E	6097	C2Z28434	SILZKAR7E8S	93476
98079-59845	BR9ECM	3252	ISKRA	NGK → STOCK No.		SFE85PRS	BCPR7ES	3330	CA 3850 DA2	BKR6EVXA-11	6838
98079-59847	BR9ES	5722	F100RS	BR8HS	4322	SFE85PS	BCP7ES	5030	CA 3850 DA2	PPR6G-13E	2341
98079-59870	B9ES	2611	F100S	B8HS	5510	SFE85PTRS	BCPR7ET	2164	CA 3850 FA1	BKR5EVXA-13	1188
98079-59876	BR9ES	5722	F20	B4H	4110	SFE85PTS	BCP7ET	2078	CA 3850 FA1	PPR5G-13E	2761
98079-60616	BR10EIX	6801	F50	B5HS	4210	T90	C7HSA	4629	CA 3850 HA2	PPR6G-13E	2341
98079-60646	BR10EIX	6801	F55PS	BP5HS	4111	TWE85PRS	DCPR8E	4179	EAC8344	B8ES	2411
98079-60648	B10EG	3630	F65PRS	BPR6HS	7022	TWE85PS	DCP7E	2363	EAC8554	BR7EFS	1094
98079-60649	BR10EG	3830	F65PS	BP6HS	4511				EBC4021	BR7EF	3346
98079-60676	BR10EIX	6801	F70	B5HS	4210	ISOLATOR	NGK → STOCK No.		EBC8523	B7ES	1111
98079-60678	B10EG	3630	F75RS	BR6HS	3922	6B	BP6HS	4511	JC2S 46895	TR6AP-13E	4968
98079-60679	BR10EG	3830	F75S	B6HS	4510	7A	B6HS	4510	NCA 3850 DA2	BKR6EVXA-11	6838
98079-60817	BR10ES	4832	F805RS	BR7HS	4122	7B	BP6HS	4511	NCA 3850 DA2	PPR6G-13E	2341
98079-60819	BR10ECS	5880	F80S	B7HS	5110	7D	BP6ES	7811	NCA 3850 FA1	BKR5EVXA-13	1188
98079-60845	BR10ECM	4234	F85PS	BP7HS	5111	A5D	BP7EFS	3526	NCA 3850 FA1	PPR5G-13E	2761
9807B-561BW	IZFR6K-11S	5266	F95PS	BP7HS	5111	A7D	BP6EFS	3812	NCA 3850 HA2	PPR6G-13E	2341
9807B-561CW	IZFR6K-11S	5266	FE100RS	BR9ES	5722	FM14-145/2	BP5ES	6511	XR819660	TR6AP-13E	4968
9807B-5615W	IZFR6K11	6994	FE100S	B9ES	2611	FM14-175/2	BP6ES	7811	XR842795	TR6AP-13E	4968
9807B-5617W	IZFR6K11	6994	FE145P	BP9ES	7526	FM14-200/2	BP6ES	7811			
98179-56841	BP6ES	7811	FE155P	BPR8EIX	6684	FM14-225/2	BP7ES	2412			
			FE45P	BP5E	4669	M14-145	B5HS	4210	JAPCAR	NGK → STOCK No.	
			FE50	B5ES	6410	M14-175	B6HS	4510	123762	BP5ES	6511
			FE55LRS	ZGR5A	5839	M14-175/2	B6ES	7310	123770	BP6ES	7811
			FE55LTXS	BUR5ET	3377	M14-225	B7HS	5110	123778	BPR5ES	7422
			FE55LXS	ZGR5A	5839	M14-225	B7HS	5110	123789	BPR6ES	7822
			FE55PRS	BPR5ES	7422	M14-240	B8HS	5510	123801	BPR7ES	2023
			FE55PS	BP5ES	6511	M14-260	B9HS	5810	123825	BPR5ES-11	4424
			FE55PTS	BP5ET	2287	M14-95	B4H	4110	123834	BPR6ES-11	4824
			FE65LTXS	BUR6ET	3172	M18-225	AB7	3010	123887	BPR5ES	7422
			FE65PP2	BPR6EIX	6637	M18-240	AB7	3010	123899	BPR6ES	7822
			FE65PRP2	BPR6ES	7822	PM14-225	BP7HS	5111	123908	BPR7ES	2023
			FE65PRS	BPR6ES	7822	U7D	BCP6ES	4930	123932	BPR5ES-11	4424
			FE65PS	BP6ES	7811	U8D	BCP5ES	7496	123940	BPR6ES-11	4824
			FE65PTS	BP6ET	1263	ZM14-260	B8HS	5510	123993	BPR7ES-11	7226
			FE75RS	BR7ES	5122				123996	BR7ES	5122
			FE75S	B7ES	1111	ISUZU	NGK → STOCK No.		124040	BPR7ES-11	7226
			FE80RS	BR8ES	5422	5-81380001-0	BPR5ES	7422	124144	BPR6ES-11	4824
			FE80S	B8ES	2411	5-81380003-0	BPR5EIX	6597	166573	BPR6ES	7822
			FE85PRS	BPR7ES	2023	5-81380004-0	BPR6EIX	6637	167605	PPR6J-11	2743
			FE85PS	BP7ES	2412	5-81380012-0	BP5EY	7327	170006	BPR6ES-11	4824
			FET55PRS	BPR5EFS	2223	5-81380013-0	BP6EY	7727	172988	BPR5ES	7422
			FET55PS	BP5EFS	3712	8-94120560-0	BPR5ES-11	4424	173939	BKR6E-11	2756
			FET65PRS	BPR6EFS	3623	8-94217232-0	BPR6ES-11	4824	177391	BKR6E-11	2756
			FET65PS	BP6EFS	3812	8-94219943-0	BPR6ES	7822	207417	PPR6J-11	2743
			FET75PS	BP7EFS	3526	8-94328373-0	BKR7E-11	1283	239214	PPR5J-11	4642
			FS50KR	BR2LM	5798	8-97012928-0	BKR6E	6962	277200	BKR5E-11	6953
						9-82513103-0	BP6ES	7811	277201	BKR5E-11	6953

JAPCAR	NGK → STOCK No.	
279427	PFR5J-11	4045
JEEP - See CHRYSLER GROUP		
JENN FENG NGK → STOCK No.		
9111-310002	BPMR6F	1270
9295-320001	BMR6F	2144
9295-310002	BPMR6F	1270
9295-310502	CMR7H	3066
9295-331501	BPMR7A	4626
JG - See CHINESE BRANDS		
JIGUANG - See CHINESE BRANDS		
JOHNSON NGK → STOCK No.		
204470091	BR7ES	5122
278000237	BR7ES	5122
278000608	BR7ES	5122
278000609	BR8ES	5422
MCBR10EG	BR10EG	3830
MCBR8EG	BR8EG	3130
MCBR8HS	BR8HS	4322
MCBR9EG	BR9EG	3230
MCBR9ES	BR9ES	5722
JONSERAD NGK → STOCK No.		
574 51 96-01	CMR6H	3365
JUNGHEINRICH NGK → STOCK No.		
14148410	BPR4FS	1127
K & N NGK → STOCK No.		
XP422	PFR6G-11	5555
KAWASAKI NGK → STOCK No.		
(E)92070-1063	BR9EG	3230
(E)92070-1064	BR8EG	3130
(E)92070-1165	DR7EA	7839
(E)92070-1173	BR10ES	4832
(E)92070-2077	BPR5ES	7422
92070-0010	R6918B-9	2954
92070-0016	BR9ECMIX	2707
92070-0045	MR8CI-8	96973
92070-0047	SILMAR9B9	95399
92070-1142	C9E	7499
92070-1146	D6EA	7512
92070-1231	BR8EIX	5044
92070-1241	R6252K-105	2741
92070-1264	CR9EK	4548
92070-1265	CR8EK	3478
92070-1266	CR9E	6263
92070-2052	BP4HS	3611
92070-2061	BPR4HS	7823
92070-2070	BR4HS	3322
92070-2108	BPMR6A	6726
92070-2110	BPR2ES	2264
92070-3707	PMR9B	4717
92070-7004	BPR4ES	7222
E92070-0001	B7HS	5110
E92070-014	B6ES	7310
E92070-036	B9HS	5810
E92070-037	B8ES	2411
E92070-054	B9ES	2611
E92070-1002	B7ES	1111
E92070-1014	BP8ES	2912
E92070-1019	DR8ES	5423
E92070-1022	BR8ES	5422
E92070-1024	BP6ES	7811
E92070-1025	BPR6ES	7822
E92070-1026	BP7ES	2412
E92070-1027	BPR7ES	2023
E92070-1034	D9EA	2420
E92070-1044	BPR8ES	3923

KAWASAKI	NGK → STOCK No.	
E92070-1053	BR9ES	5722
E92070-1057	B8EG	3430
E92070-1058	B9EG	3530
E92070-1065	DPR8EA-9	4929
E92070-1068	DPR9EA-9	5329
E92070-1109	BR9ES	5722
E92070-1113	DR7ES	3123
E92070-1114	C6HSA	3228
E92070-1116	DR8ES-L	2923
E92070-1125	DPR7EA-9	5129
E92070-1132	B10EG	3630
E92070-1133	BR10EG	3830
E92070-1138	DPR6EA-9	5531
E92070-1143	CR9E	6263
E92070-1145	CR9EK	4548
E92070-1154	CR7HSA	4549
E92070-1155	CR8HSA	2086
E92070-1158	CR8EK	3478
E92070-1169	CR8E	1275
E92070-1173	BR10ES	4832
E92070-1178	BP5ES	6511
E92070-1186	BR10EIX	6801
E92070-1189	DR9EA	3437
E92070-1199	DR8EA	7162
E92070-1209	CR7E	4578
E92070-1212	BR9EIX	3981
E92070-1215	BR8EIX	5044
E92070-1250	DPR5EA-9	2887
E92070-1254	CR9EKPA	7785
E92070-2072	BMR4A	5728
E92070-2100	BMR2A	7677
KIA NGK → STOCK No.		
18 843 100 62	LKR6D-10E	96569
18 846 100 60	SILZKR6B10E	93815
18 854 100 80	LZKR6B-10E	1578
18 855 100 60	LZKR6B-10E	1578
OK55818110	PFR6N-11	3546
KLK NGK → STOCK No.		
F100	B8HS	5510
F20	B4H	4110
F220	B9HS	5810
F50	B5HS	4210
F55P	BP5HS	4111
F65P	BP6HS	4511
F70	B5HS	4210
F75	B6HS	4510
F80	B7HS	5110
F85P	BP6HS	4511
F95P	BP7HS	5111
FA50	B4L	3112
FA70	B6L	3212
FE100	B8ES	2411
FE125P	BP6ES	7811
FE135P	BP7ES	2412
FE145P	BP8ES	2912
FE155P	BP8ES	2912
FE220	B9ES	2611
FE30	B4ES	4129
FE45P	BP5ES	6511
FE50	B5ES	6410
FE55P	BP5ES	6511
FE65P	BP6ES	7811
FE70	B5ES	6410
FE75	B6ES	7310
FE80	B7ES	1111
FE85P	BP6ES	7811
FE95P	BP7ES	2412
FS100	B8S	3810
FS20	B2	3110
FS30	B4	3210
FS35P	BP4	2911
FS45P	BP5S	3011

KLK	NGK → STOCK No.	
FS50	B6S	3510
FS70	B6S	3510
FS75	B7S	3710
FS75H	B7S	3710
FT55P	BP5FS	3412
FT65P	BP5FS	3412
FT85P	BP6FS	3512
FT95P	BP7FS	3612
GT4S	BP5S	3011
GT5	BP5HS	4111
GT5L	BP5ES	6511
GT6	BP6HS	4511
GT6L	BP6ES	7811
GT6T	AP6FS	2710
GT7	BP7HS	5111
GT7L	BP7ES	2412
GT8L	BP8ES	2912
M30	AB2	3020
M50	AB6	2910
M60	AB6	2910
M75	AB7	3010
M80	AB8	7909
MT75P	AP6FS	2710
MT85P	AP6FS	2710
T30	C6HSA	3228
T70	C7HSA	4629
T90	C8HSA	6821
TENL100	C8HSA	6821
TENL30	C7HSA	4629
TFS20	B2	3110
TFS30	B4	3210
TFS50	B6S	3510
TW100	D6HA	6512
TW220	D6HA	6512
TW240	D8HA	7112
TW270	D6HA	6512
TW275	D6HA	6512
TW280	D8HA	7112
TWE270	D8EA	2120
TWE275	D9EA	2420
KOHLER NGK → STOCK No.		
12 132 02	BCPR5ES	6130
12 132 02S	BCPR5ES	6130
14 132 11	DCPR7E	3932
14 132 11S	DCPR7E	3932
62 132 04S	BCPR6ES	2330
KOMATSU NGK → STOCK No.		
22401-58001	B6ES	7310
22401-FU412	BCPR5E-11	1273
22401-M7714	B6ES	7310
22401-M7716	B6ES	7310
22401-V1414	BPR4ES	7222
22401-W8914	BP2ES	3467
37Z-02-SP02E	BP2ES	3467
37Z-02-SP04A	B6ES	7310
37Z-02-SP05A	B6ES	7310
HE0052048-00	BMR6A	7421
HE0110256-00	BMR6A	7421
HE0110526-00	BMR6A	7421
HE40-2502314	BMR6A	7421
HE52892	BMR6A	7421
TJ-90098-09125	BP2ES	3467
TJ-90919-01055	BP2ES	3467
TJ-90919-01950-71	BP2ES	3467
KTM NGK → STOCK No.		
452390-93000	LR8B	6208
590390-93100	DCPR8E	4179
515390-93000	DR9ECMIX	2707
610390-93000	DCPR8E	4339
611390-93000	KRD8I	4742
612390-93200	LKAR9BI9	6205

KTM	NGK → STOCK No.	
750390-93000	LKAR8AI-9	6706
780390-93000	LKAR8A-9	4786
KUBOTA NGK → STOCK No.		
07909-2225-0	BM6A	5921
07909-2226-0	BM7A	6521
10202-6771-6	AB6	2910
10261-6771-6	G2Z	3320
12268-6771-1	BP2ES	3467
12366-6771-6	BR4HS	3322
12392-6771-1	BP5ES	6511
12647-6771-1	BPR6HS	7022
12681-6774-1	BR5ES	4722
12691-6771-1	BCP4ES-11	1086
12863-6771-1	BP5ES	6511
12866-6771-1	BP5ES	6511
12992-6771-1	BPR5ES	7422
13078-6771-6	BP6ES	7811
13157-6771-2	BM4A	5628
13211-6771-6	B4	3210
13281-6771-6	B4H	4110
13301-6771-6	AB2	3020
13373-6774-1	BMR4A	5728
13374-6774-1	BPR4HS	7823
13375-6774-0	BP5ES	6511
13375-6774-1	BPR4HS-10	5024
13401-6771-6	B6S	3510
13412-6771-6	B7S	3710
13451-6771-6	B6HS	4510
13581-6771-6	B7HS	5110
13582-6771-1	B6HS	4510
13641-6771-1	B4H	4110
13901-6771-6	BP6HS	4511
13979-6771-1	BP4HS	3611
LAND ROVER NGK → STOCK No.		
LR005253	IFR5N10	7866
LR005483	ILFR6B	6481
LR019484	ILKAR7C10	94940
LR021006	BKR6EQU	3199
LR025605	ILTR6G8G	96621
LR032080	ILKAR7C10	94940
RTC3812	BP6ES	7811
LD - See CHINESE BRANDS		
LEXUS - See TOYOTA		
LG - See CHINESE BRANDS		
LIXIN - See CHINESE BRANDS		
LODGE NGK → STOCK No.		
15HLNY	BP6ES	7811
2H	B7HS	5110
2H12	D8HA	7112
2HA	B6S	3510
2HL	B7ES	1111
2HL10	C7HSA	4629
2HLD	BCP6ES	4930
2HL-E	B7ES	1111
2HLN	B7ES	1111
2HLNY	BP7ES	2412
2HN	B7HS	5110
2HNY	BP7HS	5111
2H-TNY	AP7FS	2127
2HTY	BP6FS	3512
2HV	AB8	7909
2XL	BP6ES	7811
25HLD	BCP6ET	4563
25HLNY	BP7ES	2412
25XL	BP6ES	7811
3HAN	B8S	3810
3HLN	B8ES	2411

LODGE	NGK → STOCK No.	MARCHAL/VALEO	NGK → STOCK No.	MARCHAL/VALEO	NGK → STOCK No.	MARELLI	NGK → STOCK No.				
3HLNY	BP7ES	2412	21C	AB6	2910	HF34	B7ES	1111	CW6CE	BM6A	5921
3HN	B8HS	5510	21E	AB6	2910	HF34F	B8ES	2411	CW6CJ	B6S	3510
3HNY	BP8ES	2912	21L	AB6	2910	RR31HS	B10EG	3630	CW6L	B5ES	6410
4HLNY	BP8ES	2912	22L	AB2	3020	RR32HS	BR9EIX	3981	CW6LJ	B5ES	6410
5HLNY	BP8ES	2912	22LM	AB2	3020	RR33HSS	BR8EIX	5044	CW6LP	BP5ES	6511
B14	B4H	4110	34/5HS	BP6ES	7811	SCGT34/5H	BP6EFS	3812	CW6LR	BR5ES	4722
BAN	B4	3210	34C	B7S	3710	SCGT35H	BP6EFS	3812	CW6LS	B5ES	6410
BANY	BP5S	3011	34CM	B7S	3710	V36A	B5HS	4210	CW6LSZ	B5ES	6410
BBANY	BP4	2911	34HS	B7ES	1111	V6N SOLEX	B5HS	4210	CW6N	B6HS	4510
BBL	AB6	2910	34HSM	B7ES	1111				CW6NE	BM6A	5921
BBNY	BP4HS	3611	34S	B7HS	5110				CW6NJ	B6HS	4510
BLN	B4ES	4129	35	B6HS	4510	MARELLI	NGK → STOCK No.		CW6NP	BP6HS	4511
BLNY	BP5ES	6511	35/1	BP6HS	4511	7LCR	BKR6E	6962	CW6NPR	BPR6HS	7022
BLTY	BPR5EFS	2223	35/1B	BP6HS	4511	7LPR	BKR6E	6962	CW6NR	BR6HS	3922
BN	B4H	4110	35/1D	BP6HS	4511	8LCR	BCPR7ES	3330	CW75LP	BP6ES	7811
B-TY	BP5FS	3412	35/36D	B6HS	4510	8LDCR	PTR5A-10	5055	CW78L	B6ES	7310
BV	AB2	3020	35/36P	B6HS	4510	8LPR	BCPR7ES	3330	CW78LP	BP6ES	7811
CAN	B6S	3510	35/36R	B6HS	4510	AW56C	BM7A	6521	CW78LPR	BPR6ES	7822
CANB	BPM6A	7021	35B	B6HS	4510	AW5C	BM6A	5921	CW78LPS	BP6ES	7811
CANC	BM6A	5921	35C	B6S	3510	CM1N	AB2	3020	CW7C	B6S	3510
CB14	B5ES	6410	35CM	B6S	3510	CM2N	AB2	3020	CW7L	B6ES	7310
CL14	B5ES	6410	35HA	BP6ES	7811	CM3N	AB6	2910	CW7LCR	BKR6E	6962
CLN	B6ES	7310	35HS	B6ES	7310	CM4N	AB6	2910	CW7LJ	B6ES	7310
CLN14P	B5ES	6410	35M	B6HS	4510	CM5N	AB6	2910	CW7LP	BP6ES	7811
CLNH	B5ES	6410	35P	B6HS	4510	CM6N	AB7	3010	CW7LPH	BP6ES	7811
CLNY	BP5ES	6511	36	B5HS	4210	CU7N	C7HSA	4629	CW7LPR	BPR6ES	7822
CN	B5HS	4210	36B	B5HS	4210	CW101L	B85EGV	7498	CW7LR	BR6ES	4922
CNY	BP5HS	4111	36C	B4	3210	CW10L	B8EG	3430	CW7N	B6HS	4510
CSN	B4L	3112	36CM	B4	3210	CW112L	B9EG	3530	CW7NJ	B6HS	4510
CTY	BP5FS	3412	36D	B5HS	4210	CW11L	B9EG	3530	CW7NP	BP6HS	4511
CV	AB6	2910	36HS	B5ES	6410	CW12L	B9EG	3530	CW7NPR	BPR6HS	7022
H	B6HS	4510	36M	B5HS	4210	CW12NV	BUH	2422	CW7NR	BR6HS	3922
H12	D6HA	6512	36P	B5HS	4210	CW13L	B10EG	3630	CW89LP	BP7ES	2412
H18	AB7	3010	37S	B5HS	4210	CW14L	B10EG	3630	CW8CJ	B7S	3710
HA	B7S	3710	4N	B7HS	5110	CW225A	B6HS	4510	CW8L	B7ES	1111
HAN	B7S	3710	5H	B7ES	1111	CW250A	B7HS	5110	CW8LCR	BCPR7ES	3330
HAN/M	B7S	3710	5N	BP6HS	4511	CW25N	B4H	4110	CW8LJ	B7ES	1111
HB12	D6HA	6512	5N CYCLO	BP6HS	4511	CW260N	B7HS	5110	CW8LP	BP7ES	2412
HBAN	B6S	3510	64H	BP7ES	2412	CW2C	B2	3110	CW8LPR	BPR7ES	2023
HBL12	D8EA	2120	67HP	BR8EIX	5044	CW2CJ	B2	3110	CW8LPS	BP7ES	2412
HBLN	B5ES	6410	6H	BP7ES	2412	CW2L	B4ES	4129	CW8N	B7HS	5110
HBN	B5HS	4210	6N	BP5HS	4111	CW2N	B4H	4110	CW8NP	BP7HS	5111
HBSN	B6L	3212	70H	BP6ES	7811	CW3C	B4	3210	CW8NR	BR7HS	4122
HBTNY	AP6FS	2710	76H	BP5ES	6511	CW3CJ	B4	3210	CW9L	B8ES	2411
HBTY	BP5FS	3412	7H	BP6ES	7811	CW3CP	BP4	2911	CW9LJ	B8ES	2411
HBV	AB6	2910	84H	BP5ES	6511	CW3L	B4ES	4129	CW9LP	BP8ES	2912
HL	B6ES	7310	88N	B5HS	4210	CW3N	B4H	4110	CW9N	B8HS	5510
HL12	D9EA	2420	8H	BP6ES	7811	CW4A	B5ES	6410	CWC12NJ	B8HS	5510
HL14	B6ES	7310	9H	BP5ES	6511	CW4C	B4	3210	CWC67NJ	B6HS	4510
HL-E	B6ES	7310	C64H	BP6EFS	3812	CW4CJ	B4	3210	CWC6NJ	B6HS	4510
HLN	B6ES	7310	C68H	BP6EFS	3812	CW4CP	BP4	2911	CWC7NJ	B6HS	4510
HLNP	B6ES	7310	C7H	BP6EFS	3812	CW4L	B4ES	4129	CWC9NJ	B7HS	5110
HLNY	BP6ES	7811	F70H	BCP7ES	5030	CW4N	B4H	4110	CWF11L	BR8EIX	5044
HN	B6HS	4510	F74H	BCP6ES	4930	CW4NJ	B4H	4110	CWP10L	BR9EIX	3981
HNY	BP6HS	4511	F78H	BCP7ES	5030	CW55N	B5HS	4210	CWP10N	BR9HIX	5687
HT14	BP5FS	3412	GT34	BP7HS	5111	CW5C	B4	3210	CWP11L	BR10EIX	6801
HT18	AP6FS	2710	GT34/2H	BP6ES	7811	CW5CP	BP5S	3011	CWP8L	BR7EIX	6664
HTNY	AP6FS	2710	GT34/5	BP6HS	4511	CW5L	B5ES	6410	CWP8N	BR7HIX	7067
H-TY	BP6FS	3512	GT34/5D	BP6HS	4511	CW5LJ	B5ES	6410	CWP9L	BR8EIX	5044
HV	AB7	3010	GT34/5H	BP6ES	7811	CW5LP	BP5ES	6511	CWP9N	BR8HIX	7001
			GT34/5HA	BP6ES	7811	CW5LS	B5ES	6410	CX6N	D6HA	6512
			GT34/5HD	BP6ES	7811	CW5LSZ	B5ES	6410	CX8L	D8EA	2120
MARCHAL/VALEO	NGK → STOCK No.		GT34D	BP7HS	5111	CW5N	B5HS	4210	CX8N	D8HA	7112
17C	AB7	3010	GT34H	BP7ES	2412	CW5NJ	B5HS	4210	DW4CJR	BR6S	3522
19C	AB7	3010	GT34HD	BP6ES	7811	CW5NP	BP5HS	4111	F6NC	BP5HS	4111
19E	AB7	3010	GT34HHD	BP6ES	7811	CW5NR	BR5HS	3722	F6NCR	BPR5HS	6222
19L	AB7	3010	GT35	BP5HS	4111	CW5NS	B5HS	4210	F7LC	BP6ES	7811
2/13	AB8	7019	GT35D	BP5HS	4111	CW5NSZ	B5HS	4210	F7LCR	BPR6ES	7822
2/32	B8HS	5510	GT35H	BP5ES	6511	CW67L	B6ES	7310	F7NC	BP6HS	4511
2/32H	B8ES	2411	GT35HD	BP5ES	6511	CW67LP	BP6ES	7811	F7NCR	BPR6HS	7022
2/33	B8HS	5510	H32RG	B9EG	3530	CW67N	BP6HS	4511	F8LC	BP7ES	2412
2/33H	B7ES	1111	H33RG	B8EG	3430	CW67NJ	B6HS	4510	F8LCR	BPR7ES	2023
20C	AB6	2910	H34F	B8ES	2411	CW67NR	BR6HS	3922	FC6N	B5HS	4210
20E	AB6	2910	HA32/2	B8ES	2411	CW67P	BP5ES	6511	FC7N	B6HS	4510
20L	AB6	2910	HA32RS	B9EG	3530	CW6C	B6S	3510			

MARELLI	NGK → STOCK No.	
FC9L	BP8ES	2912
SW5C	BM6F	6221
T7LC	BP6EFS	3812
T7LCR	BPR6EFS	3623
T8LC	BP7EFS	3526
TM4NP	AP6FS	2710
TW4LP	BP5EFS	3712
TW5NP	BP5FS	3412
TW6NP	BP6FS	3512
TW78LP	BP6EFS	3812
TW78LPR	BPR6EFS	3623
TW78NPR	BPR6FS	2623
TW7LP	BP6EFS	3812
TW7LPR	BPR6EFS	3623
TW7NP	BP6FS	3512

MASERATI	NGK → STOCK No.	
239242	PMR8C-H	96361

MAZDA	NGK → STOCK No.	
0190 18 110	B6HS	4510
0259 18 110	BP6ES	7811
0370 18 110	BPR6EIX	6637
0371 18 110	BPR5EIX	6597
0376 18 110	BPR7EIX	4055
0419 18 110	B7ES	1111
0420 18 110	B8ES	2411
0512 18 110	B6ES	7310
0660 18 110	BP5ES	6511
0745 18 110	BP7ES	2412
1002 77 550	BP5EY	7327
1003 77 550	BP6EY	7727
1482 18 600A	BR8EQ	3328
1690 18 110	BPR6ES	7822
1UX5-18-110	HB6AIX-11P	5703
1UXQ-18-110	HB6BIX-11P	5705
3648 18 600	BR7ET	4121
3649 18 600	BR8ET	4221
4885 18 110	BPR2ES	2264
4894 18 110	BP2ES	3467
8182 18 600	BR7EQ	5128
8344 18 600	BR9ET	4528
8914 18 110	BPR5ES	7422
A501 18 110	BP6E	7529
AY02 18 110	DCP7E	2363
AZ08 18 110	BPR5E	7075
B601 18 110	BPR5ES-11	4424
B695 18 110	BCPR6E	1269
B6B3 18 110	BCPR5E-11	1273
BP01 18 110	BKR5E-11	6953
BP03 18 110	BKR6E-11	2756
BP05 18 110	BKR7E-11	1283
BP13 18 110	BKR5E-11	6953
BP47 18 110	BKR5E	7938
BP49 18 110	BKR6E	6962
BP51 18 110	BKR7E	6097
F201 18 110	ZFR6A-11	1041
F203 18 110	ZFR5A-11	5084
F210 18 110	BCPR5E	1145
F220 18 110	BCPR6E-11	3132
F285 18 110	ZFR6F-11	4291
F287 18 110	ZFR5F-11	2262
F289 18 110	ZFR7F-11	2975
FE79 18 110	BPR6ES-11	4824
JE03 18 110	BCPR7E	1272
KJ11 18 110	PZFR6F	7550
L303 18 110	TR5AI-13	90813
L3K9 18 110	ILTR6A-8G	3787
L3K9 18 110A	ILTR6A-8G	3787
L3Y2 18 110	ILTR5A-13G	3811
L3Y3 18 110	ILTR6A-8G	3787
L3YD 18 110	SILTR6A7G	95369
L813 18 110	ITR6F13	4477
L845 18 110	TR5AI-13	90813

MAZDA	NGK → STOCK No.	
N322 18 110	BR10ET	7480
N342 18 110	BUR9EQ	5483
N3A1 18 110	BUR9EQP	5255
N3A3 18 110	BUR8EQP	4582
N3Y4 18 110A	RE9B-T	2809
N3Z2 18 110A	RE7C-L	6700
N3Z4 18 110A	RE7C-L	6700
N3Z5 18 110	RE8C-L	5745
PE 5R 18 110	ILKAR7L11	94124
ZM0118110	IZFR5G	5887

MCC - See SMART

McCULLOCH	NGK → STOCK No.	
9111-310002-CH	BPMR6F	1270
SPO002	BPMR7A	4626

MEGA FIRE	NGK → STOCK No.	
SE8JC	BM6A	5921

MERCEDES BENZ	NGK → STOCK No.	
002 159 18 03	BP7ES	2412
002 159 22 03	BP5ES	6511
002 159 24 03	BP6ES	7811
002 159 27 03	BP7ES	2412
002 159 28 03	BP6ES	7811
002 159 29 03	BP5ES	6511
002 159 31 03	BP5ES	6511
002 159 41 03	BP6ES	7811
002 159 42 03	BP6ES	7811
002 159 48 03	BP5ES	6511
002 159 49 03	BP6EFS	3812
002 159 56 03	BP6EFS	3812
002 159 57 03	BP5EFS	3712
002 159 58 03	BP5EFS	3712
002 159 64 03	BP7EFS	3526
002 159 65 03	BP7EFS	3526
002 159 68 03	BP6EFS	3812
002 159 69 03	BP6EFS	3812
002 159 76 03	BP5EFS	3712
002 159 77 03	BCP5ES	7496
003 159 04 03	BP5EFS	3712
003 159 05 03	BP5EFS	3712
003 159 06 03	BP6EFS	3812
003 159 07 03	BP6EFS	3812
003 159 08 03	BP7EFS	3526
003 159 12 03	BP6ESZ	7639
003 159 13 03	BP6ESZ	7639
003 159 14 03	BP7ES	2412
003 159 16 03	BCP6ES	4930
003 159 30 03	BCP5ES	7496
003 159 31 03	BCP6ES	4930
003 159 33 03	BP7EFS	3526
003 159 34 03	BP6EFS	3812
003 159 35 03	BP6EFS	3812
003 159 36 03	BP5EFS	3712
003 159 37 03	BCP5ES	7496
003 159 40 03	BP5EFS	3712
003 159 41 03	BP5EFS	3712
003 159 42 03	BCP5ES	7496
003 159 45 03	BP6ESZ	7639
003 159 56 03	BP7ES	2412
003 159 57 03	BP6ESZ	7639
003 159 75 03	BKUR5ET	2789
003 159 78 03	BKUR6ET-10	2397
003 159 91 03	BKR5EKUP	2890
003 159 97 03	IFR6D10	5344
004 159 13 03	ILFR6A	3588
004 159 14 03	IFR6Q-G	5648
004 159 20 03	IFR6D10	5344
004 159 25 03	SILZKR7A-S	7718
004 159 30 03	BKR6EZB	4293
004 159 30 03 26	BKR6EZB	4293
004 159 36 03	BKR6EZB	4293

MERCEDES BENZ	NGK → STOCK No.	
004 159 39 03	ILZKAR7A10	6043
004 159 44 03	PLKR7B8E	94716
004 159 44 03 26	PLKR7B8E	94716
004 159 45 03	ILFR6A	3588
004 159 49 03	PLKR7A	4288
004 159 58 03	PLKR7B8E	94716
004 159 65 03	SILZKFR8D7S	95875
004 159 68 03	SILZKFR8D7S	95875
004 159 70 03	SILZKFR8D7S	95875
004 159 75 03	SILZKFR8D7S	95875
004 159 79 03	SILZKFR8E7S	90654
132 159 02 03	LKR7B-9	5847

MERCURUISER	NGK → STOCK No.	
33-104	BR7ES	5122
33-11458M	B6HS-10	1052
33-12127	BP6HS-10	6326
33-123	BR6ES	4922
33-12343	BP8HS-10	3823
33-12343B	BP8HS-10	3823
33-136862	BU8H	6431
33-136862B	BU8H	6431
33-14	BP5S	3011
33-14103550	BUZHW	2147
33-14103568	BUZ8H	7447
33-14103570	BUZHW-2	2173
33-14814548	BPZ8HS-10	3133
33-14814568	BPZ8HS-15	3180
33-17719547	BPR7HS-10	1092
33-18	BPR4FS-11	2527
33-18S	BPR4FS-11	2527
33-19424	BP8HS-15	6729
33-19796	BPR6HS-10	2623
33-306	B6HS	4510
33-312	BP6HS-10	6326
33-327	BPR6HS	7022
33-328	BP7HS	5111
33-33828C	BZ7HS-10	3579
33-400	BR6FS	4323
33-400S	BR6FS	4323
33-401	BP6EFS	3812
33-406	BPR6FS	2623
33-41263B	B7HS-10	2129
33-41263M	B7HS-10	2129
33-592	BR6S	3522
33-59571	BR6FS	4323
33-59571B	BR6FS	4323
33-63	BP5S	3011
33-670	R5673-8	4140
33-803507	DCPR6E	3481
33-807C	B8HS	5510
33-807S	B8HS	5510
33-809679	BR9ES	5722
33-809679B	BR9ES	5722
33-809680	BR8ES	5422
33-809680B	BR8ES	5422
33-811	B7HS	5110
33-811S	B7HS	5110
33-813413	B7S	3710
33-8134141	BP7HS	5111
33-813415	B8S	3810
33-813421	R5673-8	4140
33-813423	BPR6HS	7022
33-813469	B6S	3510
33-8134711	BR6ES	4922
33-814	BPR7HS-10	1092
33-816336	BPR6EFS	3623
33-8167372	BP8H-N-10	4838
33-8167372B	BP8H-N-10	4838
33-8168372	BPZ8H-N-10	4495
33-8168372B	BPZ8H-N-10	4495
33-818	BR9ES	5722
33-818S	BR9ES	5722
33-821916	BR7HS	4122

MERCURUISER	NGK → STOCK No.	
33-821C	B9HS-10	3626
33-821S	B9HS-10	3626
33-823	B6S	3510
33-82370M	B6HS	4510
33-82370M1	B6HS	4510
33-82371B	B7HS	5110
33-82371M	B7HS	5110
33-82372M	B8HS	5510
33-823S	B6S	3510
33-824	BUHX	2522
33-825C	B7S	3710
33-825S	B7S	3710
33-827858	DPR6EA-9	5531
33-827859	CR6HS	7023
33-827C	BUHW	2622
33-828C	BZ7HS-10	3579
33-828S	BZ7HS-10	3579
33-833C	BUHW-2	5626
33-833S	BUHW-2	5626
33-838	BUZHW-2	2173
33-841C	B6S	3510
33-84409B	B8HS-10	5126
33-84409M	B8HS-10	5126
33-84675M	B5HS	4210
33-8556721	PZFR5F-11	4363
33-8557171	ZFR5F-11	2262
33-859495	LFRA5A-11	6376
33-874	BR7HS	4122
33-876	BUZ8H	7447
33-880	BR8ES	5422
33-881284	LFRA6A-11	3672
33-883	BR7HS	4122
33-885C	BU8H	6431
33-885S	BU8H	6431
33-886	BUZ8H	7447
33-896	B5HS	4210
33-898	BUZHW	2147
33-918	ZFR6F-11	4291
33-924	BP8HS-15	6729
33-936C	BP8HS-10	3823
33-936S	BP8HS-10	3823
33-938	BPZ8HS-10	3133
33-938	BPZ8HS-10	3133
33-939	BPZ8HS-15	3180
33-941	BR8HS	4322
33-97180	BUHW	2622
33-97180B	BUHW	2622
33-97182	BUHW-2	5626
33-97182B	BUHW-2	5626
33-97184	BP7HS-10	7829
33-97186	B9HS-10	3626
33-97186B	B9HS-10	3626
33-97389	BPR6FS	2623

MINI (BMW)	NGK → STOCK No.	
12 12 0 030 548	BKR6EQUP	3199
12 12 0 031 708	BKR7EQUP	4285
12 12 0 034 098	PLZKBR7B8DG	90223
12 12 0 035 531	ILZKBR7B8DG	95770
12 12 2 158 165	PLZKBR7B8DG	90223

MITSUBISHI	NGK → STOCK No.	
1017268	BPR4ES	7222
1038083	BP5EY	7327
1822A005	ILZFR6C-K	6645
1822A021	ILKR8E6	1422
1822A022	ILFR7H	5245
1822A079	DILKR8B6	91448
1822A085	DILFR5A11	93759
2A3643	AB-6	2910
8N2236	BMR6A	7421
8N2630	AB-6	2910
90420-01620	PTR5D-10	3784
997476	BMR6A	7421

MITSUBISHI	NGK → STOCK No.	
MB 101 726 8	BPR4ES	7222
MD 313 443	PFR6G-11	5555
MD 314 766	BKR7EKC-N	2095
MD 338 991	PGR7A	3200
MD 360 019	IZFR6B	3116
MD 360 383	IZFR5B	4080
MD 371 434	IGR7A	6687
MD 372 588	IFR6E11	6741
MD 374 841	IGR7A-G	3106
MD 997476	BMR6A	7421
MN 119 487	IFR6S	99404
MN 119 500	IGR6A11	5743
MN 137 919	LFR6C-11	5788
MN 158 596	LZFR6AI	3656
MN 163 235	FR5E1	1313
MN 176 628	ILZFR6C-K	6645
MS 851 022	BP5ES	6511
MS 851 023	BP6ES	7811
MS 851 024	BP7ES	2412
MS 851 101	BP5EY	7327
MS 851 102	BP5EY	7327
MS 851 104	BP6EY	7727
MS 851 111	B4	3210
MS 851 113	B6S	3510
MS 851 121	BP4	2911
MS 851 126	BPR6E	6464
MS 851 132	B5HS	4210
MS 851 133	B6HS	4510
MS 851 134	B7HS	5110
MS 851 162	B5ES	6410
MS 851 163	B6ES	7310
MS 851 164	B7ES	1111
MS 851 165	B8ES	2411
MS 851 174	BR7ES	5122
MS 851 182	BP5ES	6511
MS 851 183	BP6ES	7811
MS 851 184	BP7ES	2412
MS 851 192	BP6ES	7811
MS 851 232	BPR5ES	7422
MS 851 233	BPR6ES	7822
MS 851 234	BPR7ES	2023
MS 851 235	BPR5ES	7422
MS 851 236	BPR6ES	7822
MS 851 237	BPR5ES-11	4424
MS 851 238	BPR6ES-11	4824
MS 851 239	BPR7ES-11	7226
MS 851 243	BP5EY	7327
MS 851 263	G2Z	3320
MS 851 283	BP6E	7529
MS 851 286	BP5EY	7327
MS 851 287	BP6EY	7727
MS 851 301	PGR5A-11	3573
MS 851 317	DCPR7E	3932
MS 851 327	DCPR7EIX	6046
MS 851 332	PFR6B-11	4014
MS 851 335	PFR5J-11	4642
MS 851 336	PFR6J-11	2743
MS 851 347	PFR7M	4877
MS 851 352	BK6E	3536
MS 851 357	BKR5E-11	6953
MS 851 358	BKR6E-11	2756
MS 851 367	BKR5E	7938
MS 851 368	BKR6E	6962
MS 851 403	BPR6ES-11	4824
MS 851 408	BPR6ES-11	4824
MS 851 412	BPR5ES	7422
MS 851 413	BPR6ES	7822
MS 851 414	BPR7ES	2023
MS 851 417	BPR5ES-11	4424
MS 851 418	BPR6ES-11	4824
MS 851 419	BPR7ES-11	7226
MS 851 454	BR7ES	5122
MS 851 473	PFR6B-11	4014
MS 851 473	PFR6J-11	2743

MITSUBISHI	NGK → STOCK No.	
MS 851 478	BPR6ES-11	4824
MS 851 502	PFR6J-11	2743
MS 851 722	BK6E	3536
MS 851 727	BKR5E-11	6953
MS 851 728	BKR6E-11	2756
MS 851 737	BKR5E	7938
MS 851 738	BKR6E	6962
MS 851 882	BPR7EKN	7738
MZ 602 100	HB6AIX-11P	5703
MZ 602 101	HB6BIX-11P	5705
Z 2152 944	BPR6ES-11	4824
Z 2152 945	BPR6ES	7822
Z 2152 946	BR7ES	5122
Z 2152 947	BPR7ES	2023
Z 2152 948	BPR7ES-11	7226
Z 2152 949	BCPR7ES-11	1095
Z 2152 950	BCPR6ES-11	7121

MONTESA	NGK → STOCK No.	
98059-56916-00	CR6EH-9	2688

MOPAR - See CHRYSLER GROUP

MOTO-GUZZI	NGK → STOCK No.	
887016	LMAR8F-9	90894

MOTORCRAFT	NGK → STOCK No.	
A11	B2	3110
A11NX	BM4A	5628
A11U	B2	3110
A11X	B2	3110
A1CU	B8S	3810
A21X	B8S	3810
A22NX	BPM7A	7321
A2NX	BM7A	6521
A3CU	B6S	3510
A3NX	BM6A	5921
A3X	B6S	3510
A42	BP5S	3011
A42CU	BP5S	3011
A5	B6S	3510
A5CU	B6S	3510
A5X	B6S	3510
A52	BP5S	3011
A52CU	BP5S	3011
A7	B4	3210
A7LM	B4LM	3410
A7N	BM6A	5921
A7NU	BM6A	5921
A7NX	BM6A	5921
A7U	B4	3210
A7X	B4	3210
A82	BP4	2911
A9	B4	3210
A901	B8S	3810
A9X	B4	3210
AE1C	B7HS	5110
AE1X	B7HS	5110
AE2	B7HS	5110
AE2C	B7HS	5110
AE2X	B7HS	5110
AE22	BP6HS	4511
AE22C	BP6HS	4511
AE3	B6HS	4510
AE3X	B6HS	4510
AE32	BP6HS	4511
AE32C	BP6HS	4511
AE3C	B6HS	4510
AE4	B5HS	4210
AE4X	B5HS	4210
AE42	BP5HS	4111
AE6	B5HS	4210
AE62	BP5HS	4111
AE7	B4H	4110

MOTORCRAFT	NGK → STOCK No.	
AE901	B9HS	5810
AE901X	B9HS-10	3626
AER32	BPR6HS	7022
AER4	BR5HS	3722
AER4X	BR5HS	3722
AF12	BP7FS	3612
A-2	B7FS	3027
AF22	BP6FS	3512
AF32	BP6FS	3512
AF3NX	BM7F	6421
AF42	BP5FS	3412
AF5NX	BM6F	6221
AG1	B8ES	2411
AG1C	B8ES	2411
AG1X	B8ES	2411
AG12	BP7ES	2412
AG12C	BP7ES	2412
AG12CU	BP7ES	2412
AG2	B7ES	1111
AG2C	B7ES	1111
AG2CU	B7ES	1111
AG2X	B7ES	1111
AG203	B11EGP	2191
AG22	BP6ES	7811
AG22C	BP6ES	7811
AG22CU	BP6ES	7811
AG23	B7ECS	2528
AG252	BP6ES	7811
AG252C	BP6ES	7811
AG3	B6ES	7310
AG3C	B6ES	7310
AG3X	B6ES	7310
AG32A	BP6ES	7811
AG32C	BP6ES	7811
AG32CU	BP6ES	7811
AG4	B5ES	6410
AG403	B10EGP	5224
AG403C	B10EGP	5224
AG42	BP5ES	6511
AG42CU	BP5ES	6511
AG44	ZGR5C	6334
AG44CU	BP5EY	7327
AG5	B5ES	6410
AG501X	BR10EIX	6801
AG52	BP5ES	6511
AG54	ZGR5C	6334
AG5CU	B5ES	6410
AG7	B5ES	6410
AG701	B9ES	2611
AG701C	B9ES	2611
AG701CU	B9ES	2611
AG701X	BR9EIX	3981
AG9	B4ES	4129
AG9U	B4ES	4129
AG901	B9ES	2611
AG901C	B9ES	2611
AG901CU	B9ES	2611
AG901X	BR8EIX	5044
AG902	BP8ES	2912
AG903	B8EG	3430
AGF12	BP7EFS	3526
AGF12C	BP7EFS	3526
AGF22C	BP6EFS	3812
AGF32CU	BP6EFS	3812
AGFS22C1	BPR5EFS	2223
AGFS22CM1	BPR5EFS	2223
AGFS22F13J	TR6AP-13	5809
AGFS22FE13J	PTR6F-13	7569
AGFS22IPJ	ITR6F13	4477
AGKO	BUE	2322
AGN42	BP5ES	6511
AGP12C	BCP7ES	5030
AGP22C	BCP6ES	4930
AGP701C	R7435-10	4897

MOTORCRAFT	NGK → STOCK No.	
AGPR12C	BCPR7ES	3330
AGPR12PP8	PFR7B	4853
AGPR22C	BKR6E	6962
AGPR22C1	BCPR6ES-11	7121
AGPR22CD	BKR6E	6962
AGPR22CD1	BCPR6ES-11	7121
AGPR22PP	PFR6B-11	4014
AGPR22PPJ	PFR6B-11	4014
AGPR32C	BKR6E	6962
AGPR32CD1	BCPR6ES-11	7121
AGPR32PD	BKR5EKUP	2890
AGPR902P	R7436-9	4899
AGPS22C	BCPR6ES	2330
AGPS22P1	BKR6EIX	6418
AGPS22PP1	PFR6B	3500
AGPS32C	BCPR5ES	6130
AGPS44F	PZFR5D-11	7968
AGPS44F11J	PZFR5D-11	7968
AGR1X	BR8ES	5422
AGR12C	BPR7ES	2023
AGR16C	BR8ET	4221
AGR2C	BR7ES	5122
AGR21	BR6ES	4922
AGR22	BPR6ES	7822
AGR22C	BPR6ES	7822
AGR22CU	BPR6ES	7822
AGR3X	BR6ES	4922
AGR31	BR6ES	4922
AGR32	BPR6ES	7822
AGR32C	BPR6ES	7822
AGR32CU	BPR6ES	7822
AGR34CU	BPR6EY	6427
AGR41	BR5ES	4722
AGR42	BPR5ES	7422
AGR42C	BPR5ES	7422
AGR42CU	BPR5ES	7422
AGR44CU	BPR5EY	2828
AGR44CU-11	BPR5EY-11	3028
AGR51	BR5ES	4722
AGR52	BPR5ES	7422
AGR701X	BR9EIX	3981
AGR82	BPR4ES	7222
AGR901X	BR8EIX	5044
AGRF22	BPR6EFS	3623
AGRF22C	BPR6EFS	3623
AGRF22C1	BPR6EFS	3623
AGRF22PP1	PTR5D-10	3784
AGRF32	BPR6EFS	3623
AGRF32C1	BPR6EFS	3623
AGRF42	BPR5EFS	2223
AGRF52	BPR5EFS	2223
AGRP52	ZFR4F-11	4043
AGS22C	BPR6ES	7822
AGS32C	BPR5ES	7422
AGS32C-11	BPR5ES-11	4424
AGSF22PPJ	PTR6F-13	7569
AGSF32C	BPR5EFS	2223
AGSF32FM	PTR5D-13	6644
AGSP32	BCPR6ES-11	7121
AGSP32C	BCPR6ES-11	7121
AGSP33C	ZFR6F-11	4291
AGSP52	BKR5E	7938
AL11	B4L	3112
AL5	B6L	3212
AL5X	B6L	3212
AL7	B6L	3212
AL7U	B6L	3212
AL7X	B6L	3212
AL9	B4L	3112
AL9X	B4L	3112
AR21X	BR6S	3522
AR31	BR6S	3522
AR41	BR6S	3522
AR42	BP5S	3011

MOTORCRAFT	NGK → STOCK No.
AR51	BR6S 3522
AR52	BP5S 3011
AR7N	BMR6A 7421
AR82	BP4 2911
ARF2	BR6FS 4323
ARF22	BPR6FS 2623
ARF22C	BPR6FS 2623
ARF22CU	BPR6FS 2623
ARF3	BR6FS 4323
ARF32	BPR6FS 2623
ARF32-6	BPR6FS 2623
ARF32C-6	BPR6FS 2623
ARF32M	BPR6FS 2623
ARF4	BR5FS 4123
ARF42	BPR5FS 2423
ARF42-6	BPR5FS-15 3124
ARF42CU	BPR5FS 2423
ARF52	BPR4FS 1127
ARF52-6	BPR4FS-15 2727
ARF6	BR5FS 4123
ARF62	BPR4FS 1127
ARF62-6	BPR4FS-15 2727
ARF8	BR5FS 4123
ASF32	BPR6FS 2623
ASF32C	BPR6FS 2623
ASF32M	BPR6FS 2623
ASF42	BPR5FS-11 2924
ASF42-6C	BPR5FS-15 3124
ASF42C	BPR5FS-11 2924
ASF52	BPR4FS 1127
ASF52-6	BPR4FS-15 2727
ASF52C	BPR5FS 2423
AT1	B8S 3810
AT10	B2 3110
AT2	B7S 3710
AT3	B6S 3510
AT4	B6S 3510
AT42	BP5S 3011
AT6	B6S 3510
AT8	B4 3210
ATL3	B6L 3212
ATL4	B6L 3212
ATL8	B4L 3112
AV1X	B8HS 5510
AV22CU	BP6HS 4511
AV2CU	B7HS 5110
AV2X	B7HS 5110
AV3CU	B6HS 4510
AV4	B5HS 4210
AV42	BP5HS 4111
AV52	BP5HS 4111
AV6	B4H 4110
AV6CU	B4H 4110
AV701CU10	B9HS-10 3626
AV82	BP4HS 3611
AV901CU	B9HS 5810
AV901X-4	B9HS-10 3626
AVKO	BUH 2422
AVKOD	BUHW 2622
AVZKO	BUHX 2522
AWRF32	BPR6EFS 3623
AWRF42	BPR5EFS 2223
AWSF22C	BPR6EFS 3623
AWSF22FS	PTR6D-13 5598
AWSF32	BPR6EFS 3623
AWSF32C	BPR6EFS 3623
AWSF32F	PTR5D-10 3784
AWSF32P	PTR5D-10 3784
AWSF32PP	PTR5D-10 3784
AWSF42	BPR5EFS 2223
AWSF42C	BPR5EFS 2223
AWSF52C	BPR5EFS 2223
AWSFA32C	BPR5EFS 2223
AYFS092FEC	PLTR6A-10G 3587

MOTORCRAFT	NGK → STOCK No.
AYFS22C	TR5A-10 0005
AYFS22CB	TR5B-13 4559
AYFS22FE1J	PLTR6A-10G 3587
AYFS22P1	PTR5A-10 5055
AYFS22PP1	PTR5A-10 5055
AYFS32CJ	TR5B-13 4559
AYRF22PP	PTR5A-10 5055
AYSF32YPC	ILTR5A-13G 3811
AZZ	B7S 3710
AZ3	B6S 3510
AZ9	B4 3210
AZ901	B8S 3810
AZFS22PP	PTR5A-10 5055
AZFS32FE	PTR5A-10 5055
B2W	AB8 7909
B3W	AB7 3010
B3X	AB7 3010
B4X	AB7 3010
B6W	AB6 2910
B8X	AB6 2910
BF12	AP8FS 2227
BF22	AP6FS 2710
BF22C	AP6FS 2710
BF22CU	AP6FS 2710
BF22CX	AP6FS 2710
BF22X	AP6FS 2710
BF32	AP6FS 2710
BF32CU	AP6FS 2710
BF32CX	AP6FS 2710
BF32X	AP6FS 2710
BR8	AB6 2910
BRF22	APR6FS 2922
BRF22C	APR6FS 2922
BRF32	APR6FS 2922
BRF42	APR5FS 3122
BRF82	APR5FS 3122
BSF32C	APR6FS 2922
BSF42C	APR5FS 3122
BSF82	APR5FS 3122
BSF92	APR5FS 3122
BT10	AB6 2910
BT15	AB2 3020
BT2	AB8 7909
BT3	AB7 3010
BT4	AB7 3010
BT6	AB6 2910
BT8	AB6 2910
BT9	AB6 2910
BTRF42	APR5FS 3122
BZ8	AB6 2910
CYFS12YPC	ILTR6G8G 96621
CYFS13YRC	ILZTR6A8G 94769
HG2	D8EA 2120
HG22	D8EA 2120
HG2CU	D8EA 2120
HGR2C	DR8ES-L 2923
HV2	D8HA 7112
HV22	D6HA 6512
HV3	D6HA 6512
PV2	C7HSA 4629
PV3	C6HSA 3228
TT4	G2Z 3320
TT8	G2Z 3320
YN2F-12405A2A	TR5B-13 4559

MV AGUSTA	NGK → STOCK No.
7699116	CR9EKB 2305
8000 99561	CR9EKB 2305
8000 B 7884	CR9EIB-9 92579

NANDA - See CHINESE BRANDS

NGK	NGK → STOCK No.
1010	AB-6 2910

NGK	NGK → STOCK No.
1093	Obsolete -
1110	AB-7 3010
1144	BPR7EIX 4055
1179	DCPR7EIX 6046
1188	PFR5G-13E 2761
1210	AB-8 7909
2042	BR6EF 3177
2077	Obsolete -
2145	BR10EIX 6801
2176	Obsolete -
2210	Obsolete -
2254	BR9HIX 5687
2393	BPR6HS 7022
2434	BR9ECMIX 2707
2457	BR10ECMIX 3006
2634	BR8HIX 7001
2671	BPR8EIX 6684
2834	DR9EIX 4772
2850	DR8EIX 6681
2940	BR10HIX 6692
2989	AP6FS 2710
3344	TR7IX 3690
3436	GR4IX 7149
3539	BKR6EIX 6418
3544	BKR7EIX 2667
4383	Obsolete -
4768	FR2B-D 1598
4795	DCPR7E-N-10 4983
4875	BPR5EIX 6597
4880	IZFR6B 3116
5470	BPR5EIX 6597
5567	BR8ECMIX 3520
5576	BPR9EIX 6853
5627	BR8EIX 5044
5664	BCPR5EIX 5688
5756	IKR9J8 93311
5827	BR9EIX 3981
5832	BPR6EIX 6637
5843	PLZKBR7B8DG 90223
5927	BR10EIX 6801
5992	ILZKBR7B8DG 95770
6044	TR5AI-13 90813
6111	BP5EY 7327
6223	BPR5EY-11 3028
6323	BCPR6EIX 5689
6361	DR9EIX 4772
6436	DCPR9EIX 2316
6764	BPR6EIX 6637
6838	PFR6G-13E 2341
6891	BPR6EFIX-10 94658
6921	Obsolete -
6934	BR7EIX 2667
7051	BR8EIX 5044
7236	CR8HIX 7669
7254	BR9EIX 3981
7270	BPR7EIX 4055
7335	BR10EIX 6801
7681	BCPR7EIX 5690
7682	DPR7EIX-9 7803
7836	BR7HIX 7067
94786	ILKR9G8 97168
95843	ILKAR7C10 94940
A-6	AB-6 2910
A6FS	Obsolete -
A-7	AB-7 3010
A-8	AB-8 7909
AP6F-VG	AP6FS 2710
B105EGP	Obsolete -
B10EGV	BR10EIX 6801
B10EVX	BR10EIX 6801
B10HVX	BR10HIX 6692
B6EFS	BR6EF 3177
B7EVX	BR7EIX 2667
B7HVX	BR7HIX 7067

NGK	NGK → STOCK No.
B8EGV	BR8EIX 5044
B8EVX	BR8EIX 5044
B8HVX	BR8HIX 7001
B9EGP	Obsolete -
B9EGV	BR9EIX 3981
B9EVX	BR9EIX 3981
B9HVX	BR9HIX 5687
B95EGV	BR10EIX 6801
BCP5EVX	BCPR5EIX 5688
BCP6EVX	BCPR6EIX 5689
BCP7EVX	BCPR7EIX 5690
BKR5EVXA-13	PFR5G-13E 2761
BKR6EVX	BKR6EIX 6418
BKR6EVXA-11	PFR6G-13E 2341
BKR7EVX	BKR7EIX 2667
BL6H	Obsolete -
BP5EA-L	BP5EY 7327
BP5EVX	BPR5EIX 6597
BP6EVX	BPR6EIX 6637
BP7EVX	TR7IX 3690
BP8EVX	BPR8EIX 6684
BPR4EVX	GR4IX 7149
BPR5EA-L-11	BPR5EY-11 3028
BPR5EVX	BPR5EIX 6597
BPR6EFIX-10	BPR6EFIX-10 94658
BPR6EVX	BPR6EIX 6637
BPR6H-VG4	BPR6HS 7022
BPR7EY	BPR7EIX 4055
BPR9EVX	BPR9EIX 6853
BPZ7HS-10	Obsolete -
BR10ECMVX	BR10ECMIX 3006
BR8ECMVX	BR8ECMIX 3520
BR9ECMVX	BR9ECMIX 2707
CR8HVX	CR8HIX 7669
D8EVX	DR8EIX 6681
D9EVX	DR9EIX 4772
DCPR7E-N	DCPR7E-N-10 4983
DCPR7EVX	DCPR7EIX 6046
DCPR9EVX	DCPR9EIX 2316
DIMR8B10	DIMR8A10 5066
DPR7EVX-9	DPR7EIX-9 7803
DR9EVX	DR9EIX 4772
FR2A-D	FR2B-D 4768
IKR9F8	IKR9J8 93311
ILKAR6C10	ILKAR7C10 94940
ILZKBR7A-8G	ILZKBR7B8DG 95770
ITR5F13	TR5AI-13 90813
LKR9CI-8	ILKR9G8 97168
ME-8	Obsolete -
PLZKBR7A-G	PLZKBR7B8DG 90223

NHSP LD - See CHINESE BRANDS

NIPPON DENSO - See DENSO

NISSAN	NGK → STOCK No.
-01P15	BCPR5E5-11 3524
-01P16	BCPR6E5-11 7121
-01P17	BCPR7E5-11 1095
-02P15	BCPR5E-11 1273
-02P16	BCPR6E-11 3132
-10F15	BCP5E5 7496
-10F16	BCP6E5 4930
-10F17	BCP7E5 5030
-12E15	BCPR5E5 6130
-12E16	BKR6E 6962
-12E17	BCPR7E5 3330
-1P115	PFR5G-11 2647
-1P116	PFR6G-11 5555
-1P117	PFR7G-11S 7772
-20J05	BKR5E 7938
-20J06	BKR6E 6962
-20J07	BKR7E 6097

NISSAN	NGK → STOCK No.
22401-1HC1B	LZKAR6AP-11 6643
22401-1KC1C	DILKAR7C9H 91215
22401-1KT1B	DILZKAR6A11 91691
22401-2047R	ILKAR7F7G 90061
22401-5M015	PLFR5A-11 6240
22401-9133R	ILKAR7J7G 91121
22401-BC01B	LFR5E-11 1669
22401-CK81B	PLZKAR6A-11 5118
22401-CK87B	PLZKAR6A-11 5118
22401-EW61C	DF7H-11B 1317
22401-FU412	FR2B-D 1598
22401-FU42A	FR2B-D 1598
22401-JA01B	DILKAR6A11 9029
22401-JF01D	DILKAR8A8 93026
22401-JK01D	DF8H-11B 1305
22401-L1600	BPR4ES 7222
22401-M7716	B6ES 7310
22401-RS345-8	R7345-8 4379
22401-V1414	BPR4ES 7222
22401-W8914	BPR4ES 7222
BY483-HB6AX	HB6AIX-11P 5703
BY483-HB6BX	HB6BIX-11P 5705
CK913628	AB-6 2910
N-22401-M7716	B6ES 7310
NF90420-01620	PTR5D-10 3784
-30R15	ZFR5E-11 4435
-50Y05	BKR5E-11 6953
-50Y06	BKR6E-11 2756
-53J05	BKR5EY 7390
-53J06	BKR6EY 3696
-53J16	PFR6G-9 4377
-53J66	PFR6G-9 4377
-58S16	PFR6A-11 4045
-85E15	BKR5E-11 6953
-85E16	BKR6E-11 2756
-85E17	BKR7E-11 1283
-99B07	BCPR7ES-11 1095
-99B09	BCPR6ES-11 7121
-99B12	BCPR5ES-11 3524
-F2000	BPR4ES 7222
-P8315	BPR5ES-11 4424
-P8316	BPR6ES-11 4824
-P8317	BPR7ES-11 7226
-S2000	BPR5ES 7422
-S2100	BPR6ES 7822
-V1414	BPR4ES 7222
-V1415	BPR5ES 7422
-V1416	BPR6ES 7822
-V1417	BPR7ES 2023
-W8915	BP5ES 6511
-W8916	BP6ES 7811
-W8917	BP7ES 2412
OMC	NGK → STOCK No.
115206	BP6HS 4511
387694	B7HS 5110
437929	BPR7HS 6422
445098	D6HA 6512
502177	B6HS 4510
502194	B7HS-10 2129
502196	BR6S 3522
502894	BUZ8H 7447
503948	BPR6HS 7022
503949	BR6HS 3922
503950	BR6HS 3922
504082	BR6HS 3922
509921	BUHW 2622
509922	BUHW-2 5626
509924	BUZ8H 7447
509925	BZ7HS-10 3579
509926	BUHXW-1 5526
509928	B6S 3510
509929	B7HS 5110
584918	DCPR7E 3932

OMC	NGK → STOCK No.
771770	BUZHW-2 2173
PEUGEOT - See VAUXHALL	
OREGON - See BRISK	
PAL	NGK → STOCK No.
14-5	B4H 4110
14-5Y	BP4HS 3611
14-7	B5HS 4210
14-7Y	BP5HS 4111
14-8	B6HS 4510
14-8R	BR6HS 3922
14-8Y	BP6HS 4511
14-9	B8HS 5510
14-9R	BR7HS 4122
14-9Y	BP7HS 5111
14K-5	B4 3210
14K-5Y	BP4 2911
14K-7Y	BP5S 3011
14K-8	B6S 3510
14L-5	B5ES 6410
14L-5R	BR5ES 4722
14L-5Y	BP5ES 6511
14L-7	B6ES 7310
14L-7R	BR6ES 4922
14L-7Y	BP6ES 7811
14L-8	B6ES 7310
14L-8Y	BP6ES 7811
14L-9	B7ES 1111
14L-9Y	BP7ES 2412
17-9	B7HS 5110
18-5	AB6 2910
18-5R	AB6 2910
18-7	AB7 3010
B14YC	DPR8EA-9 4929
D14YC	BCP7ES 5030
D15YC	BCP6ES 4930
D17YC	BCP5ES 7496
DR14YC	BCPR7ES 3330
DR15YC	BKR6E 6962
DR17YC	BCPR5ES 6130
G14YC	BP7EFS 3526
G15YC	BP6EFS 3812
G17YC	BP5EFS 3712
K17C	B6S 3510
K17Y	BP5S 3011
K19	B4 3210
L08W	B11EGV 5831
L12W	BR9EIX 3981
L12YC	BP9ES 7526
L14C	B8ES 2411
L14YC	BP7ES 2412
L15C	B7ES 1111
L15W	BR8EIX 5044
L15YC	BP6ES 7811
L17C	B6ES 7310
L17YC	BP5ES 6511
L19C	B5ES 6410
L5Y	BP5ES 6511
L7Y	BP6ES 7811
L8	B6ES 7310
L8Y	BP6ES 7811
L9Y	BP7ES 2412
LR12YC	BPR8ES 3923
LR14YC	BPR7ES 2023
LR15YC	BPR6ES 7822
N12YC	BP8ES 2912
N14C	B9HS 5810
N14YC	BP7HS 5111
N15C	B7ES 1111
N15YC	BP6HS 4511
N17C	B6HS 4510
N17Y	BP4HS 3611

PAL	NGK → STOCK No.
N17YC	BP5HS 4111
N19	B4H 4110
N19C	B5HS 4210
N7	B6HS 4510
N7Y	BP6HS 4511
N8	B7HS 5110
N8Y	BP7HS 5111
NR12YC	BPR8HS 3725
NR15YC	BPR6HS 7022
P15	BM7A 6521
P15Y	BPM7A 7321
P17	BM6A 5921
P17Y	BPM6A 7021
PR15Y	BPMR7A 4626
PR17Y	BPMR6A 6726
S14L-13	B8EG 3430
S14L-15	B9EG 3530
S14L-17	B10EG 3630
U17	BM6F 6221
PEUGEOT	NGK → STOCK No.
1607577680	DILFR5A11 93759
5960.83	LZKAR7A 6799
5960.92	PLZKBR7B8DG 90223
5960.93	PLZKBR7B8DG 90223
5960.A5	PLZKBR7B8DG 90223
5960.E1	PLZKBR7B8DG 90223
5960.F0	BKR6EZ 4619
5960.G1	LZKAR7A 6799
5960.G4	PLZKBR7B8DG 90223
5960.H9	PLZKBR7B8DG 90223
5960.L0	PLZKBR7B8DG 90223
5960.L2	LFR6C-11 5788
5960.L5	ILZKBR7B8DG 95770
5962.05	BP6EFS 3812
5962.09	BP6EFS 3812
5962.13	BP6ES 7811
5962.14	BP6EFS 3812
5962.15	BP6EFS 3812
5962.16	BP6ES 7811
5962.21	BP6ET 1263
5962.22	BPR6EIX 6637
5962.5G	BKR6EZ 4619
5962.6V	BKR6EZ 4619
5962.71	BKR6ES 3783
5962.72	BP6EFS 3812
5962.7S	BKR6EZ 4619
5962.80	BP6HS 4511
5962.82	BP6ES 7811
5962.87	BP6EFS 3812
5962.88	BP8ES 2912
5962.90	BP6HS 4511
5962.94	BP7ES 2412
5962.98	BP7ES 2412
5962.A1	BP7ES 2412
5962.A2	BP6ES 7811
5962.A3	BP6HS 4511
5962.A5	PLZKBR7B8DG 90223
5962.AO	BP7ES 2412
5962.C5	BKR6ES 3783
5962.C6	BKR6ES 3783
5962.CO	BP5EFS 3712
5962.E2	BCP6ES 4930
5962.F7	BCP6ES 4930
5962.F8	BCP6ES 4930
5962.G8	BP7ES 2412
5962.H2	BKR6ES 3783
5962.H8	BKR5E 7938
5962.H9	BCPR5ES 6130
5962.J9	BKR6ES 3783
5962.J0	BCP6ES 4930
5962.K1	BCPR7ES 3330
5962.K3	BCP7ET 2078
5962.K4	BKR6ES 3783

PEUGEOT	NGK → STOCK No.
5962.K6	BKR6ES 3783
5962.K7	BCPR6ET 2197
5962.KO	BCPR7ES 3330
5962.R5	BCPR6ET 2197
5962.R9	BKR6ES 3783
5962.S2	BKR6E 6962
5962.S4	BKR5E 7938
5962.T8	BKR6ES 3783
5962.V6	BKR5E 7938
5962.V7	BKR6ES 3783
5962.V8	BCPR7ES 3330
5962.W4	BCPR6ET 2197
5962.W6	BCPR7ES 3330
5962.W7	BCPR7ES 3330
5962.W9	BKR5EK 7956
5962.X5	BCP6ES 4930
5962.Y2	BKR5EK 7956
5962.Y8	BKR6EK 2288
5962.Z0	BKR6EK 2288
800942	CR9EB 6955
96 762 88 180	LZKR6AI-10G 97999
PE781757	CPR9EB-9 6508
V 7534226803 03	PLZKBR7B8DG 90223
PIAGGIO	NGK → STOCK No.
641320	CR9EB 6955
641546	ER9EH-6N 1673
638049	BR7HS 4122
POLARIS	NGK → STOCK No.
3022111	LKAR8A-9 4786
PORSCHE	NGK → STOCK No.
999 170 103 90	PFR6B 3500
999 170 195 90	BKR7EKC 7354
999 170 223 90	BKR7EQUIP 4285
101905606A	IZKR7B 7563
PRESTOLITE	NGK → STOCK No.
10E2	C7HSA 4629
10E3	C7HSA 4629
12E2	D8HA 7112
12E3	D8HA 7112
10E4	C6HSA 3228
12E22	D6HA 6512
12E42	D6HA 6512
12G2	D8EA 2120
12G3	D8EA 2120
14-11	B2 3110
14-11N	BPM6A 7021
14-11X	B2 3110
14-2X	B6S 3510
14-3	B6S 3510
14-3N	BM7A 6521
14-3X	B6S 3510
14-4	B6S 3510
14-42	BP5S 3011
14-5	B6S 3510
14-5X	B6S 3510
14-52	BP5S 3011
14-7	B4 3210
14-7N	BM6A 5921
14-7X	B4 3210
14-82	BP4 2911
14-9	B4 3210
14-9X	B4 3210
14E1	B8HS 5510
14E01	BUH 2422
14E2	B7HS 5110
14E3	B6HS 4510
14E4	B5HS 4210
14E6	B5HS 4210
14E22	BP7HS 5111
14E32	BP6HS 4511

PRESTOLITE	NGK → STOCK No.	
14E42	BP6HS	4511
14E52	BP5HS	4111
14E62	BP5HS	4111
14E82	BP4HS	3611
14ER4	BR6HS	3922
14ER6	BR6HS	3922
14F22	BP6FS	3512
14F32	BP6FS	3512
14F3N	BM7F	6421
14F42	BP5FS	3412
14F52	BPR4FS	1127
14F7N	BM6F	6221
14G01	BUE	2322
14G1	B8ES	2411
14G12	BP8ES	2912
14G2	B7ES	1111
14G22	BP6ES	7811
14G3	B6ES	7310
14G32	BP5ES	6511
14G4	B6ES	7310
14G42	BP5ES	6511
14G5	B5ES	6410
14G52	BP5ES	6511
14G7	B5ES	6410
14G902	BP8ES	2912
14GF22	BP6EFS	3812
14GR22	BPR6ES	7822
14GR32	BPR5ES	7422
14GR4	BR6ES	4922
14GR42	BPR5ES	7422
14GR52	BPR4ES	7222
14GR53	ZGR5C	6334
14GR7	BR5ES	4722
14GRF22	BPR6EFS	3623
14GRF32	BPR5EFS	2223
14GRF52	BPR5EFS	2223
14L4	B6L	3212
14L7	B6L	3212
14L9	B4L	3112
14R3	BR6S	3522
14R32	BP5S	3011
14R4	BR6S	3522
14R42	BP5S	3011
14R5	BR6S	3522
14R52	BP4	2911
14R53	BP4	2911
14R7N	BM6A	5921
14R8	B6S	3510
14RF22	BPR6FS	2623
14RF32	BPR5FS	2423
14RF32-6	BPR5FS-15	3124
14RF32A	BPR5FS-15	3124
14RF42	BPR5FS	2423
14RF42-6	BPR5FS-15	3124
14RF42A	BPR5FS-15	3124
14RF52	BPR4FS	1127
14RF52-6	BPR4FS-15	2727
14RF52A	BPR4FS-15	2727
14RF62	BPR4FS	1127
14RF62-6	BPR4FS-15	2727
14RF62A	BPR4FS-15	2727
18-3	AB6	2910
18-4	AB6	2910
18-8	AB6	2910
18-9	AB6	2910
18-10	AB6	2910
18F22	AP6FS	2710
18F32	AP6FS	2710
18RF32	APR6FS	2922
18RF42	APR6FS	2922
18RF82	APR6FS	2922
1Y00-18-110	BPR5ES	7422
394	B6ES	7310
4056	B6ES	7310

PRESTOLITE	NGK → STOCK No.	
4253	BP5EY	7327
43N	B6ES	7310
43XL	B6ES	7310
44N	B6ES	7310
44NS	BP5EY	7327
44XL	B6ES	7310
78-10	G2Z	3320
78-8	G2Z	3320
AG3	B6ES	7310
AG30C	B6ES	7310
AG3CX	B6ES	7310
AG3X	B6ES	7310
B2401-89904	BP5EY	7327
C43N	B6ES	7310
C44N	B6ES	7310
C44NS	BP5EY	7327
MS851243	BP5EY	7327
N288	B6ES	7310
N5C	B6ES	7310
S43XL	B6ES	7310
S44XL	B6ES	7310

PROTECNICA	NGK → STOCK No.	
4708	BR2LM	5798
4843	BPM7A	7321

PROTON	NGK → STOCK No.	
8200030765	LZKAR7A	6799
MS851232E	BPR5ES	7422
MS851233E	BPR6ES	7822
MS851358E	BKR6E-11	2756
PW811750	BPR6EF-11	95420
LAP6FS	AP6FS	2710
LBCPR6ES	BCPR6ES	2330
LBCP6ES	BCP6ES	4930
LBPR6EFS	BPR6EFS	3623
LBP5ES	BP5ES	6511
LBP6EFS	BP6EFS	3812
LBP6ES	BP6ES	7811
PW811750	BPR6EF-11	95420

RAM - See CHRYSLER GROUP

RENAULT	NGK → STOCK No.	
22401-8760R	LZKAR7B	5942
22401-9133R	ILKAR7J7G	91121
77 00 101 401	BCPR5ES	6130
77 00 103 502	BPR5ES	7422
77 00 103 503	BPR5ES	7422
77 00 103 533	BKR5EK	7956
77 00 107 916	BKR5EK	7956
77 00 260 637	BCP7ET	2078
77 00 266 295	BPR6EFS	3623
77 00 267 140	BPR6EFS	3623
77 00 267 805	TR7IX	3690
77 00 273 462	BKR6E	6962
77 00 273 698	BKR6EIX	6418
77 00 500 155	BKR6EZ	4619
77 00 500 192	LFRA4P-11	5613
77 00 553 622	BP6ES	7811
77 00 565 155	BR9EIX	3981
77 00 587 168	BP6HS	4511
77 00 714 540	BPR6EFS	3623
77 00 722 095	BP6EFS	3812
77 00 724 821	BP6ES	7811
77 00 725 302	BPR5ES	7422
77 00 726 503	BP7EFS	3526
77 00 727 383	BPR6ES	7822
77 00 731 583	BP7EFS	3526
77 00 732 626	BP8ES	2912
77 00 733 422	BP5HS	4111
77 00 736 149	BP7EFS	3526
77 00 736 150	BP7EFS	3526
77 00 737 457	BP7EFS	3526

RENAULT	NGK → STOCK No.	
77 00 737 458	BP6EFS	3812
77 00 737 459	BP7ES	2412
77 00 737 612	BCP5ES	7496
77 00 742 094	BPR7ES	2023
77 00 743 137	BCP5ES	7496
77 00 743 920	BP5ES	6511
77 00 749 163	BCP5ES	7496
77 00 824 821	BP6ES	7811
77 00 852 522	BP6EFS	3812
77 00 852 543	TR7IX	3690
77 00 855 463	BCP6ET	4563
77 00 855 918	BP5EFS	3712
77 00 856 342	BCP6ET	4563
77 00 859 910	BCP5ES	7496
77 00 859 967	BP5ES	6511
77 00 861 471	BP7ES	2412
77 00 861 472	BP6ESZ	7639
77 00 862 054	BP5ES	6511
77 00 868 864	BPR7ES	2023
77 00 871 617	BCPR6ET	2197
77 01 021 767	BP6EFS	3812
77 01 041 214	BP5ES	6511
77 01 041 215	BP6EFS	3812
77 01 042 816	BKR6E	6962
77 01 043 624	BCPR6ET	2197
77 01 045 018	BP7EFS	3526
77 01 065 085	PLZKAR6A-11	5118
77 01 366 057	BP6HS	4511
77 01 366 084	BR8EIX	5044
77 01 366 085	BR7EIX	6664
77 01 366 086	BP6ES	7811
77 01 366 087	BP7ES	2412
77 01 366 137	BP6EFS	3812
77 01 366 267	BP6HS	4511
77 01 366 268	BP7ES	2412
77 01 366 269	BP6ES	7811
77 01 366 270	BP6EFS	3812
77 01 366 513	BP5HS	4111
77 01 366 514	BP6EFS	3812
77 01 366 515	BP6HS	4511
77 01 366 516	BP6ES	7811
77 01 366 533	B6HS	4510
77 01 366 539	BP5ES	6511
77 01 366 903	BP5ES	6511
77 01 414 022	BP5HS	4111
77 01 414 025	BP6ES	7811
77 01 414 026	BP7EFS	3526
77 01 414 027	BP7EFS	3526
77 01 414 031	BPR6ES	7822
82 00 030 765	LZKAR7A	6799
82 00 314 928	PFR7G-9	4371
82 00 322 273	LZKAR7A	6799
82 00 363 384	PFR6G-9	4377
82 00 492 426	PFR7Z-TG	5768
82 00 587 901	ILKAR7A7	91432
82 00 592 215	LZKAR7B	5942
82 00 662 185	LZKAR7A	6799
82 00 682 592	Y1035AS	96614
82 01 001 947	IFR7X8G	95820
83 04 504 277	ZFR5F	5165
89 33 003 862	BKR6ES	3783
96 26 575 480	BKR6EK	2288

SAAB	NGK → STOCK No.	
12620540	ILTR5D	5476
12788884	PLFR6C-10G	1959
55564215	BKR7ESC-11	6313
55571391	PFR6T-10G	5542
8819302	BCPR7EIX	5690
9112541	BCPR7ES-11	1095
9117565	BCPR6ES-11	7121
9136276	BCPR5EIX	5688
9139643	BCPR6EIX	5689
9399866	PFR6H-10	6290

SEAT - See VW GROUP		
SKODA - See VW GROUP		
SMART		
000 3085 V005 0000 00	BKR6EKE	5649
001 2468 V002 000 00	LZKR8A	5214
A 003 159 92 03	BKR6EKE	5649
SPLITFIRE		
TP006A	BPR8EIX	6684
TP006B	BPR7EIX	4055
TP006C	BPR6EIX	6637
TP006D	BPR5EIX	6597
TP006E	BPR5EIX	6597
TP406B	BR9EIX	3981
TP406B	BR9EIX	3981
TP406C	BR8EIX	5044
TP406C	BR8EIX	5044
TP430B	CR9EIX	3521
TP430C	CR8EIX	4218

STEINBOCK	NGK → STOCK No.	
8155723	BPR4FS	1127

STIHL	NGK → STOCK No.	
144483	BP2ES	3467

SUBARU	NGK → STOCK No.	
22401AA020	BP6ES	7811
22401AA090	BP7ES	2412
22401AA120	BPR6ES-11	4824
22401AA220	BPR6ES	7822
22401AA230	BPR7E	1142
22401AA310	BKR6E-11	2756
22401AA370	PFR6B-11	4014
22401AA400	PFR6B	3500
22401AA480	BPR5ES-11	4424
22401AA500	BKR6EIX-11	3764
22401AA510	BKR6EIX	6418
22401AA530	PFR6B	3500
22401AA531	PFR6B	3500
22401AA570	PFR6B	3500
22401AA670	SILFR6A	7913
22401AA720	SILFR6A11	5468
22401AA730	SIFR6A11	0127
22401AA740	SILFR6A6	8659
22401AA830	ILKAR8H6	96024
22401KA080	BKR6E	6962
22401KA100	BCPR6E	1269
22401KA210	BKR5E-11	6953
320540800	B6ES	7310
320541110	B7ES	1111
320541120	BR7EIX	6664
320545700	BR6ES	4922
382420800	B5ES	6410
420543200	BP5ES	6511
490010003	BPR5EIX	6597
490010013	BPR6EIX	6637
490010023	BPR7EIX	4055
490010033	BPR5ES	7422
490010043	BP5EY	7327
490010053	BP6EY	7727
820541810	B6HS	4510
820546010	B8HS	5510
820548020	BR8HIX	7001
820549310	B7HS	5110
820549320	BR7HIX	7067
882417800	B5HS	4210
890573400	B6S	3510

SUZUKI	NGK → STOCK No.	
04982-00584	CR8EIB-10	4948
04982-00597	CR8EIA-10	4708
04982-02EA1	ZMR7AP	6914

SUZUKI	NGK → STOCK No.	SUZUKI	NGK → STOCK No.	SUZUKI	NGK → STOCK No.	TOYOTA	NGK → STOCK No.
09482-00036	BP4HS 3611	09482-00354	DPR7EA-9 5129	09482-00561	BR8EG 3130	90919-01056	BPR4ES 7222
09482-00066	B9ES 2611	09482-00358	BR4HS 3322	09482-00564	BR9EYA 7548	90919-01021	BP2ES 3467
09482-00082	B7HS 5110	09482-00359	BPR5HS 6222	09482-00590	CR6EIA-9 7967	90919-01176	BKR5EYA-11 2526
09482-00084	BP6HS 4511	09482-00360	BR10ES 4832	09482-00597	CR8EIA-10 4708	90919-01184	BKR6EYA-11 4073
09482-00088	BR6HS 3922	09482-00367	BR4HS 7823	09482-00600	DIMR8A10 5066	90919-01193	BKR5EKB-11 3967
09482-00089	B7ES 1111	09482-00370	BR8HS-10 1134	09482-00603	IKR6G11 7980	90919-01210	IFR6T11 4589
09482-00091	B8ES 2411	09482-00375	B8HS-10 5126	09482-00603-000	IKR6G11 7980	90919-01215	IFR5T-8N 3508
09482-00095	B6HS 4510	09482-00385	BP7ES 2412	09482-00621	CPR7EA-9 3901	90919-01221	HB6AIX-11P 5703
09482-00098	BR9ES 5722	09482-00389	JR9B 3188	09482-00635	LMAR8BI-9 91909	90919-01226	HB6BIX-11P 5705
09482-00102	BR8HS 4322	09482-00391	JR10B 1299	09482-69001	BPR6HS 7022	90919-01230	HB6BIX-11P 5705
09482-00105	BP7HS 5111	09482-00397	JR9C 6193			90919-01233	ILFR5T11 96779
09482-00115	BR9EIX 3981	09482-00398	DR7EA 7839	TCM	NGK → STOCK No.	90919-01234	ILFR5T11 96779
09482-00116	BR7HS 4122	09482-00399	DR8EA 7162	20801-0A041	BP2ES 3467	90919-01235	LF6C-11 5788
09482-00117	BR7ES 5122	09482-00400	DR9EA 3437	N-22401-L1600	BPR4ES 7222	90919-01249	DFH6B-11A 6858
09482-00118	BP6ES 7811	09482-00406	CR6HSA 2983	N-22401-W8914	BP2ES 3467	90919-01253	ILKAR7B11 4912
09482-00121	BR8ES 5422	09482-00408	CR7HSA 4549			90919-01950-71	BP2ES 3467
09482-00124	BP5HS 4111	09482-00409-001	BPR6ES 7822	TORCH - See CHINESE BRANDS		90919-01954	BP5EY 7327
09482-00127	BR9ES 5722	09482-00409	BPR6ES 7822			90919-01954-71	BPR2ES 2264
09482-00131	BP5ES 6511	09482-00410	CR9EK 4548	TOYOTA	NGK → STOCK No.	90919-W1001	LF6C-11 5788
09482-00136	BPR4HS 7823	09482-00412	CR8EK 3478	00591-02042-81	BPR4ES 7222	90999-09001-71	BP2ES 3467
09482-00139	BP7ES 2412	09482-00414	CR7EK 7546	00591-03633-81	BPR4ES 7222	90999-09002-71	BP2ES 3467
09482-00141	BPR6HS 7022	09482-00426	BK6E 3536	00591-05493-81	BMR6A 7421		
09482-00143	BR5HS 3722	09482-00427	BKR6E 6962	00591-06165-81	BPR5FS 2423	TRIUMPH	NGK → STOCK No.
09482-00144	D8EA 2120	09482-00429-000	BKR6E 6962	00591-06208-81	BP2ES 3467	1290023	CR9EK 4548
09482-00147	BPR5HS 6222	09482-00429-001	BKR6E 6962	00591-06209-81	BP2ES 3467	1290024	DPR8EA-9 4929
09482-00149	DR8ES-L 2923	09482-00429	BKR6E 6962	00591-07885-81	AB-6 2910	1290181	CR8EK 3478
09482-00155	BPR5ES 7422	09482-00432	BPR5E 7075	00591-07896-81	AB-6 2910	1290745	LMAR8A-9 4313
09482-00157	BR8HS 4322	09482-00433	BPR5EY-11 3028	00591-10918-81	BPR5FS 2423	1291023	CR9EIA-9 6289
09482-00167-000	BPR5EY 2828	09482-00446	DCPR6E 3481	00591-10919-81	BMR6A 7421	1295151	CR8EIA-9 4286
09482-00167-001	BPR5ES 7422	09482-00448	DCPR7E 3932	00591-20174-81	BMR6A 7421	1296999	DPR6EA-9 5531
09482-00167	BPR5ES 7422	09482-00450	DCPR8E 4179	00591-32673-81	BPR4ES 7222	1290180	DPR7EA-9 5129
09482-00175	BP8ES 2912	09482-00456	CR8E 1275	00591-32691-81	AB-6 2910	T1290023	CR9EK 4548
09482-00177	BP6ES 7811	09482-00458	CR9E 6263	00591-32692-81	BPR5FS 2423	T1290024	DPR8EA-9 4929
09482-00181	BR10EIX 6801	09482-00460	CR10E 6264	00591-32695-81	BP2ES 3467	T1290180	DPR7EA-9 5129
09482-00182	D7EA 7912	09482-00462	CR10EK 2360	00591-33646-81	BPR4ES 7222	T1290181	CR8EK 3478
09482-00184	D9EA 2420	09482-00463	CR10EK 2360	00591-33649-81	BP2ES 3467	T1290745	LMAR8A-9 4313
09482-00198	B8HS 5510	09482-00464	BR8HCS-10 1157	00591-33687-81	BMR6A 7421	T1291023	CR9EIA-9 6289
09482-00205	BPR4HS 7823	09482-00467	BR9HS-10 4551	00591-42808-81	BPR5FS 2423	T1295151	CR9EK 4548
09482-00208	BR8EIX 5044	09482-00470	BR8ECM 3035	00591-50969-81	BPR4ES 7222	T1296999	DPR6EA-9 5531
09482-00209	BR9EIX 3981	09482-00472	BR9ECM 3252	00591-50970-81	AB-6 2910		
09482-00210	BR10EIX 6801	09482-00474	BR10ECM 4234	00591-50971-81	AB-6 2910	UNIPART	NGK → STOCK No.
09482-00220	DR7ES 3123	09482-00477	BKR5E 7938	00591-50973-81	BP2ES 3467	GSP130	B5ES 6410
09482-00221	DR8ES 5423	09482-00479	DCPR7EIX 6046	00591-50976-81	BP2ES 3467	GSP131	BP5ES 6511
09482-00229	BPR6ES 7822	09482-00485	CR8HSA 2086	00591-50978-81	BPR5FS 2423	GSP141	BP5ES 6511
09482-00230	BR8HS 4322	09482-00486	BR8HCS-10 1157	00591-50979-81	BPR4FS 1127	GSP151	BP6ES 7811
09482-00237	B8HS 5510	09482-00487	BPR6ES 7822	00591-53307-81	AB-6 2910	GSP160	B6ES 7310
09482-00239	BPR8ES 3923	09482-00491	JR9B 3188	00591-55310-81	BMR6A 7421	GSP163	BP6ES 7811
09482-00244	BPR7HS 6422	09482-00494	BKR6E-11 2756	150038500	BP2ES 3467	GSP171	BP6ES 7811
09482-00255	BPR7HS 6422	09482-00495	RPR7ES 2023	150112478	BPR4ES 7222	GSP181	BP7ES 2412
09482-00258	BPMR6A 6726	09482-00499	R4118S-8 3236	19111-31720-71	PTR5D-10 3784	GSP191	BP8ES 2912
09482-00259	BP6HS 4511	09482-00500	R4118S-9 3245	19111-31721-71	PTR5D-10 3784	GSP2001	BKR6E 6962
09482-00261	BPMR4A 6028	09482-00504	BPR5EY 2828	19111-90098-71	PTR5D-10 3784	GSP2002	BPR6ES 7822
09482-00264	BP6HS-10 6326	09482-00509	R6918B-8 4492	19111-U2120-71	BPR4FS 1127	GSP2003	BKR6E 6962
09482-00269	B7HS-10 2129	09482-00511	R6918B-7 6259	19111-U3161-71	PTR5D-10 3784	GSP2004	ZFR6F-11 4291
09482-00277	BR7HS-10 1098	09482-00513	R0045J-10 7400	220001599	BP2ES 3467	GSP2005	BCPR6ES-11 7121
09482-00278	B8HS-10 5126	09482-00516	CR7E 4578	220034475	BPR4ES 7222	GSP2006	BPR6EFS 3623
09482-00279	B8HS-10 5126	09482-00519	BR9EYA 7548	580052996	BPR6EFS 3623	GSP2007	BKR6E 6962
09482-00280	BR8HS-10 1134	09482-00521	PGR5A 3987	80098-76004-71	BMR6A 7421	GSP2008	BPR5ES 7422
09482-00285	BPR6ES-11 4824	09482-00522	BPR7HS-10 1092	80098-76005-71	BMR6A 7421	GSP2009	BPR6ES 7822
09482-00290	BP4HS 3611	09482-00523	BPR8HS 3725	80098-76006-71	BP2ES 3467	GSP2010	BP6ET 1263
09482-00299	BPR6ES 7822	09482-00528	CR6E 6965	80919-76004-71	BP2ES 3467	GSP2013	ZGR5A 5839
09482-00299-000	BPR6ES 7822	09482-00530	BPR6HS 7022	80919-76008-71	BP2ES 3467	GSP2015	BKR6E 6962
09482-00316	BPR5HS 6222	09482-00531	BP6HS 4511	80919-76009-71	BP2ES 3467	GSP2017	BKR5EK 7956
09482-00321	C8HSA 6821	09482-00532	B7HS-10 2129	80919-76011-71	BP2ES 3467	GSP2018	BKR5EK 7956
09482-00327	BR6HS-10 1090	09482-00533	BR7HS-10 1098	80999-76018-71	BP2ES 3467	GSP2019	BPR6ES-11 4824
09482-00330	DPR9EA-9 5329	09482-00534	B6HS-10 1052	90053-7827	BP2ES 3467	GSP2020	BPR5ES 7422
09482-00332	DPR8EA-9 4929	09482-00535	BR6HS-10 1090	90098-09125	BP2ES 3467	GSP2021	APG6S 2710
09482-00334	DPR8EA-9 4929	09482-00537	DCPR9EIX 2316	90098-14785	BPR4FS 1127	GSP2022	BKR5E 7938
09482-00338	B6HS-10 1052	09482-00547	IFR5E11 7994	90098-16785	BPR5FS 2423	GSP2023	BCPR7ES 3330
09482-00340	CR6HS 7023	09482-00548	IFR6E11 6741	90098-20395	BP2ES 3467	GSP2024	BP6ET 1263
09482-00341	BR6HS-10 1090	09482-00549	IFR5J11 7418	90098-64015	AB-6 2910	GSP2025	ZFR5F 5165
09482-00348	BR8ES 5422	09482-00550	IFR6J11 7658	90098-66113-71	PTR5D-10 3784	GSP2026	APR6FS 2922
09482-00349	BR9ES 5722	09482-00556	CR8EIA-9 4286	90420-01190-71	PTR5D-10 3784	GSP2027	BPR6EFS 3623
09482-00351	B9ES 2611	09482-00558	CR9EIA-9 6289	90919-01055-71	BP2ES 3467	GSP2028	BKR6EKC 2848

UNIPART	NGK → STOCK No.	
GSP2029	BPR6HS	7022
GSP2030	BUR6ET	3172
GSP2031	BP5ET	2287
GSP2032	B5HS	4210
GSP2033	APR5FS	3122
GSP2034	BPR6ES	7822
GSP2035	BCP5ES	7496
GSP2036	BPR7ES	2023
GSP2037	BCPR6ES-11	7121
GSP2038	BUR5ET	3377
GSP2039	BPR5ES-11	4424
GSP2040	BP5EFS	3712
GSP2041	BKR6EQUP	3199
GSP2044	PFR7B	4853
GSP2045	BKR5E-11	6953
GSP2046	B6ES	7310
GSP2048	BKUR7ET	7873
GSP2049	B6HS	4510
GSP2050	B7HS	5110
GSP2051	BR8ES	5422
GSP2053	BKR6EK	2288
GSP2055	PFR6B-11	4014
GSP2056	BP6HS	4511
GSP2059	BKR6EQUP	3199
GSP2064	BCPR6ET	2197
GSP2065	BP5HS	4111
GSP2066	BKR6EKC	2848
GSP2070	BKR6EKC	2848
GSP2071	ZFR4F-11	4043
GSP2072	ZFR6F-11	4291
GSP2073	BKUR5ET	2789
GSP2074	BPR6EIX	6637
GSP2075	BP7HS	5111
GSP2081	BPR6ES-11	4824
GSP2082	BPR7EIX	4055
GSP2085	BCPR7ES-11	1095
GSP2086	B8EFS	1049
GSP2087	BKUR6ET-10	2397
GSP2088	BCPR6ET	2197
GSP2090	BR7ES	5122
GSP2094	BP5EFS	3712
GSP2098	BP6ES	7811
GSP2099	BP5ES	6511
GSP2100	BCP6ES	4930
GSP2101	BP6EFS	3812
GSP2102	BP6EFS	3812
GSP2103	BCP6ES	4930
GSP2106	TR5A-10	0005
GSP2108	DCPR8E-N	5692
GSP2110	BKR6E	6962
GSP2111	BPR6ES	7822
GSP2112	BKR6E	6962
GSP2113	ZFR6F-11	4291
GSP2114	BCPR6ES-11	7121
GSP2115	BPR6EFS	3623
GSP2116	BKR6E	6962
GSP2117	BPR5ES	7422
GSP2118	BPR6ES	7822
GSP2119	BPR6ES-11	4824
GSP2120	BPR6EFS	3623
GSP2121	BP5EFS	3712
GSP2122	PFR6N-11	3546
GSP2136	BKR6EQUP	3199
GSP2137	LF6B	6677
GSP2138	LF6B	7113
GSP2149	ZFR6S-Q	6449
GSP2151	IZKR7B	7563
GSP2212	PFR6N-11	3546
GSP244	BPR5ES	7422
GSP263	BPR6ES	7822
GSP264	BPR5ES	7422
GSP281	BPR7ES	2023
GSP30	B6S	3510
GSP331	BP5EFS	3712

UNIPART	NGK → STOCK No.	
GSP351	BP5EFS	3712
GSP361	BP6EFS	3812
GSP381	BP7EFS	3526
GSP4154	AP6FS	2710
GSP4266	B5HS	4210
GSP4352	BP6ES	7811
GSP4356	BP6HS	4511
GSP4362	BP6ES	7811
GSP4366	BP6HS	4511
GSP4372	BP5ES	6511
GSP4376	BP5HS	4111
GSP4382	BP5ES	6511
GSP4452	BPR7ES	2023
GSP4462	BPR6ES	7822
GSP4472	BPR5ES	7422
GSP4552	BCP7ES	5030
GSP4562	BCP6ES	4930
GSP4563	BP6EFS	3812
GSP4573	BP5EFS	3712
GSP461	BPR6EFS	3623
GSP4652	BCPR7ES	3330
GSP4662	BKR6E	6962
GSP4663	BPR6EFS	3623
GSP531	BP5HS	4111
GSP540	B5HS	4210
GSP541	BP6HS	4511
GSP550	B6HS	4510
GSP560	B7HS	5110
GSP571	BP7HS	5111
GSP634	BCPR5ES	6130
GSP6356	BP6HS	4511
GSP6382	BP5ES	6511
GSP6452	BPR7ES	2023
GSP6462	BPR6ES	7822
GSP6468	BPR6ES-11	4824
GSP6472	BPR5ES	7422
GSP664	BKR6E	6962
GSP665	BCP6ES	4930
GSP6651	PTR5A-10	5055
GSP6652	BCPR7ES	3330
GSP6658	BCPR7ES-11	1095
GSP6662	BKR6E	6962
GSP6663	BPR6EFS	3623
GSP6668	BCPR6ES-11	7121
GSP684	BCPR7ES	3330
GSP685	BCP7ES	5030
GSP761	BP6FS	3512
GSP881	BPR6FS	2623
GSP9652	PFR6N-11	3546
GSP981	AP6FS	2710

VAUXHALL/OPEL	NGK → STOCK No.	
12 14 000	BKR5EK	7956
12 14 066	IFR7X7G	91039
12 620 540	ILTR5D	5476
12 788 884	PLFR6C-10G	1959
55 564 748	DILFR7B10G	97218
55 564 763	ZFR6BP-G	1748
55 565 219	ZFR6V-G	8894
55 576 026	IFR7X7G	91039
90 239 568	BPR6ES	7822
90 239 569	BPR6HS	7022
90 336 461	BKR6ES	3783
90 338 179	BCPR6ET	2197
90 355 136	BPR6ES	7822
90 356 323	BPR5ES	7422
90 357 729	BKR6EK	2288
90 357 780	BKR6ES	3783
90 423 215	BKR6ES	3783
90 512 989	BKR5EK	7956
91 132 086	BKR5EQUB	1567
91 951 09	BKR5EK	7956
91 958 68	BKR5EQUB	1567
91 990 38	LTR6B-10T	5948

VAUXHALL/OPEL	NGK → STOCK No.	
93 161 199	PFR6G-9	4377
93 176 801	ZFR5F	5165

VESPA	NGK → STOCK No.	
137778	B6HS	4510
137917	B6ES	7310

VOLKSWAGEN - See VW GROUP

VOLVO	NGK → STOCK No.	
13 06 604	BPR6ES	7822
13 06 605	BPR6ES	7822
13 57 828	BPR7HS	6422
13 67 528	BPR6ES	7822
13 67 529	BPR6ES	7822
27 16 03	BKR6E	6962
27 17 27	BKR6E	6962
21 72 07	BKR6EKUB	3584
27 23 13	PFR6B	3500
30 637 308	PFR6B	3500
30 637 385	LF6B	4704
30 650 379	PLFR6A-11	7654
30 731 425	TR5B-13	4559
30 751 468	ILFR6B	6481
30 758 130	ILTR6G8G	96621
30 777 349	TR6AP-13	5809
31 216 674	ILFR6K8	94040
31 330 450	ILZTR6A8G	94769
31 411 394	TR5AI-13	90813
35 179 80	BKR6E	6962
86 584 74	PLFR6A-11	7654
86 947 49	ITR6F13	4477
91 467 75	BKR6ETUC	3384
92 020 64	BKR6ETUC	3384

VW GROUP	NGK → STOCK No.	
03C 905 601B	SIZFR6B8EG	96209
03F 905 600A	IZFR6P7	97153
04C 905 606 A	ZKER6A-10EG	96596
04C 905 616	ZKER6A-10EG	96596
04E 905 601	PZKER7A8EGS	94968
04E 905 612	PZKER7A8EGS	94968
06H 905 601A	PFR7S8EG	1675
06H 601 621	PFR7S8EG	1675
06K 905 601B	PLFR7A8EG	94833
06K 905 601C	PLFR7A8EG	94833
06K 905 611C	PLFR7A8EG	94833
101 000 000AB	BP6ESZ	7639
101 000 001AB	BP6ET	1263
101 000 001AC	BP6ET	1263
101 000 001AD	BP5ET-10	5156
101 000 001AE	BP5ET	2287
101 000 002AB	BP6ESZ	7639
101 000 003AA	BCP7ET	2078
101 000 004AA	BCP7ET	2078
101 000 005AA	BP6ET	1263
101 000 005AB	BP6ET	1263
101 000 005AD	BP5ET-10	5156
101 000 005AE	BP5ET	2287
101 000 005AF	BP5ET	2287
101 000 006AB	BP6ESZ	7639
101 000 006AC	BP6ESZ	7639
101 000 007AA	BP6ET	1263
101 000 007AB	BP6ET	1263
101 000 007AC	BP5ET-10	5156
101 000 007AD	BP6ET	1263
101 000 016AA	PFR7B	4853
101 000 016AB	PFR6Q	6458
101 000 017AA	BCP7ET	2078
101 000 026AA	BUR5ET	3377
101 000 026AB	BUR6ET	3172
101 000 027AA	BP6ET	1263
101 000 027AB	BP5ET	2287
101 000 027AC	BP5ET-10	5156

VW GROUP	NGK → STOCK No.	
101 000 028AA	BCP7ET	2078
101 000 029AB	BUR6EFSZ	6837
101 000 033AA	BKUR6ET-10	2397
101 000 033AB	BKUR7ET	7873
101 000 033AC	BKR5ET	2789
101 000 033AF	BKUR6ET	6437
101 000 033AG	BKUR5ET-10	7553
101 000 034AA	BP6ESZ	7639
101 000 035AB	BKR5EKU	3964
101 000 035AH	BKR5EKUP	2890
101 000 035HJ	BKR6EKUB	3584
101 000 036AA	BUR6ET	3172
101 000 036AB	BUR5ET	3377
101 000 036AC	BUR5ET-10	7264
101 000 038AA	BPR5EKU	5685
101 000 038AB	BPR5EKU	5685
101 000 039AA	BPR5EKU	5685
101 000 039AB	BPR5EKU	5685
101 000 040AC	BUR5ET	3377
101 000 040AD	BUR6ET	3172
101 000 040AE	BUR5ET-10	7264
101 000 041AC	BKUR6ET-10	2397
101 000 041AD	BKUR6ET	6437
101 000 041AE	BKUR7ET	7873
101 000 047AC	BKR6EIX	6418
101 000 049AD	BKR6ETA-10	7998
101 000 050AA	BUR5ET	3377
101 000 050AB	BUR5ET-10	7264
101 000 050AC	BUR6ET	3172
101 000 051AA	BKUR6ET-10	2397
101 000 051AB	BKUR7ET	7873
101 000 052AA	BUR6EFSZ	6837
101 000 060AA	BKUR5ET-10	7553
101 000 062AB	PZFR5D-11	7968
101 000 063AA	PFR6Q	6458
101 000 063AC	PFR7Q	7963
101 000 065AA	BKR6ETA-10	7998
101 000 068AA	ZFR6S-Q	6449
101 905 600	PZFR5J-11	7743
101 905 600A	PZFR6J-11	3586
101 905 600B	PZFR6Q-11	5965
101 905 601	PZFR5D-11	7968
101 905 601B	ZFR5P-G	6893
101 905 601F	ZFR6T-11G	5960
101 905 602	KR8BI	4347
101 905 606A	IZKR7B	7563
101 905 607	BKR6EKUE	9892
101 905 611	PFR6U-11G	5874
101 905 611A	PFR6X-11	5757
101 905 611G	PFR8S8EG	94460
101 905 616	BKR6EQUA	6872
101 905 617	ZFR5P-G	6893
101 905 617C	ZFR6T-11G	5960
101 905 618A	ZFR6T-11G	5960
101 905 620	PZFR5N-11T	7742
101 905 621	PFR7W-TG	5592
101 905 621B	PFR6W-TG	5547
101 905 622	ILZKR7A	1961
101 905 622A	ILZKR8A	94290
101 905 622B	ILZKR8A	94290
101 905 626	PZFR6R	5758
101 905 631C	PFR6Q	6458
101 905 631G	PFR8S8EG	94460
101 905 631H	PFR7S8EG	1675
400 905 619	PFR7G	4364
410 905 619	KR8BI	4347
5F6 905 601	R7438-9	4656

WAUKESHA	NGK → STOCK No.	
110532	AB-6	2910
209316	AB-6	2910

WHITE MOBILITY	NGK → STOCK No.	
10-R-385	AB-6	2910

WHITE MOBILITY	NGK → STOCK No.	
10R1191	AB-6	2910
20-7000680	AB-6	2910
20-7000681	AB-6	2910
20-7000949	AB-6	2910
20-7100035	AB-6	2910

WOLF	NGK → STOCK No.	
1015 306	AB6	2910
1018 301	BM6A	5921
1022 304	AB6	2910
2000 305	BMR6A	7421
2016 301	B7HS	5110
2050 324	BMR6A	7421
2085 300	BR6ES	4922
2090 306	BPR6ES	7822

YALE	NGK → STOCK No.	
016254800	AB-6	2910
016255000	AB-6	2910
016255100	AB-6	2910
031314500	AB-6	2910
063194200	AB-6	2910
150015100	AB-6	2910
150112405	AB-6	2910
150112406	AB-6	2910
150112407	AB-6	2910
150112408	AB-6	2910
150112409	AB-6	2910
150112410	AB-6	2910
150112411	AB-6	2910
150112413	AB-6	2910
150112420	AB-6	2910
150112427	AB-6	2910
150112453	BPR5FS	2423
150112466	BPR4ES	7222
150112473	BMR6A	7421
150112490	BMR6A	7421
150112494	BMR6A	7421
220007428	AB-6	2910
220010987	AB-6	2910
220011080	AB-6	2910
220011107	AB-6	2910
220011205	AB-6	2910
220013371	BPR4FS	1127
220052206	AB-6	2910
509295802	AB-6	2910
510764800	AB-6	2910
516484800	BPR5FS	2423
517451800	AB-6	2910
5059605-35	BPR2ES	2264
580000628	BPR4FS	1127
580005036	BPR5FS	2423
580008972	BPR5FS	2423
580013445	BPR5FS	2423

YAMAHA	NGK → STOCK No.	
14B-R465B-70	R0465B-10	7506
31926-KRM-841	CPR9EA-9	2308
90793 20029	BR10EIX	6801
90793 20030	B105EGV	2171
90793 20032	B10EG	3630
90890 78082	BR10EIX	6801
94700-00866	CPR8EA-9	2306
94701 00039	B6HS	4510
94701 00040	B7HS	5110
94701 00041	B8HS	5510
94701 00042	B9HS	5810
94701 00043	B6ES	7310
94701 00044	B7ES	1111
94701 00045	B8ES	2411
94701 00046	B9ES	2611
94701 00050	BP7HS	5111
94701 00061	BR8EIX	5044
94701 00063	BR9EIX	3981

YAMAHA	NGK → STOCK No.	
94701 00069	B5HS	4210
94701 00078	B5ES	6410
94701 00108	BP6HS	4511
94701 00110	BR7HS	4122
94701 00111	BR6ES	4922
94701 00112	BR7ES	5122
94701 00113	BR8EIX	5044
94701 00116	BP6ES	7811
94701 00117	BP7ES	2412
94701 00118	BP8ES	2912
94701 00148	BR8HIX	7001
94701 00157	D8EA	2120
94701 00159	BP4HS	3611
94701 00160	B8HS-10	5126
94701 00168	BP5HS	4111
94701 00188	BR9ES	5722
94701 00189	D7EA	7912
94701 00193	BR9EIX	3981
94701 00194	BPR5HS	6222
94701 00195	BR8HS	4322
94701 00198	BPR6HS	7022
94701 00203	DR8ES-L	2923
94701 00204	BR8ES	5422
94701 00208	DR7ES	3123
94701 00217	B7HS-10	2129
94701 00218	BPR7ES	2023
94701 00219	BPR8ES	3923
94701 00227	BP7HS	6422
94701 00232	BP6HS-10	6326
94701 00234	BPR6ES	7822
94701 00237	BP8HS-10	3823
94701 00241	DPR8EA-9	4929
94701 00248	BR6HS	3922
94701 00250	CR7HS	7223
94701 00251	BR9HS	4522
94701 00254	C7HSA	4629
94701 00256	C6HSA	3228
94701 00258	BPR4HS	7823
94701 00262	DPR7EA-9	5129
94701 00264	BP7HS-10	7829
94701 00266	D9EA	2420
94701 00268	BP8HS	2630
94701 00273	B6HS-10	1052
94701 00274	BR6HS-10	1090
94701 00280	BPR8HS	3725
94701 00282	CR6HS	7023
94701 00284	BPR6EIX	6637
94701 00285	BPR6EIX	6637
94701 00287	DR8ES	5423
94701 00292	BPR6HS-10	2633
94701 00300	CR5HS	2874
94701 00309	BR9HS-10	4551
94701 00311	BR5ES	4722
94701 00318	CR9E	6263
94701 00328	BPR5ES	7422
94701 00330	CR8E	1275
94701 00332	R5184-105	3334
94701 00333	DR8EA	7162
94701 00340	DR9EA	3437
94701 00345	DR7EA	7839
94701 00353	CR7E	4578
94701 00361	DPR9EA-9	5329
94701 00365	BR6FS	4323
94701 00372	CR6HSA	2983
94701 00375	DPR6EA-9	5531
94701 00395	CR9EK	4548
94701 00403	CR9EK	4548
94701 00406	DPR5EA-9	2887
94701 00408	CR9EIA-9	6289
94701 00422	LMAR7A-9	4908
94701 00434	LMAR8G	95627
94702 00044	B7ES	1111
94702 00045	B8ES	2411
94702 00046	B9ES	2611

YAMAHA	NGK → STOCK No.	
94702 00149	B7HS	5110
94702 00188	BR9ES	5722
94702 00193	BR9EIX	3981
94702 00195	BR8HS	4322
94702 00204	BR8ES	5422
94702 00211	BPMR6A	6726
94702 00247	BR8HS-10	1134
94702 00248	BR6HS	3922
94702 00249	BR5HS	3722
94702 00271	BR7HS-10	1098
94702 00272	BR7HS	4122
94702 00274	BR6HS-10	1090
94702 00309	BR9HS-10	4551
94702 00317	B9HS-10	3626
94702 00323	B8EG	3430
94702 00324	BR9EG	3230
94702 00325	B9EG	3530
94702 00326	BR8EG	3130
94702 00331	BPR4ES	7222
94702 00343	BR4ES	1097
94702 00348	BPR2ES	2264
94702 00349	BR7ES	5122
94702 00357	BR9ECM	3252
94702 00367	B10EG	3630
94702 00368	BR10EG	3830
94702 00372	CR6HSB	6500
94702 00391	LF9A-11	6376
94702 00400	LF6A-11	3672
94702 00404	BKR7EIKU	5881
94702 00405	BKR6EIKU	6993
94702 00409	CR9EB	6955
94702 00419	CR4HSB	4695
94702 00429	LKR7E	1643
94703 00277	BR9EIX	3981
94703 00420	CPR7EA-9	3901

YANMAR	NGK → STOCK No.	
124190-78010	BPR4ES	7222
160110-78011	B6HS	4510
160232-78010	B4H	4110
160560-78010	BPMR4A	6028
160610-78010	BP4HS	3611
160690-78010	BP6ES	7811
160693-78010	BPR6ES	7822
160769-78010	BR4HS	3322
160793-78010	BPR5ES	7422
160810-78010	BPR4HS	7823
160998-78010	BPR6EY	6427
181630-78010	BUHW	2622

YHX - See CHINESE BRANDS

ZENOAH	NGK → STOCK No.	
3699-92672	BPMR8Y	2218



SPARK PLUG COVERS

STANDARD PLUG COVERS



EPDM RUBBER PLUG COVERS



The NGK range of resistor covers are designed to give perfect noise suppression across all frequencies whilst engine performance is not adversely affected whatsoever.

Featuring a resistor element pressed in between the plug terminal and the high tension wire connection, the construction is extremely durable, the resistor element is long enough to prevent interior flashover, and steady resistance is maintained. Superlative ceramic materials are incorporated that resist deterioration and have small resistance variation under over-load, whilst the plug connector is made of sturdy phenolic resin, practically oblivious to tremendous heat and high tension, and very rugged rubber material. The heat press insertion makes the construction all the more tough and vibration-resistant. Special rubber liners on both ends prevent moisture from causing electrical leakage.

All motorcycle manufacturers now comply with current legislation which demands a standard of noise suppression on every vehicle. This is achieved usually by fitting NGK resistor covers though in many cases a combination of NGK resistor covers and NGK resistor spark plugs (R type) is necessary to satisfy the ministry tests. It is emphasized that despite the use of both resistor covers and spark plugs in such engines, due to the unique and superior construction of NGK products there is no loss of performance or shortening of service life.

LB05EMH and SD05FM being of tough EPDM rubber construction are intended for competition/trial applications.

COVER SYMBOLS EXPLANATION CHART

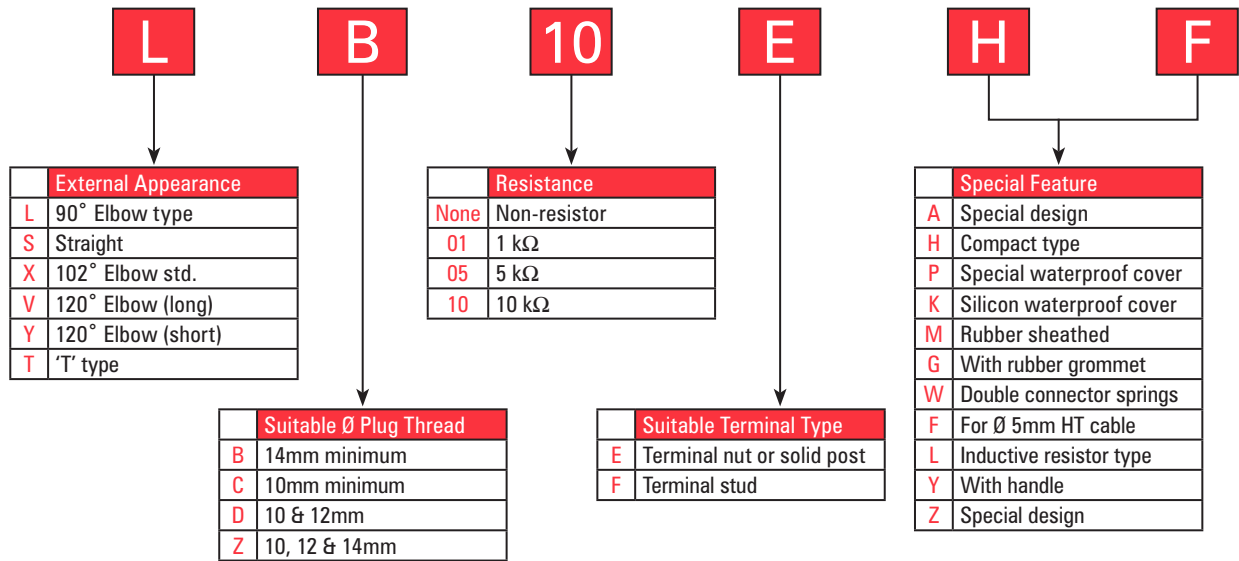

NGK RESISTOR PLUG COVERS

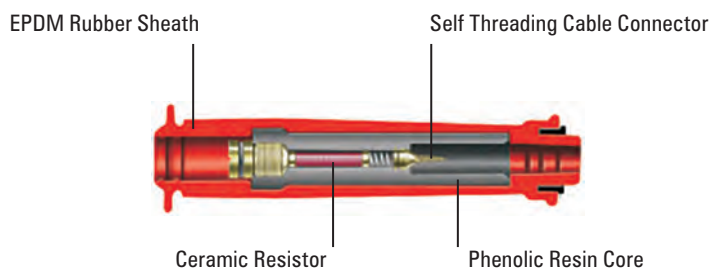
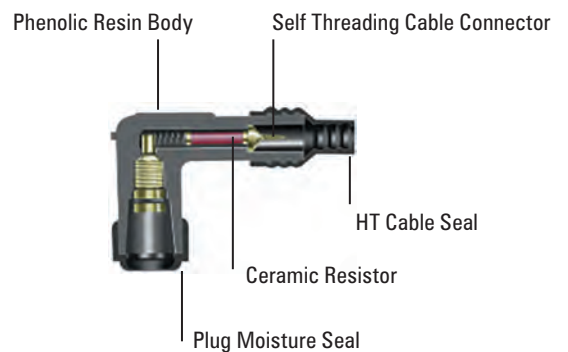
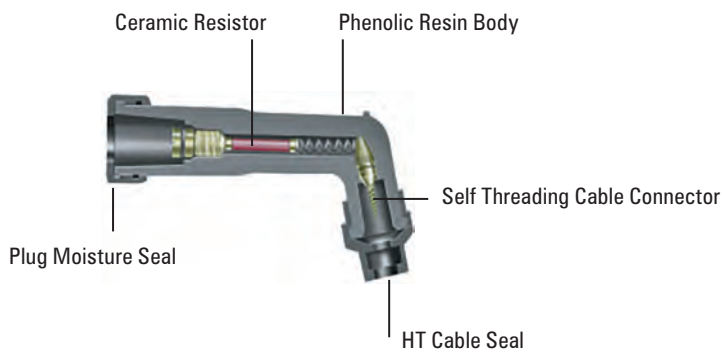

PLUG COVER SUPERSESSIONS

Original Part No.	Stock Number	replaced by	Replacement Part No.	Stock Number
LB05E (red)	8898	→	LB05E-R	8898
LB05EH (red)	8688	→	LB05EH-R	8688
LB05EMH (red)	8160	→	LB05EMH-R	8160
LB05F (red)	8854	→	LB05F-R	8854
LB10EHF (red)	8058	→	LB10EHF-R	8058
LBER (blue)	8308	→	LBER-B	8308
LBER (red)	8307	→	LBER-R	8307
LD05F (red)	8231	→	LD05F-R	8231
SB05F (red)	8567	→	SB05F-R	8567
SD05F (red)	8238	→	SD05F-R	8238
SD05FM (red)	8673	→	SD05FM-R	8673
TRS1225	8787	→	TRS1225-B	8787
TRS1408F	8871	→	TRS1408F-B	8871
TRS1409	8733	→	TRS1408F-B	8871
VB05F (red)	8759	→	VB05F-R	8759
VD05F (red)	8376	→	VD05F-R	8376
XB05F (red)	8592	→	XB05F-R	8592
XD05F (red)	8768	→	XD05F-R	8768
YB05F (red)	8162	→	YB05F-R	8162

To assist in identifying the red or blue coloured variant for popular plug covers a small change to the descriptive part number has been instigated. There is no change to the Stock Number. Black covers which are considered standard are unaffected.

SPARK PLUG COVERS

Part No.	Stock No.	Colour	Resistor	Ø Plug	Terminal Type
LB05E	8031	Black	5 kΩ	14mm	
LB05E-R	8898	Red	5 kΩ	14mm	
LB05F	8051	Black	5 kΩ	14mm	
LB05F-R	8854	Red	5 kΩ	14mm	
LB10F-CS	8961	Black	10 kΩ	14mm	

Description: 90° Elbow Type Material: Phenolic Resin

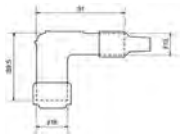

Part No.	Stock No.	Colour	Resistor	Ø Plug	Terminal Type
LZFH	8710	Black	None	10 - 14mm	

Description: 90° Non-resistor type Material: Phenolic Resin

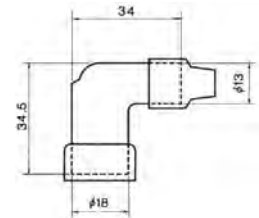

Part No.	Stock No.	Colour	Resistor	Ø Plug	Terminal Type
LB05EH	8334	Black	5 kΩ	14mm	
LB05EH-R	8688	Red	5 kΩ	14mm	
LB10EHF	8055	Black	10 kΩ	14mm	
LB10EHF-R	8058	Red	10 kΩ	14mm	

Description: 90° Elbow Type Material: Phenolic Resin

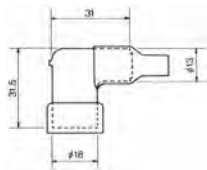

Part No.	Stock No.	Colour	Resistor	Ø Plug	Terminal Type
LB05EMH	8338	Black	5 kΩ	14mm	
LB05EMH-R	8160	Red	5 kΩ	14mm	

Description: 90° Rubber Sheathed Material: EPDM Rubber

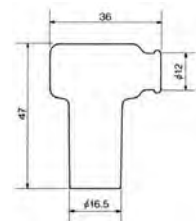

Part No.	Stock No.	Colour	Resistor	Ø Plug	Terminal Type
LD05F	8060	Black	5 kΩ	10 - 12mm	
LD05F-R	8231	Red	5 kΩ	10 - 12mm	

Description: 90° Elbow Type Material: Phenolic Resin

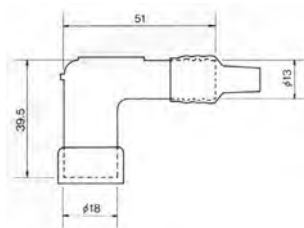

Part No.	Stock No.	Colour	Resistor	Ø Plug	Terminal Type
SB05E	8374	Black	5 kΩ	14mm	
SB05EC	8511	Red	5 kΩ	14mm	
SB05F	8080	Black	5 kΩ	14mm	
SB05F-R	8567	Red	5 kΩ	14mm	
SD05F	8022	Black	5 kΩ	10 - 12mm	
SD05F-R	8238	Red	5 kΩ	10 - 12mm	

Description: Straight Type Material: Phenolic Resin

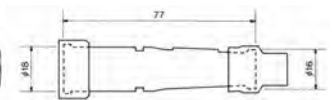

Part No.	Stock No.	Colour	Resistor	Ø Plug	Terminal Type
SD05FM	8392	Black	5 kΩ	10 - 12mm	
SD05FM-R	8673	Red	5 kΩ	10 - 12mm	

Description: Straight Rubber Sheathed Material: EPDM Rubber

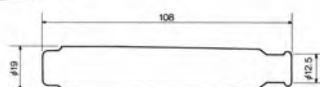

Part No.	Stock No.	Colour	Resistor	Ø Plug	Terminal Type
TB05EMA	8636	Black	5 kΩ	14mm	

Description: 90° Rubber Sheathed Material: Silicon Rubber

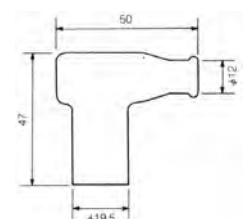

SPARK PLUG COVERS

Part No.	Stock No.	Colour	Resistor	Ø Plug	Terminal Type
XB05F	8062	Black	5 kΩ	14mm	
XB05F-R	8592	Red	5 kΩ	14mm	
XD05F	8072	Black	5 kΩ	10 - 12mm	
XD05F-R	8768	Red	5 kΩ	10 - 12mm	

Description: 102° Elbow Type Material: Phenolic Resin



Part No.	Stock No.	Colour	Resistor	Ø Plug	Terminal Type
VB05F	8032	Black	5 kΩ	14mm	
VB05F-R	8759	Red	5 kΩ	14mm	
VD05F	8052	Black	5 kΩ	10 - 12mm	
VD05F-R	8376	Red	5 kΩ	10 - 12mm	
VD05EG	5817	Black	5 kΩ	10 - 12mm	

Description: 120° Elbow (Long) Type Material: Phenolic Resin



Part No.	Stock No.	Colour	Resistor	Ø Plug	Terminal Type
YB05F	8082	Black	5 kΩ	14mm	
YB05F-R	33169	Red	5 kΩ	14mm	

Description: 120° Elbow (Short) Type Material: Phenolic Resin



Part No.	Stock No.	Colour	Resistor	Ø Plug	Terminal Type
LBER-R	8307	Red	None	14mm	
LBER-B	8308	Blue	None	14mm	

Description: 90° Rubber Sheathed Material: Silicon Rubber

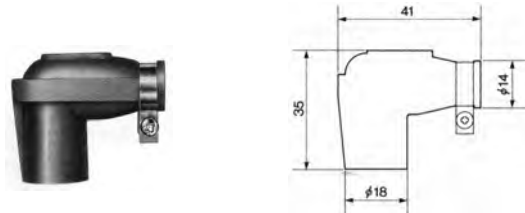

Part No.	Stock No.	Colour	Resistor	Ø Plug	Terminal Type
TRS1225-B	8787	Blue	5 kΩ	14mm	Special*

Description: 90° Compact Type Material: Silicon Rubber

**Suitable for use with R6120- racing spark plugs only*
**Suitable for use with R7282- racing spark plugs only*

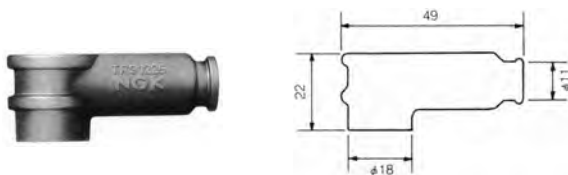

Part No.	Stock No.	Colour	Resistor	Ø Plug	Terminal Type
TRS1408F-B	8871	Blue	5 kΩ	14mm	Special*

Description: 90° Compact Type Material: Silicon Rubber

**Suitable for use with R5300A- racing spark plugs only*

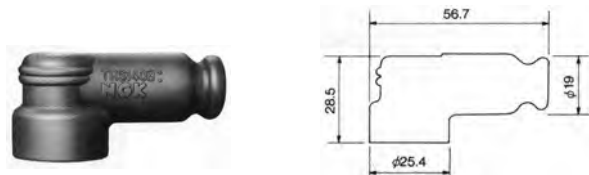

Part No.	Stock No.	Colour	Resistor	Ø Plug	Terminal Type
TRS1409-R	8733	Red	None	14mm	

Description: 90° Compact Type Material: Silicon Rubber

**Suitable for use with R5540F- racing spark plugs only*

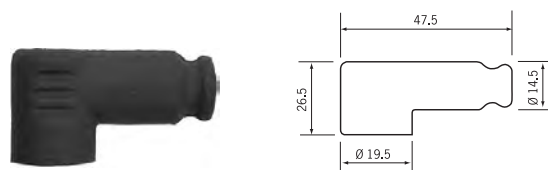

Part No.	Stock No.	Colour	Resistor	Ø Plug	Terminal Type
SD05EG	5818	Black	5 kΩ	10 - 12mm	

Description: Straight Type Material: Phenolic Resin



SPARK PLUG COVERS

Part No.	Stock No.	Colour	Resistor	Ø Plug	Terminal Type
L05EA	6667	Black	5 kΩ	14mm	

Description: 90° Elbow Type Material: Phenolic Resin

Application: Piaggio (various 125, 150cc)

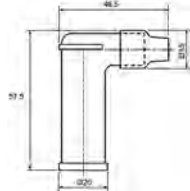

Part No.	Stock No.	Colour	Resistor	Ø Plug	Terminal Type
V05E	6665	Black	5 kΩ	14mm	

Description: 120° Elbow (Long) Type Material: Phenolic Resin

Application: Piaggio (various 125, 150cc)

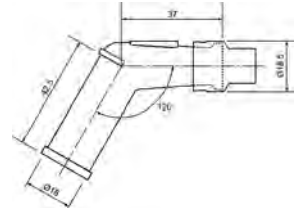

Part No.	Stock No.	Colour	Resistor	Ø Plug	Terminal Type
LB05EPK	8342	Black	5 kΩ	14mm	

Description: 90° Elbow Type Material: Phenolic Resin

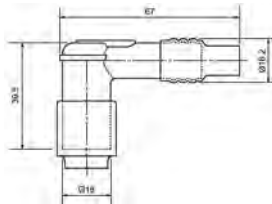

Part No.	Stock No.	Colour	Resistor	Ø Plug	Terminal Type
VD05EM	8422	Black	5 kΩ	10 - 12mm	

Description: 120° Elbow (Long) Type Material: EPDM Rubber

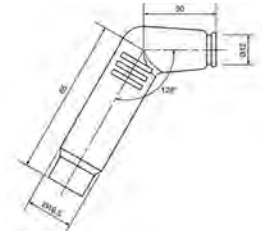

Part No.	Stock No.	Colour	Resistor	Ø Plug	Terminal Type
LB05EZ	8744	Black	5 kΩ	14mm	

Description: 90° Elbow Type Material: Phenolic Resin

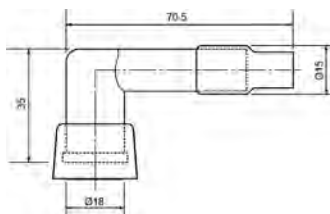

Part No.	Stock No.	Colour	Resistor	Ø Plug	Terminal Type
VD05EMH	7744	Black	5 kΩ	10 - 12mm	
VD05FMH	8425	Black	5 kΩ	10 - 12mm	

Description: 120° Elbow (Compact) Type Material: EPDM Rubber

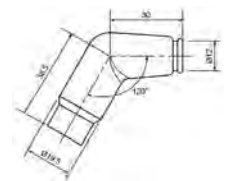

Part No.	Stock No.	Colour	Resistor	Ø Plug	Terminal Type
SD05FP	8325	Black	5 kΩ	10 - 12mm	

Description: Straight Type Material: Phenolic Resin

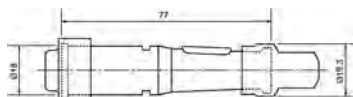

Part No.	Stock No.	Colour	Resistor	Ø Plug	Terminal Type
SD05FGA	8683	Black	5 kΩ	10 - 12mm	

Description: Straight with Grommet Material: Phenolic Resin

Application: Honda VT600, XL600

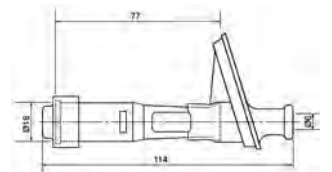

NTK LAMBDA SENSORS FOR MOTORCYCLES

Reducing the pollution created by the internal combustion engine is a great concern for us all. To ensure that manufacturers build cleaner engines, the allowable limits for certain polluting gases are set by various government bodies. These limits are getting ever tighter and engine designers are under great pressure to find ways of meeting the targets. A vital part of the pollution control used on many engines is the exhaust gas oxygen sensor - more commonly known as the Lambda sensor. Commonplace on cars since the 1990's, Lambda sensors have been used on motorcycles since 1999 and are now fitted to an increasing number of machines over 125cc.

WHAT DOES THE LAMBDA SENSOR DO?

The most popular method used by vehicle manufacturers to reduce engine emissions is the three-way catalyst (catalytic converter). This device has the ability to take the three main toxic gases produced by an engine which are carbon monoxide (CO), oxides of nitrogen (NO_x) and hydrocarbons (HC) and convert them to considerably less harmful, non-poisonous gases: carbon dioxide (CO₂), water (H₂O) and nitrogen (N₂).

To carry out this conversion of gases efficiently the catalyst must operate within a specified temperature range but also be provided with exhaust gases that are within certain very tight tolerances dependant predominantly on air/fuel ratio. The precise control required to operate this system is provided by the use of an exhaust gas oxygen (Lambda) sensor installed upstream of the catalyst. A Lambda sensor has the ability to precisely measure the residual oxygen present in exhaust gases. By sending a signal to the control unit it can initiate a change to keep the fuelling system operating within the very tight tolerances required. This is known as a closed-loop control system.

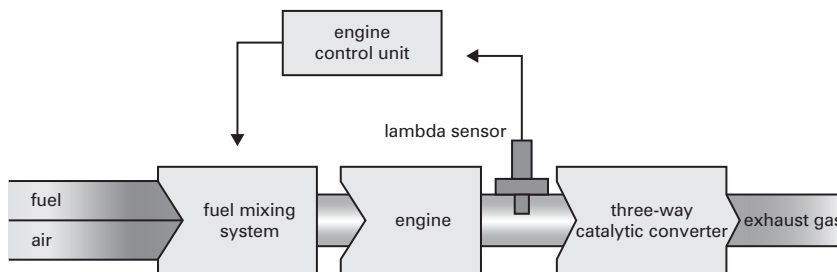

A worn or damaged sensor may affect the bike's general performance, increase fuel consumption, increase unwanted emissions and even damage the catalyst.

TECHNICAL INFORMATION

TORQUE FIGURES

Torque figures and thread form information:
M18 x 1.5 mm - 35 ~ 45Nm **M12 x 1.25 mm - 18 ~ 23Nm**

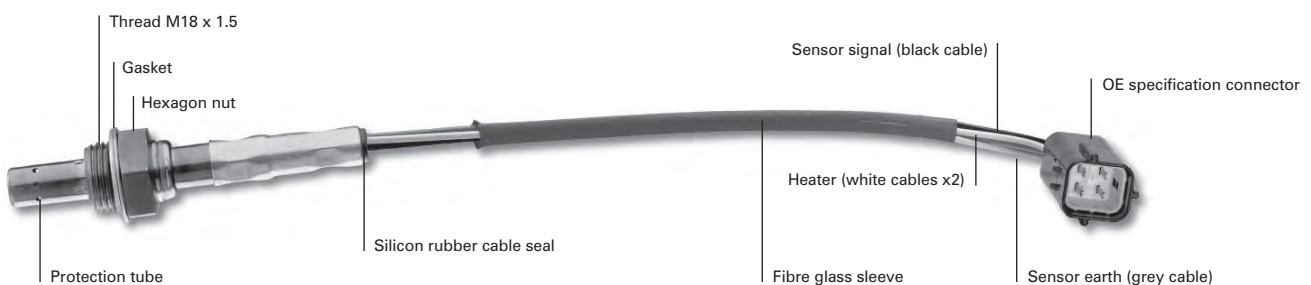

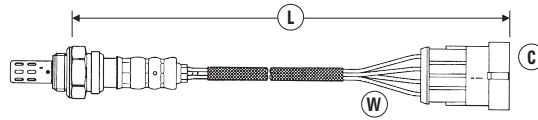

W = Number of Wires

C = Connector Type (see page 123)

L = Length of Sensor and lead (mm)

CC/MODEL	ENGINE	OE-NO.	DATE	W	C	L	NTK PART NO.	STOCK NO.
APRILIA								
1000								
RSV 1000 R	Rotax V2	A2 C 53025886	04.04→	4	31	590	OZA591-SZ1	1767
RSV 1000 R Factory	Rotax V2	A2 C 53025886	10.03→	4	31	590	OZA591-SZ1	1767
ETV 1000 Caponord		AP8127295	04→07	4	33	890	OZA222-SG2	0034
BMW								
650								
F650CS		11787 685 320	11.01→12.03	4	68	341	OZA630-BM3	0074
F650CS	K14/02	11787 685 320	01.04→12.05	4	68	341	OZA630-BM3	0074
F650GS/GS Dakar		11787 685 320	09.99→12.03	4	68	341	OZA630-BM3	0074
F650GS/GS Dakar	R13Mü	11787 685 320	12.03→11.07	4	68	341	OZA630-BM3	0074
G650 Xchallenge, Xcountry, Xmoto	K15	11787 674 452	07→09	4	99	231	OZA630-BM1	0072
800								
F650GS/GS Dakar		11787 672 785	11.07→	4	99	521	OZA630-BM2	0073
F800GS	K72	11787 672 785	11.07→	4	99	521	OZA630-BM2	0073
F800R	K73	11787 672 785	05.09→	4	99	521	OZA630-BM2	0073
F800S/ST	K71	11787 672 785	12.05→	4	99	521	OZA630-BM2	0073
850								
R850R	R28	11787 671 756	07.02→08.05	4	69	922	OZA522-BM1	0053
R850RT	R22	11787 671 756	03.01→12.04	4	69	922	OZA522-BM1	0053
1085								
R1100S	259S	11787 671 756	01.03→12.03	4	69	922	OZA522-BM1	0053
1150								
R1150GS	R21	11787 671 756	11.01→12.03	4	69	922	OZA522-BM1	0053
R1150GS Adventure	R21	11787 671 756	11.01→09.06	4	69	922	OZA522-BM1	0053
R1150R	R28	11787 671 756	10.02→08.05	4	69	922	OZA522-BM1	0053
R1150RS/RT	R22	11787 671 756	03.01→12.04	4	69	922	OZA522-BM1	0053
1170								
HP2 Enduro	K25 HP	11787 674 452	12.05→11.08	4	99	231	OZA630-BM1	0072
HP2 Megamoto	K25 HP	11787 674 452	07→08	4	99	231	OZA630-BM1	0072
HP2 Sport	K29 HP	11787 672 785	08→	4	99	521	OZA630-BM2	0073
1200								
K1200GT	K41GT	11787 671 756	11.02→08.05	4	69	922	OZA522-BM1	0053
K1200GT	K44	11787 672 785	12.05→	4	99	521	OZA630-BM2	0073
K1200R	K43	11787 672 785	03.05→	4	99	521	OZA630-BM2	0073
K1200R Sport	K43	11787 672 785	11.07→	4	99	521	OZA630-BM2	0073
K1200S	K40	11787 672 785	06.04→	4	99	521	OZA630-BM2	0073
K1200LT	K589	11787 671 757	01.04→	4	69	554	OZA522-BM2	0054
K1200RS	K41	11787 671 756	01.01→12.04	4	69	922	OZA522-BM1	0053
R1200C/CL	259C/K30	11787 671 756	02.02→12.04	4	69	922	OZA522-BM1	0053
R1200GS	K25	11787 674 452	11.03→09	4	99	231	OZA630-BM1	0072
R1200RT	K26	11787 674 452	10.04→09	4	99	231	OZA630-BM1	0072
R1200S	K29	11787 674 452	10.05→07	4	99	231	OZA630-BM1	0072
R1200ST	K28	11787 674 452	12.04→11.07	4	99	231	OZA630-BM1	0072
1300								
K1300GT	K44	11787 672 785	09→	4	99	521	OZA630-BM2	0073
K1300R	K43	11787 672 785	09→	4	99	521	OZA630-BM2	0073
K1300S	K40	11787 672 785	09→	4	99	521	OZA630-BM2	0073

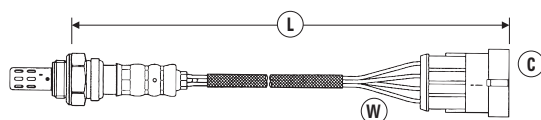

(W) = Number of Wires
 (C) = Connector Type (see page 123)
 (L) = Length of Sensor and lead (mm)

CC/MODEL	ENGINE	OE-NO.	DATE	(W)	(C)	(L)	NTK PART NO.	STOCK NO.
DUCATI								
695								
Monster 695		CA.0083 476	06.04→	4	40	880	OZA591-BB3	0066
992								
GT 1000		CA.0083 476	01.06→	4	40	880	OZA591-BB3	0066
Monster S2R 1000		CA.0083 476	01.06→	4	40	880	OZA591-BB3	0066
Paul Smart 1000		CA.0083 476	01.06→	4	40	880	OZA591-BB3	0066
ST3, ST3S		CA.0083 476	01.04→	4	40	880	OZA591-BB3	0066
Sport 1000		CA.0083 476	01.06→	4	40	880	OZA591-BB3	0066
998								
Monster S4RS		CA.0083 476	06.04→	4	40	880	OZA591-BB3	0066
HONDA								
125								
FES125 Pantheon		36531-KRJ-9010-M1	01.05→	4	96	280	OZA577-H6	0065
PS125i		36531-KTF-6412-M1	01.06→	4	96	210	OZA577-H15	0064
SH125i		36531-KTF-6412-M1	01.05→	4	96	210	OZA577-H15	0064
150								
FES150i Pantheon		36531-KRJ-9010-M1	01.05→	4	96	280	OZA577-H6	0065
1000								
CBF1000		36531-MFA-D010-M1	01.06→	4	80	990	OZA577-H17	0007
HUSQVARNA								
450								
TE450		E 252 201	09.07→	4	97	410	OZA591-WB1	0010
SM450R		E 252 201	09.07→	4	97	410	OZA591-WB1	0010
510								
SM510R		E 252 201	09.07→	4	97	410	OZA591-WB1	0010
610								
SM610		E 252 201	10.06→	4	97	410	OZA591-WB1	0010
650								
TR650 Strada		7674452	10.12→	4	99	231	OZA630-BM1	0072
TR650 Terra		7674452	10.12→	4	99	231	OZA630-BM1	0072
HYOSUNG								
647								
GT650i			01.08→	4	97	410	OZA591-WB1	0010
KTM								
999								
990 Adventure / S		1614 833 0000	01.06→	4	97	500	OZA591-VB2	0009
990 Superduke		1614 833 0000	01.06→	4	97	500	OZA591-VB2	0009
KYMCO								
200								
Yager 200i		3160-0361	06.06→	4	31	590	OZA591-YB1	0011
250								
Venox 250 Afi		3160-0361	06.06→	4	31	590	OZA591-YB1	0011
Xciting 250i		3160-0361	06.06→	4	31	590	OZA591-YB1	0011

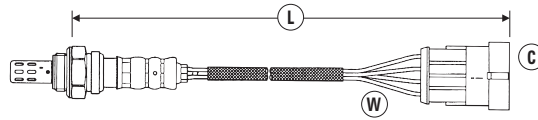

W = Number of Wires
C = Connector Type (see page 123)
L = Length of Sensor and lead (mm)

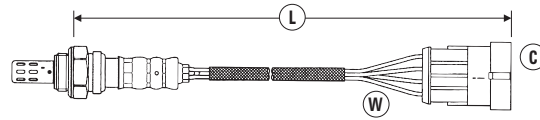

CC/MODEL	ENGINE	OE-NO.	DATE	W	C	L	NTK PART NO.	STOCK NO.
MOTO GUZZI								
750								
Breva V750 i.e.		CA.0083477.A	01.03→	4	40	310	OZA591-BB2	1710
Nevada V750 i.e.		CA.0083477.A	01.06→	4	40	310	OZA591-BB2	1710
877								
Breva V850 i.e.		CA.0083477.A	01.06→	4	40	310	OZA591-BB2	1710
Griso V850 i.e.		CA.0083477.A	01.06→	4	40	310	OZA591-BB2	1710
Norge V850 i.e.		CA.0083477.A	01.06→	4	40	310	OZA591-BB2	1710
1100								
Breva V 1100		CA.0019 265	03.04→12.05	4	40	310	OZA341-BB1	0036
Breva V 1100 i.e.		CA.0083477.A	01.06→	4	40	310	OZA591-BB2	1710
California		CA.0019 265	03.04→12.05	4	40	310	OZA341-BB1	0036
California		CA.0083477.A	01.06→	4	40	310	OZA591-BB2	1710
Griso V 1100 i.e.		CA.0083477.A	01.06→	4	40	310	OZA591-BB2	1710
V11 Models		CA.0019 265	03.04→12.05	4	40	310	OZA341-BB1	0036
1150								
Norge 1200		CA.0083477.A	01.06→12.08	4	40	310	OZA591-BB2	1710
Sport V 1200		CA.0083477.A	01.06→12.08	4	40	310	OZA591-BB2	1710
Stelvio 1200 4V		CA.0083477.A	01.06→12.10	4	40	310	OZA591-BB2	1710
MOTO MORINI								
1187								
9½		CA.0083477.A	01.06→	4	40	310	OZA591-BB2	1710
Corsaro		CA.0083477.A	01.06→	4	40	310	OZA591-BB2	1710
MV AGUSTA								
910								
F4 Brutale 910		CA.0083477.A	10.06→12.08	4	40	310	OZA591-BB2	1710
989								
Brutale 989		CA.0083477.A	01.09→	4	40	310	OZA591-BB2	1710
998								
F4 1000R		CA.0083477.A	10.06→12.08	4	40	310	OZA591-BB2	1710
1078								
Brutale 1078 RR		CA.0083477.A	01.09→	4	40	310	OZA591-BB2	1710
F4 1000		CA.0083477.A	07.07→12.08	4	40	310	OZA591-BB2	1710
F4 1078R		CA.0083477.A	01.09→	4	40	310	OZA591-BB2	1710
SUZUKI								
600								
GSR600		18213-01H00	01.07→12.10	4	80	690	OZA448-J4	0003
GSX-R600		18213-01H00	03.06→12.07	4	80	690	OZA448-J4	0003
750								
GSX-R750		18213-01H00	03.06→12.07	4	80	690	OZA448-J4	0003
1800								
VZR1800 K6 M1800R Intruder		18213-48G00	04.06→	4	80	370	OZA448-J5	0004



(W) = Number of Wires
 (C) = Connector Type (see page 123)
 (L) = Length of Sensor and lead (mm)

CC/MODEL	ENGINE	OE-NO.	DATE	(W)	(C)	(L)	NTK PART NO.	STOCK NO.
TRIUMPH								
600								
Daytona 600		22 01 347	01.03→12.05	4	97	640	OZA591-UB1	0067
Speed Four		22 01 347	01.02→	4	97	640	OZA591-UB1	0067
885								
Thunderbird Sport		22 01 347	01.03→12.04	4	97	640	OZA591-UB1	0067
955								
Daytona 955i		22 01 347	01.01→	4	97	640	OZA591-UB1	0067
Speed Triple		22 01 347	01.01→12.05	4	97	640	OZA591-UB1	0067
Sprint RS		22 01 347	01.01→12.04	4	97	640	OZA591-UB1	0067
Sprint ST		22 01 347	01.01→12.04	4	97	640	OZA591-UB1	0067
Tiger		22 01 347	01.03→	4	97	640	OZA591-UB1	0067
1050								
Sprint ST		22 01 347	01.05→	4	97	640	OZA591-UB1	0067
Speed Triple		22 01 347	01.06→12.07	4	97	640	OZA591-UB1	0067
1600								
Thunderbird			07.09→	4	80	250	AZD0101-VB004	7690
2300								
Rocket III		22 01 247	01.04→	4	97	535	OZA591-UB2	0008
Rocket III Classic		22 01 247	01.06→	4	97	535	OZA591-UB2	0008

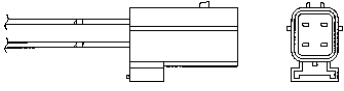
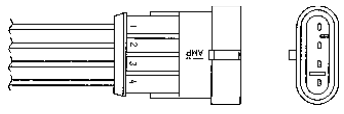
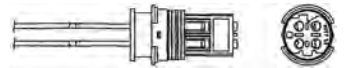
CONNECTOR TYPES

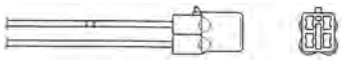
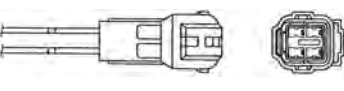
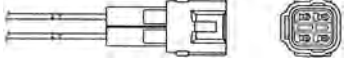
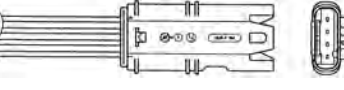
31		OZA591-YB1	0011
		OZA591-SZ1	1767
33		OZA222-SG2	0034
40		OZA341-BB1	0036
68		OZA447-E28	0427
		OZA630-BM3	0074
69		OZA522-BM1	0053
		OZA522-BM2	0054
80		OZA448-J4	0003
		OZA448-J5	0004
		OZA577-H17	0007
		AZD0101-VB004	7690
96		OZA577-H15	0064
		OZA577-H6	0065
97		OZA591-UB1	0067
		OZA591-UB2	0008
		OZA591-VB2	0009
99		OZA630-BM2	0073



IGNITION PARTS

As the world's No.1 OE manufacturer of spark plugs and the pioneers of copper core technology, trust NGK to deliver optimum performance whatever bike you ride.

- Perfect Ignition ■ Better cold weather starting ■ Better engine performance
- More complete combustion ■ Better emissions and cleaner exhaust
- Wider heat range over all conditions

CORRUGATIONS
To prevent flash over

SPECIAL PACKING
Excellent air tightness
Robust construction

INSULATOR
Made of high purity alumina providing better heat dissipation, higher electrical insulation and stronger thermal shock resistance

METAL SHELL
Plated and chromated to guard against corrosion

COPPER CORE

Deeply inserted in the centre electrode for improved thermal conductivity. Providing an ultra wide heat range plug that gives maximum performance at both high and low speeds

CENTRE & GROUND ELECTRODES

Special nickel alloy ensures superior resistance and durability

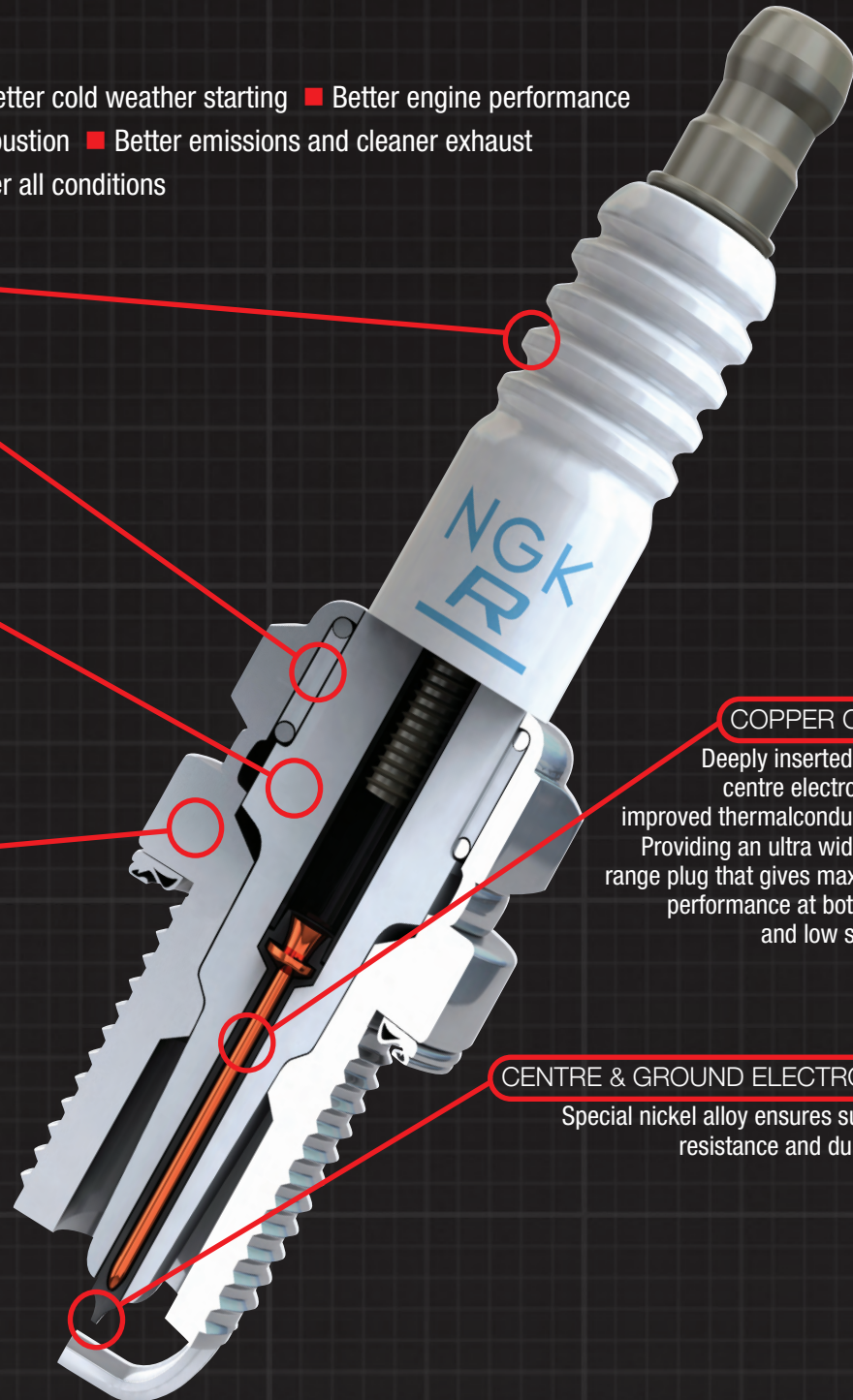

ORIGINAL EQUIPMENT SUPPLIERS TO:-

Aprilia BMW CCM Cagiva Derbi Ducati Gas Gas Honda Husqvarna
 Indian Kawasaki KTM Moto Guzzi Norton Peugeot Polaris Royal Enfield
 Scorpa Suzuki SMC TGB Triumph Victory Yamaha

ngkntk.co.uk

THE NO.1 CHOICE THE WORLD OVER



NGK Spark Plugs (UK) Limited
Maylands Avenue
Hemel Hempstead
Hertfordshire
HP2 4SD

Tel: 01442 281000
Fax: 01442 281001



IGNITION
PARTS

www.ngkntk.co.uk