

Kim Dawson

(503) 824-5888

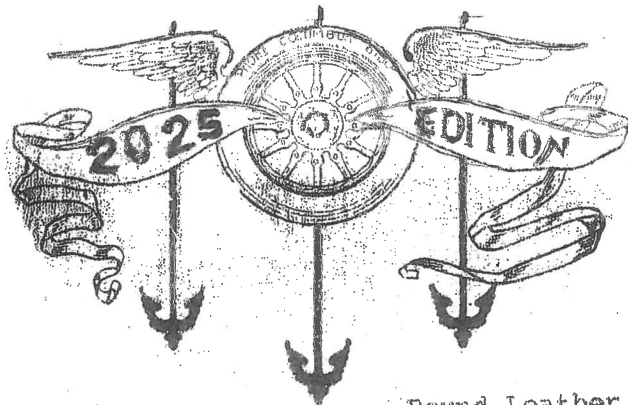

Authentic Parts
and Accessories

Round Leather
Top Stay Straps

Leather Straps and Parts
Made to Order

30688 S. MARIAN ST.
MOLALLA, OR 97038

In offering this catalog to the restorer, we have ventured to select and reproduce parts that are hard to find, and leather craftsmanship of exceptional quality. If you don't find an item you need in our catalog, please ask and we may make it or locate it for you. Let us make your top our top priority.

ORDERING:

This is a mail order business. You are welcome to stop by. Please call first. When ordering, please use part numbers and or description. List year and model of car. Include the appropriate information sheet for leather parts.

SHIPPING & HANDLING:

If your domestic order will fit in a flate rate Priority Mail Box, the cost should be no more than \$25. Longer, heavier parts usually adds more to the shipping cost. Minimun shipping charge is \$11. Foreign orders allow for higher shipping charges.

SHIPPING ADDRESS:

Please make sure your street address is on the order., although most orders will be sent USPS Priority Mail.

TERMS OF PAYMENT:

Include full payment plus shipping charge in your check or money order. Checks can be made out to Kim Dawson or Antique Auto Top Hardware Company. If you have a special order or unsure of calculating price, send order and I'll figure the cost.

PRICES:

I will try to maintain prices in this catalog, but I reserve the right to change prices whenever my cost of supplies increases.

DELIVERY TIME:

Hardware orders usually completed and shipped right away. Leather orders usually take a few days. Please don't wait until you need it yesterday. All orders completed promptly.

Authentic style top hardware and round leather top stay straps are our specialties. Most parts are made using the investment casting (lost wax) process.

DISCONNECT LINK WITH FOOTMAN, LOOP

Part No. 101
Overall length 3"
For 1" strap

Mounts on front of front top bow allowing quick, easy removal of top stay straps when top is folded. Release lower end of strap, turn link 90 degrees, and slide the link off of one side of the footman loop.

Bronze

Link/Loop Set (one link, one loop)

\$40

Note about Disconnect Link/Loop: Original parts were cast in iron with a tensile strength of 54,000 psi. These parts are cast in silicon bronze with a tensile strength of 55-65,000 psi.

FRAME BRACKET

Part No. 103
Overall length 2½"
Mounts on frame
Has ½" eye
Brass



\$20

SNAP LOOP

Part No. 207
Overall length 2½"
Mounts on front top bow or on frame.
Has ½" eye
Brass

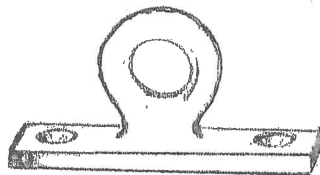

\$20

HD SNAP LOOP

Part No. 206
Overall length 2"
Width 1½"
Oval eye ¾" x 9/16"
Mounts on frame or bow.
Takes #10 screws
Brass

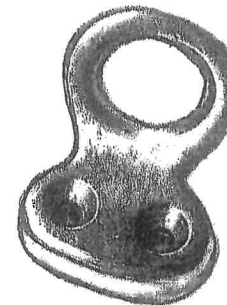

\$20

BACK STAY LOOP

Part No. 133
Overall width 2"
Mounts on back of body with #10 screws.
For 1" strap
Brass

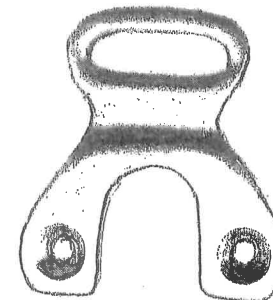

\$20

DOUBLE STRAP LOOP

Part No. 150
Overall length 2 ¾"
For two 1" straps
Mounts on back of body on each side for back stay straps.
Uses #12 screw
Brass

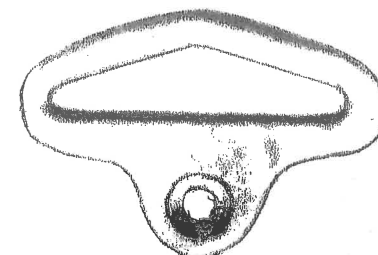

\$22

3-HOLE FOOTMAN LOOP

Part No. 169
Overall length 3"
Width 1½"
For 1¼" or 1½" strap
Use as hood strap bracket, door strap loop, or on step board.
Brass

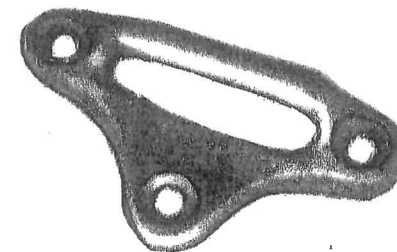

\$22

5

BOLT MOUNT STRAP LOOP

Part No. 111
 For 1" strap
 Takes $\frac{1}{4}$ " carriage bolt
 or countersunk screw.
 Mounts on front or rear bow
 or on body or frame.
 Brass

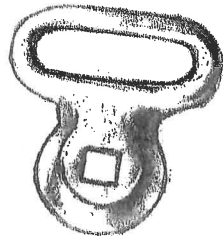

\$20

BOW BRACKET

Part No. 104
 Overall length 2 $\frac{5}{8}$ "
 For 1", 1 $\frac{1}{8}$ ", or
 1 $\frac{1}{4}$ " strap.
 Mounts on front or rear
 bow, or on step board.
 Brass



\$22

HOOD STRAP BRACKET

Part No. 105
 Overall length 2 $\frac{3}{4}$ "
 For $1\frac{1}{2}$ " strap
 Mounts on frame beside hood
 Brass

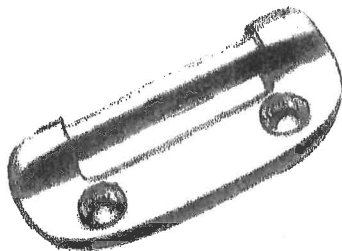

\$25

HOOD STRAP SPRING

Part No. 501
 Overall length 3 $\frac{5}{8}$ "
 For $1\frac{1}{2}$ " strap
 Stainless Steel
 Each

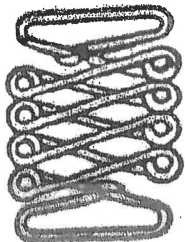

\$30

BRASS WING NUT

Part No. 128
 Width 1 $\frac{5}{8}$ ", height $\frac{7}{8}$ "
 Base $\frac{3}{4}$ " diameter.
 You drill & tap to $\frac{7}{16}$ " maximum.
 Each

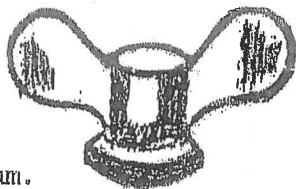

\$18

WS ROD LOWER SUPPORT BRACKET

Part No. 218
 Overall length 1 $\frac{7}{16}$ "
 $\frac{3}{8}$ " Hole
 $\frac{3}{16}$ " thick tongue
 Can use with No. 163
 Variable mounting bracket
 Brass
 Each

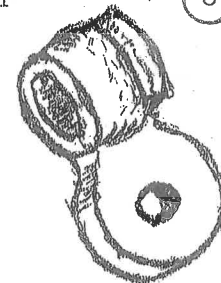

\$20

WS ROD UPPER SUPPORT BRACKET

Part No. 219
 Overall Length 1 $\frac{3}{4}$ "
 Width $\frac{7}{8}$ "
 Large opening $\frac{1}{2}$ "-
 Hole $\frac{3}{8}$ "
 Boss for set screw
 Brass
 Each

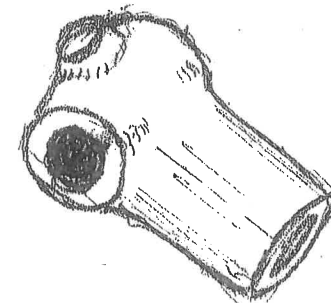

\$24

CHECK STRAP BRACKET

Part No. 187
 Width 1"
 Height 1 $\frac{5}{8}$ "
 For 1 $\frac{3}{8}$ " strap or
 1 $\frac{1}{4}$ " strap wrapped
 with Upholstery leather.
 Cast Brass
 Each

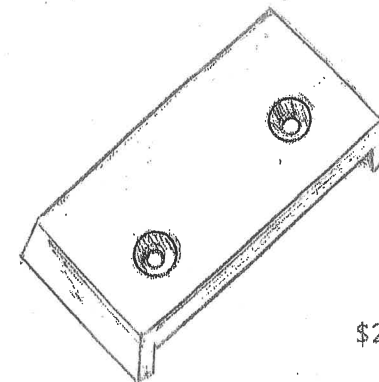

\$24

OFFSET DOOR STRAP LOOP

Part No. 124
 Overall Length 2 $\frac{1}{4}$ "
 For $1\frac{1}{4}$ " to $1\frac{1}{2}$ " strap
 Various uses
 20s & 30s cars
 Takes #12 screws
 Brass
 Each

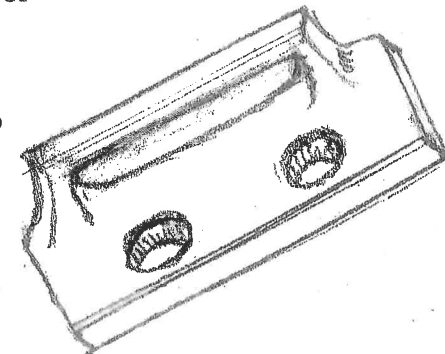

\$24

6

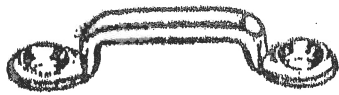

For 1" strap, overall length 2 5/8"

NICKEL Plated Steel For 1" Strap
Part No. 630 Each \$5

STAINLESS STEEL For 1" Strap
Part No. 631 Each \$5

PAINTED BLACK For 1" Strap
Part No. 431 Each \$8

For 1 1/4" strap, overall length 2 3/4"

NICKEL Plated Steel For 1 1/4" Strap
Part No. 632 Each \$5

STAINLESS STEEL For 1 1/4" Strap
Part No. 633 Each \$5

PAINTED BLACK For 1 1/4" Strap
Part No. 433 Each \$8

For 1 1/2" strap, overall length 3 1/8"

NICKEL Plated Steel For 1 1/2" Strap
Part No. 634 Each \$5

STAINLESS STEEL For 1 1/2" Strap
Part No. 635 Each \$5

PAINTED BLACK For 1 1/2" Strap
Part No. 435 Each \$8

For 2" strap, Overall length 3 5/8"

ZINC Plated Steel for 2" Strap
Part No. 636 Each \$8

PAINTED BLACK For 2" Strap
Part No. 437 Each \$10

8

DECO DOOR STRAP LOOP

Part No. 123
Overall Length 3"
For 1 1/4" strap
Various uses
20s cars, Buick, etc.
Takes #10 screws
Brass
Each

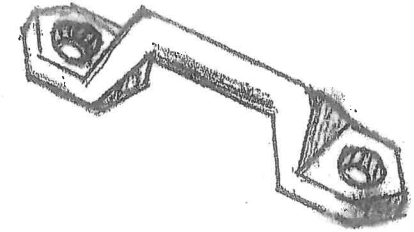

\$22

HD FOOTMAN LOOPS

Part No. 102
Overall length 2 3/4"
For 1" strap
Various uses
Takes #10 screws
Brass

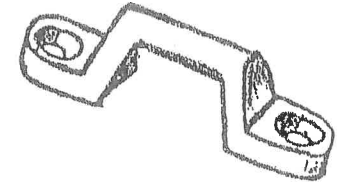

\$20

Part No. 110
Overall length 3"
For 1 1/4" strap
Door straps, hood straps
Various uses
Takes #10 screws
Brass

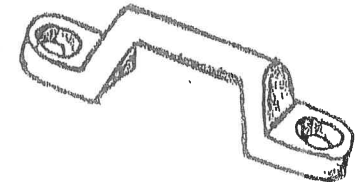

\$20

Part No. 109
Overall length 3 1/4"
For 1 1/2" strap
Door straps, hood straps
Various uses
Takes #10 screws
Brass

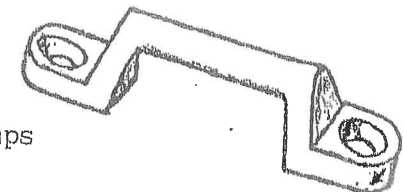

\$22

EARLY FOOTMAN LOOPS

9

Part No. 113
Overall length 2 3/4"
For 1" strap
Mounts on front or rear bow.
Various uses
Takes #10 screws
Brass

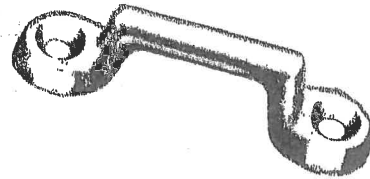

\$20

Part No. 112
Overall length 3"
For 1 1/4" strap
Back stay straps, door
straps, hood straps.
Various uses
Takes #10 screws
Brass

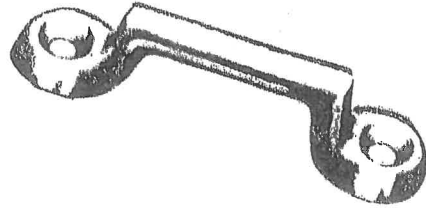

\$20

Part No. 131
Overall length 3 1/4"
For 1 1/2" strap
Various uses
Pierce door strap loop.
Takes #12 screws
Brass

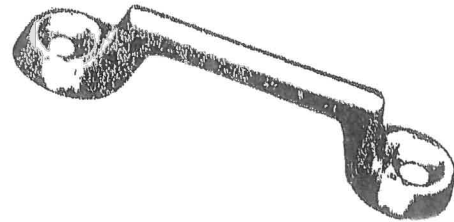

\$22

Part No. 122
Overall length 3 3/4"
For 2" strap
Various uses
Pope door strap loop.
Takes #12 screws
Brass

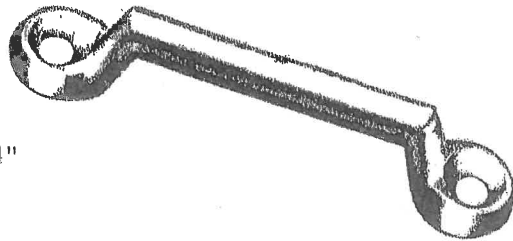

\$25

TOP BOOT STRAP LOOP

10

Part No. 156
Overall length 2 3/4"
For 1" strap
Mounts on back of body
Top boot straps fasten
on loops, 2 or 3 needed
Brass



\$22

HD RUNNING LOOP

Part No. 120
Overall length 2 3/4"
For 1 1/4" strap
Holes not countersunk
Hood straps, trunk straps
Various uses.
Low profile.
Used on Pope hood to
guide hood straps.
Brass

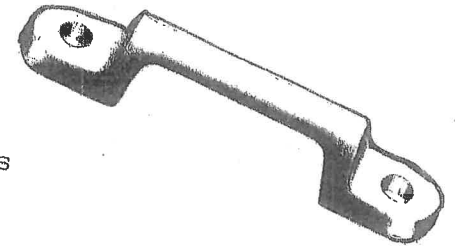

\$22

RUNNING LOOP

Part No. 132
Overall length 3 1/4"
For 1 1/2" strap
Intended to be a guide for
hood straps or trunk straps.
Used on Pierce trunk rack.
Brass

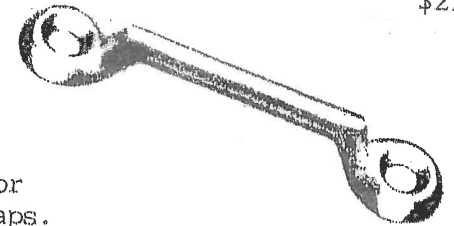

\$22

SMALL FOOTMAN LOOP

Part No. 208
Overall length 2"
For 3/4" strap
Various uses
Takes #6 screws
Polished
Brass

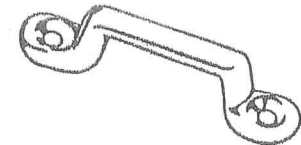

\$8

Part No. 121
Overall length 4 1/2"
For 2" strap
Takes #12 screws
Brass

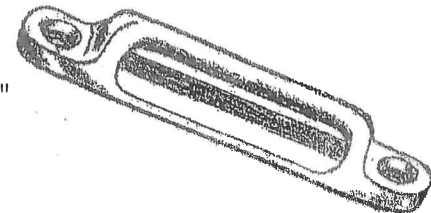

\$30

DOOR STRAP LOOPS

Part No. 108
Overall length 3"
For 1 1/4" strap
Takes #12 screws
Brass



\$22

Part No. 107
Overall length 3 1/4"
For 1 1/2" strap
Takes #12 screws
Brass

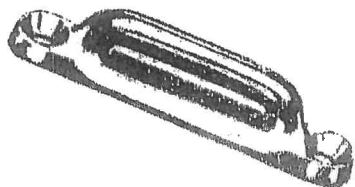

\$24

Beautifully hand stitched for strength and appearance. Black, saddle, or oiled chestnut brown color. Made to your dimensions on your loops or on ours (add cost of loops and \$8 per loop for polishing). There are fourteen different loops in our catalog suitable for door check straps.

STANDARD CHECK STRAP

Price is for leather & labor.

- 1" Wide @ \$32 Each
- 1 1/4" Wide @ \$36 Each
- 1 1/2" Wide @ \$40 Each
- 2" Wide @ \$44 Each

Send us your loops or add the cost of our loops and polishing. State length of check strap (center to center of loop mounting holes when door is in the open position). Mark leather color black, saddle, or oiled chestnut brown.

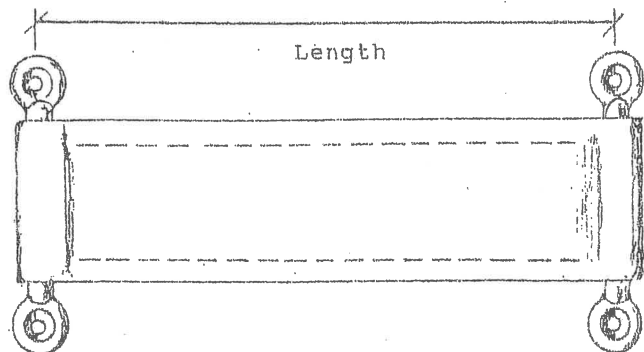

ORDERING YOUR CRANK BOOT/STRAP

On the order form, specify boot style and leather color (black, saddle, oiled brown). State buckle style and finish desired. Also state width of strap (5/8" or 3/4" are typical) and circle crank handle style. To make your crank boot/strap look like it belongs on your car, we need a few measurements. Please fill them in on the order form. The crank strap usually goes around a bracket, around the frame, or through a loop. The "total distance" measurement allows us to make the strap the correct length so you won't have to cut it off. If your strap does go around something large (like the frame), add 2 or 3 inches to the "total distance" measurement.

Crank Handle Styles:



Cylindrical



Curved



Cylindrical with ring

CRANK BOOTS WITH STRAPS

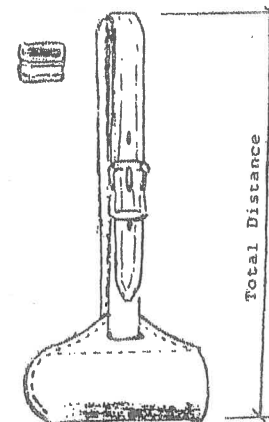

STYLE A
Part No. 450
Curved end

\$100

13

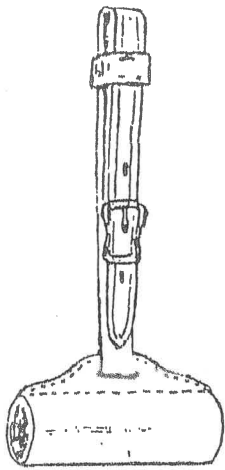

STYLE B
Part No. 451
Open both ends

\$100

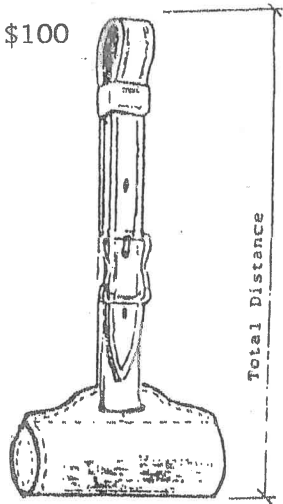

STYLE D
Part No. 453
End stitched in

\$120

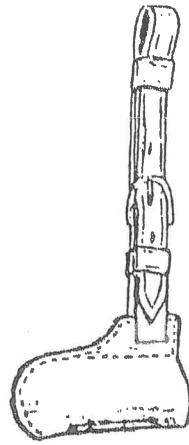

STYLE C
Part No. 452
Curved end with
offset strap

\$110

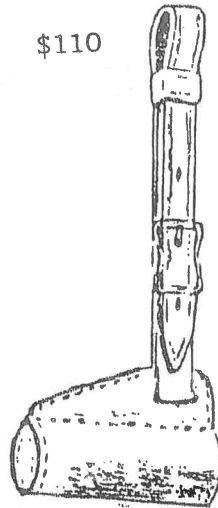

STYLE E
Part No. 454
End stitched in
with offset strap

\$120

14

CRANK BOOT WITH STRAP ORDERING INFORMATION

Boot Style _____

Leather Color _____

Buckle Style _____

Buckle Finish _____

Strap Width _____

My crank handle style is _____

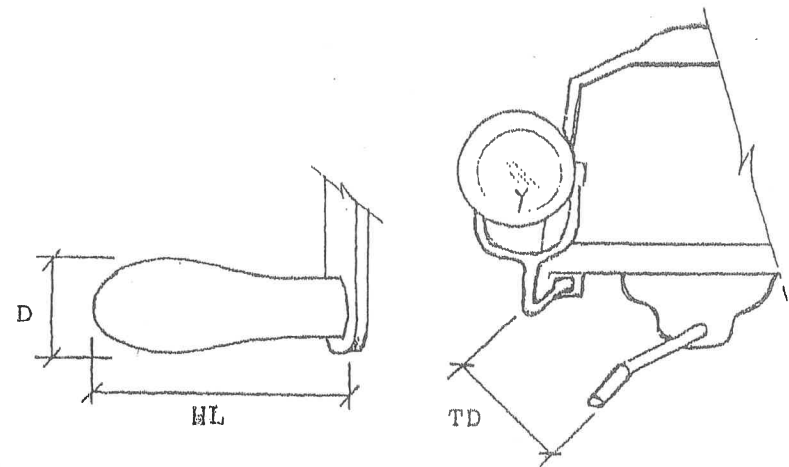

HL (Handle Length) _____

D (Diameter of largest part of handle) _____

TD (Total Distance) _____

To get the "Total Distance", measure from the bottom edge of the handle to the top edge of what the strap will go around with the crank handle positioned where you want it to be. If your strap does go around something large (like the frame), add 2 or 3 inches to the "total distance" measurement.

BOW REST BRACKET

15

Part No. 106
Overall length 3 3/8"
Slot for 3/4" strap
1/2" Hole
With set screw
You drill & tap
Brass
Each

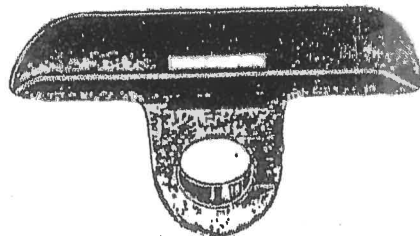

\$60

LEATHER COVERED BOW REST BRACKET

Part No. LC106
Black, saddle or oiled
brown leather.
Polished brass or black painted.
1/2" or 5/8", or 3/4" hole.
Drilled/tapped with set screw.
3/4" strap with your choice of
buckle style.
Hand stitched.
Pair

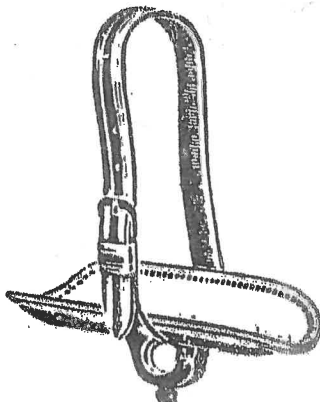

\$220

OFFSET LOOP BOW REST

Part No. 138
Overall length 3 3/4"
Slot for 7/8" strap
5/8" hole
With set screw
You drill & tap
Brass
Each

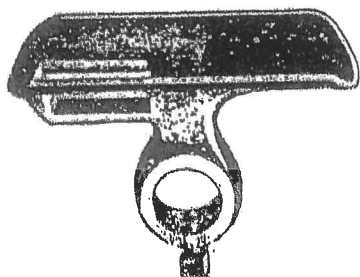

\$65

Part No. LC138
Polished Brass
Leather pad installed
Two 7/8"x24" straps
Drilled & tapped
Black, saddle or oiled brown leather
Pair

\$200

EMCO BOW REST

16

Part No. 139.
Overall length 3 3/4"
Slot for 3/4" strap
5/8" hole
With set screw
You drill & tap
Brass
Each

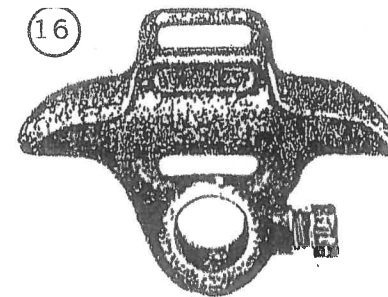

\$70

EMCO BOW REST PADS & STRAPS

Part No. L139
Black, saddle or oiled
chestnut brown leather.
Your choice of buckles.
Two pads & two straps.
Hand stitched
Set

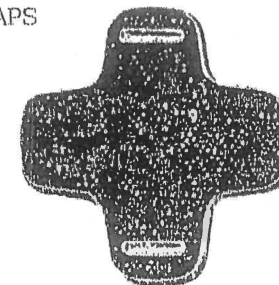

\$45

EMCO BOW RESTS COMPLETE

Part No. 139POL
Polished Brass, drilled & tapped, pads & straps
included, black, saddle, or oiled brown leather
Pair

\$260

TOP BOW RETAINING PINS WITH STRAPS

Part No. 410
Brass 5/32" cotter pin, 7/16" wide strap, Black,
Saddle or Oiled Chestnut Brown color.
Dimension X will be 5" or your dimension.
Pair

\$18

Part No. S410
Same as above except Stainless Steel cotter pin.
Pair

\$18

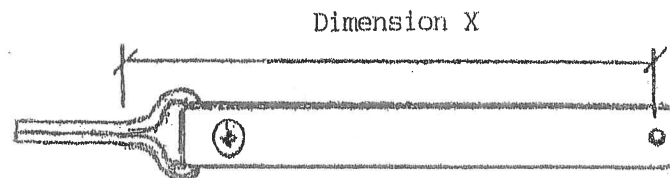

BLADE BOW SEPARATOR

Part No. 114
Overall length 2"
Aligns bows in down position
Takes #6 screws
Brass
Set (one male, one female)

17

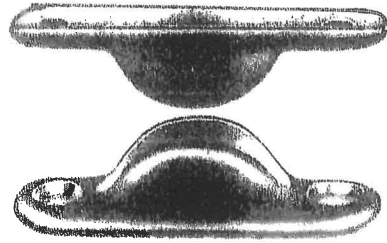

\$32

4-SCREW BOW SEPARATOR

Part No. 115
Overall length 1 1/4"
Aligns bows in down position
Takes #6 screws
Polished
Brass
Set (one male, one female)

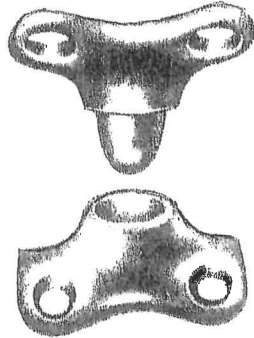

\$32

WIDE BOW SEPARATOR

Part No. 116
Overall length 2"
Width 3/4"
Aligns bows in down position
Takes #6 screws
Brass
Set (one male, one female)

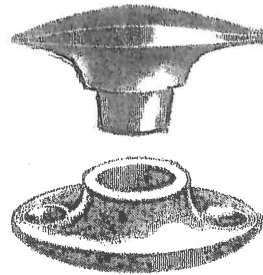

\$32

SMALL BRASS BEADED PROP NUT

18

Part No. 301
1 1/8" Diameter
7/16" Thread
Square nut
Cast Brass
Polished
Each

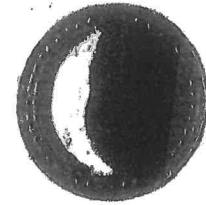

\$60

BRASS BEADED PROP NUT

Part No. 302
1 1/4" Diameter
7/16" Thread
Square nut
Cast Brass
Polished
Each

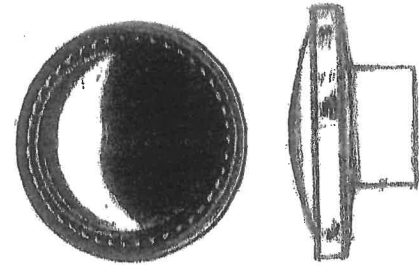

\$60

SMALL TOP PROP NUT

Part No. 303
Painted Black
Square nut
1 1/4" diameter
7/16" thread
Brass
Each



\$18

LEATHER COVERED, HAND STITCHED TOP PROP NUT

Part No. 311
1 3/4" Diameter
7/16" Thread
Black leather
Black square
Brass
Each



\$70

19

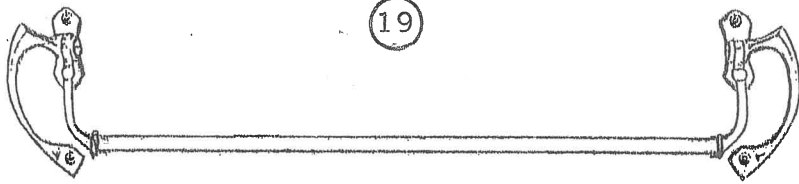

DELUXE FOLDING ROBE RAIL ENDS

Part No. 170
Four lost-wax castings
and two screws.
You drill, tap and fit.
Brass 5/8" tube needed
to complete.
Has right and left grab
handles to assist when
entering or exiting car.
Brass 6-piece kit

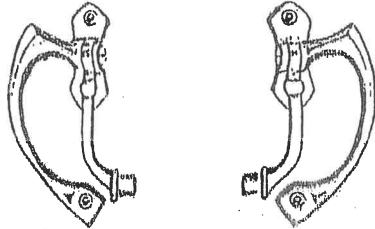

\$180

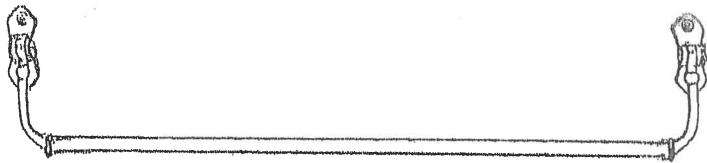

FOLDING ROBE RAIL

Part No. 172
Four lost-wax castings
and two screws.
You drill, tap and fit.
Brass 5/8" tube needed
to complete.
Brass 6-piece kit

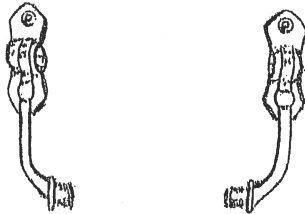

\$125

BODY GRAB HANDLE

Part No. 284
Longest dimension 4 3/4"
Height 1 7/8"
Mounts to body or pillar
Brass
Each

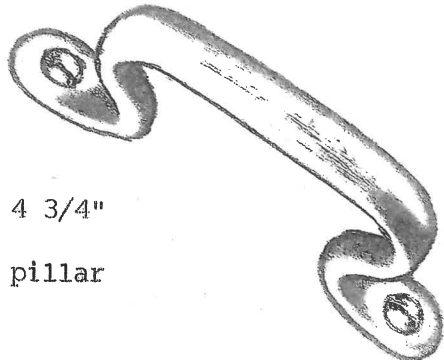

\$75

20

LARGE FOOT REST BRACKETS

Part No. 264
Overall length 8"
Machined for 1" tube
Center to center of pivot
point to tube is 6 1/2".
Drilled for 5/16" screw.
Nice brass sand castings.
Pair

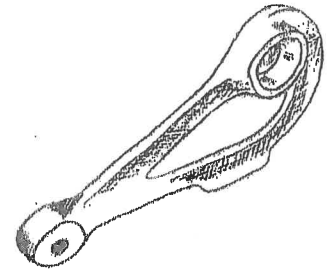

\$150

L & M FOOT REST MOUNTING BRACKET

Part No. 164
Overall length 2 1/16"
Width 7/8"
Tapped for 5/16-18 brass,
countersunk, oval-head,
slotted screw, included.
Fits Large & Medium Foot Rest
Mounting Brackets.
Brass
Each

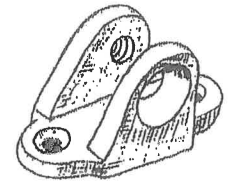

\$30

MEDIUM FOOT REST BRACKETS

Part No. 268
Overall length 7"
Machined for 1" tube
Center to center of pivot
point to tube is 5 5/8".
You drill for rivet or
screw.
Nice brass sand castings.
Pair

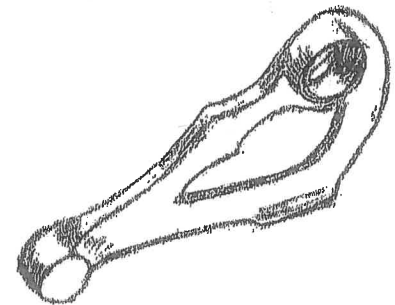

\$140

(21)
M & S FOOT REST MOUNTING BRACKET

Part No. 168
Overall length 2 1/4"
Width 3/4"
Holes for 1/4" rivet included,
or use Clevis pin.
For Medium & Small Foot Rest
Brackets.
Brass

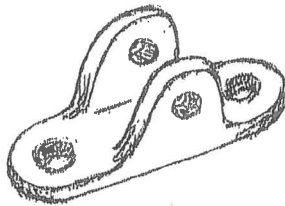

\$25

SMALL FOOT REST BRACKETS

Part No. 263
Overall length 6 1/8"
Machined for 1" tube
Center to center of pivot
point to tube is 4 3/4".
You drill for rivet or
screw.
Nice brass sand castings.
Pair.

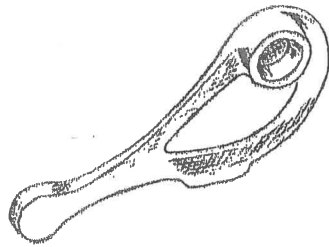

\$125

VARIABLE FOOT REST MOUNTING BRACKET

Part No. 163
Overall length 2 1/16"
Width 9/16"
You drill for proper height
of pivot point.
Made for Small Footrest Bracket
but has various uses.
Brass
Each

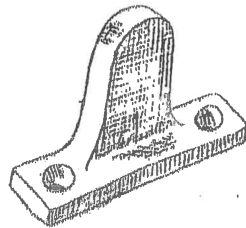

\$22

FLANG MOUNT
TIRE HOLDER

Part No. 272
Brass Sand Casting
You machine slots
for 1" or smaller
straps and drill
mounting holes.

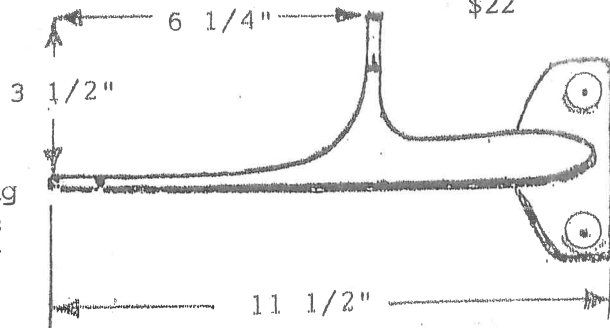

\$120

Each

(22)

OFFSET TIRE ARM

Part No. 273
Brass sand casting
Use Tire Arm Socket (No. 174) to mount.
Has support pad on arm if needed.
You machine slots for 1" or smaller straps.
Can be cut and welded to different dimensions.

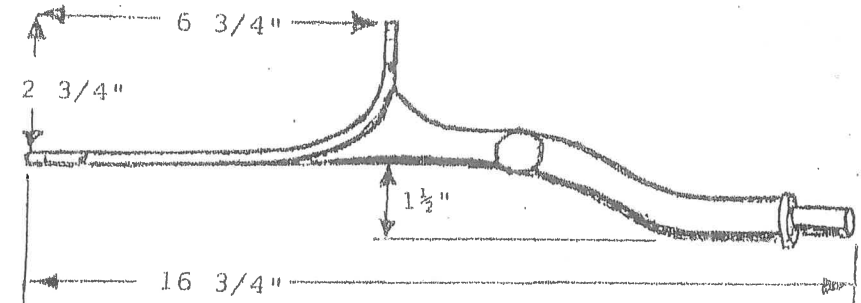

Each

\$120

STRAIGHT TIRE ARM

Part No. 274
Brass sand casting
Use Tire Arm Socket (No. 174) to mount.
You machine slots for 1" or smaller straps.

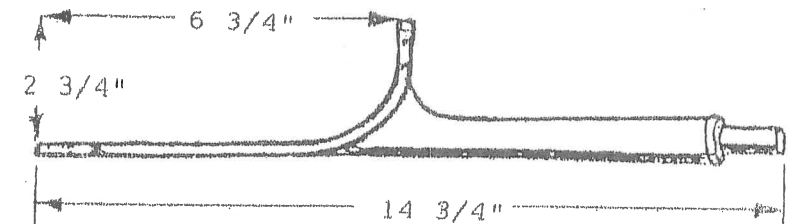

Each

\$110

TIRE ARM SOCKET

Part No. 174
Base is 2 1/2" x 1 1/4" x 1/4"
Holes for #12 screws.
You drill & tap for
set screw included.
Brass

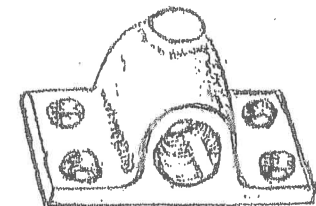

\$32

ROUND LEATHER FRONT TOP STAY STRAPS

Over the years, many cars have had their weathered or broken round top stay straps replaced by easier to obtain flat straps. If this has happened to your car, now you have the opportunity to change them back to the round style again.

Top stay straps have been made in many styles. . .some better than others. We can make most any style that you require. A less desirable design is one which puts all the tension on the hole in the leather that the buckle tongue goes through. Like this:



Better designs take the pressure off of the hole in the leather and offer mechanical advantage (as in pulley systems) when tightening. Styles, sizes, and combinations of top hardware are endless. We can copy any design or style that you need. Following are six styles that can be ordered. They come standard with footman loops #102 or #113 at the top, and either #402 bolt snaps or #403 spring snaps at the bottom. These will be polished brass and cleared. The 150 center bar roller buckle is standard and also polished & cleared. Other buckles, hardware, or finishes on request. The #101 Disconnect Link with footman loop can be used for an additional \$40 on Styles A, B, E, and F. For Styles C and D an additional \$80 is needed. The more accurate your Total Length dimension, the better the straps will fit and look. Below are the older style buckles that are available.

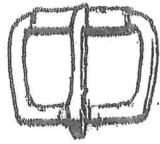

50 Buckles

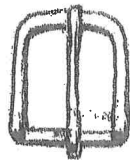

12 Buckles

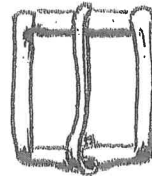

49 Buckles

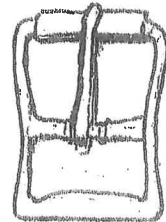

150 Buckles

ROUND LEATHER FRONT TOP STAY STRAPS

STYLE A

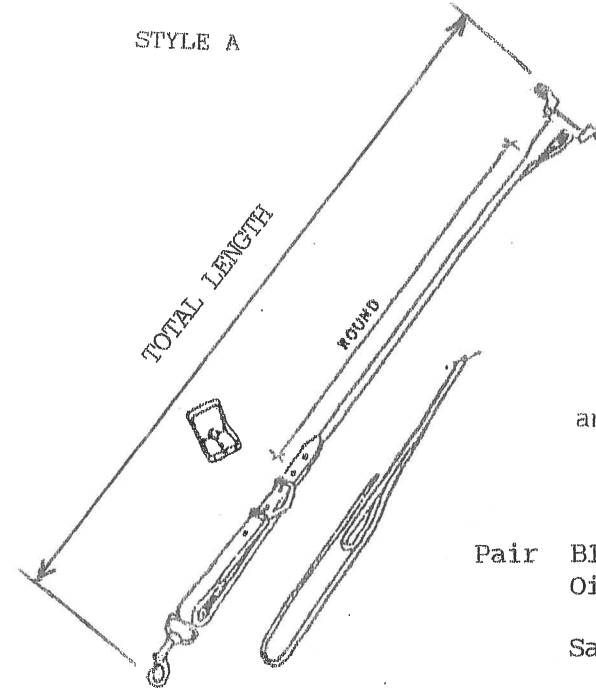

The strap is 1" wide and the round is 7/16".

Pair	Black or Oiled Brown	\$280
	Saddle	\$300

STYLE B

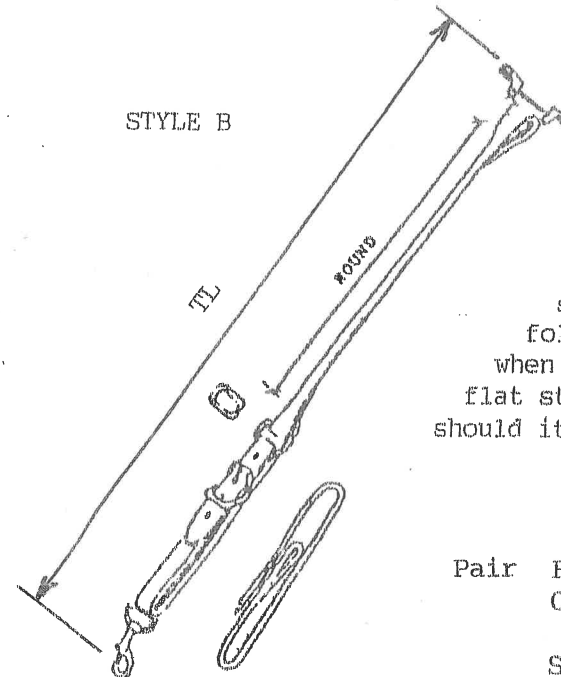

This style uses a brass square link. The strap folds easily for storage when the top is down and the flat strap is simple to replace should it become worn in the future

Pair	Black or Oiled Brown	\$290
	Saddle	\$310

STYLE C

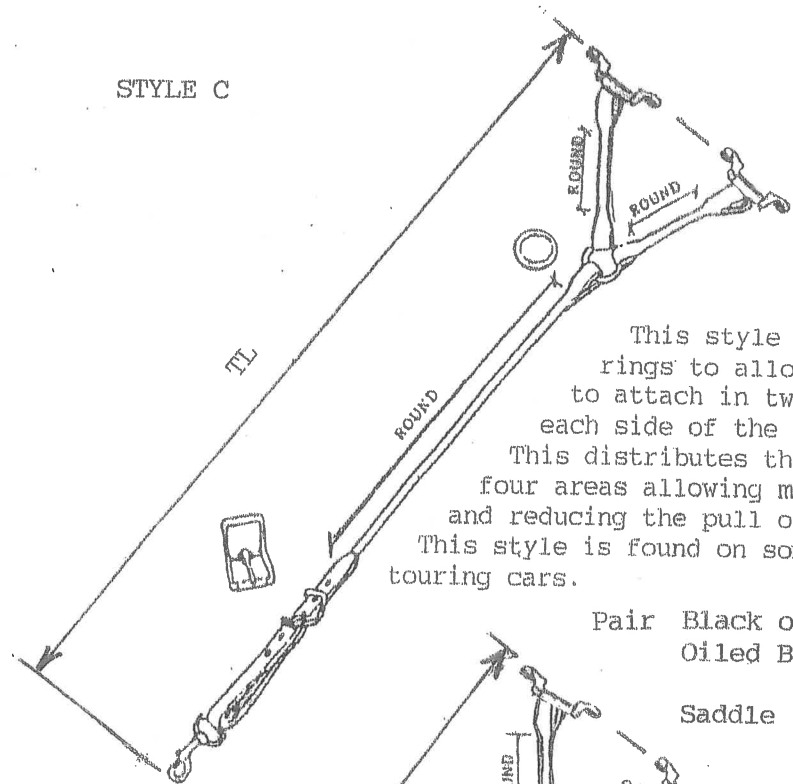

This style uses brass rings to allow the straps to attach in two places on each side of the top bow. This distributes the pull to four areas allowing more stability and reducing the pull on the loops. This style is found on some large touring cars.

Pair Black or Oiled Brown \$420
Saddle \$440

STYLE D

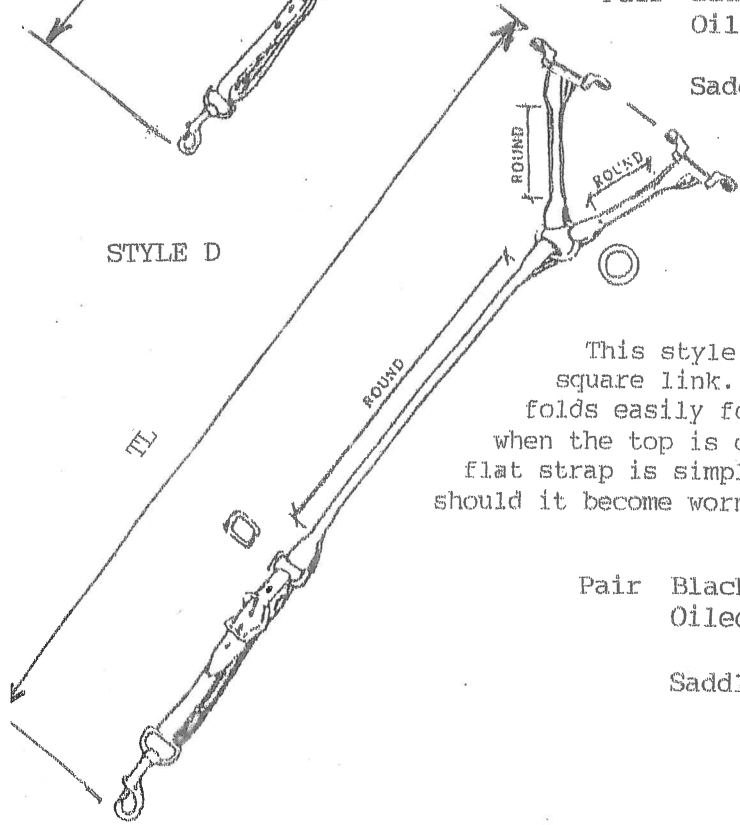

This style uses a brass square link. The strap folds easily for storage when the top is down and the flat strap is simple to replace should it become worn in the future.

Pair Black or Oiled Brown \$420
Saddle \$440

STYLE E

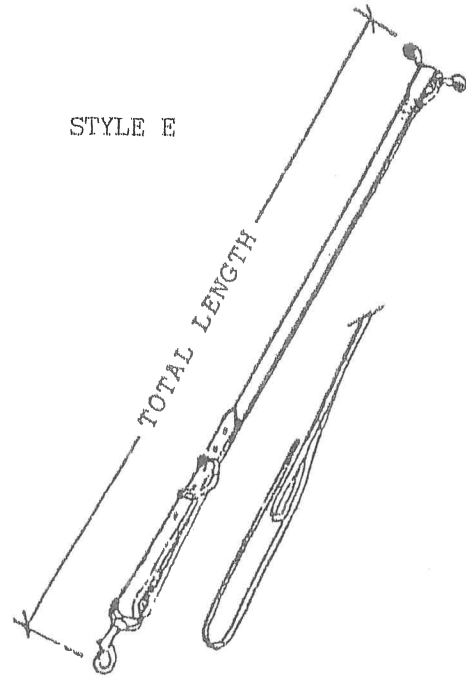

STYLE F

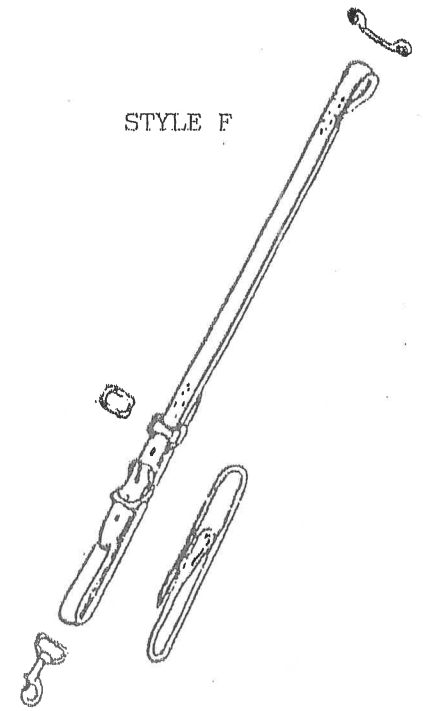

Black, Saddle, or Oiled Chestnut Brown Leather. Beautifully hand stitched. 1" wide leather straps. Brass Center-bar roller buckles. Brass square links on Style F. Upper attachment: #102 or #113 polished. Lower attachment: #402 Bolt Snap. Other combinations of hardware available. Give Total Length of strap assembly (from bow to point Bolt Snap will attach).

To order Flat Straps above:
State Style E or Style F
State Total Length
State Black or Saddle or Oiled Chestnut Brn.

Pair Black or Oiled Chestnut Brown \$180
Saddle \$200

BACK STAY STRAP STYLES

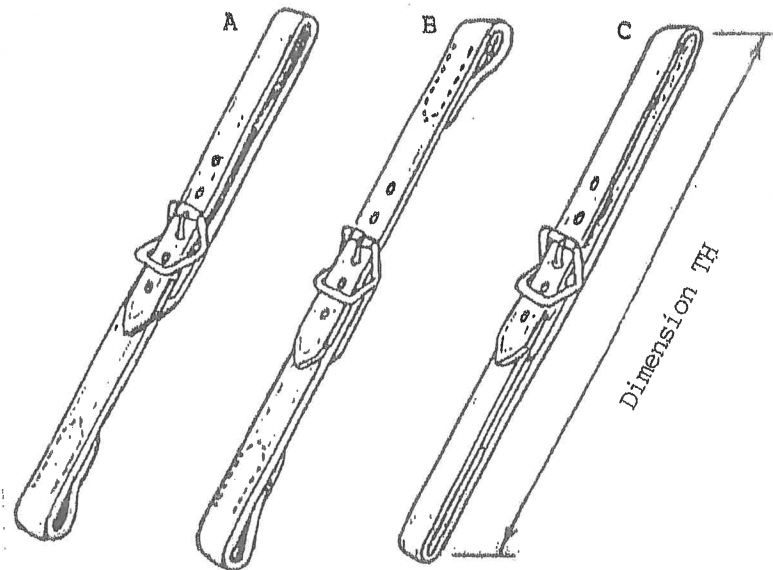

TH = _____ Total Height on strap assemblies.
 NOTE: If you punch holes in straps then TH Dimension is not extremely critical. It is usually best to fit straps and then punch holes. If you want holes already punched in straps, then a simple drawing showing mounting points on bow and body with dimension would be helpful.

COMPLETELY FINISHED ASSEMBLIES (hand stitched)
 Using your upper/lower attachments:

1" Wide	Pair \$100
1½" Wide	Pair \$115

COMPLETELY FINISHED ASSEMBLIES (hand stitched)
 Using our upper/lower attachments:

List and add the cost of the attachments needed plus \$8 each for dressing, polishing, and clearing.

Prices are for Black or Oiled Chestnut Brown.
 Saddle color add \$10

CURTAIN ROLL-UP STRAPS

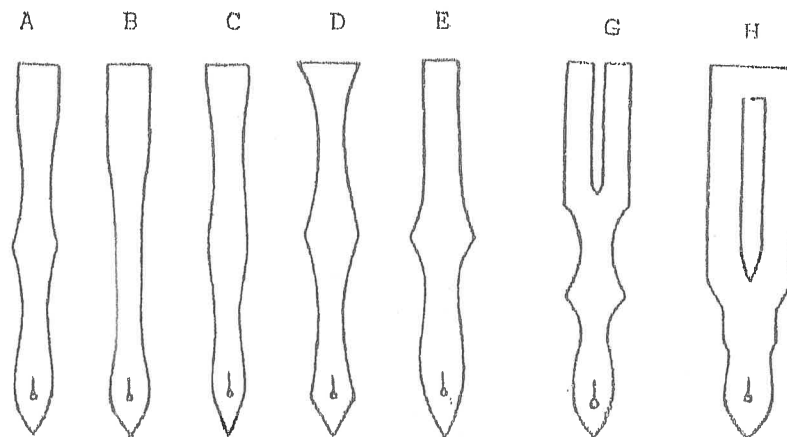

STYLES A, B, C, D, E
 Part No. 420
 Pair

\$35

STYLES G, H
 Part No. 422
 Pair

\$40

Black, Saddle, or Oiled Brown Chestnut color leather.
 Holds rolled up rear window curtain to back bow.
 State style and length (usually 10 to 12 inches).

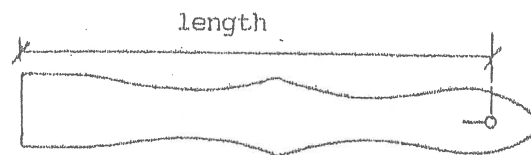

CARRIAGE KNOB

Part No. 421
 For curtain roll-up straps.
 New
 Each



\$3

We can make back stay straps, hood hold down straps, spare tire securing straps, luggage rack straps, trunk straps, or any other straps that you need. Please send accurate description of what you need (width of strap, style and finish of buckle or hardware, black, saddle, or oiled chestnut brown leather, length dimensions) and I'll send you a price quote.



Above is an example of length dimensions. Dimension A shows where you plan to position the buckle on the strap. If you prefer to fit the strap and punch the holes yourself, then Dimension B is all we need. Holes in straps are placed about one inch apart. Straps are glued and beautifully hand stitched around buckles and loops.

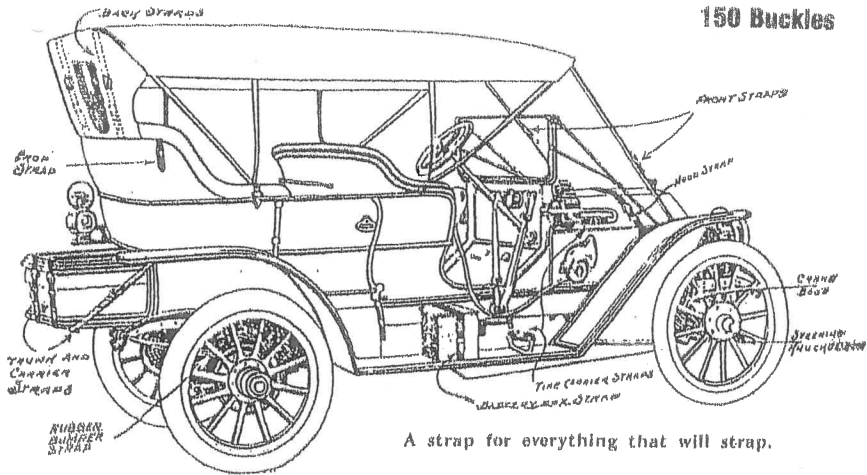
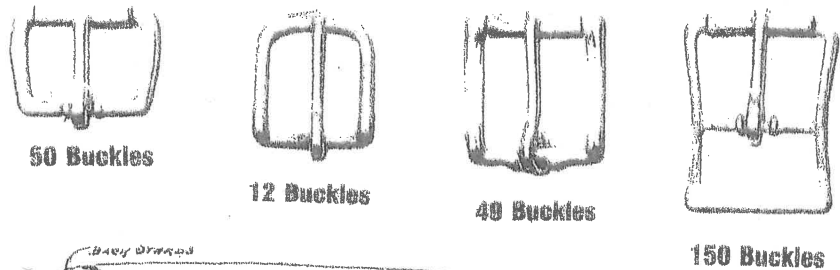

A strap for everything that will strap.

FOR TIRE CARRIERS, BOW RESTS, TRUNKS, MIRRORS, ETC.

Hand stitched, heavy leather straps with your choice of buckles. We keep a large selection of brass buckles in stock. We also have nickel, black powder painted, and chrome buckles. Decide the Total Length (Dim. B) that the strap needs to be. When I install straps, I prefer to fit the straps to the car and then punch the holes. I won't punch holes unless you request me to and you give me Dimension A which should be at least 4 inches shorter than Dimension B. Look on the chart to find the cost of BLACK or OILED CHESTNUT BROWN straps. If you want SADDLE color, add \$5 per strap and allow a little more time for me to make them. To order, state: WIDTH, LENGTH, BUCKLE STYLE & FINISH, LEATHER COLOR, and if you want holes punched, DIM. A.



PRICES ARE FOR BLACK & OILED CHESTNUT BROWN STRAPS

5/8" & 3/4" WIDTH	1 1/8" & 1 1/4" WIDTH
up to 24" = \$22	up to 30" = \$32
25" to 30" = \$24	31" to 36" = \$35
31" to 36" = \$26	37" to 42" = \$38
37" to 42" = \$28	43" to 48" = \$41
43" to 48" = \$30	49" to 54" = \$44
49" to 54" = \$32	55" to 60" = \$47
7/8" & 1" WIDTH	1 1/2" WIDTH
up to 24" = \$24	up to 30" = \$38
25" to 30" = \$26	31" to 36" = \$41
31" to 36" = \$28	37" to 42" = \$44
37" to 42" = \$30	43" to 48" = \$47
43" to 48" = \$32	49" to 54" = \$50
49" to 54" = \$34	55" to 60" = \$53

FOR SADDLE COLOR, ADD \$5 PER STRAP

HOOD STRAPS MADE FOR YOU

Below are five styles 1½" wide. Prices are for Black or Oiled Brown Leather sewn onto your loops. Saddle color add \$20. All hand sewn with leather pads under buckles. Price includes leather, labor, SS springs where shown, and polished & cleared Brass Buckles. Black, Stainless Steel and Chrome buckles also available. Check nickel buckle availability and price (sent out special). We will sew on your loops, or add the cost of ours (brass castings add \$8 each for polishing & clearing).

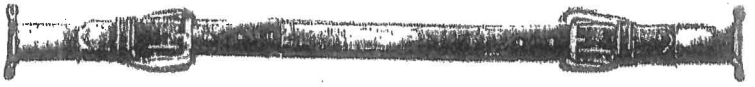
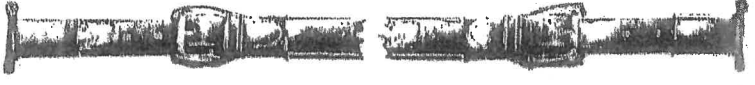
- A  \$175
 - B  \$175
 - C  \$275
 - D  \$175
 - E  \$175
- ← Total Length →

Hood
Side
Height

Holes
punched
in straps?
Yes No

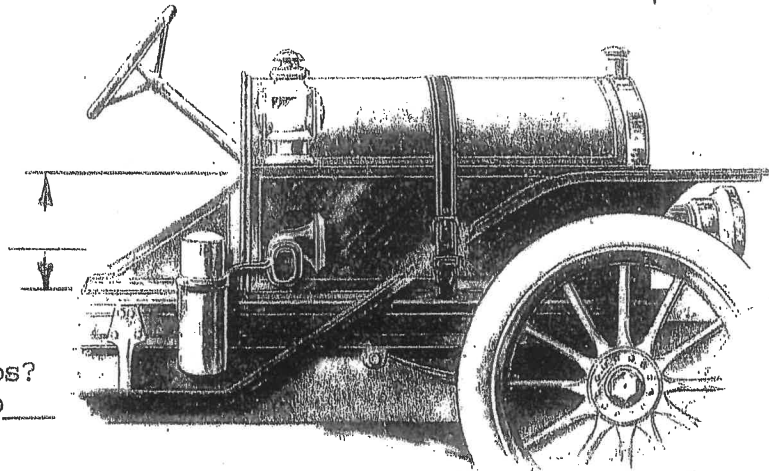

A car with a hood strap over the hood conveys the impression of greater horse-power and strength than does one without.

MURPHY--TYPE FASTENERS

SINGLE STUD
Part no. 413
Cast Brass
Polished
Each

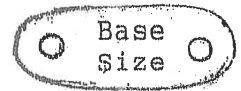
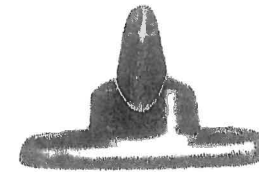

\$15

DOUBLE STUD
Part No. 414
Cast Brass
Polished
Each

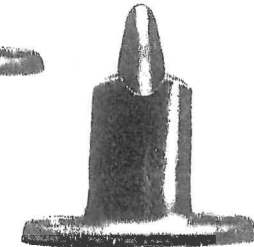
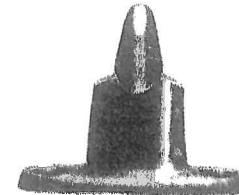

\$15.50

TRIPLE STUD
Part No. 407
Cast Brass
Polished
Each



\$16

SINGLE WIDE-BASE STUD
Part No. 408
Cast Brass
Polished
Each

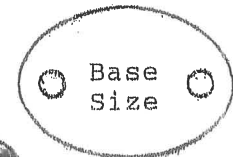
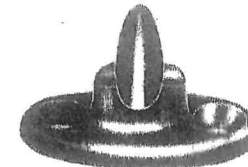

\$16

DOUBLE WIDE-BASE STUD
Part No. 409
Cast Brass
Polished
Each

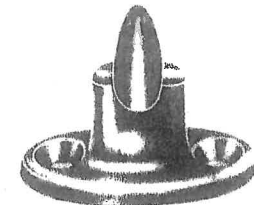

\$16.50

SINGLE CURVED-BASE STUD
Part No. 411
Cast Brass
Polished
Each

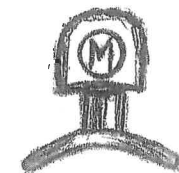
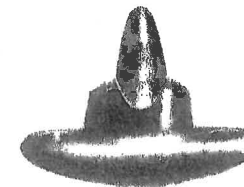

\$16

(33)

DOUBLE CURVED-BASE STUD
Part no. 412
Cast Brass
Polished
Each

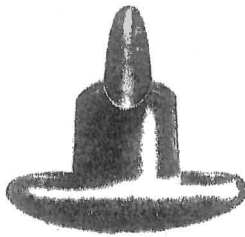

\$16.50

ROUNDED EYELET/WASHER SET

Part No. 442
Brass
Original early style
formed in our dies.
1 eyelet/washer set

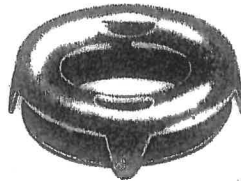

\$2.50

FLAT EYELET/WASHER SET

Part No. 440
Brass
Common Sense fastener
1 eyelet/washer set



\$1.50

MURPHY BACK PLATES

Part No. 415
For attaching studs to side
curtains, door pockets, etc.
New, brass, each

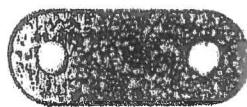

\$2.00

SPLIT RIVETS

Part No. 416
3/8" Length
Just under 1/4" head Dia.
Brass plated steel
Package of 12



\$4.00

(34)

RIBBED EYELET/WASHER SET
Part No. 445
European style
formed in our dies.
Polished Brass
1 eyelet/washer set

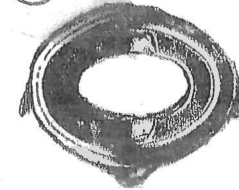

\$6

HEAVY DUTY BOLT SNAP

Part No. 402
Overall length 3"
For 1" strap
Swivel loop
Solid Brass, Each

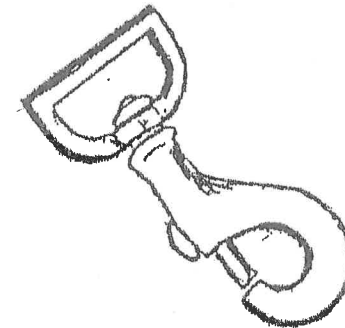

\$7

Part No. 402SS
Stainless Steel, Each

\$10

HEAVY DUTY SPRING SNAP

Part No. 403
Overall length 3"
For 1" strap
Fixed loop
Brass with SS spring, Each

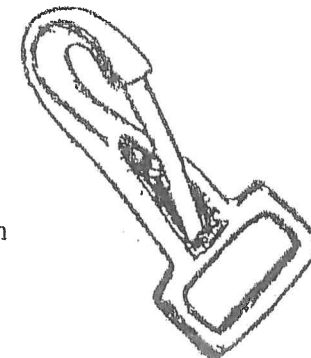

\$7

Part. No. 403SS
Stainless Steel, Each

\$10

GAS KEY & BOTTLE OPENER

Part No. 213
Key for your Prest-o-lite
bottle or gas tank
Bottle opener
Perfection on key
Used in early tool kits
Bronze
Each

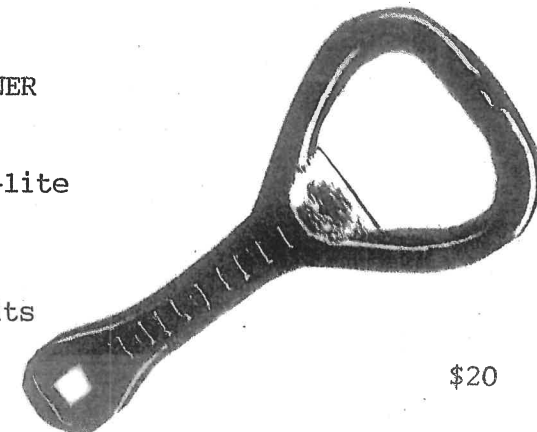

\$20

SIDE LAMP BRACKET

35

Part No. 185
Total Height 5 1/4"
Width 3 1/4", 2 1/2" out
You Drill & polish
Brass
Pair



\$170

SPEEDOMETER SHAFT BRACKET

Part No. 155
Overall length 2 5/16"
7/8" hole
Use where speedo
shaft goes through
floorboard, side
apron or fender.
Solid Brass
Each

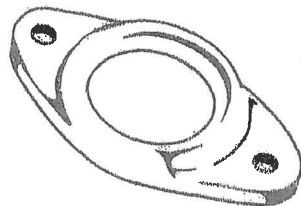

\$22

SPEEDOMETER SHAFT STRAP

Part No. 455
Overall length 3"
1" hole
3/4" wide strap
Eliminates sagging of
the speedometer shaft.
Prevents marring or
scratching.
All black
Each

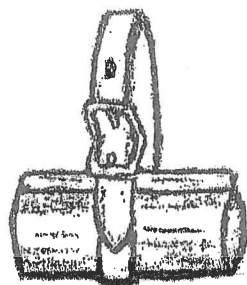

\$48

POINTED ASSIST STRAP BRACKETS

36

Part No. 189
Height 2 1/4"
Brass casting with
Brass ring.
Spring assembly keeps
tension on ring.
Nickel Plated
Pair



\$200

OVAL ASSIST STRAP BRACKETS

Part No. 190
Height 1 7/8"
Brass casting with
Brass ring.
Spring assembly keeps
tension on ring.
Nickel Plated
Pair



\$180

SINGLE GROOVE ASSIST STRAP BRACKETS

Part No. 191
Overall length 2 1/4"
Solid Brass casting
Mounts with two #8
oval head screws
Nickel Plated
Pair

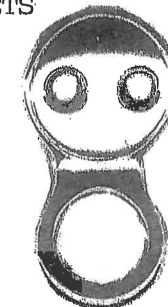

\$80

TRIPLE GROOVE ASSIST STRAP BRACKETS

Part No. 560
Overall length 2 1/4"
Stamped brass
Mounts with two #8
oval head screws
Chrome Plated
Pair

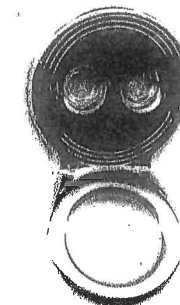

\$50

NARROW BASE ASSIST STRAP BRACKETS

Part No. 561
Overall length 2 3/8"
Stamped steel
Mounts with two #10
oval head screws
Nickel Plated
New Old Stock
Pair



\$40

38

ASSIST STRAP LOOP

Part No. 157
For 1", or 1 1/8" strap
1/2" hole
Various uses
Brass

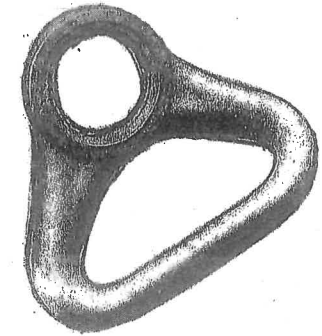

\$25

TRADITIONAL LEATHER TRUNK HANDLE

Part No. 480
Overall length 9 1/4"
Thickness is 5/16"
Use #481 or #482 Handle Loop
Sewn
Choose Black, Natural, Saddle
or Oiled Chestnut Brown leather.
Pair



\$125

SPECIAL ORDER INTERIOR TRIMMINGS

TWISTED CORD ASSIST STRAPS

Part No. 570
Length about 10 1/2"
Crocheted band at top.
Brass bell is covered
and crocheted above
the pompom.
Twisted cord surrounds
a spring originally done.
Need your interior colors
for best color choice.
Made on your original
assist strap brackets
or add the cost of ours.
Pair

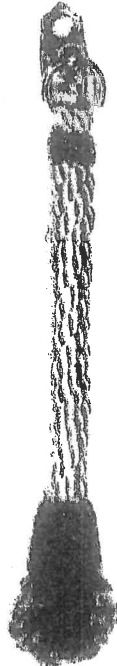

\$600

HANDLE LOOP

Part No. 481
Overall length 1 7/8"
Width is 5/8"
Brass plated steel
Each

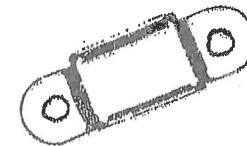

\$5

Part No. 482
Nickel plated steel

\$5

POMPOM WINDOW SHADE PULLS

Part No. 575
Normal size
Crocheted bell
Need your interior colors
for best color choice.
Each



\$95

7/16" Diameter Head Nails

1/2" long
Gloss black
Most popular for top
and interior trim.
Pack of 100



\$15

TRUNK DOWEL

Part No. 186
Height 2 5/8"
Width 2"
Two Brass Castings
Aligns trunk lid .
Each 2-piece set

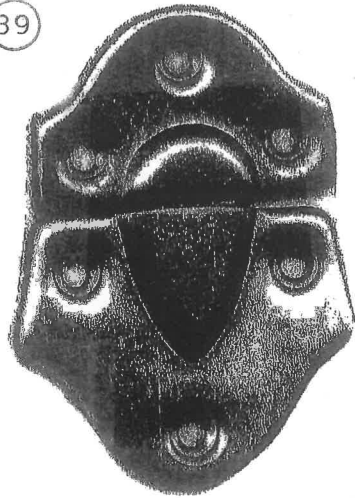

\$45

STAMPED DOWEL

Part no. 822
Size: 1 3/4" x 2 1/8"
Aligns Lid
Polished & Cleared
Solid Brass
Each

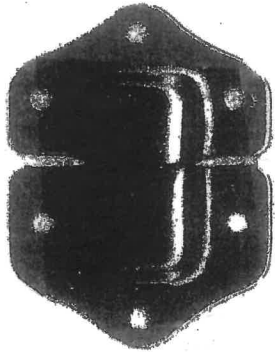

\$15

Part No. 823
Like No. 822 except
Nickel Plated steel
Each

\$8

Part No. 824
Like No. 822 except
Brass Plated steel
Each

\$8

STOP HINGE

Part No. 840
Overall length 4 3/4"
Width 1 1/4"
Opens 90 degrees
Brass plated steel
Each

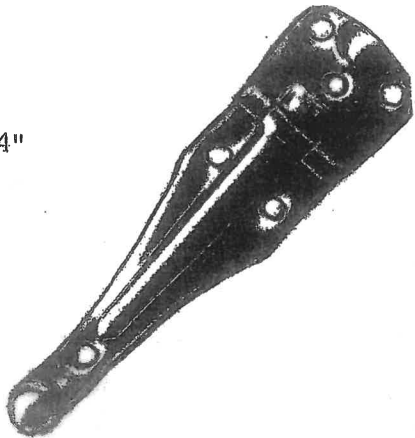

\$15

Part No. 841
Like No. 840 except
Nickel plated steel

\$15

aathco@colton.com

