

# THURSDAY POOLS®

Your weekend starts early with us

**FIBERGLASS POOL COLLECTION**

**2023 - 2024**





# WELCOME

Welcome to our corner of the universe, the place where we handcraft one-piece inground fiberglass pool shells with high standards and craftsmanship in our ISO-9001 certified facility based in Fortville, Indiana. Known widely for our innovations and quality, we owe our reputation to several contributing factors.



## THE RIGHT PEOPLE

- Over 35 years of experience in the composites industry
- Support and encouragement for professional development skills and knowledge
- Employees who take pride in their work
- Employees who look for ways to eliminate waste and non-value-added activities

## THE RIGHT ATTITUDE

- Customers, dealers and employees equally deserve honesty and respect
- There are no bad ideas
- Each person plays a different and valuable role contributing to your enjoyment of the product
- We aim to exceed EPA and OSHA standards

## THE RIGHT PLACE

- 285,000 square-foot manufacturing campus on 104 acres
- In-house tooling capability
- Ultra high-efficiency and climate-controlled environment

Every day at Thursday Pools, we demonstrate our passion, care, and relentless drive for innovation. What does this mean for you? It means that you can count on your inground fiberglass pool to be handmade by skilled craftsmen, durable, and available with innovations you won't find from any other fiberglass pool manufacturer. We welcome you to choose quality. Choose innovation. **Choose Thursday Pools.** And get ready to create a lifetime of extraordinary moments with your family and friends.



GRACE BEACH ENTRY | DIAMOND FINISH

# NOTICE AND DISCLAIMER

**This NOTICE AND DISCLAIMER is made to all retail customers purchasing any River Pools® or Thursday Pools® pool shell or otherwise dealing with a River Pools or Thursday Pools dealer or franchisee.**

Thursday Pools, LLC manufactures River Pools® and Thursday Pools® pool shells and sells those pool shells to locally owned and independently operated dealers. Those dealers resell and install those pool shells for their customers. Thursday Pools, LLC also manufactures River Pools pool shells and sells them to independently owned and operated franchisees who have franchise agreements with River Pools Franchising, LLC. River Pools Franchising, LLC provides those franchisees with the non-exclusive right to market the River Pools pool shells as a franchisee. River Pools Franchising, LLC does not manufacture pool shells, and neither Thursday Pools, LLC nor River Pools Franchising, LLC install pool shells or guarantee the obligations of any dealers or franchisees. No dealer or franchisee is an owner, agent, or employee of Thursday Pools, LLC, and no dealer or franchisee is an agent of River Pools Franchising, LLC or has authority to act on behalf of Thursday Pools, LLC or River Pools Franchising, LLC. Thursday Pools, LLC and River Pools Franchising, LLC each disclaim any responsibility or liability for the actions or inactions of any dealer or franchisee. Any statement in any advertisement, literature, brochure or website, or statement by any dealer, franchisee or other individual, should not be interpreted or construed to expressly or impliedly create any relationships contrary to this Notice and Disclaimer.



ASPEN | SQUARE SPA | CARIBBEAN SPARKLE FINISH

# SAFETY INFORMATION

## We're Committed to Safety.

Pool owners should always think of SAFETY FIRST. They should take specific steps to ensure that their family members and guests are knowledgeable about the safe and sensible use of their pool. It's also a good idea for pool owners to contact their local American Red Cross for available CPR classes and other vital safety programs. Pool owners should ensure:

1. That their pool is never used unless there is adequate supervision.
2. That their pool is kept in good repair and is not used when there is a missing or broken drain cover or other component.
3. That ALL CHILDREN using their pool are under constant supervision.
4. That anyone under the influence of alcohol, drugs, or stimulants that would impair their abilities or judgment does not use the pool.
5. That their pool is protected by appropriate barriers to prevent unsupervised entry, including, but not limited to, fencing with self-latching gates, automatic pool covers, alarms, etc., as required by local laws and safety standards.
6. That their pool builder has supplied them with all of the safety information that accompanies the pool and that they have installed the provided warning stickers and signs where they can be clearly visible to all who use the pool.
7. That for increased child safety, they always remove all toys from in and around the pool and store them out of sight when the pool is not in use.
8. That no pool users dive or jump in the pool.
9. That additional important safety information accompanying their pool is reviewed carefully before use.

**Please note:** Items that are essential for the safe use of your pool may not be visible in many of the photographs contained in this brochure, either because of perspective or camera angle, or because they were removed for photographic purposes. These items include, but are not limited to:

1. Safety ropes, which should remain in place at all times.
2. "No Diving" signs, which are provided and should be installed where they are clearly visible in accordance with instructions included in the Owner's Manual.
3. Necessary means of exit and entry into the pool.
4. Approved drain covers and other devices to protect against suction entrapment.
5. Minimum required inlets and returns to ensure proper water circulation.
6. Appropriate in-pool lighting if the pool will be used after dark.

All of these devices should be installed in accordance with manufacturers' instructions, the National Pool and Hot Tub Alliance standards, as well as state and local statutes and codes. Diving boards and slides require minimum depths and distances and must only be installed and used in strict compliance with the equipment manufacturers' specifications and the National Pool and Hot Tub Alliance standards. If the pool is labeled by Thursday Pools as NON-DIVING, then diving equipment may not be installed, and any such equipment must be removed before the pool is used.

Thursday Pools strongly recommends that diving boards and slides not be installed or used with its pools, given the inherent dangers associated with diving boards and slides in residential pools. These dangers include brain, spinal cord and other severe permanent injuries, and death. For that reason, Thursday Pools does not manufacture or sell diving boards or slides. If, despite this warning and recommendation, the owner decides to install or use a diving board or slide, the owner assumes all risks inherent with a diving board or slide, and Thursday Pools further warns that diving boards and slides require minimum depths and distances and must be installed and used in strict compliance with the equipment manufacturer's specifications and ANSI/NSPI, ANSI/APSP, and ANSI/APSP/ICC standards, as well as in compliance with all applicable laws, rules and regulations. The owner is responsible for making sure the pool is appropriate for diving boards and slides and otherwise meets all standards and laws for diving pools, and the owner must consult the diving board or slide manufacturer and/or installer as to the appropriateness of the pool for the diving board or slide and that its installation, location and use meet all standards and laws for diving and slide pools.



# A SINGLE DAY WITHOUT HER SMILE IS AN *ETERNITY*.

## PRACTICING WATER SAFETY SAVES SMILES

Drowning in the U.S. is the second leading cause of unintentional injury death for children aged one through 14. Never leave children unsupervised in a swimming pool. Teach your kids water safety with a free coloring book from a community leader and fiberglass pool manufacturer, **Thursday Pools**.



To learn more about water safety, scan this code or visit [ThursdayPools.com/water-safety](https://ThursdayPools.com/water-safety)



ASPEN | SANDSTONE FINISH



ASPEN | CALIFORNIA FINISH



GRACE BEACH ENTRY | SQUARE SPA | CALIFORNIA FINISH







# LARGE SIZE POOLS



SQUARE SPA | MONOLITH | WET DECK | MAYA FINISH



LIL BOB LX | CALIFORNIA FINISH

# GOLIATH

FILL YOUR GIANT EXPECTATIONS

## POOL SIZES

12'X25' 14'X29' 14'X33'  
16'X33' 16'X37' 16'X41'

**Big pools mean big fun. If you're looking for the max in family fun and good times, Goliath may be the pool for you.**

1. **Ample room** to exercise, play and relax.
2. **Non-skid surface** on the floor, stairs, and benches is easy on your feet and your swimsuit.
3. **Dual corner entry steps with benches** give you options for relaxing.
4. **Wide-open swim lane** allows room for play and exercise.
5. **Dual benches with swim-outs** provide comfort and convenience in the deep-end of the pool.

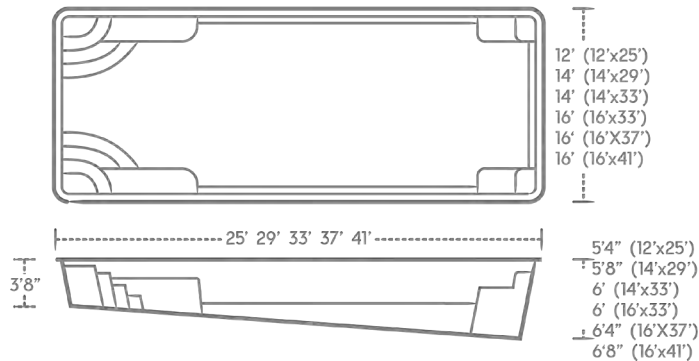

\*Non-Diving Pool  
\*See Safety Information

All measurements given reflect the dimensions of the pool to the exterior of the pool structure, not the dimensions of the pool interior.

1. All depths reflect the depth of the pool structure. Water depths may vary depending on the amount of water in the pool.
2. Additional specifications are available at [thursdaypools.com](http://thursdaypools.com).





MAYA FINISH



MAYA FINISH

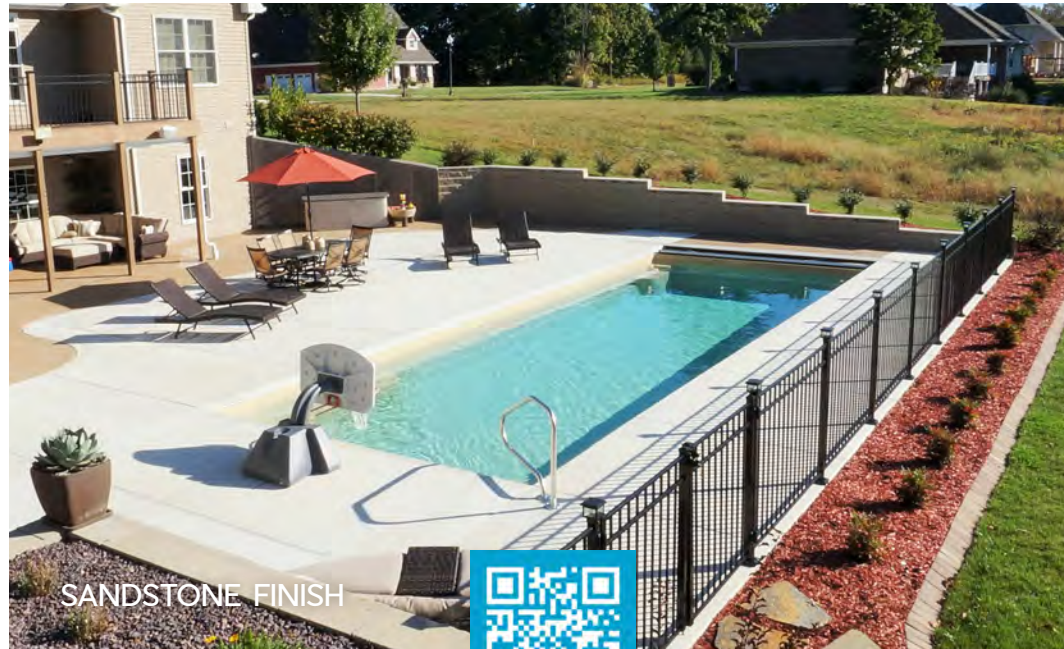

SANDSTONE FINISH



To see more of Goliath, scan this code  
or visit [ThursdayPools.com](http://ThursdayPools.com)

# ASPEN

Design Patent US D851,781 S

## CHILL OUT

### POOL SIZES

12'X25' 14'X30' 14'X35'  
16'X35' 16'X40'

Imagine yourself relaxing and keeping cool while soaking up the sun's warm rays on Aspen's fabulous tanning ledge.

1. **Huge 12" deep tanning ledge** is perfect for ledge loungers.
2. **Non-skid surface** on the floor, stairs, benches, and tanning ledge is easy on your feet and your swimsuit.
3. **Extended bench** gives you a place to relax, unwind and socialize.
4. **Dual swim outs and benches** provide comfort and convenience in the deep-end of the pool.
5. **Courtesy ledge around the deep-end** gives you a place to stand and rest.
6. **Wide-open swim lane** allows room for play and exercise.
7. **Auto-cover ready** to help you keep your new pool safe and clean.

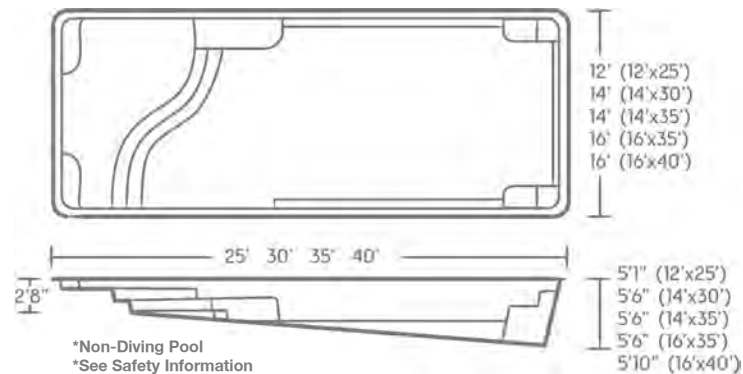

All measurements given reflect the dimensions of the pool to the exterior of the pool structure, not the dimensions of the pool interior.

1. All depths reflect the depth of the pool structure. Water depths may vary depending on the amount of water in the pool.
2. Additional specifications are available at [thursdaypools.com](http://thursdaypools.com).



CALIFORNIA FINISH



CALIFORNIA FINISH



CARIBBEAN SPARKLE FINISH



SANDSTONE FINISH

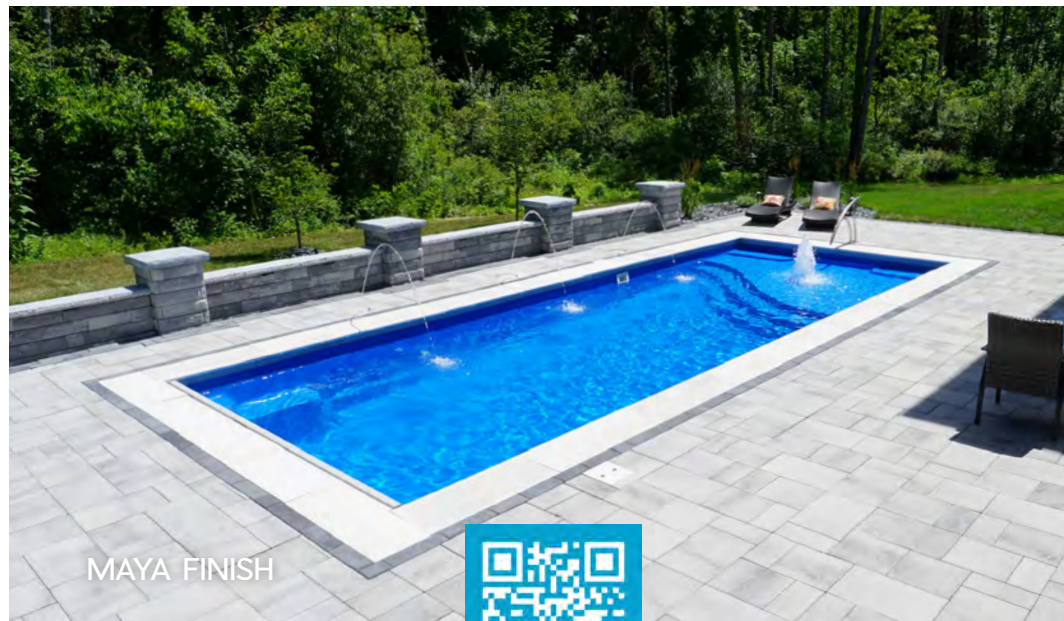

MAYA FINISH



To see more of Aspen, scan this code  
or visit [ThursdayPools.com](http://ThursdayPools.com)

# MONOLITH

## TYPE 1 DIVING POOL

### POOL SIZE

**16' X 40'**

If your home team loves to play, this is the pool for you. With Monolith, it's always game on.

1. **Large, flat-bottomed shallow-end** is ideal for water games like basketball.
2. **15" warning slope** alerts children and adults alike that they're leaving the shallow-end. Note: this transition area should be designated with safety rope and floats.
3. **Dual, deep-end seats with swim-outs** give you extra options for visiting and relaxing.
4. **Wide-open swim lane** allows room for play and exercise.
5. **Non-skid surface** on the floor, stairs, and benches is easy on your feet and your swimsuit.
6. **Auto-cover ready** to help you keep your new pool safe and clean.

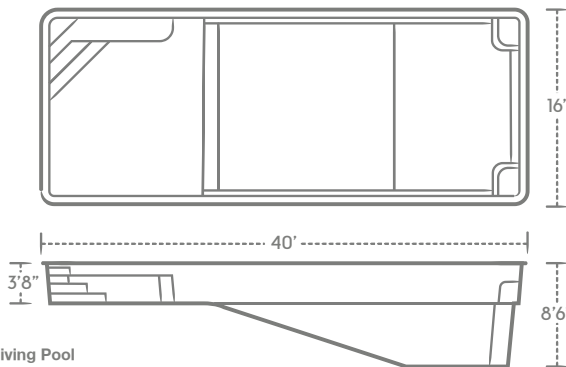

\*Type 1 Diving Pool  
\*See Safety Information

All measurements given reflect the dimensions of the pool to the exterior of the pool structure, not the dimensions of the pool interior.

1. All depths reflect the depth of the pool structure. Water depths may vary depending on the amount of water in the pool.
2. Additional specifications are available at [thursdaypools.com](http://thursdaypools.com).

\*Thursday Pools strongly recommends that diving boards and slides not be installed or used with its pools, given the inherent dangers associated with diving boards and slides in residential pools. These dangers include brain, spinal cord and other severe permanent injuries, and death. For that reason, Thursday Pools does not manufacture or sell diving boards or slides. If, despite this warning and recommendation, the owner decides to install or use a diving board or slide, the owner assumes all risks inherent with a diving board or slide, and Thursday Pools further warns that diving boards and slides require minimum depths and distances and must be installed and used in strict compliance with the equipment manufacturer's specifications and ANSI/NSPI, ANSI/APSP, and ANSI/APSP/ICC standards, as well as in compliance with all applicable laws, rules and regulations. The owner is responsible for making sure the pool is appropriate for diving boards and slides and otherwise meets all standards and laws for diving pools, and the owner must consult the diving board or slide manufacturer and/or installer as to the appropriateness of the pool for the diving board or slide and that its installation, location and use meet all standards and laws for diving and slide pools.



MAYA FINISH



MAYA FINISH

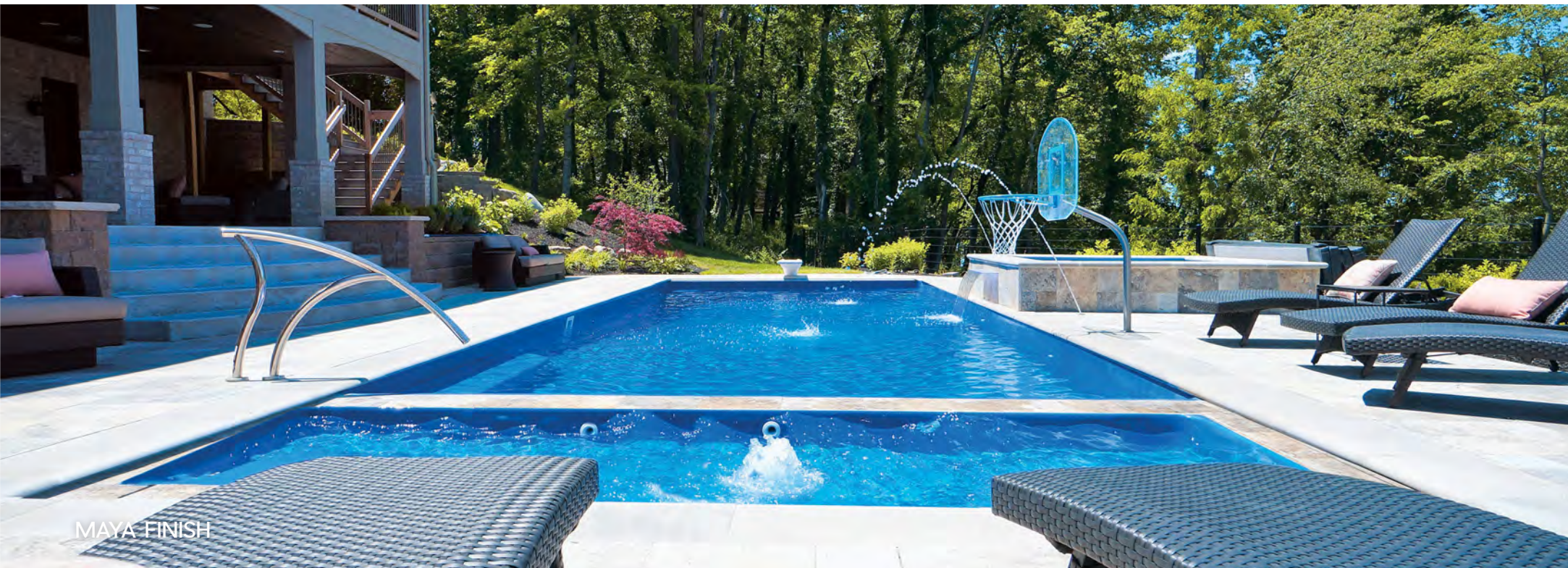

MAYA FINISH



MAYA FINISH

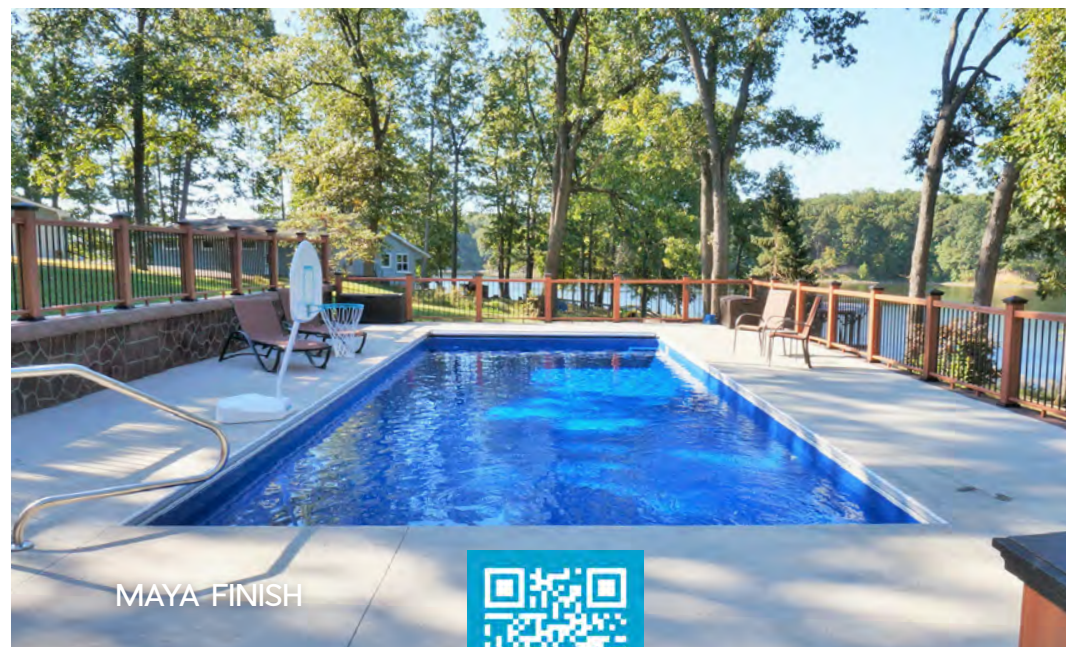

MAYA FINISH



To see more of Monolith, scan this code or visit [ThursdayPools.com](http://ThursdayPools.com)

# GRACE BEACH ENTRY

Utility Pool System Patent US 10,472,839

BRING THE SHORE TO YOUR DOOR

## POOL SIZES

14' X 36' 16' X 36' 16' X 40'

Enjoy all the luxury of a day at the beach without ever leaving your own backyard. Every day will feel like a vacation!

1. **A zero entry** that is perfect for dipping your toes in the water and lounging at the water's edge.
2. **A non-skid surface** on the floor, stairs, and benches is easy on your feet and your swimsuit.
3. **Dual, deep-end seats with swim-outs** give you extra options for visiting and relaxing.
4. **A courtesy ledge around the deep-end** gives you a place to take a break and stand.

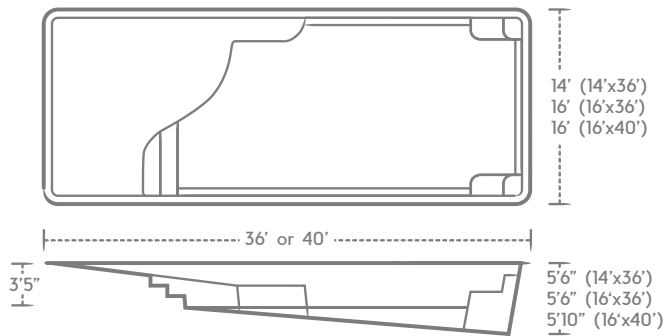

\*Non-Diving Pool  
\*See Safety Information

All measurements given reflect the dimensions of the pool to the exterior of the pool structure, not the dimensions of the pool interior.

1. All depths reflect the depth of the pool structure. Water depths may vary depending on the amount of water in the pool.
2. Additional specifications are available at [thursdaypools.com](http://thursdaypools.com).

Utility Pool System Patent US 10,472,839







DIAMOND FINISH



CARIBBEAN SPARKLE FINISH



CALIFORNIA FINISH



DIAMOND FINISH



To see more of Grace Beach Entry, scan this code or visit [ThursdayPools.com](http://ThursdayPools.com)



WELLSPRING | CARIBBEAN SPARKLE FINISH



GRACE BEACH ENTRY | DIAMOND FINISH



LIL BOB | CALIFORNIA FINISH

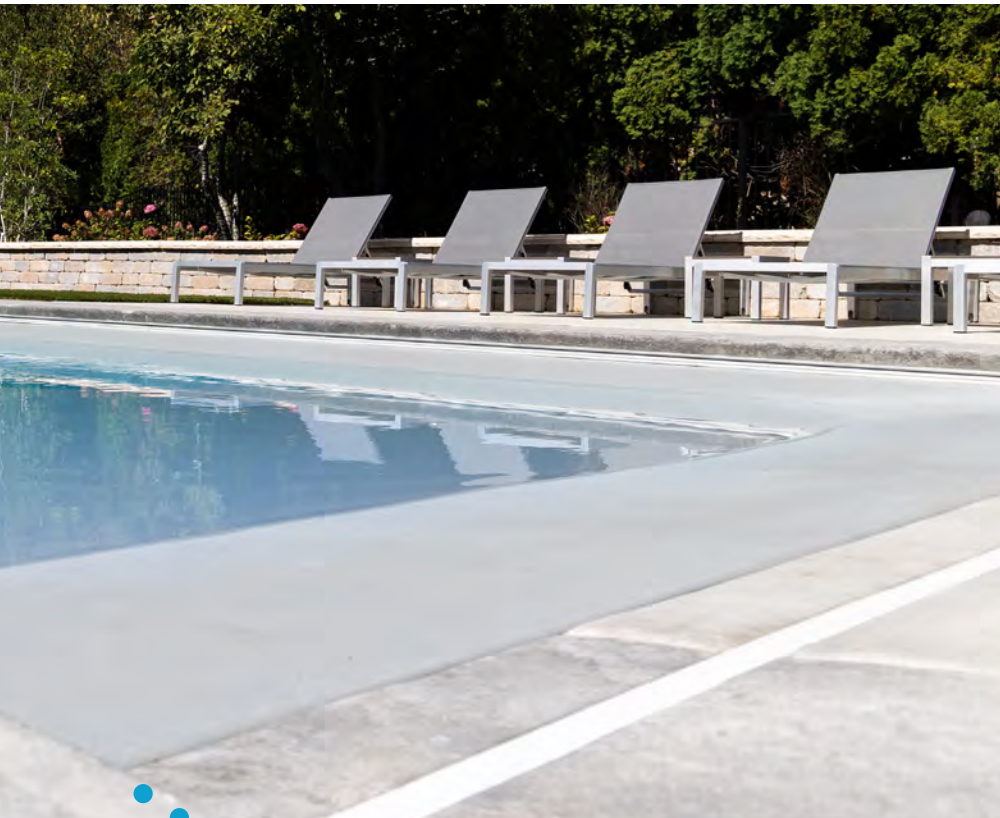

MEDIUM  
SIZE  
POOLS



LIL BOB | CARIBBEAN SPARKLE FINISH

# WELLSPRING

## YOUR PRIVATE PARADISE

### POOL SIZES

16'X36' 16'X40'

Paradise awaits just outside your back door. With Wellspring's inviting curves beckoning you, you'll never want to leave.

1. **Large 8' diameter sun shelf** is a great spot for loungers and bubblers.
2. **Wrap-around bench** gives you ample room to visit with family and friends.
3. **Expanded entry steps** provide easy entrance and exit from the pool.
4. **Non-skid surface** on the floor, benches, sun shelf, and steps is easy on your feet and your swimsuit.
5. **Deep-end bench** gives you a place to soak and unwind.

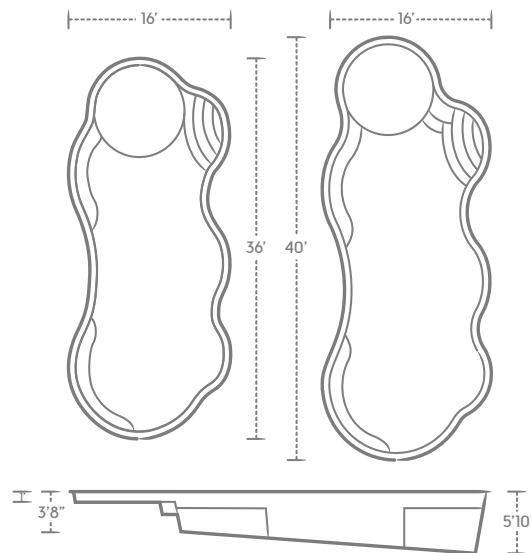

\*Non-Diving Pool  
\*See Safety Information

All measurements given reflect the dimensions of the pool to the exterior of the pool structure, not the dimensions of the pool interior.

1. All depths reflect the depth of the pool structure. Water depths may vary depending on the amount of water in the pool.
2. Additional specifications are available at [thursdaypools.com](http://thursdaypools.com).





CARIBBEAN SPARKLE FINISH



CARIBBEAN SPARKLE FINISH



CALIFORNIA FINISH



CALIFORNIA FINISH



To see more of Wellspring, scan this code or visit [ThursdayPools.com](http://ThursdayPools.com)

# SUN DAY

## EVERYONE LOVES SUNDAY

### POOL SIZES

15'X30' 16'X34.5' 16'X39'

Everyone loves Sunday. No to-do list, no errands to run, no work to be done. So drop your devices and forget your chores. Sun Day is here!

1. **Large landing pad with side entry stairs** is an ideal spot for youngsters to play.
2. **Large open swim area** is great for games, lap swimming, and water activities.
3. **12" deep sun shelf and swim-out** are perfect for easy entry and exit, and for soaking up the sun.
4. **Wrap-around benches** give you tons of room to visit and relax.
5. **Non-skid surface** on the floor, benches, and steps is easy on your feet and your swimsuit.
6. **A courtesy ledge around the deep-end** gives you a place to take a break and stand.

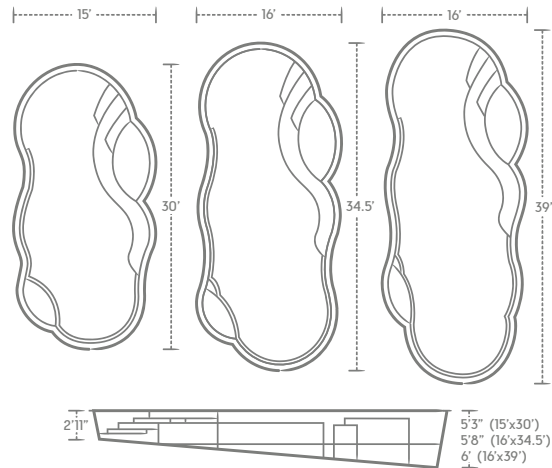

\*Non-Diving Pool  
\*See Safety Information

All measurements given reflect the dimensions of the pool to the exterior of the pool structure, not the dimensions of the pool interior.

1. All depths reflect the depth of the pool structure. Water depths may vary depending on the amount of water in the pool.
2. Additional specifications are available at [thursdaypools.com](http://thursdaypools.com).





CALIFORNIA FINISH



GRAPHITE FINISH\*  
COLOR CURRENTLY UNAVAILABLE



CALIFORNIA FINISH



To see more of Sun Day, scan this code or visit [ThursdayPools.com](http://ThursdayPools.com)

# LIL BOB

YOUR SOCIAL LIFE STARTS HERE

## POOL SIZE

13.5' X 27.5'

There's always a party waiting to happen with Lil Bob in your backyard. You'll have hours of fun because he has something for everyone. Let the party begin!

1. **4'6" flat-bottom depth** is ideal for games, water activities, and entertaining.
2. **Elongated benches** provide hours of socializing and fun with family and friends.
3. **Full-length entry steps** make for easy entrance and exit from the pool.
4. **Non-skid surface** on the floor, benches, and steps is easy on your feet and your swimsuit.
5. **Auto-cover ready** to help you keep your new pool safe and clean.

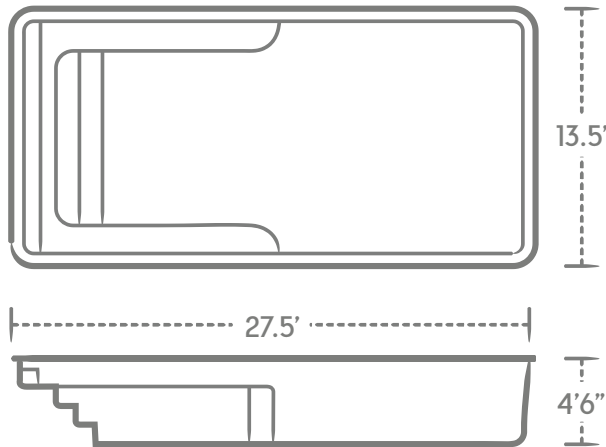

\*Non-Diving Pool  
\*See Safety Information

All measurements given reflect the dimensions of the pool to the exterior of the pool structure, not the dimensions of the pool interior.

1. All depths reflect the depth of the pool structure. Water depths may vary depending on the amount of water in the pool.
2. Additional specifications are available at [thursdaypools.com](http://thursdaypools.com).



CALIFORNIA FINISH



SANDSTONE FINISH





CALIFORNIA FINISH



CALIFORNIA FINISH



CALIFORNIA FINISH

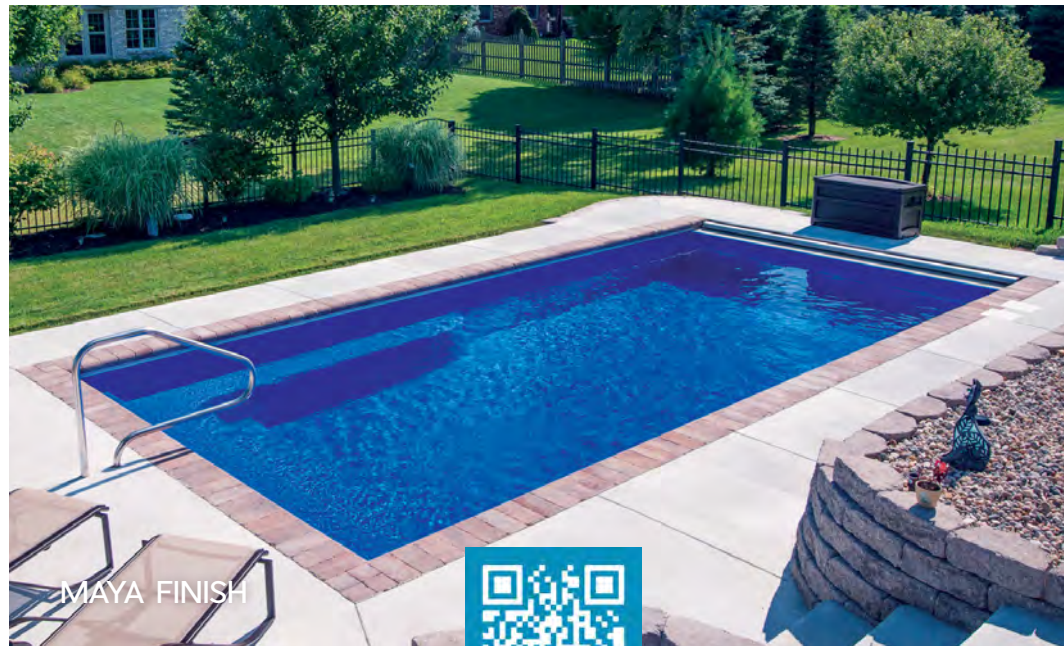

MAYA FINISH



To see more of Lil Bob, scan this code or visit [ThursdayPools.com](http://ThursdayPools.com)

# LIL BOB LX

## VERSATILE LUXURY

### POOL SIZE

13.5' X 35.5'

Lil Bob LX takes the party to a whole new level for kids of all ages with room to relax, exercise and play all around.

1. **12" deep tanning ledge** is perfect for ledge loungers and soaking up the sun.
2. **18" deep wading area** is an ideal spot for toddlers to play or for adults to enjoy a full-body soak.
3. **Wrap-around benches** give you tons of room to visit and relax.
4. **4'6" flat-bottom depth** is great for games, water activities, and entertaining.
5. **Non-skid surface** on the floor, benches, and steps is easy on your feet and your swimsuit.
6. **Auto-cover ready** to help you keep your new pool safe and clean.

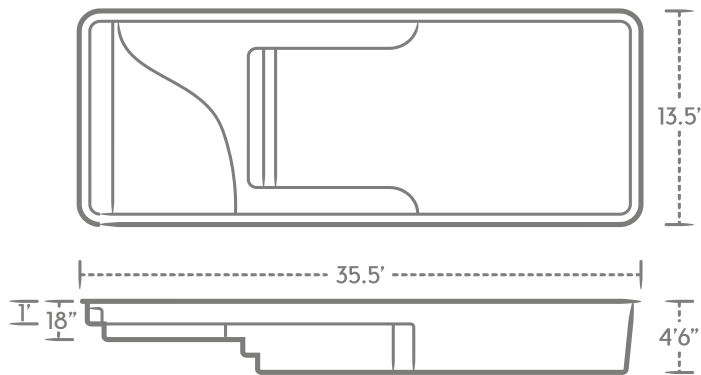

\*Non-Diving Pool  
\*See Safety Information

All measurements given reflect the dimensions of the pool to the exterior of the pool structure, not the dimensions of the pool interior.

1. All depths reflect the depth of the pool structure. Water depths may vary depending on the amount of water in the pool.
2. Additional specifications are available at [thursdaypools.com](http://thursdaypools.com).





CALIFORNIA FINISH



CALIFORNIA FINISH



CARIBBEAN SPARKLE FINISH



CARIBBEAN SPARKLE FINISH



To see more of Lil Bob LX, scan this code or visit [ThursdayPools.com](http://ThursdayPools.com)

# CATHEDRAL

## TIMELESS ELEGANCE

### POOL SIZE

14' X 33'

The classic Roman shape of the Cathedral will grace your backyard with style and refined elegance while creating an oasis for fun and relaxation.

1. **Classic design** gives curves and character without sacrificing swim area.
2. **Non-skid surface** on the floor, stairs, and benches is easy on your feet and your swimsuit.
3. **Wide steps and bench area** add style and functionality.
4. **Deep-end bench** gives you a place to soak and unwind.

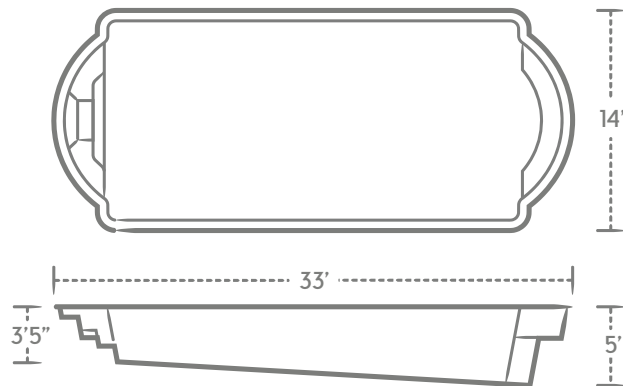

\*Non-Diving Pool  
\*See Safety Information

All measurements given reflect the dimensions of the pool to the exterior of the pool structure, not the dimensions of the pool interior.

1. All depths reflect the depth of the pool structure. Water depths may vary depending on the amount of water in the pool.
2. Additional specifications are available at [thursdaypools.com](http://thursdaypools.com).





MAYA FINISH



CALIFORNIA FINISH



MAYA FINISH



MAYA FINISH



To see more of Cathedral, scan this code  
or visit [ThursdayPools.com](http://ThursdayPools.com)

# CATHEDRAL LX

## GRACIOUS LIVING

### POOL SIZES

**16' X 36'** **16' X 40'**

The Cathedral LX envelops all the great features and awe-inspiring vistas of the original Cathedral and adds easy in-and-out steps the whole family will love. Plus, the sun shelf is heaven for the sun worshipers in your group.

1. **Classic design** gives curves and character without sacrificing swim area.
2. **Deep-end bench** gives you a place to soak and unwind.
3. **9' diameter tanning ledge** accommodates two chairs or ledge loungers.
4. **Non-skid surface** on the floor, stairs, and benches is easy on your feet and your swimsuit.
5. **Easy in-and-out wide steps and bench** area add both style and functionality.

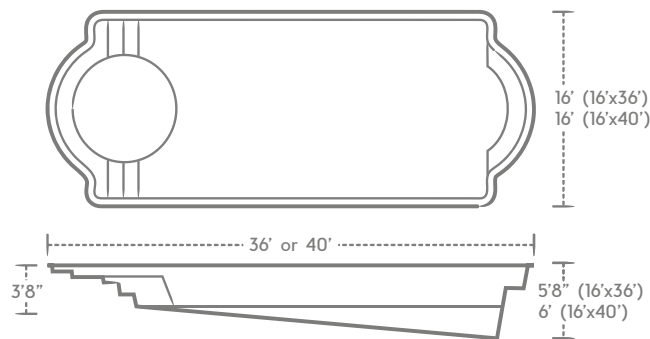

\*Non-Diving Pool  
\*See Safety Information

All measurements given reflect the dimensions of the pool to the exterior of the pool structure, not the dimensions of the pool interior.

1. All depths reflect the depth of the pool structure. Water depths may vary depending on the amount of water in the pool.
2. Additional specifications are available at [thursdaypools.com](http://thursdaypools.com).





CALIFORNIA FINISH



MAYA FINISH



CALIFORNIA FINISH



CALIFORNIA FINISH



To see more of Cathedral LX, scan this code  
or visit [ThursdayPools.com](http://ThursdayPools.com)

# SPIRIT

A REASON TO CHEER

## POOL SIZE

13.5' X 40'

The whole family will fall in love with the Spirit. It's got everything that kids of all ages want—cozy spots to relax and plenty of room to play!

1. **Full-length entry steps** for easy entrance and exit from the pool.
2. **Elongated benches** for hours of socializing and fun with family and friends.
3. **Sport pool depth so you can** enjoy a spirited game with friends and family.
4. **Auto-cover ready** to help you keep your new pool safe and clean.
5. **Non-skid surface** on the floor, benches, and steps is easy on your feet and your swimsuit.

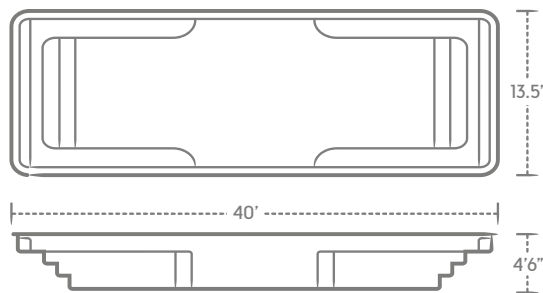

\*Non-Diving Pool  
\*See Safety Information

All measurements given reflect the dimensions of the pool to the exterior of the pool structure, not the dimensions of the pool interior.

1. All depths reflect the depth of the pool structure. Water depths may vary depending on the amount of water in the pool.
2. Additional specifications are available at [thursdaypools.com](http://thursdaypools.com).



CALIFORNIA FINISH



DIAMOND FINISH





DIAMOND FINISH



CALIFORNIA FINISH



CARIBBEAN SPARKLE FINISH



DIAMOND FINISH



To see more of Spirit, scan this code or visit [ThursdayPools.com](http://ThursdayPools.com)

# SANDAL BEACH ENTRY

Utility Pool System Patent US 10,472,839

## LIFE'S A BEACH

### POOL SIZES

16' X 34.5' 16' X 39'

**You'll feel like every day is a lazy day by the sea with Sandal. It brings all the joy of a day at the beach without the sand in your swimsuit!**

1. **A zero entry** that is perfect for dipping your toes in the water and lounging at the water's edge.
2. **A non-skid surface** on the floor, stairs, and benches is easy on your feet and your swimsuit.
3. **A 12" deep sun shelf and swim-out** are perfect for ledge lounging and soaking up the sun.
4. **A courtesy ledge around the deep-end** gives you a place to take a break and stand.

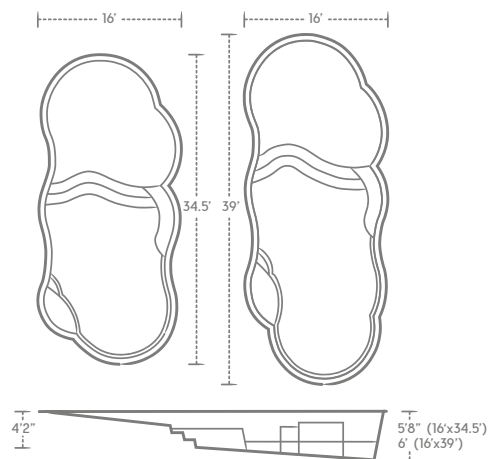

\*Non-Diving Pool  
\*See Safety Information

All measurements given reflect the dimensions of the pool to the exterior of the pool structure, not the dimensions of the pool interior.

1. All depths reflect the depth of the pool structure. Water depths may vary depending on the amount of water in the pool.
2. Additional specifications are available at [thursdaypools.com](http://thursdaypools.com).

Utility Pool System Patent US 10,472,839





CALIFORNIA FINISH



CALIFORNIA FINISH



CALIFORNIA FINISH

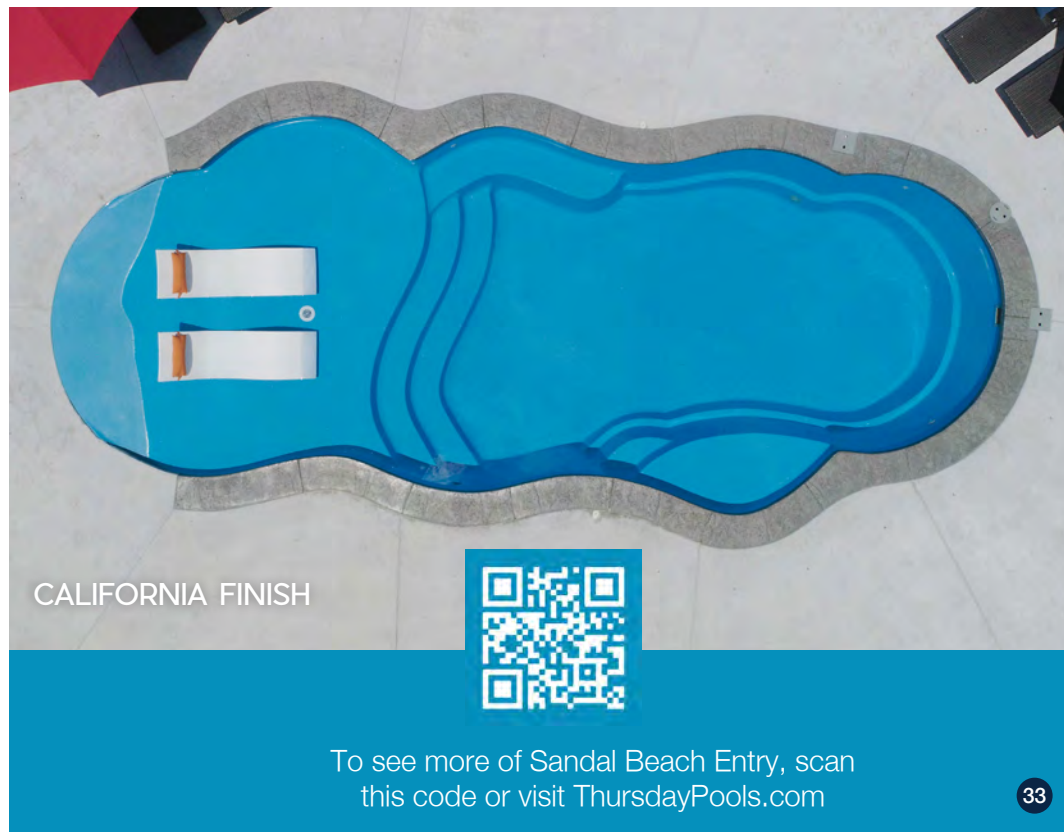

CALIFORNIA FINISH



To see more of Sandal Beach Entry, scan this code or visit [ThursdayPools.com](http://ThursdayPools.com)

# TITUS

## EPIC FUN

### POOL SIZES

12' X 26' 14' X 33'

If you're after a little exercise or just a refreshing dip, Titus is your guy. He's ready to create a diversion from the everyday blues every day of the week.

1. **Wide-entry steps with built-in seats** make a great spot for visiting and relaxing.
2. **Non-skid surface** on the floor, benches, and steps is easy on your feet and your swimsuit.
3. **Elongated benches** provide hours of socializing and fun with family and friends.
4. **Ideal depth for exercise** so you can enjoy water aerobics, games, and more.

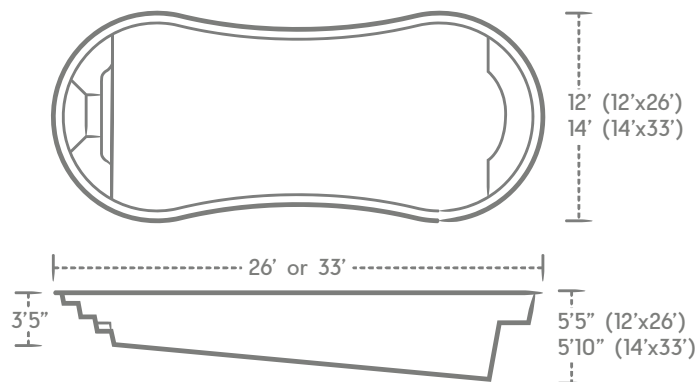

\*Non-Diving Pool  
\*See Safety Information

All measurements given reflect the dimensions of the pool to the exterior of the pool structure, not the dimensions of the pool interior.

1. All depths reflect the depth of the pool structure. Water depths may vary depending on the amount of water in the pool.
2. Additional specifications are available at [thursdaypools.com](http://thursdaypools.com).



CALIFORNIA FINISH



CALIFORNIA FINISH



ARCTIC FINISH



CALIFORNIA FINISH



To see more of Titus, scan this code  
or visit [ThursdayPools.com](http://ThursdayPools.com)



SEA TURTLE | CALIFORNIA FINISH



ASPEN | CALIFORNIA FINISH



PEARL | CALIFORNIA FINISH

SMALL  
SIZE  
POOLS

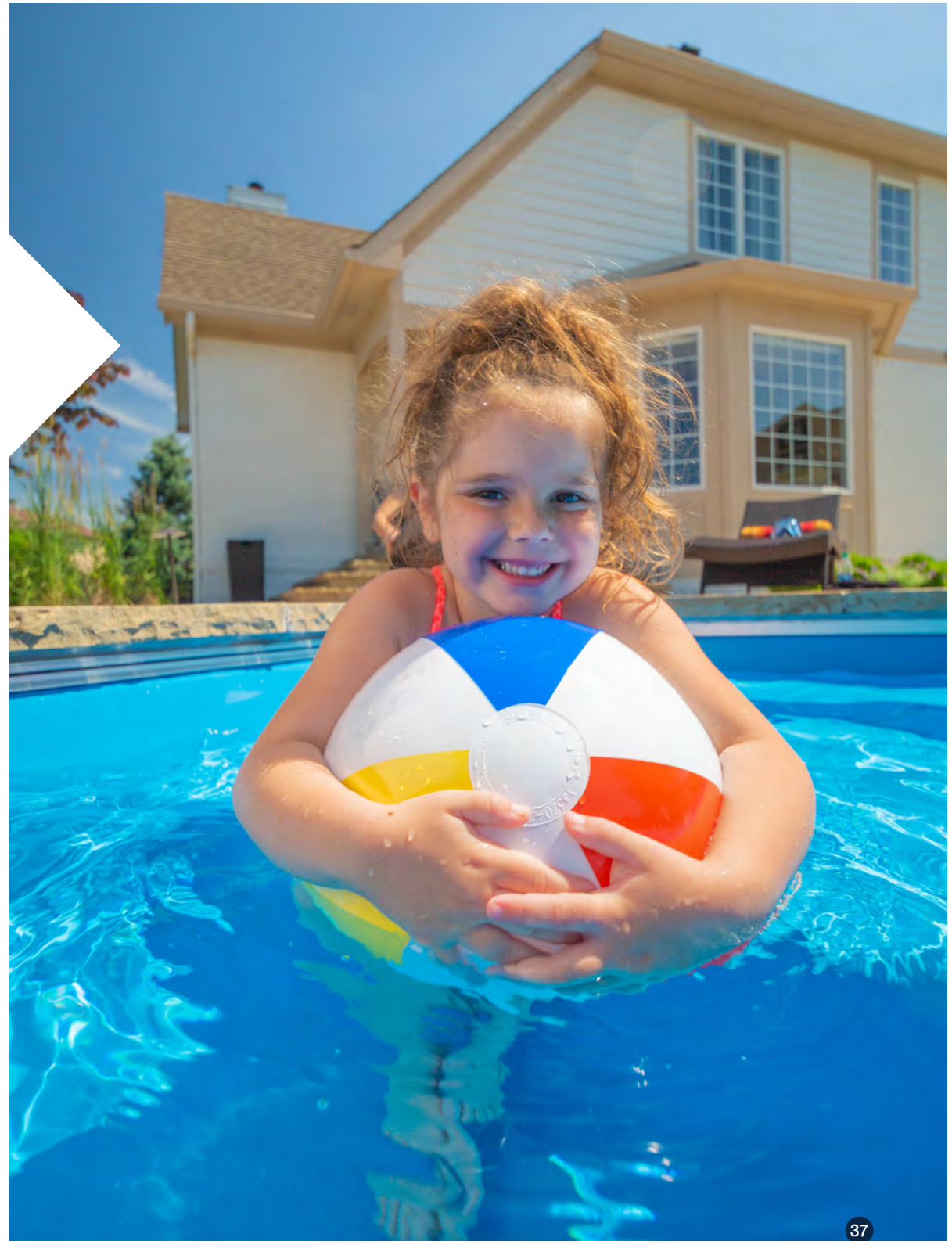

# PEARL

## AN EXCLUSIVE DESIGN

### POOL SIZE

15' X 25'

Petite and lovely, with graceful scalloped edges, our Pearl is truly a gem. It fits well in nearly any backyard and provides a lovely locale for socialization and relaxation.

1. **12" deep tanning ledge** is perfect for ledge loungers and soaking up the sun.
2. **Non-skid surface** on the floor, benches, and steps is easy on your feet and your swimsuit.
3. **Wrap-around benches** give you plenty of room to visit and relax.

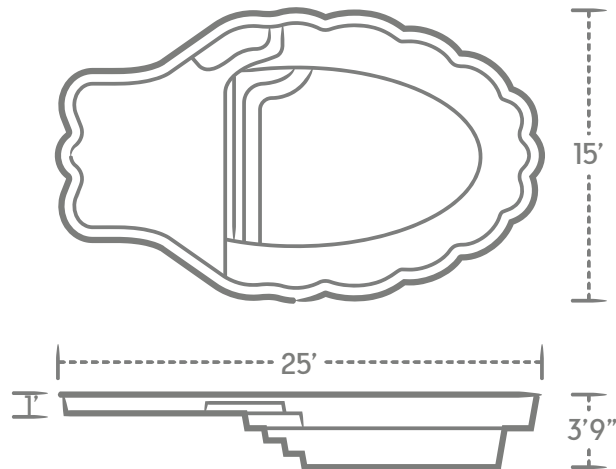

\*Non-Diving Pool  
\*See Safety Information

All measurements given reflect the dimensions of the pool to the exterior of the pool structure, not the dimensions of the pool interior.

1. All depths reflect the depth of the pool structure. Water depths may vary depending on the amount of water in the pool.
2. Additional specifications are available at [thursdaypools.com](http://thursdaypools.com).



CALIFORNIA FINISH



CALIFORNIA FINISH





CALIFORNIA FINISH

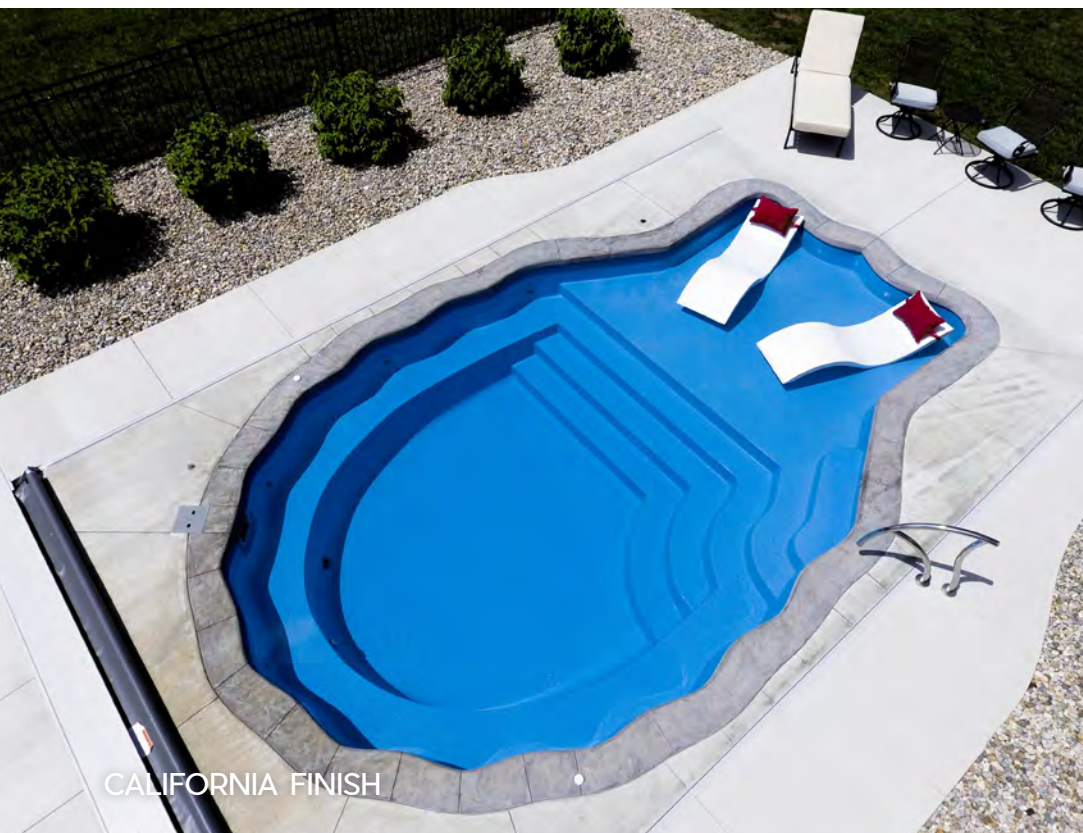

CALIFORNIA FINISH



CALIFORNIA FINISH



To see more of Pearl, scan this code  
or visit [ThursdayPools.com](http://ThursdayPools.com)

# SEA TURTLE

## SLOW DOWN TIME

### POOL SIZE

9.5' X 19.5'

Let time stand still as you savor every moment. Whether you want to chill or get a game on, Sea Turtle accommodates.

1. **Elongated benches** provide hours of socializing and fun with family and friends.
2. **4'6" flat-bottom depth** is great for games, water activities, and entertaining.
3. **Non-skid surface** on the floor, benches, and steps is easy on your feet and your swimsuit.
4. **Auto-cover ready** to help you keep your new pool safe and clean.
5. **Swim jet system-ready design** makes it easy to add a swim jet system such as Badu®.

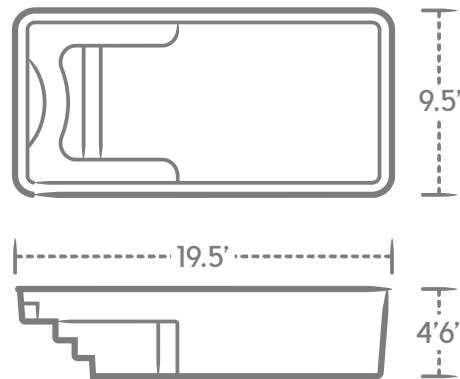

\*Non-Diving Pool  
\*\*See Safety Information

All measurements given reflect the dimensions of the pool to the exterior of the pool structure, not the dimensions of the pool interior.

1. All depths reflect the depth of the pool structure. Water depths may vary depending on the amount of water in the pool.
2. Additional specifications are available at [thursdaypools.com](http://thursdaypools.com).



CARIBBEAN SPARKLE FINISH

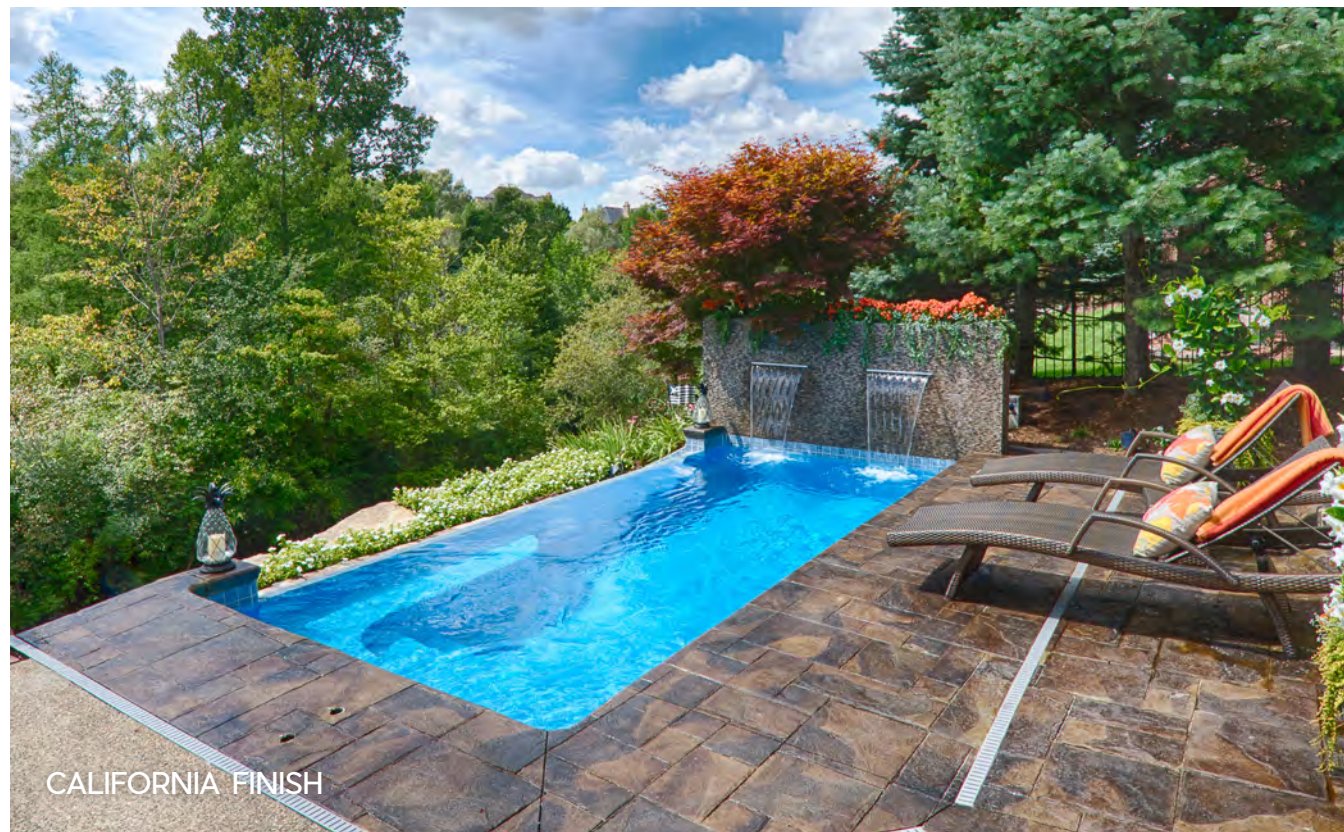

CALIFORNIA FINISH



CARIBBEAN SPARKLE FINISH



CARIBBEAN SPARKLE FINISH



CALIFORNIA FINISH



CARIBBEAN SPARKLE FINISH



To see more of Sea Turtle, scan this code or visit [ThursdayPools.com](http://ThursdayPools.com)



ASPEN | SANDSTONE FINISH

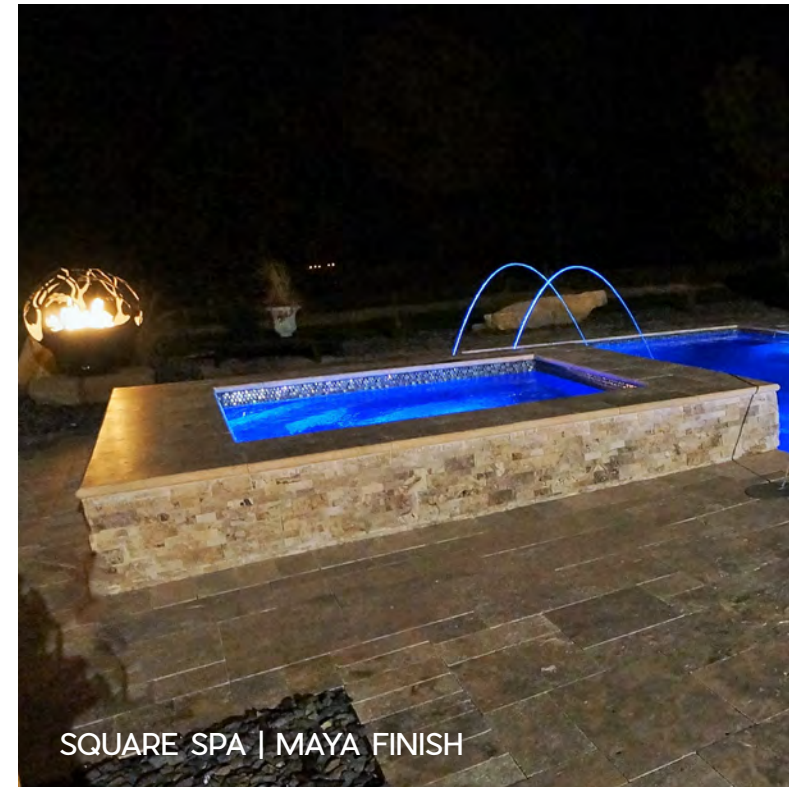

SQUARE SPA | MAYA FINISH



SQUARE SPA | CARIBBEAN SPARKLE FINISH

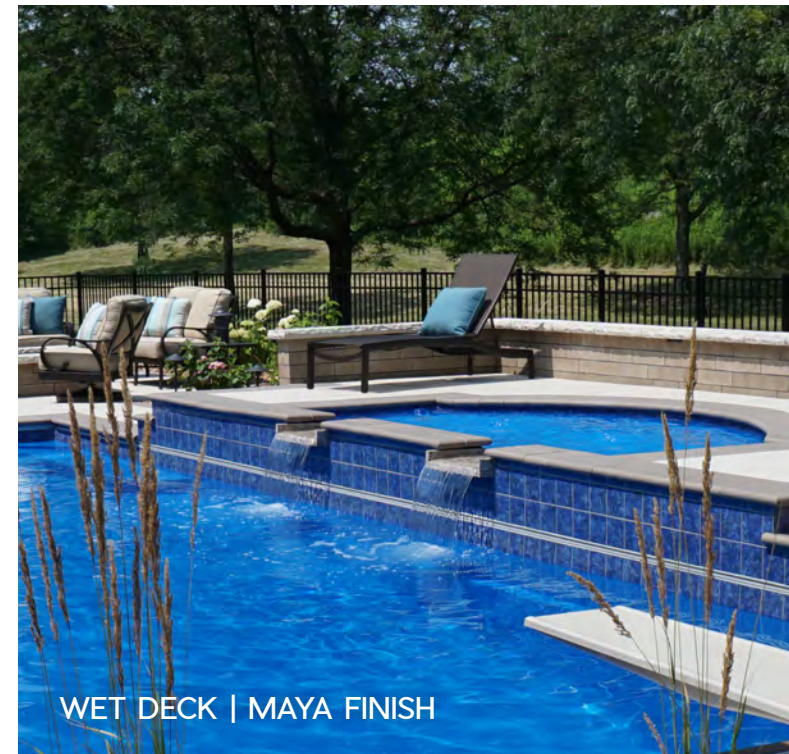

WET DECK | MAYA FINISH



GOLIATH | MAYA FINISH

# FEATURES & OPTIONS



LIL BOB | CALIFORNIA FINISH

# SPA

## ADD-ON LUXURY

### SPA SIZES

9'X9' 8'6"X8'6"

If you're looking for the ultimate in luxury and relaxation, adding a spa to your pool is certain to deliver. Go ahead. You deserve it.

1. **Room for seven people** means you can share the luxury.
2. **Luxurious bubbling water** relieves tension, reduces stress, and promotes overall wellness.
3. **Non-skid surface** on the floor, benches, and steps is easy on your feet and your swimsuit.
4. **Raised or flush construction application** gives you installation options.
5. **Auto-cover ready** to help you keep your new spa safe and clean.

Note: spa jets and fittings are not outfitted at the factory and are the responsibility of the dealer.

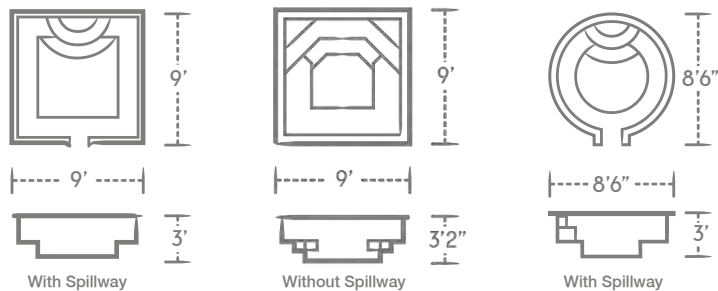

\*Non-Diving Pool  
\*See Safety Information

All measurements given reflect the dimensions of the pool to the exterior of the pool structure, not the dimensions of the pool interior.

1. All depths reflect the depth of the pool structure. Water depths may vary depending on the amount of water in the pool.
2. Additional specifications are available at [thursdaypools.com](http://thursdaypools.com).





MAYA FINISH



MAYA FINISH



To see more of our round spas, scan this code or visit [ThursdayPools.com](http://ThursdayPools.com)



CARIBBEAN SPARKLE FINISH



To see more of our square spas, scan this code or visit [ThursdayPools.com](http://ThursdayPools.com)

# GRAND SPA

DE-STRESS AND IMPROVE  
YOUR WELL-BEING

## SPA SIZE

11'6" X 11'10"

Some days enough is enough. The Grand Spa is the perfect place to relax and ease those aches and pains. From soaking up the sun to chilling after exercise in your swimming pool, you'll have just the right spot to release all that tension.

1. Room for seven to nine of your best friends makes it worth sharing.
2. A grand hot soak or sumptuous bubbling water for relaxation perfection.
3. Spillway option to enhance the atmosphere.
4. Raised or flush construction applications to make it uniquely yours.

Note: spa jets and fittings are not outfitted at the factory and are the responsibility of the dealer.

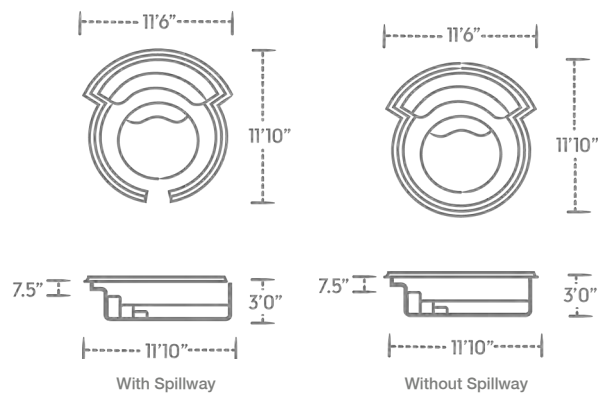

\*Non-Diving Pool  
\*See Safety Information

All measurements given reflect the dimensions of the pool to the exterior of the pool structure, not the dimensions of the pool interior.

1. All depths reflect the depth of the pool structure. Water depths may vary depending on the amount of water in the pool.
2. Additional specifications are available at [thursdaypools.com](http://thursdaypools.com).







CALIFORNIA FINISH



To see more of Grand Spa, scan this code  
or visit [ThursdayPools.com](http://ThursdayPools.com)

# WADING POOL

## SPLASH AND PLAY

### POOL SIZES

9'X9' 13'9"X11'9"

This is the ultimate playground for the kiddos. The uniform depth throughout allows for easy, worry-free play, and the bench is a great spot for the big kids to sit, relax, and watch over the youngsters.

1. **18" depth** makes a wonderful place for toddlers and pets to splash and play.
2. **Non-skid surface** on the floor, benches, and steps is easy on your feet and your swimsuit.
3. **Raised or flush construction application** gives you installation options.
4. **Auto-cover ready** to help you keep your new pool safe and clean.
5. **Full-length bench** gives you the perfect spot to relax, cool off, and watch the kids play.

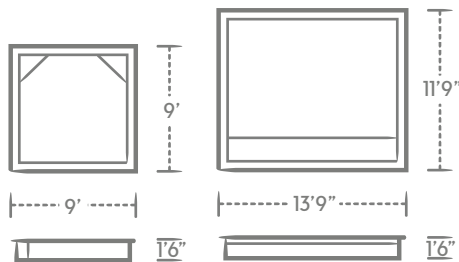

\*Non-Diving Pool  
\*See Safety Information

All measurements given reflect the dimensions of the pool to the exterior of the pool structure, not the dimensions of the pool interior.

1. All depths reflect the depth of the pool structure. Water depths may vary depending on the amount of water in the pool.
2. Additional specifications are available at [thursdaypools.com](http://thursdaypools.com).



MAYA FINISH



MAYA FINISH



MAYA FINISH



MAYA FINISH



To see more of Wading Pool, scan this code or visit [ThursdayPools.com](http://ThursdayPools.com)

# WET DECK

## AN ELEGANT WATER FEATURE

### DECK SIZE

14' X 8'

Just want to get your feet wet? The Wet Deck is a marvelous addition to any pool with custom spillway options to enhance your private backyard paradise.

1. **12" deep lounging area** is great for kids and sunbathers.
2. **Non-skid surface** on the floor is easy on your feet and your swimsuit.
3. **Custom spillway options** are available to enhance the ambiance.
4. **Raised deck application** gives you a multi-dimensional pool area.

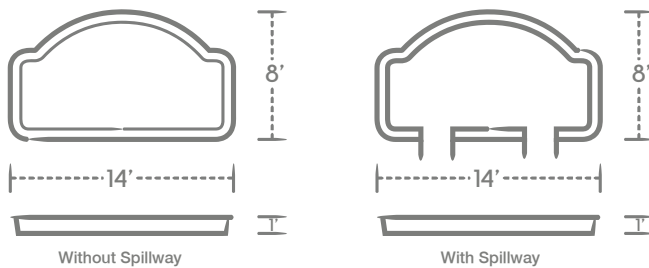

\*Non-Diving Pool  
\*See Safety Information

All measurements given reflect the dimensions of the pool to the exterior of the pool structure, not the dimensions of the pool interior.

1. All depths reflect the depth of the pool structure. Water depths may vary depending on the amount of water in the pool.
2. Additional specifications are available at [thursdaypools.com](http://thursdaypools.com).



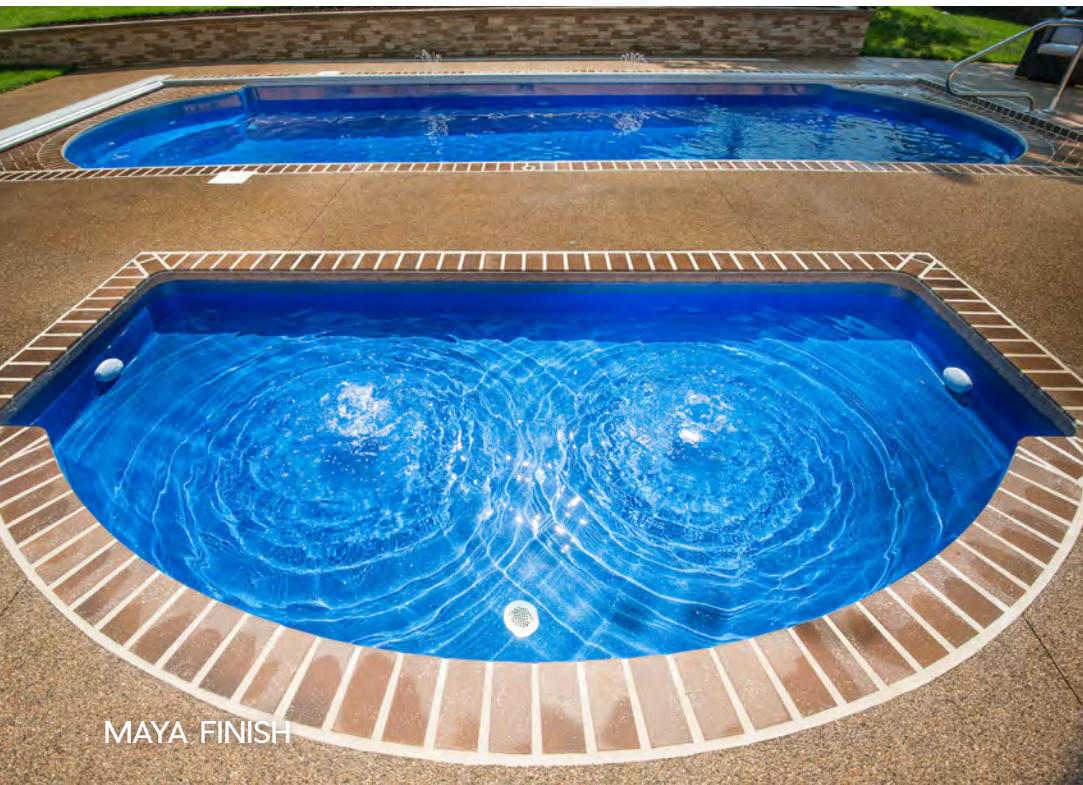

MAYA FINISH



CALIFORNIA FINISH



MAYA FINISH

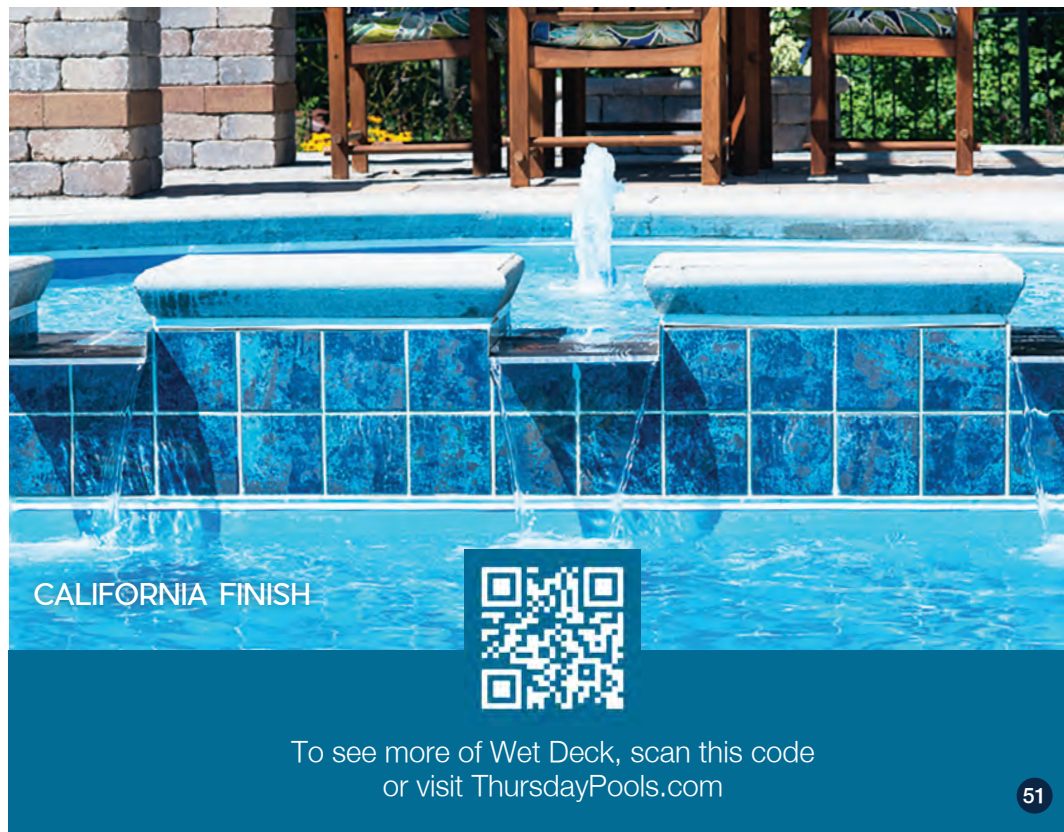

CALIFORNIA FINISH



To see more of Wet Deck, scan this code or visit [ThursdayPools.com](http://ThursdayPools.com)

# CREATE A FIRST IMPRESSION THAT LASTS A LIFETIME

A RESORT LUXURY FINISH DESERVES PROPER CARE AND COVER

## GET A HIGH-END RESORT FINISH IN YOUR BACKYARD

Your pool's interior surface shade, tile, landscaping, sunlight, and water depth influence your water color, which will set the stage for the atmosphere you create. Many upscale resorts produce their luxurious pool appearance by using colors like our Caribbean Sparkle, Diamond, Sandstone, and Arctic. The classic blue California and Maya shades are also popular choices.

*Note: all colors can suffer damage if water chemistry is not within range at all times. Color selections are subject to change without notice. Colors vary by manufacturer and batches. Actual colors may vary from photographic representations.*



To learn more about our colors, scan this code or visit  
[ThursdayPools.com](http://ThursdayPools.com)

# GREAT CARE BEGINS WITH WATER CHEMISTRY

You must maintain proper water chemistry to ensure the best protection of your fiberglass pool's surface finish. Proper water chemistry involves both water balance and ideal levels of chemicals in the water. Water balance refers to the Saturation Index (Si). The saturation index is commonly calculated using the Langelier Saturation Index method. This calculation relates to pH, alkalinity, conductivity/TDS, hardness (calcium), cyanuric acid, and temperature. pH significantly affects the calculation, but note that chlorine has none. The ideal Si is -0-. A positive Si will be more likely to stain and scale, and a negative Si will be more corrosive. Balanced pool water means the Si is -0-. The minimum water chemical levels that should be maintained are pH, alkalinity, free chlorine, cyanuric acid, hardness, metals TDS, and salt if necessary.

Note: the pool owner is ultimately responsible for the water chemistry that will determine whether the fiberglass surface has received proper care. A pool owner must have complete knowledge of pool water chemistry and maintenance to care for the pool themselves. If they do not have that knowledge, they are responsible for locating and using someone that does. They must still ensure that any outside help they employ is competent in pool water chemistry and maintenance specific to a fiberglass pool. See our owner's manual for our recommended water chemistry levels at <https://thursdaypools.com/owners-manual/>.



## KEEP IT SAFE WITH AN AUTOMATIC POOL COVER



Automatic pool covers help protect your pool investment, and even more importantly, they help protect those who matter most. Safety will always be your top concern with your new pool, and an automatic pool cover will give you added security and peace of mind.

An automatic pool cover will provide you with a more enjoyable pool ownership experience by reducing the amount of time, money, and energy you'll need to spend on pool maintenance. They keep debris out and chemicals in.

*It's important to note that automatic pool covers should never be the sole barrier to pool entry. Thursday Pools, along with The Pool and Hot Tub Alliance, believe every pool should have multiple layers of protection, such as fencing with locking gates, alarms, etc.*



ASPEN | CALIFORNIA FINISH





WHY  
THURSDAY  
POOLS?

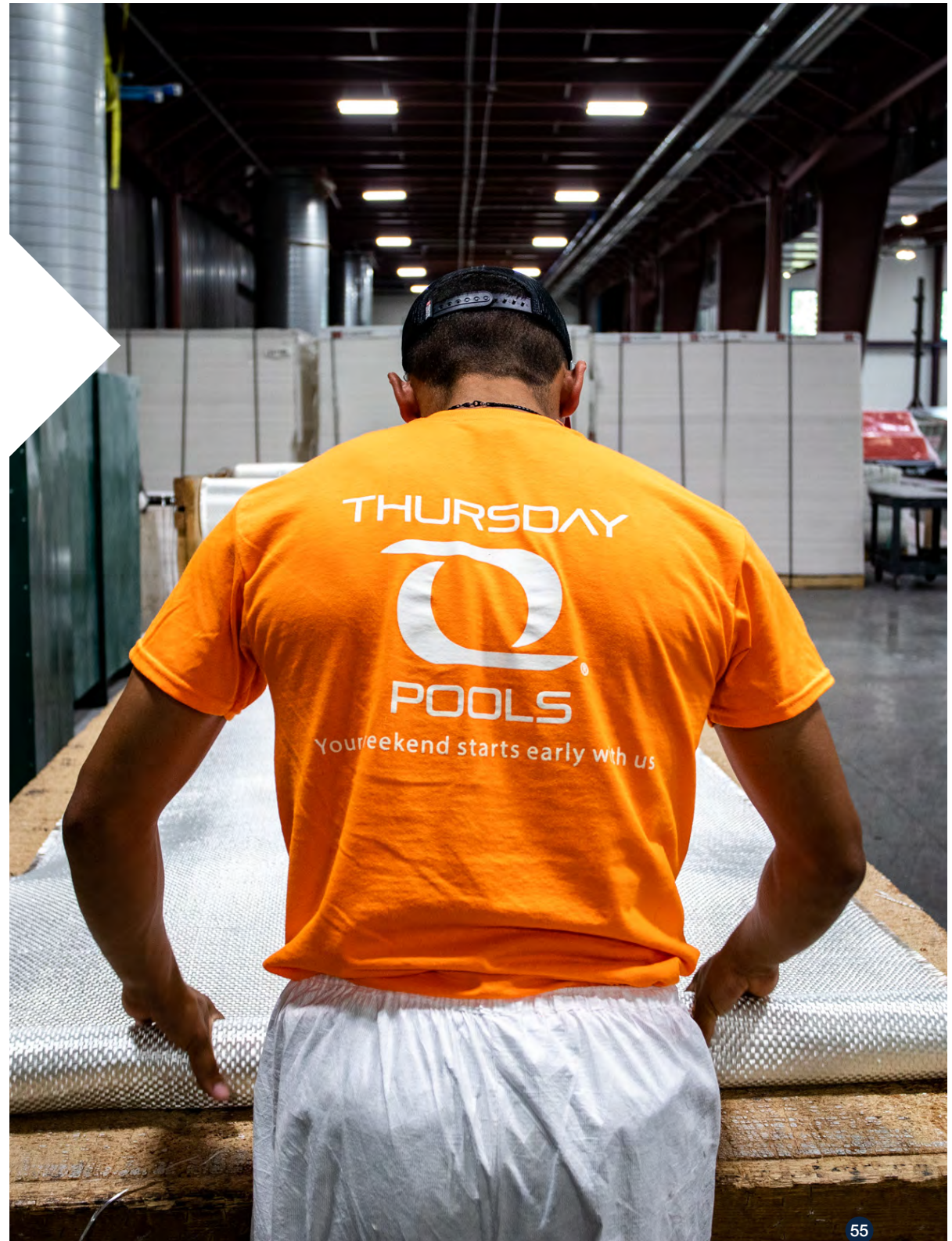

# BENEFITS OF FIBERGLASS

Fiberglass pools are elegant, durable, and beautiful, but the surface beauty is just the beginning of the story. Here are just a few reasons why you might choose a Thursday Pools fiberglass pool:

- **They're handcrafted by skilled artisans in an ISO 9001 manufacturing facility.**
- **Less maintenance and chemicals means more free time for you.**
- **High-end design features like tanning ledges and benches.**
- **They give you lower lifetime cost of ownership with no replastering.**
- **The surface and designs are pet-friendly with multiple entry and exit points.**
- **The smooth surface won't snag swimsuits or cause scratches.**

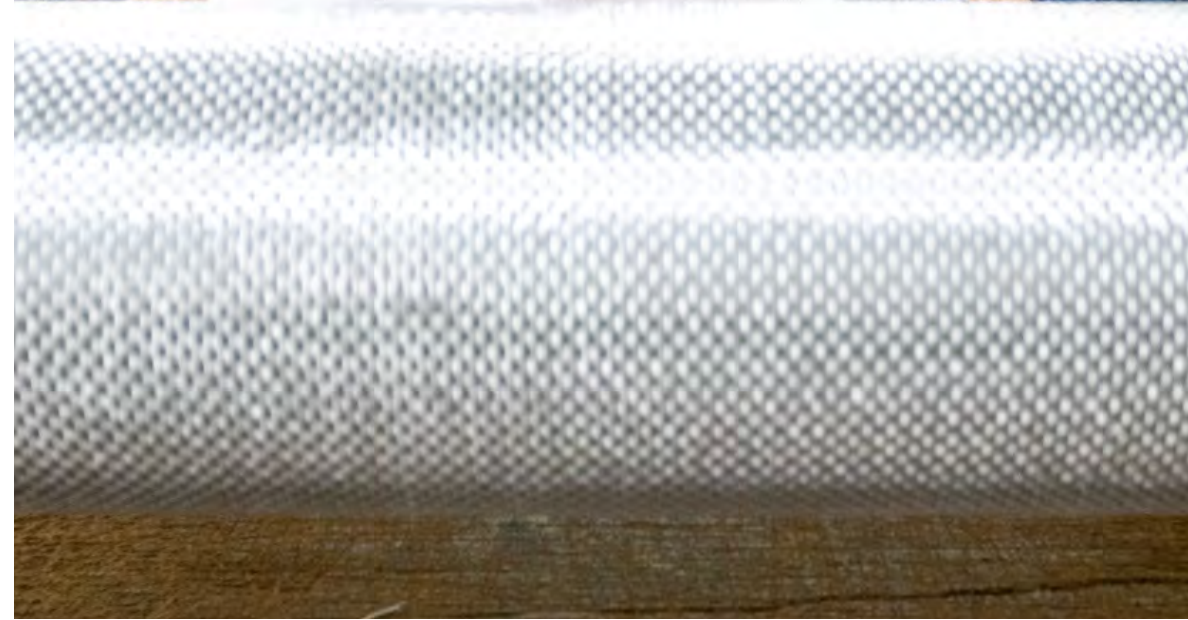



# ISO CERTIFICATIONS

## EXCEEDING STANDARDS IN MANUFACTURING AND ENVIRONMENTAL MANAGEMENT



## WHAT IS ISO 9001 CERTIFICATION?

ISO 9001 is an international standard that specifies requirements for quality management systems. Manufacturers who receive this certification have demonstrated a commitment to follow ISO-prescribed systems for quality control and continuous improvement.

### Here's what our ISO 9001 certification means to you:

- You can trust that we meet the industry standard with our manufacturing systems for every step of our process, including receiving incoming raw materials, equipment set-up, material application, and final product loading and shipping.
- You can feel confident that your new Thursday Pools fiberglass pool is made from high quality materials because we hold our suppliers to the same high standards.
- Your fiberglass pool shell has a smaller environmental footprint. Over the years, you'll never need to replace a liner or apply an acid wash on the surface. You'll also require fewer chemicals to maintain your water's proper chemistry balance.
- Thursday Pools is a proud member of the Indiana Partners for Pollution Prevention and the Indiana Department of Environmental Management's Environmental Stewardship Program. These voluntary and performance-based sustainability leadership programs recognize and reward Indiana entities for going above and beyond existing environmental regulations.





## WHAT IS ISO 14001 CERTIFICATION?

ISO 14001 certification is an international standard that specifies requirements for an effective environmental management system. Manufacturers who receive this certification have agreed to implement and continue an effective Environmental Management System that includes continuously reviewing and measuring the organization's current and future processes for environmental impact, proactively reducing its environmental footprint, and creating a safer and healthier work environment for its employees.

### Here's what our ISO 14001 certification means to you:

- You can feel good about having purchased a new fiberglass pool made by a company that actively promotes efficient use of natural resources to create the smallest possible environmental footprint.
- You can trust that your new fiberglass pool is produced with Boron-free glass and uses less energy to manufacture and ship.
- You'll know that your new fiberglass pool was made by a company that works with both the Environmental Protection Agency (EPA) and the Indiana Department of Environmental Management (IDEM) to maintain a Title V clean air permit as well as a commitment to recycling all possible production waste.
- Your fiberglass pool shell has a smaller environmental footprint. Over the years, you'll never have to replace a liner or use an acid wash on the surface. You'll also need fewer chemicals to maintain your water's chemistry balance.



# WHAT TO EXPECT

---

**Once you decide on the pool of your dreams, a process is in place to keep things moving smoothly. Here is an overview of that process, as well as some important things you should know:**

**You will be asked to sign an acknowledgment and register your warranty** before signing your contract with your dealer. However, your warranty does not take effect until the day of installation.

**Pool shell orders require a 50% deposit from your dealer to Thursday Pools to go into production.** This means the production lead time we have established will not begin until the deposit is received.

**Ask your dealer for a lead time at the time of your pool shell order.** Only your dealer can answer questions concerning payment, production, or delivery of your pool shell.

**Prior to shipping being scheduled, your dealer must pay any remaining balance.** Again, all requests and questions concerning pool shell orders and delivery must be directed to the dealer.



# HOW TO PROTECT YOUR INVESTMENT

**Do your due diligence.** The dealers go through an application process; however, that should not replace your own vetting of the dealer. Thursday Pools, LLC is not responsible for the obligations of the dealer. Ask for references. Ensure the dealer can answer all your questions thoroughly, professionally, and patiently. Be leary of down payments that are significantly above the market average. An ideal draw schedule should match the amount of work done.

**Read through your contract with the dealer.** Make sure you understand everything outlined within it and ask any questions you have prior to signing. Consider getting a second opinion if you are not certain. Thursday Pools is not privy to your contract details, so any questions should be directed to your dealer.

\*Dealers are not employed by or are agents of Thursday Pools. They own and operate their own companies. Thursday Pools is simply a vendor to said company.



LIL BOB LX | CALIFORNIA FINISH

# WARRANTY

ON PAR WITH INDUSTRY STANDARD



Your new inground fiberglass pool is a once-in-a-lifetime investment that should be protected by a comprehensive warranty. At Thursday Pools, we operate on three guiding principles: honesty, integrity and mutual respect. Those principles guide our warranty too. When you buy a Thursday Pools fiberglass pool, you'll find that our warranty is comprehensive and easy to understand.

## Our Standard One-time Transferable Limited Warranty includes:

**Fiberglass Pool Limited Lifetime Structural Warranty:** Thursday Pools warrants your pool will not leak due to structural failures caused by workmanship and material used in manufacturing.

**15-Year Pool Surface Warranty:** Thursday Pools offers a 15-year surface warranty against osmotic blistering.

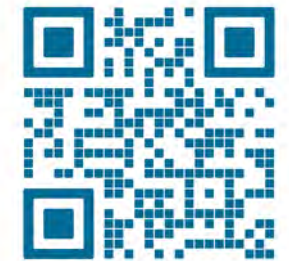
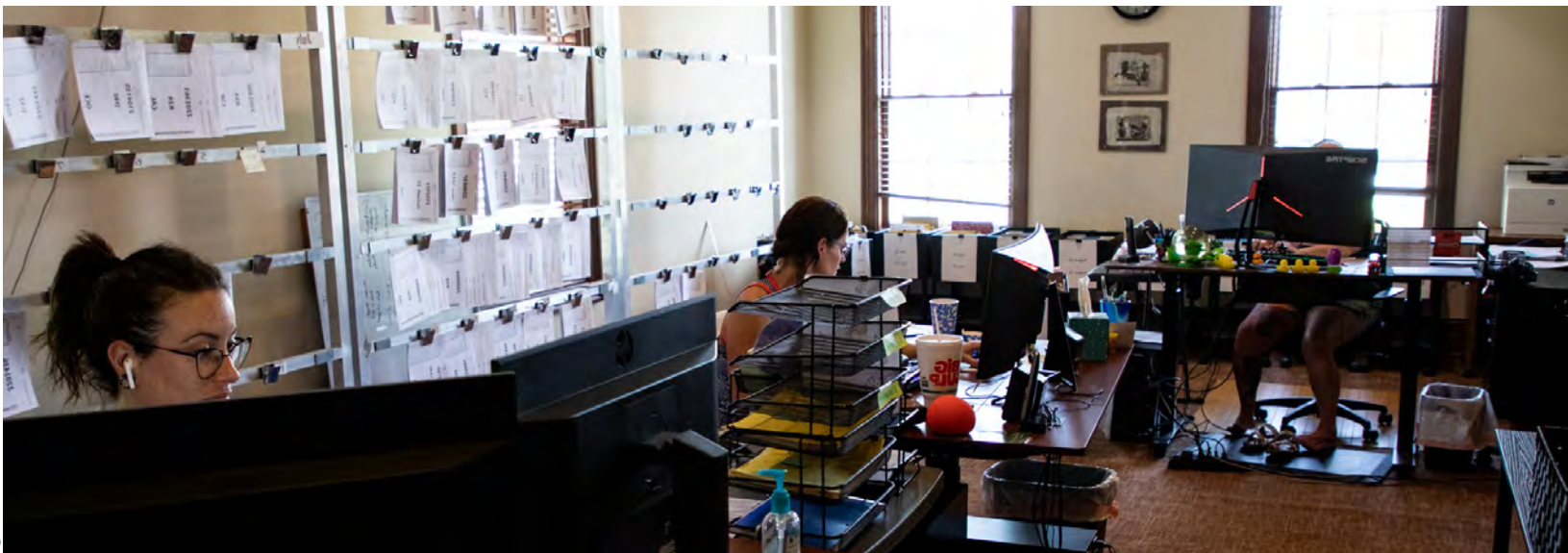

To learn more about warranty, scan this code or visit [ThursdayPools.com](http://ThursdayPools.com)



# INNOVATIONS



# THE TRIFECTA OF STRENGTH

## THREE SCHEDULES FOR A WINNING COMBINATION

While every part of each pool by Thursday Pools consists of multiple layers, some higher stress areas require more layers than others. We worked with the PINKTANK™ at Owens Corning to assess each point of a fiberglass pool and formulated three laminate schedules—aka the **1-2-3 Trifecta of Strength**—to build our pools according to each area’s structural needs. We take quality and durability seriously. Read more about each schedule and the layers that ensure you get the strongest pool we can manufacture.

**Schedule 1, which consists of 9 layers**, is used for all horizontal surfaces above the floor. It is also used to reinforce the walls with 6-inch wide, 3-foot vertical strips approximately every 2.5 feet around the pool.

**Schedule 2, also 9 layers**, is used for all higher-stress areas. The corners of steps, swimouts, tanning ledges, sun shelves, and benches are all reinforced with custom stitch mats, while an 18-inch wide strip of woven roving fiberglass runs along the floor’s inside perimeter and up the wall for extra strength where the floor and walls meet.

**Schedule 3 is 8 layers** and is used in areas that don’t require extra reinforcement, such as the floor (except the inside perimeter) and between the 6-inch wide vertical strips on the walls.

Note: Thursday Pools, LLC is committed to continuous improvement of products and processes. Improvements can be made through incremental refinement and breakthrough advancement. This build schedule may be modified as a result.



- ① Schedule 1: 9 Layers**
1. Gel Coat
  2. Vinyl Ester Barrier Coat
  3. Chopped Fiberglass
  4. Chopped Fiberglass
  5. Woven Roving Fiberglass
  6. Chopped Fiberglass
  7. Honeycomb Core
  8. Chopped Fiberglass
  9. Chopped Fiberglass

- ② Schedule 2: 9 Layers**
1. Gel Coat
  2. Vinyl Ester Barrier Coat
  3. Chopped Fiberglass
  4. Chopped Fiberglass
  5. Woven Roving Fiberglass
  6. Chopped Fiberglass
  7. Custom Stitch Mats/  
Woven Roving Fiberglass
  8. Chopped Fiberglass
  9. Chopped Fiberglass

- ③ Schedule 3: 8 Layers**
1. Gel Coat
  2. Vinyl Ester Barrier Coat
  3. Chopped Fiberglass
  4. Chopped Fiberglass
  5. Woven Roving Fiberglass
  6. Chopped Fiberglass
  7. Chopped Fiberglass
  8. Chopped Fiberglass

## LAYERS INCLUDE:



### **Gel Coat**

Our pool surface gel coat is designed to last and look luxurious. It's smooth, resistant to algae, and a dog's claws won't scratch it. Thursday Pools uses a high quality gel coat, so you can feel confident in your purchase knowing that your pool surface is one of the most tested and reputable on the market.

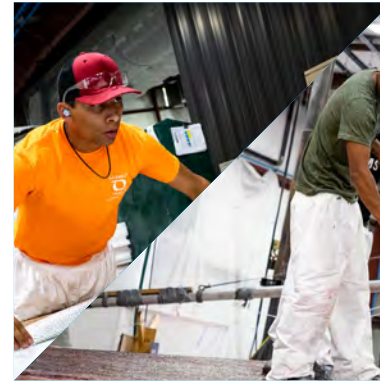

### **Chopped and Hand-Laid Roving Fiberglass**

Fiberglass is combined with 100 percent isophthalic polyester resin and no fillers for several pool layers. This type of resin is used where strength and durability is a must. Despite the costs and time involved, Thursday Pools uses both equipment-applied chopped fiberglass and hand-laid applied fiberglass to get the optimal physical properties that a best-in-class fiberglass pool requires.

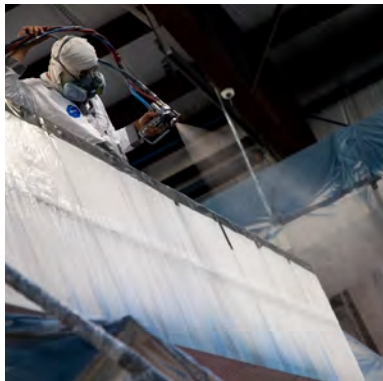

### **Vinyl Ester Barrier Coat**

Vinyl ester barrier coat helps enhance the longevity and performance of the fiberglass structure by providing an additional layer of protection against moisture and chemical degradation. Our vinyl ester barrier coat prevents potential blistering and protects the surface finish of your pool.



### **Custom Stitch Mats**

Our hand-laid stitch mats provide additional strength, stability, and reinforcement. The stitching helps to hold the fibers in place, preventing them from shifting or becoming misaligned, enhancing the structural integrity and impact resistance of the pool shell.

**THIS INNOVATION IS INCLUDED IN ALL OUR POOL DESIGNS.**



### **Honeycomb Core**

Thursday Pools adds vertical and horizontal supports throughout the pool using a honeycomb core structure. This construction technique is applied to all horizontal surfaces above the floor, such as steps, benches, and tanning ledges, and vertical strips along the pool wall.

# THURSDAY POOLS INNOVATIVE SKIMMERS

Thursday Pools has two skimmers specifically designed for the unique aspects of fiberglass pools. They were the first skimmers designed with a 7° angle and special mounting plate to provide a more polished look after installation. Not only do our skimmers look better, but they're all easier for your dealer to install.

## SKIMMER FEATURES

**7° Angle for Easy Installation.** Our skimmer is manufactured to account for the five to ten degree draft angle most fiberglass pool manufacturers use. The angled skimmer reduces the number of extension collars required to level the skimmer, makes for an easier installation and allows the pool to reach its optimum water level.

**Mounting Plate.** The lip over the opening on a traditional skimmer's mounting plate is not wide enough to cover the thickness of fiberglass pools. The Lucky 7 Skimmer's lip extends farther to ensure the raw fiberglass pool edge is not exposed, providing a more finished look.

**The Double-O7 Skimmer\* adds a couple of additional benefits to your pool.**

- Easily allows for maximum skimmer height and position.
- The sleek design matches LED lights, returns, bubblers, and other round features of your pool.
- A simple 6 7/8" standard hole cut helps with easy installation.

Please note: the Lucky 7 Skimmer and Double-O7 Skimmer are options on all of our fiberglass pool designs; however, neither comes standard.

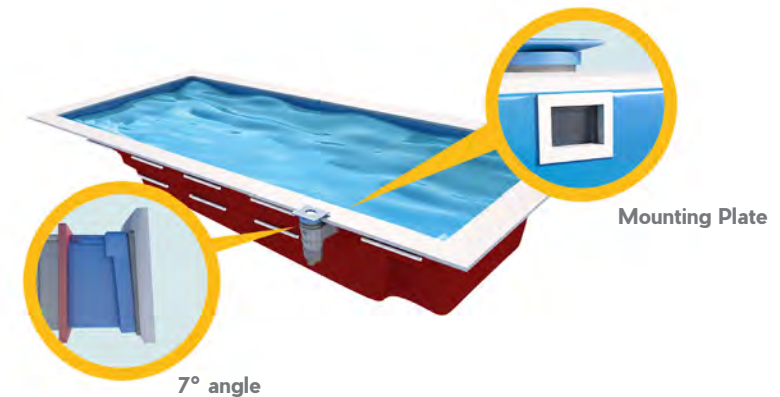

LUCKY7SEVEN<sup>®</sup>  
SKIMMER  
By Thursday Pools



DOUBLE-O7<sup>®</sup>  
SKIMMER  
By Thursday Pools



\*Double-O7 Skimmer US Patent 10,961,763

**THIS INNOVATION IS OPTIONAL  
AND NOT STANDARD.**

# GEO-ANCHOR POOL WALL<sup>®</sup>

SECURING YOUR INVESTMENT & PROVIDING EXTRA STRENGTH

Thursday Pools developed the fiberglass pool Geo-Anchor Pool Wall to help secure your investment by providing extra strength to the fiberglass pool structure.

## HOW DOES IT WORK?

### The Geo-Anchor Pool Wall (US Patent 9,593,455)

The Geo-Anchor Pool Wall helps prevent wall movement or bulging if water is lowered per the Thursday Pools Owner's Manual, which has specific requirements and instructions. The specially formulated geo-textile material is infused into the pool wall during manufacturing, then rolled up and secured for delivery. During installation, it's rolled out into the backfill and covered, thus anchoring it to the earth. The extension of this material allows the backfill to grip the pool wall to the earth.

**Please note: the Geo-Anchor Pool Wall is an option on all of our fiberglass pool designs; however, it does not come standard on any of them.**

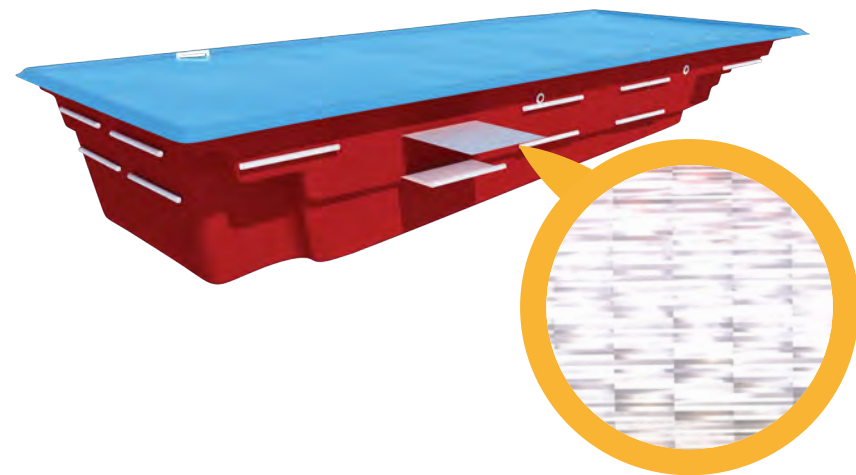

**THE  
GEO-ANCHOR  
POOL WALL**

**THIS INNOVATION IS OPTIONAL  
AND NOT STANDARD.**

# THE BACKFILL ELIMINATOR<sup>®</sup>

## TANNING LEDGE SUPPORT

Fiberglass pool owners love the luxury of being able to bask in the sun while cooling their heels in the water on a large, built-in tanning ledge. However, these ledges have created a major challenge for fiberglass pool installers as they have struggled to find ways to support the ledges with backfill during installation.

Traditionally, crushed stone or flowable fill has been used. But if the backfill is not properly completed, the tanning ledge can feel hollow as it's stepped on. Over time, the backfill can also shift and settle, creating a void.



## PROBLEM SOLVED!

To solve this problem, Thursday Pools created the patented Backfill Eliminator, a specially fabricated structure integrated into the bottom of the pool.

### The Backfill Eliminator:

- Allows sturdy and level installation.
- Permits free flow of groundwater, helping to eliminate the possibility of stagnant water accumulating under the pool or excess groundwater lifting the pool.
- Features an access point from which pool installers can easily reach plumbing and wiring.

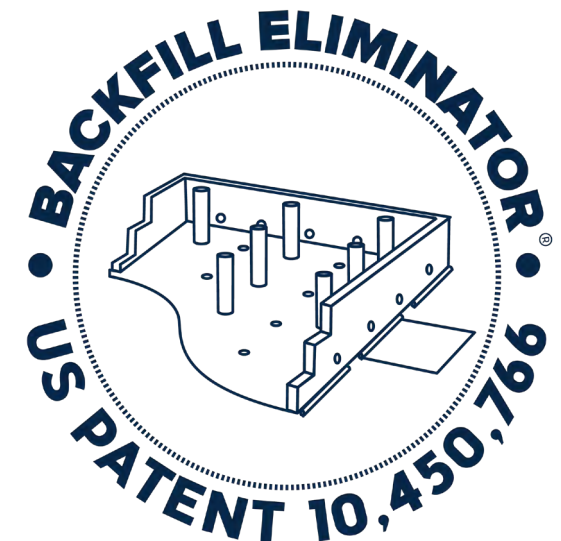
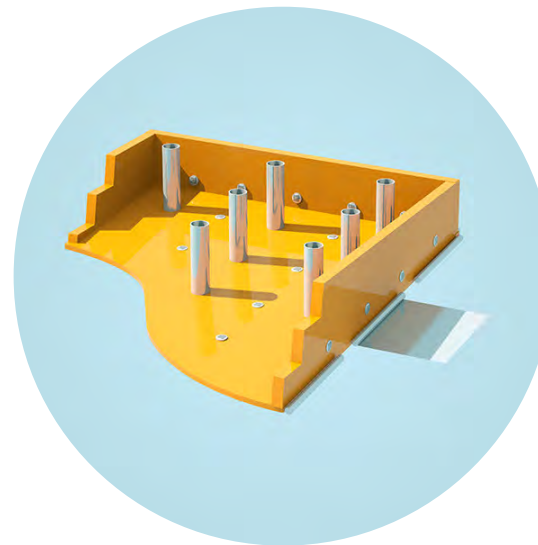

## WHY IS IT IMPORTANT?

### **The Backfill Eliminator® (US Patent 10,450,766)**

The Backfill Eliminator works in tandem with Thursday Pools' patented Geo-Anchor Pool Walls, which are built-in extensions that allow the Backfill Eliminator to be anchored to the earth during installation. It's a composite structure that has an extra thick honeycomb core and numerous support pillars. The structure is added during the manufacturing process and encases the tanning ledge on the underside of the pool. The Backfill Eliminator provides structural support to the tanning ledge and one continuous slope for excavation, making it as easy to install as any other fiberglass pool.

**Please note: the Backfill Eliminator is only an option on our fiberglass pool designs that feature tanning ledges and does not come standard.**

*The patented Backfill Eliminator is just one more way Thursday Pools is working to improve the fiberglass pool experience.*

**THIS INNOVATION IS OPTIONAL  
AND NOT STANDARD.**



# BEACH ENTRY DESIGNS

## FIBERGLASS BEACH ENTRY POOL

Utility Pool System Patent US 10,472,839

### ENJOY A DAY AT THE BEACH WITHOUT LEAVING YOUR HOUSE

A perfect day at the beach with the entire family doesn't have to be something you only get to do on vacation anymore. Beach entry pools, also known as zero entry pools, have gained popularity at resorts and upscale hotels and have become a sought-after feature for residential pool owners. Prior to this invention, it was difficult for fiberglass pool manufacturers to integrate a beach entry into their designs.

### DESIGN FEATURES

- Offers a gently sloping, non-skid pool entry that transitions seamlessly from most any deck or patio.
- Easy entrance and exit from your pool, making it great for swimmers of all ages.
- Creates a shallow spot for small children to play and sunbathers to sit—all without the mess of sand!
- Offers the luxury feel of a high-end resort or a day at the beach in the privacy of your own backyard.

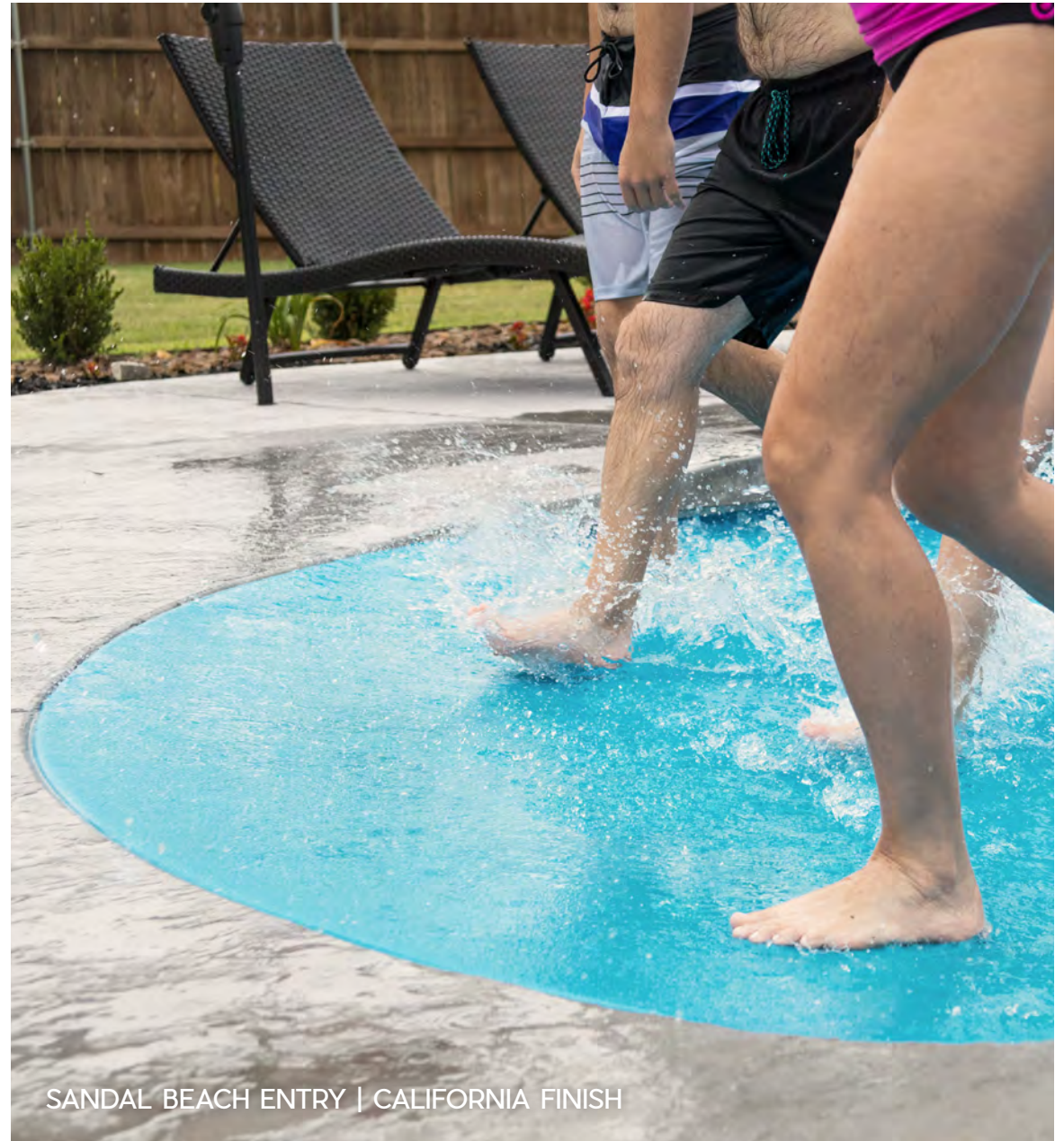

SANDAL BEACH ENTRY | CALIFORNIA FINISH



# POOL GALLERY



SPIRIT | CALIFORNIA FINISH

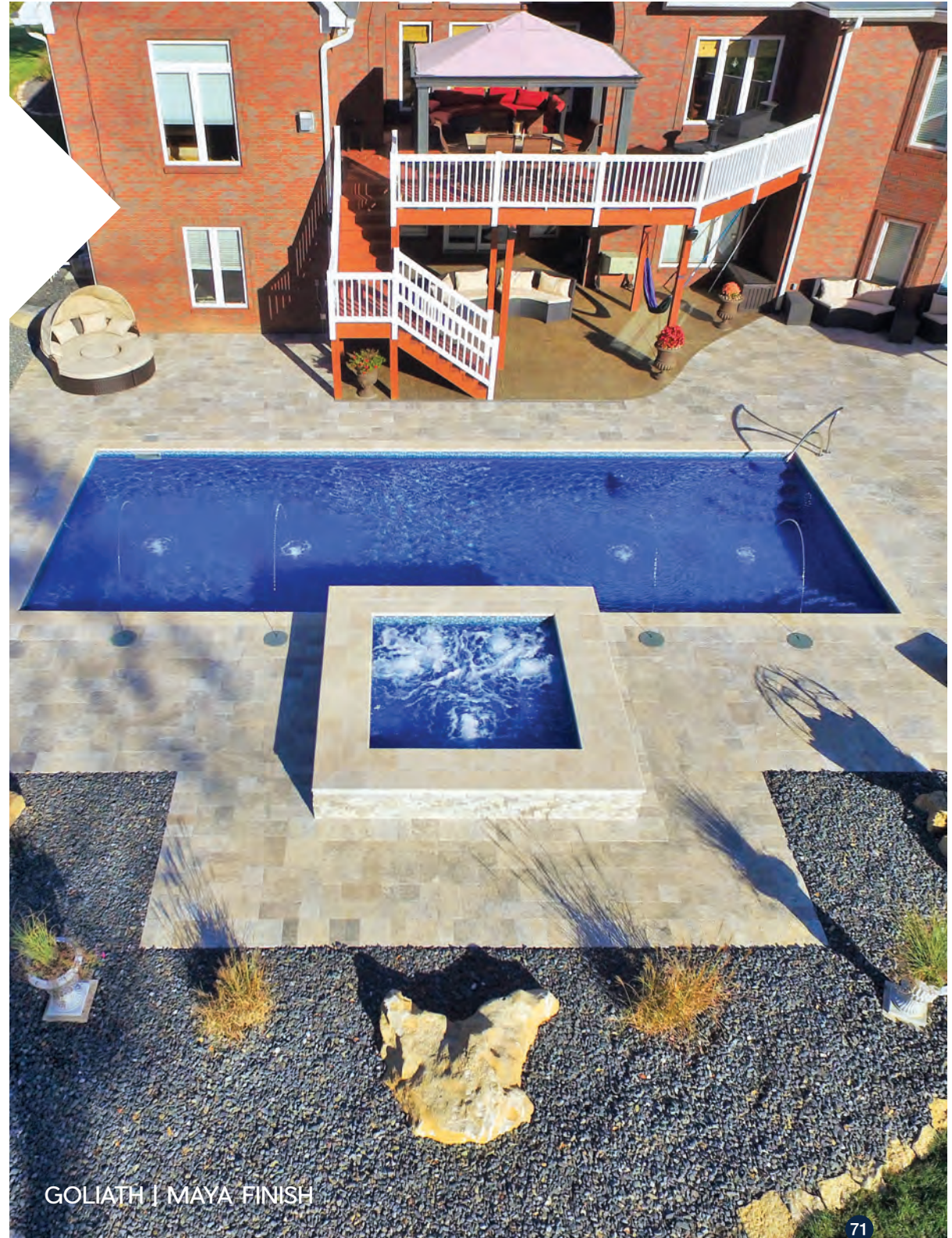

GOLIATH | MAYA FINISH



ASPEN | DIAMOND FINISH



GRACE BEACH ENTRY | CALIFORNIA FINISH



GOLIATH | MAYA FINISH



GOLIATH | CALIFORNIA FINISH



ASPEN | DIAMOND FINISH



WELLSPRING | MAYA FINISH



GRACE BEACH ENTRY | DIAMOND FINISH



GOLIATH | CALIFORNIA FINISH

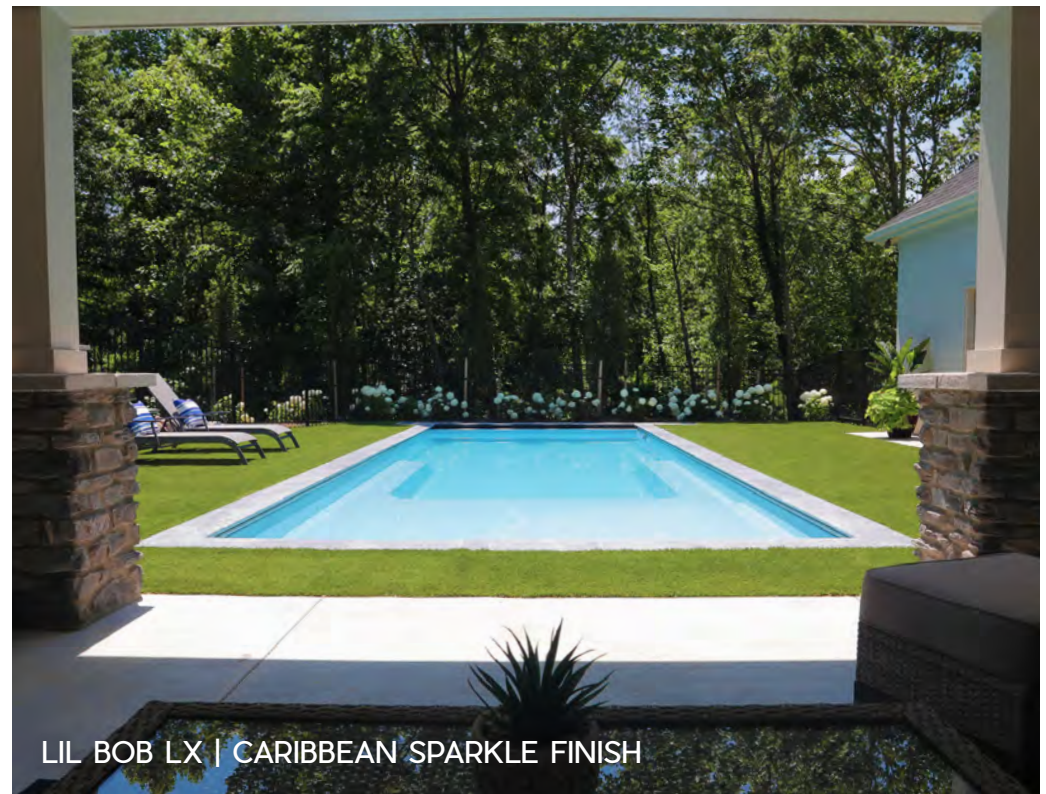

LIL BOB LX | CARIBBEAN SPARKLE FINISH





GRACE BEACH ENTRY | DIAMOND FINISH

## GOLIATH\*

12' x 25' 5"4" 14' x 29' 5"8" 14' x 33' 6'  
16' x 33' 6" 16' x 37' 6"4" 16' x 41' 6"8"

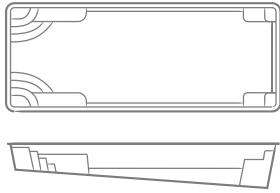

## MONOLITH\*\*

16' x 40' 8"6"

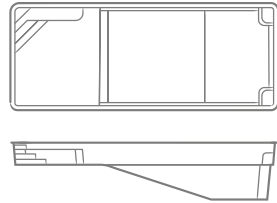

## GRACE BEACH ENTRY\*

14' x 36' 5"6" 16' x 36' 5"6"  
16' x 40' 5"10"

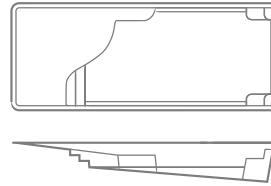

## LIL BOB LX\*

13.5' x 35.5' 4"6"

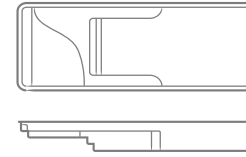

## LIL BOB\*

13.5' x 27.5' 4"6"

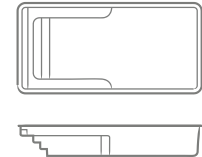

## SPIRIT\*

13.5' x 40' 4"6"

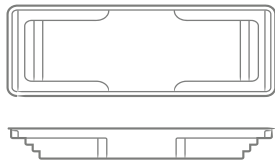

## CATHEDRAL LX\*

16' x 36' 5"8" 16' x 40' 6'

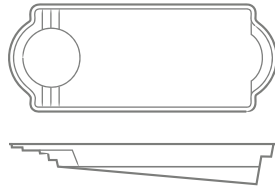

## CATHEDRAL\*

14' x 33' 5'

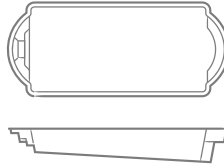

## TITUS\*

12' x 26' 5"5" 14' x 33' 5"10"

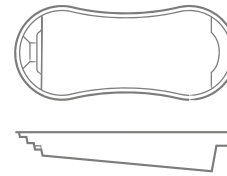

## SEA TURTLE\*

9.5' x 19.5' 4"6"

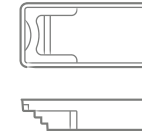

## PEARL\*

15' x 25' 3"9"

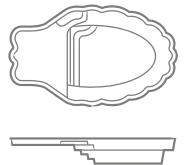

## WELLSPRING\*

16' x 36' 5"10" 16' x 40' 5"10"

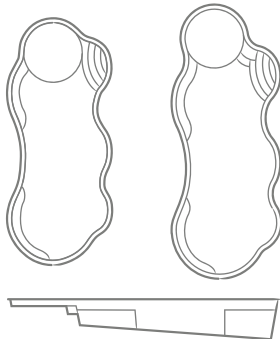

## SANDAL BEACH ENTRY\*

16' x 34.5' 5"8" 16' x 39' 6'

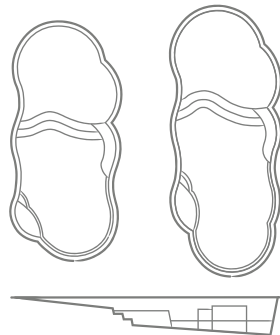

## SUN DAY\*

15' x 30' 5"3" 16' x 34.5' 5"8"  
16' x 39' 6'

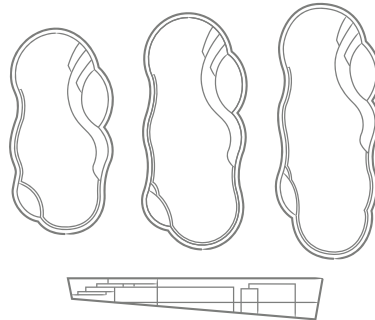

## ASPEN\*

12' x 25' 5"1" 14' x 30' 5"6" 14' x 35' 5"6"  
16' x 35' 5"6" 16' x 40' 5"10"

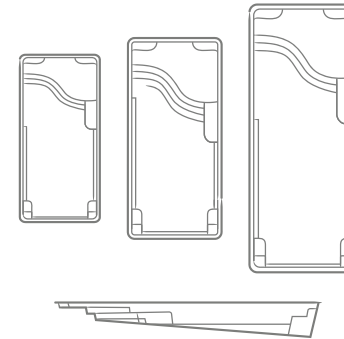

## SPA\*

9' x 9' 3"2" 9' x 9' 3'  
8'6" x 8'6" 3'



## GRAND SPA\*

11'6" x 11'10" 3'

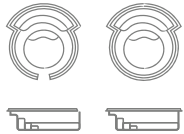

## WET DECK\*

14' x 8' 1'



## WADING POOL\*

9' x 9' 1"6" 13'9" x 11'9" 1"6"



Thursday Pools strongly recommends that diving boards and slides not be installed or used with its pools, given the inherent dangers associated with diving boards and slides in residential pools. These dangers include brain, spinal cord and other severe permanent injuries, and death. For that reason, Thursday Pools does not manufacture or sell diving boards or slides. If, despite this warning and recommendation, the owner decides to install or use a diving board or slide, the owner assumes all risks inherent with a diving board or slide, and Thursday Pools further warns that diving boards and slides require minimum depths and distances and must be installed and used in strict compliance with the equipment manufacturer's specifications and ANSI/NSPI, ANSI/APSP, and ANSI/APSP/ICC standards, as well as in compliance with all applicable laws, rules and regulations. The owner is responsible for making sure the pool is appropriate for diving boards and slides and otherwise meets all standards and laws for diving pools, and the owner must consult the diving board or slide manufacturer and/or installer as to the appropriateness of the pool for the diving board or slide and that its installation, location and use meet all standards and laws for diving and slide pools.

\*Non-Diving Pool

\*\*Type 1 Diving Pool

1. All depths reflect the depth of the pool structure. Water depths may vary depending on the amount of water in the pool.
2. All measurements given reflect the dimensions of the pool to the exterior of the pool structure, and not the dimensions of the pool interior.
3. Additional specifications are available at [thursdaypools.com](http://thursdaypools.com).

840 COMMERCE PARKWAY, FORTVILLE, INDIANA 46040

T: 877-929-POOL (7665)

MONDAY-FRIDAY: 8AM-5PM EST

VISIT US AT [THURSDAYPOOLS.COM](http://THURSDAYPOOLS.COM)

