

G.B. PERFIN SOCIETY BULLETIN

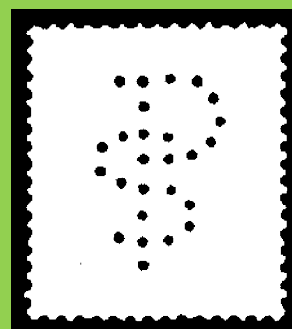

No. 380 – October 2012



Illustrated envelope used by the Royal Mail Steam Packet Co bearing ½d Green Downey with perfin R3550.03 – RM/SP. The die is known used between 1922 and 1936

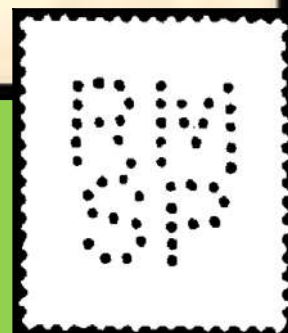

SECRETARY/TREASURER

A big thank you to all of you who have paid your subscriptions on time, it is a great help to me and reduces my administration, and the notes of support are greatly appreciated! A few of you in the UK paid subs of £11 by cheque instead of £10 and as I have no contact telephone/email I have put the £1 to credit for the future. Apologies to those that received opened empty envelopes instead of the August Bulletin & Auction, I still cannot understand why so many were affected as it has rarely ever happened before.

Subscriptions Due

If you have yet to pay your subscription due on **1st September 2012** then please do so without delay. I will only remind those members on email or who have given me a telephone number due to high postage costs.

New Collectors Website

Non-member Miles Newey has contacted the Society to highlight a new blog that he has started which may be of interest to some of our members. "I now have a new website up and running called www.stampblog.co.uk . The purpose of this site is to encourage the collecting of stamps, whilst being on hand to provide support by way of a forum. Although this is primarily launched at collecting GB and Machins, other categories on the forum may be added in the future if proved popular."

WANTED



Michael Millar writes from Canada with a further request. "I would like to add to my request in the August Bulletin for Stationery Office material. I will be happy to purchase any S Crown O (S5630.01M) and HM/SO (H5200.01aM, H5200.01M and H5200.02) that members may have lying around spare, cards, covers, wrappers, on piece or on stamp."

London Meeting & AGM

I hope to see as many of you that can make it to the meeting on November 3rd as I will be proposing to raise subscriptions in September 2013 to cover the numerous postal increases we have had over the years since the last subscription rise. If anyone has anything they would like raised and cannot attend in person then please contact me by letter or email. Details and a map are shown below.

Our booking for the Young Chelsea Bridge Club has been confirmed for Saturday November 3, 2012 from 12 o'clock onwards. The venue is very close to Earls Court Underground Station, and parking is free if you are prepared to walk a few hundred yards. The full address is The Young Chelsea Bridge Club, 32 Barkston Gardens, London, SW5 0EN, - tel. 0207 373 1665. The Society will again have the rear ground floor room that has a large skylight providing good natural light. A map of the location is shown below. The club has a licensed bar, where soft drinks, tea and coffee, and light snacks are available. Hopefully everyone will bring along some of their favourite material and there will probably be material for sale at bargain prices.



Hours of Residents' Parking control:		8.30am to 10pm Monday to Friday 8.30am to 6.30pm Saturday
NB on Saturdays after 1.30pm, park one block east of the club, in the pink-shaded area of the map.		8.30am to 10pm Monday to Friday 8.30am to 1.30pm Saturday

MEMBERS COMMENTS ON PREVIOUS ARTICLES

Arthur Wyatt & The Penrhyn Colliery - Bulletin 377/18

Andy Donaldson wrote to remind me that all the known covers with William Dawbarn overprints are addressed to Arthur Wyatt.

"I was interested in the article not because of a connection to Perfins but to Protective Overprints or to be more precise one overprint in particular that of **Wm. Dawbarn & Co. Liverpool** (see SG GB QV Specialised Vol. 1, Appendix 2, Type 19 overprint & PP57, 58 & 58a)."



"Wm. Dawbarn was a Slate and Timber merchant, based in Liverpool, who also had dealings with Arthur Wyatt and the Penrhyn Quarry. He started as a "Slate Merchant and Writing Slate Manufacturer" in the 1850s before branching out into Timber as well. William Dawbarn died in 1881 but the firm continued until the early 1900s before succumbing to bankruptcy."

"I currently have 19 examples of the overprint used on cover (both reading upwards and downwards on a variety of 1d plates) and every single one is addressed to Arthur Wyatt and all from the period 1870-1875. I have seen a handful of other Dawbarn covers and all these have also been addressed to Wyatt."

Vincent West has also contacted me. He has recorded 27 Darbarn covers - again all addressed to Arthur Wyatt. He also sent the date ranges recorded for these overprints which I show below.

Overprint upwards SG PP57: 3 covers	17/08/1872 - 25/01/1875
Overprint downwards PP58: 23 covers	30/09/1870 - 17/10/1876
Double Overprint PP58a: one cover	23/10/1872
Underprint upwards PP59: one cover	17/12/1878.

If any member is lucky enough to have one of these Darbarn covers maybe they could let the Editor know details of it to add to Vincent's database.

ALICE SLOPER

John Mathews

I am also still trying to find out where Joseph Sloper's daughter, Alice lived between the 1911 Census (Edgbaston/Stoke Prior) and her death at Torquay, Devon in 1918. In one newspaper obituary, her husband (Rev. Francis Knight) said that she had given clothing to soldiers when she lived at Putney and Ealing – presumably this was during WWI, sometime between 1914 and 1918. Now I have found an “In Memoriam” item in The Times of Tuesday 31 August 1915, written by Rev. Francis Knight who gave his address as “Poona House, Seymour Road, Wandsworth SW”. Presumably Alice was with him. (This is definitely the correct Rev. Francis Knight because he mentions that he is a “Theist” minister, same as in the 1918 obituary, and because of his relatives mentioned in the “In Memoriam” item). I had done his family tree because also in the 1918 obituary he claimed to be a “cousin of Earl Curzon” – I have not been able to establish that link yet, but have seen mention of a publication he did which included quite a lot of his ancestral detail, so it looks as if he knew what he was talking about family-wise! I have managed to track down his great-niece who lives here in Australia (!) and wrote to her last week in the hope that she may know more about Francis and Alice. It was her mention of Francis’ publication on a family history blog site which sent me on the search to find her, unaware that she was living in Australia (her father migrated here as a single man some time before 1933 when he married here).

BOARD OF TRADE PERFINS

I. J. Bernstein

[Ed:- Back in Bulletin 365 I reprinted a piece on the Board of Trade Perfins by I.J. Bernstein that had been published in 1906. The piece below by the same author is taken from the Stamp Collectors' Annual of 1907. With the preparation of the "B" section of the New Illustrated Catalogue now underway, Roy Gault is preparing a monograph on what must be the most contentious area of perfin collecting which will hopefully cast light on the values legitimately used and the many forgeries.]

In the year 1880 the inconvenience of having to pay for the postage of official letters out of their private pockets, and then having to wait till the end of the quarter before the Government reimbursed them for the outlay, was the cause of much complaint amongst officials. It was felt to be an injustice, and various schemes were devised to supply them with stamps that, though retaining their franking power, could not be converted into cash, and that were so marked as to be only available for use on official correspondence.

Special stamps were suggested; it was thought of using the unappropriated die for the purpose, putting the name of the department in the label at foot. It was, however, considered inadvisable from a Post Office point of view to have different stamps than those then current, and the devices employed by private firms and the Oxford Union Society, against misuse, were then resorted to. Printing on the back did not meet the requirements, and there remained but overprinting on the face or perforating initials or designs through the stamp. This latter was a method just then coming to the front, and much encouraged by the Post Office. Consequently it was tried for the Government Department of the Board of Trade, and the first issue was made on the 27th January, 1882. As, however, the perforated device was not easy to distinguish from those used by private firms, particularly when on a letter, this method was not adapted by the other departments, excepting the Office of Works, which used it for the short period-August, 1895, till March, 1896. The Board of Trade, however, retained it till all distinctive official stamps were finally abolished on the 14th May, 1904.

Their appearance passed quite unnoticed in philatelic circles, and for many years it was little thought that the perforation of a Crown, with the initials B.T. underneath, was of an official character on a par with the overprint I.R. Official, which created a mild sensation when it appeared in September, 1882.

A warrant for their preparation, such as was required for the overprinted "officials," not being necessary, no official record is available of what stamps, or how many of any stamp, were so perforated.

The official information available states only:

"That they were first used on January 27th. 1882, and that all stamps from the ½d to 1/- values current between that date and May 14th, 1904 (when their use, in common with other official stamps, was discontinued), were issued to, as required, and used by the department."



Board of Trade Official envelope to Belgrade, Serbia with 1d lilac and 1½d jubilee with BOT perfins and London E.C. postmark dated January 23rd 1902

As, however, the 2d blue (line engraved), plate 15, was one of the first Board of Trade Officials, it is evident that the stamps were prepared some few months before issue, as this stamp was superseded by the 2d Carmine Rose (De La Rue Series) in November 1880. I propose, therefore, listing the stamps that may possibly be found Board of Trade Official, marking those with an asterisk that I have actually seen.

It is evident that two, if not more, perforating machines were employed during the 23 years these stamps were in use, as the holes in the earlier issues are considerably larger than in the later ones, which are also found without the full stop between the initials. They were, no doubt, intentionally made smaller, as the larger the hole the more tender and likely to tear became the stamp. It is probable that the machine consisted of only one device, each stamp in a row being punched separately, but the rows were folded up either vertically or horizontally, and several thicknesses of stamps perforated simultaneously, as one can find vertical pairs with the device, tête-bêche, or horizontal pairs with one of the designs reversed. In this case the crown being symmetrical it does not show any differences, but the letters read T. B.

Being hand-punched, and a number of stamps punctured by one operation, the quantity of minor varieties resulting is naturally big. Besides the principal ones, the tête-bêche and reversed varieties already mentioned, one can find stamps with either the B or the T, or with both entirely, or in part, not punctured, the T reading like an inverted L, or with a short upright or horizontal stroke. Examples are found with part of the Crown missing, and I have seen some with the crown only.

Other flaws in the design are due to the breaking of single pins, and are quite too numerous to mention. In common with all other Government Departments, the Board of Trade correspondence to and from head quarters was franked, and the use of stamps unnecessary.

Stamps were only used by the Head Office for letters going abroad, and by branch offices for all correspondence other than that addressed to head quarters. As the Board of Trade has no branch offices, it follows that most of their stamps went to foreign countries (mostly to

captains of British boats at foreign ports), and their rarity is thus easily explained. Added to this is the fact that hardly anybody was aware of their official character, and they were, no doubt, destroyed as damaged (*i.e.*, perforated) stamps.

A few may be found with the cancellation of a seaport, but most of them have the London postmark.

Since 1887, to meet the requirements of the Parcel Post Act, an occasional copy is to be found that has been used on a parcel.

Why these stamps are not catalogued I cannot understand. English specialists' catalogues find room for "Firm's names on back," "College issues," "Private Telegraph Companies", and latterly, "Railway letter stamps"; even our Standard Catalogue includes Private and Army Telegraphs; mostly stamps issued only *by permission of the Government*, but all agree in ignoring these although *actually issued* by the Government.

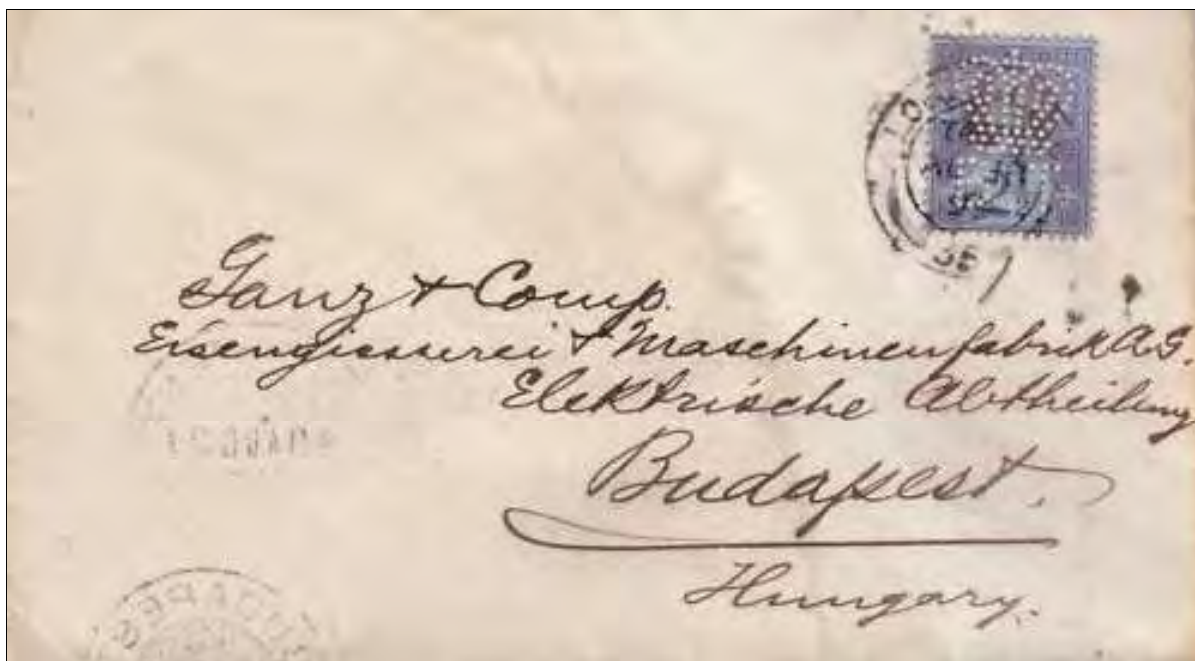

Board of Trade Official envelope to Budapest with 2½d jubilee BOT perfin and London postmark dated August 18th 1899.

[Ed:- the original article included a list of the values recorded with this perfin but as many of the values listed must now be considered to be forgeries the listing has been omitted.]

LATHAM BROTHERS OF BOLTON

Maurice Harp

Richard Husband showed me an article at the Spring meeting regarding a perforating machine that was ordered by the South Australian Government in 1869 from Latham Brothers of Bolton. Apparently Latham had been granted a patent on 22 February 1862 covering perforating machines for tickets, cheques etc.

667. Latham, W. H., and Latham, F. G. W. March 12.

Punching and perforating machines for tickets, cheques, &c.—The sheets of paper or cardboard are perforated by punches set in the periphery of wheels *c*, Fig. 4, and entering holes in the periphery of wheels *c'*. The sheets are fed by a band *e*, Fig. 1, stretched over rollers *f*. The

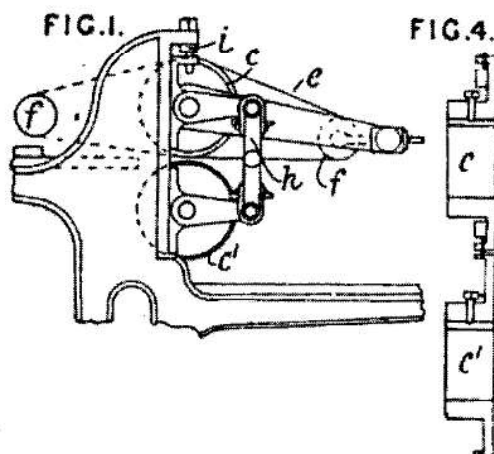

shafts of the wheels *c*, *c'* are connected by coupling-rods *h* and cranks at right-angles. The bearings of the upper shaft are adjusted by screws *i*.

Richard writes "If Latham Brothers had obtained a patent for a machine to perforate bits of paper such as cheques in 1862, why didn't they sell stamp perforating machines or take up the business of perforating stamps in say 1869 after Sloper had done all the hard work of getting perfins accepted by the Post Office? Perhaps the perfins' business up to 1872 was still very much in its infancy and barely profitable so Lathams considered

that competing with Sloper would not be worthwhile."

Looking at an 1869 directory of Bolton I find that the company describes itself as booksellers, stationers, machine makers and printers. So they seem ideally placed to be a perfin supplier. However perfins used in Bolton during this early period seem to be few and far between. In fact the only one that I have tracked down is B.T - B7060.03 used by the Bridgwater Trustees. So maybe there was little demand for perfins in the area at the time.

NEW ILLUSTRATED CATALOGUE - LETTER "B".

Roy Gault

By the time you read this, the long awaited **B's**, including a special section devoted to the notorious "Crown/B.T" 'Official' Perfin, will be nearing completion, but please wait for an announcement in the Bulletin regarding prices and availability. The **B's** currently stand at **1,981 DD**, and **20,937 DDF**.

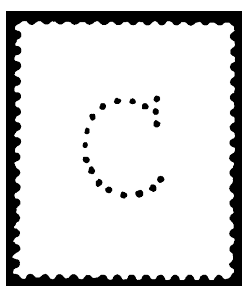
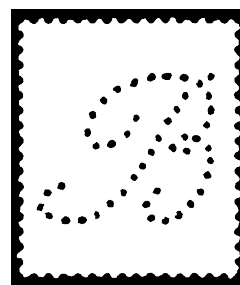

The final letter to be looked at in detail since I started the *New Illustrated Catalogue* way back in 1994, is the letter "C", which in keeping with the letter "B" will probably take two years to complete. Please take this announcement as the 'last call' for any new Perfin dies beginning with the letter "C"!

This still leaves the letters "J", "S", and "W" to be re-visited before the catalogue can be deemed anywhere near 'complete'. As these exist already in paper form it's a somewhat easier task to produce an electronic 2nd Edition. On an ad-hoc basis, these three sections will be worked on during the production of the letter "C" (1,964 Dies), probably in the order "S" (1,783), "W" (1,786), and finally "J" (1,779). Please take this also as a 'last call' to send me details of any new dies you think you may have for any of these three letters, or indeed any other information that is additional to what's already been published.

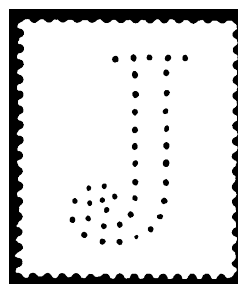
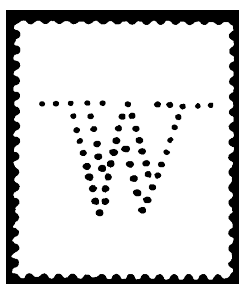
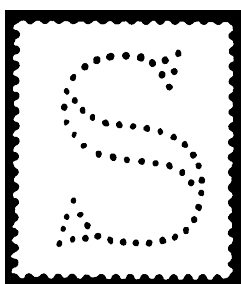

As a final note, the current number of Perfins found on G.B. stamps (as at 1st September 2012) stands at **23,955 Different Dies**, involving over **232,500 Different Die Face**. However, when the above work has finally been completed I fully expect the **DD** figure to top **24,000** and the **DDF** to be approaching **250,000** - a quarter of a million!

CANADIAN STAMPS WITH PERFORATED INITIALS
5TH EDITION PUBLISHED

Maurice Harp

The 5th Edition of "Canadian Stamps with Perforated Initials" is now available **free of charge** on the BNAPS web site. The web link to the site is www.bnaps.org/PerfinHandbook/PerfinHandbook.htm The catalogue is divided into a number of chapters which can be viewed or downloaded and saved. The whole catalogue runs to 170 pages and includes introductory chapters on the Origins of Perfins, the Use of Perfins in Canada and Perfin Machines. It should be remembered that the 4th edition of this catalogue was published way back in 1985 so as you can imagine a vast amount of new information is now available. Of particular interest to the British collector is that the catalogue records a number of British dies that can also be found on Canadian stamps. These include - CS/L/SA (C7140.04), E.G (1720.04), S (in oval) (0040.01), SF&Co.. (S2905.01). The catalogue is edited by Jon Johnson and Gary Tomasson. By using electronic publishing they have been able to include many colour illustrations and additional material that might have been left out if the cost of traditional publishing had been a consideration. The BNAPS and the editors are to be highly commended for an excellent publication and for making it available free of charge to the worldwide perfin community. The publication will probably spark new interest and reveal a great deal of new information.

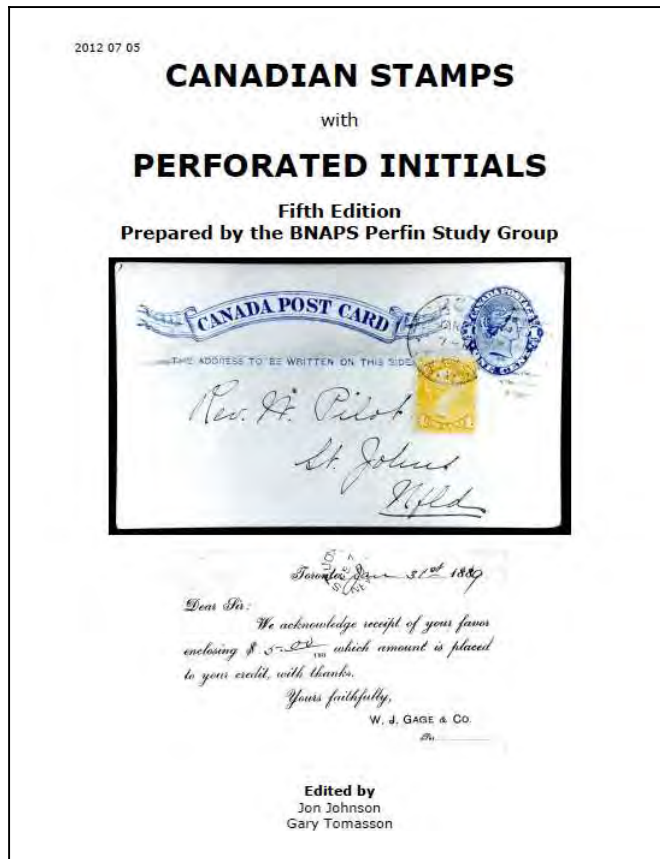

THE MIRRLEES WATSON CO. LTD.

Richard Husband

The perfin die MW/Co. - (M6030.01), shown on the cover illustrated below, was used to perforate many different stamp values between 1920 and 1965 and the only postmarks recorded are from Glasgow. A further die MW/&Co - (M6035.01) is also known used between 1925 and 1930.



Cover sent to Buenos Aires, Argentina cancelled Up Special T.P.O, dated March 1st 1935

The business of manufacturing cane sugar processing machinery had been started by Peter, William and Andrew McOnie in Glasgow in 1840. From then until 1868 the business enjoyed a number of name changes as partners came and went. In 1868 the name was changed to Mirrlees, Tait & Watson and they are thought to have used perfin die M.T.W - (M5700.01) based on the dates used, the perforated initials and the Glasgow postmarks. From 1882 to 1889 the business was known as Mirrlees Watson & Co. In 1889 it became incorporated under the name of Mirrlees, Watson, Yaryan & Co. Ltd., changing its name again to The Mirrlees, Watson Company Ltd. in 1899. The Mirrlees Watson Company Ltd was formed into a public company in 1907.

The three perfin dies referred to on the previous page are shown below.

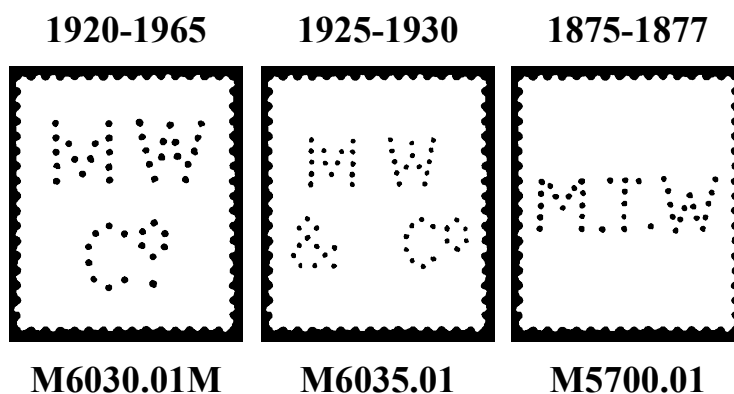

Five other perfin dies are shown below which, although unconfirmed, are thought to have been used by the company through the combination of perforated initials and Glasgow postmarks between 1882 and 1915.

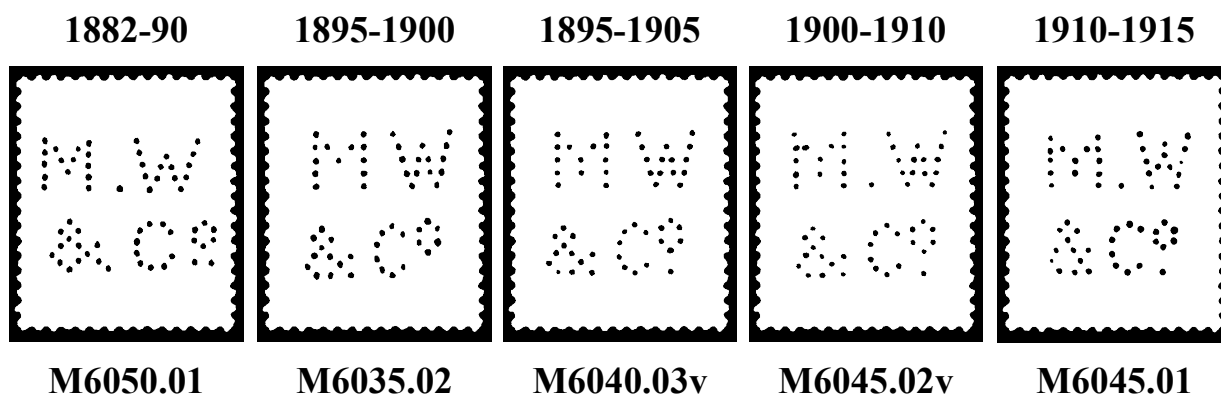

As an example of the size of the company's business, in 1908 it supplied three complete sugar processing factories, two in Mexico and one in Formosa (now Taiwan) as well as sugar processing machinery to many other countries. The advertisement from 1918 on the next page gives an indication of the size and scope of The Mirrlees Watson Co. Ltd's business.

However, in May 1926, the company was put into voluntary liquidation. Then Mirrlees, Bickerton & Day Ltd stepped in and bought the necessary assets from the liquidator to enable the Glasgow plant to continue to manufacture sugar machinery. A new company was formed for this purpose which was able to re-use the name "The Mirrlees Watson Co. Ltd."

The company's name was changed to M W Sugar Holdings Ltd in 1966 and in 1967 was taken over by A & W Smith & Co. Ltd becoming Smith Mirrlees and then in 1988 was acquired by Fletcher & Stewart Ltd of Derby, part of Booker, McConnell Ltd. In 1990, Fletcher & Stewart Ltd changed its name to Fletcher Smith Ltd and was then sold in 2000 to the French company Fives Lille and renamed Fives Fletcher Ltd. Based in Derby, the company designs and supplies sugar processing equipment.

Brief mention has already been made of Mirrlees, Bickerton & Day Ltd. This company was incorporated in 1907 specifically to build diesel engines at a new purpose built factory at Hazel Grove, outside Stockport, Cheshire. Its perfins and history were covered in an article by Roy Gault in Bulletin No 327 (December 2003).

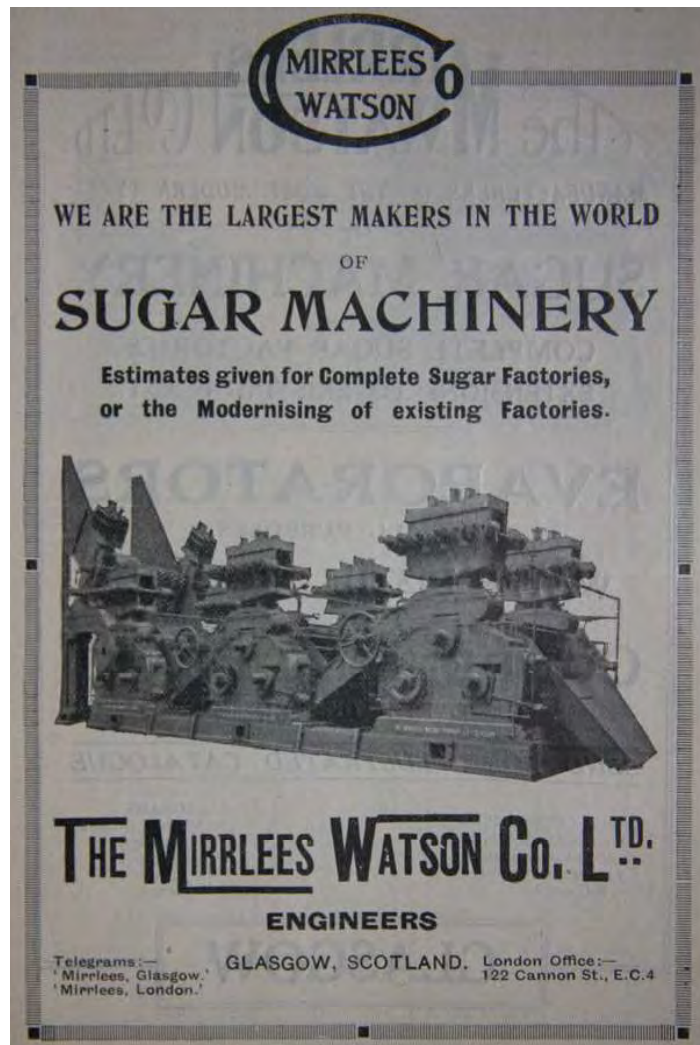

The addressee on the cover is also worthy of mention. E C Knight Company was taken to court by the United States Government in 1894 for violating the Sherman Antitrust Act 1890. The U S Govt considered that 98 per cent of the share of the U S sugar producing business being under the control of a single company group was a combination in restraint of interstate commerce. However, the Supreme Court disagreed stating that the 1890 Act did not apply because sugar refining was not interstate commerce. But by 1922, its effective control of refined sugar production in the U S had fallen to 24 per cent and declined further thereafter.

JOSEPH SLOPER'S PLACE OF DEATH

John Mathews

In Bulletin 358 (Feb 2009, p.9), the contents of Joseph Sloper's death certificate were presented, including that the place of his death was 2 Mercer's Terrace, Archway Road, Islington. This was not an address previously noted as a residence of Joseph Sloper, so I searched all the usual references such as Post Office Directories, Trade Directories, etc., for information of any connection with him and this address. One reference which I had not previously looked at was the collection of London Electoral Registers which had been made available on Ancestry.com only a short time before. I presented the results of this search in Bulletin 377 (Apr 2012 p.8), and it included details of the resident at "2 Mercer's Terrace, Archway Road, North Upper Holloway" on the 1890 and 1891 Electoral Registers as John Henry Collier. On the 1890 Electoral Roll, Joseph Sloper was shown at 12 Walm-lane, Willesden. Joseph Sloper died on 18 June 1890.

Now, an updated "England & Wales, National Probate Calendar (Index of Wills and Administrations), 1858-1966" is available on Ancestry.com. In this I found the one for Joseph Sloper whose personal estate was stated to be £163-4-1d. It reads "[1891] 30 September. Administration of the estate of Joseph Sloper, formerly of The Laurels, 12 Walm Lane, Willesden Green in the county of Middlesex and of 20 King William Street in the city of London but late of 2 Mercer Terrace, Archway Road, Highgate Hill in the said county who died 18 June 1890 at 2 Mercer Terrace was granted at the Principal Registry to Sarah Lavell Sloper of 38 Lancaster Road, Notting Hill in the said county, Widow the Relict."

If I am not mistaken, "late of 2 Mercer Terrace" would imply that he was a resident there leading up to his death, especially in view of the words ", formerly of The Laurels, 12 Walm Lane, Willesden Green". As the Electoral Registers say that John Henry Collier was at 2 Mercer Terrace while Joseph Sloper was at 12 Walm Lane (1890) and still at that address after Joseph Sloper died there (1891), it seems that these two gentlemen knew each other – I wonder in what connection? The 1891 Census does not indicate that there were two separate flats at that address.

GAS COMPANIES

Julie Barnard

The Gas Light and Coke Company (also known as the Westminster Gas Light and Coke Company), was a company that made and supplied coal gas and coke. It was located on Horseferry Road in Westminster, London. It is identified as the original company from which British Gas plc is descended.

The company was founded by Frederick Albert Winsor, who was originally from Germany, and incorporated by Royal Charter on 30 April 1812 under the seal of King George III. It was the first company set up to supply London with (coal) gas, and operated the first gas works in the United Kingdom which was also the world's first *public* gas works. It was governed by a "Court of Directors", which met for the first time on 24 June 1812. The original capitalisation was £1 million (about £9 billion at 2005 prices), in 80,000 shares.

Offices were established at Pall Mall, with a wharf at Cannon Row. In 1818 the company established a tar works in Poplar and expanded their works at Brick Lane and Westminster. Under the company's chief engineer, Samuel Clegg (formerly of Boulton and Watt), a gas works was installed at the Royal Mint in 1817 and by 1819 nearly 290 miles of pipes had been laid in London, supplying 51,000 burners. Clegg also developed a practical gas meter.

The Company absorbed numerous smaller companies, including the Aldgate Gas Light and Coke Company (1819), the City of London Gas Light and Coke Company (1870), the Equitable Gas Light Company (1871), the Great Central Gas Consumer's Company (1870), Victoria Docks Gas Company (1871), Western Gas Light Company (1873), Imperial Gas Light and Coke Company (1876), Independent Gas Light and Coke Company (1876), the London Gas Light Company (1883), Richmond Gas Company (1925), Brentford Gas Company (1926), Pinner Gas Company (1930) and Southend-on-Sea and District Gas Company (1932).



In the early 1900s the gas market in the United Kingdom was mainly run by county councils and small private firms. At this time the use of an inflammable gas (often known as "Town Gas") piped to houses as a fuel was still being marketed to consumers. The gas used in the 19th and early 20th centuries was Coal gas. Gas, as we know, is highly explosive. The postcard above shows the wreckage after a coal gas explosion at the Saltley Gas Works, Birmingham on 10th October 1904 and shows firemen still at the scene. It was thought to have been caused by someone lighting a cigarette

In 1948 Clement Attlee's Labour government reshaped the gas industry, bringing in The Gas Act of 1948. The act nationalised the UK gas industry and 1,062 privately owned and municipal gas companies were merged into twelve Area Gas Boards each a separate body with its own management structure. The Gas Light and Coke Company supplied an area from Pinner in North West London to Southend-on-Sea in Essex and became the North Thames Gas Board. Each Area Board was divided into geographical groups or divisions which were often further divided into smaller districts. These boards simply became known as the "Gas Board", a term people still use when referring to British Gas.

Gas Companies and the later Gas Boards were prolific users of Overprints (used on receipt stamps) and Perfins (used for postage). Use of these stamps prevented staff using them on their own private mail and also prevented the general public from re-using them on

their mail thus preventing fraud. There were twelve Gas Boards and they covered the following areas

- 1. Scottish Gas Board** - covering Scotland
- 2. Northern Gas Board** - covering Durham, Northumberland and parts of Cumberland, Westmorland and the North Riding of Yorkshire.
- 3. North Western Gas Board** - covering Lancashire and parts of Cheshire, Cumberland, Derbyshire, Shropshire, Westmorland and the West Riding of Yorkshire
- 4. North Eastern Gas Board** - The East Riding of Yorkshire and parts of the North and West Ridings of Yorkshire (including York).
- 5. Wales Gas Board** - covering Wales
- 6. West Midlands Gas Board** - Parts of Cheshire, Herefordshire, Leicestershire, Shropshire, Staffordshire, Warwickshire (including Birmingham) and Worcestershire.
- 7. East Midlands Gas Board** - Lincolnshire, Nottinghamshire, Rutland & parts of Bedfordshire, Buckinghamshire, Derbyshire, Leicestershire, Northamptonshire, Staffordshire and West Riding of Yorkshire
- 8. South Western Gas Board** - Cornwall (including the Isles of Scilly), Gloucestershire & parts of Berkshire, Devon, Herefordshire, Oxfordshire, Somerset, Warwickshire, Wiltshire and Worcestershire.
- 9. North Thames Gas Board** - Parts of the administrative county of London and of Berkshire, Buckinghamshire, Essex, Hertfordshire, Middlesex and Surrey
- 10. Eastern Gas Board** - Cambridgeshire, Huntingdonshire, the Isle of Ely, Norfolk, the Soke of Peterborough, Suffolk and parts of Bedfordshire, Buckinghamshire, Essex, Hertfordshire and Middlesex.
- 11. Southern Gas Board** - Dorset, Hampshire, the Isle of Wight and parts of Bedfordshire, Berkshire, Buckinghamshire, Devon, Hertfordshire, Northamptonshire, Oxfordshire, Somerset, Surrey, Sussex and Wiltshire.
- 12. South Eastern Gas Board** - Kent, and parts of the administrative County of London and of Middlesex, Surrey and Sussex.

During the 1950s the use of gas increased greatly with British Gas creating high street showrooms to promote the use of gas. By the 1960s the UK was importing 300,000 tons of liquefied natural gas from Africa every year. Surveys in the North Sea had shown that there were large reserves of natural gas and in 1966 the decision was taken to convert the UK from town gas to natural gas. The next year the first natural gas from the North Sea had arrived and over the next 10 years British Gas carried out a massive conversion program converting appliances from town gas to natural gas.

In January 1973, British Gas was restructured by the Gas Act of 1972 which centralised the company creating the British Gas Corporation and turning the area boards into regions of the new company. The Conservative Government led by Prime Minister Margaret Thatcher introduced the Gas Act of 1986 which led to the privatization of the company, and on 8 December 1986 its shares floated on the London stock market. In the hope of encouraging individuals to become shareholders, the offer was intensely advertised with the "If you see Sid ... Tell him!" campaign. The initial public offering of 135p per share valued the company at £9 billion, the highest equity offering ever at the time. The government created an industry regulator, the Office of Gas Supply (Ofgas), to protect customer needs. It later became part of the Office of Gas and Electricity Markets (Ofgem). In preparation for the opening of the gas supply markets to competition in 1996, British Gas plc had to go through a major restructuring which separated the company into five divisions.

- Public Gas Supply (Domestic gas supply).
- Contract Trading (Business Supply)
- Transportation and Storage later named Transco.
- Service and Installation (later named Services).
- Retail (Later named Energy Centers).

Following the restructuring, with shareholder approval, British Gas plc was demerged to form two separate companies on 17 Feb. 1997.

1. Centrica plc - Took responsibility of the gas supply business and the gas production business of the North and South Morecambe gas fields. Centrica has the rights to the British Gas name inside the UK .

2. BG plc - Took responsibility of Transco the gas transportation business and the international exploration and production business. BG plc went through a financial restructuring in 1999. This resulted in a new parent company being created, BG Group plc, which subsequently split into two new businesses, BG Group plc and Lattice Group plc. Lattice, which contained the Transco business, then went on to merge with the National Grid Company. BG Group has the rights to the British Gas name outside the UK.

This article has been based on an exhibit I prepared for my local society. There is a huge amount of readily available perfin material associated with gas companies which can be used to make a specialist collection. I have prepared a list below of gas company dies that I have identified which I am sure is far from complete. To this list could be added gas engineers and makers of gas appliances.

Die	Config	User
B2910.02M	BG	British Gas plc
B2950.02	BGC	Brentford Gas Co
B2960.01/02	B.G.C	Bradford Gas Co
B2960.02	B.G.C	Bath Gas Co
B2970.02M/03	BG/C	British Gas Corporation
B3100.01	BGL/Co	British Gas-Light Co Ltd *
B3115.01	BG/N	British Gas-Light Co Ltd
B3120.01	BG/Plc	British Gas plc
B3360.01/02	BHG	Brighton & Hove Gas Co
B3370.01	BH/G	Brighton & Hove Gas Co
B3470.01/02/03	BH/WG	Brighton, Hove & Worthing Gas Co
C0770.01/02	C.B/GAS	City of Birmingham Gas Dept.
C2660.01p	CG	Croydon Gas Co
C2730.01/02	C/GAS/C	Croydon Gas Co
D0390.01/02p	DB/GC	Dudley, Brierley Hill & District Gas Co
D2060.03p	DG	Dudley Gas Co
E1740.01M/02/03/04	E/GB	Eastern Gas Board
E3000.01	EMGB	East Midland Gas Board
E3010.01	EM/GB	East Midland Gas Board
E3020.01	E.M/G.B	East Midland Gas Board
G0170.01/05	GAS	Leicester Gas Department
G0193.01	GASCo.	Newport (Monmouthshire) Gas Co
G0200.01	GAS/Co.	Cardiff Gas Light & Coke Co *
G0200.02	GAS/Co.	Cardiff Gas Light & Coke Co

Die	Config	User
G0200.02a	GAS/Co.	Derby Gas Light & Coke Co
G0910.01	GC/G	Glasgow Corporation Gas Dept.
K0850.01	KG/C	Kidderminster Gas Co
L2430.01	L/G	North Western Gas Board
L2430.01p	L/G	Leyland/Liverpool Gas Co
L2480.03/04/04aM	L/GAS/Co	Liverpool Gas Co
N0510.15	NC	Newark Corporation Gas Dept.
N0640.01	NCG	Nottingham Corporation Gas Dept.
N0645.01	N.C.G	Nottingham Corporation Gas Dept.
N1170.01M/01aM	NE/GB	North Eastern Gas Board
N1560.01M/01aM	N/GB	Northern Gas Board
N2110.01v	NMG	North Middlesex Gas Co
N2120.01	N./M.G./Co.	Newport (Monmouthshire) Gas Co.*
N3605.01M	NW/G	North West Gas
N3606.01M	NW/G.	North West Gas
N3610.01M/02M	NW/GB	North West Gas Board
P2150.01p	PG/C	Plymouth & Stonehouse Gas Co
R2000.01	RGC	Richmond Gas Co *
S2500.01	SEG	South Eastern Gas Board
S2510.01	SE/G	South Eastern Gas Board
S2520.01/01aM	SE/GB	South Eastern Gas Board
S2530.01	S&E/GC	Staines & Egham Dist Gas & Coke Co
S3120.01M/01aM/01d	S/GB	Southern Gas Board
S4990.01	SMGC	South Metropolitan Gas Co
S5000.01/01a/01b/01p	SM/GC	South Metropolitan Gas Co
S5010.01	S.M./G.C.	South Metropolitan Gas Co
S6630.01	SSG	South Suburban Gas Co
S7820.01	SU/GC	Swindon United Gas Co
S7825.01	S.U/G.C	Swindon United Gas Co *
S8120.01/01a	SW/GB	South Western Gas Board
T1310.01/02M/02a	TD/GCo	Tottenham & District Gas Co *
T1455.01	T&E/GAS/Co..	Tottenham & Edmonton Gas, Light & Coke Co
T1830.01/01p	T/G	Tottenham & District Gas Co
T5050.01	T.W/&Co.	Tunbridge Wells Gas Co
W0280.01	WA/StA	Watford & St Albans Gas Co
W2940.01ap	W/G	Woking Gas Co/Wandsworth Gas Co
W3000.01	WG/B	Wales Gas Board
W3030.01M	WGC	Wandsworth/Woking Gas Co
W5310.01M/02/02a	WM/GB	West Midlands Gas Board
W7100.01/01a	W&/StA	Watford & St Albans Gas Co

* Provisionally identity

"THE H.M.S.O. STAMP PERFORATING MACHINE":
THE SEQUEL

Michael Millar, FRPSC

I found the article "The H.M.S.O. Stamp Perforating Machine" in the April 2012 *Bulletin* of great interest because I am in the process of assembling an exhibit entitled "The Perfins of the British Stationery Office." What follows will deal solely with perfin H5200.01M.

After reading both the article and the ones it cited, I asked our Editor if he would let me have copies of the images that were provided by Mr. Glenn Morgan. I also asked for Mr. Morgan's e-mail address so that I could ask his permission to use the illustrations in my exhibit. At the same time, having obtained the postal address of the British Postal Museum & Archive (BPMA) Store in Loughton (Debden), Essex from the internet, I sent a letter to "The Manager" asking if it would be possible to obtain some plain paper strikes from the machine. I had noted that the close-up of the machine's table on page 21 had a sheet of paper on it and an enlargement of this showed that there were impressions punched into the paper.



*King George VI 3d
with perfin die
S(Crown)O -
S5630.01M used
7 January 1948.
Can anyone explain
why this stamp was
used on a Board of
Trade - British
Industries Fair
envelope?*

Mr. Morgan replied and readily gave permission to use the illustrations. He also told me that he was a volunteer at the BPMA Store and could not only provide me with more photographs, should I require them, but that he could provide me with some plain paper

⋮ ○

⋮ ⋮

⋮ ○

⋮ ⋮

⋮ ○

⋮ ⋮

⋮ ○

⋮ ⋮

⋮ ○

⋮ ⋮

⋮ ○

⋮ ⋮

⋮ ○

⋮ ⋮

⋮ ○

⋮ ⋮

⋮ ○

⋮ ⋮

⋮ ○

⋮ ⋮

⋮ ○

⋮ ⋮

⋮ ○

⋮ ⋮

examples from the machine itself. This bears out Mr. Edwards' statement of several years ago that the machine was [is] in full working order.^[2] Mr. Morgan noted that visitors to the Store were once allowed to make plain paper strikes with the machine and could keep them for souvenirs, but this is no longer the case as the machine needs to be relocated. He also confirmed that the machine still has all twelve perforating dies in place.

I had assumed, wrongly as it turns out, that with the switch to decimal currency that two of the dies would have been removed. He also told me that he was going to be tied up until September and would look after the photographs and perforating for me then. However, as will be noted below, his plans changed.

I then received an e-mail from the Curator of the Store, Mr. Julian Stray, to inform me that my letter and Mr. Morgan arrived at the Store at approximately the same time. He thanked me for my letter and said that Mr. Morgan would look after my request. Mr. Morgan also e-mailed me to say that because he needed to visit the Store to complete a project, he had gone there to take the photographs and do the sample perforations. I quote from Mr. Stray's e-mail "Unfortunately, due to the current place where the perforator is stored (the top shelf of some racking) he was unable to take any photographs for you. However, I was able to access the machine to take some perforated examples for you. Glenn will be sending these on to you in due course. I hope these are of some use to you in your exhibit."^[3] This is certainly above and beyond the call of duty and is greatly appreciated. At the same time a set was also made for Roy Gault (catalogue editor) for his records.

The impressions show the well-known constant variety of the missing pin in the middle of the M in the fifth die from the left. This pin seems to have gone missing quite early in the period of use and was not replaced.

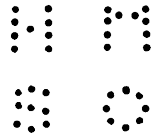

I have an example of this on the 1951 5/- (SG 510) and if anyone has an earlier example I would be pleased to hear about it.

Mr. Morgan has also drawn my attention to two missing pins at the top of the right side of the M in the second die from the left.

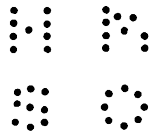

I have no examples of this in my collection and Mr. Morgan is of the opinion that the pins may have gone missing subsequent to the machine's being turned over to BPMA. However, if anyone does happen to have any examples of this variety in their collection, please let me know the issues and values.

In conclusion I would like to express my sincere thanks to Mr. Morgan and to Mr. Stray for all of the efforts they have put into this project on my behalf. It is very much appreciated and full credit will be given in the exhibit.

While the foregoing has dealt only with H5200.01M, I am still in need of a number of items for the projected exhibit, namely – S5630.01M, I need issue I RC 3d as well as some on cover material of issue I; I also need issue L 2½d; and issue O 1½d. In addition, I need an example of H5200.02 on stamp, or preferably on cover. If anyone can assist with any of the foregoing I will be very grateful. [*Ed: contact details can be found on page 3*]

References

- [1] Maurice Harp, "The H.M.S.O. Stamp Perforating Machine," *GB Perfin Society Bulletin* 377 (Apr. 2012): 21-23.
- [2] Tony Edwards, "The HM/SO Perforating Machine," *GB Perfin Society Bulletin* 206 (Aug. 1983): 9.
- [3] Julian Stray, email to the author, 12 July 2012.
- [4] Scan courtesy of Roy Gault

SEEN IN AUCTION

Michael Cole alerted me to the Philangles Auction No 284 of 23rd July which had 43 different lots of perfins from all around the world. The reserves on many of the items was clearly very high and Michael doubted that many of them would actually sell. Well it turned out that he was correct. Of the 43 lots only 11 actually sold and these I have listed below.

737	Bosnia - 24 perfins mostly on diff. early issues & a variety of company initials (res. £30)	£30
949	Cuba - 30 mostly diff. company initials and/or issue of stamp all dating from the 1940's (res. £30)	£35
1964	Hungary - a substantial collection of 320+ different on early stamps with a good variety of issues, many diff. company initials & unusual pictorial types. (res. £150)	£340
2048	Ireland - a very good collection of 180+ on Hagners chiefly on earlier stamps inc 1922 ovpt issues, values to 5/- Patrick. A very good range of company initials. (res. £150)	£250
2272	Italy - Extensive collection of 400+ diff chiefly early material with v. good variety of company initials & types (res. £200)	£220
2513	Malaya - fine collection with many QV to KGV, over 150 used, many diff company initials & use of diff stamps to \$5. Some v/good early QV issues & 1935 Jubilees. (res. £200)	£280
2689	New South Wales - a fine collection of 120+ mostly diff on QV issues inc a fine range of company initials, OS/NSW with values to 2/6d. (res. £80)	£80
2901	Norway - a scarce selection of 20 with various company initials from early posthorns onwards. (res. £30)	£30
3082	Portugal - Collection of 200+ diff with many diff company initials on wide variety of stamp/issues from earlies. (res. £100)	£90
3380	Spain - a collection of over 300 mostly diff. on earlier issues, extensive variety of company initials inc. fancy types on a wide range of issues. (res. £120)	£120
3560	Tunisia - Collection of 35 mostly diff. & scarce company initials on early issues + T telegraphs inc. inverted types. (res. £50)	£40
3659	Victoria - Collection of 100+ mostly diff. on QV inc a good range of company initials & OS, values to 2/-, all used. (res. £80)	£90

It is interesting to note that almost all the sales were at the reserve price and that the only British perfin lot - a collection of 5000+ (res £1000) - failed to find a buyer.

TEN FLINTSHIRE PERFINS.

Roy Gault

The attractive curved (Full Name) Perfin “STELLITE/L^d” (S7345.01), has for decades eluded even a partial identity, but by chance earlier this year *Rosemary Smith* reported an actual date of 23rd March 1937. More than that, she kindly sent me the stamp for perusal in the hope that the post-town could be deciphered. My own example yielded ‘OU’ (although with hindsight I can now make out QUEENSF...), and Rosemary’s produced ‘RY’, so on the face of it we were no nearer establishing where the Perfin was used.

Perfin known only on 1½d issue ‘M’, and a ½d & 1½d issue ‘O’, giving a die-in-use date range of **1935-1937**.

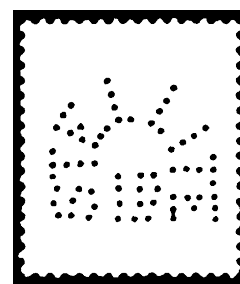

S7345.01

Although a search of the Internet a few years ago for “STELLITE” produced very little, a similar search now gives a reference to a steam locomotive in the Industrial Locomotive Society Handbook for North Wales, which I just happen to have a copy of!

SMOKELESS FUEL PLANT - Stellite Ltd

Locomotive: Gauge 4'8½"

SHEPPERTON 0-6-0ST OC P 1616 1923 (Sa) (S1)

(Sa) tdx: Willys Overland Crossley Ltd, Heaton Chapel, Stockport, Cheshire, after 4/1934 by 12/1/1935.

(S1) departed after 25/2/1938; advertised for sale by George Cohen, Sons & Co Ltd, dealers, 1938.

wlw(tdt?): Tyne Improvement Commissioners, Percy Main, North Shields, Northumberland, by 6/4/1939

Stellite Ltd's Smokeless Fuel Plant in Queensferry, Flintshire, was registered in April 1934, but by c1938 had closed. Although the details are scant, they tie in perfectly with the stamp issues, dates, and partial postmarks. As for ‘SHEPPERTON’, a Peckett Class B2 0-6-0ST built in Bristol in 1923, it became No.4 (later No.6) with the Port of Tyne Authority, and was eventually scrapped in March 1959.

The Welsh county of Flintshire, now part of Clwyd, was relatively small and boasts only a handful of Perfins. In addition to “STELLITE/L^d”, I’ve managed to find another **nine** which emanated from the county, although I must admit my search wasn’t exhaustive! Not included in the article are any Perfins whose user is known to have been based outside the county but recorded with a Flintshire postmark.

e.g. Great Central Railway “GC” (G0760.03M), postmarked Shotton.

By far the earliest example with a Flintshire postmark is the rare Perfin “DR.S^tA”. The only known example, as far as I’m aware, is shown below clearly postmarked with the St Asaph Duplex ‘676’.

- St Asaph.

User unknown.

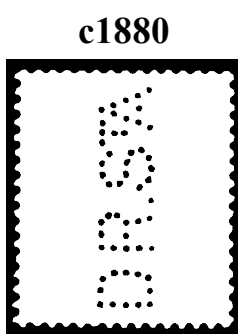

D4245.01



There are just **three** commercial companies.

- **Courtaulds**, Aber Works, Flint.
Originally (1908) the British Glanzstoff Manufacturing Co, but taken over by Courtaulds in 1917. The works were shut down in 1957, only to be re-opened in 1966, and finally demolished in 1984.

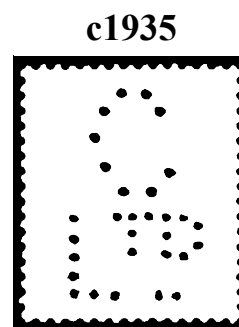

C4650.04

- **H M Factory**, Queensferry.

The factory was acquired in 1915 for the manufacture of gun cotton, but later included explosives such as TNT to help the war effort.

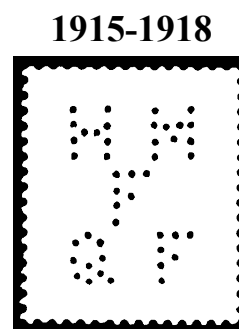

H5080.01

- **John Summers & Sons, Shotton.**

Hawarden Bridge Steel Works, Shotton, was opened in 1896. Company H/Q transferred there from the Globe Works, Stalybridge, in 1908. Absorbed into British Steel in 1967.

1912-1939

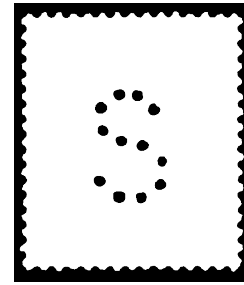

S0010.51

Another **five** Perfins were used by local authorities, although some were also used by users outside the county*. Note also that the date ranges quoted are for the overall use of the die and not necessarily for it's use in Flintshire. All five dies were produced by J Sloper & Co.

- **Flint BC, Town Hall, Flint.**

First granted a charter in 1284, becoming a Borough Council in the 1880's.

1957-1974*

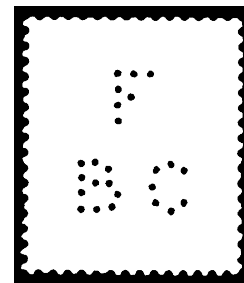

F0290.01M

- **Holywell RDC, Council Offices, Halkyn Rd, Holywell.** Created under the provisions of the Local Government Act 1894.

1957-1974*

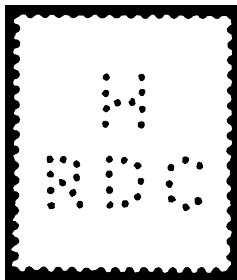

H6180.02

c1939

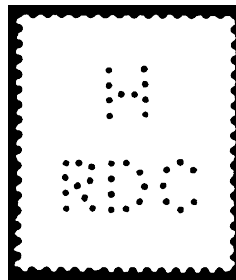

H6180.01

1965-1974*

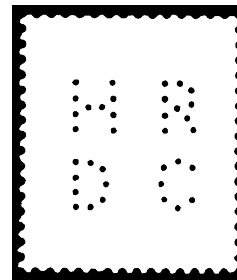

H6170.01

- **Hawarden RDC, Council Offices, Hawarden.** {Created 1894}. Used "HR/DC" (H6170.01) shown above.

1965-1969*

- **Mold UDC, Town Hall, Mold.**

Created under the provisions of the Local Government Act 1894.

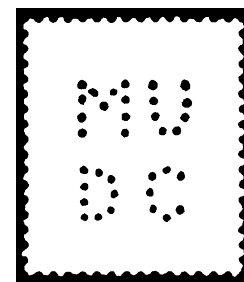

M5755.01

The local authorities listed here all ceased under local authority re-organisation on *1st April 1974*.

HULL TOWN COUNCIL PERFIN

Maurice Harp

I stumbled across this rather odd report of a Hull Town Council meeting in The York Herald May 6th 1887.

HULL TOWN COUNCIL

A meeting of the Town Council was held, yesterday afternoon at the Town Hall, the Mayor (Ald. Leak) in the chair. It being a quarterly meeting, many of the members wore their robes.

Mr C. Shaw and The Stamps

*On the passing of the money orders, Mr C Shaw called attention to an amount of £30 for stamps, and expressed the opinion there should be some check upon the use of stamps by perforation or otherwise. - Ald. Rayment thereupon informed Mr. Shaw that the stamps were perforated. - Mr. Shaw said the plan could only have been adopted recently. - **Mr. Milner the borough accountant, replied that the stamps had been perforated for the last eight years. (Laughter)** - Mr. Shaw said he would go and see for himself, and he left the Council Chamber for that purpose. He shortly afterwards returned and said he had obtained a stamp from the office, and had shown it to half-a-dozen of his colleagues, who could not, even with glasses, detect the perforation. - Mr. Larard remarked that there was a perforation, "H.C." meaning Hull Corporation. - Mr. Shaw said they could not see it when the stamp was on paper. - The Mayor said he could not allow the debate to be resumed. - Mr. Shaw again attempted to address the meeting, and was met with cries of "Order". He contended that he ought to be allowed to explain. - The Mayor said he could give notice of the question.*

This piece would date the introduction of perfins at Hull Corporation to 1879 which is surprisingly early. The earliest recorded die that we are aware of is H1160.13 - HC which is thought to have dated from 1890 - the earliest recorded dated copy is July 25th 1894. If introduced in 1879 we would expect to find the die on 1d reds. So maybe Mr Milner was exaggerating to try and keep Mr. Shaw quiet or maybe there is a die that we haven't found yet. Can anyone show an earlier use of a Hull Corporation die?

CONTENTS

PAGE

Society News:-

Membership Changes; Secretary/Treasurer; Subscriptions Due; New Collectors Website; Member's Appeal; AGM Meeting;	2 - 4
--	-------

Members' Comments:-

Arthur Wyatt & the Penrhyn Colliery	5 - 6
-------------------------------------	-------

Articles

Alice Sloper	John Mathews	6
Board of Trade Perfins	I. J. Bernstein	7 - 10
Latham Brother of Bolton	Maurice Harp	11
New Illustrated Catalogue - Letter "B"	Roy Gault	12
Canadian Stamps with Perforated Initials 5th Edition Published	Maurice Harp	13
The Mirrlees Watson Co. Ltd.	Richard Husband	14 - 16
Joseph Sloper's Place of Death	John Mathews	17
Gas Companies	Julie Barnard	18 - 23
The HMSO Stamp Perforating Machine - The Sequel	Michael Miller	24 - 26
Seen in Auction	Maurice Harp	27
Ten Flintshire Perfins	Roy Gault	28 - 30
Hull Town Council Perfin	Maurice Harp	31

New Identities Pages 473 - 484

12 Pages

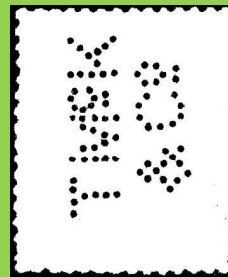

The Bulletin of the G.B. Perfin Society is a bi-monthly journal.
Subscription is £10 (UK); £12 (Europe/abroad-surface); £15 (abroad-air);
£10 (electronic). For further details of the G.B. Perfin Society and
membership application please contact: