

# Albion

Copper Hot Water Products



*Exceeding the Standard*



# SELECTION GUIDE

Albion Water Heaters is part of Kingspan Hot Water Systems Ltd, manufacturing a variety of water heating products. Mainly domestic and industrial hot water cylinders in unvented Duplex stainless steel and open vented copper units. They are all built to the highest possible standards with a focus on being environmentally friendly. This is part of the philosophy on which the group has grown, and it forms the basis of our mission statement for the future.

This information is a general guide for selecting the correct size of cylinder for use in domestic applications. If you are in any doubt or have a more specialist application such as a nursing home, sports centre or youth hostel, please call us for more information.

The following are two main factors to take into account:

- The storage volume required to meet peak hot water demand.

Typical hot water demand (litres of water at 60°C) is:

- Standard bath - 60 litres
- Corner bath - 120 litres
- Gravity shower - 30 litres
- Power shower - 60 litres
- Wash basins - 5 litres
- Kitchen sink - 15 litres

- How quickly can the energy source heat the water.

With gas or oil boilers, fast recovery cylinders such as Superduty can help you to achieve quicker reheats and reduce the amount of water that needs to be stored.

When off peak electricity (Economy 7 or 10) is used for water heating, it is most economical to heat the total contents of the cylinder overnight. This reduces the need to use immersion heater boost periods during the day when electricity is more expensive. Maxistore Economy 7 cylinders, which meet the Maxistore specifications are recommended for all electric applications.

## PART L BUILDING REGULATIONS

Changes come into effect from October 2010, our extensive range of vented copper cylinders have been tested and modified to deliver low standing heat loss and keep CO2 emissions to a minimum in line with these regulations.

The regulations have two sections; Part L covers the conservation of fuel and power in new dwellings and Part L1B covers the conservation of fuel and power in existing dwellings, which will apply to the work undertaken in existing homes and covers replacement cylinders only (Part L1B insulation requirements are lower than those of Part L).

As the market leader in the manufacture of hot water cylinders, we want to lead the way in ensuring our products are as energy efficient as possible and in line with new regulations

## NEW INSULATION LEVELS:

- Part L (new build & replacement cylinders) will have 50mm insulation.
- Part L1B (replacement only cylinders) will have 35mm insulation.





Standard Indirect

Ultracyl

Combi Unit

Maxistore

Superduty

Stored Hot Water Required (ltrs)

	Standard Indirect	Ultracyl	Combi Unit	Maxistore	Superduty
1 Bedroom + Shower	70	90	85	120	45
1 Bedroom + Bath	80	90	85	144	80
2 Bedrooms + Standard Bath	100	90	115	144	80
1/2 Bedrooms + Corner Bath	140	120	140	210	120
3 Bedrooms + Standard Bath	120	120	115	210	80
3/4 Bedrooms + Bath + Ensuite	140	130	140	210	120
3/4 Bedrooms + Corner Bath	160	160	210	210	140
4 Bedrooms + Corner Bath + Ensuite	200	160	210	-	160
2/3 Bedrooms + 2 Baths	200	160	210	-	180
4/5 Bedrooms + 2 Baths	245	210	210	-	210

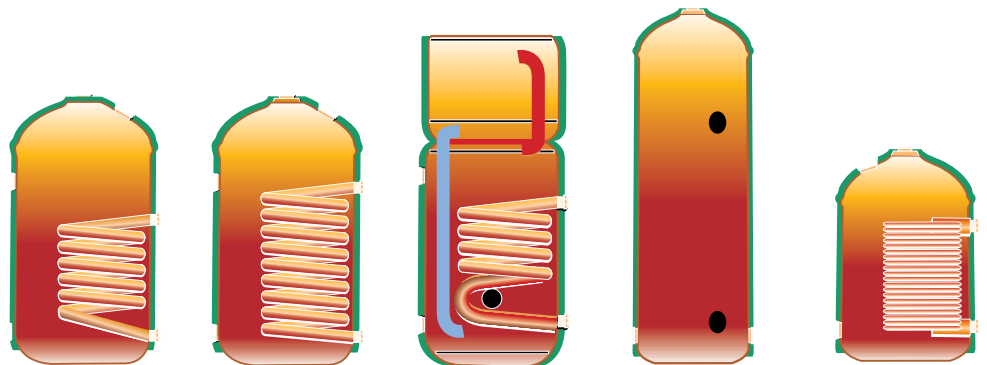

# WORKING HEAD

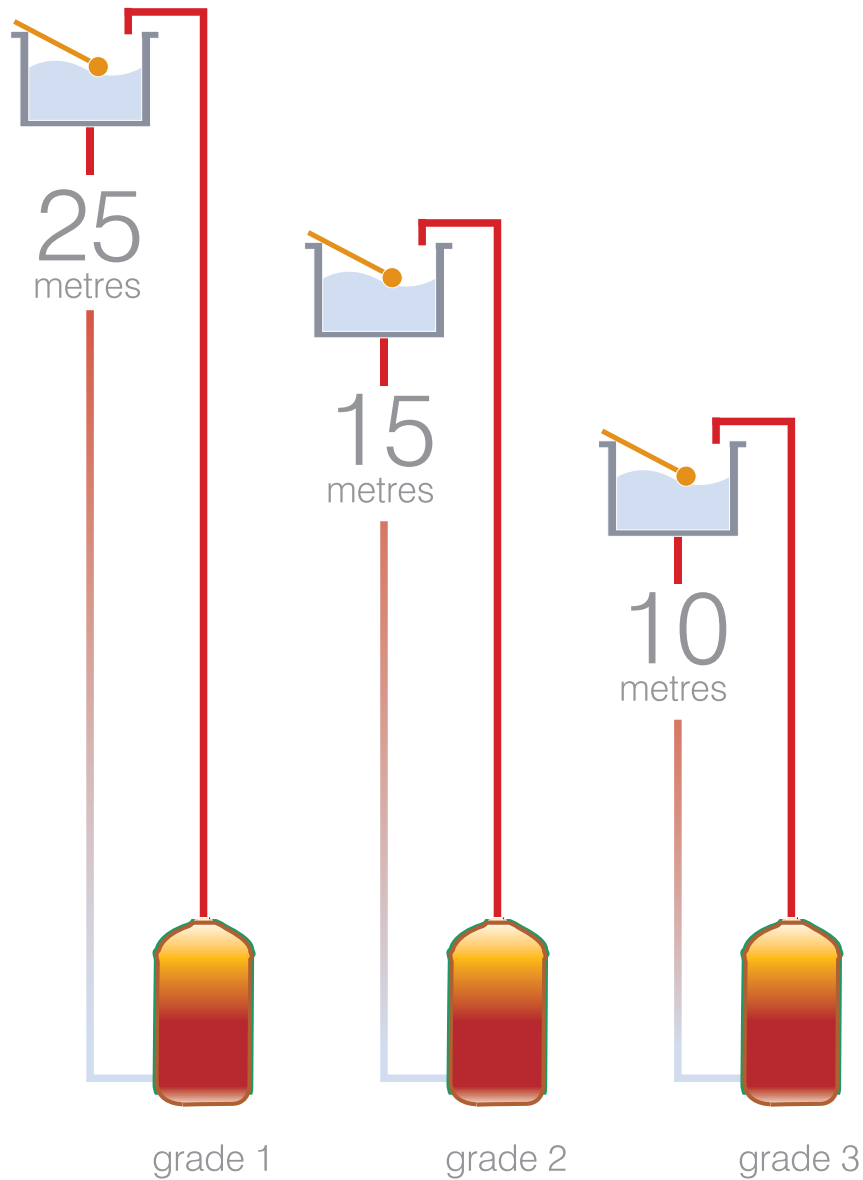

<b>Test Pressure</b>	3.65 Bar / 53 P.S.I.	2.20 Bar / 32 P.S.I.	1.45 Bar / 21 P.S.I.
<b>Working Head</b>	2.5 Bar / 36 P.S.I.	1.5 Bar / 22 P.S.I.	1.0 Bar / 14.5 P.S.I.

Cylinders for higher working head applications are available on request.

# British Standard

## Direct cylinders



BS 1566:2002  
where applicable

### Features and benefits

- Available in plain or foam lagged.
- Grades 1, 2 & 3.
- A full range of sizes available.
- For use in conjunction with an electric immersion heater.
- Can also be heated by a back boiler.
- Extra tappings and immersion heater bosses can be fitted dependent on individual requirements.
- Available with compression fittings.
- Available with 50mm of CFC free foam lagging which adds approximately 100mm to the cylinder diameter.

For use in electric homes or where a solid fuel powered heating systems is installed.

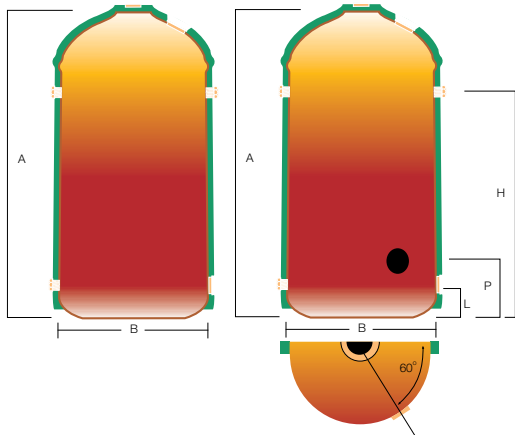

BS ref	Size A x B (mm)	capacity litres	B.S.P. Connections Male or Female  (inc. I.H. boss)	Height of screwed connections		
				H (mm)	L (mm)	P (mm)
0	1600 x 300	98	Four x 1"	1250	100	150
1	900 x 350	74	Four x 1"	700	100	150
2	900 x 400	98	Four x 1"	700	100	150
3	1050 x 400	116	Four x 1"	800	100	150
4	675 x 450	86	Four x 1"	450	100	150
5	750 x 450	98	Four x 1"	550	100	150
6	825 x 450	109	Four x 1"	625	100	150
7	900 x 450	120	Four x 1"	700	100	150
8	1050 x 450	144	Four x 1"	800	100	150
9	1200 x 450	166	Four x 1"	950	100	150
9E	1500 x 450	210	Four x 1"	1200	100	150
10	1200 x 500	200	Four x 1½"	950	150	200
11	1500 x 500	255	Four x 1½"	1200	150	200
12	1200 x 600	290	Four x 2"	950	150	200
13	1500 x 600	370	Four x 2"	1200	150	200
14	1800 x 600	450	Four x 2"	1350	150	200

There are various combinations of connections - choose the specification to fit your pipework system

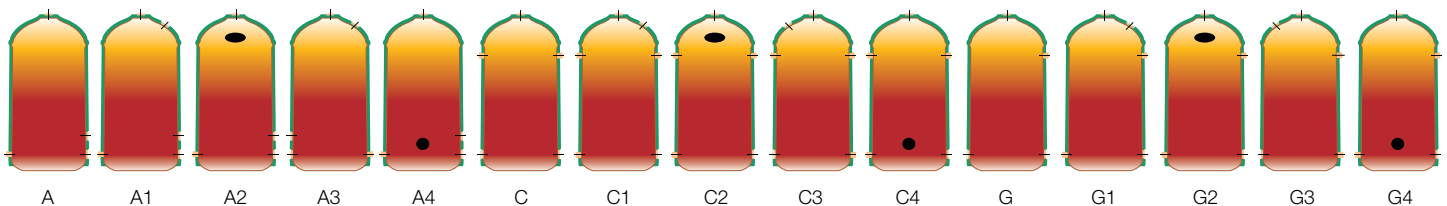

# British Standard Indirect cylinders

Double Feed Coil Type.

## Features and benefits

- Available in plain or foam lagged.
- Grades 1, 2 & 3.
- A full range of sizes available.
- For use in conjunction with a central heating system.
- Optional High Recovery coil types available.
- Immersion heater bosses fitted for potential electrical use.
- A variety of coil types available, e.g. Cross Flow and Stretch Coils.
- Extra tappings and immersion heater bosses can be fitted dependent on individual requirements.
- Available with compression fittings.
- Available with 50mm of CFC free foam lagging which adds approximately 100mm to the cylinder diameter.
- 25 minute recovery (approx) on a fully pumped system (when tested in accordance with BS1566:2002:P).



BS 1566:2002  
where applicable

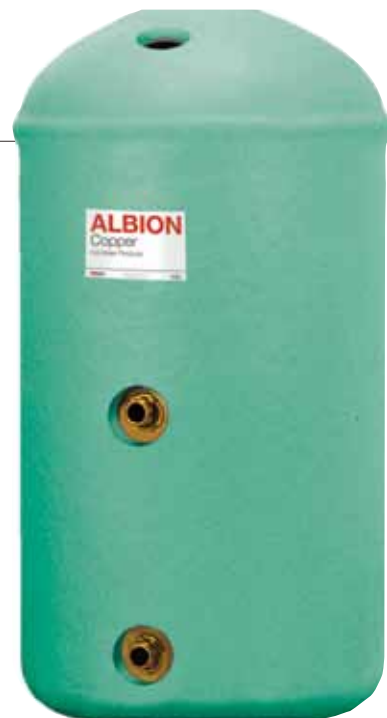

**For use with wet central heating systems and/or electric immersion heater operation**

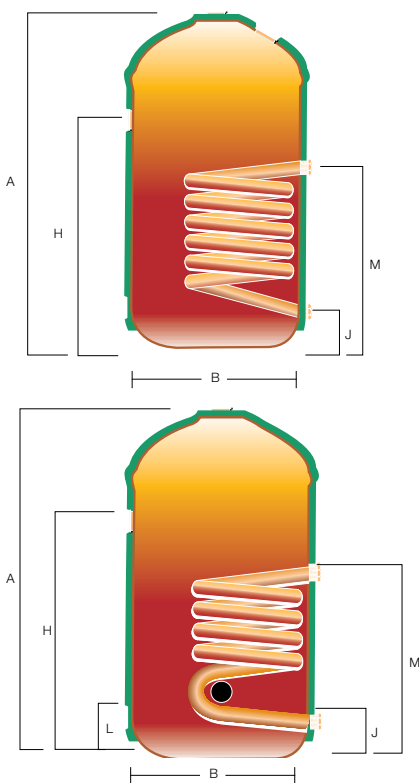

BS ref	Size A x B (mm)	capacity litres	B.S.P. Connections Male or Female  (inc. I.H. boss)	Height of screwed connections			
				H (mm)	J (mm)	L (mm)	M (mm)
0	1600 x 300*	96	Four x 1"	1250	100	100	540
1	900 x 350*	72	Four x 1"	700	100	100	400
2	900 x 400*	96	Four x 1"	700	100	100	400
3	1050 x 400*	114	Four x 1"	800	100	100	470
4	675 x 450*	84	Four x 1"	450	100	100	300
5	750 x 450*	95	Four x 1"	550	100	100	340
6	825 x 450*	106	Four x 1"	625	100	100	370
7	900 x 450*	117	Four x 1"	700	100	100	400
8	1050 x 450*	140	Four x 1"	800	100	100	470
9	1200 x 450*	162	Four x 1"	950	100	100	540
9E	1500 x 450	206	Four x 1"	1200	100	100	620
10	1200 x 500	190	2 x 1½" male and 2 x 1½" female	950	150	150	540
11	1500 x 500	245	"	1200	150	150	670
12	1200 x 600	280	2 x 1½" male and 2 x 2" female	950	150	150	540
13	1500 x 600	360	"	1200	150	150	670
14	1800 x 600	450	"	1350	150	150	800

\* These units are suitable for pumped circulation primaries. If you require gravity circulation, please state it at the time of the order.

There are various combinations of connections - choose the specification to fit your pipework system

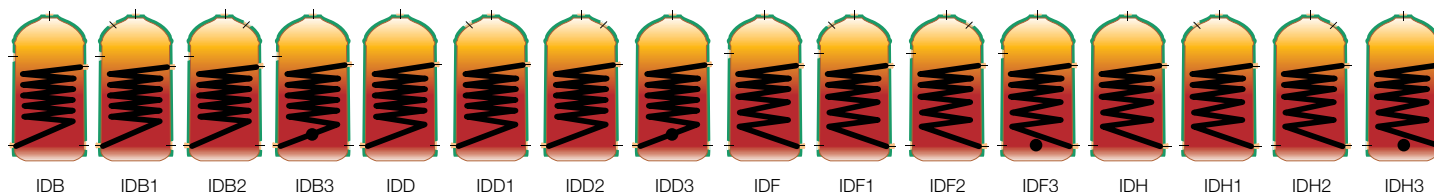

# British Standard Twin Coil Cylinders

Indirect, double feed coil type.

Twin coil cylinders are for use where two heat sources are available; eg. solid fuel (Aga) or Wood Burner, as well as a conventional boiler.

## Features and benefits

- Grades 1, 2 & 3.
- Available in plain or foam lagged.
- A full range of sizes available.
- Optional 5-year anti-corrosion guarantee (anti-corrosion Resistant).
- Extra tappings and immersion heater bosses can be fitted dependent on individual requirements.
- Optional High Recovery coil types available.
- Coils can be fitted either opposite each other or stacked vertically.
- Available with optional compression fittings.



BS 1566:2002  
where applicable

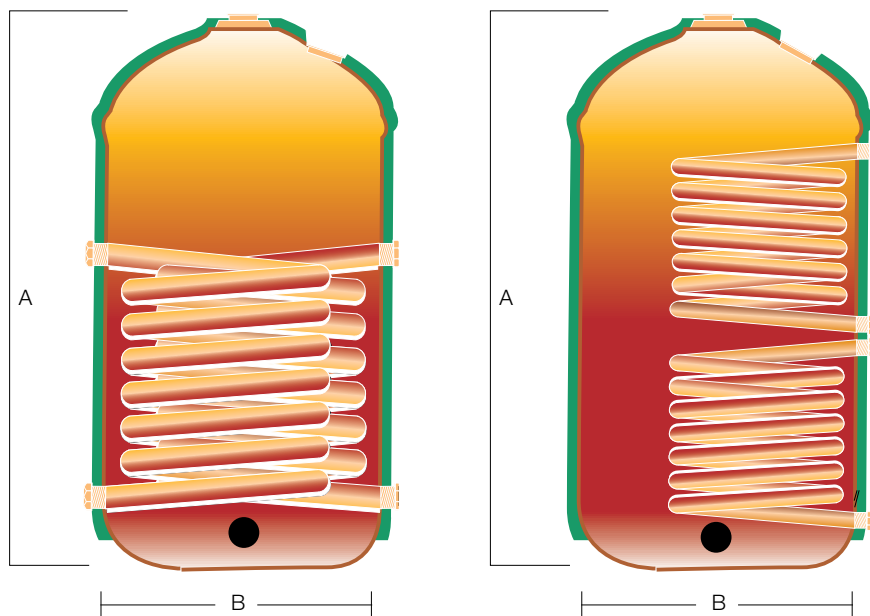
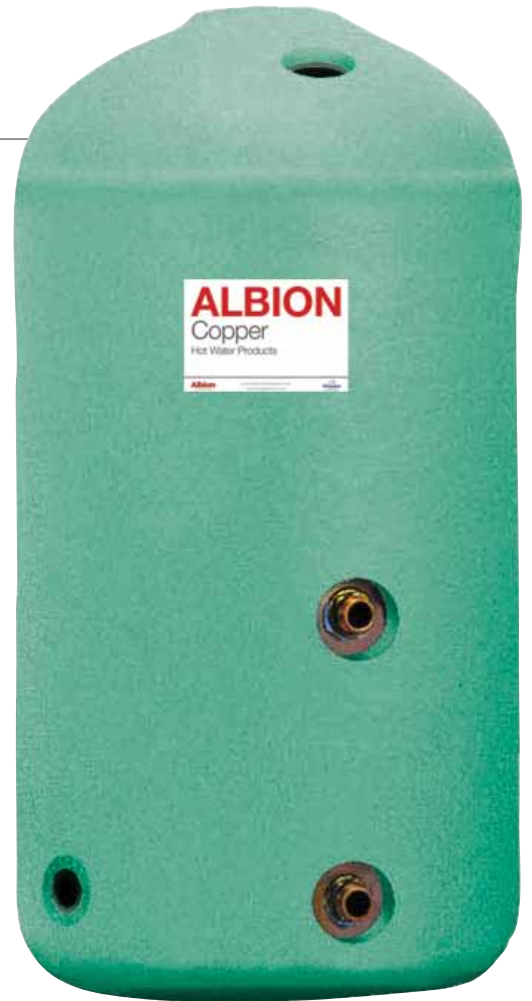

ext. ht (A) mm	ext. dia (B) mm	heating surface m <sup>2</sup>
1600	300	0.42 x 2
900	350	0.31 x 2
900	400	0.42 x 2
1050	400	0.50 x 2
675	450	0.37 x 2
750	450	0.48 x 2
825	450	0.53 x 2
900	450	0.61 x 2
1050	450	0.70 x 2
1200	450	0.79 x 2
1500	450	0.96 x 2
1200	500	0.88 x 2
1500	500	1.10 x 2
1200	600	1.18 x 2
1500	600	1.57 x 2
1800	600	1.97 x 2

# Ultracyl

## Indirect cylinders

Double feed coil type.



BS 1566:2002  
where applicable

### Features and benefits

- 50mm foam lagging.
- 5-year anti-corrosion guarantee.
- For use in conjunction with a central heating system.
- Shower flange / secondary return on larger sizes.
- A stat boss or stat pocket and stat can be fitted on request.
- Grades 1, 2 & 3.
- Compression fittings as standard.
- Baffle on cold feed.
- 20 minutes recovery on full pumped systems (when tested in accordance with BS1566:2002:P).

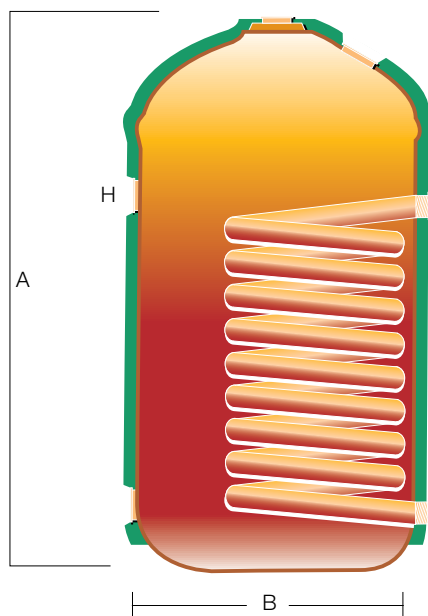

ext. ht (A) mm	ext. dia (B) mm	capacity litres
750	400	80
850	400	90
1180	400	130
900	450	120
1200	450	160
1500	450	210

**NB:** Fifth connection (H) on sizes 1500, fitted on other sizes only on request



# Superduty

## Multicoil cylinders and combination tanks

### Features and benefits

- The Superduty CF45 and the Superduty CF80 come complete with 4 x 22mm compression fittings and I.H. Boss.
- The larger cylinders in the range have 4 x 28mm tapings as standard and I.H. Boss.
- All have a ½" BSP female probe stat facility.
- The Superduty range is designed for conventional fully pumped systems.
- Optional shower flange adaptor.
- Available in combination tank form.
- Probe stat available on request.

### Superduty 45 litre

- Rapid recovery.
- Small conventional cylinder.
- Fully Pumped System.
- Multi Coil Heat Exchanger.
- Extra space in airing cupboard.
- Replaces standard size cylinder.
- Saves on gas bills.
- Reduces boiler cycling.
- Maximum Boiler Efficiency.
- Will fill a standard bath.
- Works like an instantaneous hot water cylinder.
- It's recovering as it's being used.
- Probe thermostat recommended for efficient boiler response.
- 50mm foam lagging.
- Immersion heater available.
- 350mm diameter x 600mm height on Superduty CF45 litre model.
- 5-year anti-corrosion guarantee.



### specification

ext. ht (A)	ext. dia (B)	capacity
mm	mm	litres
600	350	45
750	400	80
900	450	120
1050	450	140
1200	450	160
1350	450	180
1500	450	210

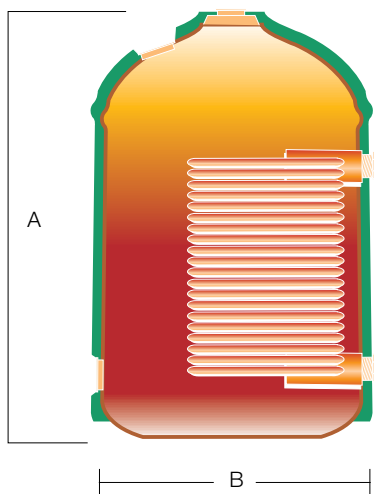

### recovery chart

Time in minutes to raise contents through 40°C

Boiler output	Capacity						
	45	80	120	140	160	180	210
9kw	15	23	30	34	38	42	47
12kw	10	17	22	25	28	31	36
15kw	8	14	18	20	22	25	28
24kw	5	8	11	13	15	17	20
30kw	4	7	10	12	14	16	19

# Single Feed, Self-Priming Cylinders & combination units

## Features and benefits

- Available in plain or foam lagged.
- Cylinders are available in Grades 2 & 3.
- A full range of sizes available.
- Extra tappings and immersion heater bosses can be fitted dependent on individual requirements.
- Available with compression fittings.
- For replacement applications only.
- For use in conjunction with a central heating system.
- Not suitable for fully pumped systems.

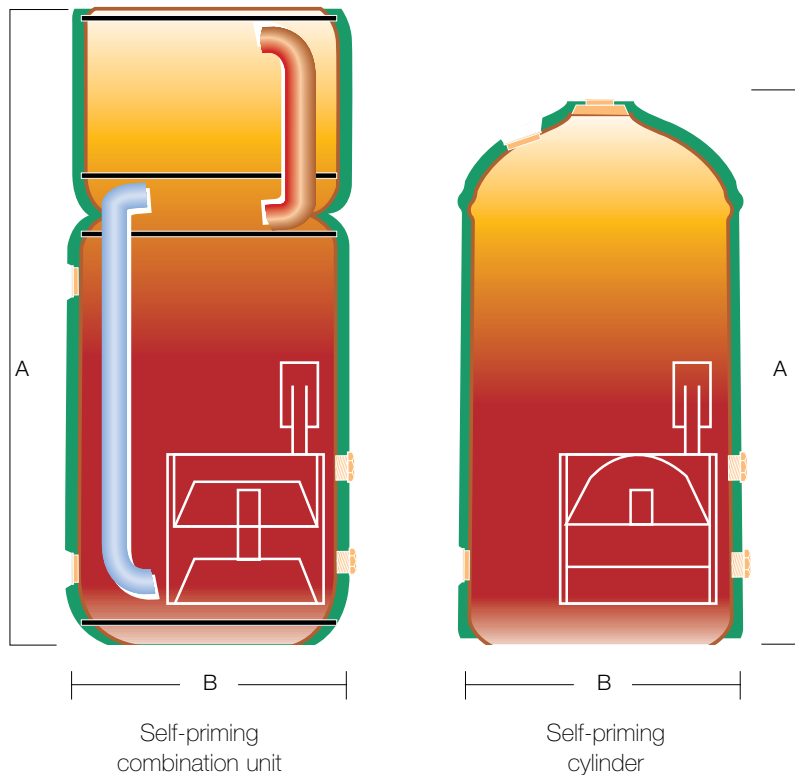
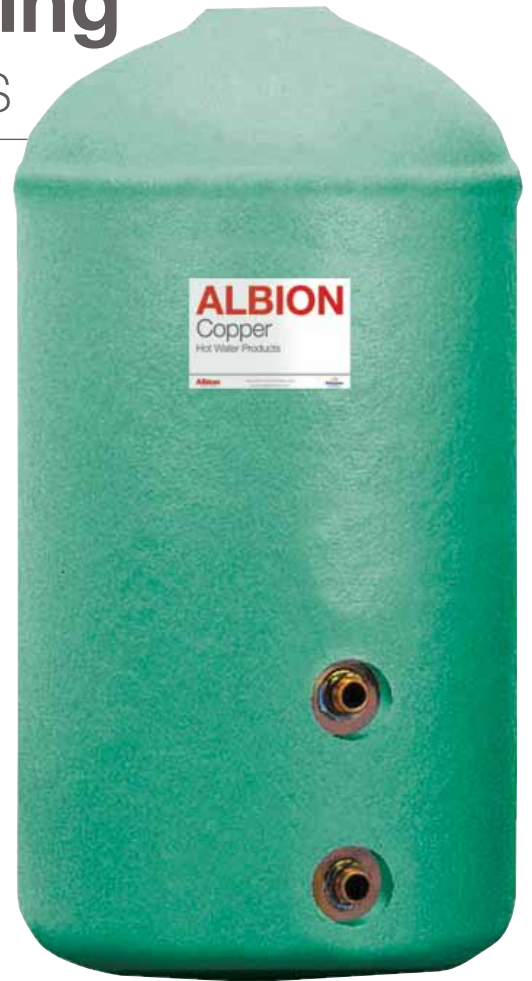

## Self-priming cylinders

ext. ht (A)	ext. dia (B)	capacity (litres)
mm	mm	
900	400	92
1050	400	109
900	450	108
1050	450	130
1200	450	152

NB: Other sizes available on request

## Self-priming combination units

ext. ht (A)	ext. dia (B)	capacity (litres)	
		hot	cold
mm	mm		
900	400	65	15
900	450	85	20
1075	450	115	20
1200	450	115	40

NB: Other sizes available on request

# Direct & Indirect Combination units

Combination units eliminate the need for a cold water storage tank and remove the complication of running pipes to and from the cold water system.

## Features and benefits

- British Standard or other sizes manufactured to suit individual requirements.
- Reduces installation costs.
- Suitable for properties without loft space; i.e. flats, bungalows and bedsits.
- Available in High Recovery and Twin Coil.
- Optional 5-year guarantee (Corrosion Resistant).
- Direct units for use with an immersion heater only.
- Indirect to be used in conjunction with a Central Heating System.
- Available with compression fittings.



BS 3198:1981  
where applicable

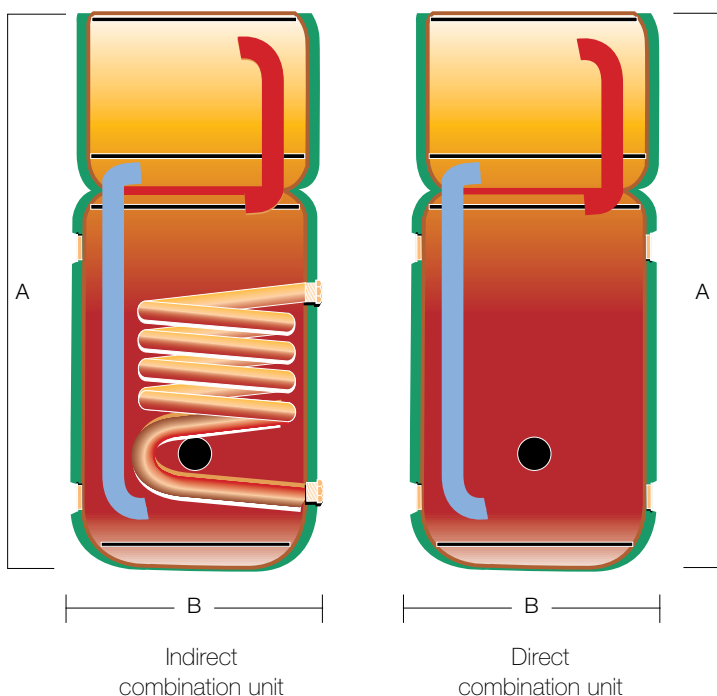

## Specifications - direct units

ext. ht (A)	ext. dia (B)	capacity (litres)	
		hot	cold
mm	mm	65	15
900	400	85	20
900	450	115	20
1050	450	120	40
1200	450	144	40
1400	450	160	40
1600	450	210	40
1850	450		

## Specifications - indirect units

ext. ht (A)	ext. dia (B)	capacity (litres)	
		hot	cold
mm	mm	65	15
900	400	85	20
900	450	115	20
1050	450	120	40
1200	450	144	40
1400	450	160	40
1600	450	210	40
1850	450		

NB: Other sizes available on request

# Maxistore

## Direct & indirect cylinders



BS 1566:2002  
where applicable

### Features and benefits

- Available in Grades 1, 2 & 3.
- Baffle plate fitted over cold feed to minimise mixing of hot & cold water.
- 50mm foam lagging.
- Used in conjunction with 'low tariff' electricity.
- 2 Side entry immersion heater connections.
- Bottom connection for 'Economy 7 or 10' tariff. Top connection for daytime boost.



### heat loss table

**The daily (24 hour) heat loss when carried out using the required procedure shall not be more than the following:**

capacity of hot water storage litres	maximum daily heat loss kWh / 24h
120	2.4
144	2.5
210	2.7

### direct units

	<b>BS7</b>	<b>BS8</b>	<b>BS9E</b>
<b>capacity litres</b>	<b>120</b>	<b>144</b>	<b>210</b>
<b>dimensions mm</b>			
A	900	1050	1500
B	450	450	450
L	100	100	100
P	150	150	150
Z	500	600	1100

### indirect units

	<b>BS7</b>	<b>BS8</b>	<b>BS9E</b>
<b>capacity litres</b>	<b>117</b>	<b>140</b>	<b>206</b>
<b>dimensions mm</b>			
A	900	1050	1500
B	450	450	450
L	100	100	100
P	150	150	150
Z	500	600	1100
J	100	100	100
M	500	550	650

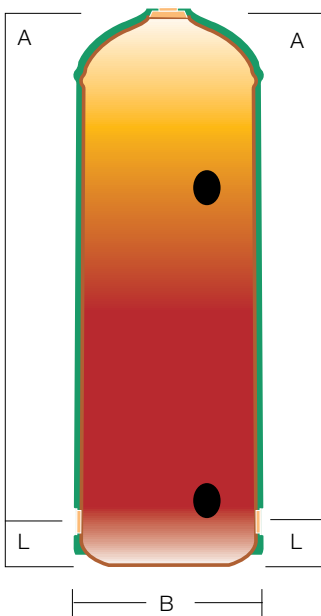

Maxistore  
direct unit

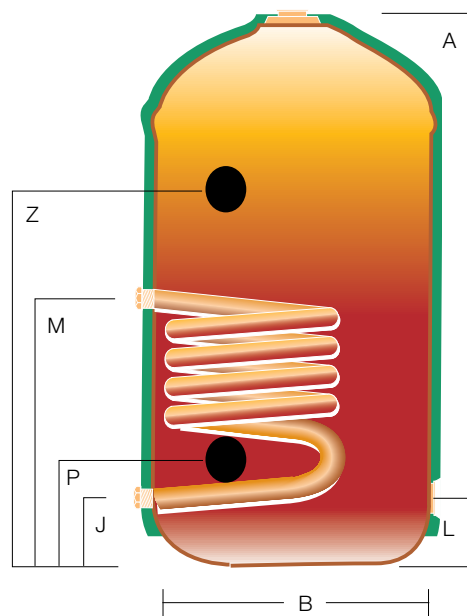

Maxistore  
indirect unit

# Direct and Indirect Maxistore Combination units



## Features and benefits

- 50mm foam lagging.
- Used in conjunction with 'low tariff' electricity.
- 2 Side entry immersion heater bosses.
- Bottom boss for 'Economy 7 or 10' overnight tariff. Top boss for daytime boost.
- Extra tapings and immersion heater bosses can be fitted dependent on individual requirements.
- Indirect combination units are also available to the above specification.



BS 3198:1981  
where applicable

ht (A)	dia (B)	C	D	E	F	capacity litres	
						hot	cold
mm	mm						
1200	450	100	500	150	700	120	40
1400	450	100	650	150	900	144	40
1600	450	100	800	150	1000	166	40
1850	450	100	1100	150	1350	210	40

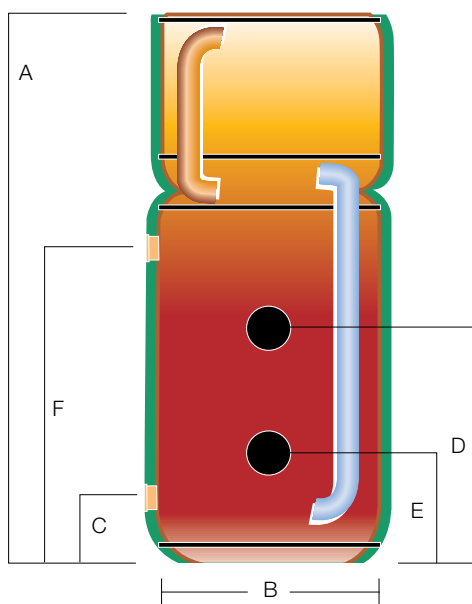

Direct Maxistore  
combination unit

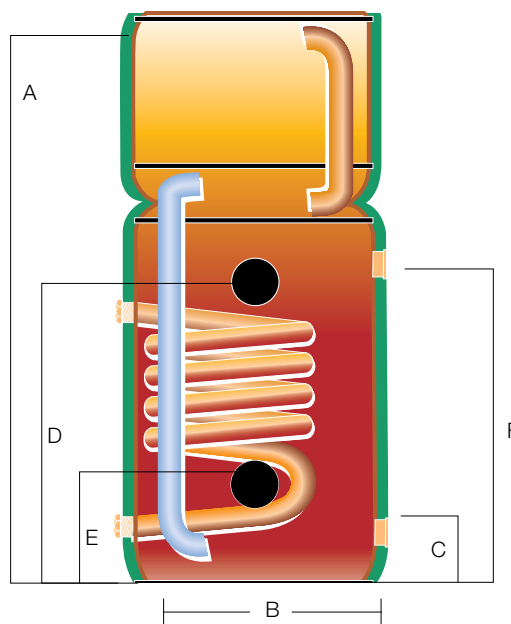

Indirect Maxistore  
combination unit

# IC10 Integrated Combi units

Indirect, double feed.

## Features and benefits

- Space saving design - ideal for installation in restricted spaces, e.g. lofts, bedsits and bungalows.
- High Recovery coil available.
- Extra tappings and immersion heater bosses can be fitted dependent on individual requirements.
- Indirect Maxistore versions available.
- 50mm foam lagging.
- A twin top tank for DHW and Boiler F+E.

The Albion IC10 unit has all the benefits of combined hot and cold storage as well as an isolated integral feed and expansion tank for primary (central heating) circuits eliminating the risk of primary and secondary mixing.

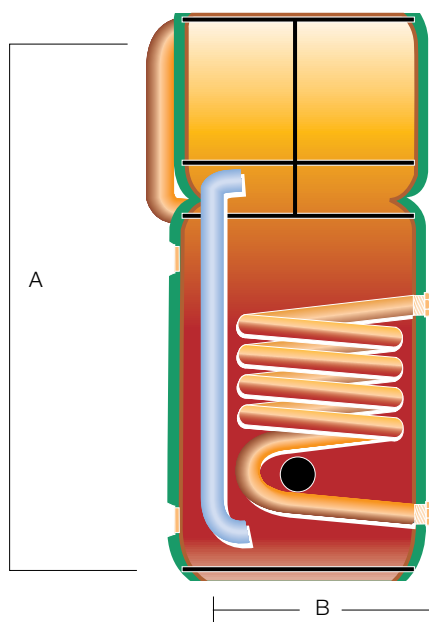

ext.ht (A) mm	ext.dia (B) mm	capacity litres	
		hot	cold*
1125	450	85	20
1319	450	115	20
1480	450	140	20
1383	450	85	40
1577	450	115	40
1738	450	140	40
1349	400	85	20
1595	400	115	20
1800	400	140	20
1677	400	85	40

\*Refers to each cistern

# Aquapak

## Pre-plumbed package units

Aquapak combines a Grade 3 copper cylinder with a black polythene cold feed tank and is a complete steel-framed unit with inter-connecting pipework. These units offer a practical and efficient solution where space and easy installation are important factors. Available as Direct and Indirect, the direct comes complete with bosses for side entry immersion heaters. Choice of either 182 ltrs or 227 ltrs cold storage tanks.

### Features and benefits

- Extra tappings and immersion heater bosses can be fitted dependent on individual requirements.
- Indirect unit is for use in conjunction with a central heating system.
- Optional High Recovery coil types available.
- Immersion heater fitted on indirects for potential electrical back-up.
- Suitable for properties without loft space, ie flats, bungalows and bedsits.
- Direct Maxistore version can be used in conjunction with 'low tariff' electricity.
- Reduces installation costs.
- Available with optional compression fittings or Albitec Adaptors.
- Indirect units have an integral feed & expansion tank within the cold tank for the central heating side.

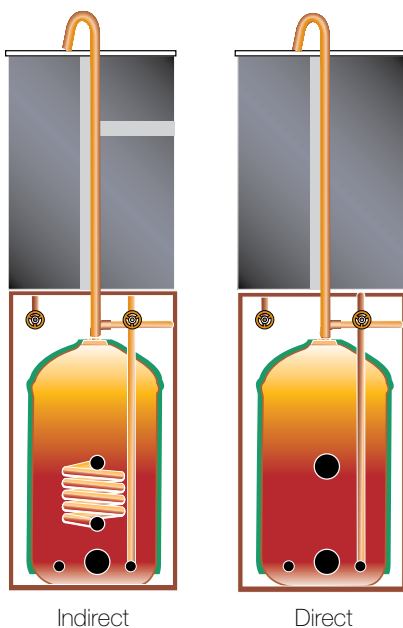

cylinder size h x d	overall height mm	overall width mm	overall depth mm	hot water capacity litres	
				indirect	direct
900 x 450	1918	585	585	117	120
1050 x 450	2103	585	585	140	144
975 x 500	2233	585	585	162	166
1070 x 525	2348	585	585	206	210

**NB:** Cold water capacity - Direct 227 ltrs  
- Indirect 182 ltrs

# Centurion

## Eco cylinders & combinations

For gravity or pumped primary systems

### Features and benefits

Albion's Centurion Eco cylinder is approved for use with solar systems by BRE Clear Skies. Installation of Albion Centurion cylinders can now be grant assisted.

30% of the volume is dedicated solar capacity, and 70% of the volume can be heated in the normal way via a primary coil on days when solar input is not sufficient to heat the full contents of the unit or on days when additional energy is required.

Two control thermostats are used to maximise solar gain. The upper one is a strap on type used for boiler control (not supplied). The lower one is a probe type (F) for solar control (not supplied). The upper 1/2" female boss (G) is for a temperature gauge (not supplied).

The range shows ten popular sizes and capacities. When calculating the size required, please ensure that the upper coil volume is used for total requirement. If the application is for a twin bath, for example, at least 140 litre of 'upper coil' volume is required so that this demand can be catered for on the darkest of winter days.

The Centurion range shown here has a British Standard Part L compliant upper coil fitted - see page 20 for the Superduty HE version for even higher performance and efficiency.

For electric homes, Direct units with twin immersions are also available.

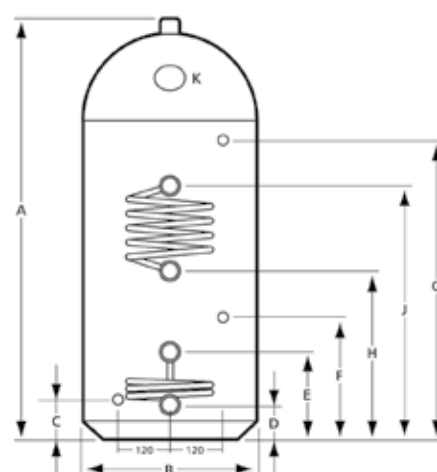
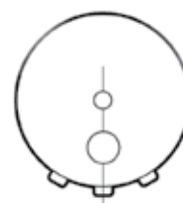

50mm foam insulation

### DIMENSIONS (mm)

	Height	1200	1500	1050	1200	1350	1500	1800	1200	1350	1500
A	Height	1200	1500	1050	1200	1350	1500	1800	1200	1350	1500
B	Diameter	400	400	450	450	450	450	450	500	500	500

— SUPPLIED WITH SECONDARY RETURN —

### CONNECTIONS (mm)

	DHW (22mm Compression)*	Dome	Dome	Dome	Dome	Dome	Dome	Dome	Dome	Dome	Dome
C	Cold Feed (22mm Compression)*	100	100	100	100	100	100	100	100	100	100
D	Eco Element (22mm Compression)	100	100	100	100	100	100	100	100	100	100
E	Eco Element (22mm Compression)	180	180	180	180	180	180	180	180	180	180
F	Thermostat (1/2" BSP)	200	200	200	200	200	200	200	200	200	200
G	Temp gauge point (1/2" BSP)	1010	1310	840	990	1150	1300	1500	995	1150	1300
H	Primary Coil (1" male c/w Albitec)	410	455	335	400	400	465	530	360	410	435
J	Primary Coil (1" male c/w Albitec)	780	825	635	700	770	835	1050	730	930	955
K	Immersion Heater Boss	Dome	Dome	Dome	Dome	Dome	Dome	Dome	Dome	Dome	Dome

\*28mm on 1800 x 450 and above

### CAPACITIES (Litres)

	Upper Coil	90	120	95	105	125	145	170	140	160	175
	Eco Element	45	50	45	55	55	65	75	60	70	75
	Total	135	170	140	160	180	210	245	200	230	250



# Superduty HE

## Eco cylinders and combinations

For pumped systems only

### Features and benefits

The Superduty HE Eco cylinder has been designed to make the very best use of energy input, both solar and fossil fuel top up.

Local Authorities, Housing Associations and other energy conscious specifiers understand the importance of high efficiency heat exchangers and will probably be aware of the Albion Superduty HE unit.

Although the principle of operation is the same as the Centurion cylinder, further energy savings are achievable by coupling the traditional boiler input to the Superduty multicoil heat exchanger. Higher efficiencies reduce boiler cycling and result in faster heat up. With lower boiler return temperatures the unit is most suited to operate with condensing boilers.

Superduty HE cylinders come with a 5-year guarantee.

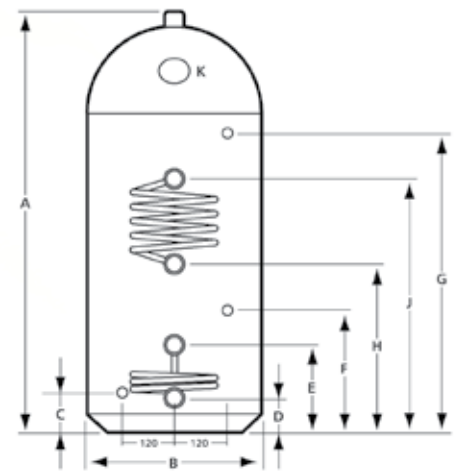
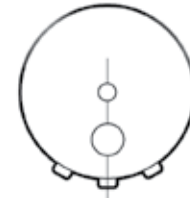

50mm foam insulation

### DIMENSIONS (mm)

		1200	1500	1050	1200	1350	1500	1800	1200	1350	1500
A	<b>Height</b>										
B	<b>Diameter</b>	400	400	450	450	450	450	450	500	500	500

└─ SUPPLIED WITH SECONDARY RETURN ─┘

### CONNECTIONS (mm)

		Dome	Dome	Dome	Dome	Dome	Dome	Dome	Dome	Dome	Dome
	<b>DHW0 (22mm Compression)*</b>										
C	<b>Cold Feed (22mm Compression)*</b>	100	100	100	100	100	100	100	100	100	100
D	<b>Eco Element (22mm Compression)</b>	100	100	100	100	100	100	100	100	100	100
E	<b>Eco Element (22mm Compression)</b>	180	180	180	180	180	180	180	180	180	180
F	<b>Thermostat (½" BSP)</b>	200	200	200	200	200	200	200	200	200	200
G	<b>Temp gauge point (½" BSP)</b>	1010	1310	840	990	1150	1300	1500	995	1150	1300
H	<b>Primary Coil (1" male c/w Albitec)</b>	410	455	335	400	400	465	530	360	410	435
J	<b>Primary Coil (1" male c/w Albitec)</b>	780	825	635	700	770	835	1050	730	930	955
K	<b>Immersion Heater Boss</b>	Dome	Dome	Dome	Dome	Dome	Dome	Dome	Dome	Dome	Dome

\*28mm on 1800 x 450 and above

### CAPACITIES (Litres)

		90	120	95	105	125	145	170	140	160	175
	<b>Upper Coil</b>										
	<b>Eco Element</b>	45	50	45	55	55	65	75	60	70	75
	<b>Total</b>	135	170	140	160	180	210	245	200	230	250

# Horizontal Cylinders

Suitable for loft or attic siting or where space in a property is limited. Can be used if existing cylinder cupboard is converted into a shower cubicle.

## Features and benefits

- Available as Direct or Indirect models.
- Single or twin coil options.
- Cradles available for rigid siting.
- Available plain or foam lagged.
- Grades 1, 2 & 3.
- Suitable for pumped systems only.
- Available with optional compression fittings or Albitec Adaptors.
- Extra tapings and immersion heater bosses can be fitted dependent on individual requirements.

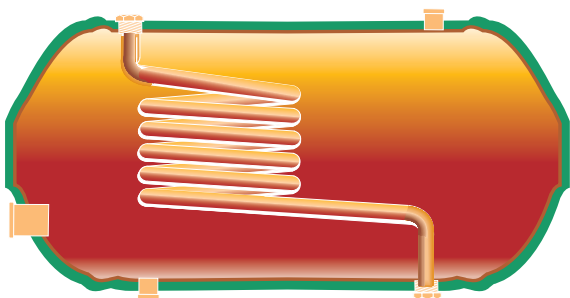

Indirect single coil

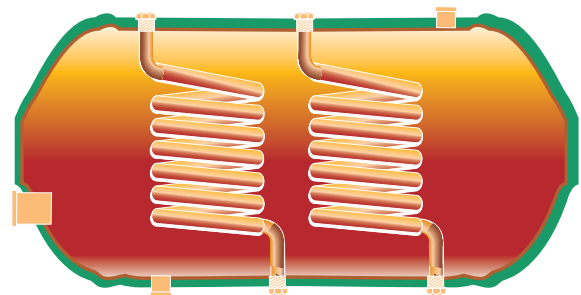

Indirect twin coil

# Big Bath Booster

## Do you need more hot water?

If you've recently added a new en-suite facility or a larger bath to your home you'll need to think about your hot water needs. You may not need to change your existing cylinder. Fit the Albion Big Bath Booster and increase your stored hot water capacity by a full 30 litres.

## Easy to install

The Albion Big Bath Booster mounts directly above your hot water cylinder and connects, with only minor adjustment, into existing pipework. For ease of installation all connections are compression pattern. A bespoke shower connection is included. Full drain-down isn't necessary, making installation even quicker!

## How does it work?

When the cylinder is heated, the specially designed link pipe connecting the Big Bath Booster to the hot water cylinder allows hot water to rise into the Big Bath Booster. Cooler water is forced down into the cylinder. This thermo-syphonic circulation continues until the temperature of the water in the Big Bath Booster is equalised with that in the cylinder. This results in an extra 30 litres of hot water for household use. The Big Bath Booster is foam insulated to keep the water hot for longer.

## Where can I use it?

The Big Bath Booster can be fitted to most conventional open vented cylinders either direct or indirect up to 10 metres working head. Because of the additional capacity the heat up times are a little longer. The Big Bath Booster is compatible with cylinders having a hot draw off boss of at least 1" male or female in size. The Big Bath Booster is not suitable for use with combination tanks, unvented or pressurised hot water systems.

## Is it approved?

The Big Bath Booster is WRAS approved.



the easy way to increase your hot water capacity!

# Slimline Electric Flat back water heaters

## Features and benefits

Albion Slimline are a family of electrically heated rectangular combination tanks, suited to areas where small quantities of hot water are needed for hand washing or dish washing etc., on a regular basis. These open vented systems are particularly suitable for rest rooms, garages, hairdressers, canteens, annexes and extensions, or any number of businesses where an economical easy to install system is required. Slimlines are attractively finished in white mild steel casing, are available in four popular sizes and suitable for wall mounted installations only.

**Finish :** White Steel Casing

**Insulation :** Urethane semi rigid slabs.

**Cold / Hot compartments :**

Copper to BS EN 1653 Tube to BS EN 1057 Zinc free brazing alloy.

**Tappings :**

Hot draw off	22mm compression
Drain	1/2" female boss
Immersion heater	2 1/4" boss

**Standards :**

Manufactured to BS 3198

WRAS listed

Note: Supplied with an immersion heater on request.



Nominal Capacity

Litres Hot	Litres Cold	Height (mm)	Width (mm)	Depth (mm)
25	8	725	470	210
50	25	770	600	320
75	25	940	600	320
100	25	1100	600	320

# ROI

## Combination tanks

### The Advantages

- Direct and Indirect models
- High capacity storage of cold water
- Overcome low flow mains
- Compatible with pumps
- 4 popular sizes
- Connections on front face
- Utilise off peak tariffs (Direct)
- Link to gas/oil boilers (Indirect)

### Application

Direct units are specifically designed for those homes where a gas or oil supply is not available. The lower immersion heater will heat the whole tank usually from an off peak tariff. A third of the total volume may be heated by the upper heater if demand requires. Extra thick insulation retains the heat efficiently.

Indirect models have a coil to integrate with a boiler and wet radiator system. An immersion heater is provided as backup should the boiler not be available. The isolation valve on the cold feed pipe eliminates the need to drain the cold tank when changing an immersion heater.

ROI Combination Tanks in either format include two cold and two hot draw off connections to enable a pump to be installed providing high performance hot and cold services throughout the home. A twin impeller negative head pump with dry run protection is recommended. Flexible couplings between the cylinder and pump are necessary.

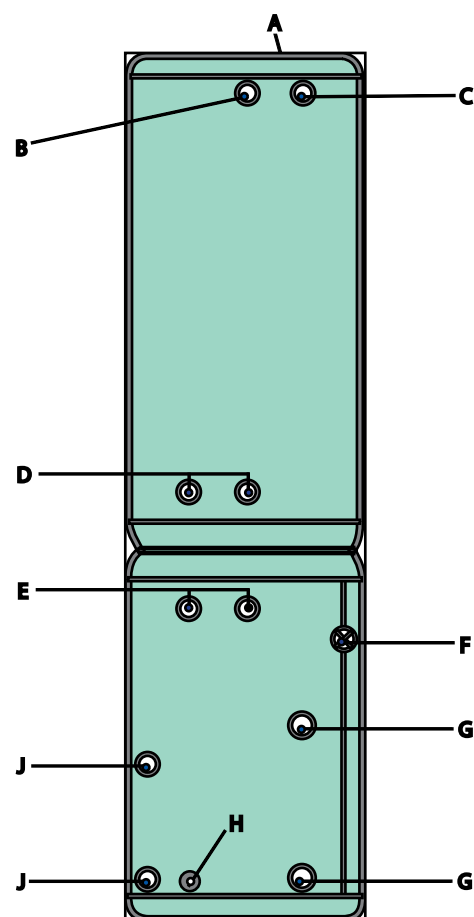

- A. Close fitting Lid
- B. 1/2" ball valve & float
- C. 3/4" overflow
- D. 2 x 3/4" cold draw off
- E. 2 x 3/4" hot draw off
- F. 22mm isolation valve
- G. 2 1/4" immersion
- H. 1/2" type A drain cock
- I. 1" primary coil - indirect only

Direct units have 2x3kW immersion heaters complete with safety cut-outs. Indirects have 1x3kW immersion heater. 450 and 500mm diameter indirects have a facility for a second immersion heater.

<b>Height (mm)</b>	2125	2125	2125	2125
<b>Diameter (mm)</b>	450	500	550	600
<b>Finished diameter including insulation (excluding pipework) - mm</b>				
<b>Direct</b>	530	580	600	680
<b>Indirect</b>	500	550	600	650
<b>Cold Capacity (ltrs)</b>	180	224	265	322
<b>Hot Capacity (ltrs)</b>	118	146	171	208
<b>Cold Capacity (galls - nominal)</b>	40	50	58	70
<b>Hot Capacity (galls- nominal)</b>	26	32	37	45

# Shower flange

## Features and benefits

Shower flange is particularly suited to cylinders where the use of an immersion heater is not recommended, e.g. Superduty or B.S. Indirect units. The flange converts a 2¼" heater boss into a 22mm compression fitting for a bespoke shower connection.

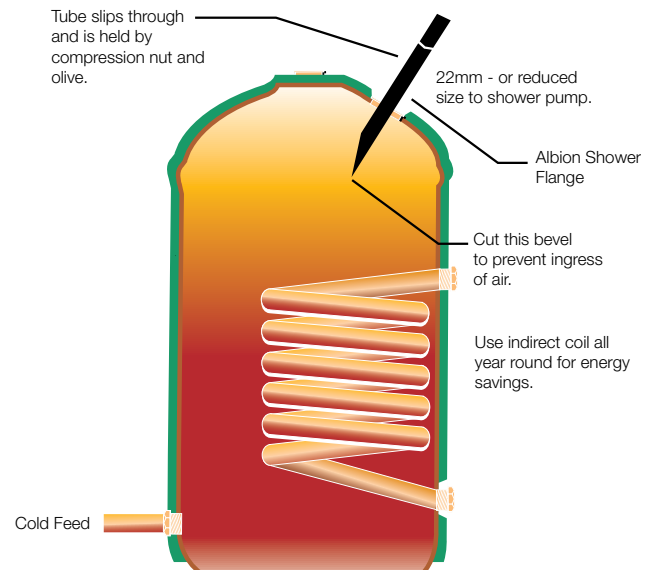

I.H.B. can also be used for pumped secondary return.

# Albitec

## 22mm cylinder compression convertor

## Features and benefits

All Kingspan Part L compliant cylinders with 1" male connections are compatible with Albion Albitec adaptors.

Albitec adaptors can be supplied as part of the cylinders or as individual fittings.

### 'QUICK & CLEVER'

Albitec adaptors convert standard 1" male BSP cylinder connections to accept 22mm copper tube.

This simple two piece adaptor replaces expensive bulky fittings which take longer to install.

The unique design of the push-fit adaptor sleeve and captivating nut results in a watertight seal every time, and means that only one joint is used in the connection, not two, as with conventional fittings.

Albitec adaptors are a must where space is at a premium and if used with street pattern elbows, the space required is reduced to an absolute minimum.

### Fits as easily as this!

1. Insert Albitec adaptor sleeve into cylinder connection.

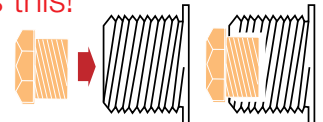

2. Offer up the 22mm copper tube with lock-nut in position.

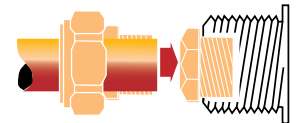

3. Push the copper tube firmly up to the stop-end of the adaptor sleeve and tighten the lock-nut onto the cylinder connection compressing the integral olive creating the watertight joint.

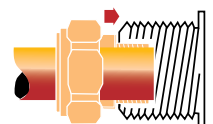

# Products List

Kingspan offer a complete range of renewable energy and related products for both domestic and commercial applications. Our complete solar package solutions include initial advice, professional design specifications and technical assistance through to a network of fully trained Kingspan Solar Accredited Installers who are kept up-to-date with the latest regulations and available grants.

## Our range of products consists of:

### Kingspan SOLAR

Kingspan Solar Ltd provides the commercial and domestic markets with an ultimate solar package, custom-designed to suit requirements of each individual application.

The Package incorporates high quality flat plate solar thermal panels or high performance Thermomax evacuated tube solar collectors. The system can incorporate the latest condensing boiler technology, underfloor heating or the traditional radiator system. It is then coupled to a high performance Albion Ultrasteel Duplex stainless steel solar cylinder. The package includes all components required to complete the installation.



The Ferham Cold Water Tanks range represents the most comprehensive and robust range of cisterns available anywhere in the United Kingdom. Designed and built to provide heating contractors with a premium product, Ferham Cold Water Tanks remain the most popular product range within the industry.

Available in a wide range of storage sizes from 18 litres (4 gallons) to 795 litres (175 gallons), the extensive Ferham range makes them the ideal solution for new builds or those involved in replacing, maintaining or improving facilities. Designed with built-in strengthening ribs that have a high impact threshold, the cisterns are virtually indestructible.

Dedicated to meeting the precise needs of customers, Ferham offers a range of accessories and fittings, available separately or as one combined Total Tank Kit.



Albion Ultrasteel unvented cylinders are manufactured from Duplex stainless steel, featuring superior corrosion resistance. They offer high flow rates for powerful showers and fast filling baths. As a result they provide mains pressure hot water around the home, which makes them suitable for use in buildings with multiple bathrooms. They offer fast reheat times and minimal heat loss from the stored water.

The range comprises Direct and Indirect models in a variety of sizes, as well as solar units to use with renewable energy sources.



# Kingspan Climate<sup>❄️</sup>

This silent solar powered cooling/heating system is perfect for hotter Mediterranean-style climates. The Kingspan Climate package includes the ClimateWell, premium quality Thermomax vacuum tube collectors, controllers and a Kingspan cylinder.

Compact and incredibly cheap to run, the Kingspan Climate can also provide heating for domestic hot water and swimming pools.



# Kingspan AEROMAX

Aeromax heat pumps use natural heat from the air outside to provide central heating (underfloor heating or traditional radiators) and/or hot water for your home. Highly efficient, the units are compact and easy to install. Incredibly quiet, they require virtually no maintenance. Offered with complete package solutions and can be coupled with the highly efficient Albion Ultrasteel renewable energy cylinder to maximise efficiency benefits.



# Albion Manchester Calorifiers

Exceeding the Standard

Albion Water Heaters and Manchester Calorifiers design and manufacture a large range of open vented and unvented calorifiers for commercial and industrial use in copper, stainless steel and mild steel. They also offer marine calorifiers and hot water provision for light commercial vehicles. All products feature high quality, durability and exceptional performance.

For maximum efficiency, units can be custom-designed for each specific application. A renewable heat source, e.g. solar panels, can also be incorporated into the system and sized to meet the heating and hot water requirements of the property.



# Albion Water Heaters - a market leader in the manufacture and supply of quality hot water systems.

Albion Water Heaters, part of Kingspan Group, is a major manufacturer of Domestic Hot Water storage systems in the UK and offers products backed by the service and technical development skills that only a company of its size can.

All sites are licensed to British Standards quality assurance BS EN ISO 9001:2000 and Albion is a BSI registered firm. This means that all manufacturing plants are monitored by an independent inspectorate and the quality systems employed by Albion meet the stringent requirements set down. Specifiers, stockists and users can depend on Albion for consistent quality and supply.

Albion continues to develop energy saving and innovative hot water products for domestic and commercial applications.



WRAS  
PRODUCT

hwa

CE



## Guarantee

Albion copper cylinders carry a 2-year (unless stated otherwise) guarantee against faulty materials or manufacture provided that:

- They have been correctly installed in line with all the relevant standards, regulations and codes of practice in force at that time.
- They have not been modified in any way, other than by Albion.
- They have not been misused, tampered with or subjected to neglect.
- The system is fed from the public mains water supply.
- They have only been used for the storage of potable water.
- They have not been subjected to frost damage.
- The benchmark sticker on the cylinder has been signed and dated by the installer.
- The guarantee period starts from the date of purchase and no registration is required.
- All the components fitted to/or supplied with the Albion cylinder carry a 2-year guarantee.

## Exclusions

The guarantee does not cover:

- The effects of scale build up.
- Any labour charges associated with replacing the unit or its parts.
- Any consequential losses caused by the failure or malfunction of the unit.

Kingspan Hot Water Systems Ltd have a policy of continuous product development and may introduce product modifications from time to time. As a consequence details given in this brochure are subject to alteration without notice.



Hot Water Systems

**Albion Water Heaters**

Station Road, Caythorpe, Nr. Grantham, Lincolnshire NG32 3EW

T: 01400 272726 F: 01400 273508

Technical Helpline: T: 0845 2607260 F: 0845 2607261

[www.albionwaterheaters.com](http://www.albionwaterheaters.com)

[www.kingspanhws.com](http://www.kingspanhws.com)