

Xclusive 24
G.C. 47-291-13

Xclusive 30
G.C. 47-291-14

Xclusive 36
G.C. 47-291-15



INSTALLATION MANUAL

High Efficiency Wall-Mounted Gas Boiler

Read this installation manual thoroughly before the installation and use of the boiler. Follow all indicated instructions. This installation manual must remain with the boiler.



Benchmark places responsibilities on both manufacturers and installers. The purpose is to ensure that customers are provided with the correct equipment for their needs, that it is installed, commissioned and serviced in accordance with the manufacturer's instructions by competent persons and that it meets the requirements of the appropriate Building Regulations. The Benchmark Checklist can be used to demonstrate compliance with Building Regulations and should be provided to the customer for future reference. Please read the Benchmark Checklist carefully, page , and complete all sections, as required by law, relevant to the appliance and installation. Failure to install and commission according to the manufacturer's instructions and complete the Benchmark Commissioning Checklist will invalidate the warranty for the Gas Boiler installation. The details within the Checklist will be required in the event of any warranty work. On completion the Checklist must be left with the end user. The relevant sections of the Service Record, page 76 , must be completed on each annual Service visit.

Installers are required to carry out installation, commissioning and servicing work in accordance with the Benchmark Code of Practice which is available from the Heating and Hotwater Industry Council who manage and promote the scheme. Visit www.centralheating.co.uk for more information.

CONTENTS

1	Preface	5
1.1	Regulation	5
1.2	Warnings	5
1.3	Manual handling	5
1.4	Pictograms	6
1.5	Warnings on the box	6
1.6	Abbreviations	6
2	Safety regulations	7
2.1	General	7
2.2	The installation	7
3	General boiler information	8
3.1	General	8
3.1.1	ErP label	8
3.1.2	Gas category	8
3.2	Operation	9
3.3	Data plate	9
3.4	Control panel	10
3.5	Operational modes	10
4	Main components	11
4.1	Standard scope of delivery	12
4.2	Accessories	13
4	Installer important points	14
5	Installation	15
5.1	Overall dimensions of boiler + assembly bracket	15
5.1.1	Installing the wall bracket and assembly bracket	15
5.2	Installation location	16
5.2.1	Installation in a kitchen cabinet	16
5.2.2	Removing/installing the front panel	17
5.3	Installing the boiler	18
6	Connection	19
6.1	Connecting the central heating system	19
6.1.1	Expansion vessel	19
6.1.2	Thermostatic radiator valves	19
6.1.3	Floor heating	19
6.1.4	LT/HT zone system	20
6.1.5	Division of central heating system in groups with extra heat source	21

6.2	Connection of domestic hot water	22
6.2.1	DHW circuit resistance graph	22
6.2.2	Boiler with heat pump boiler	23
6.2.3	Boiler with Pre-Heated Solar Boiler)	24
6.3	Electrical connection	25
6.4	Gas connection	25
6.5	Connecting room thermostat	26
6.5.1	Connecting Modulating OpenTherm thermostat	26
6.5.2	Connecting on/off room thermostat	26
6.5.3	Connecting 230V room thermostat	26
6.5.4	Connecting outdoor sensor	27
6.5.5	Frost protection	27
6.5.6	Connecting boiler sensor/thermostat	28
6.5.7	PC interface	28
6.5.8	Comfort Touch	28
6.6	Flue and air supply duct	29
6.6.1	Draft, materials and insulation	29
6.7	Pipeline lengths	30
6.7.1	Replacement lengths	30
6.7.2	Example calculation	30
6.8	General layout of the flue	31
6.8.1	Wall terminal with twin-pipe horizontal terminal C13	32
6.8.2	Façade combi-pipe horizontal terminal C13	33
6.8.3	Roof terminal with combi-pipe vertical terminal and twin-pipe vertical terminal C33	34
6.8.4	Roof terminal and air supply duct from the façade C53	35
6.8.5	Clamping the flue system (parallel and concentric)	36
7	Operation	38
7.1	Using the control panel	38
7.2	Preparation activities	38
7.2.1	Filling and venting central heating system	38
7.2.2	Domestic hot tap water facility	39
7.2.3	Gas supply	39
7.3	Commissioning procedure	40
7.4	Clock function	41
7.5	Shutting down the boiler	42
8	Settings and adjustments	43
8.1	Structure of the settings	43
8.1.1	Main menu	43
8.1.2	Domestic hot water menu	44
8.1.3	Central heating menu	45
8.1.4	RF menu	45
8.1.5	Service menu	47
8.2	Setting and adjusting the clock functions	49
8.2.1	Setting the clock program on CH operation	49
8.2.2	Setting the clock program on DHW operation	50
8.3	Parameters	52
8.4	Switching DHW comfort function on and off	53
8.5	Adjusting maximum central heating output	53
8.6	Adjusting pump capacity	53
8.7	Weather-dependent control	54
8.8	Conversion to another gas type	55
8.9	Gas/air control	56
8.10	Inspection of gas air control	57
8.10.1	Measuring flue gas at maximum output	57
8.10.2	Measuring flue gas at minimum output	59
8.10.3	Minimum output correction	61
9	Faults	63
9.1	Fault codes	63
9.2	Other faults	65
9.2.1	No heat (central heating)	65
9.2.2	Central heating does not reach the correct temperature	65
9.2.3	Central heating system remains too warm	65
9.2.4	No domestic hot water (DHW)	66
9.2.5	Domestic hot tap water does not reach the correct temperature	66
9.2.6	Burner ignites loudly	66
9.2.7	Burner resonates	67

10	Maintenance	68
10.1	Disassembly	68
10.2	Cleaning.....	68
10.3	Installation	69
10.4	Checklist	70
11	Technical specifications	71
11.1	Electrical schematic	72
11.2	Product card according to CELEX-32013R0811, Appendix IV	74
11.3	NTC resistances	74
12	Guarantee provisions and CE declaration	75
13	Gas boiler system commissioning checklist	76
	To be completed at each annual service, not subsequent.	
14	Service record	77
	To be completed at each annual service, not subsequent.	

1 PREFACE

The manufacturer Intergas Heating Ltd accepts no liability whatsoever for damage or injury caused by failure to adhere (strictly) to the safety regulations and instructions, or carelessness during installation of the Intergas Boiler wall mounted gas fired boiler and any associated accessories

Intergas Heating Ltd continuously developing ways to guarantee the quality of its products and to improve them where necessary. In so doing it reserves the right to modify at any time the features named in this document.

Read and observe all safety instructions in this instruction manual to prevent unsafe situations, fire, explosion, damage to property or personal injury.

1.1 Regulation

The Intergas combination boiler meets the requirements of Statutory Instrument 'The Boiler (Efficiency) Regulations' and is deemed to meet the requirements of:

- ▶ Low Voltage Directive (2014/35/EC)
- ▶ Gas Appliances Regulation (2016/426/EC)
- ▶ Boiler Efficiency Directive for new oil- and gas-fired central heating boilers (92/42/EC)
- ▶ EMC Directive (2014/30/EC)
- ▶ RED Directive (2014/53/EU)
- ▶ Ecodesign (2009/125/EG)
- ▶ Energy labelling 2010/30/EU

Intergas declares that the materials used in the manufacturing of this appliance are nonhazardous and that no substances harmful to health are contained within the appliance.

1.2 Warnings

Intergas accepts no responsibility for the unsatisfactory performance of the appliance or flue arising from the failure to comply with the installation and user instructions. Incorrect installation could invalidate your warranty and may lead to prosecution.

The appliance cannot be removed from the original place of installation and transferred to another site or re-sold without prior consent from Intergas to re-register the appliance with Intergas in order to maintain the warranty.

The boiler must be installed in accordance with these instructions and the regulations currently in force. Read these instructions carefully before installing or using the appliance. It is the installers responsibility that the installation conforms to the current legislation and Standard Codes of Practice.

1.3 Manual handling

When moving the boiler always keep your back straight, bend your knees, don't twist, move your feet. Avoid bending forwards or sideways and keep the load as close to your body as possible. Where possible transport the boiler using a suitable trolley, sack truck or get some assistance. Grip the boiler firmly and before lifting establish where the weight is concentrated to determine the centre of gravity, repositioning yourself if necessary.

1.4 Pictograms

The following pictograms are used in this installation manual:



CAREFUL / IMPORTANT

Procedures which, if these are not performed with the required caution, can damage the product, the surrounding or the environment or may result in personal injury.



COMMENT

Procedures and/or instructions which, if they are not followed, can negatively affect the operation of the boiler.



SEE

Reference to other manuals

1.5 Warnings on the box



INSTRUCTION (THIS SIDE UP)

Store the appliance upright as indicated on the box.



INSTRUCTION (FRAGILE)

This is a fragile piece of equipment: Please be very careful not to drop.



INSTRUCTION (FRAGILE)

This is a fragile piece of equipment: Please provide a dry storage for the appliance.



INSTRUCTIE (STACK)

No more than three boxes should be stacked on top of each other.

1.6 Abbreviations

- ▶ **DHW:** Domestic hot water
- ▶ **CH:** Central heating
- ▶ **CW:** Comfort domestic hot water
- ▶ **HE:** High efficiency
- ▶ **PHS:** Pre Heated Solar water.
- ▶ **LT:** Low temperature (zone).
- ▶ **HT:** High temperature (zone)
- ▶ **OT:** OpenTherm
- ▶ **RF:** Radio frequency
- ▶ **PC:** Personal computer
- ▶ **NTC:** Sensor (Negative temperature coefficient)
- ▶ **PP:** Polypropylene
- ▶ **CAC:** Combination air supply duct and combustible gas flue system (chimney system)

2 SAFETY REGULATIONS

Safety precautions If you smell gas



A gas leak could potentially cause an explosion. If you smell gas, observe the following rules:

- ▶ **Prevent flames or sparks:**
 - **Do not smoke, use a lighter or strike matches.**
 - **Do not operate any electrical switches or unplug any equipment.**
 - **Do not use the telephone or ring doorbells.**
- ▶ **Turn off the gas at the meter or regulator.**
- ▶ **Open windows and doors.**
- ▶ **Warn your neighbors and leave the building**
- ▶ **Prevent anyone from entering the building.**
- ▶ **Call the National Gas Emergency Service on 0800 111 999.**
L.P.G. boilers: Call the supplier's number on the side of the gas tank



2.1 General

It is law that all gas appliances are installed and serviced by a Gas Safe registered competent engineer if in any doubt please check with Gas Safe **(0800 408 5500)** and in accordance with the following recommendations:

- ▶ Current Gas Safety (Installation and Use) Regulations
- ▶ All current building regulations
- ▶ Building Standards (Scotland) Consolidated
- ▶ This appliance must be installed in accordance with the Gas (Safety and Use) Regulations, current Building Regulations, Building Standards (Scotland), I.S.813 Installation of Gas Appliances (Ireland), IEE Wiring Regulations (BS 7671), Health and Safety Document No. 635 (Electricity at Work Regulations) and Local Water Authority Bye Laws
- ▶ UK Water Regulations and Bye Laws
- ▶ Health & Safety

2.2 The installation

The installation must comply with the following British Standards codes of practice:

- ▶ BS 5440: Flues and Ventilation for gas appliances of rated input not exceeding 70kW (Part 1 Flues)
- ▶ BS 5440: Flues and Ventilation for gas appliances of rated input not exceeding 70kW (Part 2 Air Supply)
- ▶ BS 5546: 2000 Installation of gas hot water supplies for domestic purposes.
- ▶ BS 5549: 1990 Forced circulation hot water systems
- ▶ BS 6700: 1997 Design, Installation, testing and maintenance of services supplying hot water
- ▶ BS 6798: 2000 Specification for installation of gas fired hot water boilers of rated input not exceeding 70kW
- ▶ BS 6891: 1998 Installation of low pressure gas pipe-work installations up to 35mm (RI)
- ▶ BS 7593: 1992 Code of practice for treatment of water in heating systems
- ▶ BS 7671: 2001 Requirements for electrical installations, IEE Wiring regulations

Reference should also be made to:

- ▶ Guide to condensing boiler installation assessment procedures for dwellings
- ▶ The institute of Gas Engineers document IGE/UP/7 for timber frame dwellings

3 GENERAL BOILER INFORMATION

3.1 General

The Intergas Xclusive wall-mounted gas boiler is a closed unit. The boiler is intended solely to provide heat for the water in a central heating system and domestic hot water installation for household use.

The Intergas Xclusive meets the European directives and additional national regulations that are indicated by CE marking. The associated conformity declaration can be requested from Intergas Heating Ltd (also see §12)



The Intergas Xclusive meets the electrical protection class IPX4D.

The boiler can be connected to stainless steel or plastic (PP T120) combination throughputs that have a CE label.

3.1.1 ErP label

Based on the European ErP Directive (Energy related Products) all newly produced gas fired boilers have to meet minimum standards regarding energy performance.

The Intergas Xclusive carries an European energy label containing specific information regarding energy efficiency class (CH and DHW), noise level en maximum power.

The Intergas Xclusive carries label A for both CH and DHW.

In addition the Intergas Xclusive meets the following DHW capacity profile:

- ▶ Xclusive 24 : L
- ▶ Xclusive 30 : XL
- ▶ Xclusive 36 : XL

The extensive product fiche can be found in §11.2.

3.1.2 Gas category

Gas category	Gas type	Gas inlet pressure (mbar)
II _{2H3P}	Natural gas (G20)	20
	LPG (G31)	37

The Intergas Xclusive is factory-set for H-gas, G20. The boiler may optionally be converted to another gas type using a conversion set (see §8.8).

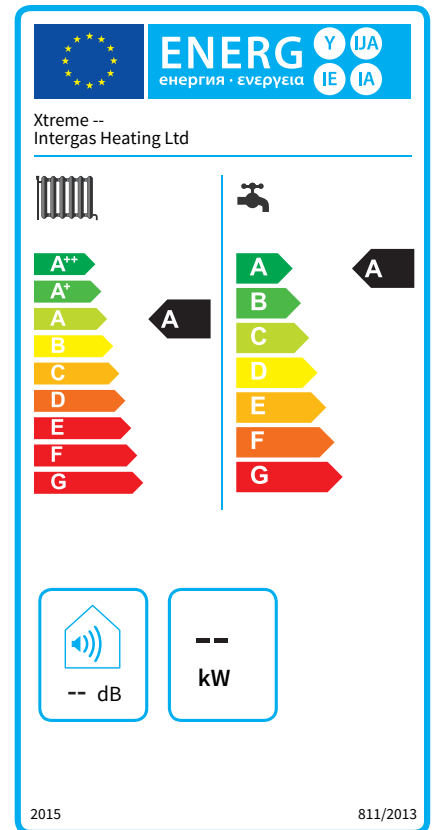

3.2 Operation

The Intergas Xclusive is a modulating high efficiency boiler. This means that the capacity is adjusted according to the desired heating capacity. Two separate copper circuits are integrated in the aluminium heat exchanger.

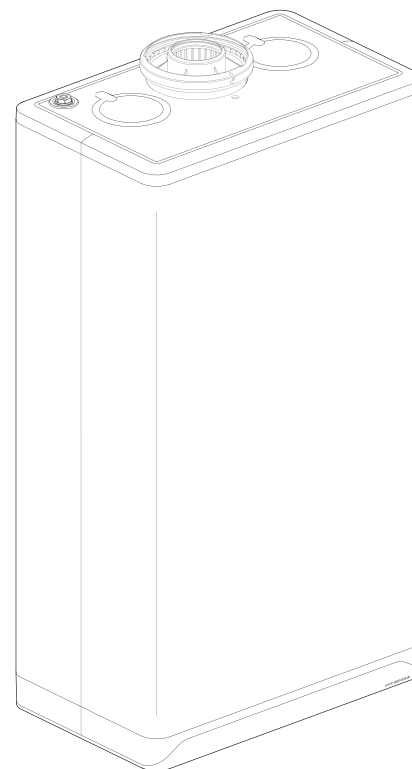

The boiler has a burner controller which, with each heat demand of the heater or the domestic hot water facility, controls the pump (only during heat demand of the heater) and the fan, opens the gas valve, ignites the burner and continuously monitors and regulates the flame, depending on the requested capacity.



3.3 Data plate

Identification of the product

You will find the unit details on the data plate on the bottom of the unit. The data plate contains, beside the supplier information and the boiler specification (boiler type and model name), the following information:

*****-yymm*****	Production code-Serial no. YY = year of production, mm = month of production
PIN	Product Information Number
	Data related to Domestic Hot Water
	Data related to Central Heating
	Information regarding electrical power supply (Voltage, mains frequency, elmax, IP-class)
PMS	Permissible overpressure in CH circuit in bar
PWS	Permissible overpressure in DHW circuit in bar
Qn HS	Input related to gross caloric value in kilowatts
Qn Hi	Input related to net caloric value in kilowatts
Pn	Output in kilowatts
BE, CH, DE, ES, FR, GB, IE, IT, MT	Countries of Destination (EN 437)
I2E(s), I2H, IIELL3P, I2H3P, I2Esi3P	Approved unit categories (EN 437)
G20-20 mbar G25-25 mbar	Gas group and gas connection pressure as set at the factory (EN 437)
B23,C93(x)	Approved flue gas category (EN 15502)
Tmax	Maximum flow temperature in °C
IPX4D	Electrical protection class

3.4 Control panel

The boiler has a fully integrated touch screen control panel that displays information about the operational mode of the boiler. Symbols (buttons), numbers, points and/or letters are displayed.

The buttons light up so that they can be operated.
For extensive control options, see **S8**.

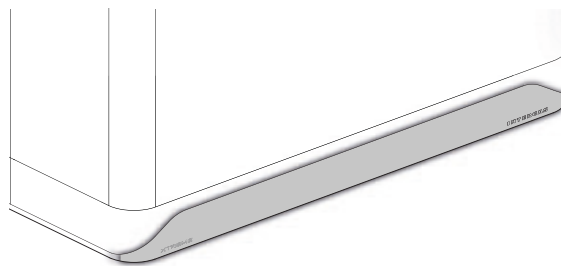

COMMENT

- ▶ **Only use your fingers to operate the touch screen**

3.5 Operational modes

The boiler has a number of operational modes:

The boiler is switched off.

The boiler is out of order but is connected to the mains voltage. In this mode, the display view is characterized by:

- ▶ Showing the **power LED** [•].
- ▶ Showing the **pressure** in the central heating system (in bar) on the left display [**1.0**].
- ▶ Showing a line **on the right display** [-].

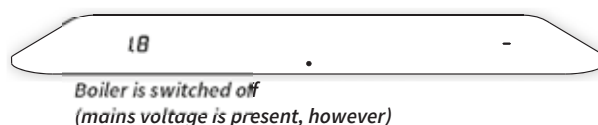

The boiler is switched on and is ready for a heat demand.

The boiler is switched on and is ready to answer a request for either domestic hot water or hot central heating water. In this mode, the display view is characterized by:

- ▶ Showing the power LED [•]. All other symbols and values are not displayed.

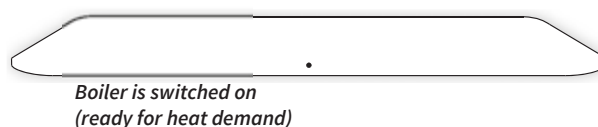

The boiler is in operation and is supplying domestic hot water.

The boiler is in operation and is supplying domestic hot water to one of the tap points. The display view is characterized by:

- ▶ Showing the power LED [•].
- ▶ Showing the flame. The burner is switched on [⦿].
- ▶ Showing the tap symbol [⌒].



The boiler is in operation and is supplying central heating water.

The boiler is in operation and is supplying central heating water. The display view is characterized by:

- ▶ Showing the power LED [•].
- ▶ Showing the flame. The burner is switched on [⦿].
- ▶ Showing the radiator symbol [|||||].



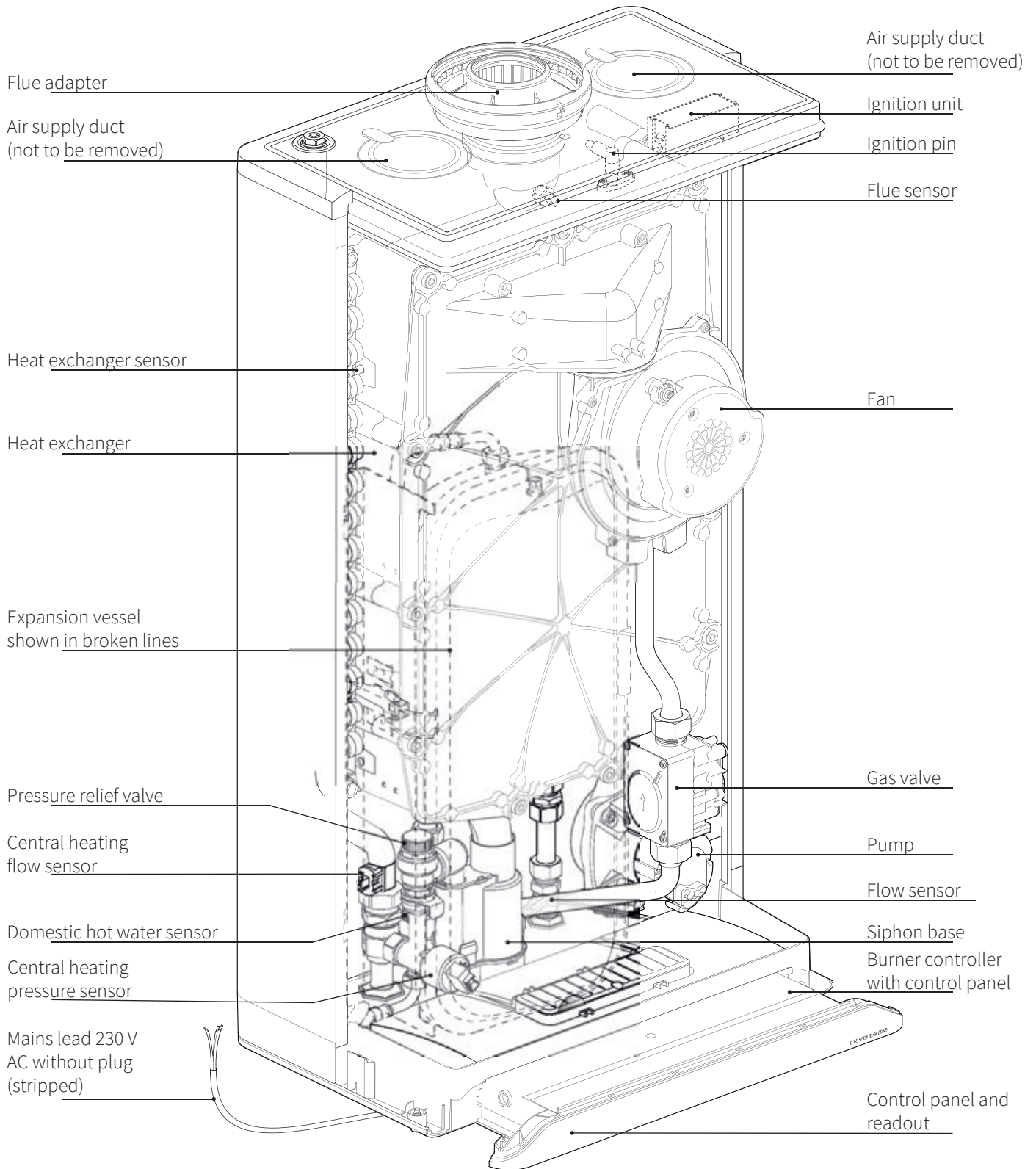

4 MAIN COMPONENTS



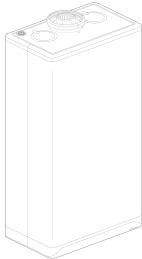
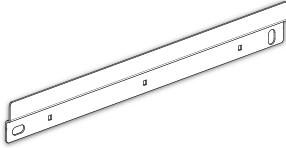
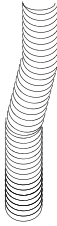

4.1 Standard scope of delivery

Check whether the package is undamaged. Unpack the boiler and check whether all components are present. Also check for any damages to the boiler or accessories and, if present, immediately notify the supplier.

		
Boiler	Wall bracket	Flexible condensate hose
		
Installation and operation instruction	Guarantee card	

4.2 Accessories

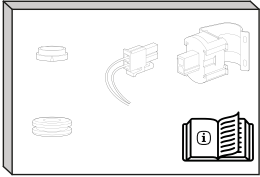
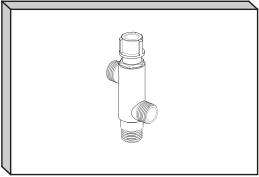
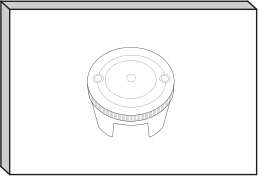
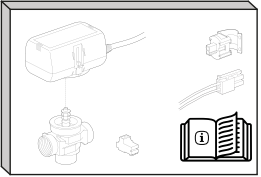
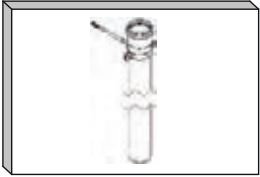
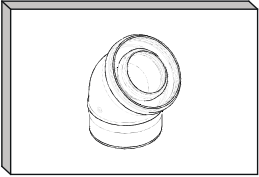
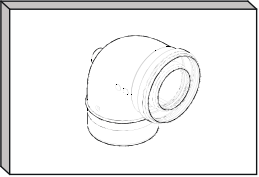
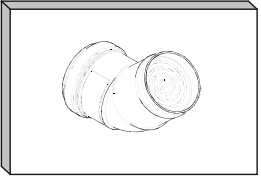
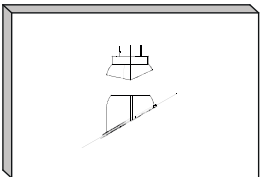
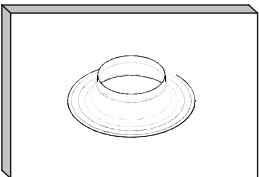
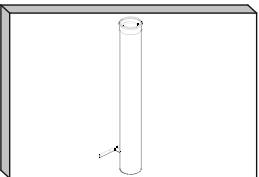
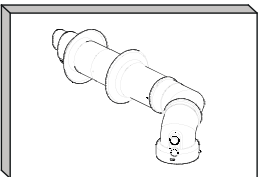
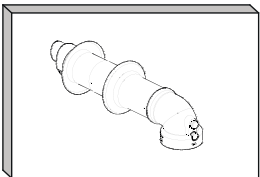
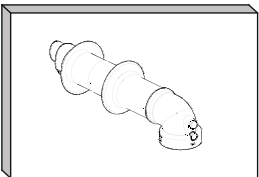
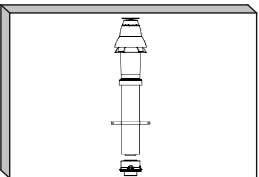
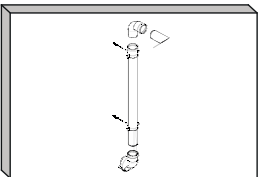
Original Intergas accessories can be ordered separately at the regular wholesaler. Instructions about the correct way to assemble and use these accessories are provided upon order and are therefore not included in this installation manual.

			
Item no 090347 Post-Heating Solar Boiler conversion set	Item no 842177 Thermostatic mixing valve	Item no 203207 Outdoor sensor	Item no 093707 LT/HT three-way valve set
			
Item no 081286 Extension L=100 incl. wall bracket (for plume management kit)	Item no 084661 Bend 45°	Item no 084660 Bend 90°	Item no 081295 Deflector kit
			
Item no 087910 Weather slate (steep roof)	Item no 087372 Weather slate (flat roof)	Item no 089975 Extension L=100 incl. wall bracket	Item no 081298 Horizontal telescopic offset wall terminal ¹
			
Item no 082980 Horizontal straight wall terminal extended ¹	Item no 081297 Horizontal telescopic wall terminal ¹	Item no 0821973 Vertical roof terminal (incl. boiler adapter 60/100)	Item no 081294 Plume management kit
			
Item no 081284 Elbow 90° (for plume management kit)	Item no 081285 Elbow 60° (for plume management kit)		

¹ Only to be used in combination with the base adapter on the boiler

4 INSTALLER IMPORTANT POINTS

Please read all instructions before fitting this appliance

- ▶ The installer shall instruct the user on the operation of the boiler, safety devices contained within the boiler and on the location of the filling loop and how to re-pressurise the system if the water pressure falls.
- ▶ The installer should hand over the installation and user instructions upon completion with the completed Benchmark Commissioning Checklist.
- ▶ The service engineer must complete the service record on the Benchmark Checklist after each service.
- ▶ It is required under Gas Safe Regulations for the installation to be notified to and registered with Gas Safe, Intergas and Building Control (Gas Safe Notification).
- ▶ Before proceeding to commission the boiler check the gas inlet pressure is 20mbar (NG) or 37mbar for Propane.
- ▶ Combustion analysis with a correctly calibrated and certificated analyser is essential for safe commissioning of the boiler.
- ▶ A pressure reducing valve set to 3.5 bar must be fitted if supply mains pressure is above 4 bar.
- ▶ In hard water areas where the PH is 200ppm or above, appropriate protection actions must be taken in accordance with BS 7593 in line with building regulations Part L.
See also Guarantee Provisions on page 75, point 4.
- ▶ The user should be instructed to keep the instructions in a safe place for servicing and future reference.
- ▶ It is important to keep the boiler clear of dust during the installation. In particular, do not allow debris to enter the flue connection at the top.
- ▶ Before fitting the boiler ensure that the pipe work that you are installing is connected to the appropriate connections on the boiler.
It is important to thoroughly flush the water circuits, after isolating the boiler, in order to remove any fluxes and debris from them. This should be done particularly where boilers are being fitted to existing radiator circuits (please refer to current Standard Codes of Practice).
- ▶ Intergas recommend water treatment in accordance with the Benchmark Guidance on Water Treatment in Central Heating Systems, we recommend the use of FERNOX, SENTINEL or ADEY inhibitors. It is most important that correct concentration of water treatment is maintained for the life of the boiler, a water sample is required on installation and to be verified by the aforementioned manufacturers should we attend a warranty call a water sample may be required to keep the warranty valid. (BS 7593:2006)
- ▶ This boiler has been factory set but adjustment may be required to the heating input in order to match the individual heating demand. This can be done by changing parameter **P010** (= max. power CH) or parameter **P070** (= max. power domestic water).
- ▶ Please do not use the pressure relief valve as a means of flushing the system.
- ▶ Remember that after hot water draw of a possible delay may occur before the heating system will fire up.
- ▶ All fluxes, residues and cleaner must be flushed from pipe-work and radiators prior to commissioning.
- ▶ External expansion vessels are best connected water side downwards to allow correct draining/cleaning of system and to prolong the life of the vessel diaphragm.
- ▶ Note: an anti-cycle delay time can be set up to a maximum of 15 minutes by adjusting parameter **P036** as described in **§8.3**.
- ▶ If you experience any problems please refer to the installation and commissioning guidelines within the boiler instruction manual. If necessary, please contact Intergas Heating Ltd).

5 INSTALLATION

5.1 Overall dimensions of boiler + assembly bracket

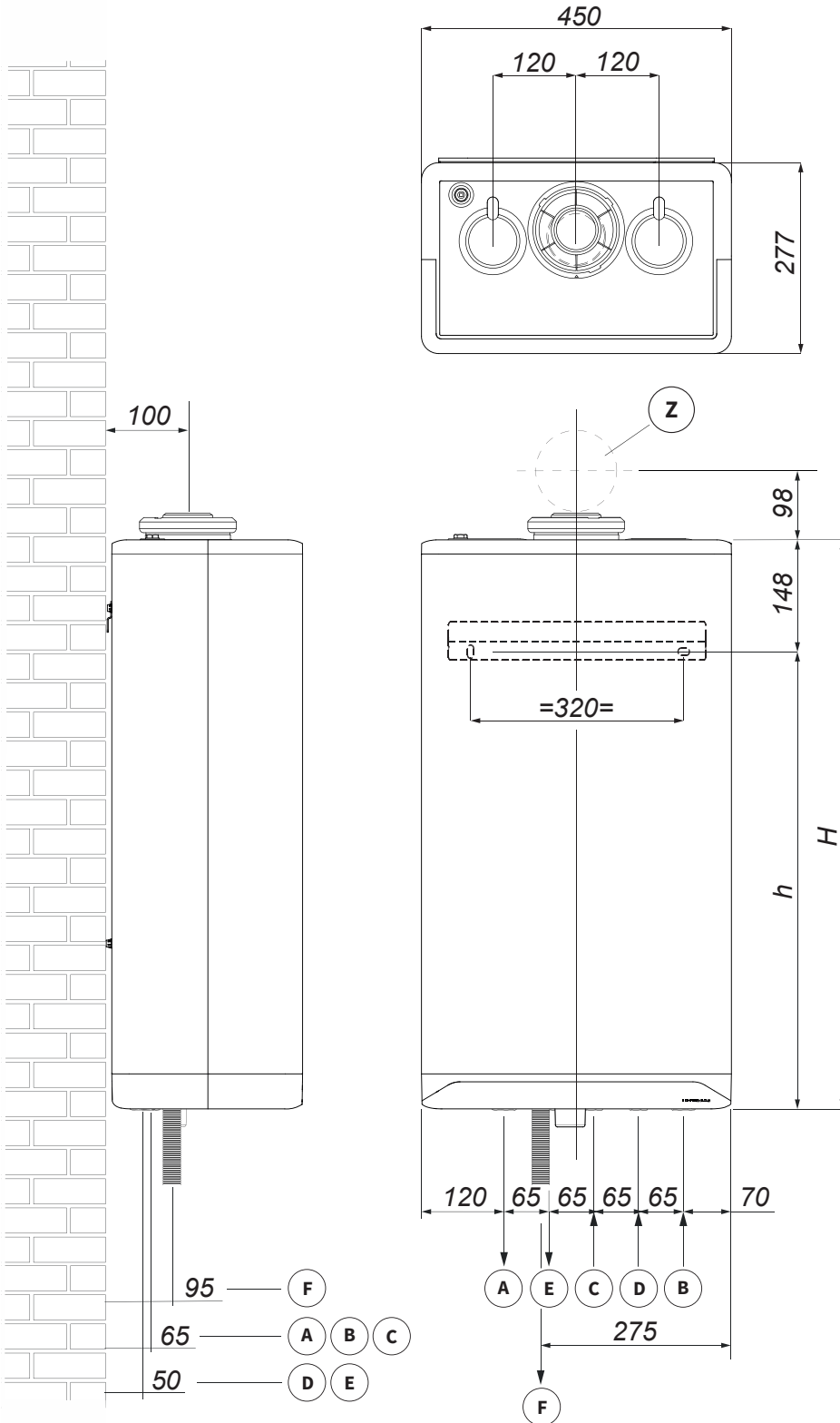

Connections		
(A)	Central heating flow	3/4"
(B)	Central heating return	3/4"
(C)	Gas flow	1/2"
(D)	Domestic hot water - cold	1/2"
(E)	Domestic hot water - hot	1/2"
(F)	Condensation drain	Ødn25
(Z)	Flue pipe / Air supply	Ø60/100 (concentric, wall terminal)

Overall dimensions		
h =	650 mm	Xclusive 24
	650 mm	Xclusive 30
	710 mm	Xclusive 36
H =	766 mm	Xclusive 24
	766 mm	Xclusive 30
	826 mm	Xclusive 36

5.1.1 Installing the wall bracket and assembly bracket

Using the corresponding fasteners, attach the wall bracket and the assembly bracket horizontally to the wall. Refer to the drill pattern in **§5.1** or refer to the installation instructions supplied with the assembly bracket.

5.2 Installation location

The boiler must be installed on a wall that has sufficient strength to be able to bear the boiler filled with water.

There must be a Earthed fuse spur available at a maximum distance of one (1) metre from the boiler. The condensate must be connected from the boiler and drain away to the sewer.

To prevent freezing of the condensation drain piping, the boiler must be installed in a frost-free area.

Make sure the boiler is easily accessible by ensuring that there is sufficient free space surrounding the boiler. This facilitates the maintenance of the boiler, amongst other things.

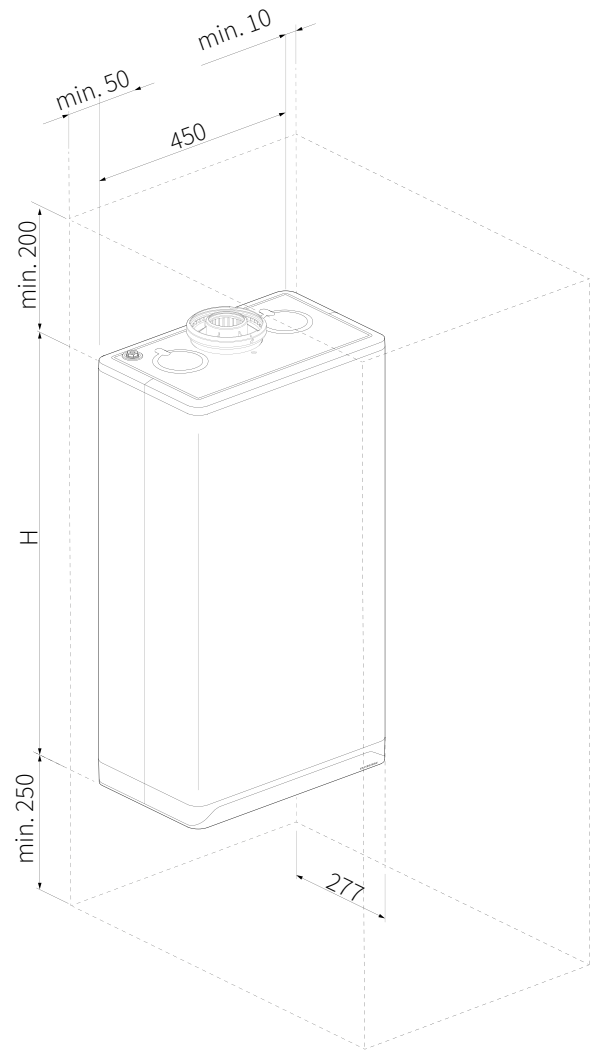

5.2.1 Installation in a kitchen cabinet

The boiler can be placed between two kitchen cabinets or inside one cabinet. Make sure, however, that there is sufficient ventilation below and above the boiler. If the boiler is placed inside a cabinet, ventilation openings of at least 50 cm² must be created above as well as below.

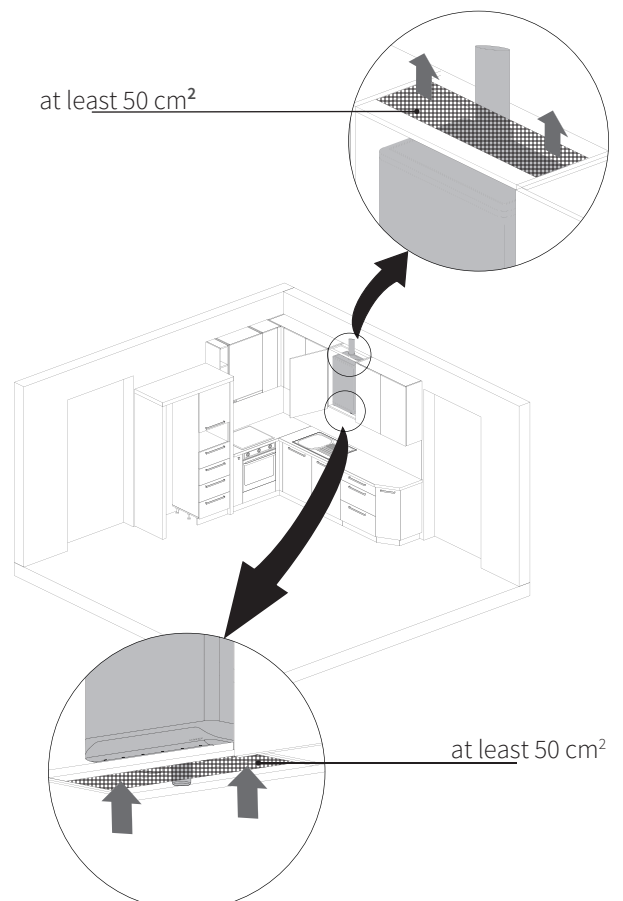

5.2.2 Removing/installing the front panel

- ▶ The front panel of the boiler must be removed to perform various maintenance activities. Do this as follows:
- ▶ Unscrew both (lossless) socket screws (1) under the boiler by using a 5 mm socket wrench.
- ▶ Slide the front panel (2) upward and then remove it by pulling it towards you.

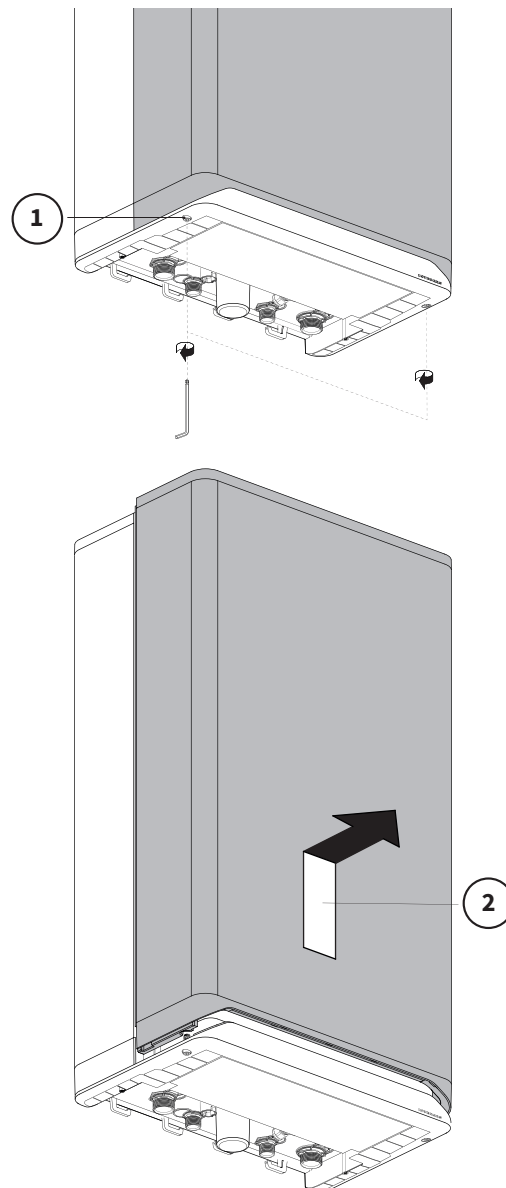

Replace front panel

To replace the front panel, proceed as follows:

- ▶ Position the front panel (3) against the boiler and slide it downwards until it is properly connected to the boiler.
- ▶ Screw tight both socket screws under the boiler using a 5 mm socket spanner.

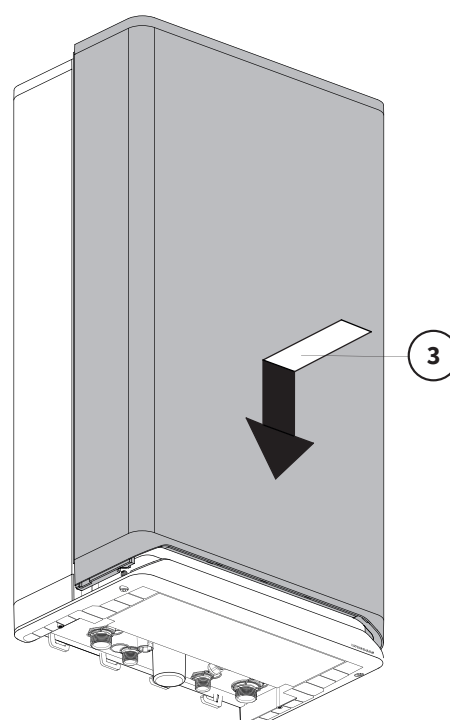

5.3 Installing the boiler

1. Install the wall bracket.
2. Place the boiler: Slide the boiler from the top down, over the wall bracket.
3. Remove the siphon cup.
4. You must fill the siphon cup just over half full with water.
5. Replace the cup. Install the flexible hose on the spout of the siphon.
6. Connect the flexible hose of the siphon to a 19 mm solvent weld pipe. To minimize the risk of freezing the condensate pipe should be connected internally and terminate to an internal sol stack (ref.: TB115 Gas Safe & HHIC).
7. Install the air supply duct and the flue (see **§6.6**).



COMMENT

- **The Intergas Xclusive has a boiler-specific siphon cup. Ensure that the proper version is ordered upon replacement. (Item no 510054)**

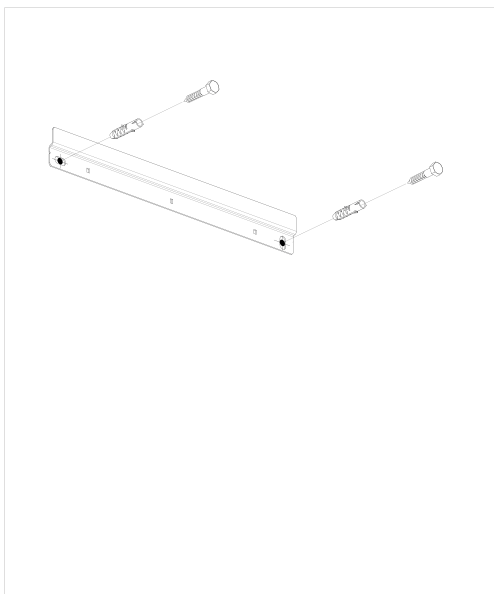

1. Assemble wall bracket

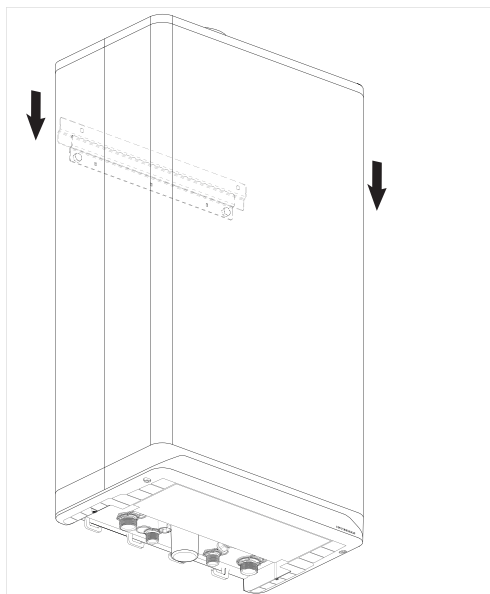

2. Place boiler

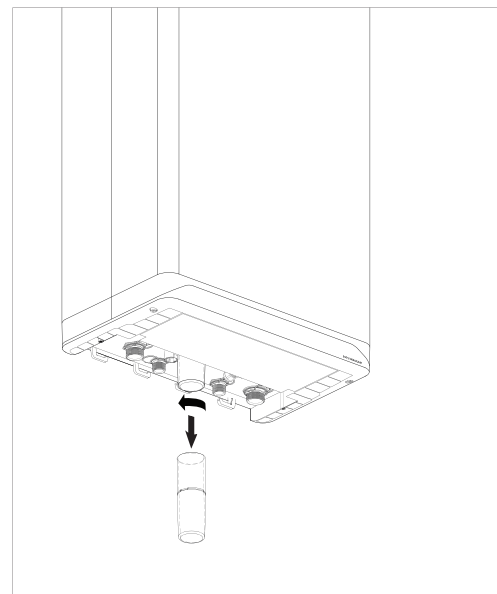

3. Remove siphon cup

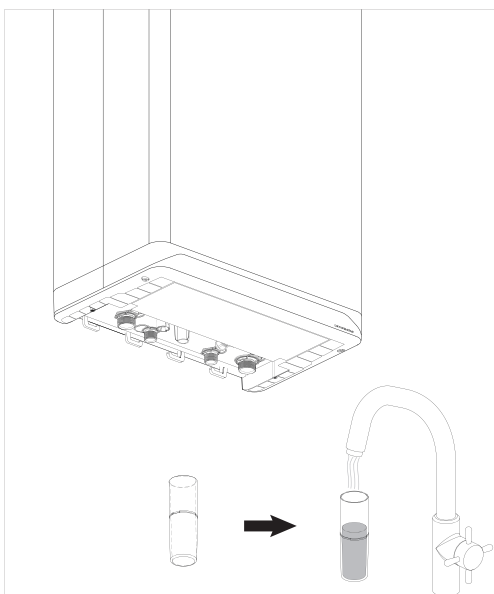

4. Fill siphon cup

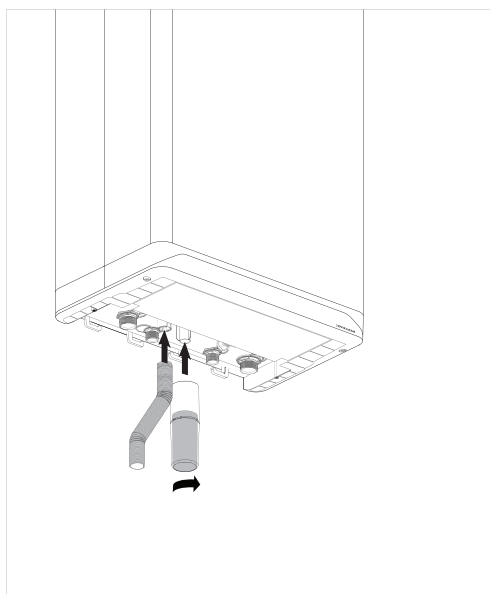

5. Replace siphon cup in position and attach flexible hose

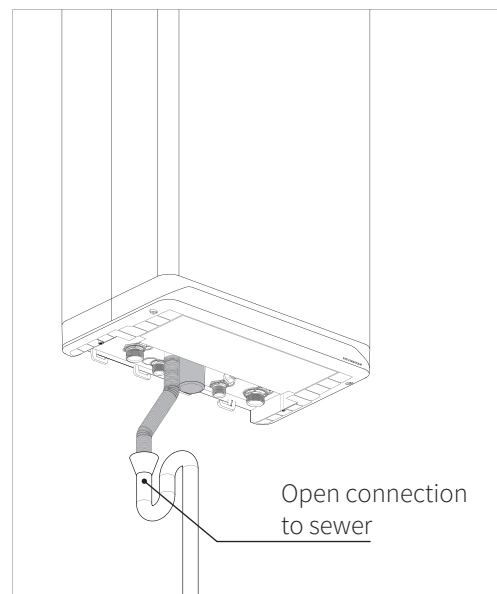

6. Connect the flexible hose to the sewer via an open connection.

6 CONNECTION

6.1 Connecting the central heating system

- ▶ Flush the central heating system thoroughly.
- ▶ Fit the flow and return pipes to the isolation valves.
- ▶ All pipes must be fitted unstressed in order to prevent pipes from ticking.
- ▶ Existing connections must not be twisted, in order to avoid leakages.

The CH system should be equipped with:

- ▶ A drain tap in the return pipe immediately below the appliance.
- ▶ A drain tap at the lowest point(s) of the installation.
- ▶ A non return valve, if pipes run upwards at a short distance from the appliance. This avoids the occurrence of thermosyphon effect during DHW operation mode.

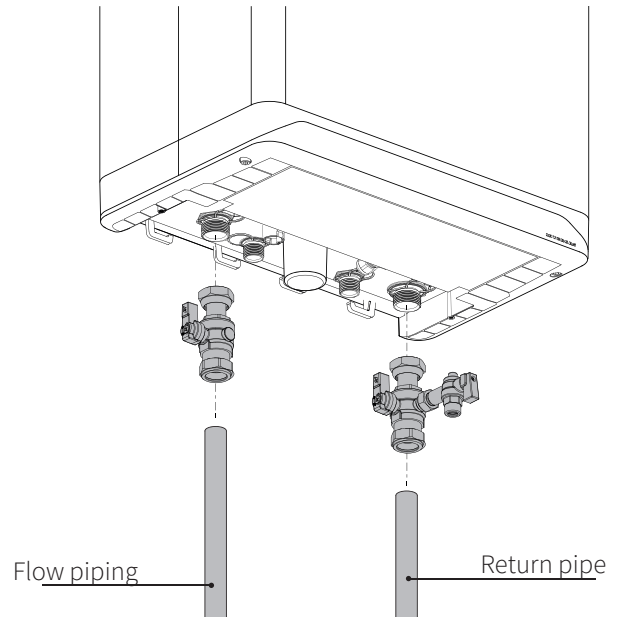

6.1.1 Expansion vessel

The appliance is fitted with a expansion vessel adequate for a system with a water volume not exceeding 100 litres, typically 8 radiators. For larger volume systems, an additional expansion vessel must be fitted. Contact Intergas for advice in these cases.

6.1.2 Thermostatic radiator valves

If all radiators have thermostatic radiator valves or valves that can be closed to separate the flow completely from the return, a minimum amount of water circulation must be ensured by the installation of bypass piping, for example (also see **§8.5**).

6.1.3 Floor heating

Floor heating with pump

For effective operation of the DHW supply any undesired circulation through the appliance as a result of a second pump in the CH circuit must be avoided.

Connect the floor heating system in a hydraulically neutral manner to the appliance, or equip the CH circuit with an electric shut-off valve or check valve to prevent flow through the appliance when there is no CH request for heat.

Make sure there is a minimum of water circulation; see **§8.5**.

Underfloor heating connection diagram

- A. Boiler
- B. Central heating pump
- C. Thermostatic control valve
- D. Spring-operated non-return valve
- E. Electric shut-off valve 230V~
- F. Radiators
- G. Room/clock thermostat
- H. Maximum thermostat

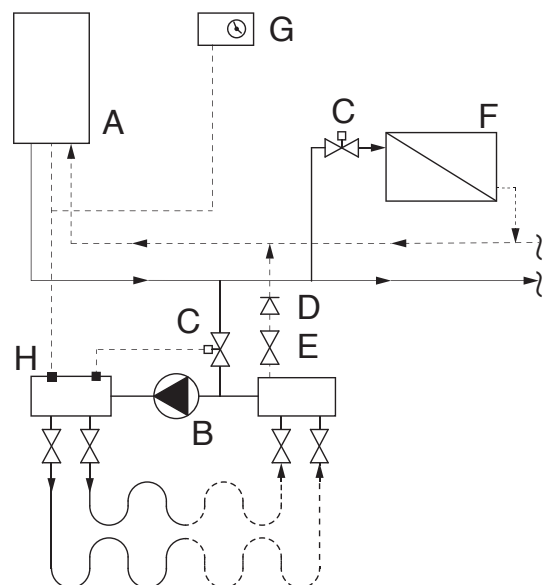

6.1.4 LT/HT zone system

The central heating system can be divided into two groups, each with a different heating temperature, for example a high-temperature zone (HT) with radiators and a low-temperature zone (LT) with underfloor heating system without its own circulation pump.

Both zones must have their own room thermostat. LT/HR zone control is activated by the adjustment of a number of parameters.

There are two different installation sets available for installing the LT/HT zone system:

- ▶ Installation set with two-way valve (item no 093697).
- ▶ Installation set with three-way valve (item no 093707).

Operational principle

The valve divides the heat over both zones. Both zones have their own room thermostat and are alternately (time-limited) heated through switching over the valve.



IMPORTANT

- ▶ **Ensure that the external pump pressure of the central heating pump in the boiler is taken into consideration during the design phase of the underfloor heating.**
- ▶ **If the radiators in the HT zone have thermostatic radiator valves, this zone must have a bypass valve.**

6.1.5 Division of central heating system in groups with extra heat source

Operational principle

If the room thermostat switches off the boiler because another heat source is heating the room, it is possible that the other rooms will cool down.

This can be prevented by dividing the central heating system into two groups. The group with the external heat source (Z2) can be closed off from the main circuit with an electric shut-off valve. Both groups have their own room thermostat.

Note: This 'external heat source' control can only be applied if no external boiler must be heated.

Installation manual

- ▶ Place the shut-off valve (B) according to the connection diagram.

If an OpenTherm or an on/off thermostat is used:

Connection diagram 'external heat source' control

- A. Boiler
- B. Electric shut-off valve 230V~
- C. Radiators
- T1. Room thermostat Group 1
- T2. Room thermostat Group 2
- Z1. Group 1
- Z2. Group 2

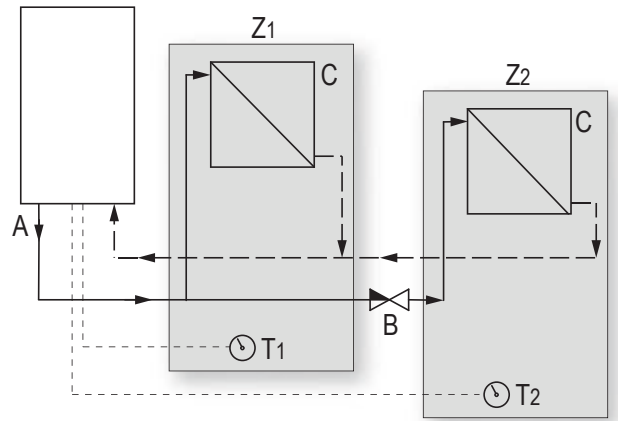

- ▶ Connect the room thermostat of Group 1 (T1) to Connector X12 1/2.
- ▶ Connect the room thermostat of Group 2 (T2) to (optional) Connector X13 1/2.
- ▶ Change parameter **P081** (see §8.3).

If an RF thermostat is used:

- ▶ Connect the RF thermostat using the RF menu; see §7.1.4. The RF thermostat can only be used for Group 2.
- ▶ Change parameter **P081** (see §8.3).



COMMENT

- ▶ All types of thermostats (OpenTherm, on/off or RF) can be used in both groups.

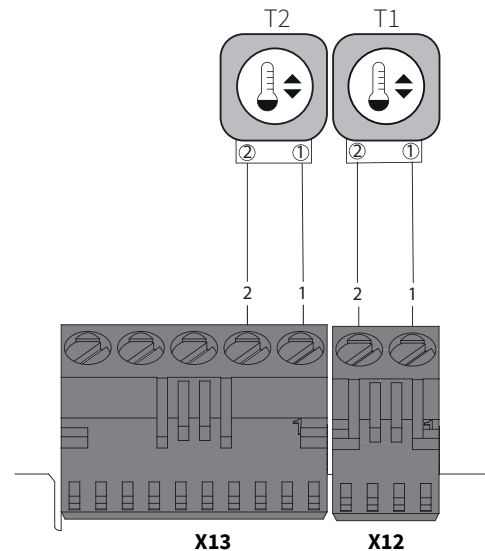

Connect thermostats Groups 1 and 2

6.2 Connection of domestic hot water

- ▶ Flush the installation thoroughly to clean (please refer to current Standard Codes of Practice).
- ▶ Fit the cold and hot water pipes into the shut off valve and the elbow.
- ▶ Existing connections must not be twisted, in order to avoid leakages. Make sure the compression fittings are tightened thoroughly to prevent leakage.

Comments

- ▶ The specific pipeline length with a piping diameter of 12/10 mm or 15/13 mm is 30 meters and 17.7 meters, respectively.
- ▶ If the boiler is only used for the domestic hot water facility, the heating function can be switched off. Parameter **P001** must then be changed from 0 to 2. In this case, the central heating system does not need to be connected or filled.
- ▶ If the boiler is out of order and disconnected from the electricity network during the winter months, the water must be drained to prevent freezing. Disconnect the domestic hot water connections immediately directly under the boiler.
- ▶ The Xclusive 24 is equipped with a flow restrictor with a nominal value of 8 l/min. The Xclusive 30 and Xclusive 36 do not have this feature. If desired, this can be ordered from Intergas as an option.
The Xclusive 36 allows larger volume flows with high water pressures; to ensure an exhaust temperature of 55°C, the DHW facility has to be set at 9 l/min.

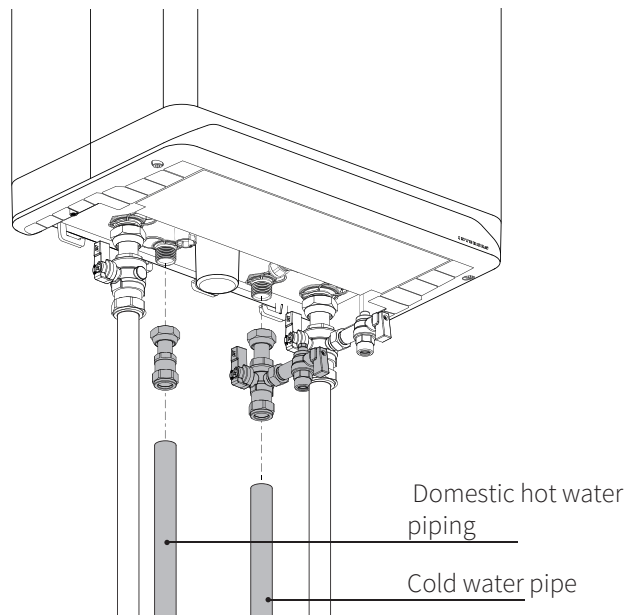

6.2.1 DHW circuit resistance graph

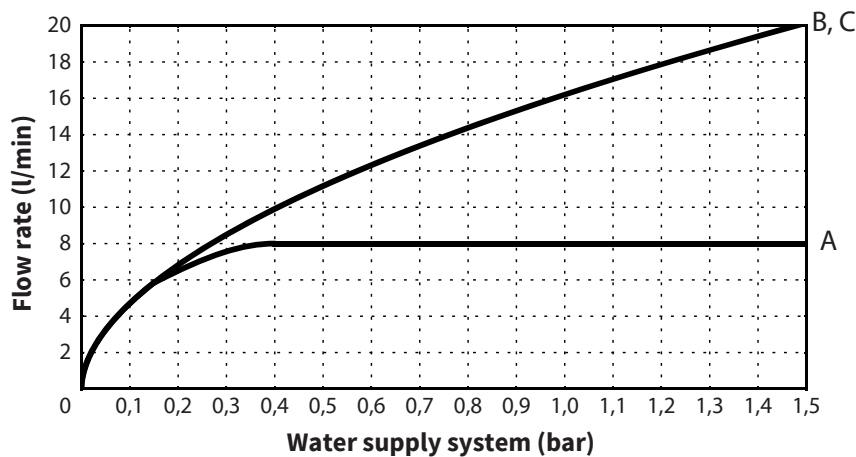

- A. Xclusive 24
- B. Xclusive 30
- C. Xclusive 36

6.2.2 Boiler with heat pump boiler

The boiler is suitable for use in combination with a heat pump boiler.

If the exhaust temperature of a heat pump boiler is lower than 55°C, the Intergas Xclusive makes sure that the domestic hot water from the heat pump boiler is post-heated under HE conditions.

Operational principle:

The domestic hot water connection of the heat pump boiler is connected to the mix input of the thermostatic switch valve (see the principle diagram). If the DHW temperature of the boiler is higher than the set temperature of the switch valve, the heat pump boiler will be tapped. Because the switch valve is not fully closing, a small amount will also run through the Intergas Xclusive (about 10% of the total flow).

As soon as the exhaust temperature of the heat pump boiler becomes lower than the set temperature of the switch valve, the flow through the Intergas Xclusive will increase. If the flow becomes greater than the domestic hot water threshold of the Intergas Xclusive, the boiler will start domestic hot water demand.

When the exhaust temperature of the heat pump boiler has become lower than the set temperature of the switch valve minus 12K, almost the entire domestic hot water flow goes through the Intergas Xclusive. The small leakage flow is now taken from the heat pump boiler. After the entire switching of the switch valve, the domestic hot water flow will be limited by the Intergas Xclusive.

Connection diagram of boiler with heat pump boiler

- A. Heat pump
- B. Boiler
- C. Switch valve
- D. Cold water inlet
- E. DHW temperature of heat pump
- F. DHW temperature of domestic hot water

Installation:

The combination must be connected according to the connection diagram. The following points are important to guarantee a correct operation of the combination.

Thermostatic switch valve:

The thermostatic switch valve used is a modified valve that meets the specific requirements to which the combination heat pump boiler and Intergas Xclusive are subject. For the correct operation of the combination, the switch valve has a fixed temperature setting. The thermostatic switch valve can be ordered from Intergas (item no: 065127).

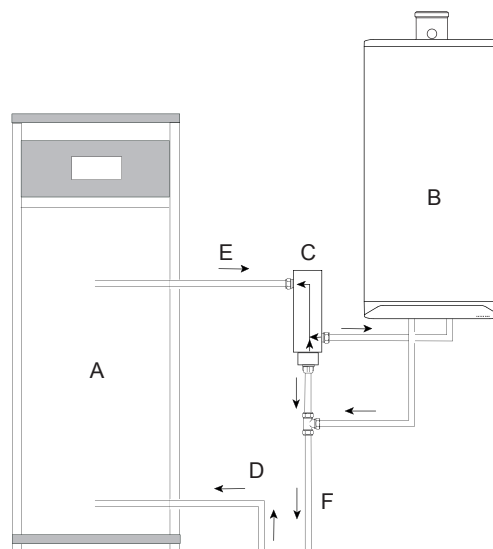

Domestic hot water inlet pressure:

For a flow volume of 20 litres per minute, the initial pressure must be a minimum of 2.3 bar. The allowed domestic hot water operational pressure for the combination may be a maximum of 6 bar. A safety group (6 bar) must be installed for this purpose.

Maximum flow volume:

If the domestic hot water flow is greater than 20 litres per minute, the Intergas Xclusive will start domestic hot water demand, regardless of the exhaust temperature of the heat pump boiler.

Maximum temperature setting of the heat pump boiler:

The temperature of the heat pump boiler may not be set higher than 60°C.

Position of thermostatic switch valve:

To prevent the thermostatic switch valve being influenced too much by the surrounding air, this valve must be placed in a vertical position and as close as possible to the domestic hot water connection of the boiler (maximum distance of 100 mm). This prevents the boiler operating with each tap request.

Influence of water flows:

To prevent the flow being influenced by the Intergas Xclusive during the switching of the valve, the domestic hot water 'out' pipeline of the combination must run straight (see connection diagram [F]).

6.2.3 Boiler with Pre-Heated Solar Boiler)

A connection set and a thermostatic mixing valve are available to order for this purpose.

Comment:

The cold water sensor must be connected to Connector X13 4/5. When combined with a solar energy system, a thermostatic mixing valve, set at 62.5°C, must always be placed after the boiler.

- ▶ Pre-heated Solar boiler conversion set item no 090347
- ▶ Thermostatic mixing valve item no 842177

Connection diagram:

- A. Boiler
- B. Solar boiler
- C. Cold water
- D. Safety group
- E. T max. 85°C
- F. Domestic hot water
- G. Thermostatic mixing valve 35°C-65°C (set at 62.5°C)
- H. Domestic hot water mixed
- I. Cold water sensor

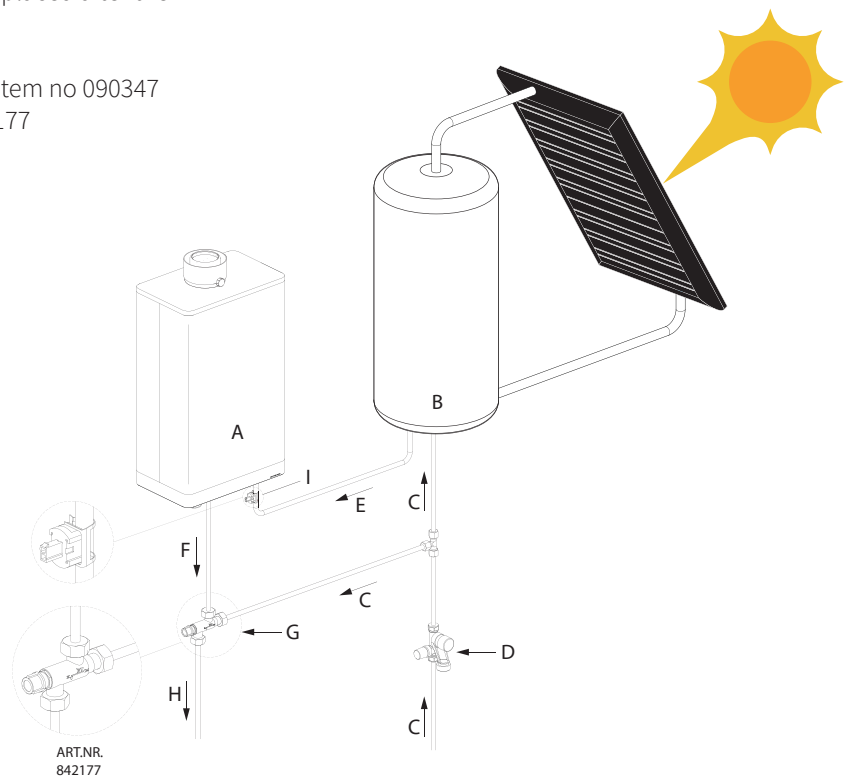

6.3 Electrical connection



CAREFUL

- ▶ A fused spur or an unswitched socket must be located no more than 1 metre from the appliance.
- ▶ For installation in damp rooms a fixed connection is obligatory.
- ▶ When working on the electrical circuit always isolate the electric supply.
- ▶ When the power mains cord must be replaced, this must be ordered from Intergas.

If maintenance activities to the electric circuit must be performed:

- ▶ Remove the front panel (see §5.2.2) and pull the burner controller unit forward; the burner controller will then tilt downwards.
- ▶ Consult the electrical schematic in §11.1 for making the connections.



CAREFUL

- ▶ The Xclusive complies with IPX4D. To ensure this, cable grommets should be used when making electrical connections.

- ▶ After the desired connections have been made, slide the burner controller back in the boiler (until the left and right safeties are again locked) and replace the front panel on the boiler; see §5.2.2.
- ▶ After making the desired connections plug the appliance into an earthed wall socket

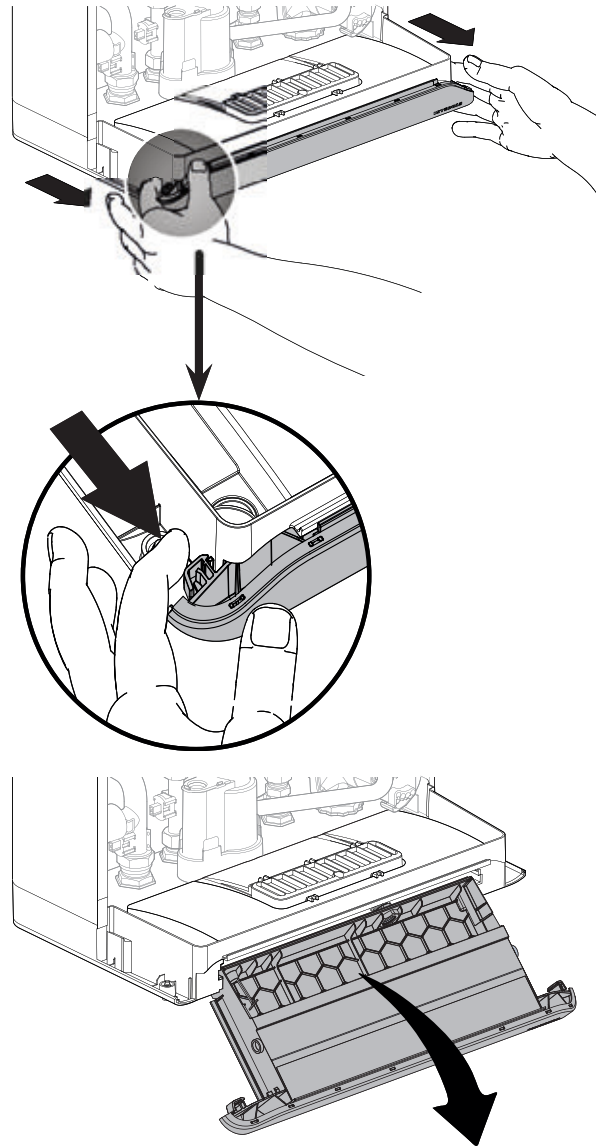

6.4 Gas connection

- ▶ Fit the gas pipe into the gas valve and tighten this thoroughly.
- ▶ Make sure that the gas pipe is fixed to a rigid surface.
- ▶ Open the main gas valve and purge the system.
- ▶ Check all connections for leakage.



CAREFUL

- ▶ Before starting the work, close the main gas valve.
- ▶ The boiler is intended exclusively to be installed on a gas supply with a meter with gas pressure regulator.
- ▶ When pollution in the gas is to be expected a gas filter has to be placed in the gas pipe to the boiler.

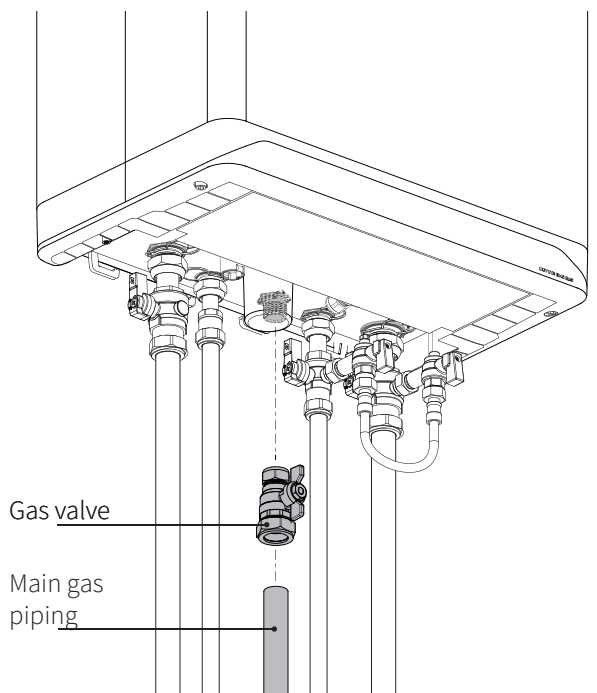

6.5 Connecting room thermostat

The boiler is suitable for connection to the following room thermostats:

- ▶ OpenTherm (OT) thermostat
- ▶ On/off thermostat
- ▶ RF thermostat; see §8.1.4.

6.5.1 Connecting Modulating OpenTherm thermostat

The boiler is standardly provided with an OpenTherm connection. This allows the connection of modulating OpenTherm thermostats without any additional modifications. The Xclusive is also suitable for **OpenTherm Smart Power**.

- ▶ Place the thermostat in the room that functions as a reference point (in general, the living room).
- ▶ Connect the modulating thermostat to Connector X13 1/2 (also see §11.1); the polarity of the wires is not important in this situation. The boiler offers the possibility of connecting two OpenTherm thermostats. Connect a 2nd OpenTherm thermostat to an (optional) Connector X12.

If you would like to make use of the domestic hot water on/off switch function of the OpenTherm thermostat, the DHW comfort function must be set to 'eco' or 'on' (see §8.1.2) and parameter **P074** must be set to 0.

For more information, consult the manual of the room thermostat.

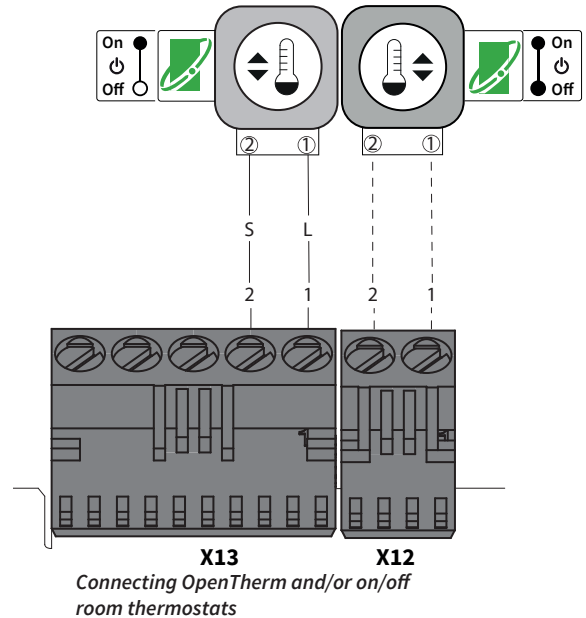

6.5.2 Connecting on/off room thermostat

The boiler is suitable for connection to a 2-wire on/off room thermostat.

- ▶ Place the thermostat in the room that functions as a reference point (in general, the living room).
- ▶ Connect the 2-wire room thermostat to Connector X13 1/2 (also see §11.1); the polarity is not important in this situation. A second on/off thermostat can be connected to the (optional) Connector X12, if desired.

 **If both an OpenTherm as well as an on/off thermostat is connected, the on/off thermostat has priority with respect to the OpenTherm thermostat.**

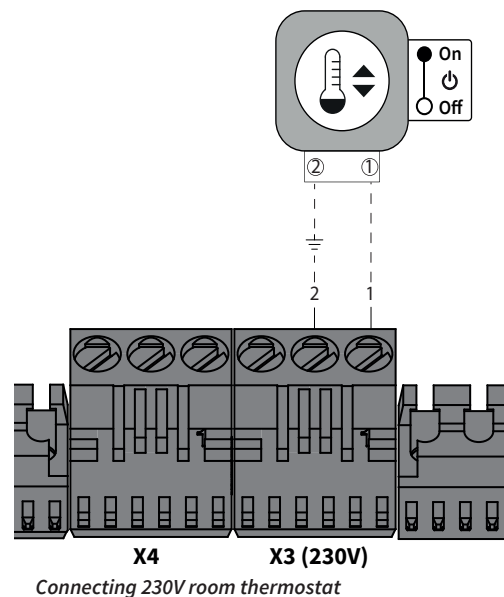

6.5.3 Connecting 230V room thermostat

To be connected to contacts 1 and 2 of connector X3.

- ▶ Place the thermostat in the room that functions as a reference point (in general, the living room).
- ▶ Connect the 2-wire room thermostat to Connector X3 1/2 (also see §11.1); the polarity is not important in this situation.

 **IMPORTANT (HIGH VOLTAGE)**
▶ **Isolate the appliance from the electrical supply before connecting the thermostat.**

6.5.4 Connecting outdoor sensor

The boiler has a connection for an Intergas outdoor sensor. The outdoor sensor must be used in combination with an on/off or OpenTherm room thermostat.

In principle, any on/off or OpenTherm room thermostat can be combined with an Intergas outdoor sensor. With an on/off thermostat, the boiler will adjust the flow temperature according to the set heating line. With an OpenTherm thermostat, this determines the influence on the flow temperature.

- ▶ Connect the outdoor sensor to Connector X13 3/4 (also see §11.1).
For the heating line graph, see §7.6.

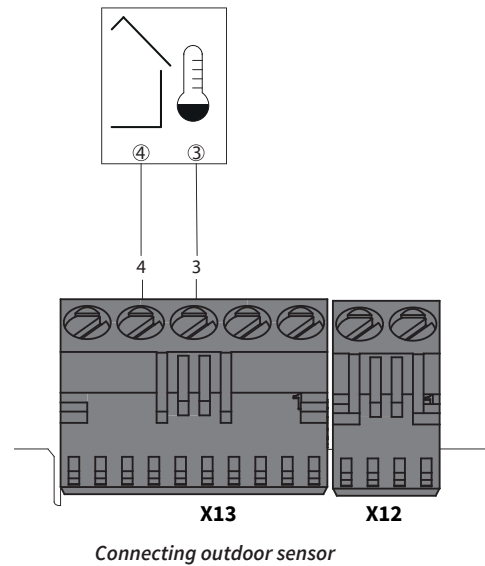

6.5.5 Frost protection

- ▶ To prevent freezing of the condensation drain piping, the boiler must be installed in a frost-free area.
- ▶ To prevent freezing of the boiler, the boiler is equipped with frost protection. If the temperature of the water in the heat exchanger becomes too low, the pump will run (the burner is switched on if needed) until the temperature of the water is again at a frost-free level.

Comment

If an on/off room thermostat will be used, secure a frost-hazard area from frost in combination with a frost thermostat. The radiator valve in the frost-sensitive area must be opened.

- ▶ In frost-hazard areas (for example, a garage), place a frost thermostat.
- ▶ Connect the frost thermostat together with an on/off room thermostat or RF thermostat parallel to Connector X13 1/2 (also see §11.1).

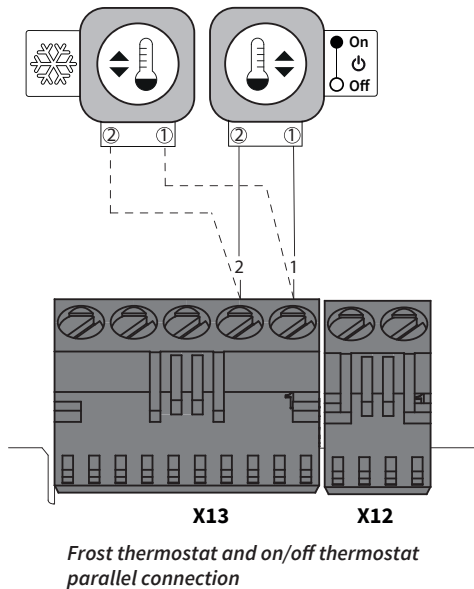

CAREFUL

- ▶ **With the use of an OpenTherm thermostat, a frost thermostat may not be connected in parallel on Connector X13. In that case, connect the OpenTherm thermostat to Connector X13 and the frost thermostat to Connector X12 (optional).**

If the (external) frost thermostat is used in the installation and it is connected to the boiler, it is not active when the boiler is switched off.

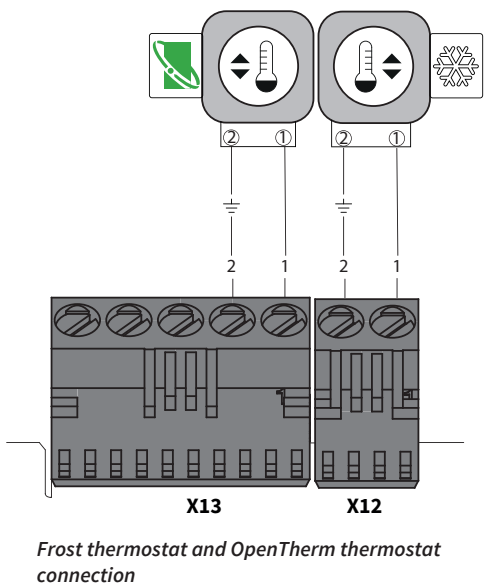

6.5.6 Connecting boiler sensor/thermostat

- ▶ The boiler sensor/thermostat can be connected to Connector X13 4/5 (also see **§11.1**).

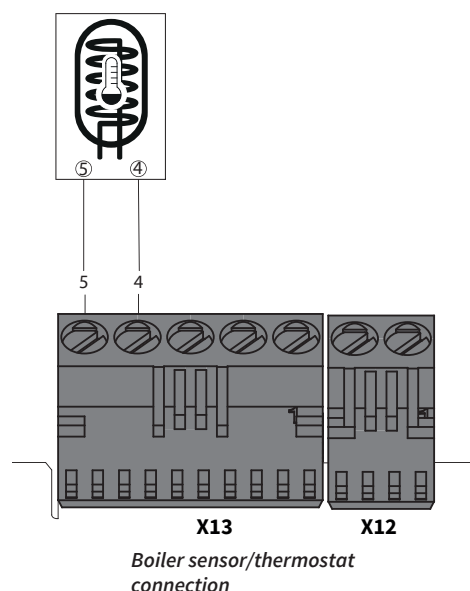

6.5.7 PC interface

The automatic has an interface for a PC. A PC can communicate with the boiler through a special cable, or wirelessly through the Intergas USB dongle, along with associated software. This facility allows the behaviour of the boiler controller, the boiler and the heating system to be followed over a longer period of time.

- ▶ Connect the cable to Connector X14 (also see **§11.1**).

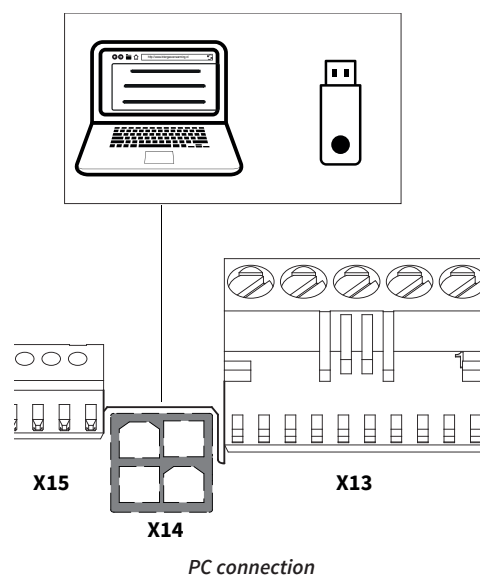

6.5.8 Comfort Touch

It is possible to combine the Xtreme with the Intergas Comfort Touch wireless and Comfort Touch OpenTherm (available as an option). This set consists of a LAN2RF gateway and a connection set. The LAN2RF gateway provides a connection between an internet router and the boiler, so that the boiler can be monitored and managed at a distance (via a web server) using the Comfort Touch service app.

The Comfort Touch is available via the regular merchant.

If the end user also wants to make use of the Comfort Touch possibilities of the Xtreme, the set is also available with a Honeywell Round thermostat. For the end user, a consumer version of the Comfort Touch app is available.

The Comfort Touch service and consumer app can be downloaded from both the Google Play Store and the Apple App Store.

6.6 Flue and air supply duct



- ▶ For the installation of the flue and air supply duct material, see the manual included with the materials. Contact the manufacturer of the relevant flue and air supply duct materials for extensive technical information and specific assembly instructions.
- ▶ Only stainless steel or plastic (PP T120) flue material is allowed.



- ▶ Make sure that the socket connections of the flue and air supply duct materials are correctly sealed. Improper fastening of the flue and the air supply duct can lead to hazardous situations or result in personal injury. Check all flue components for tightness.
- ▶ Don not use screws or parkers to mount the flue system as leakage can occur.
- ▶ Do not use any sort of grease when mounting the pipe system. Use water instead. The sealing rubbers can be negatively affected when grease is applied.
- ▶ Do not mix any components, materials or ways of coupling from different manufacturers.

6.6.1 Draft, materials and insulation

Piping	Diameter	Material
Flue	Ø100/60 mm	According to Table 4 of NPR3378-46 (C-category appliances) NPR3378-47 (B-category appliances) Only stainless steel or PP T120.

6.7 Pipeline lengths

As the resistance of the flue and air supply duct pipes increases, the capacity of the boiler will decrease. The allowed decrease in capacity is a maximum of 5%.

The resistance of the air supply duct and the flue depends on the length and diameter of the piping system and all associated components. For each boiler category, the total allowed pipeline length of the air supply duct and flue is given.

The specification of the pipeline length in meters assumes $\varnothing 80$ mm piping.

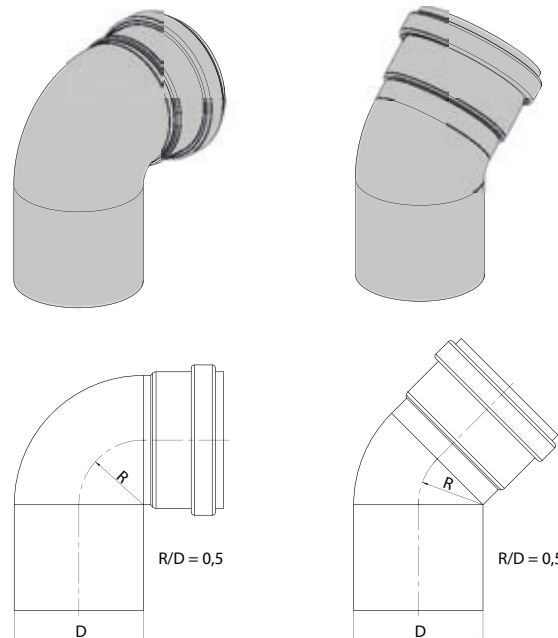

6.7.1 Replacement lengths

Curve of 90°	R/D=1	2 m
Curve of 45°	R/D=1	1 m
Knee of 90°	R/D=0.5	4 m
Knee of 45°	R/D=0.5	2 m

Contact the manufacturer for check calculations for the resistance of the air supply duct and flue system and for the wall temperature at the end of the flue system.

6.7.2 Example calculation

Piping	Pipeline length	Total pipeline length
Flue	$L1+L2+L3+(2 \times 2\text{m})$	12 m
Air supply duct	$L4+L5+L6+(2 \times 2\text{m})+(1 \times 1\text{m})$	13 m

Comments

- The total pipeline length is:
The sum of the straight pipeline lengths + the sum of the replacement pipeline lengths of curves/knees are together 25 meters.
- If the allowed length of air supply duct pipe and flue pipe are together 80 metres (excluding the length of the combi-pipe wall terminal or the twin-pipe wall terminal), then the calculation falls within the allowed pipeline length.

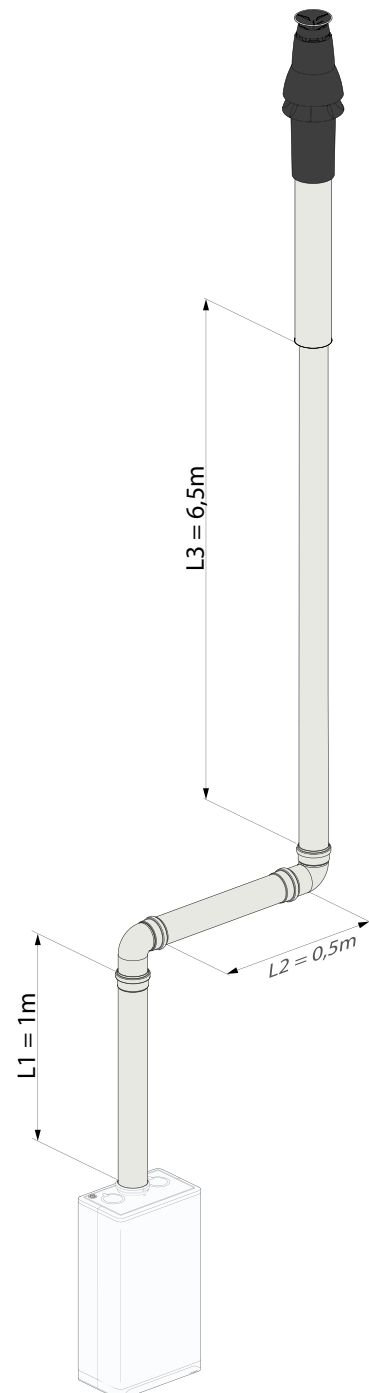

6.8 General layout of the flue

The following drawing shows all possible situations schematically.



COMMENT

► The following schematic drawings serve as examples and the details may differ from the actual situation.

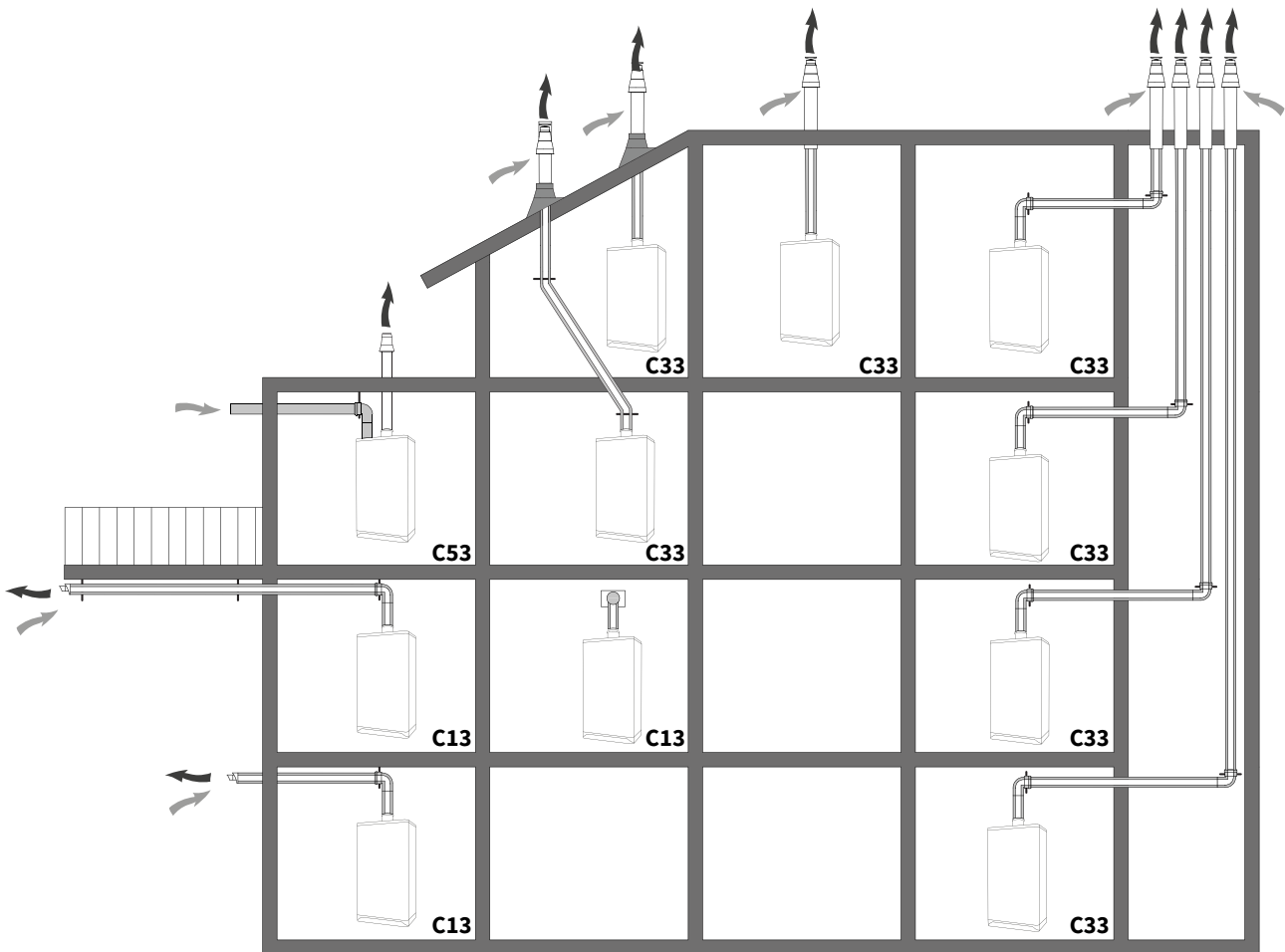

Note for flue systems

Cat.	Note according to CE	Materials	Supplier/ Inspection requirement	Applicable to Xclusive
C13	The terminal is located in the façade; the inlet for the air supply duct is located in the same pressure area as the terminal. Example: combined façade terminal	Terminal	Intergas	Yes
		Other components	Gastec QA or Intergas	
C33	The terminal is located above the roof; the inlet for the air supply duct is located in the same pressure area as the terminal of the flue piping.	Terminal	Intergas	Yes
		Terminal at the prefab chimney	Gastec QA or Intergas	
		Other components		
C53	Closed unit, connected to separate air supply duct and flue channels, terminated in various pressure zones. See the installation manual for the possibilities.	Intake grille	Intergas	Yes
		Other components and exhaust cap	Gastec QA or Intergas	

6.8.1 Wall terminal with twin-pipe horizontal terminal C13



COMMENT

- ▶ Pipes for the connection of the air supply duct and the flue between the boiler and the combi-pipe wall terminal must have a diameter of Ø80 mm.
- ▶ When using a wall terminal, the boiler must be equipped with a flue gas non-return valve (item no 090417).
- ▶ The individual flue pipe (Ø80) must be constructed of stainless steel or plastic PP T120.

- ▶ Intergas twin-pipe horizontal wall terminal (item no 09027). To be extended, in the case of a balcony terminal, with one or two standard pipes (Ø80 mm).

Allowable pipeline length

Air supply and flue system including the length of the twin-pipe wall terminal.

Boiler	Length
Intergas Xclusive 24	100 m
Intergas Xclusive 30	85 m
Intergas Xclusive 36	80 m

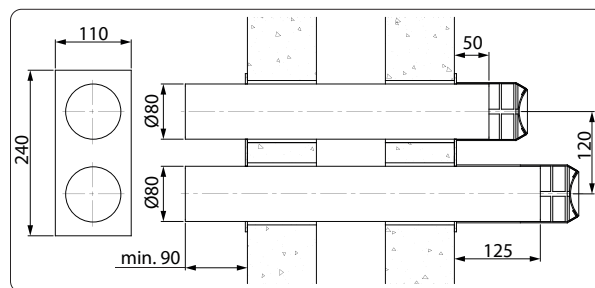
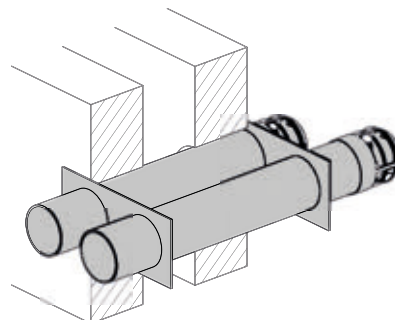

Assembly of twin-pipe wall terminal

- ▶ Create two openings of Ø90 mm at the location of the terminal.
- ▶ Shorten the twin-pipe wall terminal to the correct length.
- ▶ Slide the supply and exhaust pipe in the openings.
- ▶ Close the openings with the wall covers.
- ▶ Install the outlet grilles on the supply and exhaust pipe.
- ▶ Attach these to the pipes.
- ▶ Assemble the twin-pipe wall terminal, taking into account the air supply duct goes to the exterior at an angle and the flue goes to the boiler at an angle.

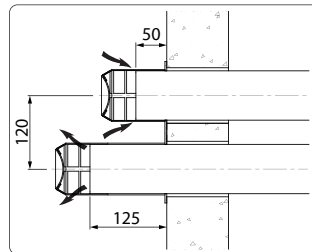
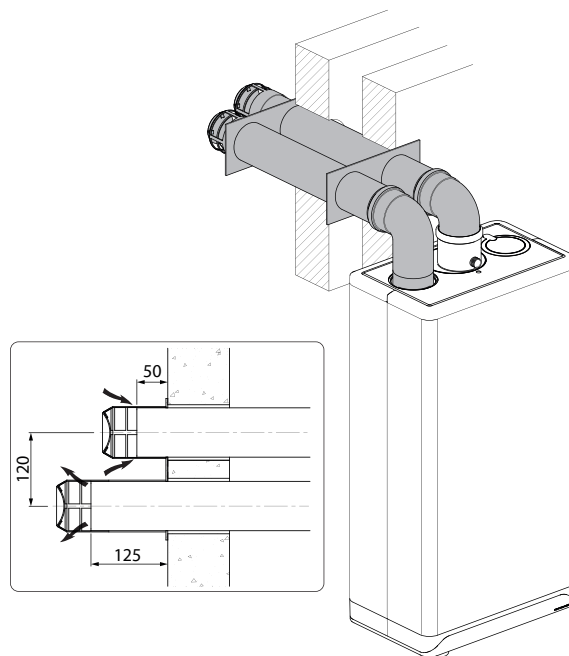

6.8.2 Façade combi-pipe horizontal terminal C13



COMMENT

- ▶ Pipes for the connection of the air supply duct and the flue between the boiler and the combi-pipe wall terminal must have a diameter of Ø80 mm.
- ▶ It is recommended to use a flue gas non return valve.
- ▶ The individual flue pipe (Ø80) and/ or the internal pipe of the combi-pipe wall terminal / extension pipe must be constructed of stainless steel or PP T120.

Allowed pipeline length

▶ Twin-pipe

Air supply duct and flue pipe together, excluding the length of the combi-pipe wall terminal.

Boiler	Length
Intergas Xclusive 24	100 m
Intergas Xclusive 30	85 m
Intergas Xclusive 36	80 m

▶ Concentric

Air supply duct and combustible gas exhaust pipe together, excluding the length of the combi-pipe wall terminal.

 Boiler	C13	
Ø60/100	Intergas Xclusive 24	10 m
	Intergas Xclusive 30	10 m
	Intergas Xclusive 36	10 m

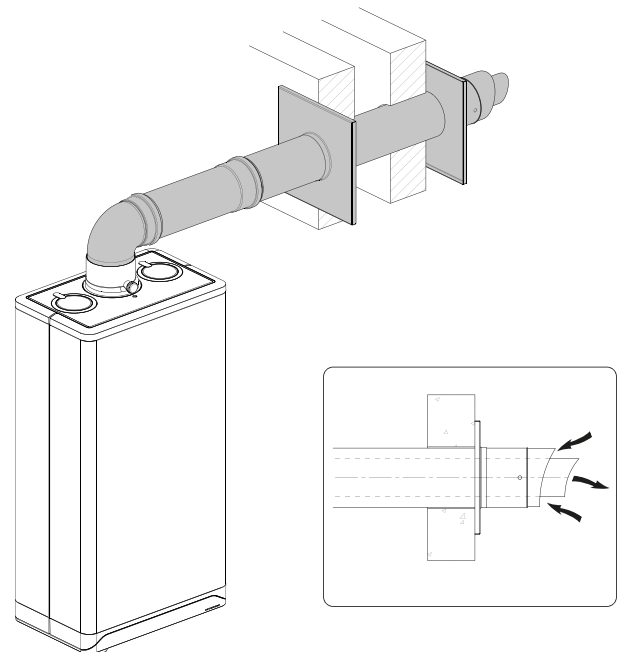
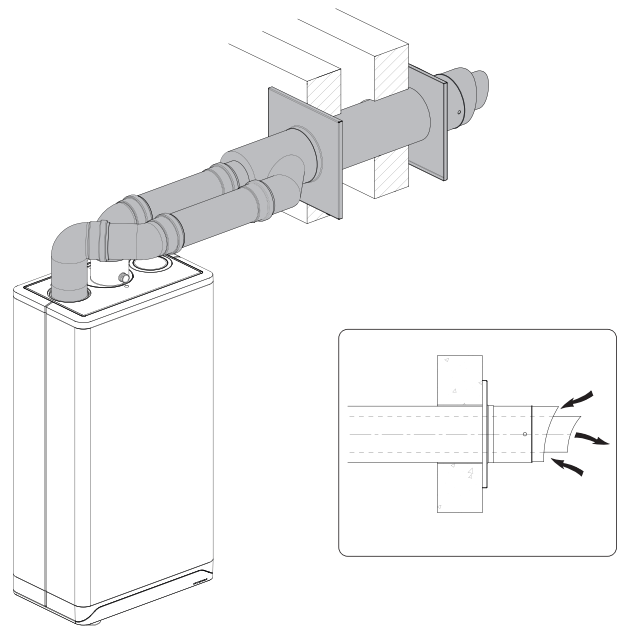

Assembly of combi-pipe horizontal terminal

- ▶ Create an opening of Ø130 mm at the location of the terminal.
- ▶ Shorten the combi-pipe wall terminal to the indicated length.
- ▶ Assemble the outlet grille and attach this to the internal pipe.
- ▶ Slide the combi-pipe wall terminal in the opening and attach rosettes to cover the opening.
- ▶ Assemble the combi-pipe wall terminal to the boiler at an angle.

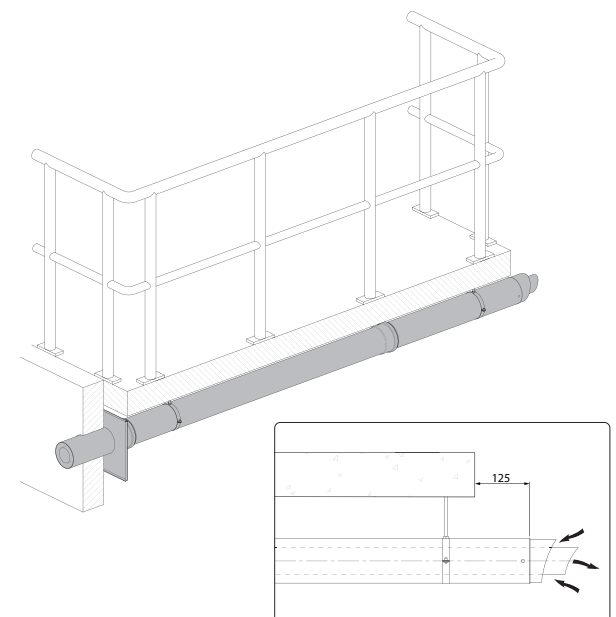

6.8.3 Roof terminal with combi-pipe vertical terminal and twin-pipe vertical terminal C33



IMPORTANT

- ▶ If the Intergas combi-pipe vertical terminal cannot be used, the air supply duct and flue must be implemented separately.
- ▶ The individual flue pipe (Ø80) and/or the internal pipe of the combi-pipe wall terminal / extension pipe must be constructed of stainless steel or PP T120.

- ▶ Intergas combi-pipe vertical terminal

Allowed pipeline length

▶ Twin-pipe

Air supply duct and flue pipe together, excluding the length of the combi-pipe wall terminal or the twin-pipe wall terminal.

Boiler	Length
Intergas Xclusive 24	100 m
Intergas Xclusive 30	85 m
Intergas Xclusive 36	80 m

▶ Concentric

Air supply duct and combustible gas exhaust pipe, excluding the length of the combi-pipe wall terminal.

	Boiler	C33
Ø60/100	Intergas Xclusive 24	11 m
	Intergas Xclusive 30	10 m
	Intergas Xclusive 36	10 m

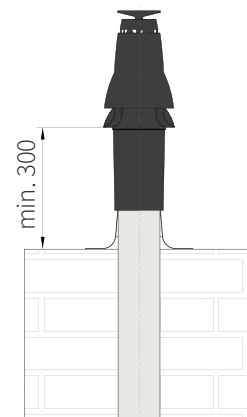
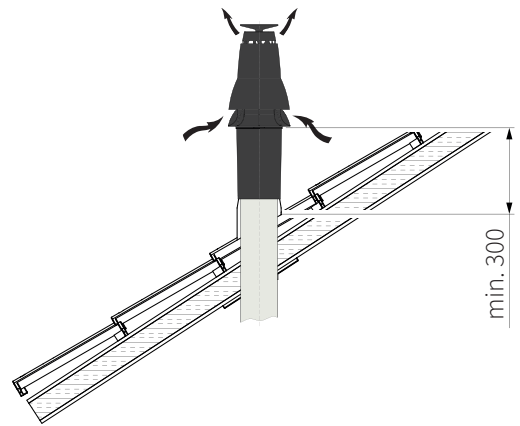
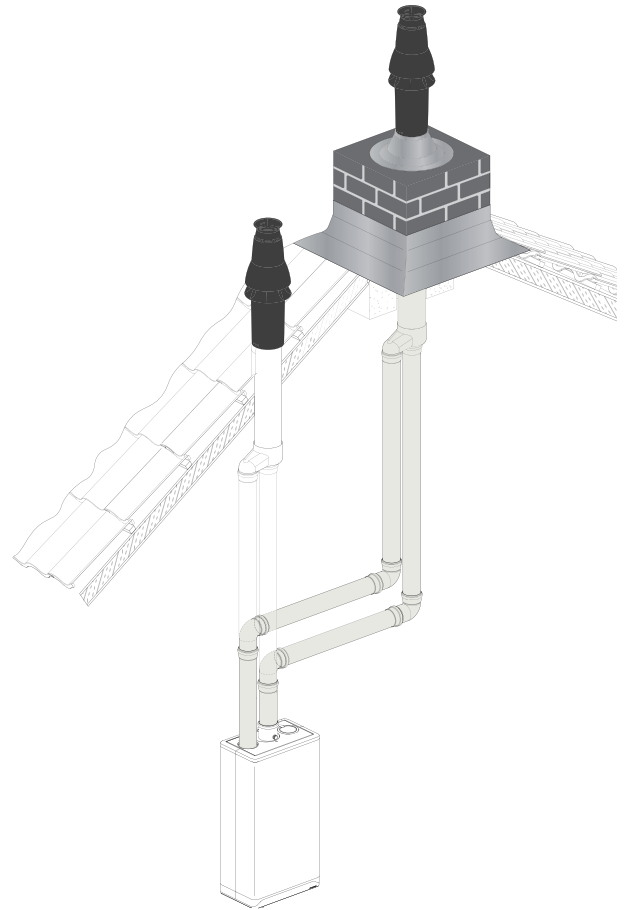

Assembly of combi-pipe vertical terminal

- ▶ On a steep roof, install a vertical weather slate with scale at the location of the terminal.
On a flat roof, a weather slate (flat roof) for a pipe (Ø126 mm) must be installed.
- ▶ Disassemble the manifold from the combi-pipe wall terminal.
- ▶ Slide the combi-pipe wall terminal from the outside to the inside:
With a steep roof, through the vertical weather slate with scale.
With a flat roof, through the weather slate.
- ▶ Install the manifold from the combi-pipe wall terminal and secure this with a panel screw or blind rivet.

6.8.4 Roof terminal and air supply duct from the façade C53



IMPORTANT

- ▶ **The air supply duct in the façade must have an Intergas intake grille (item no 926187).**
- ▶ **The individual flue pipe (Ø80) must be constructed of stainless steel or plastic PP T120.**

- ▶ Flue through a prefab chimney or through a double-walled roof terminal Ø80 mm with pulling exhaust cap.

The prefab chimney must have flue openings of at least 150 cm² per connected boiler and must satisfy the indicated minimum measurements. The supplier of the prefab chimney must guarantee the correct operation of the chimney in terms of wind exposure, ice formation, rain entering, recirculation etc.

Allowed pipeline length

Air supply duct and flue pipe, including the length of the terminal.

Boiler	Length
Intergas Xclusive 24	100 m
Intergas Xclusive 30	85 m
Intergas Xclusive 36	80 m

Assembly of horizontal air supply duct

- ▶ The air supply can be made in an arbitrary location in the façade.
- ▶ At the location of the supply, make an opening of Ø90 mm.
- ▶ Shorten the air supply duct pipe to the desired length out of the wall.
- ▶ Install the Intergas intake grille and attach this to the pipe.
- ▶ Slide the air supply duct pipe in the opening and cover the opening, if necessary, with a rosette.
- ▶ Install the air supply duct, at the location of the façade terminal, to the exterior at an angle directed outside to prevent rain entering.

Assembly of vertical flue terminal

- ▶ On a steep roof, install a weather slate with scale at the location of the terminal.
On a flat roof, install a weather slate for a double-walled terminal Ø80 mm (diameter Ø96 mm).
- ▶ Slide the double-walled terminal from the outside to the inside through the roof terminal. The terminal must be at least 500 mm above the roof surface.

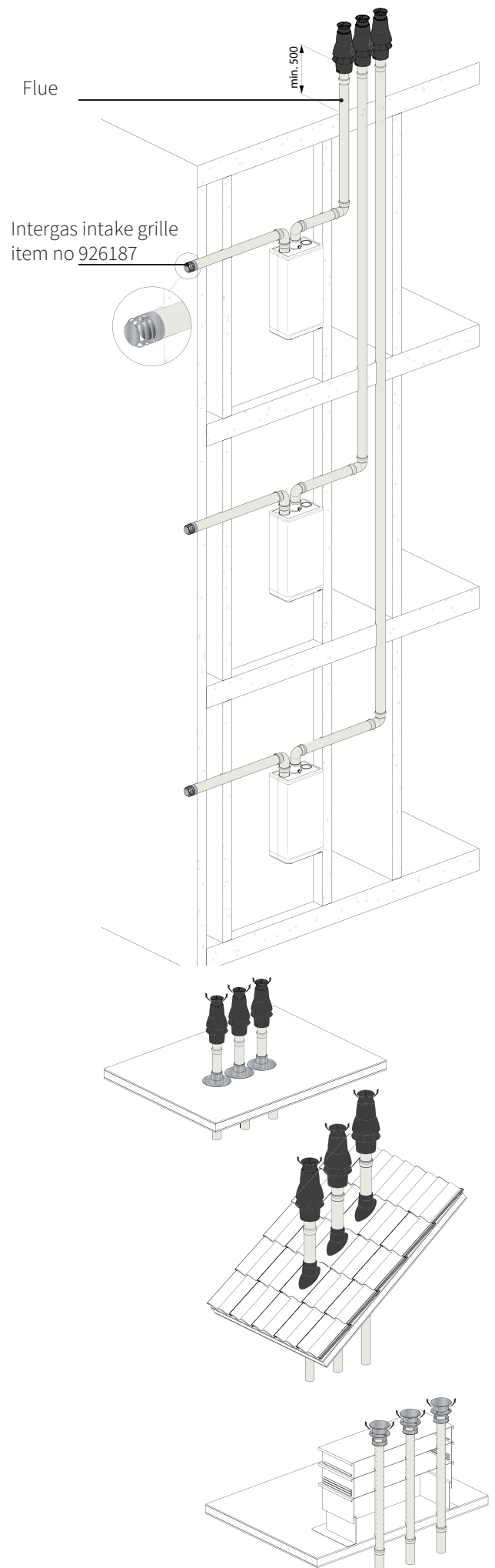

6.8.5 Clamping the flue system (parallel and concentric)



IMPORTANT

- ▶ These regulations are typical for both concentric and parallel flue systems.
- ▶ The flue system must be secured to a solid structure.
- ▶ The flue system should have a continuous fall back to the boiler (min. 0.3°).
- ▶ Only use accompanying brackets.
- ▶ Every elbow must be secured by using the bracket.

Exception at connecting on boiler:

If the length of the pipes before and after the first elbow, are no more than 250 mm, the second element after the first elbow has to contain a bracket.

Note: The bracket must be positioned on or near the elbow!

- ▶ Every extension must be secured per metre with a bracket.
This bracket must not be clamped around the pipe ensuring free movement of the pipe.
- ▶ Make sure bracket is locked into the correct position depending on the position of the bracket on the pipe or elbow:

Fixation bracket on pipe

Fixation bracket on elbow

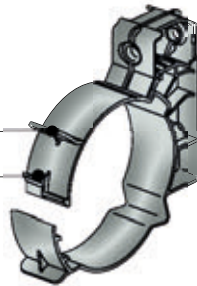

IMPORTANT

- ▶ Do not mix any components, materials or ways of coupling from different manufacturers.

Maximum distance between brackets

Flue system	Orientation	Horizontal/ non-vertical	Vertical
Stainless steel		1000 mm	2000 mm
Safe-PP		1000 mm	2000 mm
Concentric		1000 mm	2000 mm

- ▶ Distribute the length between brackets evenly.
- ▶ Each flue system has to contain at least 1 bracket.
- ▶ The distance between the boiler and the first bracket may not be more than 500 mm.

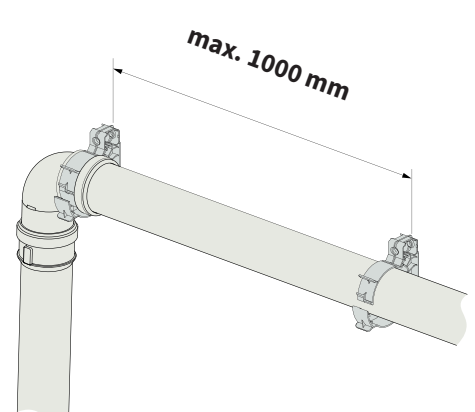
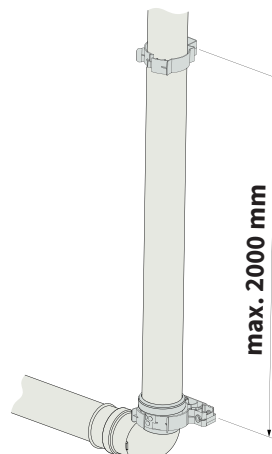
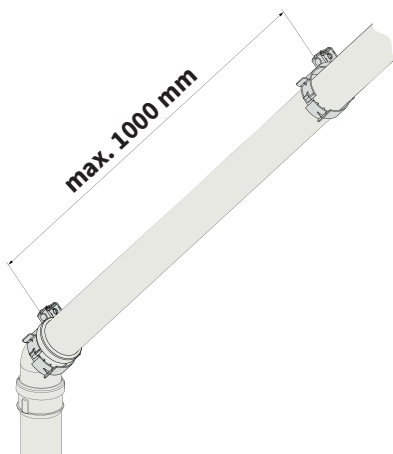



COMMENT

► Shown examples are typical for both parallel and concentric clamping.

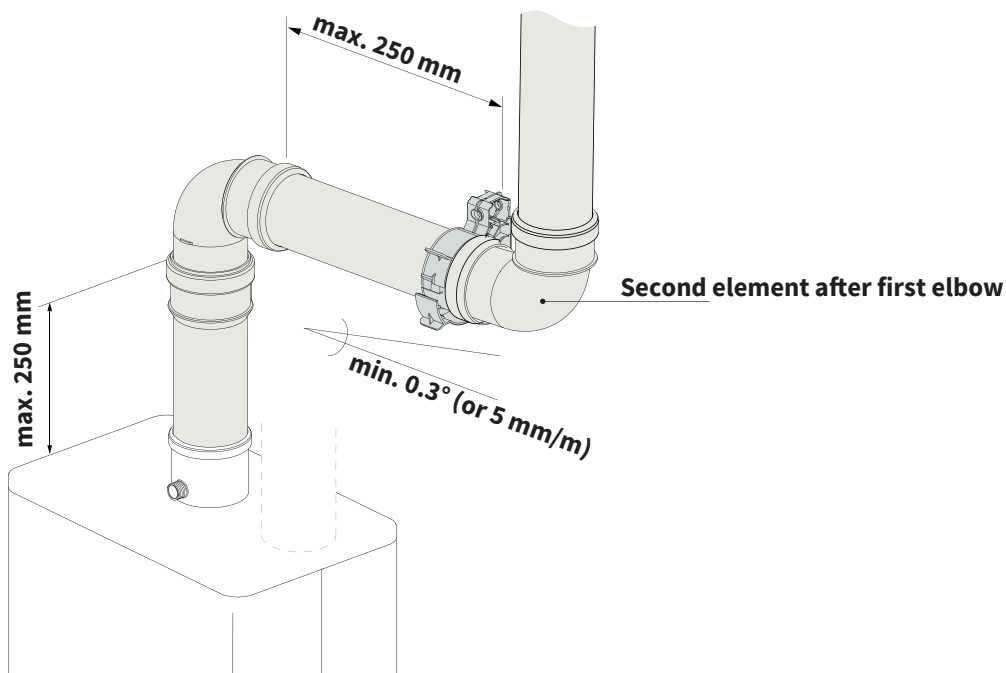
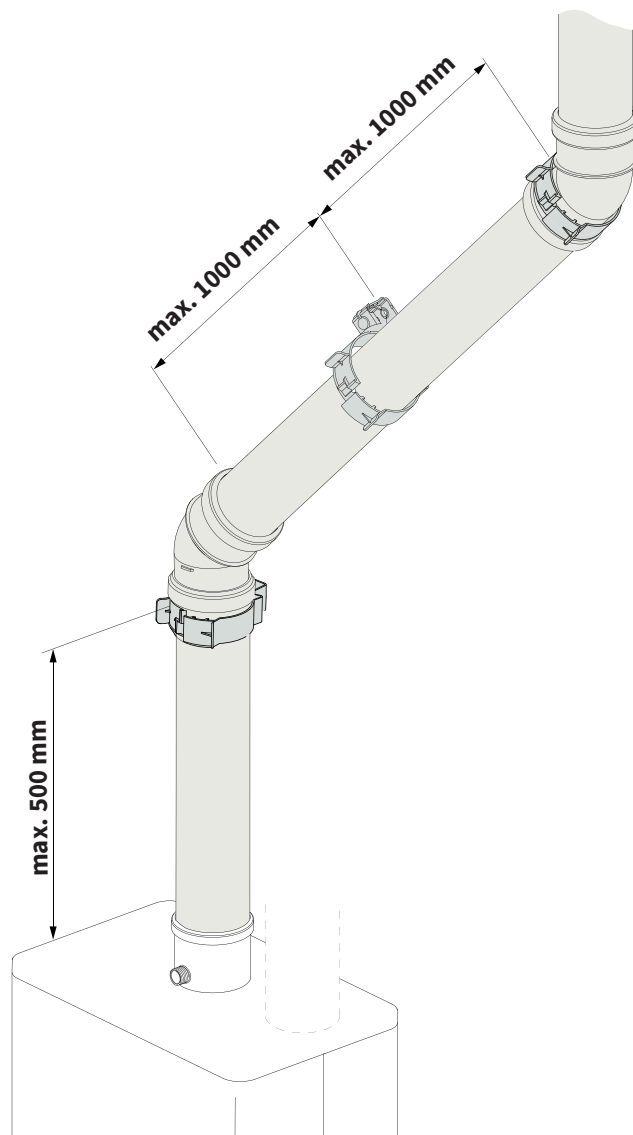
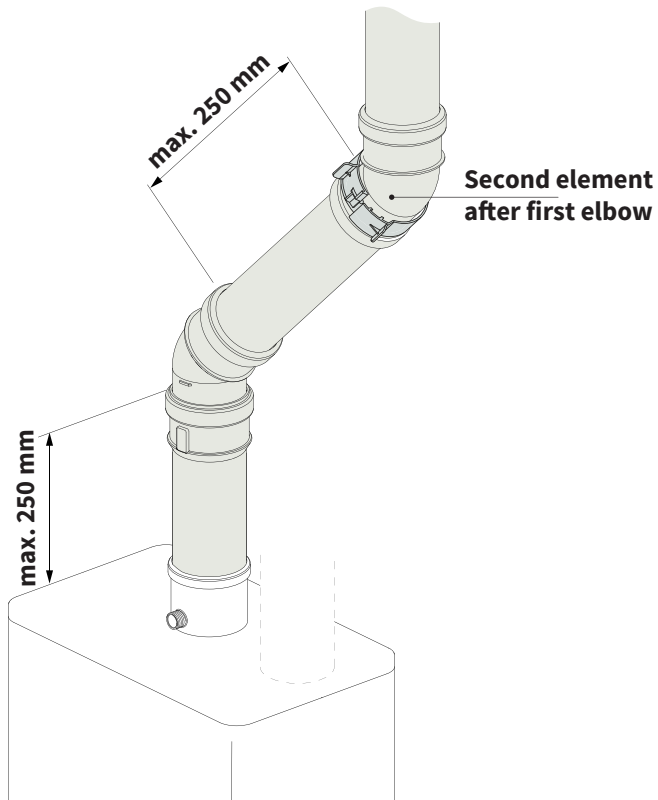

7 OPERATION

7.1 Using the control panel

Tapping

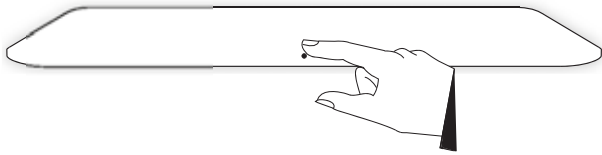

Touching and holding for 2 seconds

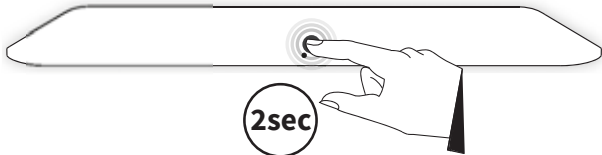

7.2 Preparation activities

7.2.1 Filling and venting central heating system

- ▶ Connect to 3 amp fused spur.
- ▶ Connect the appliance to mains

A **2** may briefly appear on the right display; this means that the connected sensors are being inspected. Then the boiler enters the switched-off setting, characterised by a line **—** on the right display and the central heating system pressure on the left display.



- ▶ **When the central heating pressure is lower than 0.5 bar, this will be shown by a flashing display (if the boiler is in central heating demand) and the capacity will be reduced as a signal function to the resident.**
- ▶ **Below 0.2 bar central heating pressure, central heating demand will no longer be met.**



Central heating pressure is too low.



WARNING

- ▶ **If an additive is added to the central heating water, this must be suitable for the materials used in the boiler, such as copper, brass, steel, stainless steel, plastic and rubber. The additive must preferably have a KIWA-ATA-Atest certification.**

- ▶ Connect the filling loop and fill the installation with clean drinking water to a maximum pressure of 1-2 bar in the case of a cold installation (Indicated on left display.)
- ▶ Bleed the appliance with the manual bleed screw.
- ▶ Bleed the air in the installation with the manual bleed screws on the radiators.
- ▶ Top up the CH installation if the pressure has dropped too far as a result of the air bleeding.
- ▶ Check all couplings for leakage.
- ▶ Switch on the boiler by touching the control panel just above the power LED and holding this for 2 seconds.
- ▶ Put the boiler in operation using the room thermostat or Service company (see **§8.1.5**) and check the operation.

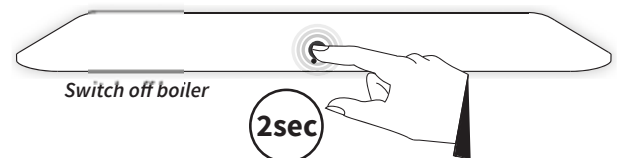
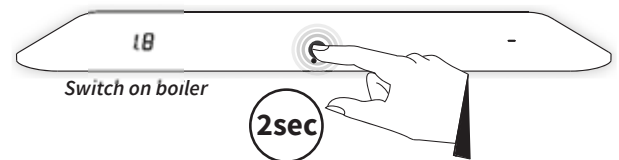
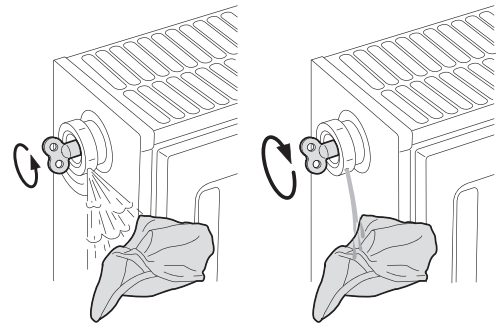
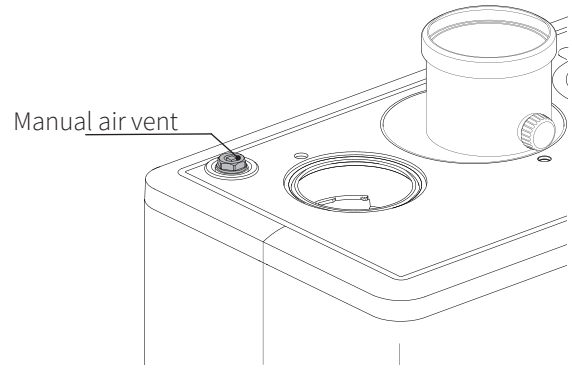

7.2.2 Domestic hot tap water facility

- ▶ Open the mains tap to bring the domestic hot water section under pressure.
- ▶ Vent the exchanger and the piping system by opening a domestic hot water tap. Leave the tap open until all air has disappeared from the system. Close the tap again.
- ▶ Check all connections for leakage.

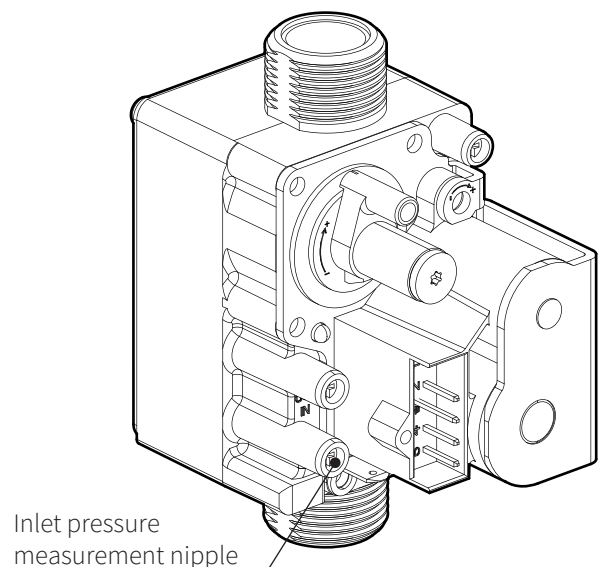

7.2.3 Gas supply

- ▶ Vent the gas piping with the inlet pressure measurement nipple on the gas valve.
- ▶ Check all connections for leakage.
- ▶ Check the inlet pressure and possibly the gas-air control; see **§8.9**.



7.3 Commissioning procedure

After the preparation activities have been performed and completed, the boiler can be commissioned. Follow the following procedure for this:

- ▶ Switch on the boiler by touching just above the power LED and holding this for 2 seconds.
- ▶ Adjust the pump setting depending on the set maximum capacity and the water-sided resistance of the system. Increase the pump pressure and the pressure loss of the boiler; see **§8.6**.
- ▶ Set the temperature of the room thermostat higher than the room temperature. The boiler is now starting central heating demand. Symbols  and  light up.
- ▶ Heat up the system.
- ▶ Check whether the set maximum central heating output is in agreement with the desired value. If necessary, the maximum central heating output can be adjusted; see **§8.3** (parameter **P010**) and **§8.5**.
- ▶ Check whether the set minimum and maximum values of the pump performance have been set correctly; see **§8.3**.
- ▶ Switch off the boiler by touching just above the power LED and holding this for 2 seconds.
- ▶ Vent the system after cooling (top off as needed; see **§7.2.1**).
- ▶ Now switch on the boiler again by touching just above the power LED and holding this for 2 seconds.
- ▶ Check the heating and the domestic hot water facility for correct operation.
- ▶ Instruct the end user about filling and venting and the operation of the heating and the domestic hot water facility.
- ▶ Give the operation instructions and guarantee card 'for customer' to the end user.

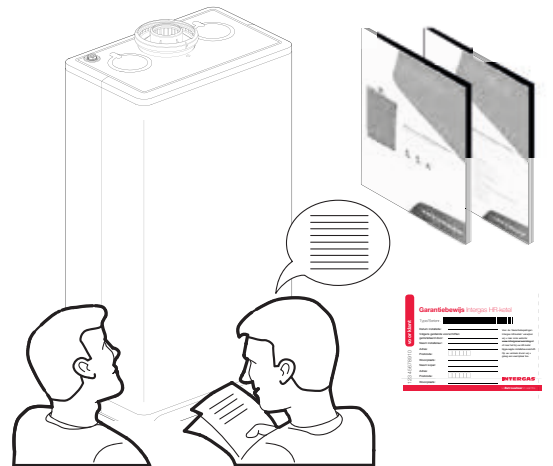
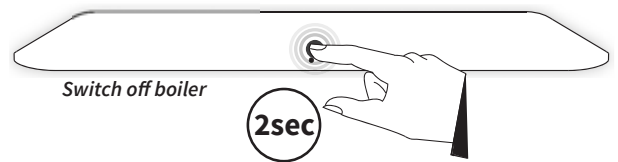
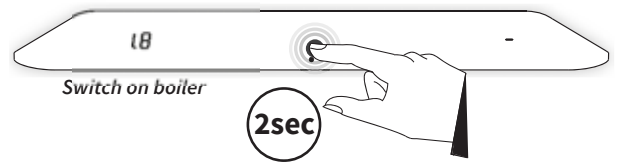

Comments

- ▶ The boiler has a burner controller which ignites the burner, continuously monitors the flame and controls the fan and the modulating pump with each heat demand of the heater or the domestic hot water facility.
- ▶ With each heat demand, the circulation pump runs for heating. The overrun can be set with parameter **P033** (see **§8.3**).
- ▶ The pump automatically runs once per 24 hours for 10 seconds to prevent becoming stuck. The automatic switching on of the pump takes place 24 hours after the last heat demand.
- ▶ The pump does not run for the domestic hot water facility.

7.4 Clock function

The boiler is equipped with a digital clock and offers the possibility to program points in time for both CH operation and DHW operation.

To activate the clock program the following parameters have to be set:

For CH operation parameter **P040** = 1

For DHW operation parameter **P087** = 1

- ▶ In CH operation 6 points can be programmed to switch from CH off or CH on.
- ▶ In DHW operation 4 points can be programmed to switch the pre-heat function of the heat exchanger from on to off. Also the pre-heat behavior of an external boiler can be programmed in this mode.

Additionally the following special modes can be chosen:

In CH operation

▶ **P-on (Program on):**

The boiler will respond only on CH demands within the chosen time blocks. If the clock program does not contain any valid switching points, the boiler will respond on any CH demand. The actual time is shown on the left display indicating that the clock program is active.

▶ **T-on (Temporary on):**

The clock program will be temporary overruled. The boiler will respond to every CH demand until the next "on" switching point. On the left display **t-ON** will be shown.

▶ **On (Continuous on):**

The boiler will respond to every CH demand without any time limit.

▶ **Off:**

The boiler will not respond to any CH demand.

In DHW operation

▶ **P-on (Program on):**

The appliance's DHW comfort function is switched on continuously within the chosen time blocks. In this mode the heat exchanger will be kept on temperature to assure instant delivery of DHW. If the clock program does not contain any valid switching points, the heat exchanger will continuously be kept on temperature.

▶ **On (Continuous on):**

The appliance's DHW comfort function is switched on continuously. The heat exchanger will be kept on temperature.

▶ **Eco:**

The appliance's DHW comfort function is self learning within the chosen time blocks. The appliance will adapt to the pattern of use of the hot water tap. As a result, the temperature of the heat exchanger will not be maintained during the night or in case of long absence. If the clock program does not contain any valid switching points, the self learning feature is maintained.

▶ **Off:**

The temperature of the heat exchanger is not maintained, as a result of which the delivery of hot domestic water takes a little time. If there is no need for fast delivery of domestic hot water, DHW comfort function can be switched off.

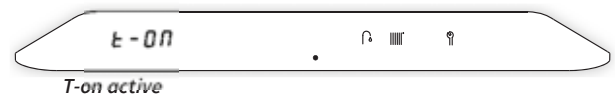
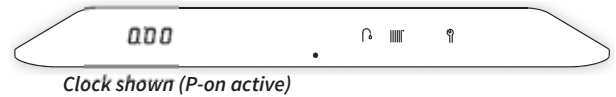

If an external boiler is installed (Parameter P001 = 1)

▶ **P-on (Program on):**

The external boiler will be kept on temperature within the chosen time blocks . If the clock program does not contain any valid switching points, the external boiler will continuously be kept on temperature. The boiler can be heated outside the chosen time blocks by means of an OpenTherm demand or via the Incomfort app.

▶ **On (Continuous on):**

The external boiler will be constantly kept on temperature.

▶ **Eco:**

The external boiler is heated within the chosen time blocks by means of an OpenTherm demand or via the Incomfort app. If the clock program does not contain any valid switching points, all heat demands will be answered.

▶ **Off:**

The external boiler will not be kept on temperature.

Note

For setting and adjusting the clock and timer function see **§8.2**.

7.5 Shutting down the boiler



CAREFUL

▶ **Drain the boiler and the system if the mains voltage has been interrupted and there is a chance of freezing as a result.**

- ▶ Switch off the boiler.
- ▶ Remove the plug from the wall socket.
- ▶ Turn off the gas valve under the boiler.
- ▶ Drain the boiler with the fill/drain tap.
- ▶ Drain the system at the lowest point.
- ▶ Close the mains tap for the water supply of the domestic hot water.
- ▶ Drain the boiler by disconnecting the domestic hot water connections under the boiler.

8 SETTINGS AND ADJUSTMENTS

The functioning of the boiler can be influenced by the various (parameter) settings in the burner controller. Based on a number of specific menus, these settings can be made and modified via the display. Some of the settings are only accessible after entering the installer's code (see §8.1.5 and §8.3).



▶ The boiler has a touch screen control panel. Buttons will light up as soon as they are operable and they will be extinguished when they are no longer available.

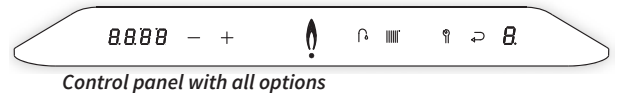

- ▶ **8.8.8.8 :** Left display / Desired temperature in °C / Central heating pressure / Fault code / Time
- ▶ **- :** - (Minus) button
- ▶ **+** : + (Plus) button
- ▶ **🔥 :** In operation (burner is switched on)
- ▶ **● :** Power LED
- ▶ **🔑 :** Tap operation / tap comfort setting / Temperature domestic hot water setting
- ▶ **||||| :** Central heating demand / Adjusting maximum central heating temperature
- ▶ **🔧 :** Service button
- ▶ **↵ :** Enter button
- ▶ **8. :** Right display / operational code

8.1 Structure of the settings

The structure of the settings is built up from various menus that are accessible via certain buttons (of button combinations). The following menus are available:

- ▶ **Main menu**
Higherlevel menu from which all other menus are accessible.
- ▶ **Domestic hot water menu**
Menu in which several domestic hot water-related settings can be set and/or modified.
- ▶ **Central heating menu**
Menu in which several central heating-related settings can be set and/or modified.
- ▶ **RF menu**
Menu in which RF room thermostats can be assigned to the boiler.
- ▶ **Service menu**
Menu in which the test programs can be activated and from which the (installer's) parameters can be modified (installer's code required).

8.1.1 Main menu

The main menu is accessible by tapping just above the power LED. The main menu can be requested in a boiler that is switched on as well as one that is switched off. If no button is used in the main menu for 1 minute, the display returns to the initial setting.

The following buttons will light up:

- ▶ The domestic hot water symbol 🔑
- ▶ The central heating symbol |||||
- ▶ The Service symbol 🔧

Also, on the left display the clock time is shown.

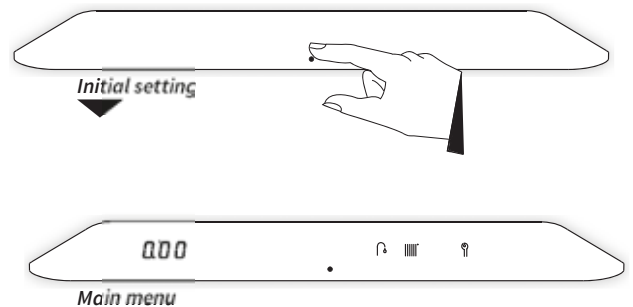

8.1.2 Domestic hot water menu

The domestic hot water menu has 2 settings and is accessible by tapping on the Domestic Hot Water symbol  from the main menu.



Via the domestic hot water menu:

- ▶ the domestic hot water temperature can be modified
- ▶ the DHW comfort function can be modified



The following buttons will light up:

- ▶ The Minus symbol $-$
- ▶ The Plus symbol $+$
- ▶ The Enter symbol 

The Central Heating symbol  will be extinguished.

The left display will light up and will display the current domestic hot water temperature by tapping on the Domestic Hot Water symbol . By tapping again on the Domestic Hot Water symbol , it alternates between 'modify domestic hot water temperature' and 'modify DHW comfort function'.



To modify the domestic hot water temperature:

1. Tap the Domestic Hot Water button . The set temperature is shown on the left display.
2. Using the Plus $+$ and Minus $-$ buttons, set the desired temperature (for example, 60°C).
3. Tap the Enter button  to confirm (or wait 30 seconds).
A **P** appears on the right display (all other buttons are extinguished), which means the setting has been stored.
4. The display returns to the main menu.

For the quick supply of domestic hot water, a DHW comfort function has been built in. This has the following settings:

- ▶ **P-On:**
The DHW comfort function is switched on within the chosen time blocks. The heat exchanger will maintain temperature during these time blocks.
- ▶ **On:**
The DHW comfort function is continuously switched on. The boiler always supplies domestic hot water immediately.
- ▶ **Eco:**
The DHW comfort function of the boiler is self learning. The boiler will adapt itself to the pattern of use of domestic hot water. This means that the heat exchanger will not maintain temperature during the night or with long absences.
- ▶ **Off:**
The heat exchanger is not kept warm, as a result of which the supply of domestic hot water is somewhat delayed. If there is no need for a quick supply of domestic hot water, the DHW comfort function can be switched off.

To modify the DHW comfort function:

1. Tap the Domestic Hot Water button 2x . The set tap comfort setting is shown on the left display.
2. Using the Plus $+$ and Minus $-$ buttons, set the desired tap comfort setting (for example, P-On).
3. Tap the Enter button  to confirm (or wait 30 seconds).
A **P** appears on the right display (all other buttons are extinguished), which means the setting has been stored.
4. The display returns to the main menu.

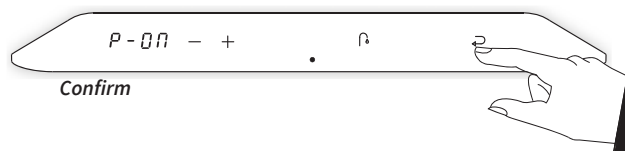
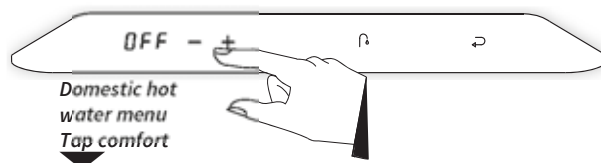
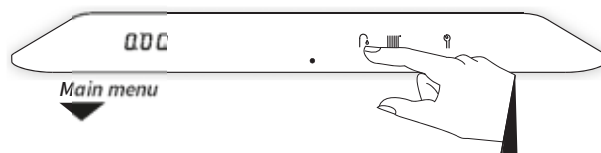
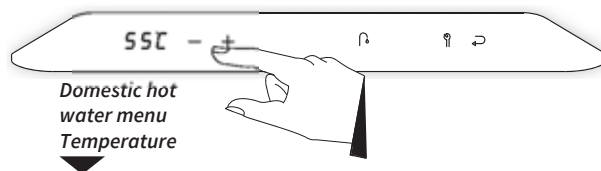
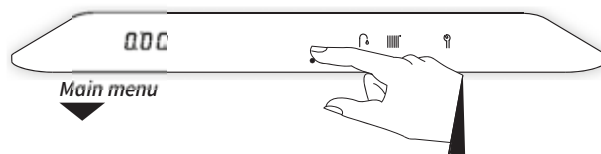





8.1.3 Central heating menu

The central heating menu has 3 settings and is accessible by tapping on the Central Heating symbol  from the main menu. Via the central heating menu:





- ▶ the maximum temperature of the central heating water can be modified
- ▶ access to the RF menu can be obtained
- ▶ the timer function can be set

The following buttons will light up:

- ▶ The Minus symbol 
- ▶ The Plus symbol 
- ▶ The Enter symbol 

The Domestic Hot Water symbol  will be extinguished. The left display will light up and the current temperature of the central heating water will be displayed.

To modify the temperature of the central heating water:

1. Tap the Central Heating button . The set temperature of the central heating water is shown on the left display.
2. Using the Plus  and Minus  buttons, set the desired temperature (for example, 55°C).
3. Tap the Enter button  to confirm (or wait 30 seconds). A **P** appears on the right display (all other buttons are extinguished), which means the setting has been stored.
4. The display returns to the main menu.

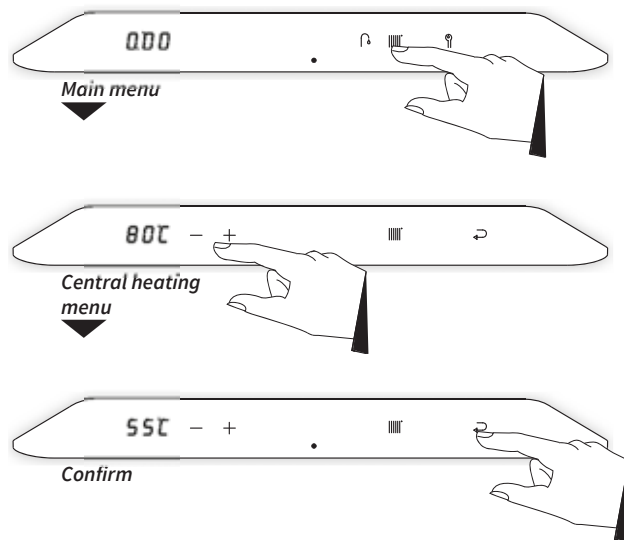

8.1.4 RF menu



The Xclusive is standardly provided with a built-in transmitting/receiving module, which makes the boiler suitable for wireless communication with the Honeywell room thermostats T87RF2025 Round RF and CMS927.

Assignment of the thermostat and additional settings can be made via the RF menu.

The RF menu is accessible by touching the Central Heating symbol  and holding it for 2 seconds. The following settings can then be made:

- ▶ Assign RF thermostat
- ▶ Remove assignment between boiler and RF thermostat

The following buttons will light up:

- ▶ The Service symbol 
- ▶ The Enter symbol 

The left display will light up and, depending on the assignment of the boiler, will show 'RF1-' or 'RF1'.

RF1-:

Boiler and thermostat are not assigned.



RF1:

Boiler and thermostat are assigned.

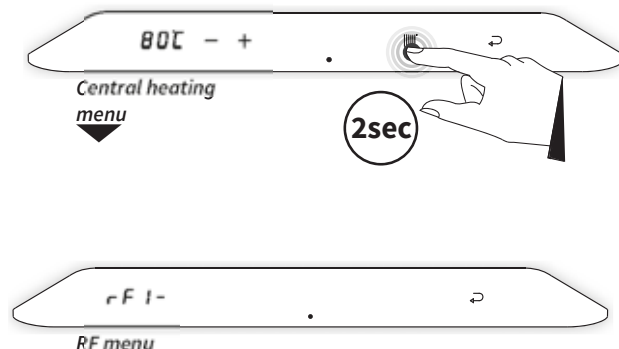
Tap the Enter button  (or wait 1 minute) to save and return to the main menu. By tapping just above the power LED, the display returns to the initial setting and no settings are saved.



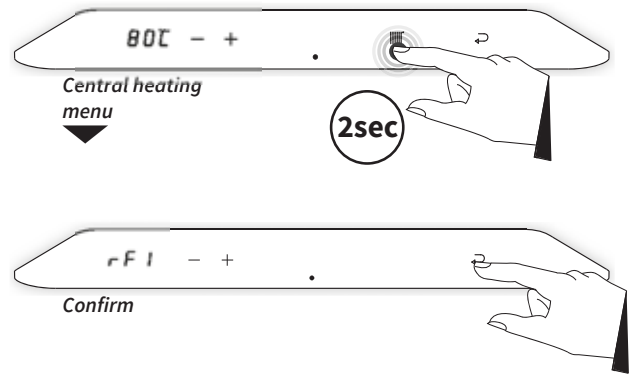

To modify an RF room thermostat:

1. Touch the Central Heating symbol  and hold for 2 seconds.
2. The method of assignment is dependent on the type of room thermostat and is described in the installation manual and operation instructions of the wireless room thermostat.
3. After a successful assignment, 'RF1' appears in the left display. Tap the Enter symbol  to save.



To remove an assignment:

1. Touch the Central Heating symbol  and hold for 2 seconds.
2. 'RF1' appears in the left display.
3. Tap the Service  button to remove the assignment.
4. 'RF1-' appears in the left display.
5. Tap the Enter symbol  to confirm the removal and return to the main menu.
6. Make a new assignment if desired.

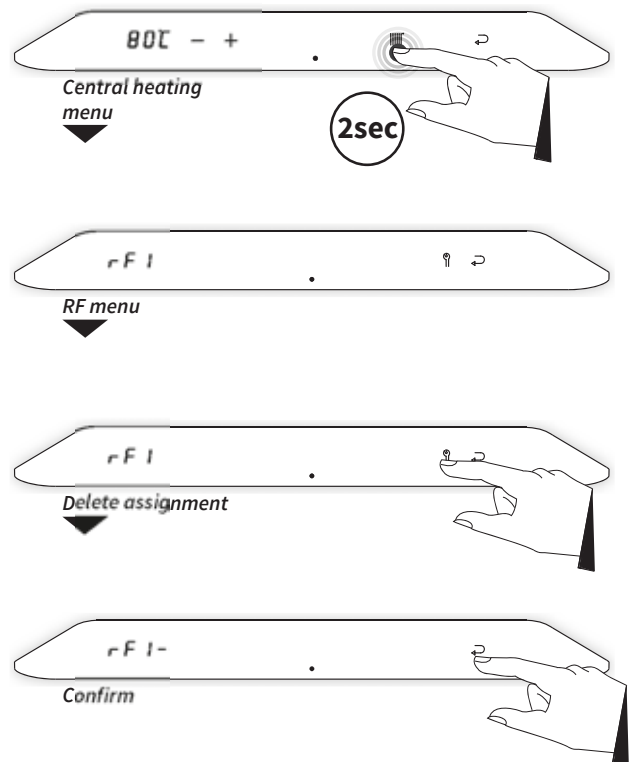

8.1.5 Service menu



The service menu is accessible by touching the Service button  from the menu and holding it for 2 seconds.

Via the service menu:

- ▶ the test programs can be activated
- ▶ access to the (installer's) parameters can be obtained

The following buttons will light up:

- ▶ The Minus symbol —
- ▶ The Plus symbol +
- ▶ The Enter symbol ↻

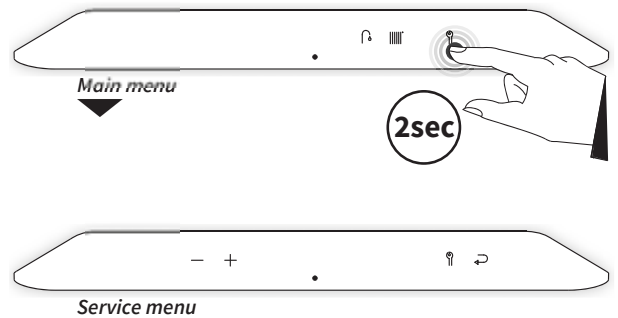

The Domestic Hot Water symbol  and the Central Heating symbol  will be extinguished.





Test programs

A feature has been installed in the burner controller to bring the boiler in a test mode. By activating a test program, the boiler will operate with a fixed fan speed without the control functions intervening. However, the safety functions remain active.

The following test programs are available:



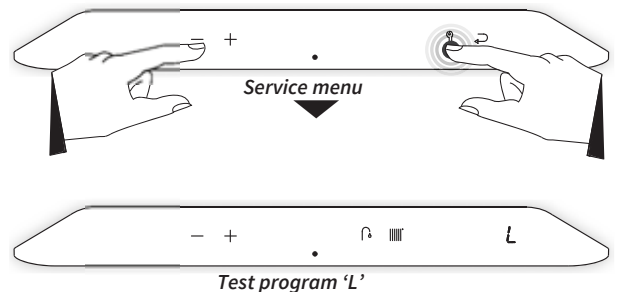

<p>Program 'L' Burner on with minimum DHW capacity. Button combination  and —</p>
<p>Program 'h' Burner on with set maximum central heating output. Button combination  and +</p>
<p>Program 'H' Burner on with maximum capacity. Button combination  and 2x +</p>
<p>Switching off test program Button combination + and —</p>

To activate the 'L' test program:

1. Hold the Service button  and at the same time tap the Minus button —. The Service button  and the Enter button  will be extinguished. An 'L' will appear on the right display.
2. Tap the Minus button — and the Plus button + at the same time to terminate the program.



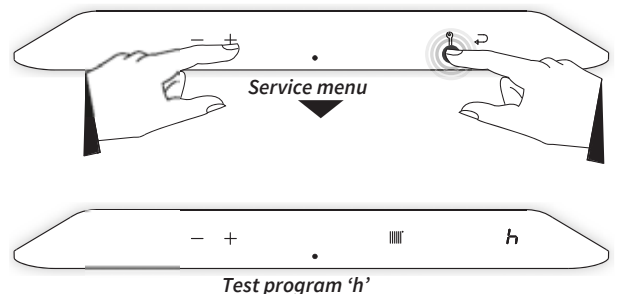

To activate the 'h' test program:

1. Hold the Service button  and at the same time tap the Plus button +. The Service button , the Enter button  and the Domestic Hot Water button  will be extinguished. An 'h' will appear on the right display.
2. Tap the Minus button — and the Plus button + at the same time to terminate the program.



To activate the 'H' test program:

1. Hold the Service button  and at the same time tap the Plus button 2x +. The Service button , the Enter button  will be extinguished. An 'H' will appear on the right display.
2. Tap the Minus button — and the Plus button + at the same time to terminate the program.

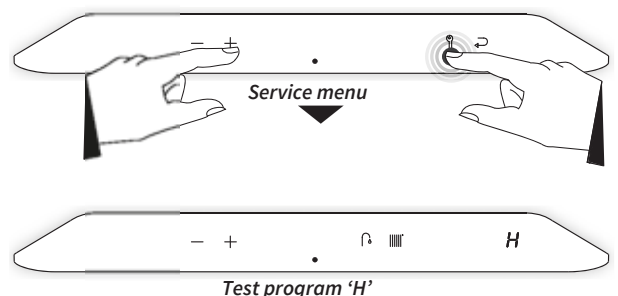

(Installer's) parameters













The (installer's) parameters of the burner controller are factory-set according to the table in **§8.3**.

These parameters can only be modified using the installer's code.

The installer's code is shown on the left display and is preceded by the letter **C**.

The parameters are also shown on the left display and are preceded by the letter **P**.

To modify a parameter: (for example, modify parameter P031 from 80 to 90)

1. Tap the Service button  and the Enter button  **at the same time**. The Enter button  is extinguished and all other buttons remain on. 'C000' appears in the left display.
2. Using the Plus button  and the Minus button , set the installer's code (**C015**) and tap on the Service button . Parameter 'P001' will now be shown on the left display.
3. Using the Plus button  and the Minus button , set the desired parameter (in this example, 'P031') and tap on the Service button . The current value of the relevant parameter will be shown on the left display (in this example, '80').
4. Using the Plus button  and the Minus button , set the desired value of the parameter (in this example, '90').
5. Tap the Service button . Repeat Steps 3 and 4 to set any additional parameters.
6. Tap the Enter button  to confirm. A **P** appears on the right display (all other buttons are extinguished), which means the settings have been stored.
7. The display returns to the initial setting and is ready for any heat demand.





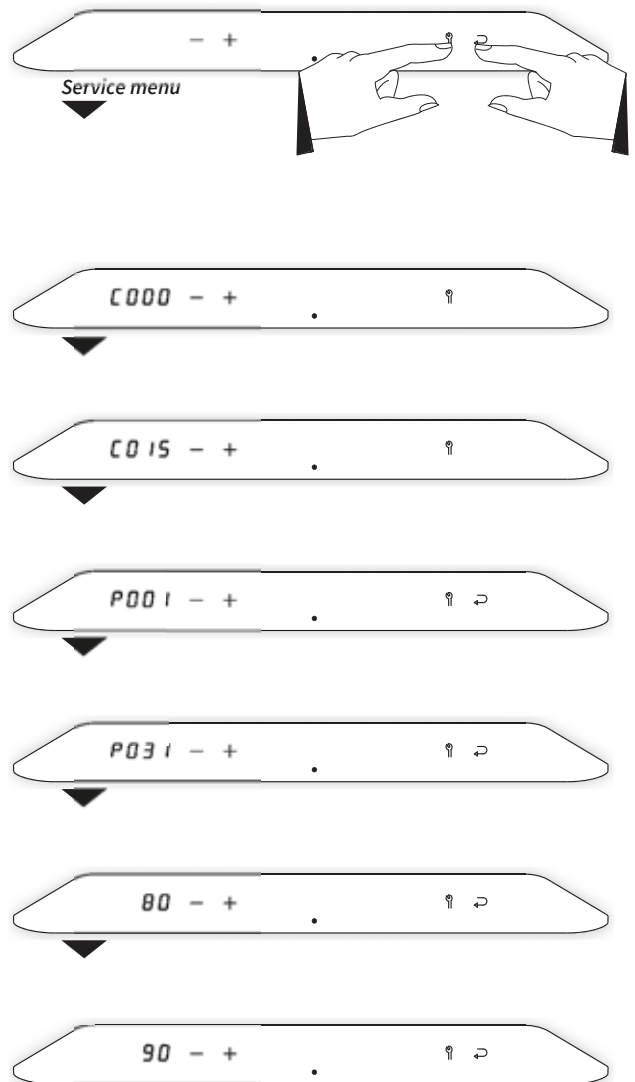

By tapping just above the power LED during a parameter modification, the modification procedure is ended without the parameter modification being saved. The display returns to the initial setting and is ready for any heat demand.







8.2 Setting and adjusting the clock functions

Show actual time







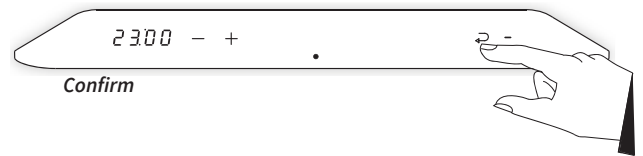
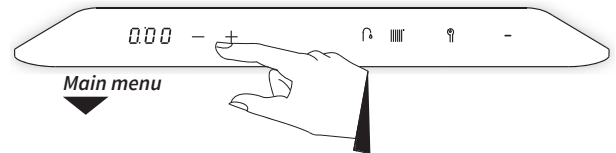
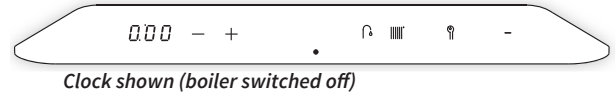
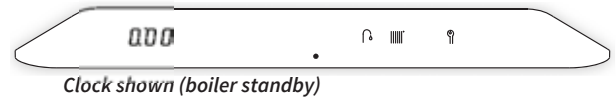











- ▶ From a boiler that is in standby or in operational mode tap just above the power LED to access the main menu (also see §8.1.1). The actual time is shown in the left display. The symbols ,  and  also light up.
- ▶ If the boiler is switched off when accessing the main menu the symbols  and  will light up as well.

Setting the clock

- ▶ Check if the boiler is switched off or otherwise switch it off by touching just above the power LED and holding this for 2 seconds.
 - ▶ Tap just above the power LED to access the main menu. Adjust the clock to the correct time by pressing the  and  buttons.
- Note: Holding the button for more than 1 second will make the clock run fast.
- ▶ Tap the Enter  button to confirm.
- Note: By tapping just above the power LED instead of the Enter  button the display returns to the main menu without saving any changes.



8.2.1 Setting the clock program on CH operation

- ▶ From a boiler that is in standby or in operational mode tap just above the power LED to access the main menu. The symbols ,  and  light up.
 - ▶ Tap on the Central Heating  button.
 - ▶ Tap on the Service  button.
 - ▶ The symbols , ,  and  are shown. Also the first switching period "t1" appears on the left display.
 - ▶ Tapping the  and  buttons will change between the 6 different on/off switching periods.
 - ▶ Choose a switching period (for instance "t1") and tap on the Central Heating  button.
 - ▶ Tap on the  and  buttons to set the time and tap the Central Heating button again to set the desired action by tapping the  and  buttons.
- The actions to be set are as follows:
- ▶ **On:** Start of period CH on. From this switching point requests for heat demands will be answered.
 - ▶ **Off:** End of period CH off. From this switching point requests for heat demands will not be answered.
 - ▶ **- :** No action. This switching point will have no effect on requests for heat demands.
- ▶ Tap on the Central Heating  button to select the next switching period. Set the switching time and the corresponding action and repeat this, if needed, for all 6 switching periods.
 - ▶ Tap the Enter  button to confirm. The switching times and actions will be saved in the boiler controller. After 2 minutes of inactivity changes made will also be saved. A **P** appears in the right display and the display returns to the Central Heating menu.
- Note: By tapping just above the power LED instead of the Enter  button the display returns to the Central Heating menu without storing any changes.

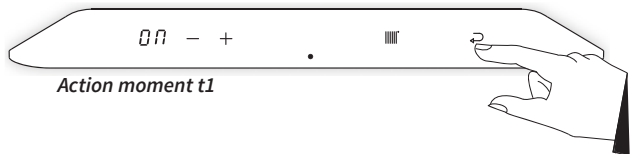
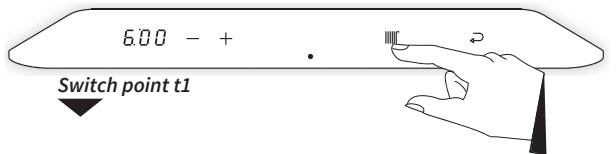
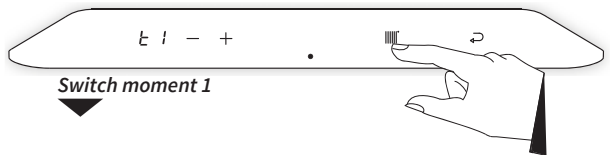
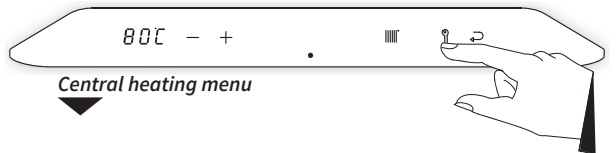
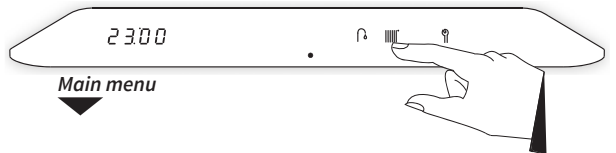

Note

- ▶ Switching points and actions may be set in random order. There is no need to set times and actions chronologically.

To apply the clock program

- ▶ From a boiler that is in standby or in operational mode tap just above the power LED to access the main menu (also see §8.1.1).
- ▶ Tap on the Central Heating button. The current temperature of the central heating water is displayed in the left display. Tap the Central Heating button again to switch to the clock program setting.
- ▶ Using the Plus + and Minus - buttons, set the desired program setting (P-on, T-on, On or Off).
- ▶ Tap the Enter button to confirm. The chosen program setting will be saved in the boiler controller. After 2 minutes of inactivity changes made will also be saved.

A **P** appears in the right display and the display returns to the Central Heating menu.

Note: By tapping just above the power LED instead of the Enter button the display returns to the Central Heating menu without storing any changes.

8.2.2 Setting the clock program on DHW operation

- ▶ From a boiler that is in standby or in operational mode tap just above the power LED to access the main menu. The symbols \mathcal{D} , \mathcal{H} and \mathcal{I} light up.
- ▶ Tap the Domestic Hot Water button \mathcal{D} . The set temperature is shown on the left display. Tap the Domestic Hot Water button \mathcal{D} again to switch to the clock program setting.
- ▶ Tap on the Service button \mathcal{I} .
- ▶ The symbols -, +, \mathcal{D} and \mathcal{E} are shown. Also the first switching period "t1" appears on the left display.
- ▶ Tapping the + and - buttons will change between the 4 different on/off switching periods.
- ▶ Choose a switching period (for instance "t1") and tap on the Domestic Hot Water button \mathcal{D} .
- ▶ Tap on the + and - buttons to set the time and tap the Domestic Hot Water button \mathcal{D} again to set the desired action by tapping the + and - buttons.

The actions to be set are as follows:



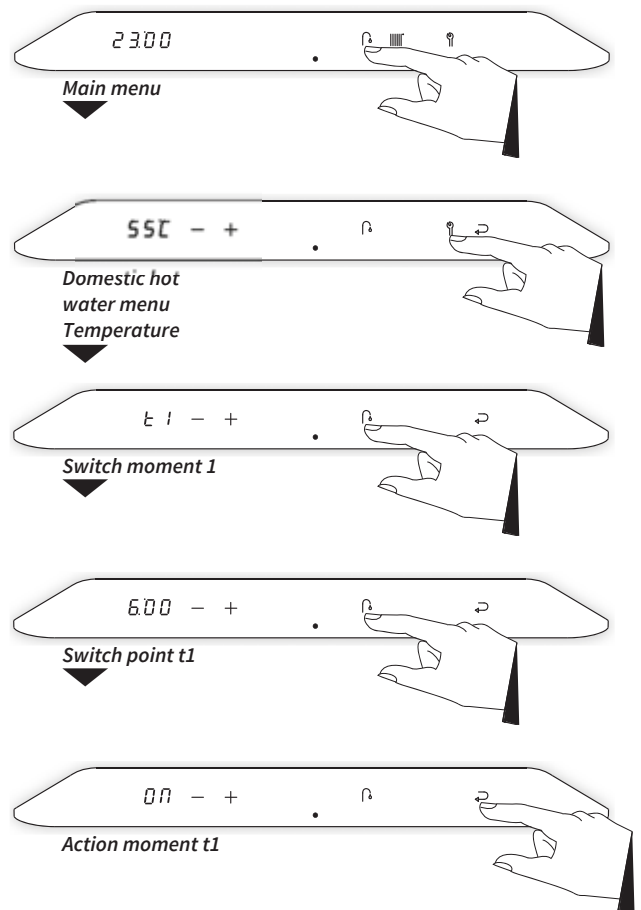

- ▶ **On:** Start of period DHW on. From this switching point the heat exchanger will be kept on temperature.
- ▶ **Off:** End of period DHW off. From this switching point the heat exchanger will not be kept on temperature.
- ▶ **- :** No action. This switching point will have no effect on maintaining the heat exchanger's temperature.
- ▶ Tap on the Domestic Hot Water button \mathcal{D} to select the next switching period. Set the switching time and the corresponding action and repeat this, if needed, for all 4 switching periods.
- ▶ Tap the Enter button to confirm. The switching times and actions will be saved in the boiler controller. After 2 minutes of inactivity changes made will also be saved.

A **P** appears in the right display and the display returns to the Central Heating menu.

Note: By tapping just above the power LED instead of the Enter button the display returns to the Central Heating menu without storing any changes.



To apply the clock program

- ▶ From a boiler that is in standby or in operational mode tap just above the power LED to access the main menu (also see **§8.1.1**).
- ▶ Tap on the Domestic Hot Water button . The current temperature of the central heating water is displayed in the left display. Tap the Domestic Hot Water button  again to switch to the clock program setting.
- ▶ Using the Plus  and Minus  buttons, set the desired program setting (P-on, On, Eco or Off).
- ▶ Tap the Enter  button to confirm. The chosen program setting will be saved in the boiler controller. After 2 minutes of inactivity changes made will also be saved. A **P** appears in the right display and the display returns to the Central Heating menu.

Note: By tapping just above the power LED instead of the Enter  button the display returns to the Domestic Hot Water menu without storing any changes.

8.3 Parameters

Parameter	Setting	Set value	Description/Setting range
P001	System type	0	0 = Xclusive Kombi 1 = Xclusive Solo + Cylinder 2 = Xclusive DHW 3 = Xclusive System boiler
P010	Set maximum central heating output	75 ----- 100	75 = Xclusive 36 100 = Xclusive 24 / Xclusive 30 25% to 100% (see §8.5)
P030	Central heating pump setting	0	0 = overrun active 1 = continuous ¹
P031	Maximum capacity of modulating central heating pump	65	Set value of parameter P032 to 100%
P032	Minimum capacity of modulating central heating pump	35	15% to set value of parameter P031
P033	Central heating pump overrun after central heating demand	1	0 to 15 minutes
P034	Central heating pump overrun after boiler operation	1	0 to 15 minutes (n/a for Kombi boiler)
P035	Step modulation	1	0 = off 1 = on
P036	Anti-pendulum time central heating	5	Minimum switch-off time for boiler water temperature 0 to 15 minutes
P040	Activate clock program CH operation	0	0 = inactive 1 = active
P057	Response of OpenTherm room thermostat	1	0 = do not respond to heat demand if requested temperature is lower than 30°C 1 = respond to heat demand with minimum flow temperature limited at 30°C 2 = respond to heat demand with maximum set flow temperature (on/off function)
P059	Maximum setting value of flow temperature	80	10°C to 90°C
P070	Set maximum DHW capacity	100	20% to 100%
P074	Number ECO days	7	0 to 10 days
P075	Control temperature during boiler operation	80	60°C to 90°C
P077	Waiting time central heating demand after DHW operation	0	0 to 15 minutes
P081	Setting of three-way valve or electric shut-off valve	0	0 = powered during central heating demand 1 = powered during DHW operation
P087	Activate clock program DHW operation	0	0 = inactive 1 = active

¹ DHW comfort function off.

8.4 Switching DHW comfort function on and off

It is possible to switch on and off the DHW comfort function from an OpenTherm room thermostat (provided the thermostat supports this function). To do this, the boiler must be set at the 'eco' setting and the parameter **P074** must be set to 0. The self-learning character of the control is therefore switched off.

8.5 Adjusting maximum central heating output

The maximum central heating output is factory-set. If more or less output is needed for the central heating system, the maximum central heating output can be modified with parameter **P010**. See the table below:
Setting central heating output.

P010	Desired central heating output in kW (approx.)			Minimum flow quantity (l/h)		
	Xclusive					
	24	30	36	24	30	36
100	13,8	19,4	25,7	396	557	738
75	10,6	14,6	19,3	304	419	553
50	7,3	9,8	12,8	210	281	369
35	5,4	7,0	9,0	155	201	258
25	-	5,1	6,4	-	146	184

Note:

The output during combustion will be slowly increased and decreased as soon as the set flow temperature is achieved (modulation on T_{flow}).

8.6 Adjusting pump capacity

The Xclusive has a modulating pump that modulates that modulates based on the central heating output provided. The minimum and maximum capacity of the pump can be adjusted with the parameters **P031** and **P032**. Also see **§8.3**.

The set value of parameter **P031** (max. pump setting) is the percentage of the maximum pump capacity and is linked to the set maximum central heating output which is set with parameter **P010**.

The set value of parameter **P032** (min. pump setting) is linked to the minimum central heating output.

The pump capacity must be set such that the temperature difference between the supply and return fits with the system.

If the central heating load modulates between the minimum and maximum value, the pump capacity will modulate along proportionately.

Pressure loss graph boiler central heating side

- A. Xclusive 24
- B. Xclusive 30
- C. Xclusive 36

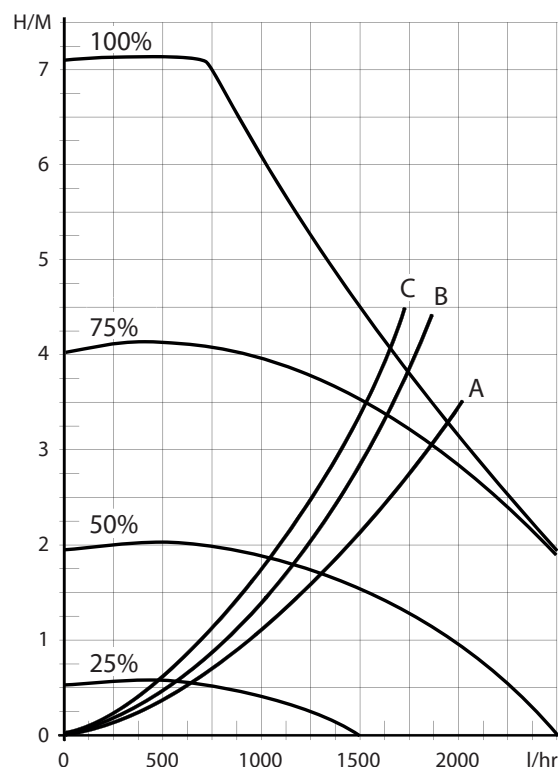

8.7 Weather-dependent control

When an outdoor sensor is connected, the flow temperature will be automatically controlled according to the set heating line, depending on the outside temperature.

The weather-dependent control functions solely with an on/off room thermostat. When using an OpenTherm room thermostat, the outside temperature will be relayed, but the heating line of the central heating boiler will not be active.

Heating line

X: T outside in °C

Y: T flow in °C

A. Factory setting

($T_{\max \text{ CH}} = 80^{\circ}\text{C}$, $T_{\min \text{ CH}} = 25^{\circ}\text{C}$, $T_{\min \text{ out}} = -9^{\circ}\text{C}$, $T_{\max \text{ out}} = 25^{\circ}\text{C}$)

B. Example

($T_{\max \text{ CH}} = 60^{\circ}\text{C}$, $T_{\min \text{ CH}} = 25^{\circ}\text{C}$, $T_{\min \text{ out}} = -9^{\circ}\text{C}$, $T_{\max \text{ out}} = 25^{\circ}\text{C}$)

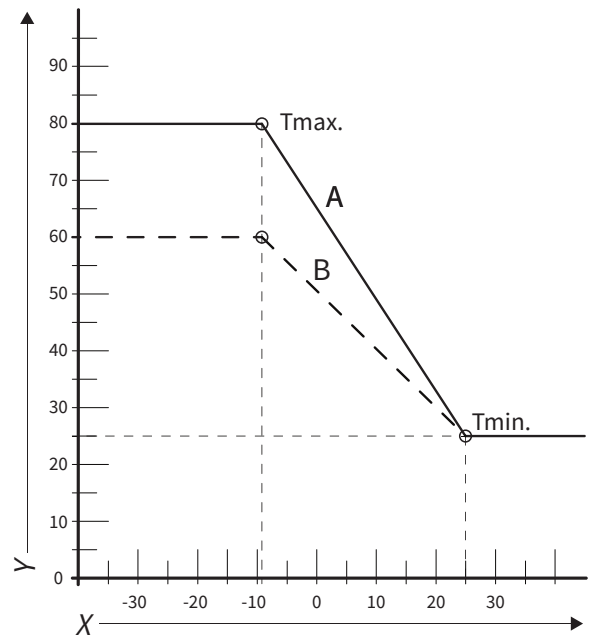

8.8 Conversion to another gas type



CAREFUL

- ▶ Only qualified competent gas safe registered engineers may work on the boiler.

If the boiler is connected to another gas type than that for which the boiler has been set by the manufacturer, the gas restriction ring must be replaced. Conversion sets for other gas types are available to order.

Conversion of the restriction ring

- ▶ Switch off the boiler and remove the plug from the wall outlet.
- ▶ Close the gas valve.
- ▶ Remove the front panel of the boiler.
- ▶ Disconnect the connection above the gas valve and turn the gas mixing pipe to the back.
- ▶ Replace the O-ring and the gas restriction ring with the rings from the conversion set.
- ▶ Reconstruct it in reverse order.
- ▶ Open the gas valve.
- ▶ Check the gas connections before the gas valve for tightness.
- ▶ Put the plug in the wall outlet and switch on the boiler.
- ▶ Check the gas connections after the gas valve for tightness (during operation).
- ▶ Now check the adjustment of the gas/air proportion (see **§8.10**).
- ▶ Place a sticker indicating the newly set gas type over the existing sticker near the gas valve.
- ▶ Stick the same sticker near the data plate.
- ▶ Assemble the front panel of the boiler.

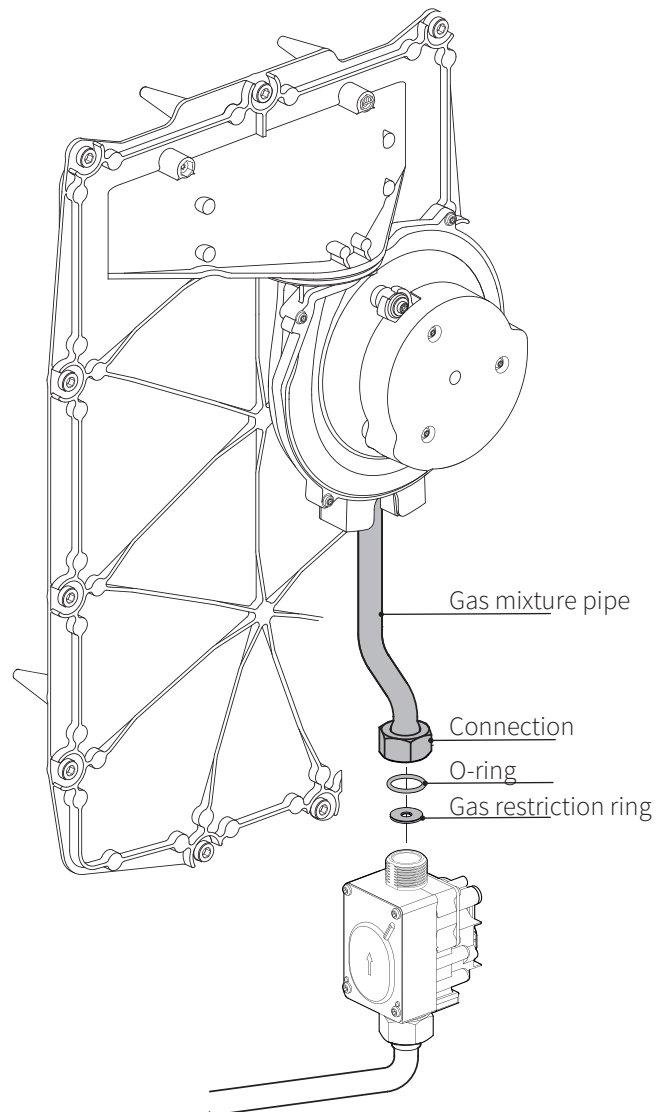

8.9 Gas/air control



IMPORTANT

- ▶ **Work on gas supply pipe components as well as the adjustment of the gas air control must be performed by an authorised installer.**

The gas/air control is set in the factory such that the combustion is optimal for the gas type used. The gas type (natural gas or LPG) for which the boiler is adjusted is indicated on the data plate under the boiler. The boiler may not be implemented if the gas used deviates from that which is indicated on the data plate. The boiler may optionally be converted to another gas type using a conversion set. For the correct gas restriction ring, see the table below.

Table 1: Gas restriction rings

Boiler type Xclusive	Insert number	Gas category	
		Natural gas G20 20 mbar	LPG G31 30 & 50 mbar
		Gas restriction ring number	
24	528	392	315
30	500	450	370
36	500	450	370

By default, the boiler is set to natural gas G20.

A proper operation of the gas air control can be established by measuring the flue gases directly above the boiler using an analyser probe of a flue gas analyser. The measurement takes place at high and minimum output (for this, see **§8.10.1** and **§8.10.2**). Any deviation can be corrected solely at minimum output by setting the gas valve anew (see **§8.10.3**).



IMPORTANT

- ▶ **Inspection of the gas/air control must be done with opened casing.**
- ▶ **The measurement must be performed based on O₂; in other words, the flue gas analyser must have an O₂ sensor. Conversion of the measured O₂ measurement value in the flue gas analyser to a CO₂ measurement value is allowed.**
- ▶ **The deviation of the flue gas analyser may be a maximum of ± 0.3% (based on O₂).**
- ▶ **A reliable check and adjustment is only safeguarded if no eXclusive vacuum is present in the flue connection opposite the installation location. This also includes a natural draught (wind), for example.**
- ▶ **A deviation at maximum output cannot be corrected by adjusting the gas valve. In that case, the boiler must be meticulously inspected for gas density and correctness of components used (especially the gas restriction ring and the fan including venturi).**
- ▶ **When replacing components and/or converting to another gas type, the operation of the gas air control must always be inspected.**

8.10 Inspection of gas air control

8.10.1 Measuring flue gas at maximum output

A. Switch off the boiler.

A line \rightarrow will appear on the right display and the central heating pressure will be visible on the left display.

B. Remove the front panel of the boiler by unscrewing the 2 attachment screws (1) and then removing the panel forward (2).

C. Remove the cap of the flue gas measurement point (3) on the flue adapter above the boiler.

D. Place the analyser probe of the flue gas analyser in the flue gas measurement point.



IMPORTANT

- ▶ **Make sure that the flue gas analyser is calibrated. The start-up procedure of the flue gas analyser must be completed before the analyser probe is placed in the flue gas measurement point.**
- ▶ **The analyser probe must completely seal off the flue gas measurement point to provide a reliable measurement.**
- ▶ **The end of the analyser probe must be located entirely in the flue gases (middle of the flue gas pipe).**

E. Switch on the boiler.

F. Switch on the boiler to maximum output. To do this, hold the Service button ⌵ and at the same time tap the Plus button $2x+$ until the capital letter **H** appears on the right display.

G. Wait until the readout of the flue gas analyser is stable (at least 3 minutes).



IMPORTANT

- ▶ **Make sure that the capital letter **H** appears on the right display. This provides assurance that the boiler is operating as maximum load.**

H. Note the measured $O_2(H)$ or $CO_2(H)$ value.

$O_2(H)$... = measured maximum output O_2 value

$CO_2(H)$... = measured maximum output CO_2 value

I. Check according to Table 2a or Table 2b whether the measured maximum output $O_2(H)$ or $CO_2(H)$ value is between the indicated upper and lower limits.

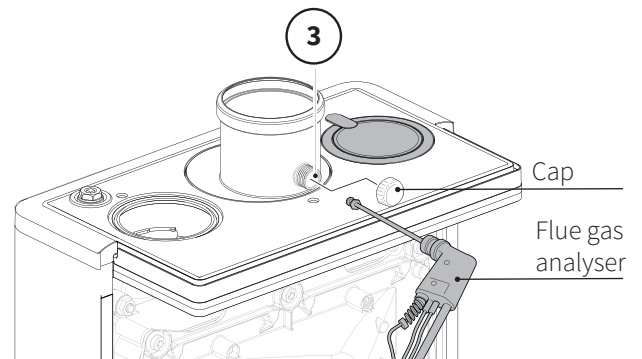
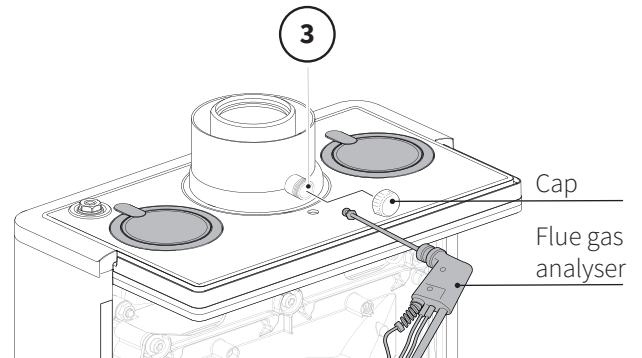
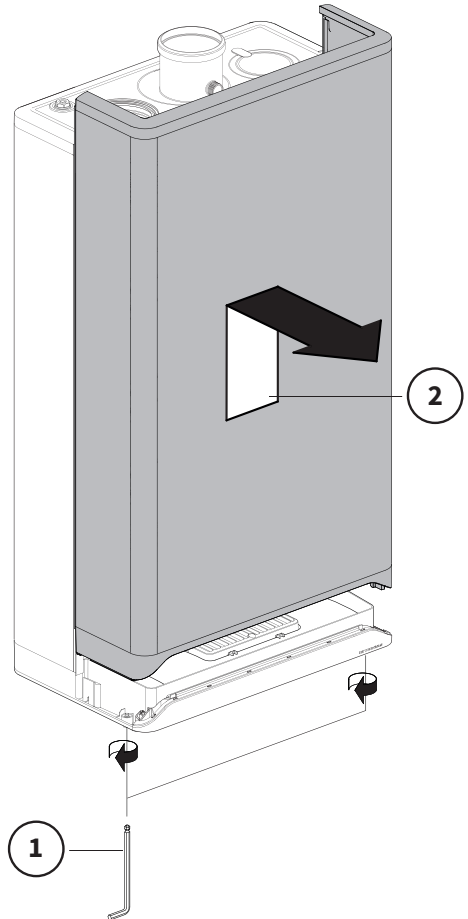

Table 2a: Allowed O₂(H) limits at maximum output (open casing)

Value limits	Gas category	
	Natural gas G20	LPG G31
	O ₂ [%]	O ₂ [%]
Upper limit	5.60	6.05
Lower limit	3.85	4.50

Table 2b: Allowed CO₂(H) limits at maximum output (open casing)

Value limits	Gas category	
	Natural gas G20	LPG G31
	CO ₂ [%]	CO ₂ [%]
Upper limit	9.6	10.8
Lower limit	8.6	9.8





IMPORTANT

▶ A deviation at maximum output cannot be corrected by adjusting the gas valve. In that case, the boiler must be meticulously inspected for gas density and correctness of components used (especially the gas restriction ring and the fan including venturi).

J. Then perform the measurement at minimum output (see §8.10.2).

8.10.2 Measuring flue gas at minimum output

Before measuring the flue gases at minimum output, the measurement at maximum output must be completed. The measured $O_2(H)$ or $CO_2(H)$ value at maximum output is important for determining the correct value for the check at minimum output. See **§8.10.1** for measuring at maximum output.

- Switch on the boiler at minimum output. To do this, tap simultaneously the Service button  and the Minus button  until the capital letter **L** appears on the right display.
- Wait until the readout of the flue gas analyser is stable (at least 3 minutes).
- Note the measured $O_2(L)$ or $CO_2(L)$ value.
 - $O_2(L)$... = measured minimum output O_2 value
 - $CO_2(L)$... = measured minimum output CO_2 value
- Check according to Table 3a or Table 3b whether the measured minimum output $O_2(L)$ or $CO_2(L)$ value is between the indicated upper and lower limits.



► **The O_2 lower limit is the $O_2(H)$ value that was noted during the maximum output measurement. The CO_2 upper limit is the $CO_2(H)$ value that was noted during the maximum output measurement. (See §8.10.1, Step H)**

Table 3a: Allowed $CO_2(L)$ limits at minimum output (open casing)

Value limits	Gas category	
	Natural gas G20	LPG G31
	O_2 [%]	O_2 [%]
Upper limit	6.00	6.65
Lower limit	$O_2(H)$	$O_2(H) + 0.5$

Table 3b: Allowed $CO_2(L)$ limits at minimum output (open casing)

Value limits	Gas category	
	Natural gas G20	LPG G31
	CO_2 [%]	CO_2 [%]
Upper limit	$CO_2(H)$	$CO_2(H) - 0.3$
Lower limit	8.4	9.4



IMPORTANT

- ▶ **The gas air control is correctly set if the measured value at minimum output falls within the indicated upper and lower limits. Adjustment of the gas air control is not necessary in this case. The setting at minimum output must be adjusted using the method described in §8.10.3 if the measured value lies outside the indicated limits.**



Example (Natural gas G20)

- ▶ **During maximum output a $O_2(H)$ value of 4.0 % has been measured. In that case the $O_2(L)$ value at minimum output must be in-between 4 % (= value $O_2(H)$) and 6.05% as stated in the table. When during minimum output a value out of this range is measured the gas-air ratio must be adjusted.**

- E. If the minimum output measurement falls outside the limits given in Table 3a or 3b, continue at **§8.10.3** to set up the gas valve anew. If the setting is correct, continue to Step F.
- F. Mount the front panel and fasten the 2 screws by hand. Check the CO value at minimum output. The maximum allowed CO measurement value is 160 ppm.
- G. Switch on the boiler to maximum output. To do this, hold the Service button  and at the same time tap the Plus button 2x **+** until the capital letter **H** appears on the right display. Check the CO value at maximum output. The maximum allowed CO measurement value is 160 ppm.
- H. Switch off the boiler.
- I. Remove the analyser probe of the flue gas analyser from the flue gas measurement point and carefully replace the cap on the adapter above the boiler.
- J. Switch on the boiler again.
- K. Check the gas density of the flue gas measurement point.

8.10.3 Minimum output correction

Before the min. output correction is performed, the maximum output and minimum output measurements must be completed. The measured $O_2(H)$ or $CO_2(H)$ value at maximum output is important for determining the correct value for the setting at minimum output (see §8.10.1 and §8.10.2).

- A. Remove the cover screw of the gas valve so that the adjustment screw is accessible.
- B. Switch on the boiler at minimum output. To do this, tap simultaneously the Service button  and the Minus button — until the capital letter **L** appears on the right display.
- C. Wait until the readout of the flue gas analyser is stable (at least 3 minutes).
- D. Measure the $O_2(L)$ or $CO_2(L)$ value.
- E. Using the adjustment screw B, set the correct $O_2(L)$ or $CO_2(L)$ value. For the correct $O_2(L)$ setting value, see Tables 4a, 4b or 4c. For the correct $CO_2(L)$ setting value, see Tables 5a, 5b or 5c.
- F. Reattach the cover screw of the gas valve so that the adjustment screw is sealed.

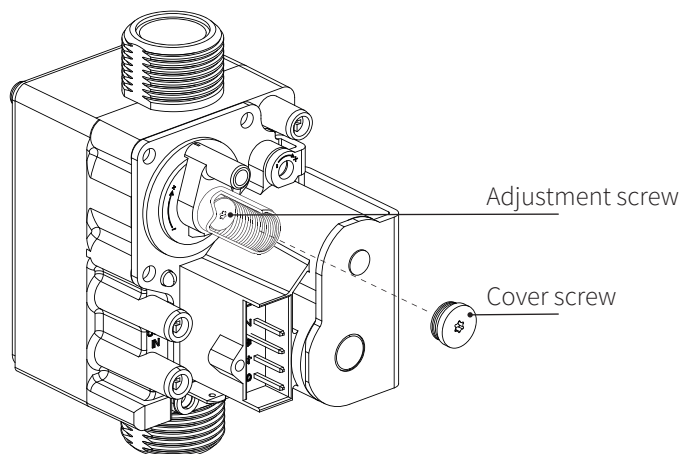

- ▶ **Select the correct table depending on the applicable gas category:**
4a and 5a: natural gas (G20)
4b and 5b: LPG 3P (G31)
- ▶ **The maximum output measurement value is decisive for a correct adjustment. This measurement value was noted during the maximum output measurement $O_2(H)$ or $CO_2(H)$ (see §8.10.1, Step H).**
- ▶ **Turning the adjustment screw to the right reduces O_2 (and increases CO_2); turning to the left increases O_2 (and decreases CO_2).**
- ▶ **Twist the adjustment screw with small steps and wait after each twist until the measurement is stable.**

Table 4a: Determination of O₂(L) setting value natural gas (open casing)

Natural gas		G20 (20 mbar)
Measured value at maximum output (see §8.10.1, Step H)		Setting value minimum output (= 0.5 x O ₂ (H) + 3)
O ₂ (H) [%]		CO ₂ (L) [%]
5.60	→	5.80 ± 0.2
5.30	→	5.65 ± 0.2
5.00	→	5.50 ± 0.2
4.70	→	5.35 ± 0.2
4.40	→	5.20 ± 0.2
4.10	→	5.05 ± 0.2
3.85	→	4.90 ± 0.2

Table 5a: Determination of CO₂(L) setting value for natural gas 2EK (open casing)

Natural gas		G20 (20 mbar)
Measured value at maximum output (see §8.10.1, Step H)		Setting value minimum output (= 0.5 x CO ₂ (H) + 4.2)
CO ₂ (H) [%]		CO ₂ (L) [%]
9.6	→	9.0 ± 0.1
9.4	→	8.9 ± 0.1
9.2	→	8.8 ± 0.1
9.0	→	8.7 ± 0.1
8.8	→	8.6 ± 0.1
8.6	→	8.5 ± 0.1

Table 4b: Determination of O₂(L) setting value for LPG (open casing)

LPG		G31 (30 & 50 mbar)
Measured value at maximum output (see §8.10.1, Step H)		Setting value minimum output (= O ₂ (H) + 0.5)
O ₂ (H) [%]		CO ₂ (L) [%]
6.05	→	6.55 ± 0.2
5.70	→	6.20 ± 0.2
5.40	→	5.90 ± 0.2
5.10	→	5.60 ± 0.2
4.80	→	5.30 ± 0.2
4.50	→	5.00 ± 0.2

Table 5b: Determination of CO₂(L) setting value for LPG (open casing)

LPG		G31 (30 & 50 mbar)
Measured value at maximum output (see §8.10.1, Step H)		Setting value minimum output (= CO ₂ (H) - 0.3)
CO ₂ (H) [%]		CO ₂ (L) [%]
10.8	→	10.5 ± 0.1
10.6	→	10.3 ± 0.1
10.4	→	10.1 ± 0.1
10.2	→	9.9 ± 0.1
10.0	→	9.7 ± 0.1
9.8	→	9.5 ± 0.1



Example (when using natural gas G20)



▶ During maximum output, an O₂(H) value of 4.10% is measured. In that case, the minimum output O₂ setting value is 5.05 ± 0.2%.

- G. Repeat the measurements at maximum output and minimum output noted in §8.10.1 and §8.10.2 (start with Step F in §8.10.1) to ensure the correct operation of the boiler.

9 FAULTS

9.1 Fault codes

Requesting fault code

If the burner controller detects a fault, this is shown by a flashing service symbol  on the display. A fault code, such as **F004**, is shown on the left display for 30 seconds. Then the left display will be extinguished. The service symbol  remains flashing.

The fault code can be requested by tapping the flashing service symbol .

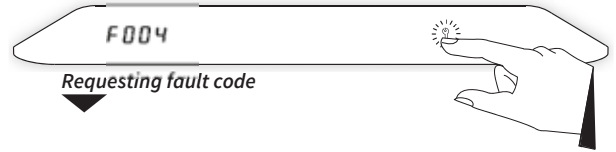

Resetting the boiler

The boiler can be reset by touching the flashing Service button  and holding it for 2 seconds. The boiler will then be restarted.

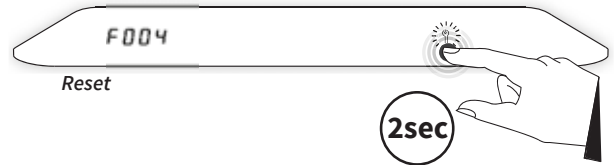

IMPORTANT

▶ **Using the fault code, check the table below for the nature of the fault and try to address the cause of the fault as much as possible before resetting the boiler.**

The following fault codes can be distinguished:

Fault code	Description	Possible cause / solution
F000	Sensor S0 is defective.	▶ Replace heat exchanger sensor S0.
F001	Temperature is too high during central heating demand.	<ul style="list-style-type: none"> ▶ Air in system. Bleed the central heating system. ▶ Pump does not run. Replace the pump. ▶ Check wiring of central heating flow sensor S1 for breakage/shutdown. ▶ Check whether central heating flow sensor S1 is installed correctly. ▶ Check for the correct operation of central heating flow sensor S1. ▶ Replace central heating flow sensor S1.
F002	Temperature too high during DHW demand.	<ul style="list-style-type: none"> ▶ Check wiring of domestic hot water sensor S3 for breakage/shutdown. ▶ Check whether domestic hot water sensor S3 is installed correctly. ▶ Check for the correct operation of domestic hot water sensor S3. ▶ Replace domestic hot water sensor S3.
F003	Flue gas temperature is too high.	▶ Check heat exchanger for contamination.
F004	No flame during start-up.	<ul style="list-style-type: none"> ▶ Gas valve is closed. ▶ Gas inlet pressure lower than 20 mbar or sometimes disappears. ▶ Condensation drain is blocked. ▶ Check ignition unit. ▶ Gas valve or ignition unit is not receiving electricity. ▶ Poor internal grounding.
F005	Flame disappears during operation.	<ul style="list-style-type: none"> ▶ Condensation drain is blocked. ▶ Gas inlet pressure lower than 20 mbar or sometimes disappears. ▶ Check ignition unit. ▶ Check adjustment of gas valve. ▶ Check air supply duct and flue for possible recirculation or blockage of flue gases. ▶ Poor internal grounding.
F006	Flame simulation.	<ul style="list-style-type: none"> ▶ Replace gas valve. ▶ Replace burner controller.

Fault code	Description	Possible cause / solution
F007	No or insufficient ionisation flow.	<ul style="list-style-type: none"> ▶ Check ionisation/ignition pin. ▶ Check wiring of ionisation/ignition pin for breakage/shutdown. ▶ Replace ionisation/ignition pin.
F008	Incorrect fan speed	<ul style="list-style-type: none"> ▶ Check fan cable. ▶ Check and/or replace fan. ▶ Replace burner controller.
F009	Internal fault in burner controller.	<ul style="list-style-type: none"> ▶ Replace burner controller.
F010, F011	Sensor fault S0.	<ul style="list-style-type: none"> ▶ Check the wiring of heat exchanger sensor S0 for breakage/shutdown. ▶ Check whether heat exchanger sensor S0 is connected correctly. ▶ Check for the correct operation of heat exchanger sensor S0. ▶ Replace heat exchanger sensor S0.
F012	Sensor fault S5.	<ul style="list-style-type: none"> ▶ Check the wiring of flue gas sensor S5 for breakage/shutdown. ▶ Check whether flue gas sensor S5 is connected correctly. ▶ Check for the correct operation of flue gas sensor S5. ▶ Replace flue gas sensor S5.
F014	Mounting fault sensor S0	<ul style="list-style-type: none"> ▶ Heat exchanger sensor S0 is not mounted correctly. Mount the sensor correctly.
F015	Mounting fault sensor S1	<ul style="list-style-type: none"> ▶ Central heating flow sensor is not mounted correctly. Mount the sensor correctly.
F016	Mounting fault S3	<ul style="list-style-type: none"> ▶ Domestic hot water sensor S3 is not mounted correctly. Mount the sensor correctly.
F018	Flue and/or air supply duct is blocked.	<ul style="list-style-type: none"> ▶ Check the flue and the air supply duct. ▶ Clean the flue and/or the air supply duct.
F019	BMM fault.	<ul style="list-style-type: none"> ▶ Check BMM wiring for breakage/shutdown. ▶ Replace BMM.
F027	Short circuit of outdoor sensor S6.	<ul style="list-style-type: none"> ▶ Check the wiring of the outdoor sensor for breakage/shutdown. ▶ Replace the outdoor sensor. ▶ BRINK WTW connection piece is connected. Burner controller is unsuitable for this application. Replace burner controller with the correct version.
F028	Reset error.	<ul style="list-style-type: none"> ▶ Check the reset button for unintentional operation (e.g. cleaning of control panel). ▶ Replace burner controller.
F029	Gas valve fault.	<ul style="list-style-type: none"> ▶ Check the gas valve for leakage. ▶ Replace the burner controller.
F030	Sensor fault S3.	<ul style="list-style-type: none"> ▶ Check wiring of domestic hot water sensor S3 for breakage/shutdown. ▶ Check whether domestic hot water sensor S3 is connected correctly. ▶ Check for the correct operation of domestic hot water sensor S3. ▶ Replace domestic hot water sensor S3.
F031	Sensor fault S1.	<ul style="list-style-type: none"> ▶ Check wiring of central heating flow sensor for breakage/shutdown. ▶ Check whether central heating flow sensor S1 is connected correctly. ▶ Check for the correct operation of central heating flow sensor S1. ▶ Replace central heating flow sensor S1.



IMPORTANT

- ▶ **Replace defective components exclusively with original Intergas components.**
- ▶ **Not or incorrectly installing the sensors can lead to serious damage.**

9.2 Other faults

9.2.1 No heat (central heating)

Possible causes	Analysis	Solution
The power LED is not shown.	→ Yes ↓ No	→ Check the power supply. Check the fuse; see Electrical schematic §11.1 .
The right display shows a line (—). The boiler is off.	→ Yes ↓ No	→ Switch on the boiler by touching just above the power LED and holding this for 2 seconds
Room thermostat / weather-dependent control is not connected or is defective.	→ Yes ↓ No	→ Check the wiring. Check OpenTherm, On/Off connection of the boiler, or the connection between the central heating boiler and the OpenTherm room thermostat. Replace the thermostat. Replace the weather-dependent control.
No electricity (24V).	→ Yes	→ Replace defective automatic. Check the wiring according to the schematic. Check Connector X13.

9.2.2 Central heating does not reach the correct temperature

Possible causes	Analysis	Solution
Water pressure in the system is too low.	→ Yes ↓ No	→ Top off the system; see §7.2.1 .
Room thermostat is not in order.	→ Yes ↓ No	→ Check the setting and adjust it if necessary.
Temperature is set too low.	→ Yes ↓ No	→ Increase the central heating temperature; see central heating demand. If an outdoor sensor is present: Check the outdoor sensor for short circuiting: cancel this.
No flow in the system.	→ Yes ↓ No	→ Check the ΔT ($\pm 20^{\circ}\text{C}$) between central heating supply and return. Ensure a correct flow in the system.
The boiler capacity is not correctly set.	→ Yes ↓ No	→ Adjust the boiler capacity. See §8.3 and §8.6 .
No heat transfer due to contamination in the central heating boiler/system.	→ Yes ↓ No	→ Flush the central heating boiler/system from the central heating side.
Flue and/or air supply duct is blocked.	→ Yes	→ Check and (if necessary) clean the flue and the air supply duct.

9.2.3 Central heating system remains too warm

Possible causes	Analysis	Solution
Room thermostat / weather-dependent control is defective or has a short circuit.	→ Yes ↓ No	→ Check the wiring. Check OpenTherm, On/Off connection of the boiler, or the connection between the central heating boiler and the RF room thermostat. Replace the thermostat. Replace the weather-dependent control.
There is thermo-siphon in the central heating circuit.	→ Yes	→ Place a check valve (in the case of thermo-siphon) or a two-way valve (if there is a second pump in the central heating circuit).

9.2.4 No domestic hot water (DHW)

Possible causes	Analysis	Solution
The power LED is not shown.	→ Yes ↓ No	→ Check the power supply. Check the fuse; see Electrical schematic § 11.1.
Flow sensor does not work.	→ Yes ↓ No	→ Replace the flow sensor.
Domestic hot water flow < 2 l/min.	→ Yes ↓ No	→ Increase the domestic hot water flow.
Domestic hot water sensor S3 is defective.	→ Yes ↓ No	→ Replace domestic hot water sensor S3.
No electricity on the flow sensor (5V DC).	→ Yes	→ Check the wiring according to the schematic.

9.2.5 Domestic hot tap water does not reach the correct temperature

Possible causes	Analysis	Solution
Domestic hot water flow is too high.	→ Yes ↓ No	→ Reduce the domestic hot water flow.
Setting for domestic hot water temperature is too low.	→ Yes ↓ No	→ Increase the domestic hot water temperature; see §8.1.2.
Insufficient heat transfer due to calcium or contamination in the domestic hot water-sided central heating boiler.	→ Yes ↓ No	→ De-calcify or flush the domestic hot water-sided central heating boiler.
The central heating system becomes warm while tapping water.	→ Yes ↓ No	→ Undesirable circulation during domestic hot water demand in the central heating circuit due to thermo-siphon of the second pump in the central heating circuit. Place a check valve (in the case of thermo-siphon) or a two-way valve (if there is a second pump).
Central heating pressure is too low.	→ Yes ↓ No	→ Top off the central heating system until the central heating pressure is between 1 and 2 bar.
The flue is blocked.	→ Yes	→ Check the flue.

9.2.6 Burner ignites loudly

Possible causes	Analysis	Solution
Inlet pressure is too high.	→ Yes ↓ No	→ The home pressure regulator may be defective. In that case, contact the energy company.
Ignition distance is incorrect.	→ Yes ↓ No	→ Replace the ignition pin including the ignition cable.
Gas-air control is not correctly adjusted.	→ Yes ↓ No	→ Check the adjustment; see §8.9 and §8.10.
The spark is weak.	→ Yes	→ Check and/or replace the ignition cable. Replace the ignition unit in the top cover. Replace the ignition pin.

9.2.7 Burner resonates

Possible causes	Analysis	Solution
Gas inlet pressure lower than 20 mbar or sometimes disappears.	→ Yes ↓ No	→ The home pressure regulator may be defective. Contact the energy company.
There is recirculation of flue gases.	→ Yes ↓ No	→ Check the flue and air supply duct.
Gas-air control is not correctly adjusted.	→ Yes ↓ No	→ Check the adjustment; see §8.9 and §8.10 .
Burner seal is defective.	→ Yes ↓ No	→ Replace the burner seal.
Burner is defective.	→ Yes	→ Replace the burner.

10 MAINTENANCE

The boiler and the system must be inspected annually by an qualified competent gas safe registered engineer and cleaned if necessary. The annual maintenance interval is based on an expected operation time of approx. 1,500 heating hours/year (average domestic use), via Comfort Touch dashboard and installed app. If not monitored by Comfort Touch then the boiler must be serviced annually.



CAREFUL

- ▶ **After work activities, check all flue supply piping parts for tightness.**
- ▶ **Some components can be hot when the boiler has just been in operation.**

10.1 Disassembly

- ▶ Switch off the appliance and isolate the power supply at the fuse spur, make safe the appliance before continuing (Ref TB118).
- ▶ Close the gas valve.
- ▶ Remove the front panel of the boiler by unscrewing the two screws (1) and then removing the panel up and forward (2).
- ▶ Wait until the boiler has cooled down. This can be done by opening a domestic hot water tap.
- ▶ Turn the expansion vessel aside.
- ▶ Disconnect the connector of the fan.
- ▶ Disconnect the connection under the gas valve.
- ▶ Unscrew the shoulder bolts (socket) of the front cover and remove the cover forward with the gas valve and fan (pay attention that the burner, insulation panel, gas valve, gas piping and the fan do not become damaged). Lay the removed front cover with the foot supports horizontal on a smooth surface.
- ▶ The burner and the integrated insulation panel do not require maintenance (do not need to be cleaned). Therefore, never use a brush or compressed air to clean these components so that the development of dust is avoided.
- ▶ Remove the siphon cup by turning it counter-clockwise and then removing it downwards.



COMMENT

- ▶ **The expansion vessel must be inspected and tested at each annual service and if required re-pressure to 0.75 bar.**

10.2 Cleaning

- ▶ Clean the slats of the heat exchanger from top to bottom with a brush or vacuum cleaner.
- ▶ Clean the underside of the heat exchanger.
- ▶ Clean the siphon with water.
- ▶ Only clean the underside of the front panel.



CAREFUL

- ▶ **The integrated insulation panel and burner seal contain ceramic fibres.**

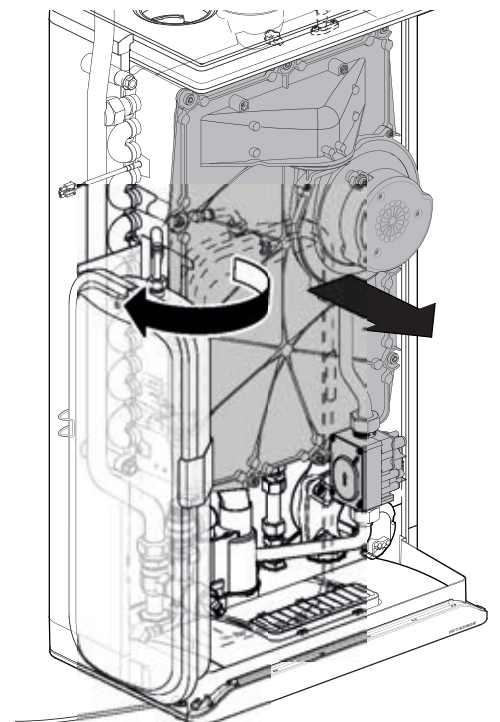
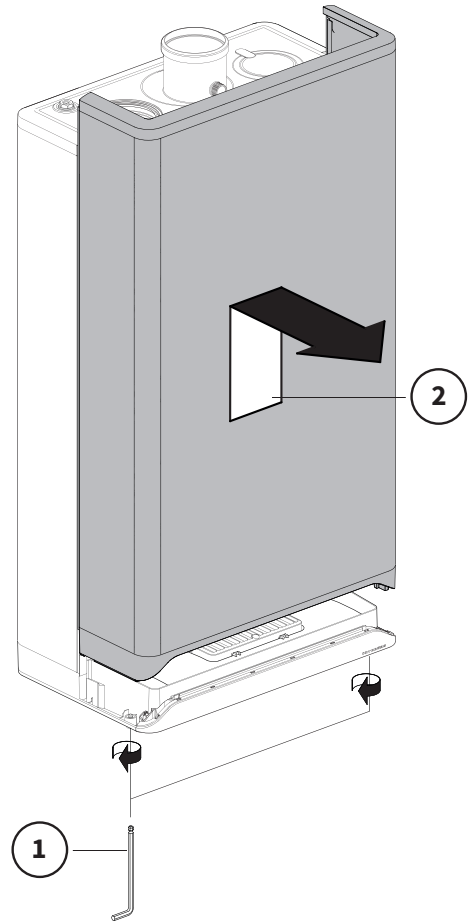

10.3 Installation



IMPORTANT

- ▶ **Replace the front plate O-ring every 3 years.**
Art.no: 877927 — Xclusive 24/30
620274 — Xclusive 36
- ▶ **Check and replace any other gaskets.**
Also check the correct positioning.

- ▶ Check whether there is a thin layer of ceramic grease between the flange of the shoulder bolt and the front panel. If there is insufficient grease present, extra must be applied:
- ▶ Check whether the gasket around the front panel is correctly placed. Place the front panel on the heat exchanger and attach it with the special shoulder bolts (socket). Tighten the shoulder bolts (1 to 11) by hand, working diagonally. For the order of tightening, see the picture.
- ▶ Verify the shoulder bolts according to the same order with a torque spanner at 10-12 Nm.
- ▶ Tighten the burner bolts diagonally by hand.
- ▶ Check the gasket and fit the gas connection under the gas valve.
- ▶ Install the connector on the fan.
- ▶ Open the gas valve and check the gas connections under the gas valve for leakage.
- ▶ Check the water supply piping for leakage.
- ▶ Fill the siphon cup to just over half full with clean water.
- ▶ Replace the siphon cup by sliding it over the siphon spout and then turning it clockwise until it is secure. Check whether the siphon spout is sticking into the water and check whether the siphon cup is firmly in place.
- ▶ Turn the expansion vessel back to its original position. Make sure the vessel is secured by the lip on the cable cover.
- ▶ Turn the power supply on at the fuse spur.
- ▶ Switch on the boiler.
- ▶ Check the front cover, the connection of the fan on the front cover, and the flue components for leakage.
- ▶ Check the gas/air control (see **§8.9** and **§8.10**) and check the gas connection on the gas valve for tightness.
- ▶ Install the casing and tighten the two screws at the left and right under the boiler.
- ▶ Check the domestic hot water facility for correct operation.

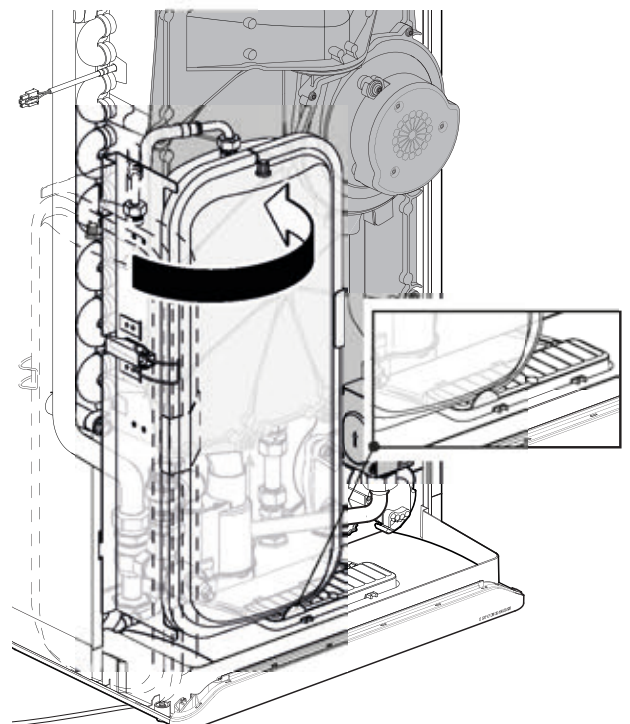
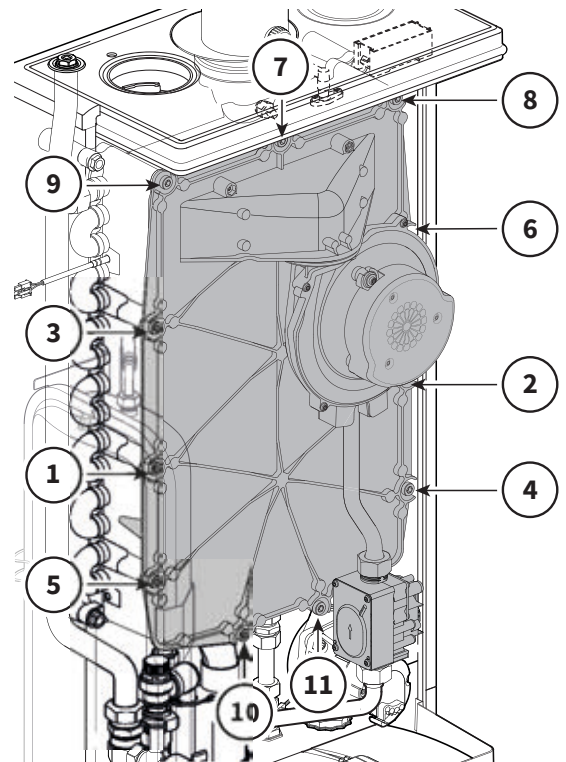
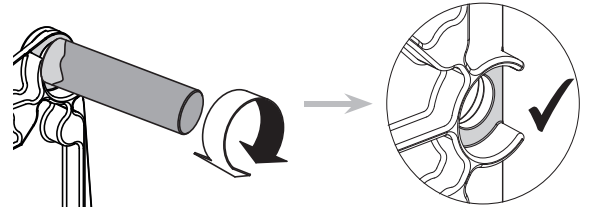

10.4 Checklist

No.	Activity	Inspection at every annual service	Maintenance must be carried out at regularly
1	Isolate the boiler from the fuse spur and make safe (ref TB118) check the correct 3amp fuse fitted.		
2	Carry out inspection of boiler for dust and dirt and clean where necessary.		
3	Visually inspect the front plate and heat exchange for signs of damage. If damage is evident proceed to column 2.		
4	Check the gas inlet pressure on HIGH rate (DHW mode).		
5	Check combustion by measuring CO, CO ² . If the values are outside the tolerances then proceed to a full service in column 2.		
6	Close the gas isolation valve.		
7	Isolate flow and return valves and drain boiler via the drain off on the return. Check the charge in the expansion vessel. Recharge if necessary.		
8	Remove the front plate and clean the inside of the heat exchanger.		
9	Check the front plate seal and replace the seal if damaged or the seal is 3 years old.		
10	Check the burner and burner seal.		
11	Check the ignition pin.		
12	Check the condensate trap, clean and fill.		
13	Open the isolation valves on flow and return and refill the water in the boiler to 1.2 bar via the filling loop.		
14	Open the gas isolation valve, reconnect the power to the boiler via fuse spur.		
15	Check visually the ignition and burner performance.		
16	Check the boiler for leaks of any kind (gas, flue gas, water, condensate) rectify if necessary.		
17	Recheck the CO,CO ² and adjust if necessary, adjust CO ² only LOW fire.		
18	Complete the Benchmark Service Record on the back pages of the Installation manual.		

11 TECHNICAL SPECIFICATIONS

Boiler category	C13; C33; C53		
Gas inlet pressure	G20: 20 mbar, G31: 37 mbar		
Suitable for gas	II _{2H3P}		

Technical data	Xclusive		
	24	30	36

Domestic hot water				
Nom. input rating (lower value)	kW	3.6 – 25.1	3.6 – 30.5	3.6 – 32.7
Tap threshold	l/min	2		
ΔT 25°C	l/min	14.1	17.1	18.9
ΔT 35°C	l/min	10	12.2	13.5
Domestic hot water temperature (default)	°C	55		
Domestic hot water-sided pressure difference	bar	see §6.2.1		

Central heating				
Nom. input rating (lower value)	kW	3.6 – 18.7	3.6 – 23.7	3.6 – 27.0
Nom. output	kW	4.0 – 18.2	4.0 – 23.1	4.0 – 26.6
Max. Central heating water pressure	bar	3		
Max. Central heating water temperature	°C	90		





Other data				
Gas consumption (G20)	m ³ /h	0.38 – 2.66	0.38 – 3.23	0.38 – 3.46
Gas consumption (G31)	m ³ /h	0.15 – 1.03	0.15 – 1.25	0.15 – 1.34
Appliance pressure loss (CH)	mWk	See §8.6		
Average flue temperature DHW	°C	35		
Flue massflow (minimum-maximum)	kg/h	5.9 – 41.6	5.9 – 50.5	5.9 – 54.1
Maximum counterpressure	Pa	250		



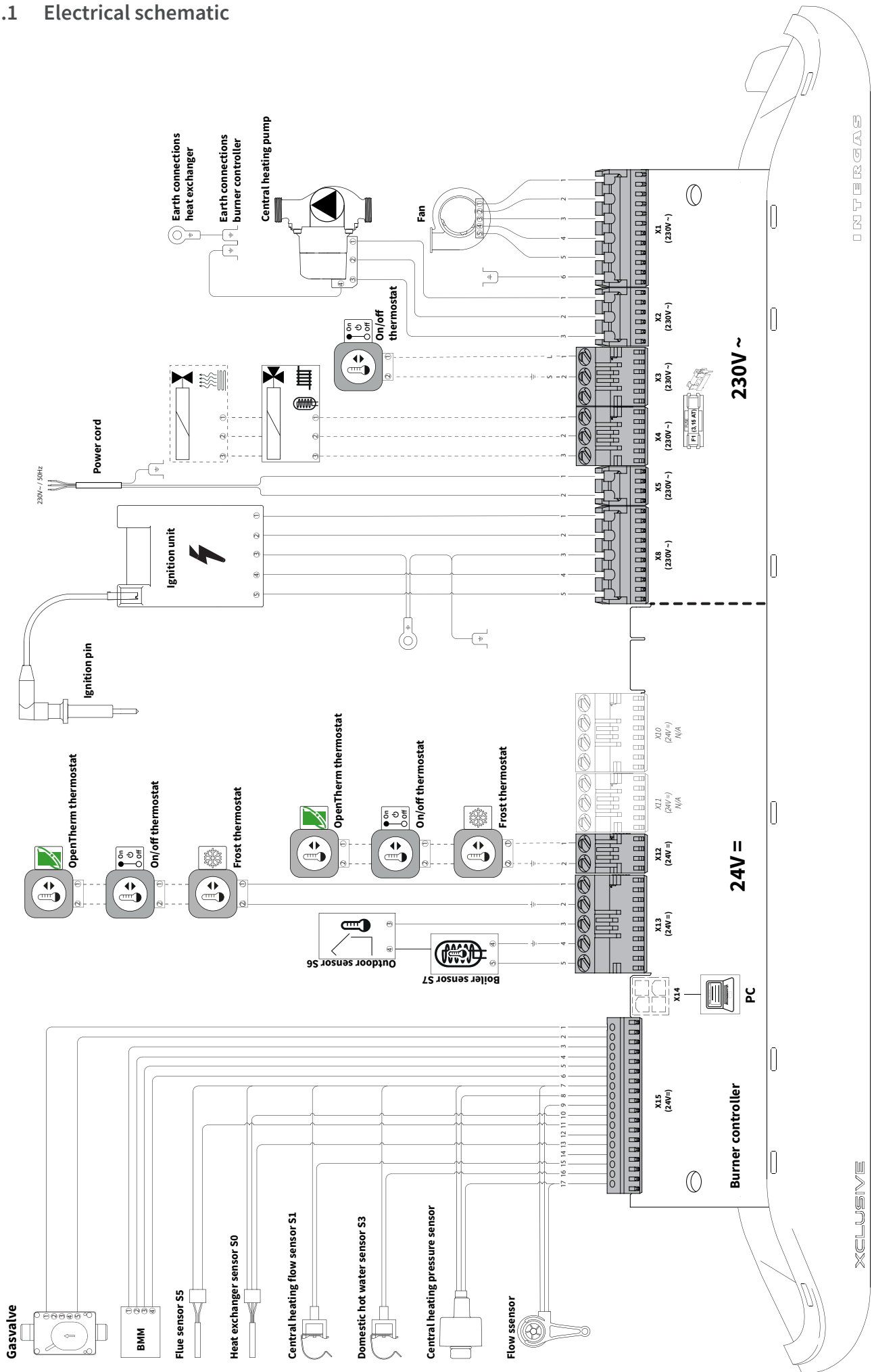



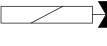
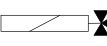



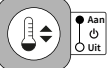

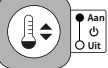

Electric data				
Mains voltage	V	230		
Safety class	IP	IPX4D		
Recorded output: full load	W	115		
Recorded output: standby	W	2		

Overall dimensions and weight				
Height	mm	766	766	826
Width	mm	450		
Depth	mm	277		
Weight	kg	30	30	33

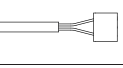
11.1 Electrical schematic

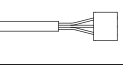

230V~ component			
Connector	Connections	Designation	Description
X1	1-2-3-4-5-6		Fan
X2	1-2-3		Central heating pump
X3	1-2		On/off room thermostat 230V
X4	1-2-3		Shut-off valve underfloor heating or groups adjustment (1=N (blue), 2=L (brown), 3=T (black))
	1-2-3		Three-way valve (1=N (blue), 2=L (brown), 3=T (black))
X5	1-2		Power mains cord 230V~ 50Hz (1=L (brown), 2=N (blue), \perp = ground (green/yellow))
X8	1-2-3-4-5		Ignition unit

24V = component			
Connector	Connections	Designation	Description
X12	1-2		Optional (OpenTherm thermostat)
X12	1-2		Optional (On/off room thermostat)
X12	1-2		Optional (Frost thermostat if OT thermostat on X13)
X13	1-2		OpenTherm thermostat (<u>primary</u> connection)
	1-2		On/off room thermostat
	1-2		Frost thermostat
	3-4		Outdoor sensor S6 (12k Ω / 25°C)
	4-5		Boiler sensor S7
X14			PC Interface
X15	1-2		Gas valve
	3-4-5-6		BMM (Boiler Memory Module)
	7-11		Flue gas sensor S5
	7-16		Domestic hot water sensor S3
	7-10-13		Heat exchanger sensor S0
	7-15		Central heating flow sensor S1
	7-9-17		Flow sensor
	7-8-17		Central heating pressure sensor

11.2 Product card according to CELEX-32013R0811, Appendix IV

Supplier			Intergas Heating Ltd Unit 2 Easter Park Worcester Road Kidderminster DY11 7AR		
			Intergas Xclusive		
Type designation	Symbol	Unit	24	30	36
Seasonal energy efficiency class for room heating	-	-	A	A	A
Nominal heat output (capacity)	P_{rated}	kW	18	23	27
Seasonal energy efficiency class for room heating	η_s	%	93	93	93
Annual energy use	Q_{HE}	GJ	38	48	58
Noise level	L_{WA}	dB	56	56	58
Domestic hot water capacity profile	-	-	L	XL	XL
Energy efficiency class for water heating	-	-	A	A	A
Domestic hot water efficiency	η_{WH}	%	85	86	87
Annual electricity use	AEC	kWh	13	16	15
Annual fuel use	AFC	kWh	2958	4809	4756



IMPORTANT

- ▶ Before installation, read the installation manual and the operation instructions.
- ▶ This appliance is not intended for use by individuals (including children) with reduced physical, sensory or mental capacities, or lack of experience and knowledge, unless supervision of or instruction about the use of the appliance is given by a person who is responsible for their safety.
- ▶ The boiler and system must be inspected annually by an authorized installer and cleaned if necessary. See §10 for the annual cleaning.
- ▶ The boiler can be cleaned with a damp cloth. Do not use aggressive or scrubbing cleaning agents or solvents.

11.3 NTC resistances

NTC 12 kOhm							
T [°C]	R [Ω]	T [°C]	R [Ω]	T [°C]	R [Ω]	T [°C]	R [Ω]
-15	76020	15	18300	45	5522	75	1994
-10	58880	20	14770	50	4609	80	1717
-5	45950	25	12000	55	3863	85	1467
0	36130	30	9805	60	3253	90	1266
5	28600	35	8055	65	2752	95	1096
10	22800	40	6653	70	2337	100	952

12 GUARANTEE PROVISIONS AND CE DECLARATION

1. The installer must be registered with Gas Safe, installer must complete the Benchmark Commissioning Checklist in full at the time the boiler is installed. The Benchmark must be made available and can be found at the back of the installation instructions. The Benchmark Commissioning Checklist must be retained on site by the owner/occupier for inspection during an engineers visit.
2. The boiler warranty must be registered with Intergas by either the installer or you the householder, within 30 days of the boiler being installed. For the new build properties, this must be done within 30 days of the sale being completed. If these conditions are not met, the warranty will not be valid.

The product must be registered via the internet at www.intergasheating.co.uk or on the Intergas MiREG website www.myintergasregistration.co.uk or by returning the warranty card.

3. The boiler must be serviced annually by a registered Gas Safe Engineer in accordance with manufacturer's instructions.
4. Service details must be recorded in the Benchmark Checklist or provide proof of service which must be available for inspection.
5. The cost of the annual service is not included in the warranty.

If the above conditions are not met this warranty will be limited to 12 months from the date of installation or date of Manufacture, as recorded on the Benchmark commissioning checklist.



IMPORTANT

Warranty terms mentioned above are based on domestic use only. Any non-domestic applications will be covered by a 12 months warranty. Service intervals may need to be increased depending on commercial usage. For additional information please contact Intergas Heating Ltd.

6. Only boiler component failures are covered by the warranty. The warranty does not cover any connected system or accessories such as time switches, thermostats, motorised valves, external pumps and so on.
7. Any repair carried out under the terms of this warranty does not extend the warranty beyond its original period.
8. If the boiler breaks down, Intergas may ask you* (Homeowner or Installer) to pay a deposit before we visit to complete the repair. We will return the deposit in full if we find a fault that is covered by the warranty. We may keep the deposit if we cannot access the property at the time we have arranged with you to visit or we find other conditions of this warranty have not been met.
9. The system must be flushed and cleansed in accordance with BS7593.
10. If any failure is caused by contaminated water in the system the engineer visit becomes chargeable.
11. All installation, non boiler or external system faults calls will be charged to the home owner/occupier.
12. Roof space installation BS6798 2009 Require a permanently fixed access ladder must service installations in lofts or attics. Adequate lighting and permanently fixed flooring must also be available.
13. Engineers will not carry out repairs if they think accessing the boiler would be a risk to Health and Safety. A responsible adult must be at the property to give our engineer access to the boiler.
14. If your boiler is in a cupboard, there must be enough room for the engineer to work (the minimum area as set out in the installation instructions). We are not responsible for removing cupboards, kitchen units, trims etc to gain access for repairs.

15. In hard water areas of 200ppm or above, appropriate protection actions must be taken in accordance with BS 7593 in line with building regulations Part L1. (Above 200ppm we recommend Combimate*, Adey Electroscale or Hydroflow HS38 should be installed. 300ppm and above we recommend a Combimate* or Water softener* should be installed.) (*serviceable item)
16. The central heating system must be maintained in accordance with the Benchmark Guidance on Water Treatment in Central Heating Systems & BS7593, we recommend the use of FERNOX, SENTINEL or ADEY inhibitors and Filters. It is important that correct concentration of water treatment is maintained for the life of the boiler, should we attend a warranty call we have the right to take a water sample. Should this fail the warranty will not be valid and will become chargeable. (BS 7593:2006)
17. If the boiler suffers a breakdown you should contact Intergas on 01527 888000 selecting option 2. Our normal working hours, excluding Bank Holidays are:
8.00am – 5.00pm Monday to Friday and
8.00am – 12.00pm Saturday mornings.



Installers are required to carry out installation, commissioning and servicing work in accordance with the Benchmark Code of Practice which is available from the Heating and Hotwater Industry Council who manage and promote the scheme. Visit www.centralheating.co.uk for more information.

CE DECLARATION

Manufacturer	Intergas Heating Limited
Address	Unit 2 Easter Park Worcester Road Kidderminster DY11 7AR

hereby declares that CH appliance:
INTERGAS, Type:

- ▶ **Xclusive 24**
- ▶ **Xclusive 30**
- ▶ **Xclusive 36**

Meets the provisions of the following directives:

- ▶ Low Voltage Directive (2014/35/EC)
- ▶ Gas Appliance Regulation (2016/426/EC)
- ▶ Directive regarding efficiency requirements for new oil and gas-burning central heating boilers (92/42/EC)
- ▶ EMC Directive (2014/30/EC)
- ▶ RED Directive (2014/53/EC)*
- ▶ Ecodesign (2009/125/EG)
- ▶ Energy labelling (2010/30/EU)

* The conformity declaration can be requested from Intergas.



S. Zouch, April 2019

13 GAS BOILER SYSTEM COMMISSIONING CHECKLIST

GAS BOILER SYSTEM COMMISSIONING CHECKLIST

This Commissioning Checklist is to be completed in full by the competent person who commissioned the boiler as a means of demonstrating compliance with the appropriate Building Regulations and then handed to the customer to keep for future reference.

Failure to install and commission according to the manufacturer's instructions and complete this Benchmark Commissioning Checklist will invalidate the warranty. This does not affect the customer's statutory rights.

Customer name:		Telephone number:	
Address:			
Boiler make and model:			
Boiler serial number:			
Commissioned by (PRINT NAME):		Gas Safe register number:	
Company name:		Telephone number:	
Company address:			
		Commissioning date:	
To be completed by the customer on receipt of a Building Regulations Compliance Certificate*			
Building Regulations Notification Number (if applicable):			
CONTROLS (tick the appropriate boxes)			
Time and temperature control to heating	Room thermostat and programmer/timer		Programmable room thermostat
	Load/weather compensation		Optimum start control
Time and temperature control to hot water	Cylinder thermostat and programmer/timer		Combination Boiler
Heating zone valves	Fitted		Not required
Hot water zone valves	Fitted		Not required
Thermostatic radiator valves	Fitted		Not required
Automatic bypass to system	Fitted		Not required
Boiler interlock			Provided
ALL SYSTEMS			
The system has been flushed and cleaned in accordance with BS7593 and boiler manufacturer's instructions			Yes <input type="checkbox"/>
What system cleaner was used?			
What inhibitor was used?			Quantity litres
Has a primary water system filter been installed?			Yes <input type="checkbox"/> No <input type="checkbox"/>
CENTRAL HEATING MODE measure and record:			
Gas rate	m ³ /hr	OR	ft ³ /hr
Burner operating pressure (if applicable)	mbar	OR Gas inlet pressure	mbar
Central heating flow temperature			°C
Central heating return temperature			°C
COMBINATION BOILERS ONLY			
Is the installation in a hard water area (above 200ppm)?			Yes <input type="checkbox"/> No <input type="checkbox"/>
If yes, has a water scale reducer been fitted?			Yes <input type="checkbox"/> No <input type="checkbox"/>
What type of scale reducer has been fitted?			
DOMESTIC HOT WATER MODE Measure and Record:			
Gas rate	m ³ /hr	OR	ft ³ /hr
Burner operating pressure (at maximum rate)	mbar	OR Gas inlet pressure at maximum rate	mbar
Cold water inlet temperature			°C
Hot water has been checked at all outlets			Yes <input type="checkbox"/> Temperature °C
Water flow rate			l/min
CONDENSING BOILERS ONLY			
The condensate drain has been installed in accordance with the manufacturer's instructions and/or BS5546/BS6798			Yes <input type="checkbox"/>
ALL INSTALLATIONS			
Record the following:	At max. rate: CO ppm	AND	CO/CO ₂ Ratio
	At min. rate: (where possible) CO ppm	AND	CO/CO ₂ Ratio
Mandatory Requirement	CO ₂ @Max Rate %	CO ₂ @Min Rate %	
The heating and hot water system complies with the appropriate Building Regulations			Yes <input type="checkbox"/>
The boiler and associated products have been installed and commissioned in accordance with the manufacturer's instructions			Yes <input type="checkbox"/>
The operation of the boiler and system controls have been demonstrated to and understood by the customer			Yes <input type="checkbox"/>
The manufacturer's literature, including Benchmark Checklist and Service Record, has been explained and left with the customer			Yes <input type="checkbox"/>
Commissioning Engineer's Signature			
Customer's Signature			
(To confirm satisfactory demonstration and receipt of manufacturer's literature)			

All installations in England and Wales must be notified to Local Authority Building Control (LABC) either directly or through a Competent Persons Scheme. A Building Regulations Compliance Certificate will then be issued to the customer.

© Heating and Hotwater Industry Council (HHIC)



SERVICE INTERVAL RECORD

It is necessary that your heating system is serviced annually to validate your warranty and that the appropriate Service Interval Record is completed.

Service Provider

Before completing the appropriate Service Record below, please ensure you have carried out the service as described in the manufacturer's instructions. Always use the manufacturer's specified spares when replacing parts.

<table border="1" style="width:100%; border-collapse: collapse;"> <tr> <td colspan="2">SERVICE 01</td> <td>Date:</td> </tr> <tr><td colspan="3">Engineer name:</td></tr> <tr><td colspan="3">Company name:</td></tr> <tr><td colspan="3">Telephone No:</td></tr> <tr><td colspan="3">Gas safe register No:</td></tr> <tr> <td>Record:</td> <td>At max. rate: CO ppm AND CO₂ %</td> <td></td> </tr> <tr> <td></td> <td>At min. rate: CO ppm AND CO₂ %</td> <td></td> </tr> <tr> <td>CO/CO₂ Ratio</td> <td>min. rate</td> <td>max rate</td> </tr> <tr><td colspan="3">Comments:</td></tr> <tr><td colspan="3">Signature</td></tr> </table>	SERVICE 01		Date:	Engineer name:			Company name:			Telephone No:			Gas safe register No:			Record:	At max. rate: CO ppm AND CO ₂ %			At min. rate: CO ppm AND CO ₂ %		CO/CO ₂ Ratio	min. rate	max rate	Comments:			Signature			<table border="1" style="width:100%; border-collapse: collapse;"> <tr> <td colspan="2">SERVICE 02</td> <td>Date:</td> </tr> <tr><td colspan="3">Engineer name:</td></tr> <tr><td colspan="3">Company name:</td></tr> <tr><td colspan="3">Telephone No:</td></tr> <tr><td colspan="3">Gas safe register No:</td></tr> <tr> <td>Record:</td> <td>At max. rate: CO ppm AND CO₂ %</td> <td></td> </tr> <tr> <td></td> <td>At min. rate: CO ppm AND CO₂ %</td> <td></td> </tr> <tr> <td>CO/CO₂ Ratio</td> <td>min. rate</td> <td>max rate</td> </tr> <tr><td colspan="3">Comments:</td></tr> <tr><td colspan="3">Signature</td></tr> </table>	SERVICE 02		Date:	Engineer name:			Company name:			Telephone No:			Gas safe register No:			Record:	At max. rate: CO ppm AND CO ₂ %			At min. rate: CO ppm AND CO ₂ %		CO/CO ₂ Ratio	min. rate	max rate	Comments:			Signature		
SERVICE 01		Date:																																																											
Engineer name:																																																													
Company name:																																																													
Telephone No:																																																													
Gas safe register No:																																																													
Record:	At max. rate: CO ppm AND CO ₂ %																																																												
	At min. rate: CO ppm AND CO ₂ %																																																												
CO/CO ₂ Ratio	min. rate	max rate																																																											
Comments:																																																													
Signature																																																													
SERVICE 02		Date:																																																											
Engineer name:																																																													
Company name:																																																													
Telephone No:																																																													
Gas safe register No:																																																													
Record:	At max. rate: CO ppm AND CO ₂ %																																																												
	At min. rate: CO ppm AND CO ₂ %																																																												
CO/CO ₂ Ratio	min. rate	max rate																																																											
Comments:																																																													
Signature																																																													
<table border="1" style="width:100%; border-collapse: collapse;"> <tr> <td colspan="2">SERVICE 03</td> <td>Date:</td> </tr> <tr><td colspan="3">Engineer name:</td></tr> <tr><td colspan="3">Company name:</td></tr> <tr><td colspan="3">Telephone No:</td></tr> <tr><td colspan="3">Gas safe register No:</td></tr> <tr> <td>Record:</td> <td>At max. rate: CO ppm AND CO₂ %</td> <td></td> </tr> <tr> <td></td> <td>At min. rate: CO ppm AND CO₂ %</td> <td></td> </tr> <tr> <td>CO/CO₂ Ratio</td> <td>min. rate</td> <td>max rate</td> </tr> <tr><td colspan="3">Comments:</td></tr> <tr><td colspan="3">Signature</td></tr> </table>	SERVICE 03		Date:	Engineer name:			Company name:			Telephone No:			Gas safe register No:			Record:	At max. rate: CO ppm AND CO ₂ %			At min. rate: CO ppm AND CO ₂ %		CO/CO ₂ Ratio	min. rate	max rate	Comments:			Signature			<table border="1" style="width:100%; border-collapse: collapse;"> <tr> <td colspan="2">SERVICE 04</td> <td>Date:</td> </tr> <tr><td colspan="3">Engineer name:</td></tr> <tr><td colspan="3">Company name:</td></tr> <tr><td colspan="3">Telephone No:</td></tr> <tr><td colspan="3">Gas safe register No:</td></tr> <tr> <td>Record:</td> <td>At max. rate: CO ppm AND CO₂ %</td> <td></td> </tr> <tr> <td></td> <td>At min. rate: CO ppm AND CO₂ %</td> <td></td> </tr> <tr> <td>CO/CO₂ Ratio</td> <td>min. rate</td> <td>max rate</td> </tr> <tr><td colspan="3">Comments:</td></tr> <tr><td colspan="3">Signature</td></tr> </table>	SERVICE 04		Date:	Engineer name:			Company name:			Telephone No:			Gas safe register No:			Record:	At max. rate: CO ppm AND CO ₂ %			At min. rate: CO ppm AND CO ₂ %		CO/CO ₂ Ratio	min. rate	max rate	Comments:			Signature		
SERVICE 03		Date:																																																											
Engineer name:																																																													
Company name:																																																													
Telephone No:																																																													
Gas safe register No:																																																													
Record:	At max. rate: CO ppm AND CO ₂ %																																																												
	At min. rate: CO ppm AND CO ₂ %																																																												
CO/CO ₂ Ratio	min. rate	max rate																																																											
Comments:																																																													
Signature																																																													
SERVICE 04		Date:																																																											
Engineer name:																																																													
Company name:																																																													
Telephone No:																																																													
Gas safe register No:																																																													
Record:	At max. rate: CO ppm AND CO ₂ %																																																												
	At min. rate: CO ppm AND CO ₂ %																																																												
CO/CO ₂ Ratio	min. rate	max rate																																																											
Comments:																																																													
Signature																																																													
<table border="1" style="width:100%; border-collapse: collapse;"> <tr> <td colspan="2">SERVICE 05</td> <td>Date:</td> </tr> <tr><td colspan="3">Engineer name:</td></tr> <tr><td colspan="3">Company name:</td></tr> <tr><td colspan="3">Telephone No:</td></tr> <tr><td colspan="3">Gas safe register No:</td></tr> <tr> <td>Record:</td> <td>At max. rate: CO ppm AND CO₂ %</td> <td></td> </tr> <tr> <td></td> <td>At min. rate: CO ppm AND CO₂ %</td> <td></td> </tr> <tr> <td>CO/CO₂ Ratio</td> <td>min. rate</td> <td>max rate</td> </tr> <tr><td colspan="3">Comments:</td></tr> <tr><td colspan="3">Signature</td></tr> </table>	SERVICE 05		Date:	Engineer name:			Company name:			Telephone No:			Gas safe register No:			Record:	At max. rate: CO ppm AND CO ₂ %			At min. rate: CO ppm AND CO ₂ %		CO/CO ₂ Ratio	min. rate	max rate	Comments:			Signature			<table border="1" style="width:100%; border-collapse: collapse;"> <tr> <td colspan="2">SERVICE 06</td> <td>Date:</td> </tr> <tr><td colspan="3">Engineer name:</td></tr> <tr><td colspan="3">Company name:</td></tr> <tr><td colspan="3">Telephone No:</td></tr> <tr><td colspan="3">Gas safe register No:</td></tr> <tr> <td>Record:</td> <td>At max. rate: CO ppm AND CO₂ %</td> <td></td> </tr> <tr> <td></td> <td>At min. rate: CO ppm AND CO₂ %</td> <td></td> </tr> <tr> <td>CO/CO₂ Ratio</td> <td>min. rate</td> <td>max rate</td> </tr> <tr><td colspan="3">Comments:</td></tr> <tr><td colspan="3">Signature</td></tr> </table>	SERVICE 06		Date:	Engineer name:			Company name:			Telephone No:			Gas safe register No:			Record:	At max. rate: CO ppm AND CO ₂ %			At min. rate: CO ppm AND CO ₂ %		CO/CO ₂ Ratio	min. rate	max rate	Comments:			Signature		
SERVICE 05		Date:																																																											
Engineer name:																																																													
Company name:																																																													
Telephone No:																																																													
Gas safe register No:																																																													
Record:	At max. rate: CO ppm AND CO ₂ %																																																												
	At min. rate: CO ppm AND CO ₂ %																																																												
CO/CO ₂ Ratio	min. rate	max rate																																																											
Comments:																																																													
Signature																																																													
SERVICE 06		Date:																																																											
Engineer name:																																																													
Company name:																																																													
Telephone No:																																																													
Gas safe register No:																																																													
Record:	At max. rate: CO ppm AND CO ₂ %																																																												
	At min. rate: CO ppm AND CO ₂ %																																																												
CO/CO ₂ Ratio	min. rate	max rate																																																											
Comments:																																																													
Signature																																																													
<table border="1" style="width:100%; border-collapse: collapse;"> <tr> <td colspan="2">SERVICE 07</td> <td>Date:</td> </tr> <tr><td colspan="3">Engineer name:</td></tr> <tr><td colspan="3">Company name:</td></tr> <tr><td colspan="3">Telephone No:</td></tr> <tr><td colspan="3">Gas safe register No:</td></tr> <tr> <td>Record:</td> <td>At max. rate: CO ppm AND CO₂ %</td> <td></td> </tr> <tr> <td></td> <td>At min. rate: CO ppm AND CO₂ %</td> <td></td> </tr> <tr> <td>CO/CO₂ Ratio</td> <td>min. rate</td> <td>max rate</td> </tr> <tr><td colspan="3">Comments:</td></tr> <tr><td colspan="3">Signature</td></tr> </table>	SERVICE 07		Date:	Engineer name:			Company name:			Telephone No:			Gas safe register No:			Record:	At max. rate: CO ppm AND CO ₂ %			At min. rate: CO ppm AND CO ₂ %		CO/CO ₂ Ratio	min. rate	max rate	Comments:			Signature			<table border="1" style="width:100%; border-collapse: collapse;"> <tr> <td colspan="2">SERVICE 08</td> <td>Date:</td> </tr> <tr><td colspan="3">Engineer name:</td></tr> <tr><td colspan="3">Company name:</td></tr> <tr><td colspan="3">Telephone No:</td></tr> <tr><td colspan="3">Gas safe register No:</td></tr> <tr> <td>Record:</td> <td>At max. rate: CO ppm AND CO₂ %</td> <td></td> </tr> <tr> <td></td> <td>At min. rate: CO ppm AND CO₂ %</td> <td></td> </tr> <tr> <td>CO/CO₂ Ratio</td> <td>min. rate</td> <td>max rate</td> </tr> <tr><td colspan="3">Comments:</td></tr> <tr><td colspan="3">Signature</td></tr> </table>	SERVICE 08		Date:	Engineer name:			Company name:			Telephone No:			Gas safe register No:			Record:	At max. rate: CO ppm AND CO ₂ %			At min. rate: CO ppm AND CO ₂ %		CO/CO ₂ Ratio	min. rate	max rate	Comments:			Signature		
SERVICE 07		Date:																																																											
Engineer name:																																																													
Company name:																																																													
Telephone No:																																																													
Gas safe register No:																																																													
Record:	At max. rate: CO ppm AND CO ₂ %																																																												
	At min. rate: CO ppm AND CO ₂ %																																																												
CO/CO ₂ Ratio	min. rate	max rate																																																											
Comments:																																																													
Signature																																																													
SERVICE 08		Date:																																																											
Engineer name:																																																													
Company name:																																																													
Telephone No:																																																													
Gas safe register No:																																																													
Record:	At max. rate: CO ppm AND CO ₂ %																																																												
	At min. rate: CO ppm AND CO ₂ %																																																												
CO/CO ₂ Ratio	min. rate	max rate																																																											
Comments:																																																													
Signature																																																													
<table border="1" style="width:100%; border-collapse: collapse;"> <tr> <td colspan="2">SERVICE 09</td> <td>Date:</td> </tr> <tr><td colspan="3">Engineer name:</td></tr> <tr><td colspan="3">Company name:</td></tr> <tr><td colspan="3">Telephone No:</td></tr> <tr><td colspan="3">Gas safe register No:</td></tr> <tr> <td>Record:</td> <td>At max. rate: CO ppm AND CO₂ %</td> <td></td> </tr> <tr> <td></td> <td>At min. rate: CO ppm AND CO₂ %</td> <td></td> </tr> <tr> <td>CO/CO₂ Ratio</td> <td>min. rate</td> <td>max rate</td> </tr> <tr><td colspan="3">Comments:</td></tr> <tr><td colspan="3">Signature</td></tr> </table>	SERVICE 09		Date:	Engineer name:			Company name:			Telephone No:			Gas safe register No:			Record:	At max. rate: CO ppm AND CO ₂ %			At min. rate: CO ppm AND CO ₂ %		CO/CO ₂ Ratio	min. rate	max rate	Comments:			Signature			<table border="1" style="width:100%; border-collapse: collapse;"> <tr> <td colspan="2">SERVICE 10</td> <td>Date:</td> </tr> <tr><td colspan="3">Engineer name:</td></tr> <tr><td colspan="3">Company name:</td></tr> <tr><td colspan="3">Telephone No:</td></tr> <tr><td colspan="3">Gas safe register No:</td></tr> <tr> <td>Record:</td> <td>At max. rate: CO ppm AND CO₂ %</td> <td></td> </tr> <tr> <td></td> <td>At min. rate: CO ppm AND CO₂ %</td> <td></td> </tr> <tr> <td>CO/CO₂ Ratio</td> <td>min. rate</td> <td>max rate</td> </tr> <tr><td colspan="3">Comments:</td></tr> <tr><td colspan="3">Signature</td></tr> </table>	SERVICE 10		Date:	Engineer name:			Company name:			Telephone No:			Gas safe register No:			Record:	At max. rate: CO ppm AND CO ₂ %			At min. rate: CO ppm AND CO ₂ %		CO/CO ₂ Ratio	min. rate	max rate	Comments:			Signature		
SERVICE 09		Date:																																																											
Engineer name:																																																													
Company name:																																																													
Telephone No:																																																													
Gas safe register No:																																																													
Record:	At max. rate: CO ppm AND CO ₂ %																																																												
	At min. rate: CO ppm AND CO ₂ %																																																												
CO/CO ₂ Ratio	min. rate	max rate																																																											
Comments:																																																													
Signature																																																													
SERVICE 10		Date:																																																											
Engineer name:																																																													
Company name:																																																													
Telephone No:																																																													
Gas safe register No:																																																													
Record:	At max. rate: CO ppm AND CO ₂ %																																																												
	At min. rate: CO ppm AND CO ₂ %																																																												
CO/CO ₂ Ratio	min. rate	max rate																																																											
Comments:																																																													
Signature																																																													

*All installations in England and Wales must be notified to Local Authority Building Control (LABC) either directly or through a Competent Persons Scheme. A Building Regulations Compliance Certificate will then be issued to the customer.



A series of 20 horizontal lines spanning the width of the page, providing a template for writing.



Intergas Heating Ltd

Intergas Heating Limited
Unit 2
Easter Park
Worcester Road
Kidderminster
DY11 7AR
Tel: 01527 888000
Fax: 01384 279480
info@intergasheating.co.uk
www.intergasheating.co.uk



2019 Intergas Heating Ltd.

All rights reserved.

The information provided applies to the standard version of the product. Intergas Heating Ltd can therefore not be held liable for any damage ensuing from specifications that deviate from the standard version of the product. Although the available information has been composed with all possible care, Intergas Heating Ltd cannot be held liable for any errors in the information or for the consequences of such. Intergas Heating Ltd cannot be held liable for damage ensuing from activities that are performed by third parties.

Subject to modifications.



84010402

INTERGAS®