

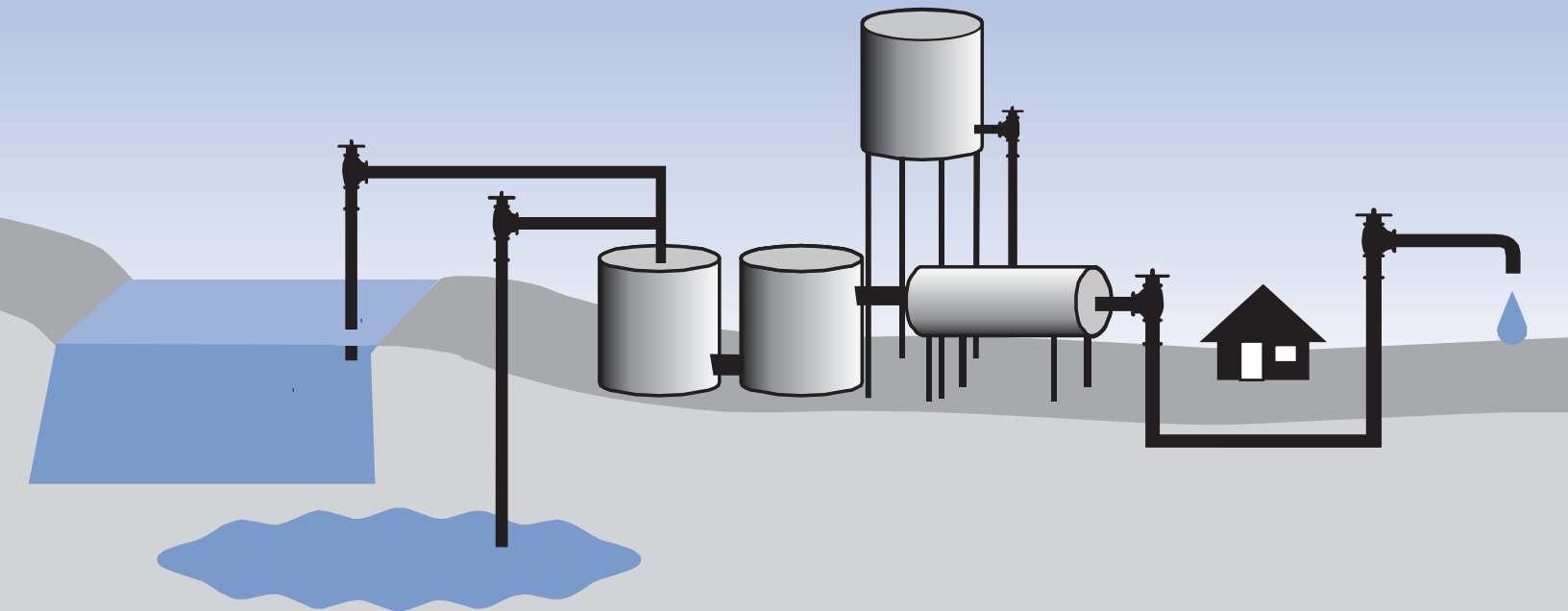

# Arsenic Treatment Technology Evaluation Handbook for Small Systems



**Office of Water (4606M)**  
**EPA 816-R-03-014**  
**July 2003**  
**[www.epa.gov/safewater](http://www.epa.gov/safewater)**

# Disclaimer

---

The information in this document has been subjected to the Agency's peer and administrative reviews and has been approved for publication as an EPA document. Mention of trade names or commercial products does not constitute an endorsement or recommendation of use.

This page intentionally left blank.

# Executive Summary

---

In January 2001, the U.S. Environmental Protection Agency (USEPA) published a final Arsenic Rule in the Federal Register. This rule established a revised maximum contaminant level (MCL) for arsenic at 0.010 mg/L. All community and non-transient, non-community (NTNC) water systems, regardless of size, will be required to achieve compliance with this rule by January 2006.

This technical handbook is intended to help small drinking water systems make treatment decisions to comply with the revised arsenic rule. A “small” system is defined as a system serving 10,000 or fewer people. Average water demand for these size systems is normally less than 1.4 million gallons per day (MGD).

Provided below is a checklist of activities that should normally take place in order to comply with the new Arsenic Rule. Many of the items on this checklist refer to a section in this handbook that may help in completing the activities.

## Arsenic Mitigation Checklist

1. Monitor arsenic concentration at each entry point to the distribution system (see Section 1.3.2).
2. Determine compliance status. This may require quarterly monitoring. See Section 1.3.2 for details on Arsenic Rule compliance.
3. Determine if a non-treatment mitigation strategy such as source abandonment or blending can be implemented. See Sections 2.1.1 through 2.1.3 for more detail and Decision Tree 1, *Non-Treatment Alternatives*.
4. Measure water quality parameters. See Section 3.1.1 for more detail on water quality parameters that are used in selecting a treatment method.
  - Arsenic, Total
  - Arsenate [As(V)]
  - Arsenite [As(III)]
  - Chloride
  - Fluoride
  - Iron
  - Manganese
  - Nitrate
  - Nitrite
  - Orthophosphate
  - pH
  - Silica
  - Sulfate
  - Total Dissolved Solids (TDS)
  - Total Organic Carbon (TOC)
5. Determine the treatment evaluation criteria. See Section 3.1.2 for more detail on parameters that are used in selecting a treatment method.
  - Existing Treatment Processes
  - Target Finished Water Arsenic Concentration

- Technically Based Local Limits (TBLLs) for Arsenic and TDS
  - Domestic Waste Discharge Method
  - Land Availability
  - Labor Commitment
  - Acceptable Percent Water Loss
  - Maximum Source Flowrate
  - Average Source Flowrate
  - State or primacy agency requirements that are more stringent than those of the USEPA.
6. Select a mitigation strategy using the decision trees provided in Section 3.2. These trees lead to the following mitigation strategies.
- Non-Treatment & Treatment Minimization Strategies
    - Source Abandonment
    - Seasonal Use
    - Blending Before Entry to Distribution System
    - Sidestream Treatment
  - Enhance Existing Treatment Processes
    - Enhanced Coagulation/Filtration
    - Enhanced Lime Softening
    - Iron/Manganese Filtration
  - Treatment (Full Stream or Sidestream)
    - Ion Exchange
    - Activated Alumina
    - Iron Based Sorbents
    - Coagulation-Assisted Microfiltration (CMF)
    - Coagulation-Assisted Direct Filtration (CADF)
    - Oxidation/Filtration
  - Point-of-Use Treatment Program
    - Activated Alumina
    - Iron Based Sorbent
    - Reverse Osmosis
7. Estimate planning-level capital and operations and maintenance (O&M) costs for the mitigation strategy using the costs curves provided in Section 4. Include costs for arsenic removal and waste handling. If this planning level cost is not within a range that is financially possible, consider using different preferences in the decision trees.
8. Evaluate design considerations for the mitigation strategy. See Section 2.5 for enhancing existing treatment processes and Sections 6 through 8 for the design of new treatment processes.

9. Pilot the mitigation strategy. Although not explicitly discussed in this Handbook, piloting the mitigation strategy is a normal procedure to optimize treatment variables and avoid implementing a strategy that will not work for unforeseen reasons. For many small systems, piloting may be performed by the vendor and result in a guarantee from the vendor that the system will perform.
10. Develop a construction-level cost estimate and plan.
11. Implement the mitigation strategy.
12. Monitor arsenic concentration at each entry point to the distribution system to ensure that the arsenic levels are now in compliance with the Arsenic Rule – assumes centralized treatment approach, not point-of-use treatment.

Table ES-1 provides a summary of information about the different alternatives for arsenic mitigation found in this Handbook. Please note that systems are not limited to using these technologies.

**Table ES-1. Arsenic Treatment Technologies Summary Comparison.**  
(1 of 2)

Factors	Sorption Processes			Membrane Processes
	Ion Exchange	Activated Alumina <sup>A</sup>	Iron Based Sorbents	Reverse Osmosis
	IX	AA	IBS	RO
USEPA BAT <sup>B</sup>	Yes	Yes	No <sup>C</sup>	Yes
USEPA SSCT <sup>B</sup>	Yes	Yes	No <sup>C</sup>	Yes
System Size <sup>B,D</sup>	25-10,000	25-10,000	25-10,000	501-10,000
SSCT for POU <sup>B</sup>	No	Yes	No <sup>C</sup>	Yes
POU System Size <sup>B,D</sup>	-	25-10,000	25-10,000	25 -10,000
Removal Efficiency	95% <sup>E</sup>	95% <sup>E</sup>	up to 98% <sup>E</sup>	> 95% <sup>E</sup>
Total Water Loss	1-2%	1-2%	1- 2%	15-75%
Pre-Oxidation Required <sup>F</sup>	Yes	Yes	Yes <sup>G</sup>	Likely <sup>H</sup>
Optimal Water Quality Conditions	pH 6.5 - 9 <sup>E</sup> < 5 mg/L NO <sub>3</sub> <sup>-1</sup> < 50 mg/L SO <sub>4</sub> <sup>2-1</sup> < 500 mg/L TDS <sup>K</sup> < 0.3 NTU Turbidity	pH 5.5 - 6 <sup>1</sup> pH 6 - 8.3 <sup>L</sup> < 250 mg/L Cl <sup>1</sup> < 2 mg/L F <sup>-1</sup> < 360 mg/L SO <sub>4</sub> <sup>2-K</sup> < 30 mg/L Silica <sup>M</sup> < 0.5 mg/L Fe <sup>+3 1</sup> < 0.05 mg/L Mn <sup>+2 1</sup> < 1,000 mg/L TDS <sup>K</sup> < 4 mg/L TOC <sup>K</sup> < 0.3 NTU Turbidity	pH 6 - 8.5 < 1 mg/L PO <sub>4</sub> <sup>-3 N</sup> < 0.3 NTU Turbidity	No Particulates
Operator Skill Required	High	Low <sup>A</sup>	Low	Medium
Waste Generated	Spent Resin, Spent Brine, Backwash Water	Spent Media, Backwash Water	Spent Media, Backwash Water	Reject Water
Other Considerations	Possible pre & post pH adjustment. Pre-filtration required. Potentially hazardous brine waste. Nitrate peaking. Carbonate peaking affects pH.	Possible pre & post pH adjustment. Pre-filtration may be required. Modified AA available.	Media may be very expensive. <sup>O</sup> Pre-filtration may be required.	High water loss (15-75% of feed water)
Centralized Cost	Medium	Medium	Medium	High
POU Cost	-	Medium	Medium	Medium

<sup>A</sup> Activated alumina is assumed to operate in a non-regenerated mode.

<sup>B</sup> USEPA, 2002a.

<sup>C</sup> IBS's track record in the US was not established enough to be considered as Best Available Technology (BAT) or Small System Compliance Technology (SSCT) at the time the rule was promulgated.

<sup>D</sup> Affordable for systems with the given number of people served.

<sup>E</sup> USEPA, 2000.

<sup>F</sup> Pre-oxidation only required for As(III).

<sup>G</sup> Some iron based sorbents may catalyze the As(III) to As(V) oxidation and therefore would not require a pre-oxidation step.

<sup>H</sup> RO will remove As(III), but its efficiency is not consistent and pre-oxidation will increase removal efficiency.

<sup>I</sup> AwwaRF, 2002.

<sup>J</sup> Kempic, 2002.

<sup>K</sup> Wang, 2000.

<sup>L</sup> AA can be used economically at higher pHs, but with a significant decrease in the capacity of the media.

<sup>M</sup> Clifford, 2001.

<sup>N</sup> Tumalo, 2002.

<sup>O</sup> With increased domestic use, IBS cost will significantly decrease.



**Table ES-1. Arsenic Treatment Technologies Summary Comparison.  
(2 of 2)**

Factors	Precipitative Processes				
	Enhanced Lime Softening	Enhanced (Conventional) Coagulation Filtration	Coagulation--Assisted Micro-Filtration	Coagulation-Assisted Direct Filtration	Oxidation Filtration
	LS	CF	CMF	CADF	OxFilt
USEPA BAT <sup>B</sup>	Yes	Yes	No	Yes	Yes
USEPA SSCT <sup>B</sup>	No	No	Yes	Yes	Yes
System Size <sup>B,D</sup>	25-10,000	25-10,000	500-10,000	500-10,000	25-10,000
SSCT for POU <sup>B</sup>	No	No	No	No	No
POU System Size <sup>B,D</sup>	-	-	-	-	-
Removal Efficiency	90% <sup>E</sup>	95% (w/ FeCl <sub>3</sub> ) <sup>E</sup> < 90% (w/ Alum) <sup>E</sup>	90% <sup>E</sup>	90% <sup>E</sup>	50-90% <sup>E</sup>
Total Water Loss	0%	0%	5%	1-2%	1-2%
Pre-Oxidation Required <sup>F</sup>	Yes	Yes	Yes	Yes	Yes
Optimal Water Quality Conditions	pH 10.5 - 11 <sup>1</sup> > 5 mg/L Fe <sup>+3</sup> <sup>1</sup>	pH 5.5 - 8.5 <sup>P</sup>	pH 5.5 - 8.5 <sup>P</sup>	pH 5.5 - 8.5 <sup>P</sup>	pH 5.5 - 8.5 >0.3 mg/L Fe Fe:As Ratio > 20:1
Operator Skill Required	High	High	High	High	Medium
Waste Generated	Backwash Water, Sludge (high volume)	Backwash Water, Sludge	Backwash Water, Sludge	Backwash Water, Sludge	Backwash Water, Sludge
Other Considerations	Treated water requires pH adjustment.	Possible pre & post pH adjustment.	Possible pre & post pH adjustment.	Possible pre & post pH adjustment.	None.
Centralized Cost	Low <sup>Q</sup>	Low <sup>Q</sup>	High	Medium	Medium
POU Cost	N/A	N/A	N/A	N/A	N/A

<sup>B</sup> USEPA, 2002a.

<sup>D</sup> Affordable for systems with the given number of people served.

<sup>E</sup> Depends on arsenic and iron concentrations.

<sup>F</sup> Pre-oxidation only required for As(III).

<sup>1</sup> AwwaRF, 2002.

<sup>P</sup> Fields, et al, 2002a.

<sup>Q</sup> Costs for enhanced LS and enhanced CF are based on modification of an existing technology. Most small systems will not have this technology in place.

This page intentionally left blank.

# Contents

---

<b>EXECUTIVE SUMMARY .....</b>	<b><i>i</i></b>
<b>CONTENTS .....</b>	<b><i>vii</i></b>
<b>LIST OF FIGURES .....</b>	<b><i>x</i></b>
<b>LIST OF TABLES .....</b>	<b><i>xiii</i></b>
<b>LIST OF ACRONYMS AND ABBREVIATIONS .....</b>	<b><i>xiv</i></b>
<b>EQUATION NOMENCLATURE .....</b>	<b><i>xvii</i></b>
<b>1.0 BACKGROUND .....</b>	<b>1</b>
1.1 Purpose of this Handbook .....	1
1.2 How to Use this Handbook .....	1
1.3 Regulatory Direction .....	2
1.3.1 The Arsenic Rule .....	2
1.3.2 Health Effects .....	3
1.3.3 Other Drinking Water Regulations .....	4
1.3.4 Waste Disposal Regulations .....	5
1.4 Arsenic Chemistry .....	8
<b>2.0 ARSENIC MITIGATION STRATEGIES .....</b>	<b>11</b>
2.1 Description of Arsenic Mitigation Strategies .....	11
2.1.1 Abandonment .....	12
2.1.2 Seasonal Use .....	12
2.1.3 Blending .....	13
2.1.4 Treatment .....	15
2.1.5 Sidestream Treatment .....	16
2.2 Pre-Oxidation Processes .....	18
2.2.1 Chlorine .....	19
2.2.2 Permanganate .....	20
2.2.3 Ozone .....	21
2.2.4 Solid Phase Oxidants (Filox-R™) .....	22
2.3 Sorption Treatment Processes .....	23
2.3.1 Ion Exchange .....	24
2.3.2 Activated Alumina .....	26
2.3.3 Iron Based Sorbents .....	29
2.4 Membrane Treatment Processes .....	30
2.5 Precipitation/Filtration Treatment Processes .....	32
2.5.1 Enhanced Lime Softening .....	32
2.5.2 Conventional Gravity Coagulation/Filtration .....	33

2.5.3	Coagulation-Assisted Microfiltration .....	34
2.5.5	Oxidation/Filtration .....	35
2.6	Point-of-Use Treatment .....	37
<b>3.0</b>	<b>ARSENIC TREATMENT SELECTION .....</b>	<b>39</b>
3.1	Selection Criteria .....	39
3.1.1	Source Water Quality .....	39
3.1.2	Process Evaluation Basis .....	41
3.2	Process Selection Decision Trees .....	41
<b>4.0</b>	<b>PLANNING-LEVEL TREATMENT COSTS .....</b>	<b>55</b>
4.1	Pre-Oxidation System Costs Using Chlorine .....	57
4.2	Ion Exchange System Costs .....	58
4.3	Activated Alumina System Costs .....	63
4.4	Iron Based Sorbent System Costs .....	68
4.5	Greensand System Costs .....	68
4.6	Coagulation Assisted Microfiltration System Costs .....	71
4.7	Coagulation/Filtration System Enhancement Costs .....	74
4.8	Lime Softening System Enhancement Costs .....	76
4.9	Point-of-Use Reverse Osmosis System Costs .....	77
4.10	Point-of-Use Activated Alumina System Costs .....	79
4.11	Point-of-Use Iron Based Sorbent System Costs .....	80
<b>5.0</b>	<b>PRE-OXIDATION DESIGN CONSIDERATIONS .....</b>	<b>81</b>
5.1	Chlorine Pre-Oxidation Design Considerations .....	81
5.1.1	Commercial Liquid Hypochlorite .....	82
5.1.2	On-Site Hypochlorite Generation .....	84
5.2	Permanganate Pre-Oxidation Design Considerations .....	86
5.3	Ozone Pre-Oxidation Design Considerations .....	88
5.4	Solid Phase Oxidant Pre-Oxidation Design Considerations .....	90
5.5	Comparison of Pre-Oxidation Alternatives .....	93
<b>6.0</b>	<b>SORPTION PROCESS DESIGN CONSIDERATIONS .....</b>	<b>95</b>
6.1	Process Flow .....	95
6.2	Column Rotation .....	96
6.3	Sorption Theory .....	97
6.3.1	Non-Regenerated Sorption Processes .....	98
6.3.2	Ion Exchange Processes .....	98
6.4	Process Design & Operational Parameters .....	100
6.5	Column Design .....	101
6.5.1	Column Diameter .....	102
6.5.2	Column Height .....	103
6.6	Media Replacement Frequency .....	104
6.7	Regeneration of Ion Exchange Resin .....	105
6.8	Waste Handling Systems .....	106

<b>7.0 PRESSURIZED MEDIA FILTRATION PROCESS DESIGN CONSIDERATIONS ...</b>	<b>107</b>
7.1 Process Flow .....	107
7.2 Process Design & Operational Parameters .....	109
7.3 Filter Design .....	110
7.3.1 Filter Diameter .....	113
7.3.2 Media Weight .....	113
7.4 Waste Handling System Design .....	114
7.5 Coagulant Addition System Design .....	115
<b>8.0 POINT-OF-USE TREATMENT .....</b>	<b>117</b>
8.1 Treatment Alternatives .....	117
8.1.1 Adsorption Point-of-Use Treatment .....	117
8.1.2 Reverse Osmosis Point-of-Use Treatment .....	119
8.2 Implementation Considerations .....	121
8.2.1 Program Oversight .....	121
8.2.2 Cost .....	122
8.2.3 Compliance Monitoring .....	122
8.2.4 Mechanical Warnings .....	122
8.2.5 Operations and Maintenance .....	122
8.2.6 Customer Education and Residential Access .....	123
8.2.7 Residual Oxidant in Distribution System .....	123
8.2.8 Waste Handling .....	123
8.3 Device Certification .....	124
<b>9.0 REFERENCES .....</b>	<b>125</b>

# List of Figures

---

Figure 1-1. Optimal pH Ranges for Arsenic Treatment Technologies. ....	4
Figure 1-2. Flow Diagram for RO POU. ....	8
Figure 1-3. Dissociation of Arsenite [As(III)]. ....	9
Figure 1-4. Dissociation of Arsenate [As(V)]. ....	9
Figure 2-1. Example of Seasonal High Arsenic Source Use. ....	13
Figure 2-2. Blending. ....	14
Figure 2-3. Sidestream Treatment. ....	16
Figure 2-4. Treatment and Blending. ....	16
Figure 2-5. Sidestream Treatment and Blending. ....	16
Figure 2-6. Sidestream Treatment. ....	17
Figure 2-7. Sidestream Treatment for RO. ....	17
Figure 2-8. Ion Exchange Process Flow Diagram. ....	24
Figure 2-9. Effect of Sulfate on Ion Exchange Performance (Clifford, 1999). ....	25
Figure 2-10. Activated Alumina Process Flow Diagram. ....	27
Figure 2-11. Effect of pH on Activated Alumina Performance ....	28
Figure 2-12. RO Membrane Process Flow Diagram. ....	30
Figure 2-13. Two-Stage RO Treatment Process Schematic. ....	31
Figure 2-14. Generic Precipitation/Filtration Process Flow Diagram. ....	32
Figure 3-1. Decision Tree Overview. ....	43
Figure 3-2. Decision Tree 1 – Non-Treatment Alternatives. ....	44
Figure 3-3. Decision Tree 2 - Treatment Selection. ....	45
Figure 3-4. Decision Tree 2a - Enhanced Coagulation/Filtration. ....	46
Figure 3-5. Decision Tree 2b - Enhanced Lime Softening. ....	47
Figure 3-6. Decision Tree 2c - Iron/Manganese Filtration. ....	48
Figure 3-7. Decision Tree 3 - Selecting New Treatment. ....	49
Figure 3-8. Decision Tree 3a - Ion Exchange Processes. ....	50
Figure 3-9. Decision Tree 3b - Sorption Processes. ....	51
Figure 3-10. Decision Tree 3c - Filtration and Membrane Processes. ....	52
Figure 4-1. Chlorination Capital Costs. ....	57
Figure 4-2. Chlorination O&M Costs. ....	58
Figure 4-3. Ion Exchange (<20 mg/L SO <sub>4</sub> <sup>2-</sup> ) Capital Costs. ....	59
Figure 4-4. Ion Exchange (<20 mg/L SO <sub>4</sub> <sup>2-</sup> ) O&M Costs. ....	59
Figure 4-5. Ion Exchange (<20 mg/L SO <sub>4</sub> <sup>2-</sup> ) Waste Disposal Capital Costs. ....	60

Figure 4-6. Ion Exchange (<20 mg/L SO <sub>4</sub> <sup>2-</sup> ) Waste Disposal O&M Costs. ....	60
Figure 4-7. Ion Exchange (20-50 mg/L SO <sub>4</sub> <sup>2-</sup> ) Capital Costs. ....	61
Figure 4-8. Ion Exchange (20-50 mg/L SO <sub>4</sub> <sup>2-</sup> ) O&M Costs. ....	61
Figure 4-9. Ion Exchange (20-50 mg/L SO <sub>4</sub> <sup>2-</sup> ) Waste Disposal Capital Costs. ....	62
Figure 4-10. Ion Exchange (20-50 mg/L SO <sub>4</sub> <sup>2-</sup> ) Waste Disposal O&M Costs. ....	62
Figure 4-11. Activated Alumina (Natural pH) Capital Costs. ....	63
Figure 4-12. Activated Alumina (Natural pH of 7-8) O&M Costs. ....	64
Figure 4-13. Activated Alumina (Natural pH of 7-8) Waste Disposal O&M Costs. ....	64
Figure 4-14. Activated Alumina (Natural pH of 8-8.3) O&M Costs. ....	65
Figure 4-15. Activated Alumina (Natural pH of 8.0-8.3) Waste Disposal O&M Costs. ....	65
Figure 4-16. Activated Alumina (pH Adjusted to 6.0) Capital Costs. ....	66
Figure 4-17. Activated Alumina (pH adjusted to 6.0 - 23,100 BV) O&M Costs. ....	66
Figure 4-18. Activated Alumina (pH adjusted to 6.0 - 23,100 BV) Waste Disposal O&M Costs. ....	67
Figure 4-19. Activated Alumina (pH adjusted to 6.0 - 15,400 BV) O&M Costs. ....	67
Figure 4-20. Activated Alumina (pH adjusted to 6.0 - 15,400 BV) Waste Disposal O&M Costs. ....	68
Figure 4-21. Greensand Capital Costs. ....	69
Figure 4-22. Greensand O&M Costs. ....	69
Figure 4-23. Greensand Waste Disposal Capital Costs. ....	70
Figure 4-24. Greensand Waste Disposal O&M Costs. ....	70
Figure 4-25. Coagulation Assisted Microfiltration Capital Costs. ....	71
Figure 4-26. Coagulation Assisted Microfiltration O&M Costs. ....	72
Figure 4-27. Coagulation Assisted Microfiltration (w/ Mechanical Dewatering) Waste Disposal Capital Costs. ....	72
Figure 4-28. Coagulation Assisted Microfiltration (w/ Mechanical Dewatering) Waste Disposal O&M Costs. ....	73
Figure 4-29. Coagulation Assisted Microfiltration (w/ Non-Mechanical Dewatering) Waste Disposal Capital Costs. ....	73
Figure 4-30. Coagulation Assisted Microfiltration (w/ Non-Mechanical Dewatering) Waste Disposal O&M Costs. ....	74
Figure 4-31. Coagulation/Filtration System Enhancement Capital Costs. ....	75
Figure 4-32. Coagulation/Filtration System Enhancement O&M Costs. ....	75
Figure 4-33. Lime Softening Enhancement Capital Costs. ....	76
Figure 4-34. Lime Softening Enhancement O&M Costs. ....	77
Figure 4-35. POU Reverse Osmosis Capital Costs. ....	78

Figure 4-36. POU Reverse Osmosis O&M Costs. ....	78
Figure 4-37. POU Activated Alumina Capital Costs. ....	79
Figure 4-38. POU Activated Alumina O&M Costs. ....	80
Figure 5-1. Typical Liquid Hypochlorite Process Flow Diagram. ....	83
Figure 5-2. Liquid Hypochlorite System Schematic (USFilter, Wallace & Tiernan). ....	83
Figure 5-3. Typical On-Site Hypochlorite Generation Process Flow Diagram. ....	85
Figure 5-4. On-Site Hypochlorite Generation System Schematic (USFilter, Wallace & Tiernan). ....	85
Figure 5-5. On-Site Hypochlorite Generation System (Severn Trent Services). ....	86
Figure 5-6. Typical Permanganate Process Flow Diagram. ....	87
Figure 5-7. Permanganate Dry Feed System (Merrick Industries, Inc.). ....	88
Figure 5-8. Permanganate Dry Feed System (Acrison, Inc.). ....	88
Figure 5-9. Typical Ozonation Process Flow Diagram. ....	89
Figure 5-10. Ozone Generator and Contactor (ProMinent). ....	90
Figure 5-11. Typical Solid Phase Oxidant Arsenic Oxidation Process Flow Diagram. ....	90
Figure 5-12. Venturi Air Injector Assembly Schematic (Mazzei). ....	91
Figure 6-1. Sorption Treatment Process Flow Diagram w/o pH Adjustment and Regeneration. ....	95
Figure 6-2. Sorption Treatment Process Flow Diagram w/ pH Adjustment and Regeneration. ....	95
Figure 6-3. Sorption Column Operation Modes. ....	97
Figure 6-4. Multi-Component Ion Exchange. ....	98
Figure 6-5. Activity of Nitrate and Nitrite During Ion Exchange. ....	99
Figure 6-6. Ion Exchange System (Tonka Equipment Company). ....	102
Figure 6-7. Process Flow Diagram for Example Problem. ....	104
Figure 7-1. Typical Media Filtration Process Flow Diagram. ....	107
Figure 7-2. Media Filtration Process Flow Modes. ....	108
Figure 7-3. Schematic of a Vertical Greensand Pressure Filter. ....	110
Figure 7-4. Hub-Lateral Distribution System (Johnson Screens). ....	111
Figure 7-5. Header-Lateral Distribution System (Johnson Screens). ....	111
Figure 7-6. Multiple Media Filter Setup. ....	112
Figure 7-7. Pressurized Media Filter (USFilter). ....	112
Figure 7-8. Pre-Engineered Arsenic Filtration System (Kinetico). ....	113
Figure 7-9. Ferric Chloride Addition Flow Diagram. ....	116
Figure 8-1. Point-Of-Use Adsorption Setup (Kinetico). ....	118
Figure 8-2. Metered Automatic Cartridge (Kinetico). ....	119
Figure 8-3. Point-Of-Use Reverse Osmosis Setup (Kinetico). ....	120



# List of Tables

---

Table ES-1. Arsenic Treatment Technologies Summary Comparison. ....	<i>iv</i>
Table 1-1. Waste Disposal Options. ....	6
Table 2-1. Typical Treatment Efficiencies and Water Losses. ....	16
Table 2-2. Comparison of Oxidizing Agents. ....	19
Table 2-3. Water Quality Interferences with AA Adsorption. ....	28
Table 2-4. Examples of Iron Based Sorbents. ....	29
Table 3-1. Key Water Quality Parameters to be Monitored. ....	40
Table 3-2. Other Water Quality Parameters to be Monitored. ....	41
Table 3-3. Arsenic Treatment Technologies Summary Comparison. ....	53
Table 5-1. Typical Filox-R™ Design and Operating Parameters. ....	92
Table 5-2. Comparison of Pre-Oxidation Alternatives. ....	93
Table 6-1. Typical Sorption Treatment Design and Operating Parameters. ....	101
Table 7-1. Typical Greensand Column Design and Operating Parameters. ....	109

# List of Acronyms and Abbreviations

---

AA	Activated Alumina
Al	Aluminum
ANSI	American National Standards Institute
As	Arsenic
As(III)	Valence +3 Arsenic (found in Arsenite ion, $\text{AsO}_3^{-3}$ )
As(V)	Valence +5 Arsenic (found in Arsenate ion, $\text{AsO}_4^{-3}$ )
$\text{AsO}_3^{-3}$	Arsenite ion
$\text{AsO}_4^{-3}$	Arsenate ion
ASTM	American Society for Testing and Materials
AWWA	American Water Works Association
AwwaRF	American Water Works Association Research Foundation
BAT	Best Available Technology
BV	Bed Volume
cft	Cubic feet
$\text{Ca}^{+2}$	Calcium
$\text{CaCO}_3$	Calcium Carbonate
CADF	Coagulation-Assisted Direct Filtration
CCI	Construction Cost Index
CF	Enhanced (Conventional) Coagulation/Filtration
$\text{Cl}^-$	Chloride
$\text{Cl}_2$	Chlorine
CMF	Coagulation-Assisted Microfiltration
$\text{CO}_3^{-2}$	Carbonate
CT	Disinfectant Concentration Times Contact Time
CWA	Clean Water Act of 1987
DBP	Disinfection By-Product
DBPR	Disinfectants/Disinfection By-Products Rule
DO	Dissolved Oxygen
EBCT	Empty Bed Contact Time
ENR	Engineering News Record
$\text{F}^-$	Fluoride
$\text{Fe}, \text{Fe}^{+2}, \text{Fe}^{+3}$	Iron
$\text{FeCl}_3$	Ferric Chloride
$\text{Fe}(\text{OH})_3$	Ferric Hydroxide
ft	Feet
FTW	Filter-To-Waste
g	Gram
gal	Gallon
GFH	Granular Ferric Hydroxide
gpd	Gallons per Day
gph	Gallons per Hour

gpm	Gallons per Minute
hr	Hour
H <sup>+</sup>	Hydronium, Hydrogen ion
H <sub>2</sub> AsO <sub>3</sub> <sup>-</sup>	Monovalent Arsenite Ion
H <sub>2</sub> AsO <sub>4</sub> <sup>-</sup>	Monovalent Arsenate Ion
H <sub>2</sub> O	Water
H <sub>2</sub> S	Hydrogen Sulfide
H <sub>2</sub> SO <sub>4</sub>	Sulfuric Acid
H <sub>3</sub> AsO <sub>3</sub>	Arsenite Molecule
H <sub>3</sub> AsO <sub>4</sub>	Arsenate Molecule
HAA5	Haloacetic Acid
HAsO <sub>3</sub> <sup>-2</sup>	Divalent Arsenite Ion
HAsO <sub>4</sub> <sup>-2</sup>	Divalent Arsenate Ion
HCl	Hydrochloric Acid
HOCl	Hypochlorous Acid
HS <sup>-</sup>	Hydrogen Sulfide Ion
IBS	Iron Based Sorbents
in.	Inches
IESWTR	Interim Enhanced Surface Water Treatment Rule
IX	Ion Exchange
kg	kilogram
kWh	Kilowatt Hour
L	Liter
LACSL	Land Application Clean Sludge Limit
lb(s)	Pound(s)
LCR	Lead and Copper Rule
LS	Lime Softening
LT1ESWTR	Long Term-1 Enhanced Surface Water Treatment Rule
MCL	Maximum Contaminant Level
MF	Micro-Filtration
mg	Milligram
Mg	Magnesium
MGD	Million Gallons per Day
min.	Minute
mL	Milliliter
mm	Millimeter
Mn, Mn <sup>+2</sup>	Manganese
MnO <sub>2</sub>	Manganese Dioxide
MnO <sub>4</sub> <sup>-</sup>	Permanganate
MSHA	Mine Safety and Health Administration
MTZ	Mass Transfer Zone
N	Nitrogen
NaCl	Sodium Chloride
NaOCl	Sodium Hypochlorite
NaOH	Sodium Hydroxide

NIOSH	National Institute for Occupational Safety and Health
NIPDWRs	National Interim Primary Drinking Water Regulations
NO <sub>2</sub> <sup>-</sup>	Nitrite
NO <sub>3</sub> <sup>-</sup>	Nitrate
NOM	Natural Organic Matter
NPDES	National Pollutant Discharge Elimination System
NPDWRs	National Primary Drinking Water Regulations
NTNC	Non-Transient, Non-Community
NTU	Nephelometric Turbidity Units
O <sub>2</sub>	Oxygen
O <sub>3</sub>	Ozone
O&M	Operations and Maintenance
OCl <sup>-</sup>	Hypochlorite
OH <sup>-</sup>	Hydroxide
PFLT	Paint Filter Liquids Test
pH	Negative Log of Hydrogen Ion Concentration
PO <sub>4</sub> <sup>-3</sup>	Phosphate, Orthophosphate
POE	Point-of-Entry
POTW	Publicly Owned Treatment Works
POU	Point-of-Use
psi	Pounds per Square Inch
RCRA	Resource Conservation and Recovery Act
RO	Reverse Osmosis
S <sup>0</sup>	Sulfur, zero valence
SBA	Strong Base Anion exchange resin
scf	Standard Cubic Feet
scfm	Standard Cubic Feet per Minute
SDWA	Safe Drinking Water Act
sft	Square Feet
Si(OH) <sub>3</sub> O <sup>-</sup>	Silicate Ion
SO <sub>4</sub> <sup>2-</sup>	Sulfate
SSCT	Small System Compliance Technologies
SWTR	Surface Water Treatment Rule
TBLL	Technically Based Local Limit
TC	Toxicity Characteristic
TCLP	Toxicity Characteristic Leaching Procedure
TDS	Total Dissolved Solids
TTHM	Total Trihalomethanes
TOC	Total Organic Carbon
UFC	Uniform Fire Code
USEPA	United States Environmental Protection Agency
UV	Ultra-Violet
WET	Waste Extraction Test
wt%	Weight Percent
y	Year

# Equation Nomenclature

Symbol	Definition	Units
$BV_e$	Number of Bed Volumes to Exhaustion	-
$C_{As,j}$	Arsenic Concentration of Source $j$	mg/L
$C_{As,B}$	Arsenic Concentration of Blended Stream	mg/L
$C_{Cl_2}$	Chlorine Concentration	lbs $Cl_2$ /gal
$C_{FeCl_3}$	Ferric Chloride Stock Solution Concentration	wt%
$C_i$	Concentration of Species $i$ in the Feed Stream	mg/L
$C_k$	Arsenic Concentration Entering System During Quarter $k$	mg/L
$C_{MCL}$	Arsenic MCL	mg/L
$C_{MnO_4}$	Permanganate Stock Solution Concentration	mg/L
$C_{R,i}$	Concentration of Species $i$ in the Retentate	mg/L
$C_{RAA}$	Running Annual Average Arsenic Concentration	mg/L
$C_{TDS}$	Concentration of Total Dissolved Solids	g/L
$CCI_{Current}$	Construction Cost Index for the Current Year	-
$CCI_{1998}$	Construction Cost Index for 1998	-
$D$	Column Diameter	ft
$D_{Cl_2}$	Ultimate Chlorine Demand	mg/L as $Cl_2$
$D_{MnO_4}$	Ultimate Permanganate Demand	mg/L as Mn
$D_{O_2}$	Ultimate Oxygen Demand	mg/L
$D_{O_3}$	Ultimate Ozone Demand	mg/L
$E$	Overall Rejection Rate	%
$E_s$	Individual Stage Contaminant Rejection Rate	%
EBCT	Empty Bed Contact Time	minutes
$F$	Freeboard Allowance	%
$G_{BW}$	Backwash Flux	gpm/sft
$G_R$	Regeneration Flux	gpm/sft
HLR	Hydraulic Loading Rate	gpm/sft
$H$	Column Height	ft
$h_j$	Height of Media Layer $j$	ft
$i$	Annual Inflation Rate	%
$M_{Brine}$	Brine Molarity	mole/L
$M_{Cl_2}$	Chlorine Mass Flow	lb/day of $Cl_2$

Symbol	Definition	Units
$M_{O_3}$	Ozone Mass Flow	g/hr of $O_3$
$n$	Number of Stages	-
$n_p$	Number of Parallel Treatment Trains	-
$P_{1998}$	Year 1998 Cost	\$
$P_{Current}$	Current Cost	\$
$Q$	Design Flow Rate	gpm
$Q_j$	Flowrate of Source $j$	gpm
$Q_B$	Flowrate of Blended Stream	gpm
$Q_{BW}$	Backwash Flowrate	gpm
$Q_{Cl_2}$	Hypochlorite Metering Pump Rate	gph
$Q_{FeCl_3}$	Ferric Chloride Metering Pump Rate	mL/min
$Q_{MnO_4}$	Permanganate Metering Pump Rate	gph
$Q_S$	Flowrate to be Split off and Treated	gpm
$t$	Storage Time	days
$t_{BW}$	Backwash Duration	minutes
$t_{FTW}$	Filter-To-Waste Duration	minutes
$t_R$	Regeneration Duration	minutes
$V$	Storage Volume	gal
$V_{WW}$	Volume of Wastewater	gal
$W_j$	Weight of Media $j$	lbs
$Y_{Current}$	Current Year	-
$Z$	Depth of Media	ft
$\beta$	Individual Stage Water Recovery Rate	%
$\delta_{Cl_2}$	Chlorine Dose	mg/L as $Cl_2$
$\delta_{FeCl_3}$	Ferric Chloride Dose	mg/L
$\delta_{MnO_4}$	Permanganate Dose	mg/L as Mn
$\delta_{O_2}$	Oxygen Dose	mg/L
$\delta_{O_3}$	Ozone Dose	mg/L
$\epsilon$	Arsenic Rejection Rate	%
$\rho_{FeCl_3}$	Density of Ferric Chloride	kg/L
$\rho_j$	Bulk Density of Media $j$	lbs/cft
$\sigma$	Safety Margin	%
$\tau$	Optimal Filter Run Time	hr
$\omega$	Treatment Water Loss	%

# Section 1

## Background

---

### 1.1 Purpose of this Handbook

This Handbook is intended to serve as a resource for small municipal drinking water systems that may be affected by provisions of the Arsenic Rule. A “small” system is defined as a system serving 10,000 or fewer people. Average water demand for these size systems is normally less than 1.4 million gallons per day (MGD). Please note that the USEPA statutes and regulations described in this document contain legally binding requirements. The recommendations provided in this handbook do not substitute for those statutes or regulations, nor is this document a regulation itself. The approaches described in this handbook are strictly voluntary and do not impose legally-binding requirements on USEPA, states, local or tribal governments, or members of the public, and may not apply to a particular situation based upon the circumstances. Although the USEPA strongly recommends the approach outlined in this document, state and local decision makers are free to adopt approaches that differ from this handbook or to evaluate and choose technologies that are not discussed here. Interested parties are free to raise questions and objections about the appropriateness of the application of this handbook. Any USEPA decisions regarding a particular system will be made based on the applicable statutes and regulations. The USEPA may review and update this handbook as necessary and appropriate.

### 1.2 How to Use this Handbook

This Handbook includes general arsenic treatment information, cost evaluation tools, and design considerations for specific treatment technologies. The Handbook is organized to enable the utility to make educated decisions about the most appropriate treatment approach(es) to address arsenic concerns prior to getting involved in detailed design considerations. The utility should read Sections 1 through 3 in sequence, then use the treatment selection guidance provided in Section 3 to determine the most appropriate cost and design considerations sections (Sections 4 through 8).

Section 1 provides background information on the Arsenic Rule, waste disposal regulation, and arsenic chemistry that is useful in understanding the remainder of the Handbook.

Section 2 provides descriptions and background information for established arsenic mitigation strategies, with emphasis on those that are most technically and financially suitable for small systems. The utility should use this section to gather background information on the various arsenic mitigation strategies and determine the flowrate to be treated if treatment is selected as the mitigation strategy.

Section 3 describes the considerations required to make an informed treatment method selection. Decision trees are provided to guide the utility to the most applicable mitigation or treatment strat-

egy. The selected process is the one that has the highest chance of achieving the most cost effective solution for the particular water source, given the parameters used in the decision making process.

Section 4 enables the utility to quickly estimate the planning-level costs for the selected treatment process. This section is intended for those utilities that have identified the need to install new arsenic treatment. Based on the cost estimate, the utility can then decide if the selected treatment process is economically feasible. If it is not, the utility can repeat the decision trees and apply different preferences. It is important to recognize that the cost curves provided are for planning-level considerations only and should not be used as the primary decision-making tools.

Section 5 presents pre-oxidation alternatives and design calculations. This section is relevant to those utilities that have selected a treatment alternative and do not currently employ oxidation at the source(s) with arsenic concerns.

Sections 6-8 are intended for those utilities that have identified the need to install new arsenic treatment technologies. These sections provide design information on each of the primary arsenic treatment technologies.

After the selected mitigation strategy has been reviewed, the utility should evaluate the cost and constraints of the mitigation strategy. For strategies that involve modification of an existing process, a test should be run. For strategies that involve a new process, a pilot plant test should be run. After the tests have been performed and the results analyzed, the utility should re-evaluate whether the strategy will reduce the arsenic concentration below the Maximum Contaminant Level (MCL).

## **1.3 Regulatory Direction**

### **1.3.1 The Arsenic Rule**

The former arsenic MCL was 0.05 mg/L, as established under the 1975 National Interim Primary Drinking Water Regulations (NIPDWRs). As part of the 1996 Safe Drinking Water Act (SDWA) Amendments, the United States Environmental Protection Agency (USEPA) was directed to conduct health effects and cost/benefit research to finalize a new arsenic standard.

In June 2000, the USEPA proposed a revised arsenic MCL of 0.005 mg/L, and requested public comment on alternative MCLs of 0.003, 0.010, and 0.020 mg/L. The USEPA published a final rule in the Federal Register in January 2001 (USEPA, 2001). This rule established a revised arsenic MCL of 0.010 mg/L, and identified the following as Best Available Technologies (BATs) for achieving compliance with this regulatory level:

- Ion Exchange (IX)
- Activated Alumina (AA)
- Oxidation/Filtration
- Reverse Osmosis (RO)



- Electrodialysis Reversal
- Enhanced Coagulation/Filtration
- Enhanced Lime Softening

The following are listed in the final rule and the *Implementation Guidance for the Arsenic Rule* (USEPA, 2002a) as Small System Compliance Technologies (SSCT).

- IX
- AA, centralized and point-of-use (POU)
- RO, centralized and POU
- Electrodialysis Reversal
- Oxidation/Filtration
- Coagulation/Filtration, Enhanced Coagulation/Filtration, and Coagulation-Assisted Microfiltration (CMF)
- Lime Softening (LS) and Enhanced Lime Softening

This regulation applies to all community water systems and non-transient, non-community (NTNC) water systems, regardless of size. Please note that systems are not required to use these technologies.

Compliance with the Arsenic Rule will be required by January 2006. The running annual average arsenic level must be at or below 0.010 mg/L at each entry point to the distribution system. However, POU treatment can be instituted instead of centralized treatment. Analytical results for arsenic are rounded to the nearest 0.001 mg/L for reporting and compliance determination.

### **1.3.2 Health Effects**

Motivation to reduce the arsenic MCL is driven by the findings of health effects research. Over the past several years, numerous toxicological and epidemiological studies have been conducted to ascertain health risks associated with low-level exposure to As(V) ingestion.

Ingestion of inorganic arsenic can result in both cancer and non-cancer health effects (NRC, 1999). Arsenic interferes with a number of essential physiological activities, including the actions of enzymes, essential cations, and transcriptional events in cells (NRC, 1999). The USEPA has classified arsenic as a Class A human carcinogen. Chronic exposure to low arsenic levels (less than 0.05 mg/L) has been linked to health complications, including cancer of the skin, kidney, lung, and bladder, as well as other diseases of the skin, neurological, and cardiovascular system (USEPA, 2000).

The primary mode of exposure is ingestion of water containing arsenic. Dermal absorption of arsenic is minimal; therefore, hand washing and bathing do not pose a known risk to human health.

### 1.3.3 Other Drinking Water Regulations

In an attempt to comply with one drinking water regulation, it is possible to compromise treatment performance or compliance with other drinking water regulations. Therefore, in an effort to conform with the Arsenic Rule, community water systems should be cognizant of potential system-wide, regulatory, and operational impacts. In particular, compliance with the following regulations should be considered.

- Lead and Copper Rule (LCR)
- Surface Water Rules (SWTR, IESWTR, LT1ESWTR)
- Disinfectants/Disinfection By-Products Rule (DBPR)

Many of the arsenic treatment technologies require pH adjustment for optimization of performance. Figure 11 provides a summary of the optimal pH ranges for several arsenic treatment technologies. Sorption and coagulation processes are particularly sensitive to pH, and function most effectively at the lower end of the natural pH range. However, use of AA at a natural pH may be a cost effective option for many small water systems.

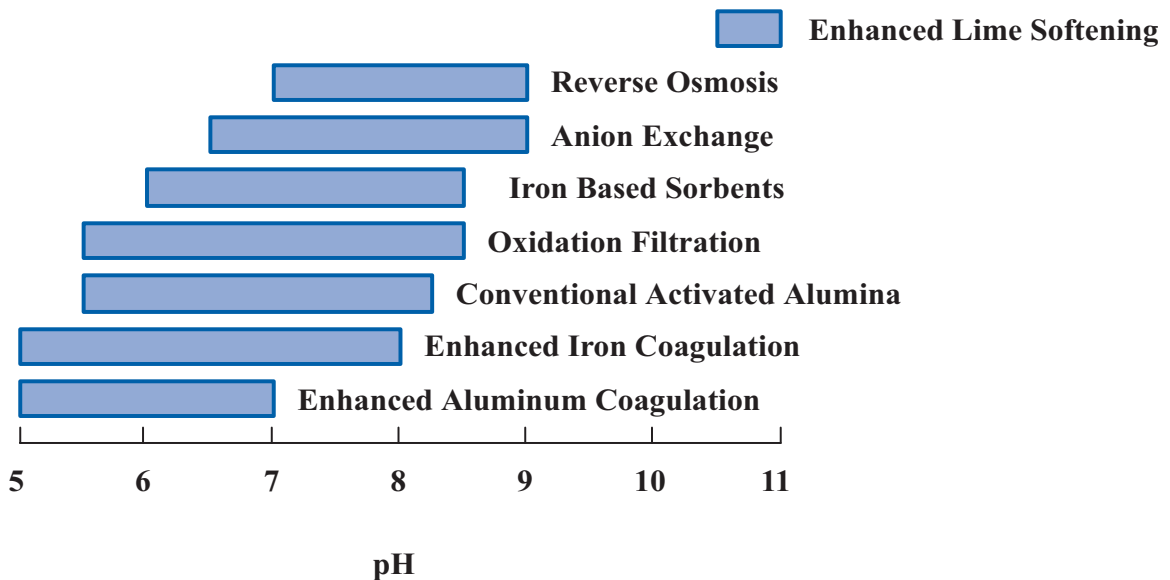

Figure 1-1. Optimal pH Ranges for Arsenic Treatment Technologies.

In addition to affecting arsenic treatability, pH also can have a significant effect on disinfection, coagulation, and chemical solubility/precipitation within the distribution system and in plumbing systems (LCR).

### *Lead and Copper Rule*

Lead and copper in tap water is primarily due to corrosion of plumbing system components within buildings, including copper pipes, lead-based solder used to join segments of copper pipe, and faucets made from brass. Alkalinity and pH play a critical role in providing passivation protection from corrosion. In general, the optimum pH range for minimizing corrosion of lead and copper is 7.5-9.0. Therefore, post-treatment pH adjustment is recommended for many of the treatment techniques provided in Figure 11.

### *Surface Water Rules (SWTR, IESTWR, LT1ESWTR)*

Disinfection efficacy is also related to pH if chlorine is used. When pre-chlorinating, the biocidal potential of chlorine is enhanced as the pH is reduced. Therefore, utilities that are currently required to meet a CT (disinfectant concentration times contact time) standard should receive disinfection benefit from pH reduction at the head of the treatment process. Post-treatment pH adjustment for corrosion control should be conducted after CT requirements are met.

Coagulation and flocculation processes are also related to pH. The formation of floc is improved as the pH is reduced, and optimized within the range of 5-8. However, iron and aluminum-based coagulants also consume alkalinity, thereby decreasing the buffering capacity of the water.

### *Disinfectants/Disinfection By-Products Rule (DBPR)*

Chlorine reacts with natural organic matter (NOM) to form halogenated disinfection by-products, such as total trihalomethanes (TTHM) and haloacetic acids (HAA5). Therefore, incorporating pre-chlorination to convert As(III) to As(V) could increase the occurrence of these regulated chemicals. However, as most arsenic in surface water is already oxidized to As(V), chlorination may not be necessary in surface water, where disinfection byproducts are of the most concern. The Stage 1 DBPR<sup>1</sup> establishes running annual average MCLs of 0.080 mg/L and 0.060 mg/L for TTHM and HAA5, respectively.

The Stage 2 DBPR, scheduled for proposal in early 2003, augments the Stage 1 DBPR to reduce health risks from DBP exposure.

## **1.3.4 Waste Disposal Regulations**

Waste disposal is an important consideration in the treatment selection process. Arsenic removal technologies produce several different types of waste, including sludges, brine streams, backwash slurries, and spent media. These wastes have the potential for being classified as hazardous and can pose disposal problems. Table 1-1 provides a summary of the available waste disposal options and associated criteria. These are further discussed in the following paragraphs. In addition, specific waste disposal considerations for each technology are discussed in Section 2.

---

<sup>1</sup>The Stage 1 DBPR became effective for surface water systems and groundwater systems under the direct influence of surface water serving at least 10,000 people in January 2002. The rule will take effect for all groundwater systems, and surface water systems and groundwater systems under the direct influence of surface water systems serving less than 10,000 people in January 2004.

**Table 1-1. Waste Disposal Options.**

Waste Type	Disposal Method (Criteria)
Liquid	● Direct Discharge to Surface Water (CWA, NPDES)
	● Indirect Discharge to POTW (TBLLs)
	● On-Site Sewerage (POU systems)
	● Infiltration to Ground Water
	● Evaporation Ponds
	● Recycle/Reuse
	● Ocean Discharge
Solid (sludge, media)	● Land Application
	● Municipal Solid Waste Landfill (PFLT, TCLP, WET in California)
	● Hazardous Waste Landfill (PFLT)

Liquid waste streams must have lower concentrations than the Toxicity Characteristic (TC) in order for the waste to be classified as non-hazardous. The arsenic TC is 5.0 mg/L. Those liquid waste streams that contain more than 5.0 mg/L of arsenic would therefore be classified as a hazardous waste. Many of the arsenic removal technologies also remove other constituents (e.g., chromium). The waste stream must be analyzed for these other substances that may be in concentrations above their respective TCs. Because of Resource Conservation and Recovery Act (RCRA) requirements and cost implications, on-site treatment or off-site disposal of hazardous waste is likely to be infeasible for small water systems. Indirect discharge may be an option since wastes that pass through a sewer system to a Publicly Owned Treatment Works (POTW) are exempt from RCRA regulation once the waste mixes with wastewater from the sewer. Utilities considering indirect discharge should work with the POTW to determine if the arsenic waste levels would be acceptable to a revised Technically Based Local Limit (TBLL). (The TBLL would be revised because the arsenic treatment will change the arsenic background at the POTW).

Solids waste streams are subject to the Toxicity Characteristic Leaching Procedure (TCLP). This test is used to simulate the potential for leaching in a landfill setting. The TCLP leachate must be lower than any of the TC values in order for the waste to be classified as non-hazardous.

There are five realistic methods for the disposal of arsenic waste streams.

#### *Landfill Disposal*

Historically, municipal solid waste landfills have been commonly used for the disposal of non-hazardous solid wastes emanating from treatment processes. However, the hazard potential of arsenic may limit the feasibility of this alternative.

Dewatered sludge and spent media can be disposed in a municipal solid waste landfill if the waste passes both the Paint Filter Liquids Test (PFLT) and the TCLP. The PFLT is used to verify there is no free liquid residual associated with the waste. However, if the TCLP extract contains arsenic or any other contaminant (e.g., chromium) above the TC, the waste

residuals must be disposed in a designated and licensed hazardous waste landfill. These landfills are strictly regulated under RCRA and have extensive monitoring and operational guidelines. As such, the costs of disposal are relatively high. As with municipal solid waste landfill disposal, waste sludges must not contain free liquid residuals.

A critical element of hazardous waste disposal is the cradle-to-grave concept. The party responsible for generating the hazardous waste retains liability and responsibility for the fate and transport of the waste.

#### *Direct Discharge to Surface Waters*

Direct discharge refers to the disposal of liquid waste streams to nearby surface waters, which act to dilute and disperse the waste by-products. The primary advantage of direct discharge is reduced capital and operations and maintenance (O&M) costs due to the elimination of residuals treatment. The feasibility of this disposal method is subject to provisions of the National Pollution Discharge Elimination System (NPDES) and state anti-degradation regulation. The allowable discharge is a function of the ability of the receiving water to assimilate the arsenic without exceeding water quality criteria established under the Clean Water Act (CWA) or state regulation. Different water quality criteria exist depending on the classification of the receiving water. For specific NPDES conditions and limits, the appropriate NPDES permitting agency should be contacted, because the conditions and limits can vary according to the receiving stream's particular characteristics.

#### *Indirect Discharge*

The discharge of liquid waste streams to a POTW is a potential disposal alternative. In this case, the waste stream will be subject to TBLLs established regionally by sewer authorities as part of the POTW's Industrial Pretreatment Program. TBLLs are established in order to protect POTW operation, assure compliance with NPDES permits, and prevent an unacceptable level of accumulation of contaminants in the process sludge and biosolids. The arsenic limit is usually on the order of 0.05 to 0.1 mg/L. The TBLLs are computed for each POTW to take into account the background levels of contaminants in the municipal wastewater. The background level will change because of the drinking water treatment process, which may lead to revised TBLLs. The revised TBLL would be used to determine if the liquid waste stream could be discharged to the POTW.

#### *Land Application*

Land application of concentrated sludge may be allowed under certain conditions depending on the state law and regulations. Some states do not allow land application of solid residuals. Sewage sludge (also called "biosolids") containing <41 mg As/kg biosolids can be land-applied with no restrictions. Biosolids with arsenic concentrations between 41 and 75 mg/kg can be land-applied, but must track arsenic accumulation. The lifetime arsenic accumulation limit is 41 kg As per hectare of land. Federal part 503 land application limits are only applicable in states that have adopted these limits for water plant residuals or in cases where these residuals are mixed with sewage sludge.

### *On-Site Sewerage*

Liquid waste streams from RO POU devices should be suitable for disposal in an on-site sewerage or septic system. Figure 1-2 illustrates a typical flow diagram for RO POU water treatment and on-site waste disposal.

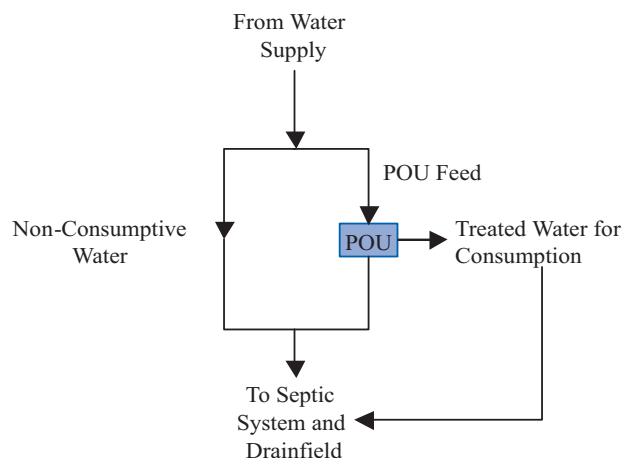

Figure 1-2. Flow Diagram for RO POU.

Arsenic is concentrated in the RO retentate during normal process operation. However, eventually this retentate is combined with other domestic wastewater in the septic tank. Because the amount of water consumed is small relative to the total flow entering the dwelling, the concentration of arsenic in the *blended* wastewater is nearly identical to that in the influent stream.

## 1.4 Arsenic Chemistry

Arsenic is introduced into the aquatic environment from both natural and manmade sources. Typically, however, arsenic occurrence in water is caused by the weathering and dissolution of arsenic-bearing rocks, minerals, and ores. Although arsenic exists in both organic and inorganic forms, the inorganic forms are more prevalent in water and are considered more toxic. Therefore, the focus of this Handbook is on inorganic arsenic.

Total inorganic arsenic is the sum of particulate and soluble arsenic. A 0.45-micron filter can generally remove particulate arsenic.

Soluble, inorganic arsenic exists in either one of two valence states depending on local oxidation-reduction conditions. Typically groundwater has anoxic conditions and arsenic is found in its arsenite or reduced trivalent form [As(III)]. Surface water generally has aerobic conditions and arsenic is found in its arsenate or oxidized pentavalent form [As(V)].

Both arsenite and arsenate exist in four different species. The speciation of these molecules changes by dissociation and is pH dependent. The kinetics of dissociation for each are nearly instantaneous. The pH dependencies of arsenite and arsenate are depicted in Figure 1-3 and Figure 1-4, respec-

tively. The species shown in bold are those that are most likely to be removed by the techniques discussed in this handbook.

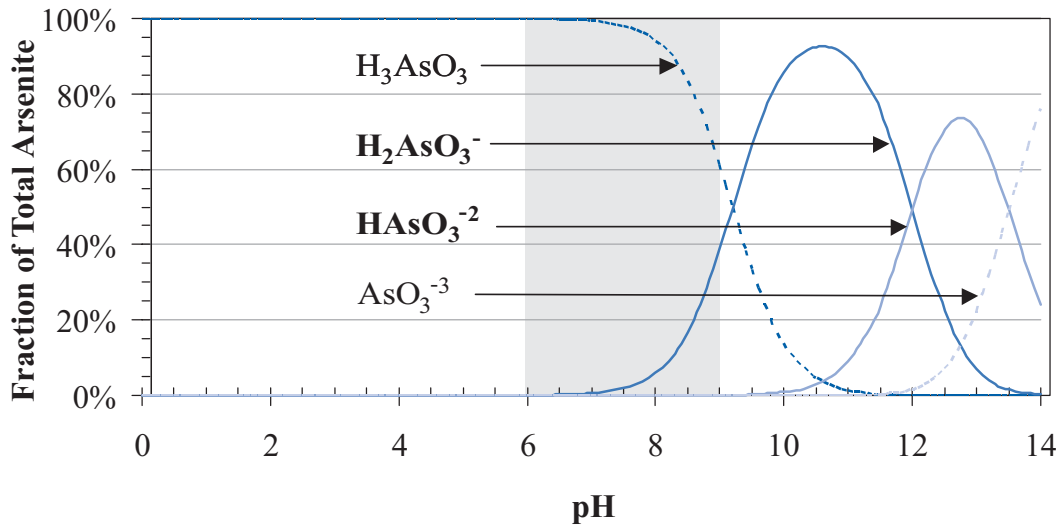

Figure 1-3. Dissociation of Arsenite [As(III)].

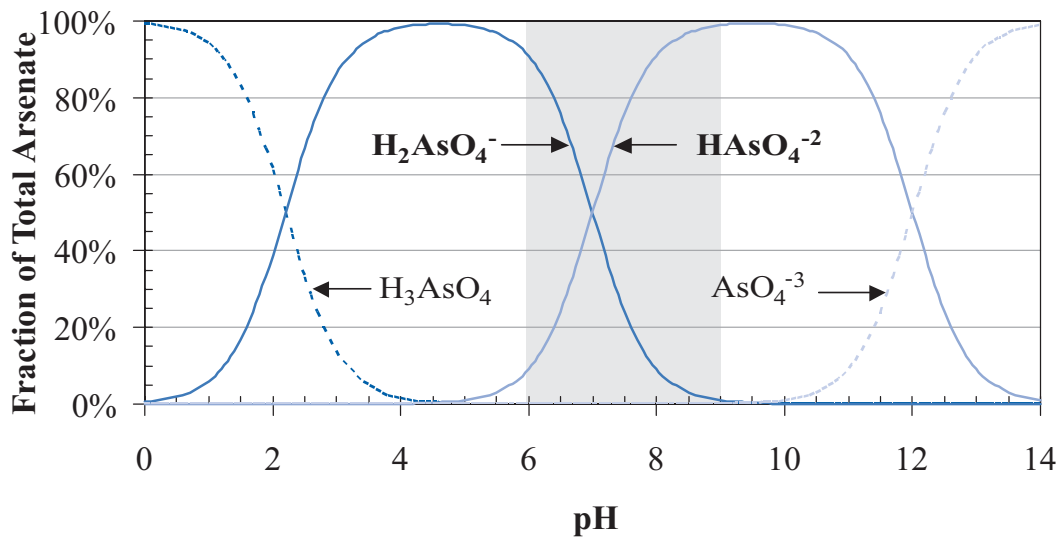

Figure 1-4. Dissociation of Arsenate [As(V)].

Chemical speciation is a critical element of arsenic treatability. Negative surface charges facilitate removal by adsorption, anion exchange, and co-precipitative processes. Since the net charge of arsenite [As(III)] is neutral at natural pH levels (6-9), this form is not easily removed. However, the net molecular charge of arsenate [As(V)] is negative (-1 or -2) at natural pH levels, enabling it to be removed with greater efficiency. Conversion to As(V) is a critical element of most arsenic treatment processes. This conversion can be accomplished by adding an oxidizing agent such as chlorine or permanganate. Selection of the most appropriate oxidation technology should be based on several considerations, including cost, integration with existing treatment, disinfection requirements, and secondary effects. This is discussed further in Section 2.2.

This page intentionally left blank.



# Section 2

## Arsenic Mitigation Strategies

---

### 2.1 Description of Arsenic Mitigation Strategies

Problematic arsenic levels in drinking water can be mitigated in several different ways. This Handbook will address the following mitigation strategies:

- Abandonment - The total abandonment of the problematic source(s) and subsequent switch to other source(s) within the system or purchase from a neighboring system.
- Seasonal Use - Switching the problematic source(s) from full-time used to seasonal or peaking use only with subsequent blending with other full-time source(s).
- Blending - The combination of multiple water sources to produce a stream with an arsenic concentration below the MCL.
- Sidestream Treatment - The treatment of a portion of the high arsenic water stream and subsequent blending back with the untreated portion of the stream to produce water that meets the MCL.
- Treatment – The processing of all or part of a water stream to reduce the arsenic concentration to below the MCL.
  - Wellhead Treatment – Treatment is located at the wellhead location before the water is mixed with water from other sources.
  - Centralized Treatment – Water from several sources is piped to a centralized location for treatment before the water enters the distribution system.
  - POU Treatment – Treatment devices are located at the Point-Of-Use within the building or home and treat only the water intended for direct consumption, typically at a single tap.

There are three primary categories of available treatment processes.

- Sorption Treatment Processes
  - IX<sup>2</sup>
  - AA<sup>2,3</sup>
  - Iron Based Sorbents (IBS)<sup>4</sup>
- Membrane Treatment Processes
  - RO<sup>2,3</sup>
- Precipitation/Filtration Processes

---

<sup>2</sup> Technologies that have been designated as small system compliance technologies (SSCT) for centralized or wellhead treatment.

<sup>3</sup> Technologies that have been designated as SSCT for POU treatment.

<sup>4</sup> Due to limited performance research at the time the rule was promulgated, IBS was not designated as a BAT or a SSCT by the USEPA.

- Enhanced Conventional Gravity Coagulation/Filtration <sup>2 above</sup>
- CMF <sup>2 above</sup>
- Coagulation-Assisted Direct Filtration (CADF) <sup>2 above</sup>
- Oxidation/Filtration <sup>2 above</sup>
- Enhanced Lime Softening <sup>2 above</sup>

The selection of the most appropriate mitigation strategy should be based on feasibility issues, system constraints, and costs.

### 2.1.1 Abandonment

Perhaps the simplest approach for remedying a high arsenic source is abandonment of the high arsenic water source and procurement of a new source that meets the arsenic MCL. This option is most realistic for utilities with multiple water sources where at least one source can be relied upon for producing water with arsenic below the MCL. There may, however, be other constraints to switching primary sources, such as inadequate treatment capacity or water rights. Many small systems do not have the flexibility to switch to a source with a lower arsenic concentration. In this particular case, the utility has two options: (1) locate or install a new source, or (2) purchase water from a nearby system if an interconnection exists. New source installations may or may not be more costly than treatment. It should also be noted that drilling a new source may not be the best option if the aquifer has consistently high levels of arsenic. The utility should check with other systems in the area before drilling.

### 2.1.2 Seasonal Use

Another option is to switch a high arsenic water source from full-time production to seasonal or peaking use only. When used, it would be blended with low arsenic water sources before entry to the distribution system. This is allowed at the federal level, as long as the running annual average at the entry point to the distribution system does not exceed the MCL. Individual state requirements may preclude this option.

The running annual average can be calculated by adding the four most recent quarterly arsenic concentrations together and dividing by 4 as seen in the following equation.

$$C_{RAA} = \frac{C_1 + C_2 + C_3 + C_4}{4} \quad \text{Eqn. 2-1}$$

Where:

- $C_{RAA}$  = Running Annual Average Arsenic Concentration Entering System,
- $C_1$  = Arsenic Concentration Entering System During the Quarter 1,
- $C_2$  = Arsenic Concentration Entering System During the Quarter 2,
- $C_3$  = Arsenic Concentration Entering System During the Quarter 3, and
- $C_4$  = Arsenic Concentration Entering System During the Quarter 4.

An example of this is shown in Figure 2-1. Well 1 is the only source for the first and second quarters of year and has an arsenic concentration of 0.003 mg/L. Well 2 is used in conjunction with Well 1 for the third and fourth quarters of the year and the combined output from Wells 1 and 2 has an arsenic concentration of 0.014 mg/L. The running annual average is calculated below as 0.009 mg/L and complies with the federal Arsenic Rule.

$$C_{\text{RAA}} = \frac{0.003 + 0.003 + 0.014 + 0.014}{4} = 0.0085 \text{ mg/L} \Rightarrow 0.009 \text{ mg/L}$$

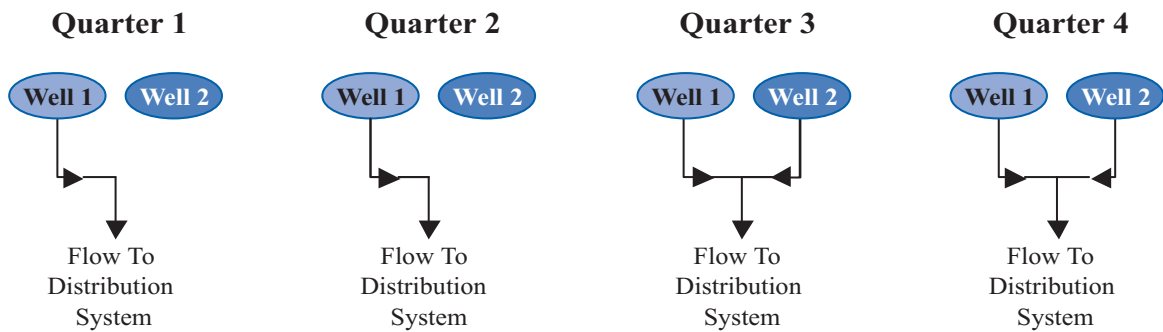

Figure 2-1. Example of Seasonal High Arsenic Source Use.

### 2.1.3 Blending

The revised arsenic MCL must be met at all entry points to the distribution system. Therefore, blending is a viable mitigation strategy for conservative inorganic substances and should be considered by systems that utilize multiple sources. Blending involves mixing waters from two or more different sources prior to entering the distribution system. The purpose of blending is to eliminate the need for treatment.

Stand-alone blending shown in Figure 2-2 is only a consideration when a water system has multiple sources, one (or more) with arsenic levels above the MCL, and one (or more) with arsenic levels below the MCL. Also, the wells with low arsenic levels must be reliable on a continuous basis.

Each stream in the blending process should have a flow measurement to insure that the streams are blended in a ratio that produces an arsenic concentration that meets the MCL requirement. Flow measurement is shown in the following figure and an “F” inscribed in a circle.

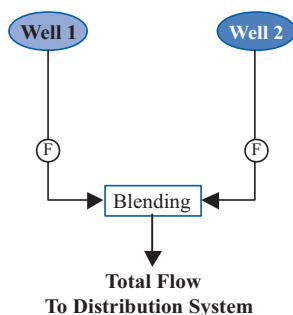

Figure 2-2. Blending.

The concentration of the blended stream ( $C_{As,B}$ ) can be calculated using the following formula.

$$C_{As,B} = \frac{Q_1 \cdot C_{As,1} + Q_2 \cdot C_{As,2}}{Q_1 + Q_2} \quad \text{Eqn. 2-2}$$

Where:

- $C_{As,B}$  = Arsenic Concentration of Blended Stream (mg/L),
- $C_{As,1}$  = Arsenic Concentration of Well 1 (mg/L),
- $C_{As,2}$  = Arsenic Concentration of Well 2 (mg/L),
- $Q_1$  = Flowrate of Well 1 (gpm), and
- $Q_2$  = Flowrate of Well 2 (gpm).

For example, suppose that water from Wells 1 and 2 in Figure 2-2 contain arsenic concentrations of 0.015 mg/L and 0.006 mg/L, respectively, with flowrates of 700 gpm and 2,450 gpm, respectively. The blended stream's arsenic concentration will then be 0.008 mg/L, which meets the MCL, and is calculated as follows:

$$C_{As,B} = \frac{700 \text{ gpm} \cdot 0.015 \text{ mg/L} + 2,450 \text{ gpm} \cdot 0.006 \text{ mg/L}}{700 \text{ gpm} + 2,450 \text{ gpm}} = 0.008 \text{ mg/L}$$

The following equation can be used to determine the required flowrate from the low arsenic source ( $Q_2$ ) that, when blended with flow from the high arsenic source ( $Q_1$ ), will produce water with an arsenic concentration a safe margin below the MCL.

$$Q_2 = Q_1 \cdot \left( \frac{[1 - \sigma] \cdot C_{MCL} - C_{As,1}}{C_{As,2} - [1 - \sigma] \cdot C_{MCL}} \right) \quad \text{Eqn. 2-3}$$

Where:

- $Q_1$  = Flowrate of Well 1 (gpm) {high arsenic source},
- $Q_2$  = Flowrate of Well 2 (gpm) {low arsenic source},
- $C_{As,1}$  = Arsenic Concentration of Well 1 (mg/L) {high arsenic source},
- $C_{As,2}$  = Arsenic Concentration of Well 2 (mg/L) {low arsenic source},
- $C_{MCL}$  = Arsenic MCL (mg/L), and
- $s$  = Safety Margin (% expressed as a decimal).

For example, suppose that water from Wells 1 and 2 in Figure 2-2 contain arsenic concentrations of 0.015 mg/L and 0.006 mg/L, respectively. Assuming that the utility wants to provide a 20% safety margin (i.e., produce water with 0.008 mg/L of arsenic) and the maximum flowrate from Well 1 is 700 gpm, the minimum required flowrate from Well 2 is 2,450 gpm and is calculated as follows:

$$Q_2 = 700 \text{ gpm} \cdot \left( \frac{[1 - 0.2] \cdot 0.010 \text{ mg/L} - 0.015 \text{ mg/L}}{0.006 \text{ mg/L} - [1 - 0.2] \cdot 0.010 \text{ mg/L}} \right) = 2,450 \text{ gpm}$$

#### 2.1.4 Treatment

If a treatment method is used to mitigate the arsenic problem from multiple sources, the utility will need to decide between wellhead treatment and centralized treatment. Wellhead treatment treats the water from each well at or near the wellhead. For systems with multiple wells, this could result in multiple treatment facilities. If possible, piping high arsenic water from multiple sources to a single, centralized treatment facility may be more economical. Some factors to take into account would be:

- the proximity of wells to be treated to each other,
- feasibility of piping the sources to a central location,
- availability of land and power at the treatment site(s), and
- labor requirements for multiple sites rather than a single site.

Some treatment processes (e.g., RO) may have significant water losses associated with them. Water loss is incoming water that does not exit the system as treated water. Water losses frequently occur as a stream used to dispose of waste. Typical treatment efficiencies and water losses for processes operated under normal conditions are provided in Table 2-1.

**Table 2-1. Typical Treatment Efficiencies and Water Losses.**

Treatment	As(V) Removal Efficiency	Water Loss
<b>Sorption Processes</b>		
Ion Exchange	95% <sup>1</sup>	1-2%
Activated Alumina (Throw-Away Media)	95% <sup>1</sup>	1-2%
Iron Based Sorbents	Up to 98% <sup>1</sup>	1-2%
<b>Iron and Manganese Removal Processes</b>		
Oxidation/Filtration (Greensand)	50-90% <sup>2</sup>	≤2%
<b>Membrane Processes</b>		
Reverse Osmosis	>95% <sup>1</sup>	15-50% <sup>1</sup>
<b>Precipitative Processes</b>		
Coagulation Assisted Microfiltration	90% <sup>1</sup>	5%
Enhanced Coagulation/Filtration		
With Alum	<90% <sup>1</sup>	
With Ferric Chloride	95% <sup>1</sup>	1-2%
Enhanced Lime Softening	90% <sup>1</sup>	1-2%

<sup>1</sup> USEPA, 2000.

<sup>2</sup> Depends on arsenic and iron concentrations

### 2.1.5 Sidestream Treatment

The treatment and blending strategies can be combined in a variety of ways as illustrated in Figure 2-3 through Figure 2-5.

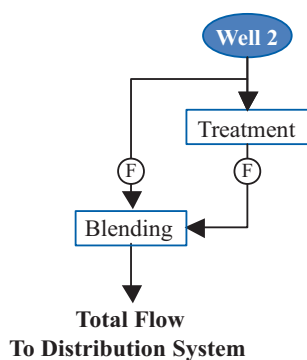

Figure 2-3. Sidestream Treatment.

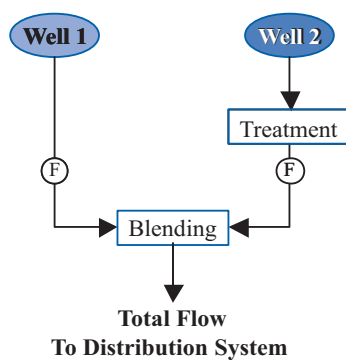

Figure 2-4. Treatment and Blending.

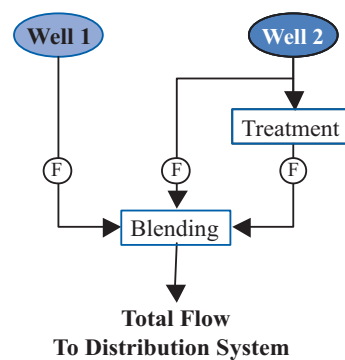

Figure 2-5. Sidestream Treatment and Blending.

Sidestream treatment, Figure 2-3, involves splitting the source flow, treating one stream, and then blending it with the untreated stream prior to distribution. Sidestream treatment is feasible when a water source exceeds the revised MCL by a relatively small margin. This approach is viable because most arsenic treatment processes (operated under optimal conditions) can achieve at least 80% arsenic removal and, in many cases, this high level of

performance is not needed to meet the MCL. Any utility considering treatment should consider sidestream treatment as a method to reduce the overall level and cost of the treatment required.

In the simple case of sidestream treatment from a single source, as in Figure 2-6, the flowrate of the split stream requiring treatment can be calculated using Equation 2-4. If the treatment process is RO, as in Figure 2-7, the flowrate of the split stream requiring treatment can be calculated using Equation 2-5. RO requires a more complex equation because RO has a continuous stream of water lost during operation and this water is not available for blending. In all the other treatments, when the water loss occurs (e.g., the backwash of a column or filter) no treated water is available for blending so no blending occurs. (Under these circumstances, the untreated water flow to the distribution is also halted.) For all the treatment methods, the resulting blended treated flowrate can be calculated using Equation 2-6.

$$Q_S = Q_1 \left( \frac{C_1 - (1 - \sigma) \cdot C_{MCL}}{\varepsilon C_1} \right) \quad \text{Eqn. 2-4}$$

$$Q_S = Q_1 \left( \frac{C_1 - (1 - \sigma) \cdot C_{MCL}}{C_1 [1 - (1 - \omega)(1 - \varepsilon)] - \omega \cdot (1 - \sigma) \cdot C_{MCL}} \right) \quad \text{Eqn. 2-5}$$

$$Q_B = Q_1 - \omega Q_S \quad \text{Eqn. 2-6}$$

The variable for the equations are:

- $Q_S$  = Flowrate to Split Off for Treatment (gpm),
- $Q_B$  = Flowrate of the Final Blended Stream (gpm),
- $Q_1$  = Source 1 Flowrate (gpm),
- $C_1$  = Arsenic Concentration of the Source (mg/L),
- $C_{MCL}$  = Arsenic MCL (mg/L),
- $\sigma$  = Safety Margin (% expressed as a decimal),
- $\omega$  = Treatment Water Loss (% expressed as a decimal), and
- $\varepsilon$  = Arsenic Rejection Rate (% expressed as a decimal).

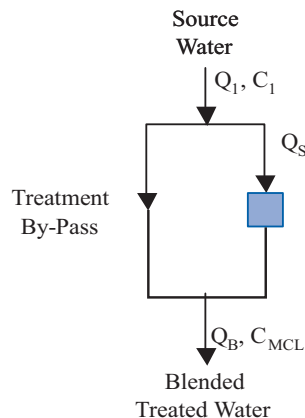

Figure 2-6. Sidestream Treatment.

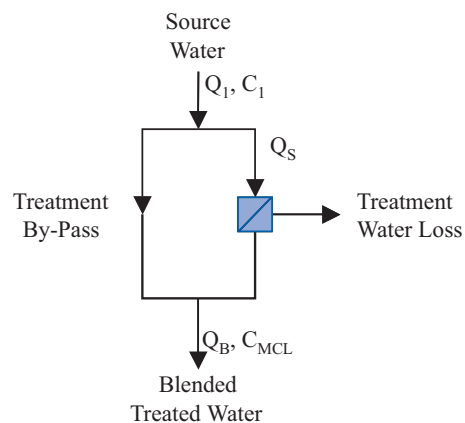

Figure 2-7. Sidestream Treatment for RO.

For example, suppose a water utility operates a single well at a maximum flowrate ( $Q_1$ ) of 500 gpm. The well water contains ( $C_1$ ) 0.012 mg/L of arsenic. Further, assume that utility wants to provide a 20% safety margin ( $\sigma$ ) on the arsenic MCL ( $C_{MCL}$ ) of 0.010 mg/L (i.e., produce water with 0.008 mg/L of arsenic). The utility has selected a RO process that has demonstrated an arsenic removal efficiency ( $\epsilon$ ) of 95% at a water loss ( $\omega$ ) of 40%. Using Equation 2-5, 237 gpm of the well's flow (or approximately 47%) should be split and sent to the RO treatment unit. The final (blended) flowrate is 405 gpm, as determined using Equation 26.

$$Q_S = (500 \text{ gpm}) \cdot \left( \frac{0.012 \text{ mg/L} - [1 - 0.2] \cdot 0.010 \text{ mg/L}}{0.012 \text{ mg/L} [1 - (1 - 0.4)(1 - 0.95)] - 0.4 \cdot [1 - 0.2] \cdot 0.010 \text{ mg/L}} \right) = 237 \text{ gpm}$$

$$Q_B = (500 \text{ gpm}) - 0.4 \cdot (237 \text{ gpm}) = 405 \text{ gpm}$$

## 2.2 Pre-Oxidation Processes

Reduced inorganic As(III) (arsenite) should be converted to As(V) (arsenate) to facilitate removal. **This step is critical for achieving optimal performance of all unit processes described in this Handbook.** Conversion to As(V) can be accomplished by providing an oxidizing agent at the head of any proposed arsenic removal process. Chlorine, permanganate, ozone, and Filox-R™<sup>5</sup> are highly effective for this purpose. Chlorine dioxide and monochloramine are ineffective in oxidizing As(III). Ultraviolet (UV) light, by itself, is also ineffective. However, if the water is spiked with sulfite, UV photo-oxidation shows promise for As(III) conversion (Ghurye and Clifford, 2001). Based on these considerations, only chlorine, permanganate, ozone, and Filox-R™ are discussed further in this Handbook.

Table 2-2 provides a summary of the benefits and drawbacks associated with the use of several oxidation technologies. The choice of oxidation method should be based primarily on the arsenic treatment technology to be employed (as described in Section 3), and secondarily on factors provided in Table 2-2. Many small water systems employ chlorine disinfection, either alone or as part of a larger treatment process. In most of these instances, the existing chlorination process can be optimized to provide concurrent As(III) oxidation.

---

<sup>5</sup> Filox is a registered trademark of Matt-Son, Inc., Barrington, IL. Filox-R is a trademark of Matt-Son, Inc., Barrington, IL.



**Table 2-2. Comparison of Oxidizing Agents.**

Oxidant	Benefits	Drawbacks
Chlorine	<ul style="list-style-type: none"> <li>● Low relative cost (\$0.50/lb.)</li> <li>● Primary disinfection capability</li> <li>● Secondary disinfectant residual</li> <li>● MnO<sub>2</sub> media regenerant</li> <li>● Oxidizes arsenic in less than 1 minute</li> </ul>	<ul style="list-style-type: none"> <li>● Formation of disinfection by-products</li> <li>● Membrane fouling</li> <li>● Special handling and storage requirements</li> </ul>
Permanganate	<ul style="list-style-type: none"> <li>● Unreactive with membranes</li> <li>● No formation of disinfection by-products</li> <li>● MnO<sub>2</sub> media regenerant?</li> <li>● Oxidizes arsenic in less than 1 minute</li> </ul>	<ul style="list-style-type: none"> <li>● High relative cost (\$1.35/lb.)</li> <li>● No primary disinfection capability</li> <li>● Formation of MnO<sub>2</sub> particulates</li> <li>● Pink Water</li> <li>● Difficult to handle</li> <li>● An additional oxidant may be required for secondary disinfection</li> </ul>
Ozone	<ul style="list-style-type: none"> <li>● No chemical storage or handling required</li> <li>● Primary disinfection capability</li> <li>● No chemical by-products left in water</li> <li>● Oxidizes arsenic in less than 1 minute in the absence of interfering reductants</li> </ul>	<ul style="list-style-type: none"> <li>● Sulfide and TOC interfere with conversion and increase the required contact time and ozone dose for oxidation</li> <li>● An additional oxidant may be required for secondary disinfection</li> </ul>
Solid Phase Oxidants (Filox R™)	<ul style="list-style-type: none"> <li>● No chemical storage or handling required</li> <li>● No chemical by-products left in water</li> <li>● Oxidizes arsenic with an EBCT of 1.5 minutes in the absence of interfering reductants</li> </ul>	<ul style="list-style-type: none"> <li>● Backwashing required</li> <li>● Backwash waste is generated</li> <li>● Requires dissolved oxygen to work</li> <li>● No primary disinfection capability</li> <li>● An additional oxidant may be required for secondary disinfection</li> <li>● Iron, manganese, sulfide, and TOC increase the contact time and dissolved oxygen concentration required for oxidation</li> </ul>

### 2.2.1 Chlorine

Issues associated with pre-chlorination are: (1) sensitivity of the treatment process to chlorine; (2) disinfection by-product (DBP) formation potential; (3) code requirements associated with chemical storage and handling; and (4) operator safety. Chlorine can be added either as a gas or as liquid hypochlorite, although chlorine gas may not be appropriate for small systems. For new chlorine feed installations, these alternatives should be evaluated with respect to capital and operating costs, O&M requirements, code restrictions, containment requirements, footprint, and safety concerns, among other issues. Gas feed is typically conducted with either 150-pound cylinders or 2,000-pound (1-ton) containers, depending on the rate of chlorine consumption. Small systems normally use the 150-pound cylinders. Liquid hypochlorite can either be generated on-site (0.8% strength), or purchased as commercial strength (5¼ or 12½%) liquid hypochlorite.

The stoichiometric oxidant demand is 0.95 mg of chlorine (as Cl<sub>2</sub>) per mg of As(III). The oxidation-reduction reaction for chlorine (as hypochlorite) is provided in the following equation.

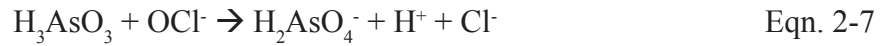

The ability of chlorine to convert As(III) to As(V) was found to be relatively independent of pH in the range 6.3 – 8.3. Based on laboratory oxidation studies (Ghurye and Clifford, 2001), chlorine applied in a stoichiometric excess of 3 times was capable of converting over 95% of As(III) to As(V) within 42 seconds. Dissolved iron, manganese, and total organic carbon (TOC) had no significant effects on the conversion time. However, sulfide in 1 and 2 mg/L concentrations increased the conversion time to 60 seconds.

The stoichiometric oxidant demands and the oxidation-reduction reactions for chlorine (as hypochlorite) to oxidize iron, manganese, and sulfide are provided below.

Stoichiometric ratio for oxidation of Fe(II) is 0.64 mg Cl<sub>2</sub> per mg Fe<sup>2+</sup>.

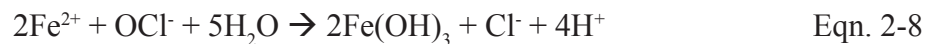

Stoichiometric ratio for oxidation of Mn(II) is 1.29 mg Cl<sub>2</sub> per mg Mn<sup>2+</sup>.

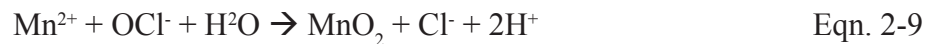

Stoichiometric ratio for oxidation of sulfide is 2.21 mg Cl<sub>2</sub> per mg HS<sup>-</sup>.



Information on the design of a chlorination system can be found in Section 5.1, *Chlorine Pre-Oxidation Design Considerations*.

### 2.2.2 Permanganate

Permanganate is a powerful oxidizing agent that is commonly used in iron and manganese removal processes. Potassium permanganate exists in solid, granular form and is readily soluble in water (60 g/L at room temperature). Most applications involve metering of a permanganate solution.

The stoichiometric oxidant demand is 1.06 mg of permanganate per mg of As(III). The oxidation-reduction reaction for permanganate is provided in the following equation.

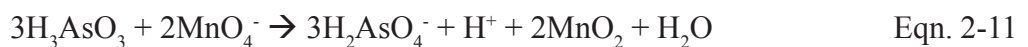

The ability of permanganate to convert As(III) to As(V) was found to be relatively independent of pH in the range 6.3 – 8.3. Based on laboratory oxidation studies (Ghurye and

Clifford, 2001), permanganate applied in a stoichiometric excess of 3 times was capable of converting over 95% of As(III) to As(V) within 36 seconds. Dissolved iron, manganese, and TOC had no significant effects on the conversion time. However, sulfide in 1 and 2 mg/L concentrations increased the conversion time to 54 seconds.

The stoichiometric oxidant demands and the oxidation-reduction reactions for permanganate to oxidize iron, manganese, and sulfide are provided below.

Stoichiometric ratio for the oxidation of Fe(II) is 0.71 mg  $\text{MnO}_4^-$  per mg  $\text{Fe}^{2+}$ .



Stoichiometric ratio for oxidation of Mn(II) is 1.44 mg  $\text{MnO}_4^-$  per mg  $\text{Mn}^{2+}$ .

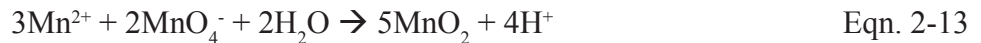

Stoichiometric ratio for oxidation of sulfide is 2.48 mg  $\text{MnO}_4^-$  per mg  $\text{HS}^-$ .

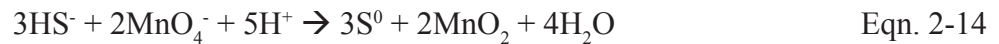

The use of permanganate has several disadvantages.

Firstly, it is difficult to handle. It comes as a powder, is very corrosive, and stains nearly everything purple. The second drawback is the formation of manganese particulates ( $\text{MnO}_2$ ). To prevent the accumulation of these deposits in the distribution system, they must be removed via filtration. A third drawback is that, because permanganate is not used as a secondary disinfectant, another oxidant may be required for secondary disinfection. Additionally, if a secondary disinfectant is not used in the distribution system when a POU treatment strategy is implemented, anoxic conditions could develop in the distribution system causing the As(V) to reduce back to As(III). This would decrease the effectiveness of the POU devices and increase the cost of the treatment.

Information on the design of a permanganate system can be found in Section 5.2, *Permanganate Pre-Oxidation Design Considerations*.

### 2.2.3 Ozone

Ozone is the most powerful and rapid-acting oxidizer produced. It is created by exposing oxygen, either in air or pure oxygen, to high energy such as an electric discharge field (i.e., corona discharge) or to UV radiation. This causes the oxygen molecules to react to form an unstable configuration of three oxygen atoms – the oxygen molecule contains only two. Because of its instability, ozone is very reactive and is a very efficient oxidant. The only by-product from oxidation with ozone is oxygen, which is dissolved in aqueous systems. But because of ozone's highly reactive nature, it will quickly self-react and revert back to oxygen if in high concentrations or not used within short periods of time. Therefore, if ozone is used as an oxidant, it must be produced on site.

The stoichiometric oxidant demand is 0.64 mg of ozone per mg of As(III). The oxidation-reduction reaction for ozone is provided in the following equation.

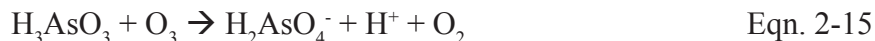

The ability of ozone to convert As(III) to As(V) was found to be relatively independent of pH in the range 6.3 – 8.3. Based on laboratory oxidation studies (Ghurye and Clifford, 2001), ozone applied in a stoichiometric excess of 3 times was capable of converting over 95% of As(III) to As(V) within 18 seconds. Dissolved iron, manganese, and TOC had no significant effects on the conversion time. However, sulfide in 1 and 2 mg/L concentrations increased the conversion time to 54 and 132 seconds, respectively.

The stoichiometric oxidant demands and the oxidation-reduction reactions for ozone to oxidize iron, manganese, and sulfide are provided below.

Stoichiometric ratio for the oxidation of Fe(II) is 0.43 mg O<sub>3</sub> per mg Fe<sup>2+</sup>.



Stoichiometric ratio for oxidation of Mn(II) is 0.88 mg O<sub>3</sub> per mg Mn<sup>2+</sup>.

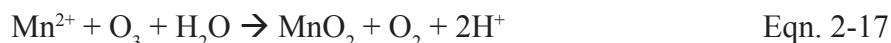

Stoichiometric ratio for oxidation of sulfide is 1.50 mg O<sub>3</sub> per mg HS<sup>-</sup>.



The primary drawback to the use of ozone is that, because ozone does not provide a secondary disinfectant, another oxidant may be required for secondary disinfection. Additionally, if a secondary disinfectant is not used in the distribution system when a POU treatment strategy is implemented, anoxic conditions could develop in the distribution system causing the As(V) to reduce back to As(III). This would decrease the effectiveness of the POU devices and increase the cost of the treatment.

Information on the design of an ozonation system can be found in Section 5.3, *Ozone Pre-Oxidation Design Considerations*.

#### 2.2.4 Solid Phase Oxidants (Filox-R™)

Filox-R™ is a granular manganese dioxide media that can catalyze the oxidation of As(III) to As(V) (Ghurye and Clifford, 2001). This media catalytically oxidizes As(III) to As(V) using dissolved oxygen in the water. The Filox-R™ media also tends to adsorb some of the arsenic. New media can adsorb as much as 26% of the arsenic. Once the media's capacity is exhausted, the media will no longer remove arsenic but will continue to oxidize it.

The stoichiometric oxidant demand is 0.21 mg of oxygen per mg of As(III). The oxidation-reduction reaction for oxygen is provided in the following equation.



Based on laboratory oxidation studies (Ghurye and Clifford, 2001) with an empty bed contact time (EBCT) of 1.5 minutes, Filox-R™ was capable of converting over 98.7% of As(III) to As(V). Decreasing the pH from 8.3 to 6.0 increased the conversion to 100%. Dissolved iron, manganese, hydrogen sulfide, and total organic carbon (TOC) were found to interfere with arsenic oxidation when the dissolved oxygen (DO) concentration was low (0.1 mg/L) and the EBCT was low (1.5 minutes). Either increasing the DO concentration (to 8.2 mg/L) or increasing the EBCT (to 6 minutes), eliminated the effects of these interfering reductants.

Filox-R™ also has the ability to remove iron, manganese, hydrogen sulfide. The stoichiometric oxidant demands and the oxidation-reduction reactions for oxygen to oxidize iron, manganese, and sulfide are provided below.

Stoichiometric ratio for the oxidation of Fe(II) is 0.43 mg O<sub>2</sub> per mg Fe<sup>2+</sup>.



Stoichiometric ratio for oxidation of Mn(II) is 0.58 mg O<sub>2</sub> per mg Mn<sup>2+</sup>.



Stoichiometric ratio for oxidation of sulfide is 0.48 mg O<sub>2</sub> per mg HS<sup>-</sup>.



The primary drawback to the use of a solid phase oxidant is that, because the solid phase oxidant does not provide a secondary disinfectant, another oxidant may be required for secondary disinfection. Additionally, if a secondary disinfectant is not used in the distribution system when a POU treatment strategy is implemented, anoxic conditions could develop in the distribution system causing the As(V) to reduce back to As(III). This would decrease the effectiveness of the POU devices and increase the cost of the treatment.

Information on the design of a solid phase oxidant system can be found in Section 5.4, *Solid Phase Oxidant Pre-Oxidation Design Considerations*.

## 2.3 Sorption Treatment Processes

The following three forms of sorption treatment are addressed: (1) ion exchange, (2) adsorption to AA media, and (3) adsorption on IBS media.

### 2.3.1 Ion Exchange

Ion exchange is a physical-chemical process in which ions are swapped between a solution phase and solid resin phase. The solid resin is typically an elastic three-dimensional hydrocarbon network containing a large number of ionizable groups electrostatically bound to the resin. These groups are exchanged for ions of similar charge in solution that have a stronger exchange affinity (i.e., selectivity) for the resin. In drinking water treatment, this technology is commonly used for POE softening and nitrate removal.

Arsenic removal is accomplished by continuously passing water under pressure through one or more columns packed with exchange resin. Figure 2-8 shows a typical process flow diagram for ion exchange. As(V) can be removed through the use of strong-base anion exchange resin (SBA) in either chloride or hydroxide form. These resins are insensitive to pH in the range 6.5 to 9.0 (USEPA, 2000; reference to Clifford et al., 1998). The following paragraphs discuss factors that affect IX system efficiency and economics.

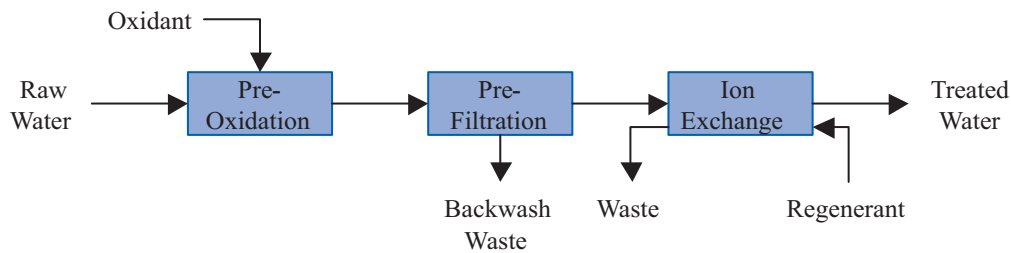

Figure 2-8. Ion Exchange Process Flow Diagram.

The exchange affinity of various ions is a function of the net surface charge. Therefore, the efficiency of the IX process for As(V) removal depends strongly on the solution pH and the concentration of other anions, most notably sulfates and nitrates. These and other anions compete for sites on the exchange resin according to the following selectivity sequence (Clifford, 1999).



High levels of total dissolved solids (TDS) can adversely affect the performance of an IX system. In general, the IX process is not an economically viable treatment technology if source water contains over 500 mg/L of TDS (Wang et al., 2000) or over 50 mg/L of sulfate (SO<sub>4</sub><sup>2-</sup>) (Kempic, 2002). Figure 2-9 illustrates the effect of sulfate ions on the performance of IX media. Although this relationship will not be exactly the same for all waters, it does provide a general indication of the impact of sulfates on IX treatment. Additionally, small amounts of iron may form a soluble complex with arsenic and carry it out of the column.

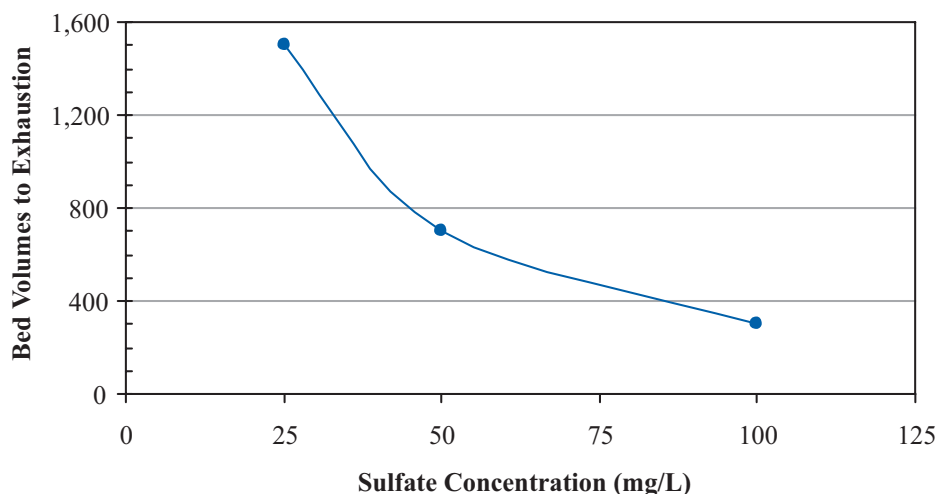

Figure 2-9. Effect of Sulfate on Ion Exchange Performance (Clifford, 1999).

One of the primary concerns related to IX treatment is the phenomenon known as chromatographic peaking, which can cause As(V) and nitrate levels in the treatment effluent to exceed those in the influent stream. This can occur if sulfates are present in the raw water and the bed is operated past exhaustion. Because sulfate is preferentially exchanged, incoming sulfate anions may displace previously sorbed As(V) and nitrate. In most groundwaters, sulfates are present in concentrations that are orders of magnitude greater than As(V). Therefore, the level of sulfates is one of the most critical factors to consider for determining the number of bed volumes that can be treated. A useful technique for avoiding chromatographic peaking is to perform careful monitoring of the effluent stream during startup. Then, based on the analysis, determine a setpoint for the total volume treated before breakthrough occurs. This volumetric setpoint would then be used to trigger the regeneration cycle. Regular monitoring of the column effluent should be continued to insure that loss of capacity in the media does not lead to premature breakthrough. Frequently, the volumetric setpoint is based on the breakthrough of sulfate. The kinetics of breakthrough are rapid; therefore a margin of safety should be provided or a guard column should be used in series with the IX column.

Hydraulic considerations associated with IX include empty bed contact time (EBCT) and headloss. The recommended EBCT range is 15 minutes. EBCTs as low as 1.5 minutes have been shown to work in some installations. The presence of suspended solids in the feed water could gradually plug the media, thereby increasing headloss and necessitating more frequent backwashing. Therefore, pre-filtration is recommended if the source water turbidity exceeds 0.3 NTU.

Another concern is resin fouling. Resin fouling occurs when mica or mineral-scale coat the resin or when ions bond the active sites and are not removable by the standard regeneration methods. This can have a significant effect on the resins capacity as the media becomes older. Replacement of the media or reconditioning may be needed after a number of years.

Resin that has been used to exhaustion can be regenerated on-site using a four-step process: (1) backwash, (2) regeneration with brine (for chloride-form SBA) or caustic soda (for hydroxide-form SBA), (3) slow water rinse, and (4) fast water rinse. It is recommended that small systems use the chloride-form resin due to the easier chemical handling considerations for regeneration.

Single-pass regeneration of anion exchange media typically produces 45 bed volumes of brine waste (USEPA, 2000; reference to AwwaRF, 1998). In a study conducted by the USEPA (Wang et al., 2000), dissolved arsenic concentrations in spent brine ranged from 1.83 mg/L to 38.5 mg/L, with an average value of 16.5 mg/L. It is anticipated that for most sources with arsenic levels above 0.010 mg/L and sulfate levels below 50 mg/L, the spent regenerant will contain at least 5.0 mg/L of dissolved arsenic.

Liquid waste streams (less than 0.5% solids) are evaluated directly against the TC to characterize hazard potential. Those liquid waste streams that contain more than 5.0 mg/L of arsenic would be classified as hazardous waste based on TC.

Indirect discharge may be an option since wastes that pass through a sewer system to a POTW are exempt from RCRA regulation. The critical factor dictating the feasibility of this option will be TBLLs for arsenic and TDS. The background level will change because of the drinking water treatment process, which may lead to revised TBLLs. The revised TBLL would be used to determine if the liquid waste stream could be discharged to the POTW. Water systems that elect to use brine recycle will further concentrate the dissolved arsenic and solids, making it even more unlikely that the stream will meet local TBLLs.

Because of RCRA requirements and cost implications, off-site disposal of hazardous waste or on-site treatment of waste is likely to be infeasible for small water systems.

Replacement of IX media may be required over time. Based on previous studies, spent IX resin does not exceed any TC concentrations, enabling it to be disposed of in a municipal solid waste landfill. This is true regardless of whether or not the media has been regenerated prior to conducting the TCLP.

Information on the design of an IX system can be found in Section 6, *Process Design Considerations*.

### **2.3.2 Activated Alumina**

Activated alumina is a porous, granular material with ion exchange properties. The media, aluminum trioxide, is prepared through the dehydration of aluminum hydroxide at high temperatures. AA grains have a typical diameter of 0.3 to 0.6 mm and a high surface area for sorption.

In drinking water treatment, packed-bed AA adsorption is commonly used for removal of natural organic matter and fluoride. The removal of As(V) by AA adsorption can be accom-



plished by continuously passing water under pressure through one or more beds packed with AA media. Figure 2-10 shows a typical process flow diagram for ion exchange. Dashed lines and boxes indicate optional streams and processes. The efficiency and economics of the system are contingent upon several factors, as discussed in the following paragraphs.

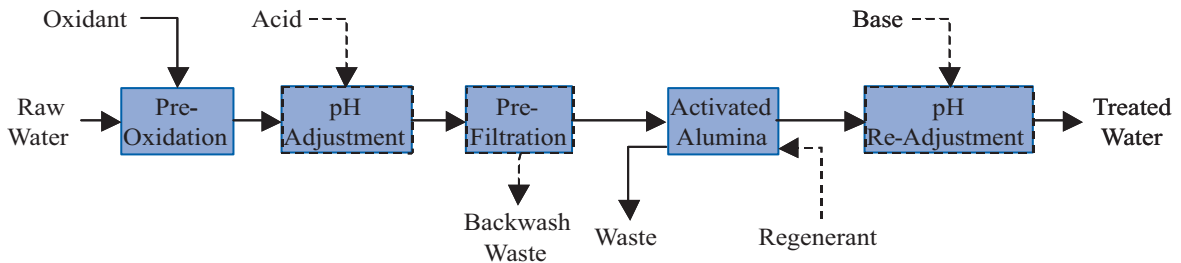
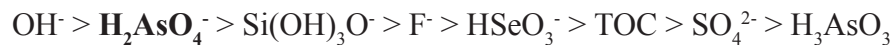

Figure 2-10. Activated Alumina Process Flow Diagram.

The level of competing ions affects the performance of AA for As(V) removal, although not in the same manner nor to the same extent as IX. The following selectivity sequence has been established for AA adsorption (USEPA, 2000):



The selectivity of AA towards As(III) is poor, owing to the overall neutral molecular charge at pH levels below 9.2. Therefore, pre-oxidation of As(III) to As(V) is critical. Several different studies have established the optimum pH range as 5.5-6.0, and demonstrated greater than 98% arsenic removal under these conditions. AA column runs operated under acidic pH conditions are 5 to 20 times longer than under natural pH conditions (6.0-9.0), as depicted in Figure 2-11. However, many small utilities elect to conduct AA treatment under natural pH conditions. In these cases, the savings in capital and chemical costs required for pH adjustment and media regeneration offset the costs associated with decreased run length.

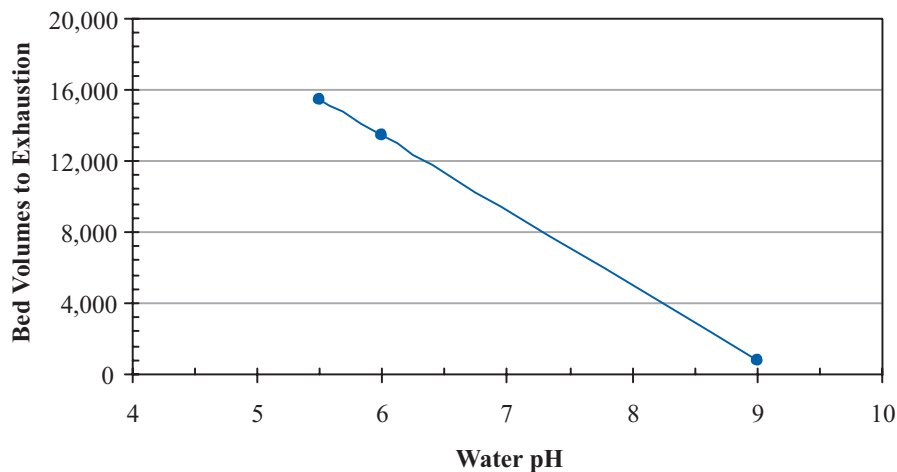

Figure 2-11. Effect of pH on Activated Alumina Performance (USEPA, 2000; original data from Hathaway and Rubel, 1987).

Several constituents can interfere with the adsorption process, either by competing for adsorption sites or clogging the media with particulate matter. These constituents, and their corresponding problematic levels, are summarized in Table 2-3.

<b>Parameter</b>	<b>Problem Level</b>
Chloride	250 mg/L <sup>1</sup>
Fluoride	2 mg/L <sup>1</sup>
Silica	30 mg/L <sup>2</sup>
Iron	0.5 mg/L <sup>1</sup>
Manganese	0.05 mg/L <sup>1</sup>
Sulfate	720 mg/L <sup>3</sup>
Dissolved Organic Carbon	4 mg/L <sup>3</sup>
Total Dissolved Solids	1,000 mg/L <sup>3</sup>

<sup>1</sup> AwwaRF (2002)

<sup>2</sup> Clifford (2001)

<sup>3</sup> Wang, et al. (2000)

Hydraulic considerations associated with AA adsorption include empty bed contact time and headloss. For most types of AA media, the recommended EBCT range is 310 minutes. The presence of suspended solids in the feed water could gradually clog the media, thereby increasing headloss. Pre-filtration is recommended for sources where the turbidity exceeds 0.3 NTU.

The technologies and market for alumina-based adsorptive media continue to expand. There are several emerging proprietary media, commonly referred to as modified AA, which contain alumina in a mixture with other substances such as iron and sulfur. In some instances, these media have greater overall adsorptive capacities, enhanced selectivity towards arsenic, and/or greater overall operational flexibility than conventional AA, thus making them more cost-effective. To account for this industry growth, the decision trees in Section 3 include a treatment alternative known as modified-AA. If this endpoint is reached, the water system should strongly consider more detailed investigation into current, innovative media. It is required by most states that all media used in water treatment be approved under NSF Standard 61.

AA media can either be regenerated on-site or disposed of and replaced with fresh media. On-site regeneration of AA media typically produces 37 to 47 bed volumes of caustic soda waste (USEPA, 2000). Because of the high pH of the regeneration process, roughly 2% of the AA media dissolves during each regeneration sequence. Therefore, the waste solution typically contains high levels of TDS, aluminum, and soluble arsenic. In most cases, this arsenic level will exceed the 5.0 mg/L TC, and the waste stream will be classified as a hazardous liquid waste. Backwashing may also be necessary to prevent cementation of the media, which can occur as a result of dissolution caused by chemical addition during regeneration. For these reasons, regeneration of AA is likely to be an infeasible option for most small water systems.

The alternative for utilities considering AA adsorption is the use of throwaway media, operated with or without pH adjustment. The savings in O&M requirements and residuals disposal may offset the cost of periodically replacing the media. For this option, systems must provide an equalization basin for backwash water (if applicable) and a staging area to store spent media prior to disposal. Throwaway AA media is expected to not exceed any TCs, enabling it to be disposed of in a municipal solid waste landfill (Wang et al., 2000). As an added convenience to small systems, media suppliers may offer a media disposal service with the purchase of their media.

Information on the design of an AA system can be found in Section 6, *Sorption Process Design Considerations*. Information on POU systems can be found in Section 8.1.1, *Adsorption Point-of-Use Treatment*.

### 2.3.3 Iron Based Sorbents

Adsorption on IBS is an emerging treatment technique for arsenic. Examples of IBS products currently available with NSF 61 approval are shown in Table 2-4. The sorption process has been described as chemisorption (Selvin et al., 2000), which is typically considered to be irreversible. It can be applied in fixed bed pressure columns, similar to those for AA. Due to limited performance research at the time the Arsenic Rule was promulgated, it was not designated as a BAT or a SSCT by the USEPA.

**Table 2-4. Examples of Iron Based Sorbents. <sup>1</sup>**

Product Name	Company	Material Type
G2	ADI International	Modified Iron
SMI III	SMI	Iron/Sulfur
GFH	U.S. Filter/General Filter Products	Granular Ferric Hydroxide
Bayoxide E 33	Bayer AG	Iron Oxide

<sup>1</sup> Examples are taken from Rubel 2003.

The few studies conducted with IBS media have revealed that the affinity of this media for arsenic is strong under natural pH conditions, relative to AA. This feature allows IBS to treat much higher bed volumes without the need for pH adjustment. However, similar to AA, optimal IBS performance is obtained at lower pH values. The recommended operating conditions include an EBCT of 5 minutes and a hydraulic loading rate of 5 gpm/sft.

Phosphate has been shown to compete aggressively with As(V) for adsorption sites. Each 0.5 mg/L increase in phosphate above 0.2 mg/L will reduce adsorption capacity by roughly 30% (Tumalo, 2002).

In previous studies, exhausted IBS media has not exceeded any TCs, enabling it to be disposed of in a municipal solid waste landfill (MacPhee et al., 2001). As an added convenience to small systems, media suppliers may offer a media disposal service with the purchase of their media.

Information on the design of IBS systems can be found in Section 6, *Sorption Process Design Considerations*. Information on POU systems can be found in Section 8.1.1, *Adsorption Point-of-Use Treatment*.

## 2.4 Membrane Treatment Processes

Membrane separation technologies are attractive arsenic treatment processes for small water systems. They can address numerous water quality problems while maintaining simplicity and ease of operation. The molecular weight cut-off of microfiltration (MF) processes necessitates the use of a coagulation stage to generate arsenic-laden floc and is therefore discussed in Section 2.5.3, *Coagulation-Assisted Microfiltration*. However, RO units have a much larger retention spectrum, and can be used as stand-alone arsenic treatment under most water quality conditions. Figure 2-12 provides a block flow diagram for a typical RO membrane process. Dashed lines indicate optional streams and processes.

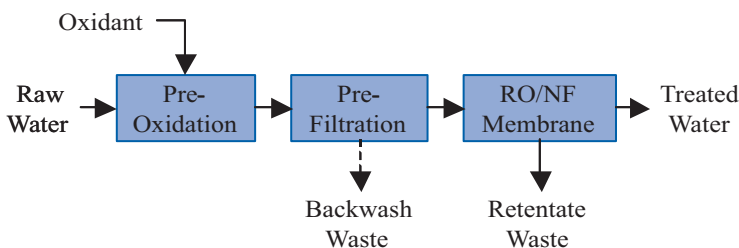

Figure 2-12. RO Membrane Process Flow Diagram.

Most RO membranes are made of cellulose acetate or polyamide composites cast into a thin film. The semi-permeable (non-porous) membrane is then constructed into a cartridge called an RO module, typically either hollow-fiber or spiral-wound.

RO is a pressure-driven membrane separation process capable of removing dissolved solutes from water by means of particle size, dielectric characteristics, and hydrophilicity/hydrophobicity. Reverse osmosis is capable of achieving over 97% removal of As(V) and 92% removal of As(III) in a single pass (NSF, 2001a; NSF 2001b). As an added benefit, RO also effectively removes several other constituents from water, including organic carbon, salts, dissolved minerals, and color. The treatment process is relatively insensitive to pH. In order to drive water across the membrane surface against natural osmotic pressure, feed water must be sufficiently pressurized with a booster pump. For drinking water treatment, typical operating pressures are between 100 and 350 psi. Water recovery is typically 60–80%, depending on the desired purity of the treated water. In some cases, particularly POU applications, RO units are operated at tap water pressures. This results in a significantly lower water recovery.

Multiple RO units can be applied in series to improve the overall arsenic removal efficiency. Figure 2-13 illustrates a 2-stage RO treatment process. The overall rejection rate for a multi-staged RO treatment process can be calculated as:

$$E = 1 - (1 - E_S)^n \quad \text{Eqn. 2-23}$$

Where:

- $E$  = Overall Rejection Rate (Treatment Efficiency),
- $E_S$  = Individual Stage Contaminant Rejection Rate, and
- $n$  = Number of Stages.

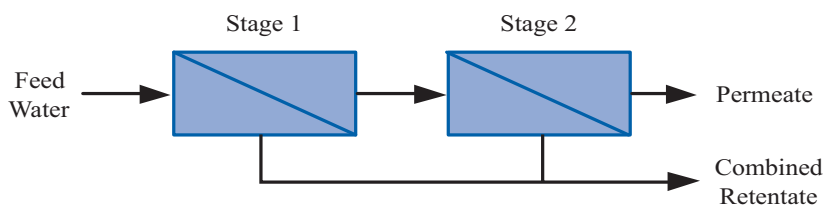

Figure 2-13. Two-Stage RO Treatment Process Schematic.

Membrane fouling can occur in the presence of NOM and various inorganic ions, most notably calcium, magnesium, silica, sulfate, chloride, and carbonate. These ions can be concentrated (in the retentate) to concentrations an order of magnitude higher than in raw water. This can lead to the formation of scale on the membrane surface, which in turn can cause a decline in arsenic rejection and water recovery. Further, the membrane surface can act as a substrate for biological growth. Membrane cleaning can restore treatment performance; however, the cleaning process is difficult and costly. The rate of membrane fouling depends on the configuration of the module and feed water quality. Most RO modules are designed for cross-flow filtration, which allows water to permeate the membrane while the retentate flow sweeps rejected salts away from the membrane surface. In many cases, pre-filtration (commonly through sand or granular activated carbon) is worthwhile. This minimizes the loading of salt precipitates and suspended solids on the membrane surface, thereby extending run length, improving system hydraulics, and reducing O&M requirements.

Some membranes, particularly those composed of polyamides, are sensitive to chlorine. Feed water should be dechlorinated (if applicable) in these instances. Another potential concern associated with RO treatment is the removal of alkalinity from water, which in turn could affect corrosion control within the distribution system. If feasible, this problem can usually be avoided by conducting sidestream treatment for arsenic removal.

Indirect discharge to a POTW or direct discharge to an on-site sewerage system (for POU systems) are considered the most viable residuals disposal option. For those systems considering indirect discharge, the retentate must meet local TBLLs for arsenic. The arsenic concentration in the retentate can be calculated using Equation 2-24.

$$C_{R,i} = \frac{C_i \cdot E_S}{1 - \beta} \quad \text{Eqn. 2-24}$$

Where:

- $C_{R,i}$  = Concentration of Species  $i$  in the Retentate (mg/L),
- $C_i$  = Concentration of Species  $i$  in the Feed Stream (mg/L),

- $E_s$  = Individual Stage Contaminant Rejection Rate (% expressed as a decimal), and  
 $\beta$  = Individual Stage Water Recovery Rate (% expressed as a decimal).

It is not anticipated that a small system will use an RO system for centralized treatment because RO systems for centralized treatment can be expensive. Therefore, no design information on centralized systems has been provided in this Handbook. However, information on RO POU systems can be found in Section 8.1.2, *Reverse Osmosis Point-of-Use Treatment*.

## 2.5 Precipitation/Filtration Treatment Processes

- The following four chemical precipitation processes are addressed:
- LS,
- Conventional Gravity Coagulation/Filtration,
- CMF,
- CADF, and
- Oxidation/Filtration.

Figure 2-14 provides a block flow diagram for a generic precipitation/filtration process. Dashed lines and boxes indicate optional streams and processes.

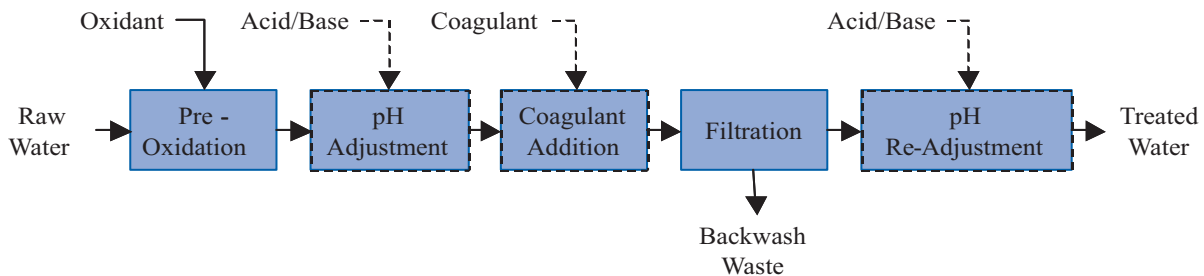

Figure 2-14. Generic Precipitation/Filtration Process Flow Diagram.

### 2.5.1 Enhanced Lime Softening

Lime softening is a chemical-physical treatment process used to remove calcium and magnesium cations from solution. The addition of lime increases the pH of solution, thereby causing a shift in the carbonate equilibrium and the formation of calcium carbonate and magnesium hydroxide precipitates. These precipitates are amenable to removal by clarification and filtration.

LS solely for arsenic removal is uneconomical and is generally considered cost-prohibitive. However, for water systems that use LS to reduce hardness, the process can be enhanced for arsenic removal. To remove As(V), additional lime is added to increase the pH above 10.5. In this range magnesium hydroxide precipitates and As(V) is removed by co-precipitation with it. As(V) removal by co-precipitation with calcium carbonate (i.e., below a pH of 10.5) is poor (less than 10%).

The amount of waste residual produced by LS is dependent on the hardness removed. While the total volume of waste produced from LS is typically higher than that produced by coagulation/filtration and co-precipitative processes, the arsenic concentration in the sludge is generally lower because more solids are produced. Typical solids concentrations are 1 - 4% arsenic. Prior to disposal, this waste residual will require thickening and dewatering, most likely via mechanical devices. Previous studies have indicated that typical lime sludge will not exceed TC limits, enabling it to be disposed of in a municipal solid waste landfill (Fields et al., 2000a).

Because LS is unlikely to be installed solely for arsenic removal in small systems, no design discussion is provided in this Handbook.

### **2.5.2 Conventional Gravity Coagulation/Filtration**

Coagulation is the process of destabilizing the surface charges of colloidal and suspended matter to allow for the agglomeration of particles. This process results in the formation of large, dense floc, which is amenable to removal by clarification or filtration. The most widely used coagulants for water treatment are aluminum and ferric salts, which hydrolyze to form aluminum and iron hydroxide particulates, respectively.

Conventional gravity coagulation/filtration processes use gravity to push water through a vertical bed of granular media that retains the floc and are typically used within surface water treatment plants. They are less commonly used for treatment of groundwater supplies since these sources usually contain much lower concentrations of suspended solids, organic carbon, and pathogenic microorganisms. Installation and operation of a conventional gravity coagulation/filtration process solely for arsenic removal is uneconomical.

Coagulation/filtration processes can be optimized to remove dissolved inorganic As(V) from water. The mechanism involves the adsorption of As(V) to an aluminum or ferric hydroxide precipitate. The As(V) becomes entrapped as the particle continues to agglomerate. As(III) is not effectively removed because of its overall neutral charge under natural pH conditions. Therefore, pre-oxidation is recommended. The efficiency and economics of the system are contingent upon several factors, including the type and dosage of coagulant, mixing intensity, and pH. In general, however, optimized coagulation-filtration systems are capable of achieving over 90% removal of As(V) and producing water with less than 0.005 mg/L of As(V). Influent As(V) levels do not appear to impact the effectiveness of this treatment process.

Iron-based coagulants, including ferric sulfate and ferric chloride, are more effective at removing As(V) than their aluminum-based counterparts. This is because iron hydroxides are more stable than aluminum hydroxides in the pH range 5.5 to 8.5. A fraction of the aluminum remains as a soluble complex, which is incapable of adsorbing As(V) and can pass through the filtration stage. The optimal pH ranges for coagulation with aluminum and ferric salts are 5 to 7 and 5 to 8, respectively. At pH values above 7, the removal performance of aluminum-based coagulants drops markedly. Feed water pH should be adjusted

to the appropriate range prior to coagulant addition. Post-filtration pH adjustment may be necessary to optimize corrosion control and comply with other regulatory requirements.

Several batch studies have demonstrated that As(V) removal is positively related to coagulant dosage. However, specific dose requirements needed to meet As(V) removal objectives were contingent upon the source water quality and pH. Effective coagulant dosage ranges were 5-25 mg/L of ferric chloride and as much as 40 mg/L of alum.

Water intended for indirect discharge will be subject to TBLLs for TDS and arsenic. Dewatering can be accomplished by gravity thickening, followed by other mechanical or non-mechanical techniques. Settling basins can be used to allow settleable solids to drop out of solution via gravity, while the supernatant can be decanted and recycled to the process head. The solids can be slurried out periodically and passed through a small filter press for dewatering. The resultant sludge can be disposed of in a municipal solid waste landfill if it meets the criteria of the PFLT (no free liquid) and the TCLP. Previous studies have indicated that typical coagulation/filtration sludge will not exceed TC limits (Fields et al., 2000a).

Because conventional gravity coagulation filtration is unlikely to be installed solely for arsenic removal in small systems, no design discussion is provided in this Handbook.

### **2.5.3 Coagulation-Assisted Microfiltration**

Coagulation-Assisted Microfiltration uses the same coagulation process described above. However, instead of the granular media filtration step, the water is forced through a semi-permeable membrane by a pressure differential. The membrane retains the As(V) laden floc formed in the coagulation step.

The use of pre-engineered CMF package plants is a realistic possibility for new installations where water quality precludes the use of sorption treatment. Due to limited full-scale application, it was not designated as a BAT by the USEPA but was listed as a SSCT in the final rule.

The membrane must be periodically backwashed to dislodge solids and restore hydraulic capacity. Backwash water is typically a high-volume, low solids (less than 1.0%) waste stream. The specific amount of solids will depend on several factors, including coagulant type, dosage, filter run length, and ambient solids concentration. Two treatment options are available for this waste stream: (1) indirect discharge, and (2) dewatering and sludge disposal (AwwaRF 2000).

Water intended for indirect discharge will be subject to TBLLs for TDS and arsenic. Dewatering can be accomplished by gravity thickening, followed by other mechanical or non-mechanical techniques. Settling basins can be used to allow settleable solids to drop out of solution via gravity, while the supernatant can be decanted and recycled to the process head. The solids can be slurried out periodically and passed through a small filter press for dewatering. The resultant sludge can be disposed of in a municipal solid waste landfill if it meets



the criteria of the PFLT (no free liquid) and the TCLP. Previous studies have indicated that typical CMF sludge will not exceed TC limits (Fields et al., 2000a).

Design of a CADF system can be found in Section 7, *Pressurized Media Filtration Process Design Considerations*.

### **2.5.5 Oxidation/Filtration**

Oxidation/filtration refers to processes that are designed to remove naturally occurring iron and manganese from water. The processes involve the oxidation of the soluble forms of iron and manganese to their insoluble forms and then removal by filtration. If arsenic is present in the water, it can be removed via two primary mechanisms: adsorption and co-precipitation. First, soluble iron and As(III) are oxidized. The As(V) then adsorbs onto the iron hydroxide precipitates that are ultimately filtered out of solution.

Although some arsenic may be removed by adsorption/co-precipitation with manganese, iron is much more efficient for arsenic removal. The arsenic removal efficiency is strongly dependent on the initial iron concentration and the ratio of iron to arsenic. In general, the Fe:As mass ratio should be at least 20:1. These conditions customarily result in an arsenic removal efficiency of 80-95%. In some cases, it may be appropriate to add ferric coagulant to the beginning of the iron removal process to optimize arsenic removal.

The effectiveness of arsenic co-precipitation with iron is relatively independent of source water pH in the range 5.5 to 8.5. However, high levels of NOM, orthophosphates, and silicates weaken arsenic removal efficiency by competing for sorption sites on iron hydroxide precipitates (Fields et al., 2000b).

The common iron/manganese methods consist of (1) air oxidation or chemical oxidation followed by media filtration and (2) potassium permanganate oxidation followed by a greensand media filter. The latter process is commonly referred to as the greensand process. The greensand process can be operated on an intermittent regeneration (IR) basis or on a continuous feed (CF) basis. With IR operational procedure, the greensand filter is periodically regenerated with potassium permanganate following the back washing of the filter. In the CF mode, permanganate or chlorine is continuously added to the feed water ahead of greensand filter.

In the air/chemical oxidation filtration iron removal process, the iron is oxidized with either air (aeration tower) or with an oxidizing chemical, usually chlorine. Because of the limitations of air to oxidize As(III), chlorine is normally used in order for the process to be effective for arsenic removal. After the water is oxidized, it is filtered with a granular media to remove the iron hydroxide precipitates that contain the adsorbed arsenic. The effectiveness of the granular media is important because any iron particles that manage to get through the filter media will contain some arsenic.

The greensand process is a special case of pressurized granular-media filtration where the granular media, greensand, catalyzes the oxidation and precipitation of iron and manganese. In the greensand process, operated on an IR basis, the water is passed through a column of greensand media, which adsorbs and catalyzes the oxidation of the iron and manganese. In order for greensand to retain its adsorption and catalytic oxidation capabilities, the media must be regenerated with permanganate or chlorine. When operated on an IR basis, the greensand filter column is taken off line and the media is soaked in a solution of permanganate. In the CF mode, permanganate or chlorine is continuously added to the feed water ahead of greensand filter where they provide continuous oxidation of the iron and As(III) and regeneration of the greensand. If the arsenic in the ground water is not already oxidized to As(V), it is recommended that CF process using chlorine or permanganate be used to provide continuous oxidation of the iron, manganese, and As(III).

Greensand is manufactured by coating glauconite with manganese dioxide. Other manganese dioxide media are also used for iron and manganese removal such as pyrolucite, Pyrolox<sup>®6</sup>, Filox-R<sup>™7</sup>, MTM<sup>®8</sup>, BIRM<sup>®9</sup>, and Anthrasand. Greensand and some of the other manganese dioxide media (Filox-R<sup>™</sup>) have been shown to have some arsenic adsorptive effectiveness in removing arsenic from drinking water (Hanson et al., 1999, Fields et al., 2000b, Ghurye and Clifford, 2001).

In all oxidation/filtration processes, the filter media must be periodically backwashed to dislodge solids and restore hydraulic capacity. Backwash water is typically a high-volume, low solids (less than 0.1%) waste stream. The specific amount of solids will depend on several factors, including raw water iron levels, coagulant addition (if any), filter run length, and background solids concentration. Two treatment options are available for this waste stream: (1) indirect discharge and (2) dewatering and sludge disposal.

Water intended for indirect discharge will be subject to TBLLs for TDS and arsenic. The background level will change because of the drinking water treatment process, which may lead to revised TBLLs. The revised TBLL would be used to determine if the liquid waste stream could be discharged to the POTW. Dewatering can be accomplished by gravity thickening, followed by other mechanical or non-mechanical techniques. Settling basins can be used to provide gravity clarification, while the supernatant can be decanted and recycled to the process head. The solids can be slurried out periodically and passed through a filter press for dewatering. The resultant sludge can be disposed of in a municipal solid waste landfill if it passes the PFLT (no free liquid) and the TCLP. Previous studies have indicated that typical ferric coagulation-filtration sludge will not exceed TC limits (Fields et al., 2000b).

Design of an oxidation/filtration system can be found in Section 7, *Pressurized Media Fil-*

---

<sup>6</sup> Pyrolox is a trademark of American Materials.

<sup>7</sup> Filox is a registered trademark of Matt-Son, Inc., Barrington, IL. Filox-R is a trademark of Matt-Son, Inc., Barrington, IL.

<sup>8</sup> MTM is a registered trademark of Clack Corporation, Windsor, WI.

<sup>9</sup> Birm is a registered trademark of Clack Corporation, Windsor, WI.

## **2.6 Point-of-Use Treatment**

Under the final Arsenic Rule, POU devices are approved as SSCTs. However, SDWA requires that the devices be owned, controlled, and maintained by the public water utility or by an agency under contract with the water utility. Therefore, the responsibility of operating and maintaining the devices cannot be passed to the customer.

POU devices are particularly attractive for removing contaminants that pose only an ingestion risk, as is the case with arsenic. This is because a very small fraction of the total water supplied to a given household is ultimately consumed. In most cases, the POU unit is plumbed in at the kitchen sink (the device will have its own faucet).

The primary advantage of employing POU treatment in a small system is reduced capital and treatment costs, relative to centralized treatment. On the downside, however, these programs generally incur higher administrative and monitoring costs to make sure that all units are functioning properly. Previous studies have suggested that POU programs are an economically viable alternative to centralized treatment for systems serving roughly 50-500 people.

Most POU devices do not address the issue of pre-oxidation. While RO may remove As(III) to acceptable standards, sorptive processes such as AA or IBS will probably not. In this case, water systems may need to conduct centralized chlorine treatment to convert As(III) to As(V). There is also a concern that even with centralized pre-oxidation, anoxic conditions could exist in the distribution system that allow As(V) to reduce back to As(III). Depending on the extent of reduction, this could be detrimental to a POU program.

The technologies that are most amenable to POU treatment include AA, IBS, and RO. AA and RO are approved as SSCTs for POU applications (USEPA, 2002a). Although there are no IBS systems currently approved as SSCTs, there are several media currently being tested.

The primary criteria for selecting an appropriate POU treatment device are arsenic removal performance and cost. The unit must be independently certified against NSF/ANSI product standards to be used for compliance purposes.

More information on POU technologies and can be found in Section 8, *Point-of-Use Treatment*, and in USEPA's soon to be released *Guidance for Implementing a Point-of-Use or Point-of-Entry Treatment Strategy for Compliance with the Safe Drinking Water Act* (USEPA, 2002b Draft).

This page intentionally left blank.

# Section 3

## Arsenic Treatment Selection

---

### 3.1 Selection Criteria

The task of navigating through the alternative arsenic treatment technologies involves several technical considerations. Although nearly all of the unit processes previously presented could be used for arsenic reduction at an arbitrary site, some are more economically viable under specific circumstances. Optimization of existing processes is a realistic option for some utilities. Although most water systems today have been designed without the goal of arsenic removal, many current practices may accomplish incidental removal. Optimization of these processes is a realistic option. The utility should coordinate the selection and implementation process with its state drinking water program.

#### 3.1.1 Source Water Quality

Source water quality dictates the performance of the removal processes identified in Section 2. In turn, process performance, associated O&M requirements, and residuals disposal dictate the economics of a particular treatment approach. Therefore, it is important that utilities conduct thorough up-front monitoring of water quality at all active sources to make the most informed treatment selection decision.

Tables 3-1 and 3-2 provide a summary of recommended monitoring parameters and associated analytical methods. The parameters are divided into two categories: (1) Key and (2) Other. Key parameters are those most critical to evaluating the treatment performance potential of various arsenic removal processes. These parameters should be monitored multiple times over the course of several weeks or months to capture variability in concentrations. Other parameters should be monitored at least once in order to optimize the selected arsenic treatment method.

**Table 3-1. Key Water Quality Parameters to be Monitored.**

Parameter	USEPA Method	Standard Method <sup>3</sup>	ASTM <sup>4</sup>
Arsenic, Total <sup>1</sup>	200.8	3113 B	D2972-93B
	200.9	3114 B	D2972-93C
Arsenite {As(III)}		3500-As B	
Arsenate {As(V)}		3500-As B	
Chloride (Cl <sup>-</sup> ) <sup>2</sup>	300.0	4110 B	D4327-91 D512-89B
		4500-Cl <sup>-</sup> D	
		4500-Cl <sup>-</sup> B	
Fluoride (F <sup>-</sup> ) <sup>1,2</sup>	300.0	4110 B	D4327-91 D1179-93B
		4500-F <sup>-</sup> B	
		4500-F <sup>-</sup> C	
		4500-F <sup>-</sup> D	
		4500-F <sup>-</sup> E	
Iron (Fe) <sup>2</sup>	200.7 200.9	3120 B	
		3111 B	
		3113 B	
Manganese (Mn) <sup>2</sup>	200.7 200.8 200.9	3120 B	
		3111 B	
		3113 B	
Nitrate (NO <sub>3</sub> <sup>-</sup> ) <sup>1</sup>	300.0 353.2	4110 B	D4327-91 D3867-90A D3867-90B
		4500-NO <sub>3</sub> <sup>-</sup> F	
		4500-NO <sub>3</sub> <sup>-</sup> D	
Nitrite (NO <sub>2</sub> <sup>-</sup> ) <sup>1</sup>	300.0 353.2	4110 B	D4327-91 D3867-90A D3867-90B
		4500-NO <sub>3</sub> <sup>-</sup> F	
		4500-NO <sub>3</sub> <sup>-</sup> E	
		4500-NO <sub>2</sub> <sup>-</sup> B	
Orthophosphate (PO <sub>4</sub> <sup>-3</sup> ) <sup>1</sup>	365.1 300.0	4500-P F	D515-88A D4327-91
		4500-P E	
		4110 B	
pH <sup>1,2</sup>	150.1 150.2	4500-H <sup>+</sup> B	D1293-95
Silica <sup>1</sup>	200.7	4500-Si D	D859-95
		4500-Si E	
		4500-Si F	
Sulfate (SO <sub>4</sub> <sup>-2</sup> ) <sup>2</sup>	300.0 375.2	4110 B	D4327-91 D516-90
		4500-SO <sub>4</sub> <sup>-2</sup> F	
		4500-SO <sub>4</sub> <sup>-2</sup> C	
		4500-SO <sub>4</sub> <sup>-2</sup> D	
		4500-SO <sub>4</sub> <sup>-2</sup> E	
Total Dissolved Solids (TDS) <sup>2</sup>		2540 C	
Total Organic Carbon (TOC)	415.1		

<sup>1</sup> USEPA Approved Methods for Drinking Water Analysis of Inorganic Chemicals and other parameters.

<sup>2</sup> USEPA Recommended Methods for Secondary Drinking Water Contaminants.

<sup>3</sup> 18th and 19th editions of Standard Methods for the Examination of Water and Wastewater, 1992 and 1995, American Water Works Association (AWWA).

<sup>4</sup> Annual Book of ASTM Standards, 1994 and 1996, Vols. 11.01 and 11.02, American Society for Testing and Materials (ASTM).

**Table 3-2. Other Water Quality Parameters to be Monitored.**

Parameter	USEPA Method	Standard Method <sup>3</sup>	ASTM <sup>4</sup>
Alkalinity <sup>1</sup>		2320 B	D1067-92B
Aluminum (Al) <sup>2</sup>	200.7	3120 B	
	200.8	3113 B	
	200.9	3111 D	
Calcium (Ca <sup>2+</sup> ) <sup>1</sup>	200.7	3500-Ca D	D511-93A D511-93B
		3111 B	
		3120 B	
Magnesium (Mg <sup>2+</sup> ) <sup>1</sup>	200.7	3113 B	D511-53B D511-93B
		3120 B	
		3500-Mg E	
Turbidity	180.1		
Water Hardness	215.1		
	242.1		

<sup>1</sup> USEPA Approved Methods for Drinking Water Analysis of Inorganic Chemicals and other parameters.

<sup>2</sup> USEPA Recommended Methods for Secondary Drinking Water Contaminants.

<sup>3</sup> 18th and 19th editions of Standard Methods for the Examination of Water and Wastewater, 1992 and 1995, American Water Works Association (AWWA).

<sup>4</sup> Annual Book of ASTM Standards, 1994 and 1996, Vols. 11.01 and 11.02, American Society for Testing and Materials (ASTM).

### 3.1.2 Process Evaluation Basis

There are several variables, design criteria, and assumptions that should be established prior to navigating the decision trees and cost tables. These include the following:

- Existing Treatment Processes
- Target Finished Water Arsenic Concentration
- TBLLs for Arsenic and TDS
- Domestic Waste Discharge Method
- Land Availability
- Labor Commitment
- Acceptable Percent Water Loss
- Maximum Source Flowrate
- Average Source Flowrate
- State or primacy agency requirements that are more stringent than those of the USEPA.

## 3.2 Process Selection Decision Trees

Decision trees are useful tools for narrowing the field of available treatment technologies to those that are most economical for a particular system. This is accomplished through a series of input-output blocks, which direct the utility along the path towards the best technologies. While they do not always point to a single solution, they allow the utility to rapidly eliminate some technologies that are cost-prohibitive for a specific application.

**It is critical that the utility employ these decision trees, rather than the cost correlation curves, as the primary tool for selecting an arsenic mitigation strategy. These trees take into account system-specific conditions and system preferences.**

The decision trees guide the utility to the technologies that are expected to work best for their particular situation. In some cases, the pathway is contingent upon a water utility's willingness to impose a particular change in their operating scheme. These decision-making scenarios were presented only for cases where it may be economically advantageous to make such a change. However, there may be other restrictions (i.e., operating labor, space) to making the operational changes in question. In other cases, there may be more than one equally viable technology. At that point, the water utility should further evaluate its preferences with respect to costs and labor commitments, and capabilities with respect to residuals disposal and facility expansion.

The decision trees employ the following labeling scheme:

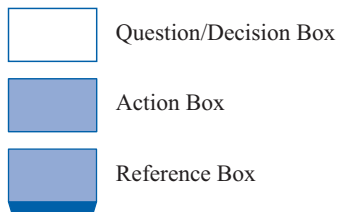

The Question/Decision block requests information or utility preference in the form of a yes/no or multiple-choice question. The Action Box provides the recommended follow-up action given system-specific constraints and preferences. This box is frequently used as the stopping point for a particular branch of the decision tree. The Reference Box simply directs the utility to another portion of the decision tree.

If a utility reaches an action box pertaining to switching sources, blending, or existing treatment optimization, they should refer to Section 2 for more specific information. If a utility reaches an action box pertaining to new treatment installation, they should refer to Section 4 for cost information and Sections 6-8 for specific design considerations.

The decision trees are intended for use as an iterative tool. If a utility proceeds to a specific action box, conducts follow-up cost estimation, process optimization, and/or pilot-testing, and the results indicate that the selected strategy may be ineffective or too expensive for arsenic removal, the utility can restart the tree and modify preferences.

The following assumptions were made in the development of the decision trees:

- Optimization of existing treatment process is economically preferable over new installations.
- Construction of new conventional gravity coagulation/filtration or LS systems is not appropriate for the sole purpose of arsenic removal.
- Small water systems would opt for disposable adsorptive media rather than conduct on-site regeneration.
- Small systems would choose to not generate hazardous waste for either on-site treatment or off-site disposal.



# Decision Tree Overview

## Non-Treatment Alternatives

- **Tree 1 Non-Treatment Alternatives**

## Treatment Selection

- **Tree 2 Treatment Selection**
  - Tree 2a Enhanced Coagulation/Filtration**
  - Tree 2b Enhanced Lime Softening**
  - Tree 2c Iron & Manganese Filtration**

## Selecting New Treatment

- **Tree 3 Selecting New Treatment**
  - Tree 3a Ion Exchange Processes**
  - Tree 3b Sorption Processes**
  - Tree 3c Filtration & Membrane Processes**

Figure 3-1. Decision Tree Overview.

# Tree 1

## Non-Treatment Alternatives

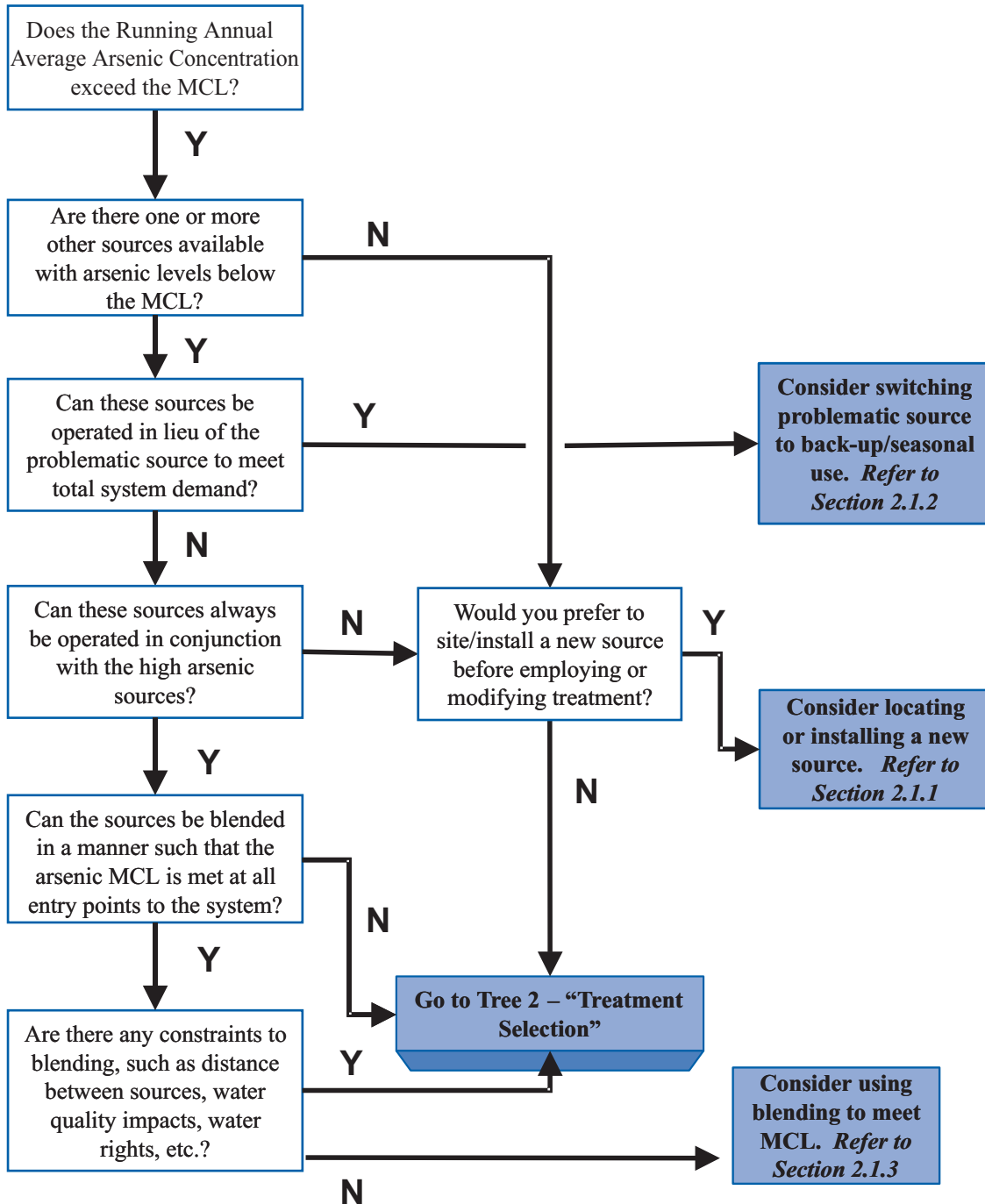
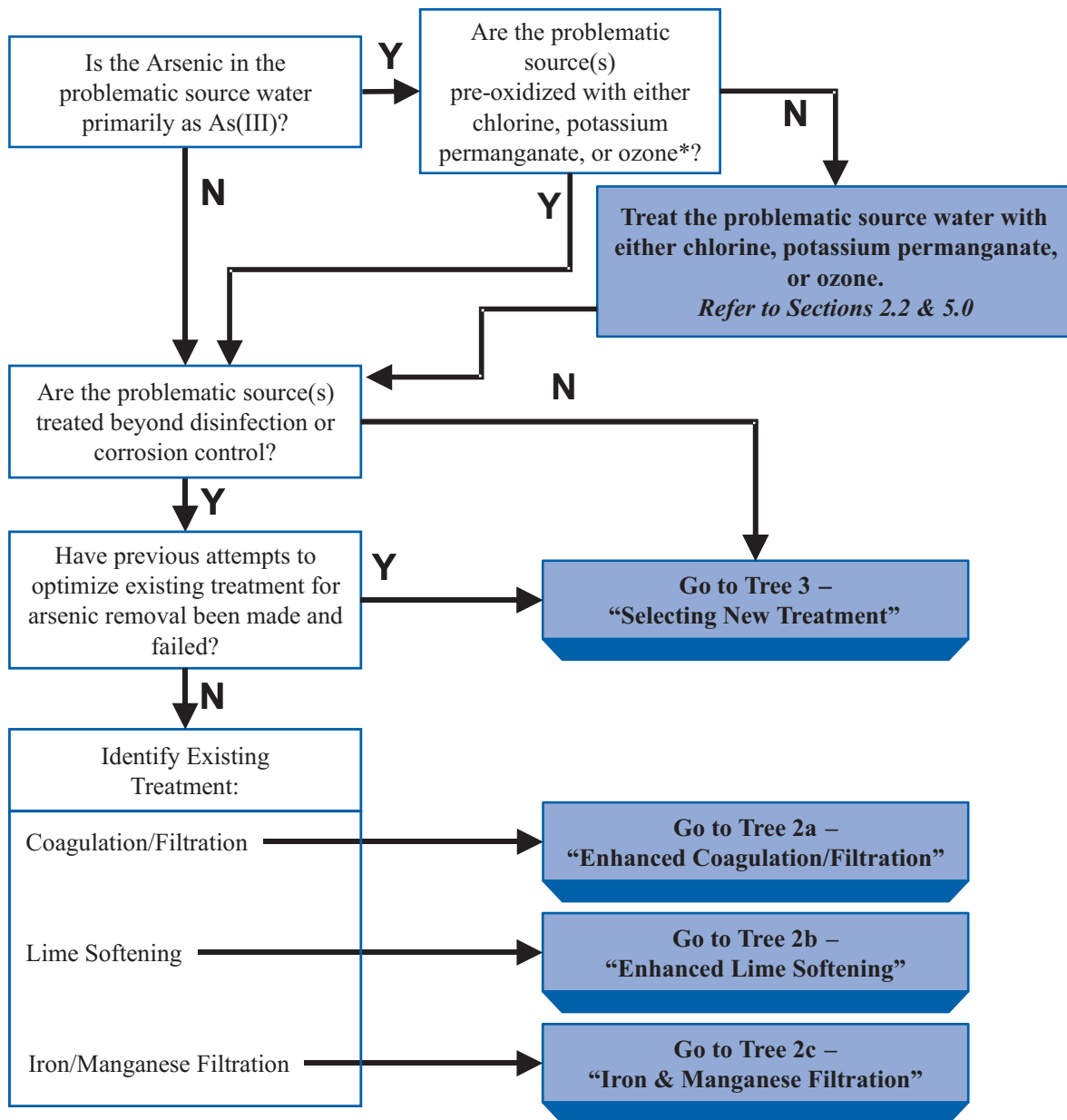

Figure 3-2. Decision Tree 1 – Non-Treatment Alternatives.

# Tree 2 Treatment Selection



\*Pre-oxidized refers to the process of converting As(III) to As(V)

Figure 3-3. Decision Tree 2 - Treatment Selection.

Use this decision tree only after using Tree 1 “Non-Treatment Alternatives.”

# Tree 2a

## Enhanced Coagulation/Filtration

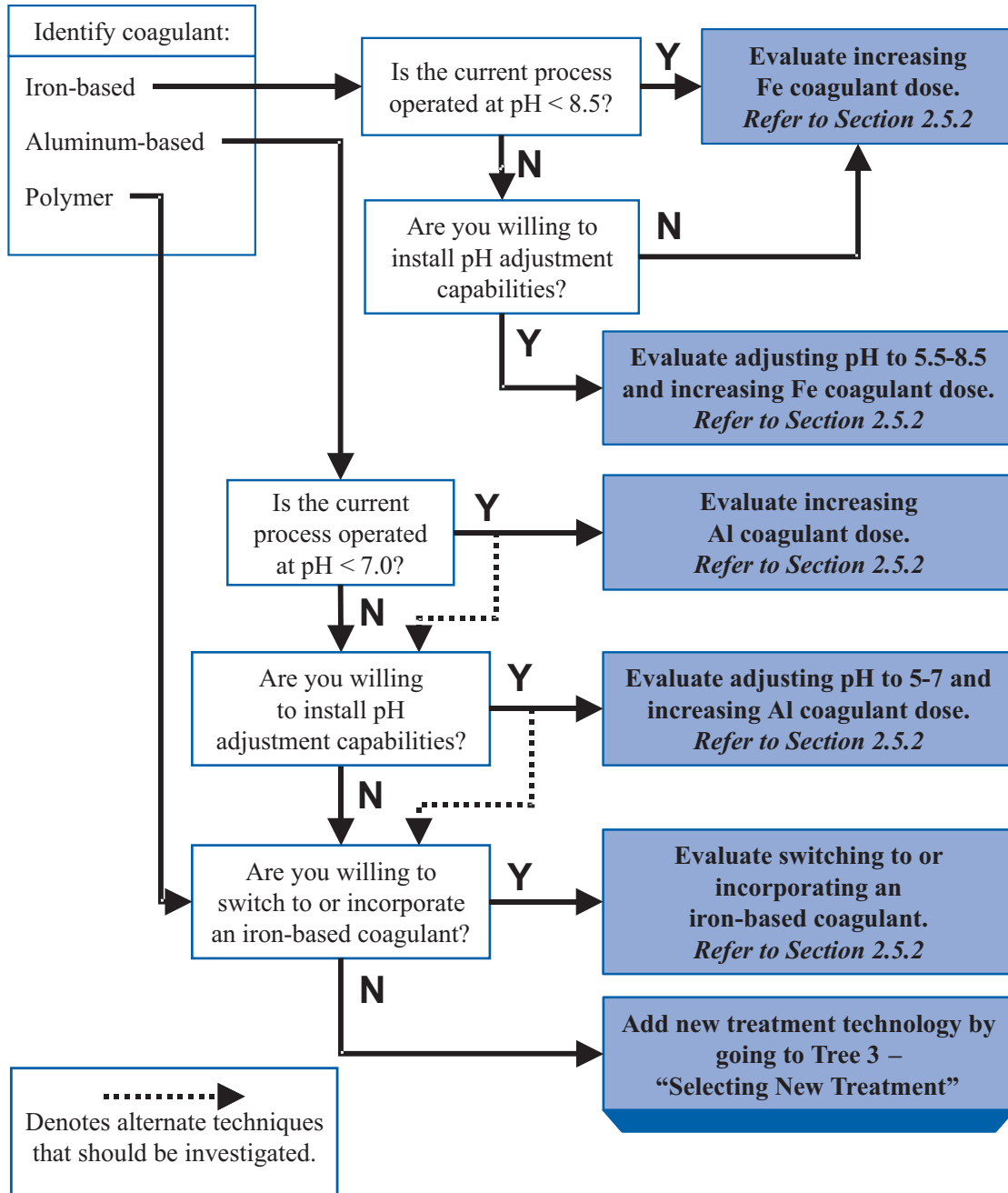

Figure 3-4. Decision Tree 2a - Enhanced Coagulation/Filtration.

Use this decision tree only after using Tree 2 “Treatment Selection.”

# Tree 2b

## Enhanced Lime Softening

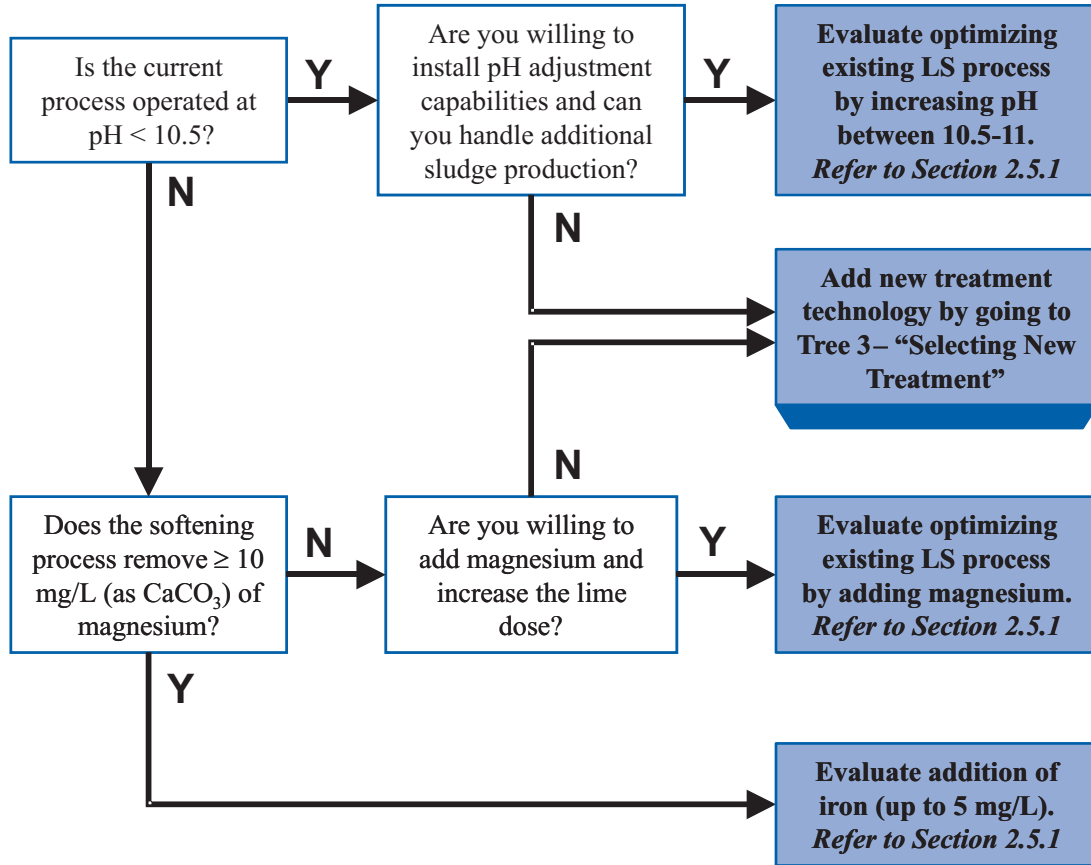

Figure 3-5. Decision Tree 2b - Enhanced Lime Softening.

Use this decision tree only after using Tree 2 "Treatment Selection."

## Tree 2c Iron & Manganese Filtration

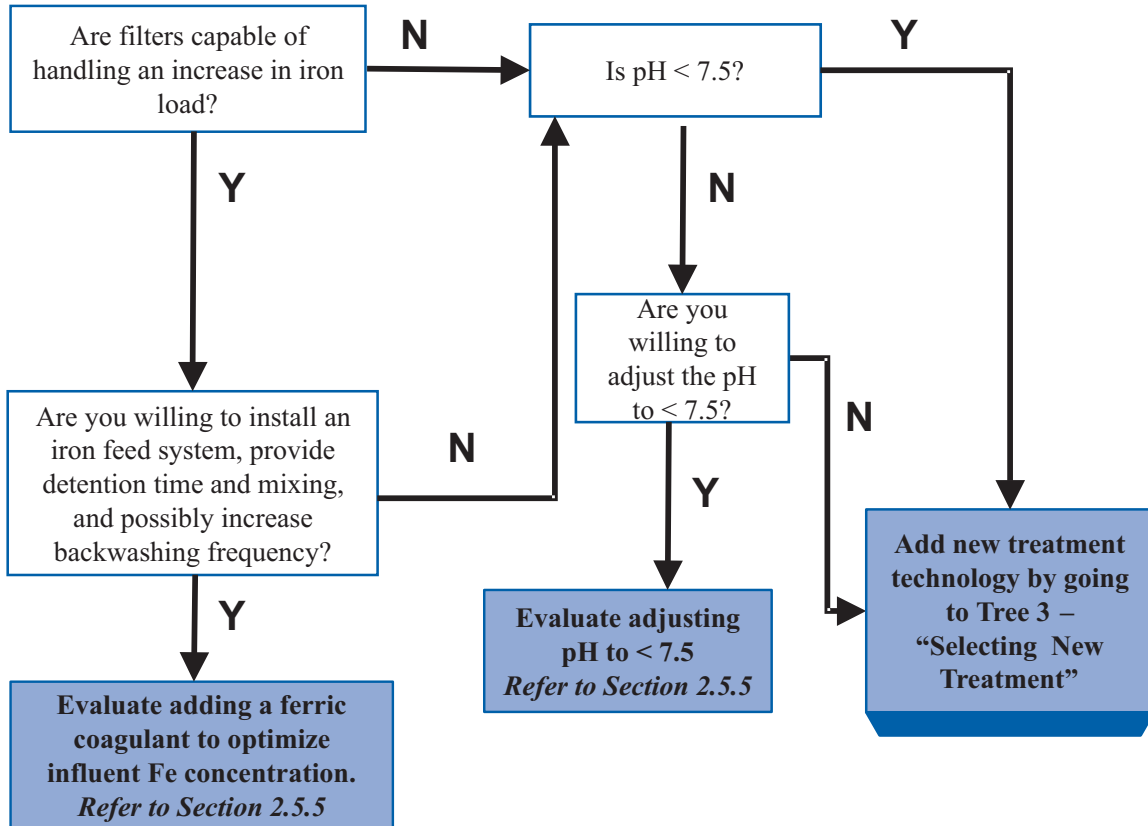

Figure 3-6. Decision Tree 2c - Iron/Manganese Filtration.

Use this decision tree only after using Tree 2 "Treatment Selection."

# Tree 3

## Selecting New Treatment

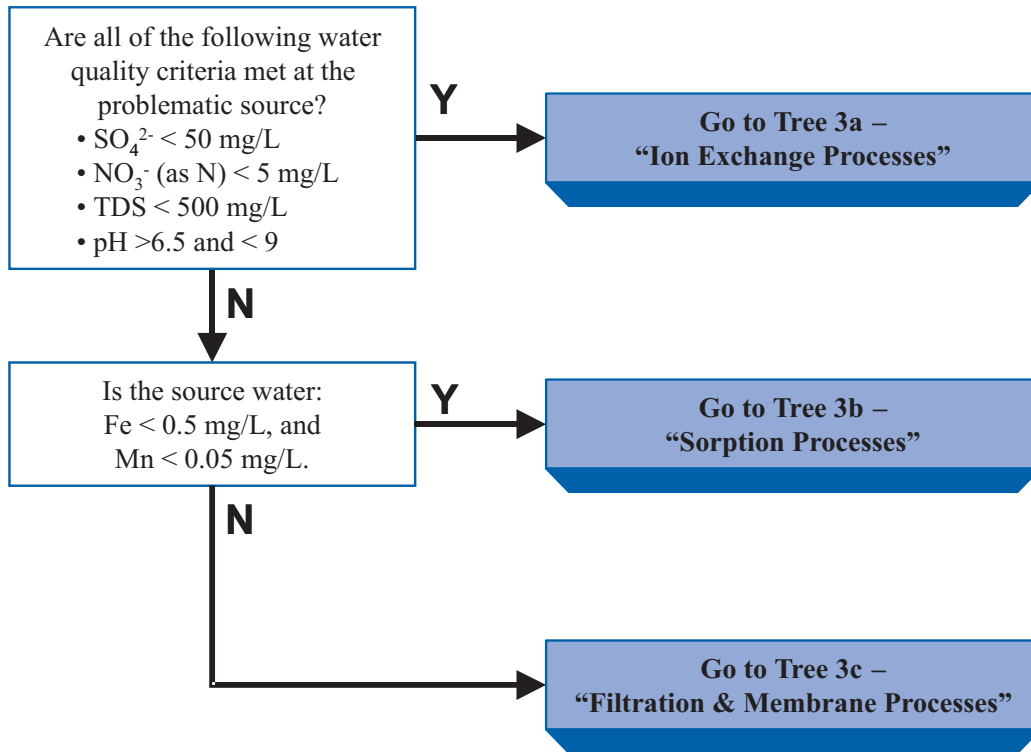
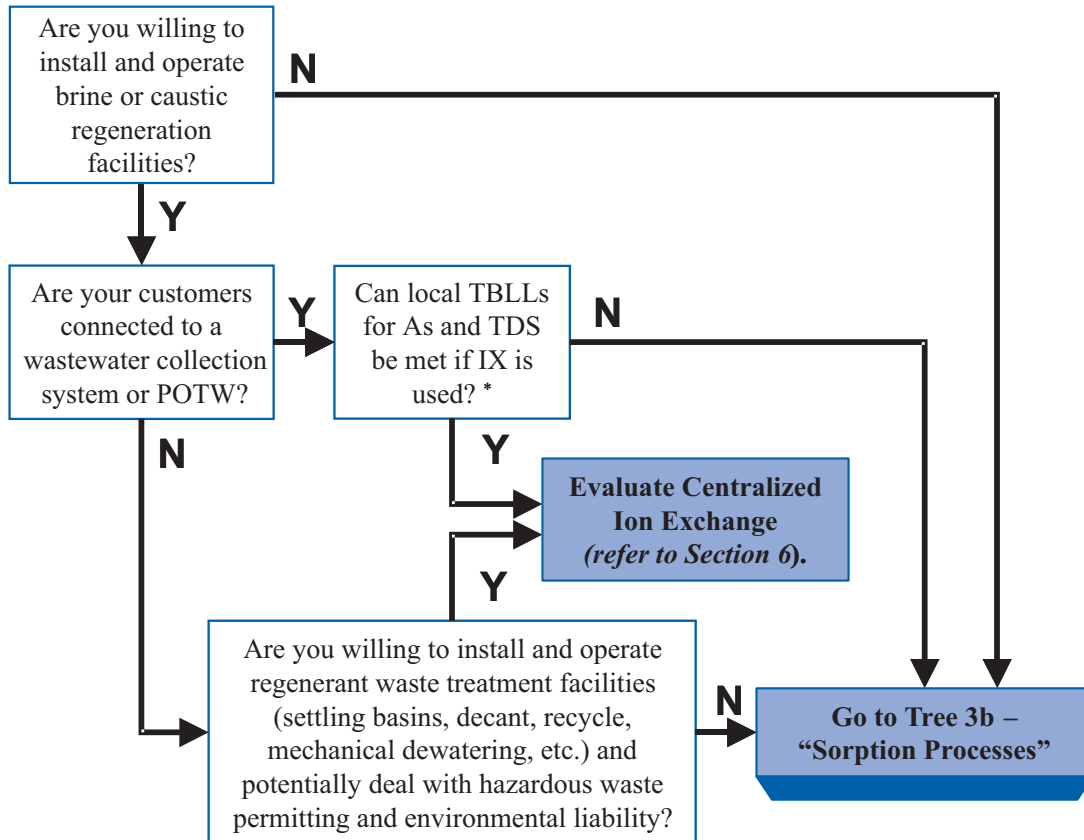

Figure 3-7. Decision Tree 3 - Selecting New Treatment.

Use this decision tree only after using Tree 2 “*Treatment Selection.*”

# Tree 3a Ion Exchange Processes



\* This evaluation will be complex because removal of As from drinking water will change the background As concentration for the TBLL. A revised TBLL would be used to determine if the brine stream could be discharged to the POTW. TDS may be the more critical restriction, especially in the western U.S.

Figure 3-8. Decision Tree 3a - Ion Exchange Processes.

Use this decision tree only after using Tree 3 “*Selecting New Treatment.*”



# Tree 3b Sorption Processes

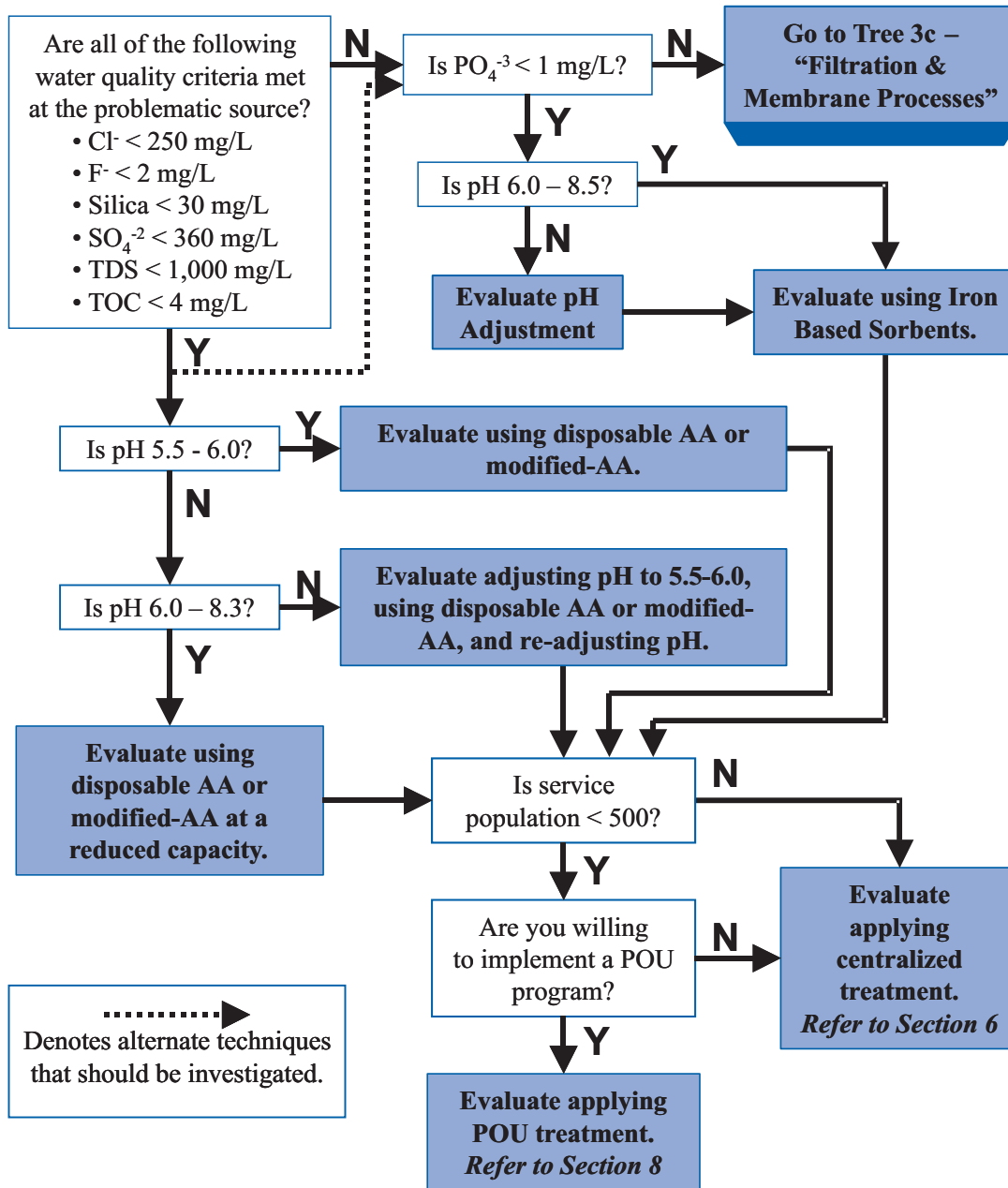

Figure 3-9. Decision Tree 3b - Sorption Processes.

Use this decision tree only after using Tree 3 “*Selecting New Treatment.*”

# Tree 3c

## Filtration & Membrane Processes

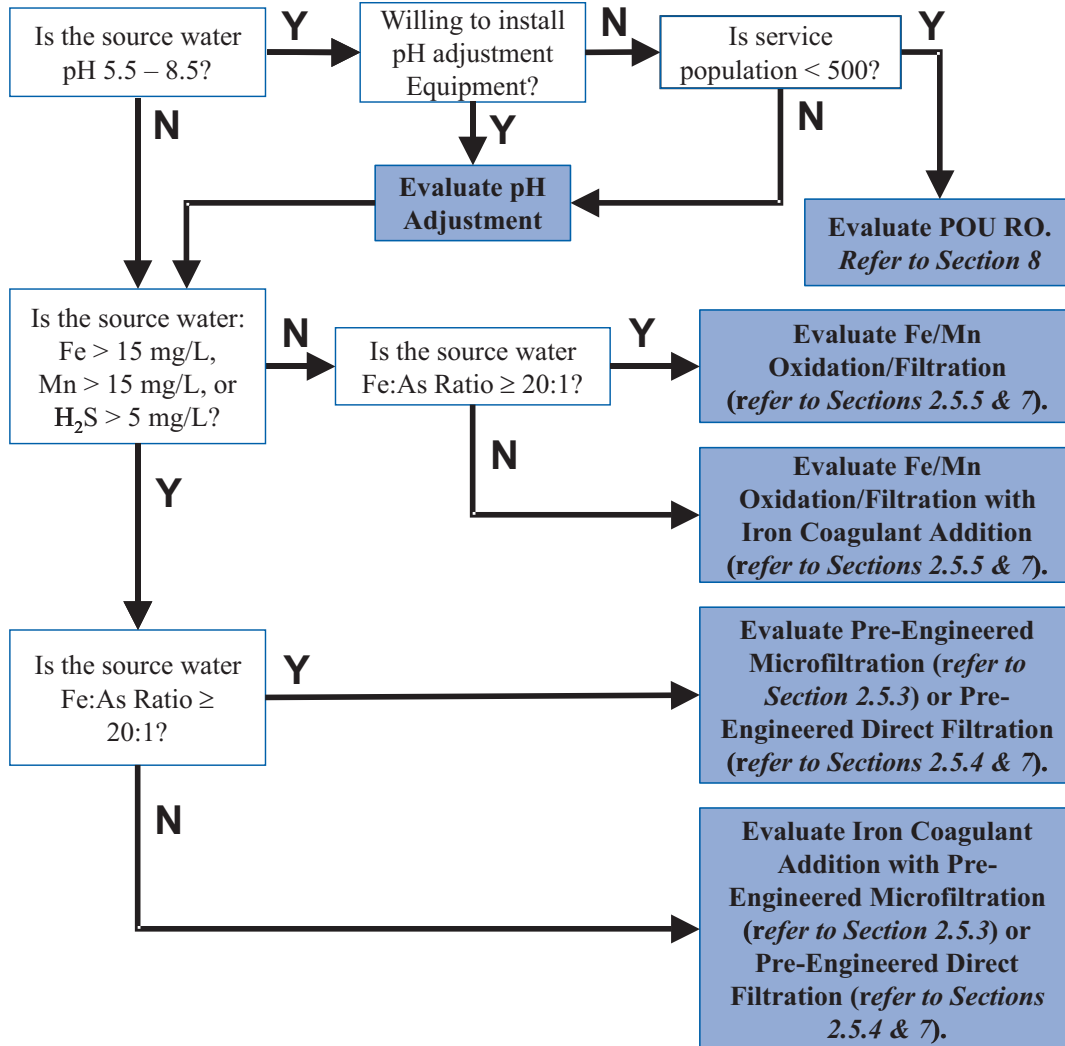

Figure 3-10. Decision Tree 3c - Filtration and Membrane Processes.

Use this decision tree only after using Tree 3 “Selecting New Treatment.”

Table 3-3 provides a summary of information about the different alternatives for arsenic mitigation found in this Handbook.

**Table 3-3. Arsenic Treatment Technologies Summary Comparison.**  
(1 of 2)

Factors	Sorption Processes			Membrane Processes
	Ion Exchange	Activated Alumina <sup>A</sup>	Iron Based Sorbents	Reverse Osmosis
	IX	AA	IBS	RO
USEPA BAT <sup>B</sup>	Yes	Yes	No <sup>C</sup>	Yes
USEPA SSCT <sup>B</sup>	Yes	Yes	No <sup>C</sup>	Yes
System Size <sup>B,D</sup>	25-10,000	25-10,000	25-10,000	501-10,000
SSCT for POU <sup>B</sup>	No	Yes	No <sup>C</sup>	Yes
POU System Size <sup>B,D</sup>	-	25-10,000	25-10,000	25 -10,000
Removal Efficiency	95% <sup>E</sup>	95% <sup>E</sup>	up to 98% <sup>E</sup>	> 95% <sup>E</sup>
Total Water Loss	1-2%	1-2%	1- 2%	15-75%
Pre-Oxidation Required <sup>F</sup>	Yes	Yes	Yes <sup>G</sup>	Likely <sup>H</sup>
Optimal Water Quality Conditions	pH 6.5 - 9 <sup>E</sup> < 5 mg/L NO <sub>3</sub> <sup>-1</sup> < 50 mg/L SO <sub>4</sub> <sup>2-1</sup> < 500 mg/L TDS <sup>K</sup> < 0.3 NTU Turbidity	pH 5.5 - 6 <sup>1</sup> pH 6 - 8.3 <sup>L</sup> < 250 mg/L Cl <sup>1</sup> < 2 mg/L F <sup>-1</sup> < 360 mg/L SO <sub>4</sub> <sup>2-K</sup> < 30 mg/L Silica <sup>M</sup> < 0.5 mg/L Fe <sup>+3 1</sup> < 0.05 mg/L Mn <sup>+2 1</sup> < 1,000 mg/L TDS <sup>K</sup> < 4 mg/L TOC <sup>K</sup> < 0.3 NTU Turbidity	pH 6 - 8.5 < 1 mg/L PO <sub>4</sub> <sup>-3 N</sup> < 0.3 NTU Turbidity	No Particulates
Operator Skill Required	High	Low <sup>A</sup>	Low	Medium
Waste Generated	Spent Resin, Spent Brine, Backwash Water	Spent Media, Backwash Water	Spent Media, Backwash Water	Reject Water
Other Considerations	Possible pre & post pH adjustment. Pre-filtration required. Potentially hazardous brine waste. Nitrate peaking. Carbonate peaking affects pH.	Possible pre & post pH adjustment. Pre-filtration may be required. Modified AA available.	Media may be very expensive. <sup>O</sup> Pre-filtration may be required.	High water loss (15-75% of feed water)
Centralized Cost	Medium	Medium	Medium	High
POU Cost	-	Medium	Medium	Medium

<sup>A</sup> Activated alumina is assumed to operate in a non-regenerated mode.

<sup>B</sup> USEPA, 2002a.

<sup>C</sup> IBS's track record in the US was not established enough to be considered as Best Available Technology (BAT) or Small System Compliance Technology (SSCT) at the time the rule was promulgated.

<sup>D</sup> Affordable for systems with the given number of people served.

<sup>E</sup> USEPA, 2000.

<sup>F</sup> Pre-oxidation only required for As(III).

<sup>G</sup> Some iron based sorbents may catalyze the As(III) to As(V) oxidation and therefore would not require a pre-oxidation step.

<sup>H</sup> RO will remove As(III), but its efficiency is not consistent and pre-oxidation will increase removal efficiency.

<sup>I</sup> AwwaRF, 2002.

<sup>J</sup> Kempic, 2002.

<sup>K</sup> Wang, 2000.

<sup>L</sup> AA can be used economically at higher pHs, but with a significant decrease in the capacity of the media.

<sup>M</sup> Clifford, 2001.

<sup>N</sup> Tumalo, 2002.

<sup>O</sup> With increased domestic use, IBS cost will significantly decrease.

**Table 3-3. Arsenic Treatment Technologies Summary Comparison.  
(2 of 2)**

Factors	Precipitative Processes				
	Enhanced Lime Softening	Enhanced (Conventional) Coagulation Filtration	Coagulation-Assisted Micro-Filtration	Coagulation-Assisted Direct Filtration	Oxidation Filtration
	LS	CF	CMF	CADF	OxFilt
USEPA BAT <sup>B</sup>	Yes	Yes	No	Yes	Yes
USEPA SSCT <sup>B</sup>	No	No	Yes	Yes	Yes
System Size <sup>B,D</sup>	25-10,000	25-10,000	500-10,000	500-10,000	25-10,000
SSCT for POU <sup>B</sup>	No	No	No	No	No
POU System Size <sup>B,D</sup>	-	-	-	-	-
Removal Efficiency	90% <sup>E</sup>	95% (w/ FeCl <sub>3</sub> ) <sup>E</sup> < 90% (w/ Alum) <sup>E</sup>	90% <sup>E</sup>	90% <sup>E</sup>	50-90% <sup>E</sup>
Total Water Loss	0%	0%	5%	1-2%	1-2%
Pre-Oxidation Required <sup>F</sup>	Yes	Yes	Yes	Yes	Yes
Optimal Water Quality Conditions	pH 10.5 - 11 <sup>1</sup> > 5 mg/L Fe <sup>+3</sup> <sup>1</sup>	pH 5.5 - 8.5 <sup>P</sup>	pH 5.5 - 8.5 <sup>P</sup>	pH 5.5 - 8.5 <sup>P</sup>	pH 5.5 - 8.5 >0.3 mg/L Fe Fe:As Ratio > 20:1
Operator Skill Required	High	High	High	High	Medium
Waste Generated	Backwash Water, Sludge (high volume)	Backwash Water, Sludge	Backwash Water, Sludge	Backwash Water, Sludge	Backwash Water, Sludge
Other Considerations	Treated water requires pH adjustment.	Possible pre & post pH adjustment.	Possible pre & post pH adjustment.	Possible pre & post pH adjustment.	None.
Centralized Cost	Low <sup>Q</sup>	Low <sup>Q</sup>	High	Medium	Medium
POU Cost	N/A	N/A	N/A	N/A	N/A

<sup>B</sup> USEPA, 2002a.

<sup>D</sup> Affordable for systems with the given number of people served.

<sup>E</sup> Depends on arsenic and iron concentrations.

<sup>F</sup> Pre-oxidation only required for As(III).

<sup>1</sup> AwwaRF, 2002.

<sup>P</sup> Fields, et al, 2002a.

<sup>Q</sup> Costs for enhanced LS and enhanced CF are based on modification of an existing technology. Most small systems will not have this technology in place.

## Section 4

# Planning-Level Treatment Costs

---

This section presents information the utility can use to calculate planning-level capital and O&M costs for the treatment method selected in Section 3. All the charts are from *Technologies and Costs for Removal of Arsenic from Drinking Water* (USEPA, 2000). This information will give the utility only a rough estimate of the selected treatment process costs so that relative costs can be evaluated. If the costs are too high, the utility is encouraged to re-evaluate the criteria used in the treatment selection process in Section 3.

**It is critical that the utility employ the decision trees in Section 3, rather than the cost correlation curves provided in this section, as the primary tool for selecting an arsenic mitigation strategy.** The trees take into account system-specific conditions and utility preferences. Comparing planning-level costs without consideration of the technical issues incorporated in the decision trees may lead the utility to an inappropriate technology.

The cost curves incorporate different mathematical models for different sized systems. Because of this, there are step changes between the model outputs in some of the charts. If the system being sized falls at a flowrate that lays on one of these step changes, the utility is encouraged to use an average cost number and then perform a more site specific cost evaluation.

Capital cost charts are based on the maximum flowrate for which the facility was designed (i.e., design flowrate). The design flowrate should be higher than the treated flowrate determined in Section 3. The capital costs include: process costs (including manufactured equipment, concrete, steel, electrical and instrumentation, and pipe and valves), construction costs (including site-work and excavation, subsurface considerations, standby power, contingencies, and interest during construction), engineering costs (including general contractor overhead and profit, engineering fees, and legal, fiscal, and administrative fees) and the costs associated with retrofitting, permitting, pilot testing, housing, and system redundancy (where prudent). The capital costs do not include costs associated with additional contaminants or land.

The O&M costs are based on the average flowrate that the facility is expected to treat. The O&M costs are based on the following assumptions:

- Electricity costs of \$0.08/kWh,
- Diesel fuel costs of \$1.25/gallon,
- Natural gas costs of \$0.006/scf,
- Large systems labor costs of \$40/h (or loaded labor costs of \$52/h),
- Loaded labor costs for small systems of \$28/h, and
- Building energy use of 102.6 kWh/sft/y.

All of the costs presented in the charts are given in year 1998 dollars. To escalate the capital cost of a technology from 1998 to the present, construction cost indexes (CCI) published by Engineering News Record (ENR) can be used in the following formula.

$$P_{\text{Current}} = P_{1998} \left( \frac{\text{CCI}_{\text{Current}}}{\text{CCI}_{1998}} \right) \quad \text{Eqn. 4-1}$$

Where:

- $P_{\text{Current}}$  = Present Cost,
- $P_{1998}$  = Year 1998 Cost (from the charts),
- $\text{CCI}_{\text{Current}}$  = Construction Cost Index Value for the current year, and
- $\text{CCI}_{1998}$  = Construction Cost Index Value for 1998.

For example, a greensand filtration system is designed to handle 1 MGD. Values taken from the figures and their equations are:

- 1998 Capital Cost is \$587,584 (Figure 4-21)
- 1998 Waste Disposal Capital Cost is \$3,955 (Figure 4-23)

The annual average 20-cities ENR CCI for 1998 and for November 2002 are 5,920.44 and 6,578.03, respectively. Therefore, the total capital cost for this facility can be estimated for the year 2002 using Equation 4-1 as follows:

$$P_{\text{Capital, 2002}} = (\$587,584 + \$3,955) \left( \frac{6,578.03}{5,920.44} \right) = \$657,242$$

The O&M costs presented in the Handbook are 1998 costs and can be escalated to the current year's costs using the formula below. This formula can also be used in place of the CCI equation, although it is less accurate.

$$P_{\text{Current}} = P_{1998} (1 + i)^{(Y_{\text{Current}} - 1998)} \quad \text{Eqn. 4-2}$$

Where:

- $P_{\text{Current}}$  = Current Cost,
- $P_{1998}$  = Year 1998 Cost (from the charts),
- $i$  = Annual rate of inflation (currently ~ 2.5% - 3%), and
- $Y_{\text{Current}}$  = Current Year.

Using the same example of a 1 MGD greensand filtration system, the values taken from the figures and their equations are:

- 1998 O&M cost is \$66,314/y (Figure 4-22)
- 1998 Waste Disposal O&M cost is \$8,678/y (Figure 4-24)

Assuming an annual inflation rate of 2.5%, the O&M can be estimated for the year 2002 using Equation 4-2 as follows:

$$P_{O\&M,2002} = (\$66,314 + \$8,678)(1 + 0.025)^{(2002-1998)} = \$82,777$$

Additionally, the USEPA has a cost model for estimating the costs of processes using sorptive media. This cost model, titled *Cost Estimating Program for Arsenic Removal by Small Drinking Water Facilities*, can be found on the USEPA's website.

#### 4.1 Pre-Oxidation System Costs Using Chlorine

Costs presented in the following charts make the following assumptions:

- A new chlorination system is installed.
- A dose of 1.5 mg/L of free chlorine is added to the treated flow.
- Systems use 15% sodium hypochlorite feed stock and are designed to handle dosages as high as 10 mg/L.

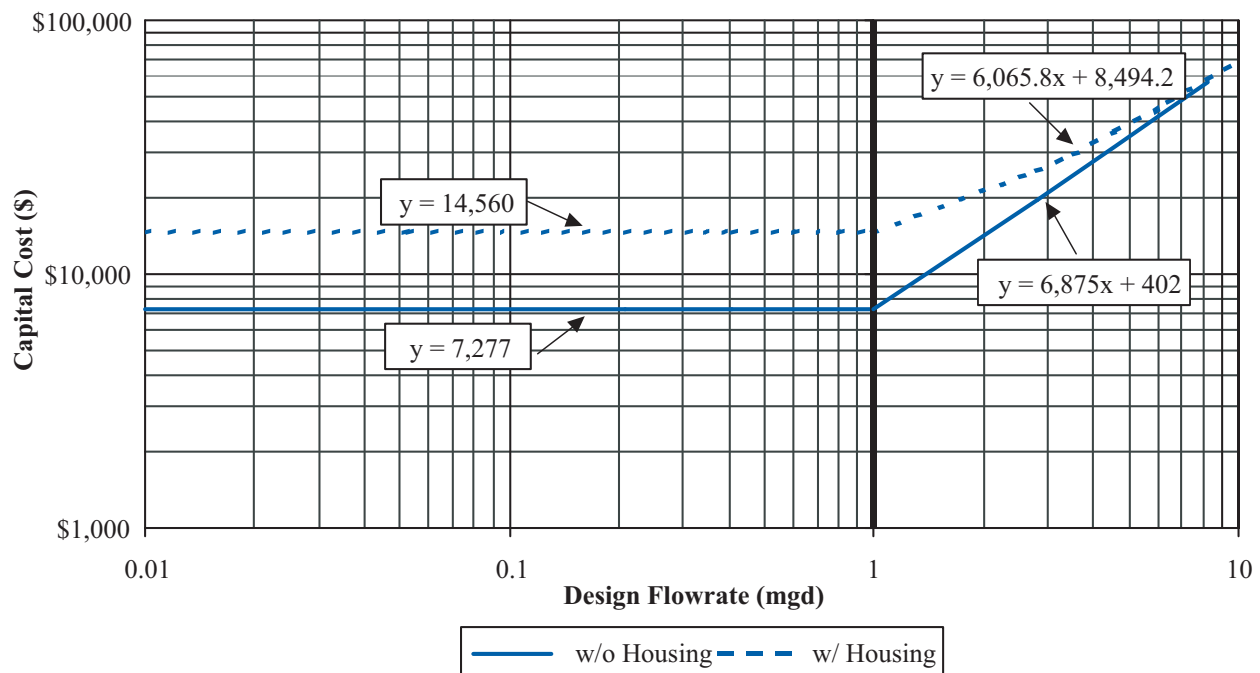

Figure 4-1. Chlorination Capital Costs.

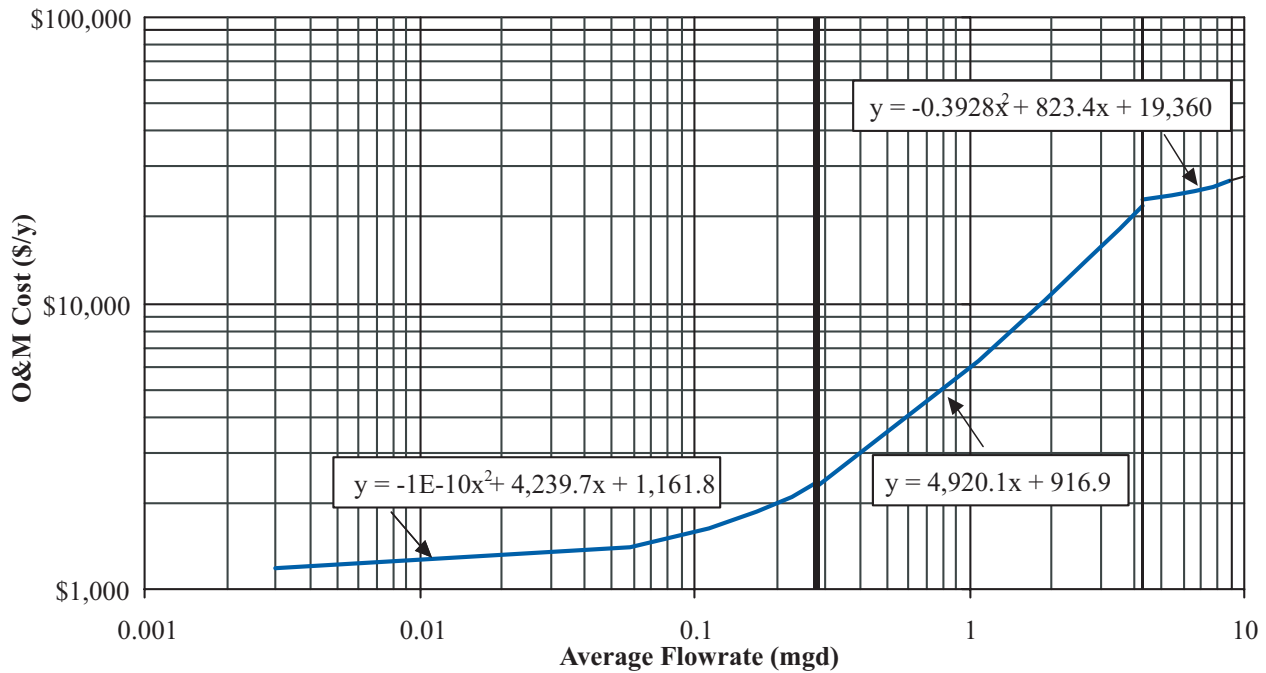

Figure 4-2. Chlorination O&M Costs.

## 4.2 Ion Exchange System Costs

Costs presented in the following charts make the following assumptions:

- A new IX system is installed.
- Capital Cost Design Assumptions:
  - Pre-oxidation is required but not included in these costs.
  - Cost includes a redundant column to allow the system to operate during regeneration.
- O&M Cost Design Assumptions:
  - Run length when sulfate is at or below 20 mg/L is 1500 bed volumes (BV).
  - Run length when the sulfate is between 20 and 50 mg/L is 700 BV.
  - Labor rate for small systems is \$28/hour. The loaded labor rate for large systems is \$52/hour.
- Waste is discharged to a POTW (i.e., indirect discharge).



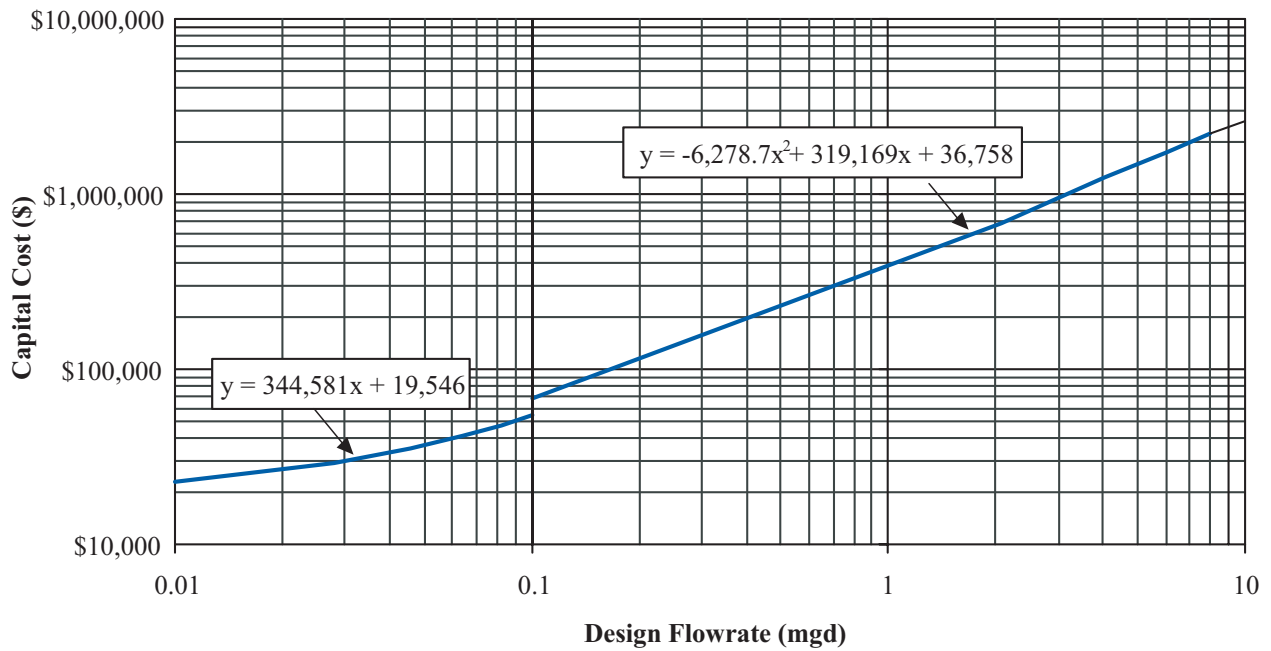

Figure 4-3. Ion Exchange (<20 mg/L SO<sub>4</sub><sup>2-</sup>) Capital Costs.

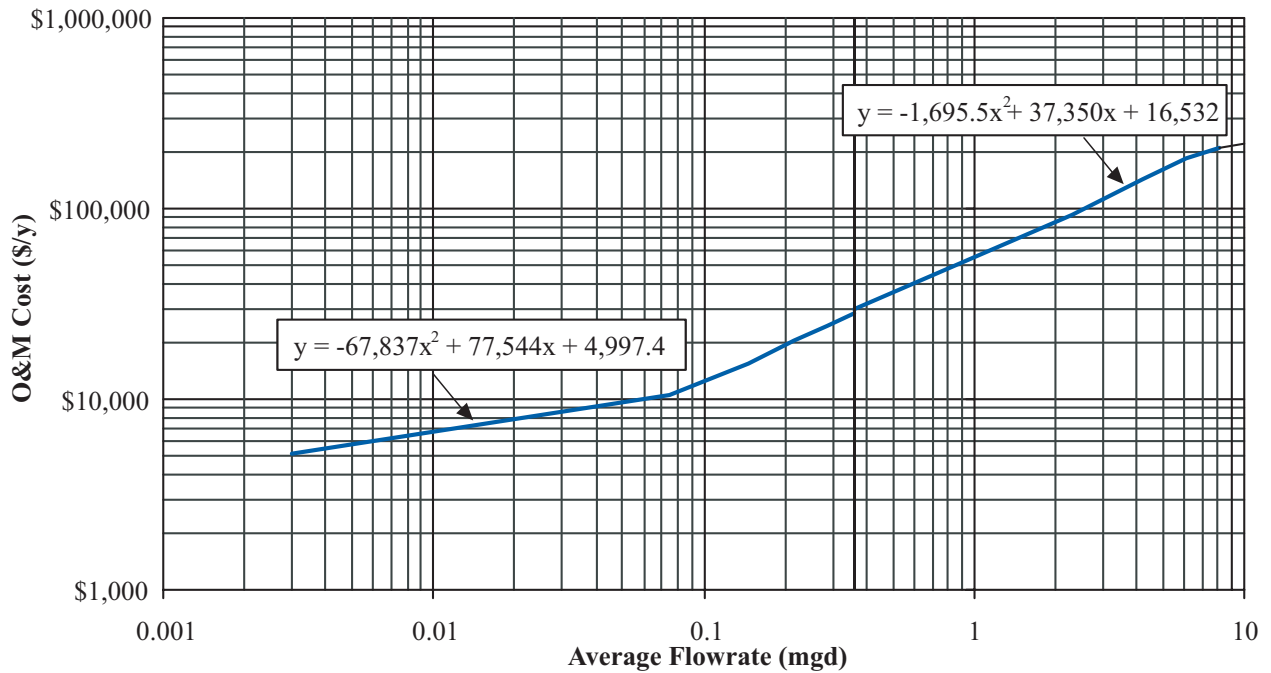

Figure 4-4. Ion Exchange (<20 mg/L SO<sub>4</sub><sup>2-</sup>) O&M Costs.

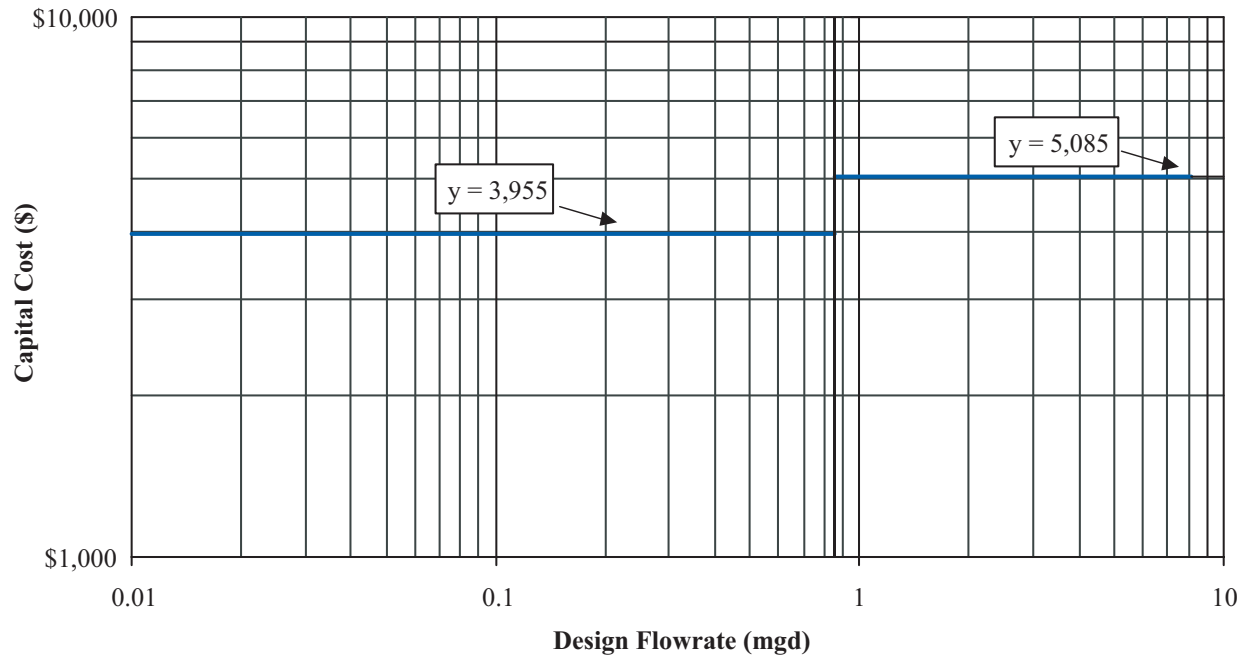

Figure 4-5. Ion Exchange (<20 mg/L SO<sub>4</sub><sup>2-</sup>) Waste Disposal Capital Costs.

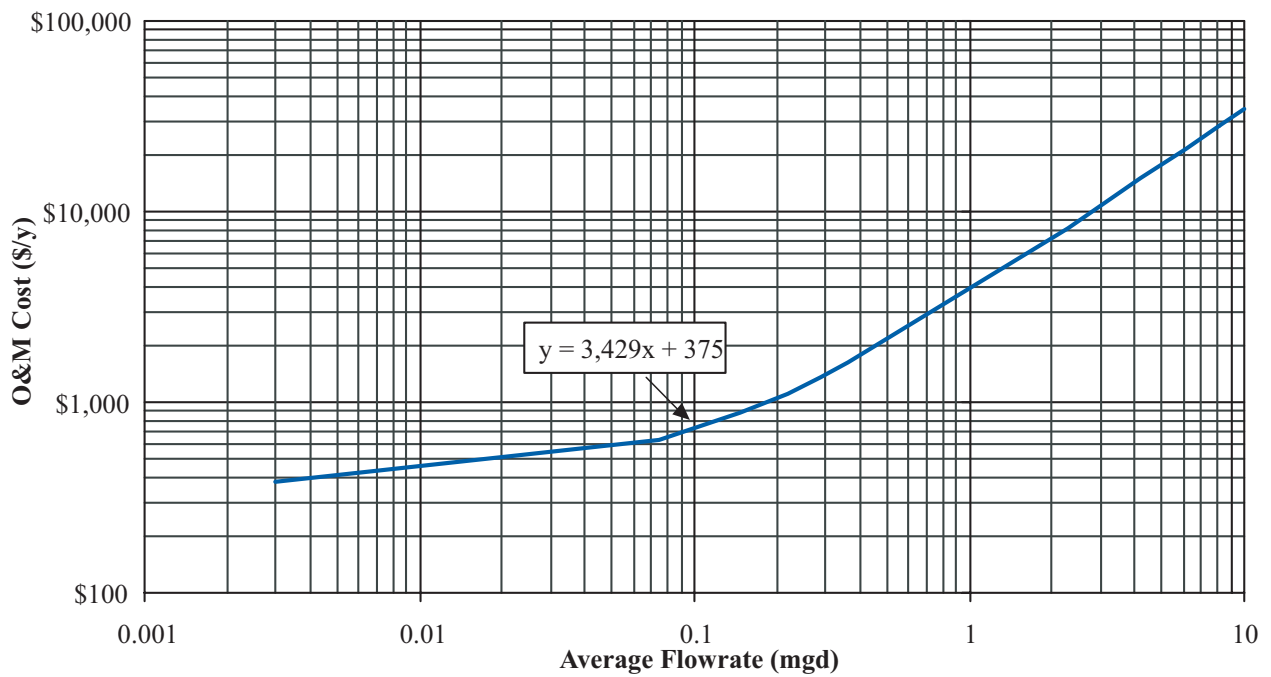

Figure 4-6. Ion Exchange (<20 mg/L SO<sub>4</sub><sup>2-</sup>) Waste Disposal O&M Costs.

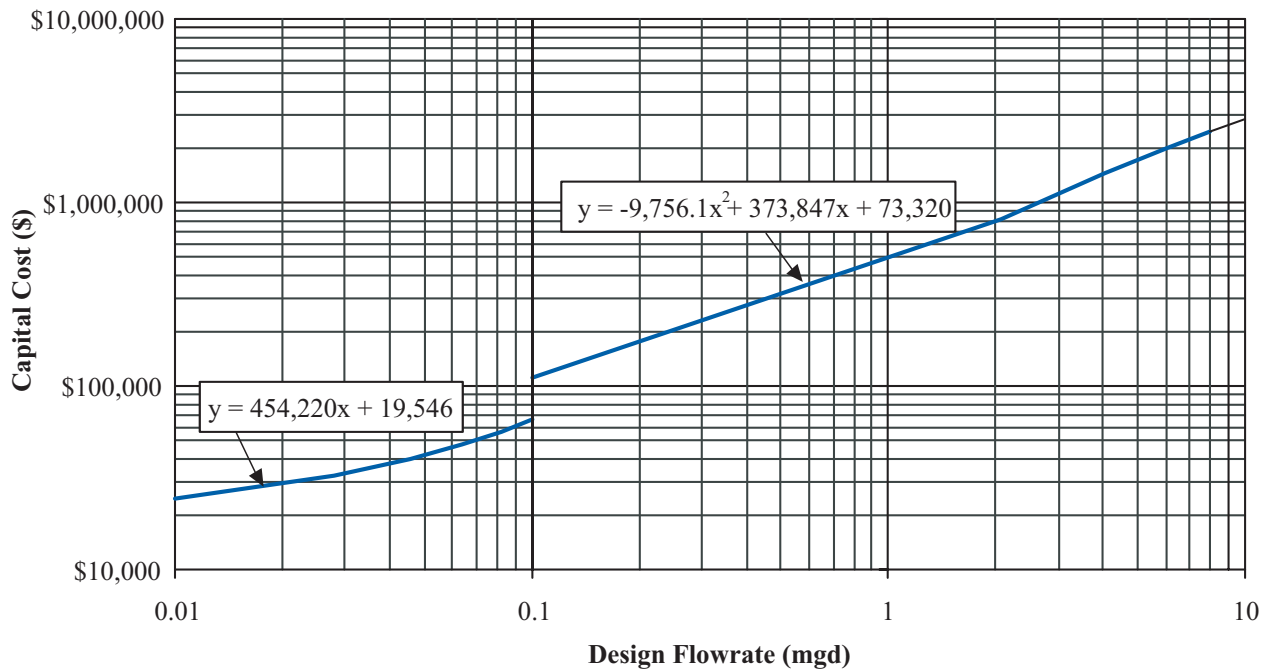

Figure 4-7. Ion Exchange (20-50 mg/L  $\text{SO}_4^{2-}$ ) Capital Costs.

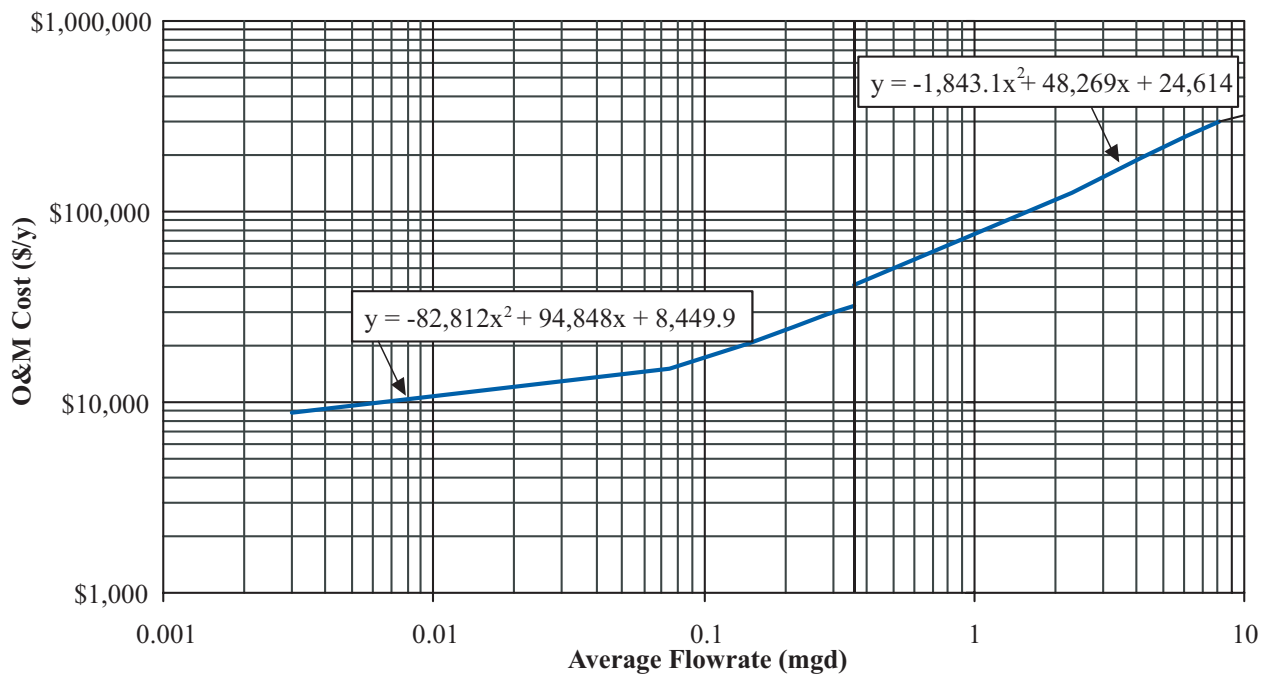

Figure 4-8. Ion Exchange (20-50 mg/L  $\text{SO}_4^{2-}$ ) O&M Costs.

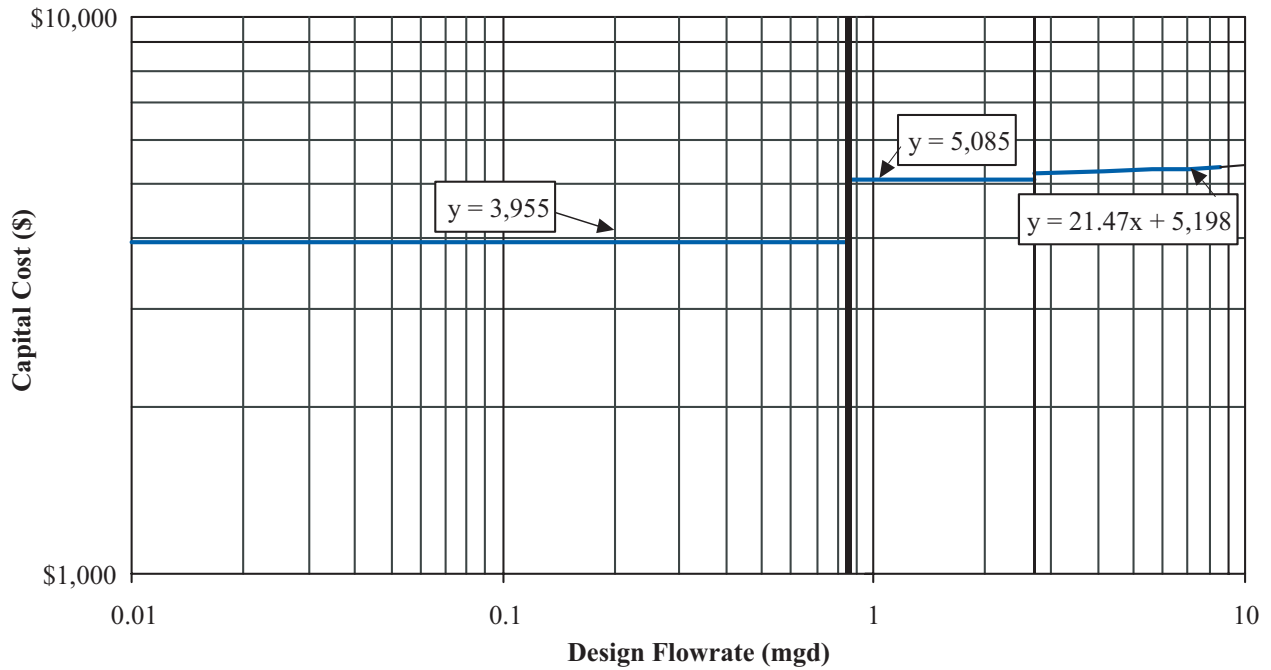

Figure 4-9. Ion Exchange (20-50 mg/L  $\text{SO}_4^{2-}$ ) Waste Disposal Capital Costs.

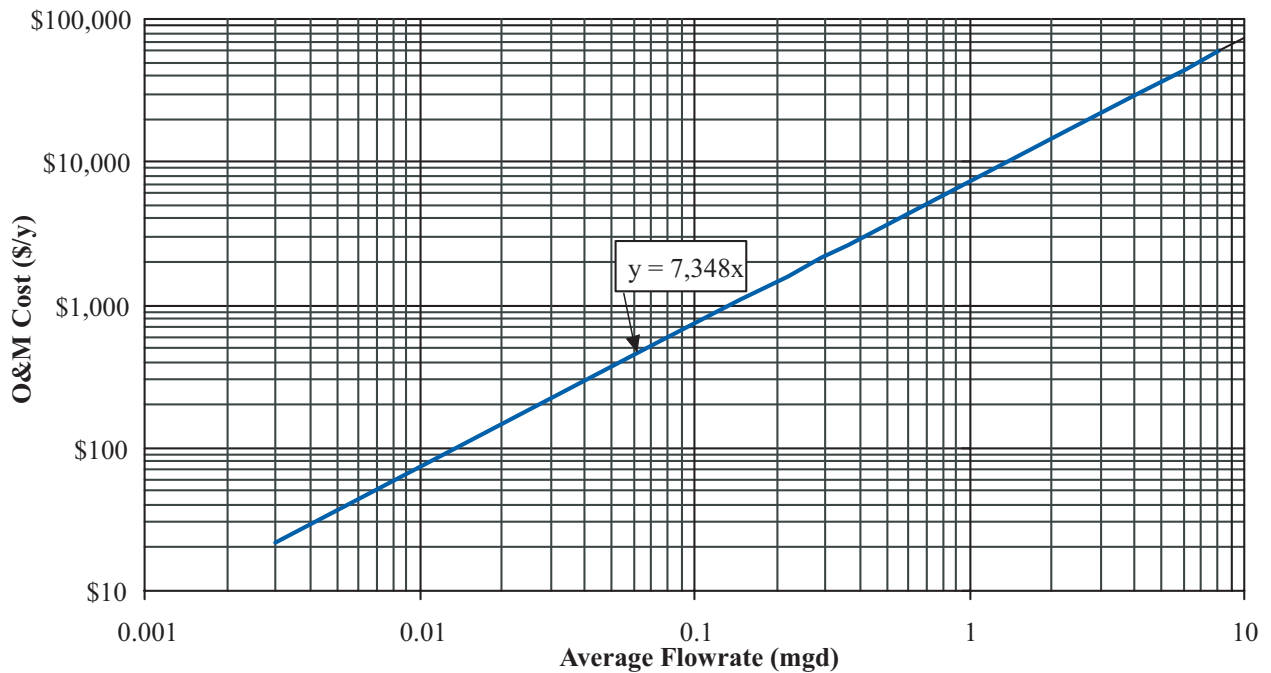

Figure 4-10. Ion Exchange (20-50 mg/L  $\text{SO}_4^{2-}$ ) Waste Disposal O&M Costs.

### 4.3 Activated Alumina System Costs

Costs presented in the following charts make the following assumptions:

- A new AA system is installed.
- AA media is disposed of in a non-hazardous landfill rather than regenerated.
- Four treatment modes are assumed:
  - No pH adjustment, Natural pH of 7-8, run length is 10,000 BV.
  - No pH adjustment, Natural pH of 8-8.3, run length is 5,200 BV.
  - pH adjusted to 6.0 using hydrochloric acid, run length is 23,100 BV.
  - pH adjusted to 6.0 using sulfuric acid, columns are good for 15,400 BV.
- Capital Cost Design Assumptions:
  - Redundant column included for operation during media replacement.
  - Costs for constructing housing for the equipment are included.
  - Capital costs include both pre- and post-treatment pH adjustment if pH adjustment is used.
- O&M Cost Design Assumptions:
  - Power costs are \$0.08/kwh.
  - pH adjustment costs are included.
  - Labor rate for small systems is \$28/hour. The loaded labor rate for large systems is \$52/hour.

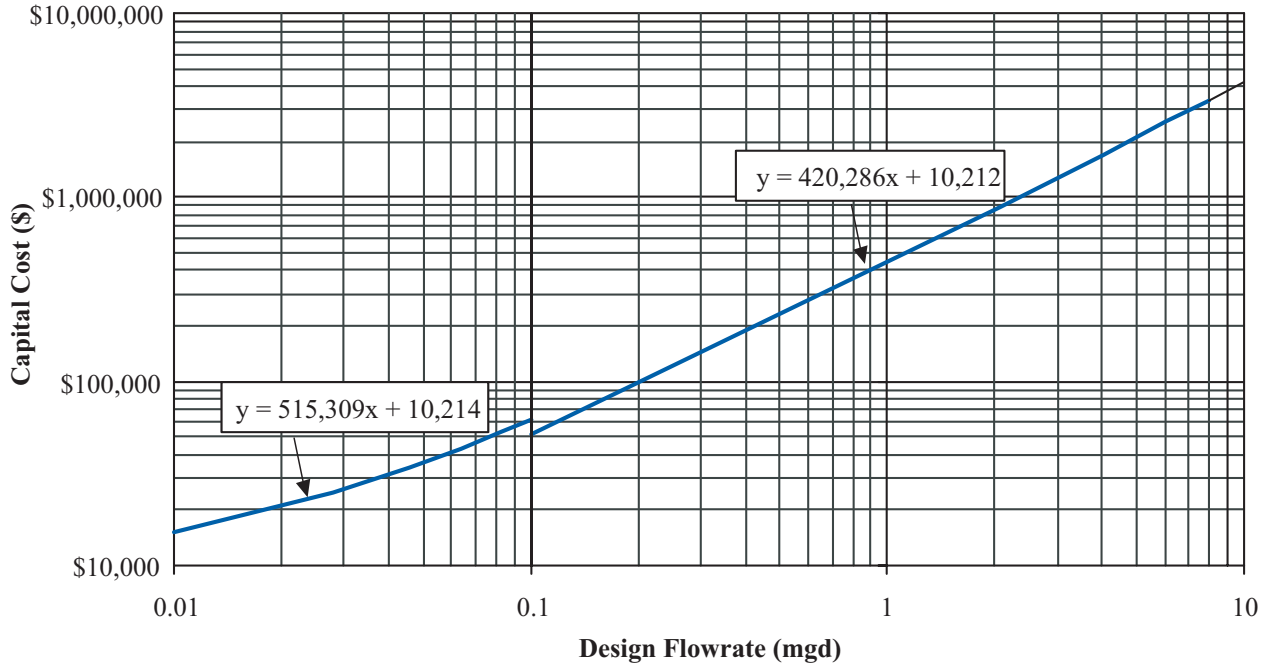

Figure 4-11. Activated Alumina (Natural pH) Capital Costs.

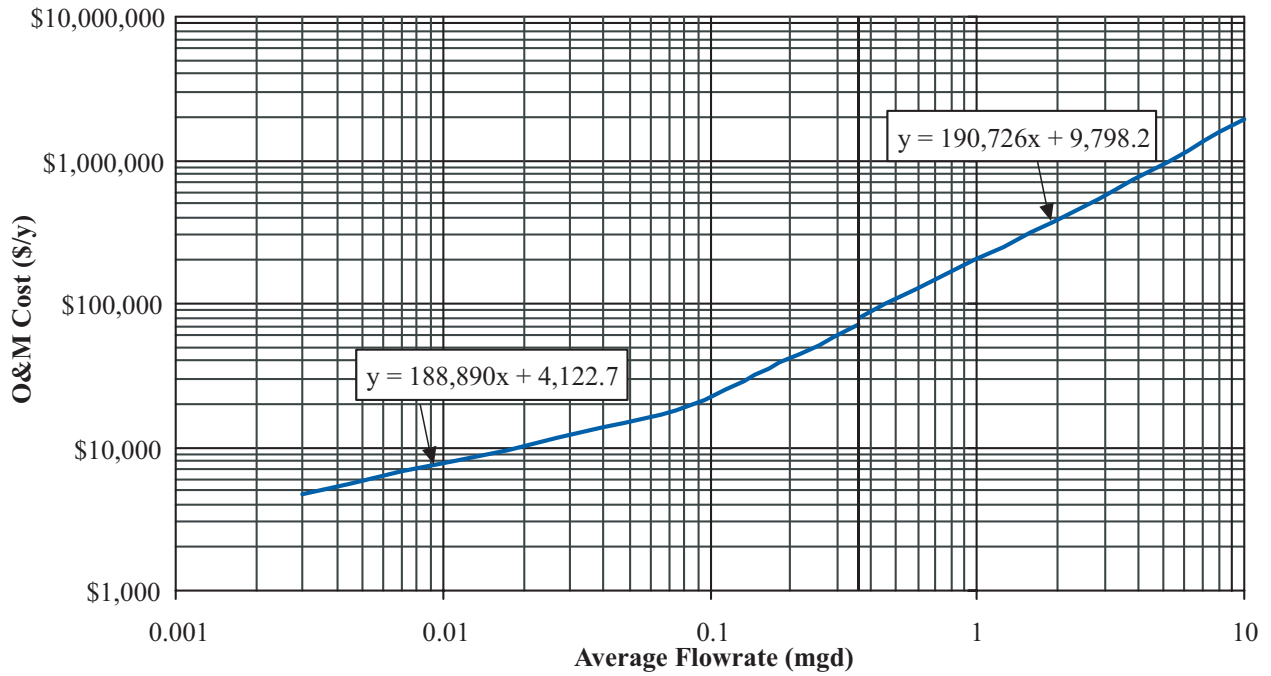

Figure 4-12. Activated Alumina (Natural pH of 7-8) O&M Costs.

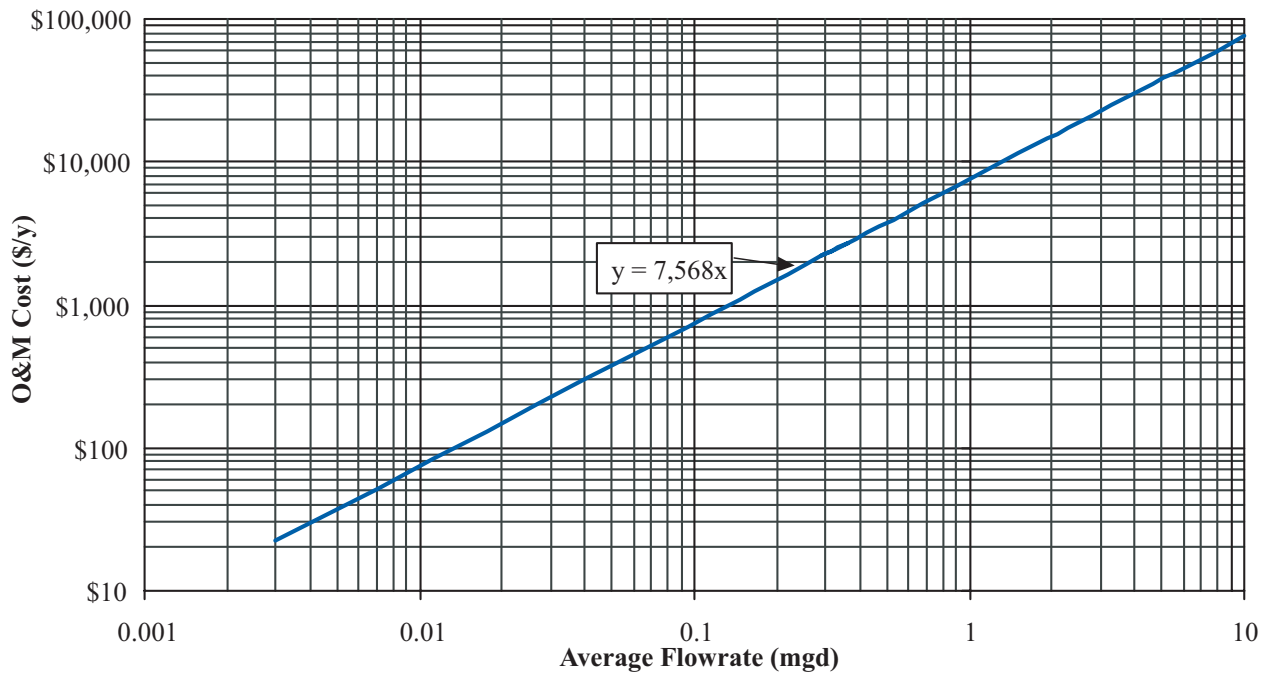

Figure 4-13. Activated Alumina (Natural pH of 7-8) Waste Disposal O&M Costs.

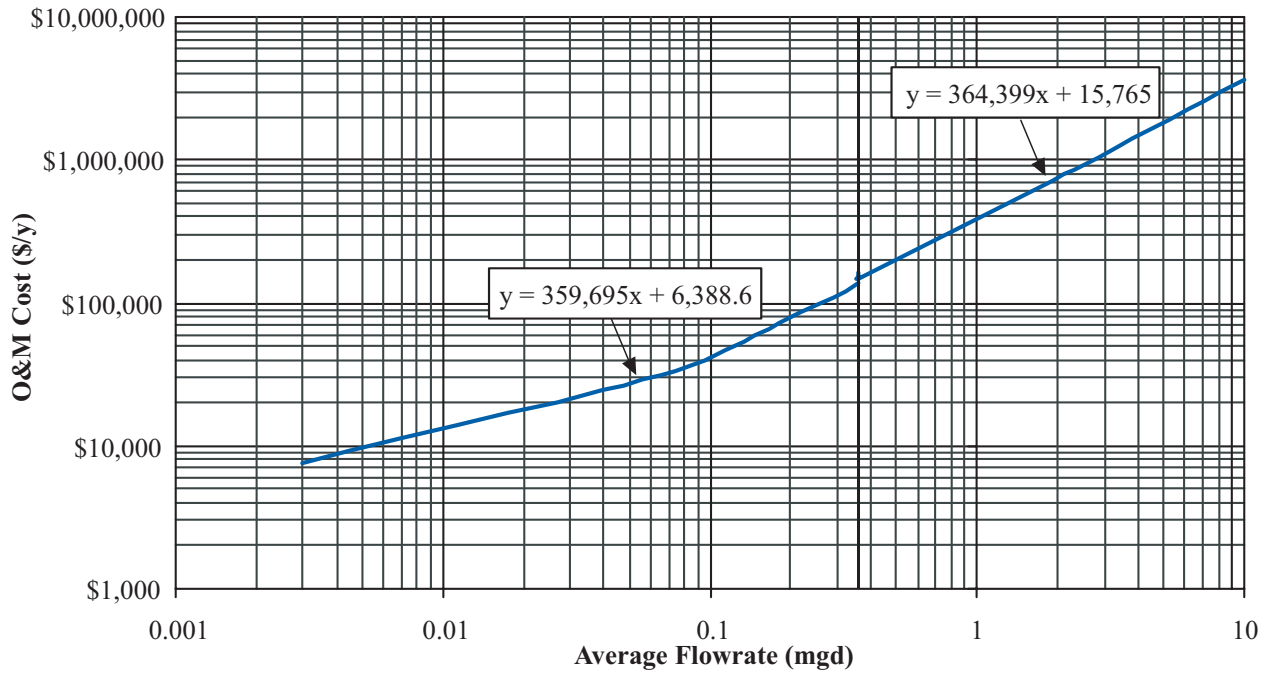

Figure 4-14. Activated Alumina (Natural pH of 8-8.3) O&M Costs.

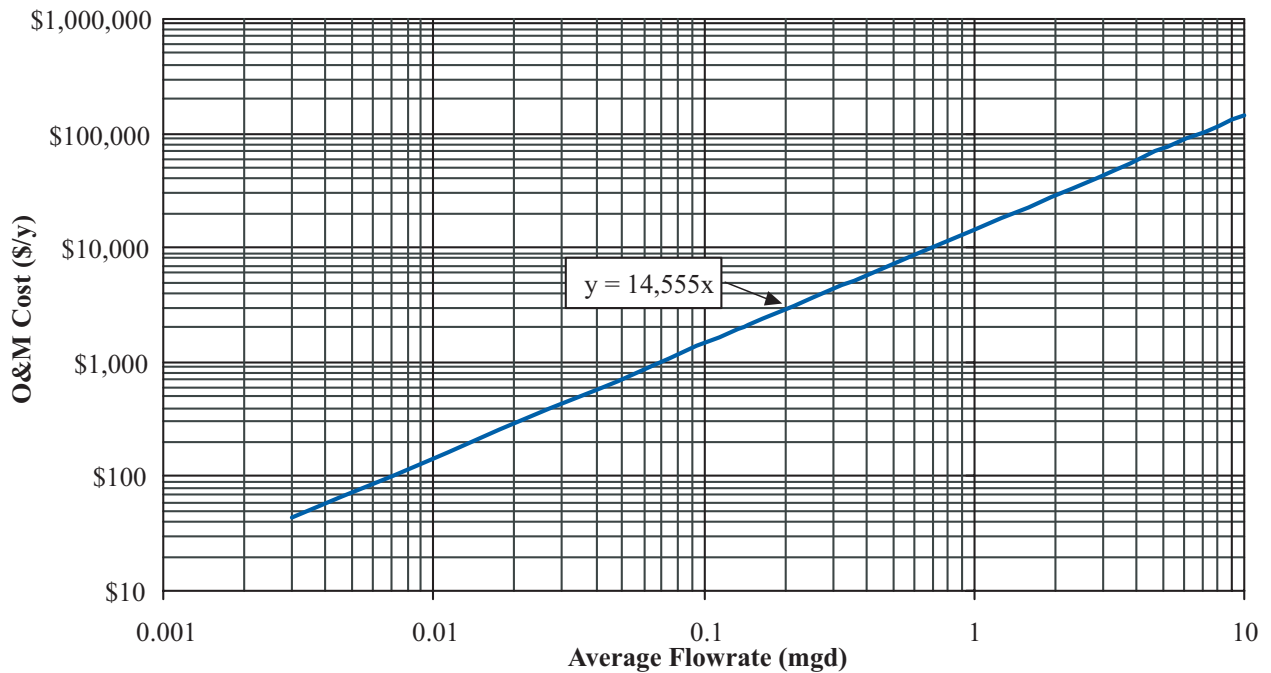

Figure 4-15. Activated Alumina (Natural pH of 8.0-8.3) Waste Disposal O&M Costs.

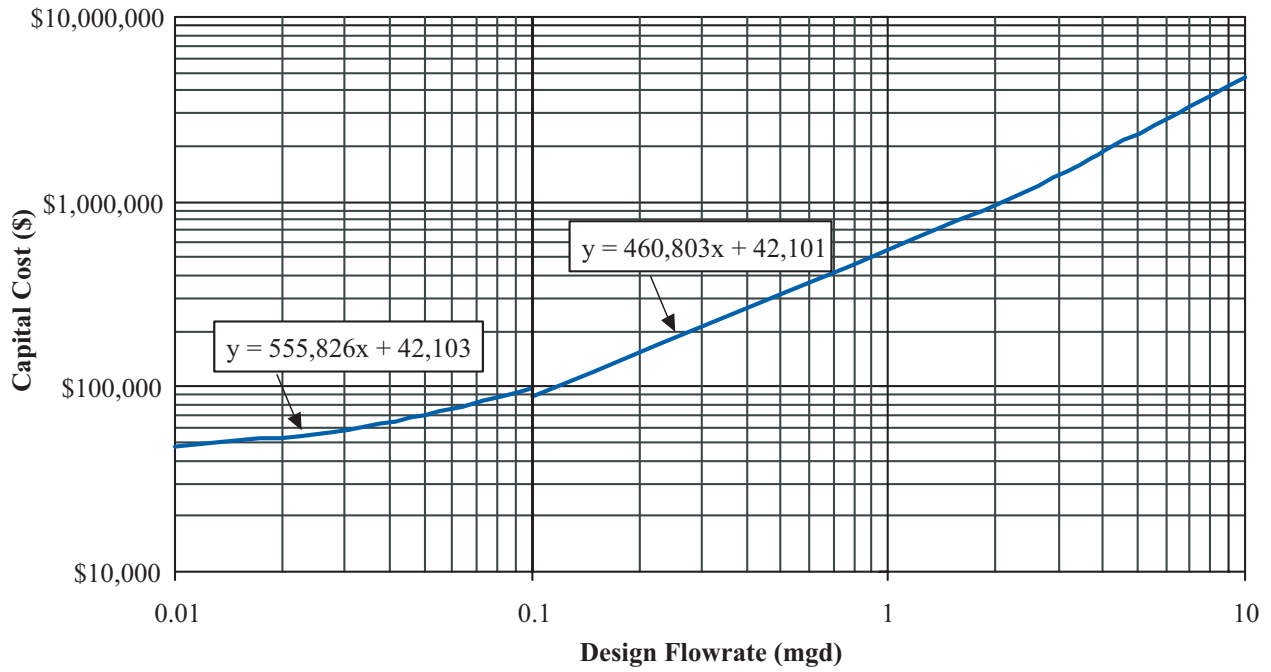

Figure 4-16. Activated Alumina (pH Adjusted to 6.0) Capital Costs.

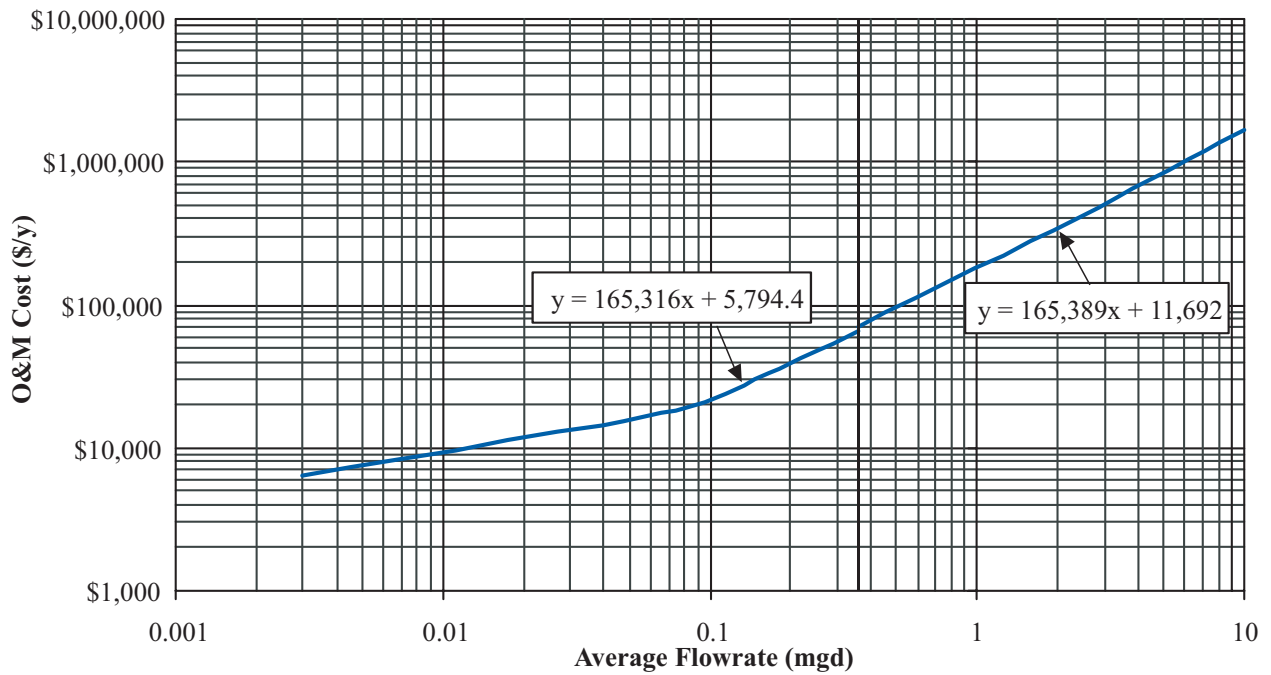

Figure 4-17. Activated Alumina (pH adjusted to 6.0 - 23,100 BV) O&M Costs.



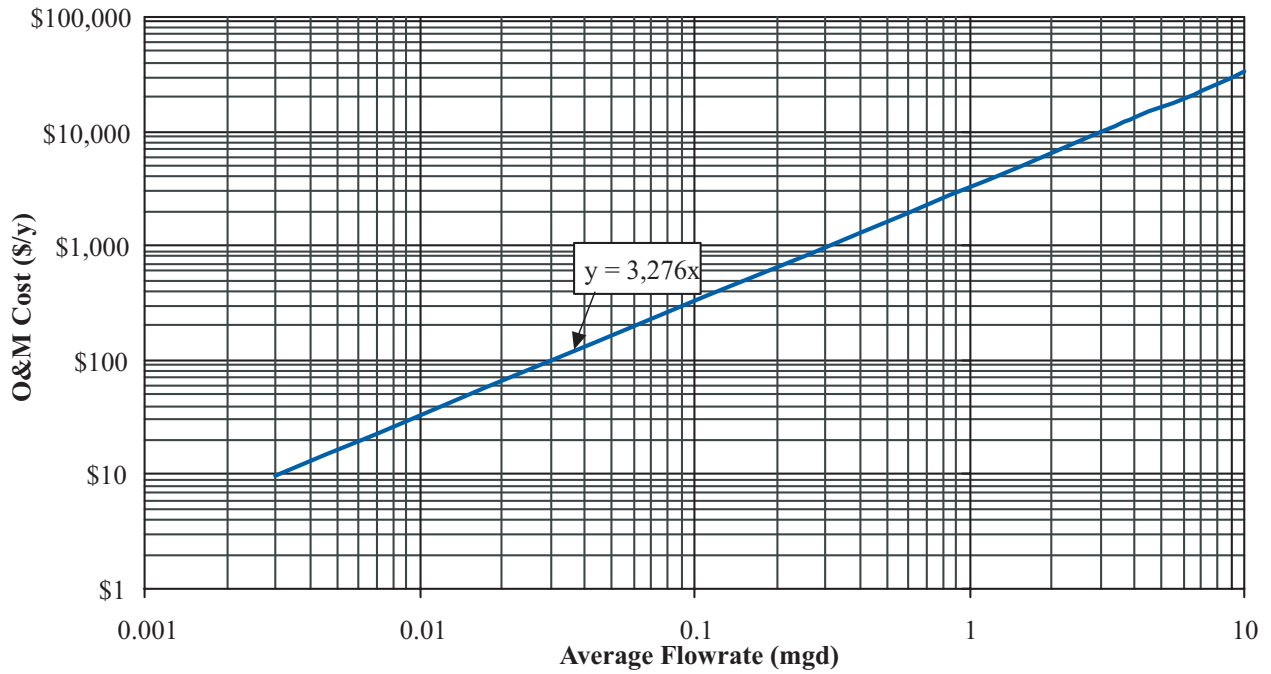

Figure 4-18. Activated Alumina (pH adjusted to 6.0 - 23,100 BV) Waste Disposal O&M Costs.

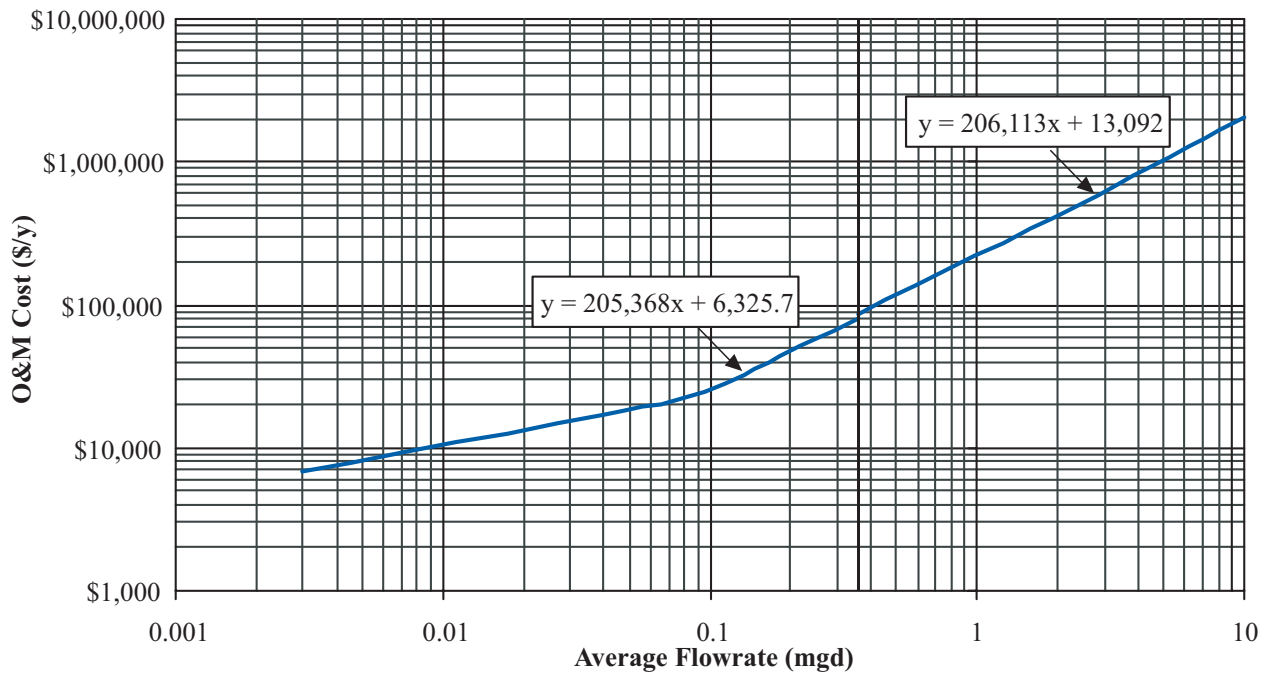

Figure 4-19. Activated Alumina (pH adjusted to 6.0 - 15,400 BV) O&M Costs.

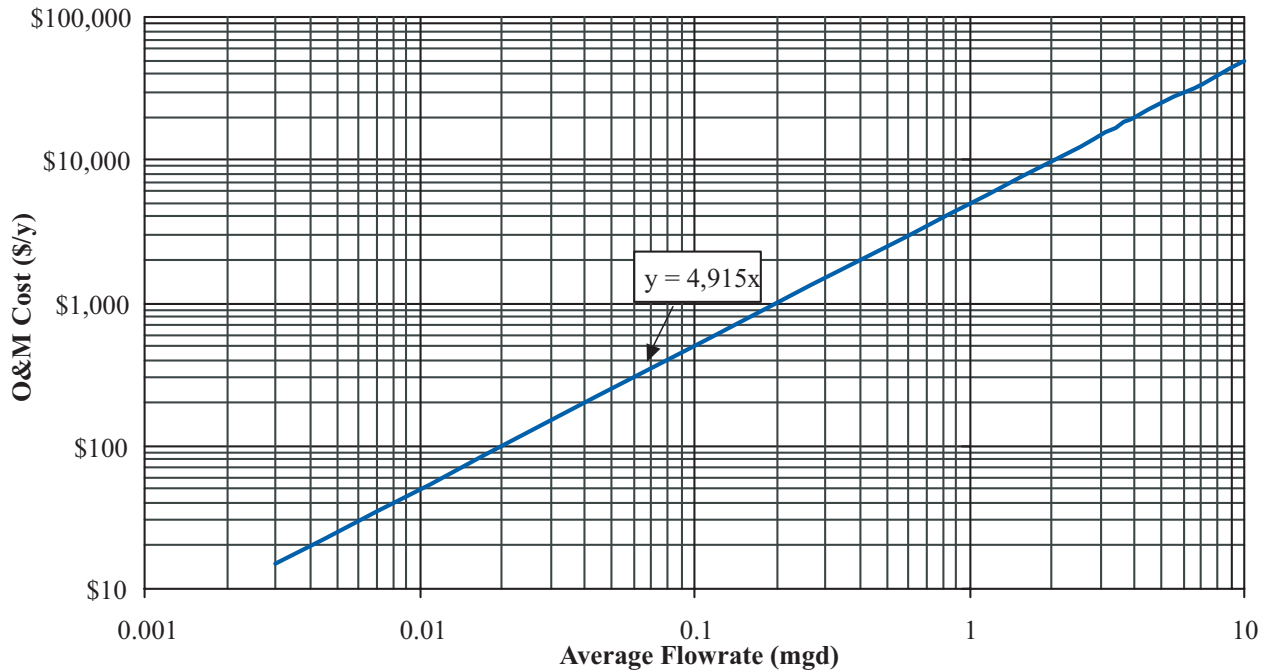

Figure 4-20. Activated Alumina (pH adjusted to 6.0 - 15,400 BV) Waste Disposal O&M Costs.

#### 4.4 Iron Based Sorbent System Costs

IBS are relatively new technologies and, as such, costs for IBS treatment systems have not yet been developed.

#### 4.5 Greensand System Costs

Costs presented in the following charts make the following assumptions:

- A new greensand filtration system is installed.
- Potassium permanganate feed rate of 10 mg/L (however, chlorination will work also).
- Hydraulic loading rate of 4 gpm/sft.
- Backwash flowrate of 10-12 gpm/sft.
- Backwash waste is discharged to a POTW (i.e., indirect discharge).

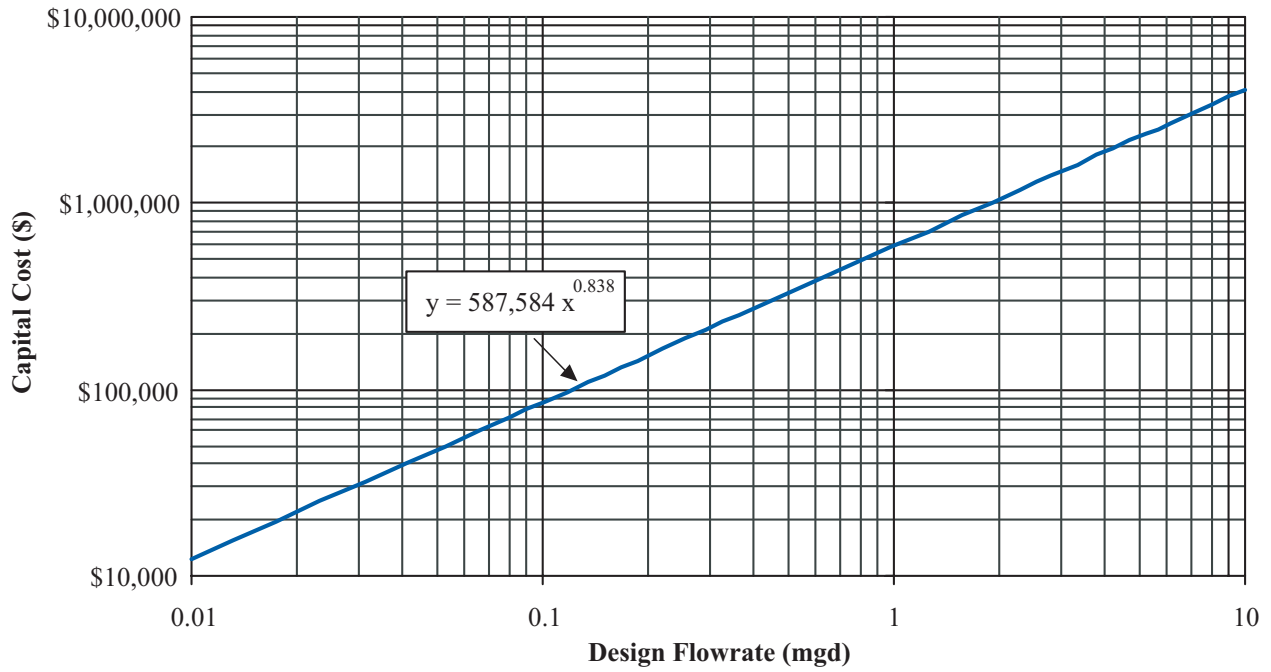

Figure 4-21. Greensand Capital Costs.

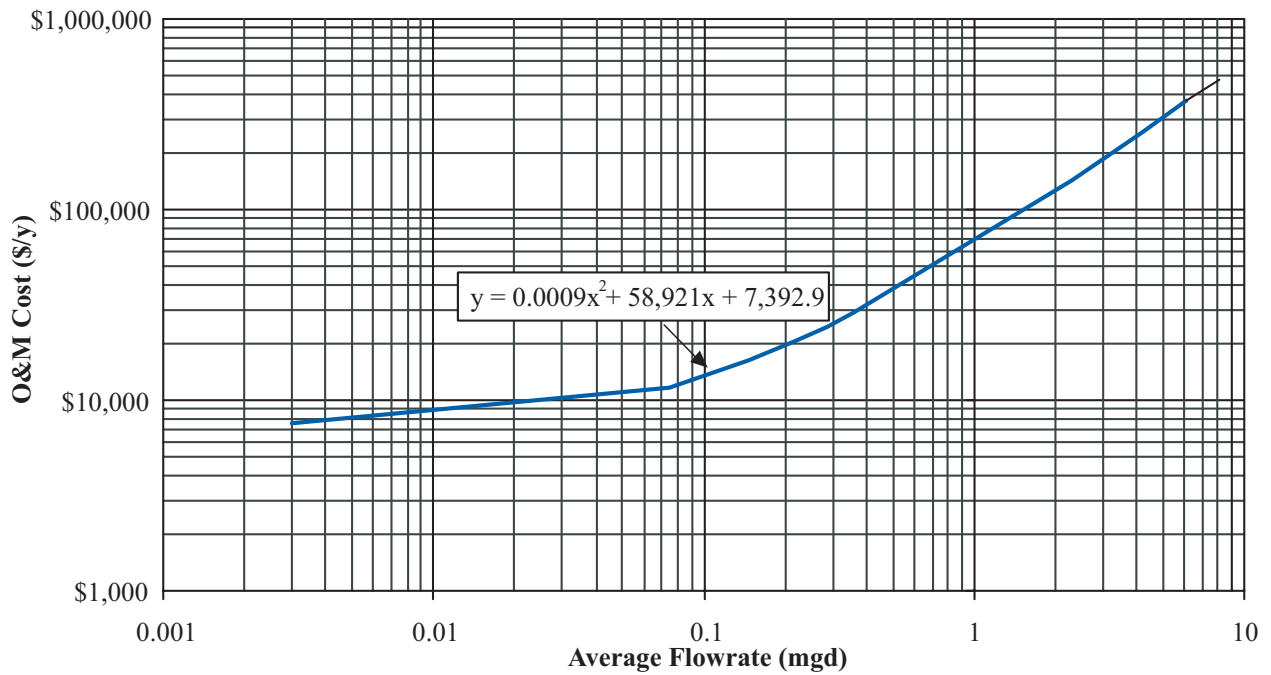

Figure 4-22. Greensand O&M Costs.

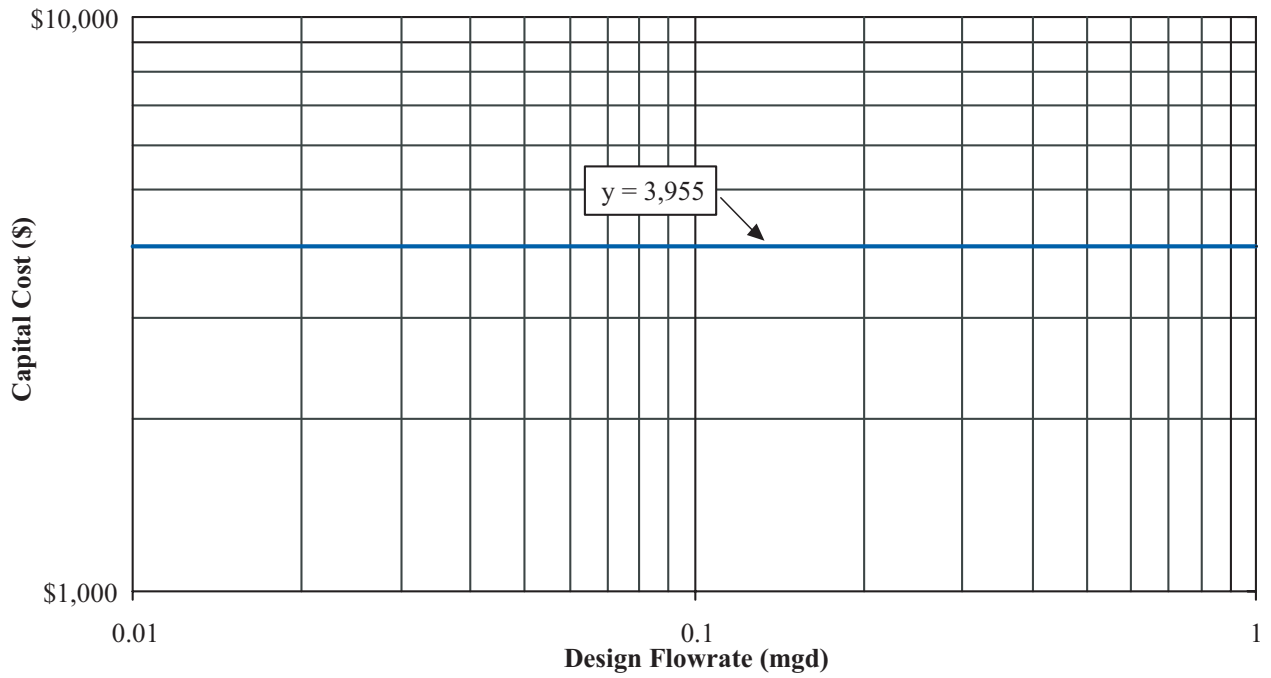

Figure 4-23. Greensand Waste Disposal Capital Costs.

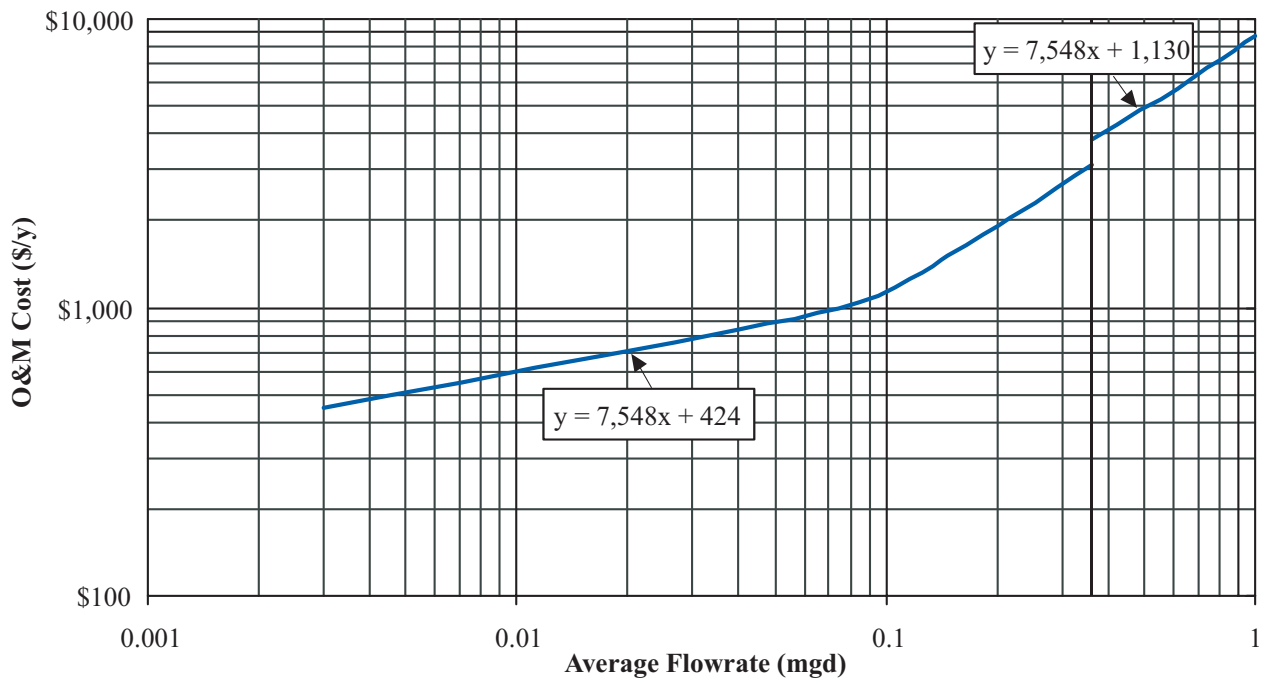

Figure 4-24. Greensand Waste Disposal O&M Costs.

## 4.6 Coagulation Assisted Microfiltration System Costs

Costs presented in the following charts make the following assumptions:

- Ferric chloride dose of 25 mg/L.
- For Systems Less Than 1 MGD:
  - Package plants with a hydraulic loading rate of 5 gpm/sft.
  - Sodium hydroxide dose of 20 mg/L for pH control.
  - Standard MF.
- For Systems Larger Than 1 MGD:
  - Rapid mix for 1 minute.
  - Flocculation for 20 minutes.
  - Sedimentation at 1000 gpd/sft using rectangular tanks.
  - Standard MF.
- Waste is dewatered before being disposed of in a non-hazardous landfill. Costs are given for dewatering performed either mechanically or non-mechanically. Land costs are not included in the waste disposal costs.

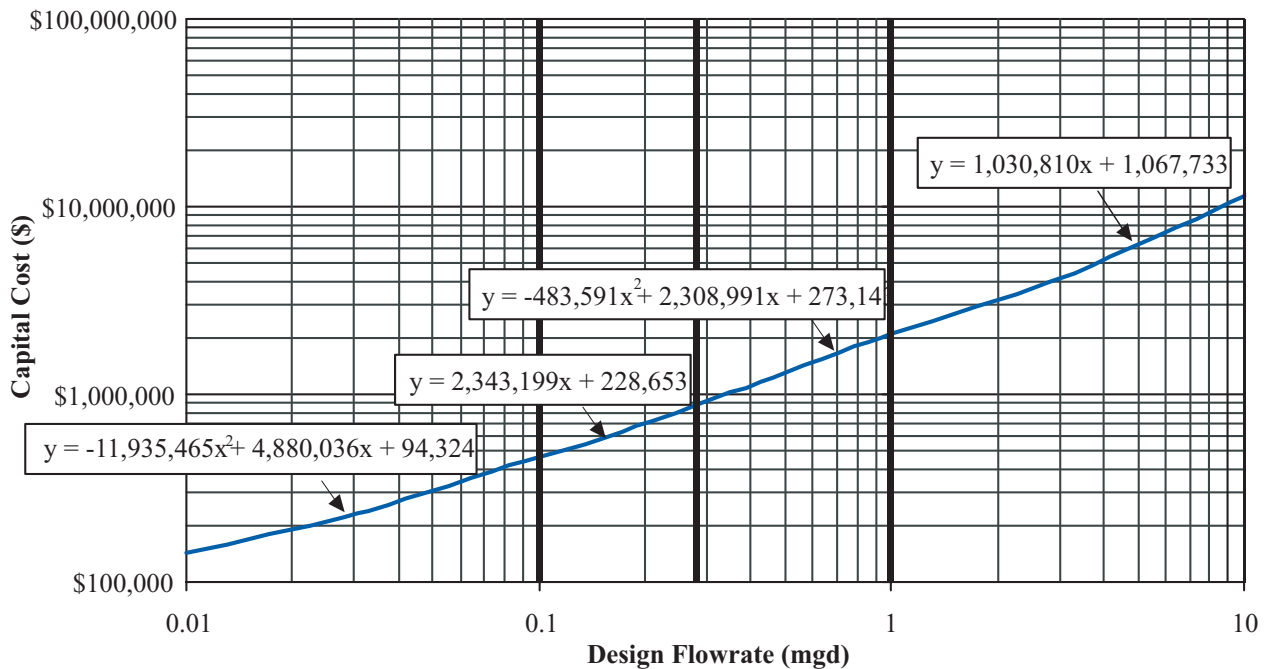

Figure 4-25. Coagulation Assisted Microfiltration Capital Costs.

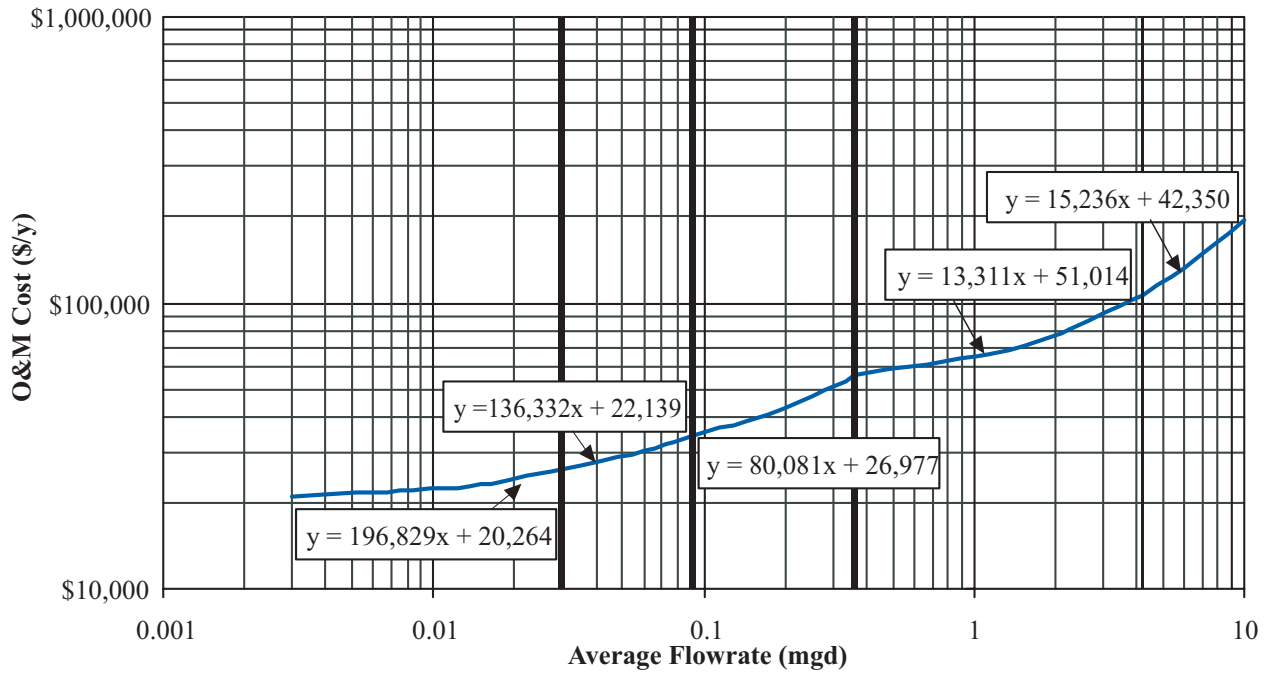

Figure 4-26. Coagulation Assisted Microfiltration O&M Costs.

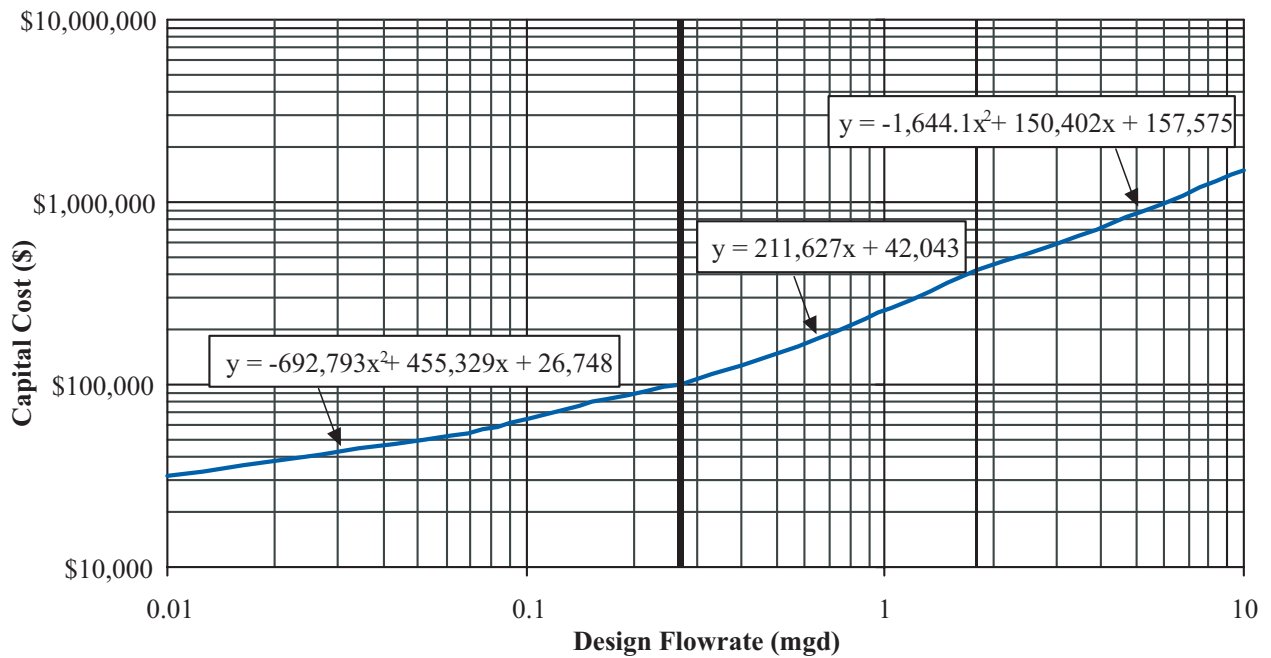

Figure 4-27. Coagulation Assisted Microfiltration (w/ Mechanical Dewatering) Waste Disposal Capital Costs.

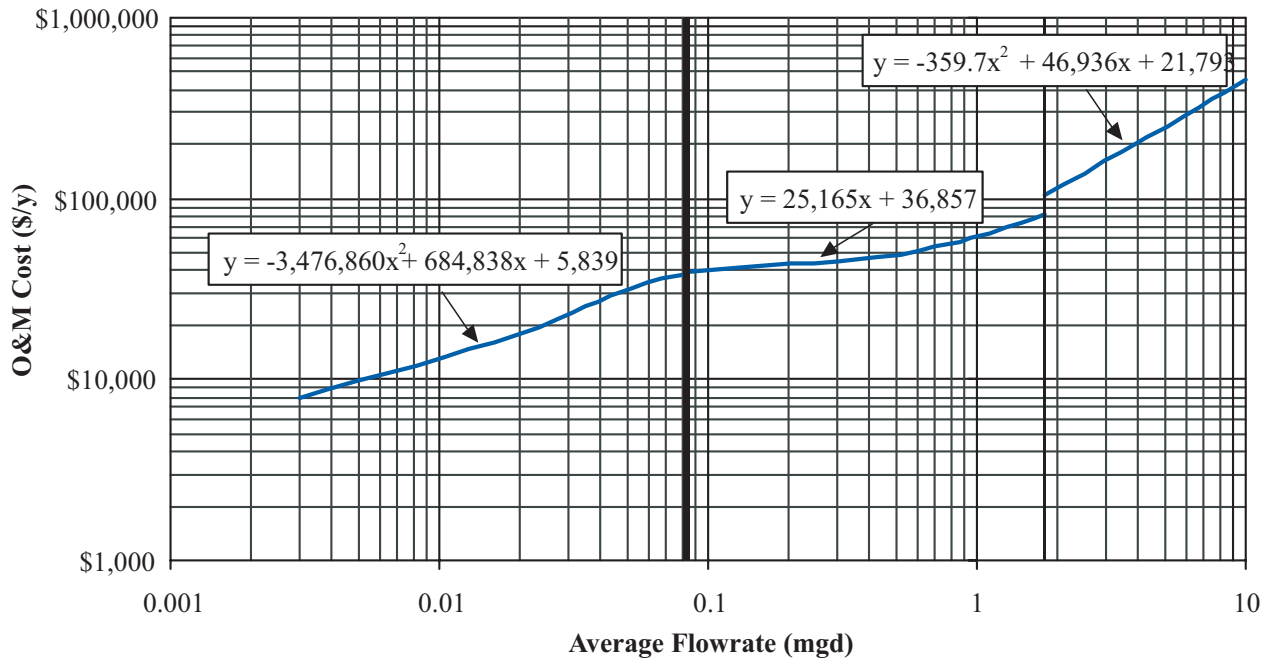

Figure 4-28. Coagulation Assisted Microfiltration (w/ Mechanical Dewatering) Waste Disposal O&M Costs.

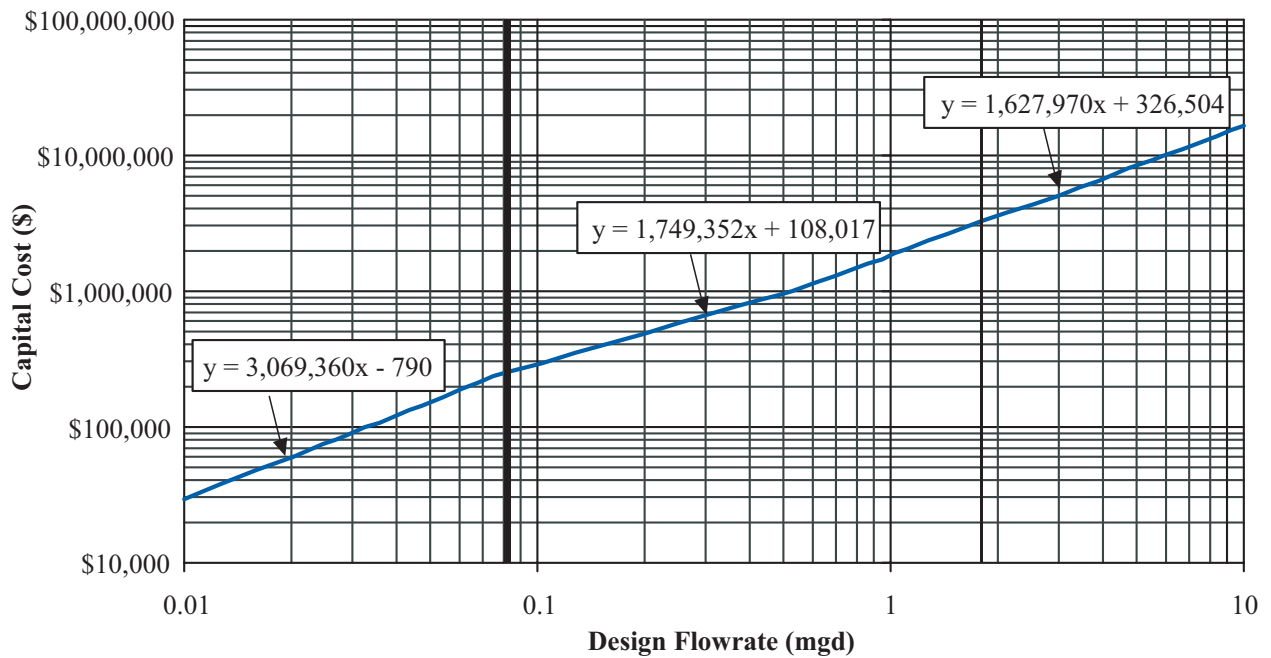

Figure 4-29. Coagulation Assisted Microfiltration (w/ NonMechanical Dewatering) Waste Disposal Capital Costs.

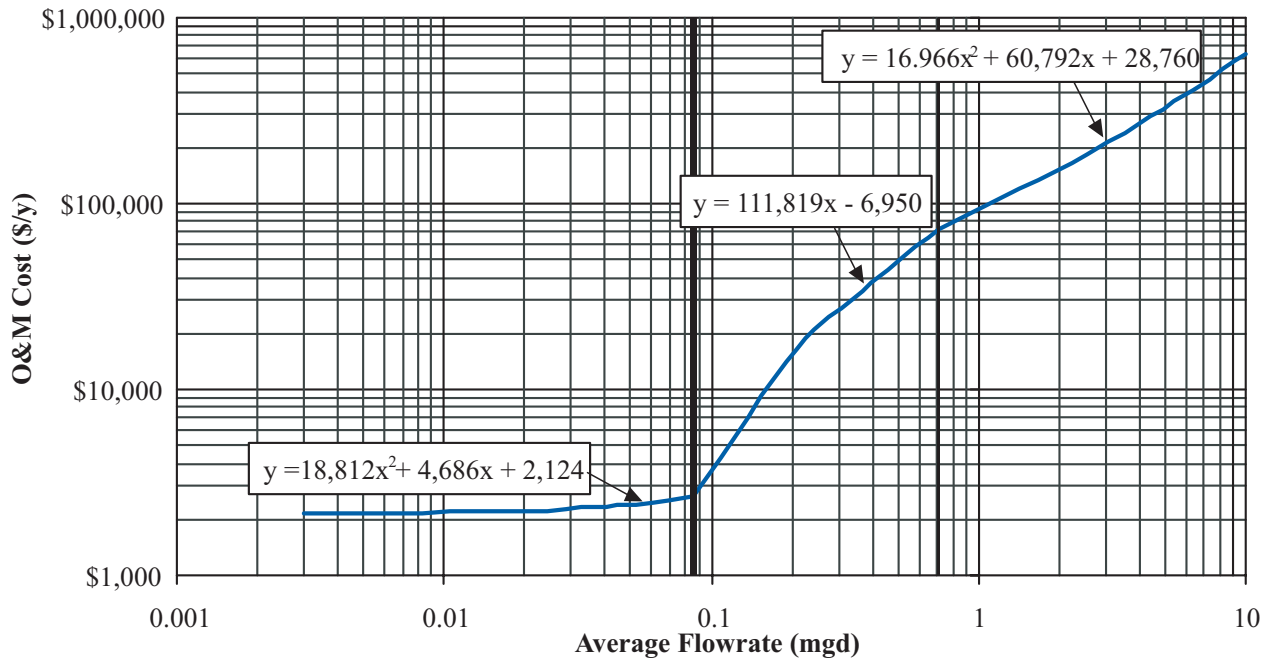

Figure 4-30. Coagulation Assisted Microfiltration (w/ NonMechanical Dewatering) Waste Disposal O&M Costs.

## 4.7 Coagulation/Filtration System Enhancement Costs

Costs presented in the following charts make the following assumptions:

- A coagulation/filtration system is already installed. Costs are only for system enhancement for arsenic removal.
- Assumptions about the Existing Coagulation/Filtration System:
  - Existing coagulation/filtration system removes 50% of the arsenic without enhancement.
  - Ferric chloride dose of 25 mg/L.
  - Polymer dose of 2 mg/L.
  - Lime dose of 25 mg/L for pH control.
  - Systems less than 1 MGD are package plants with a hydraulic loading rate of 5 gpm/sft.
  - Systems Larger Than 1 MGD:
    - Rapid mix for 1 minute.
    - Flocculation for 20 minutes.
    - Sedimentation at 1000 gpd/sft using rectangular tanks.
    - Dual media gravity filters running at a hydraulic loading rate of 5 gpm/sft.
- Assumptions for the Enhancement of the Coagulation/Filtration System:
  - Additional ferric chloride dose of 10 mg/L.
  - Additional feed system for increased ferric chloride dose.
  - Additional lime dose of 10 mg/L for pH adjustment.
  - Additional feed system for increased lime dose.



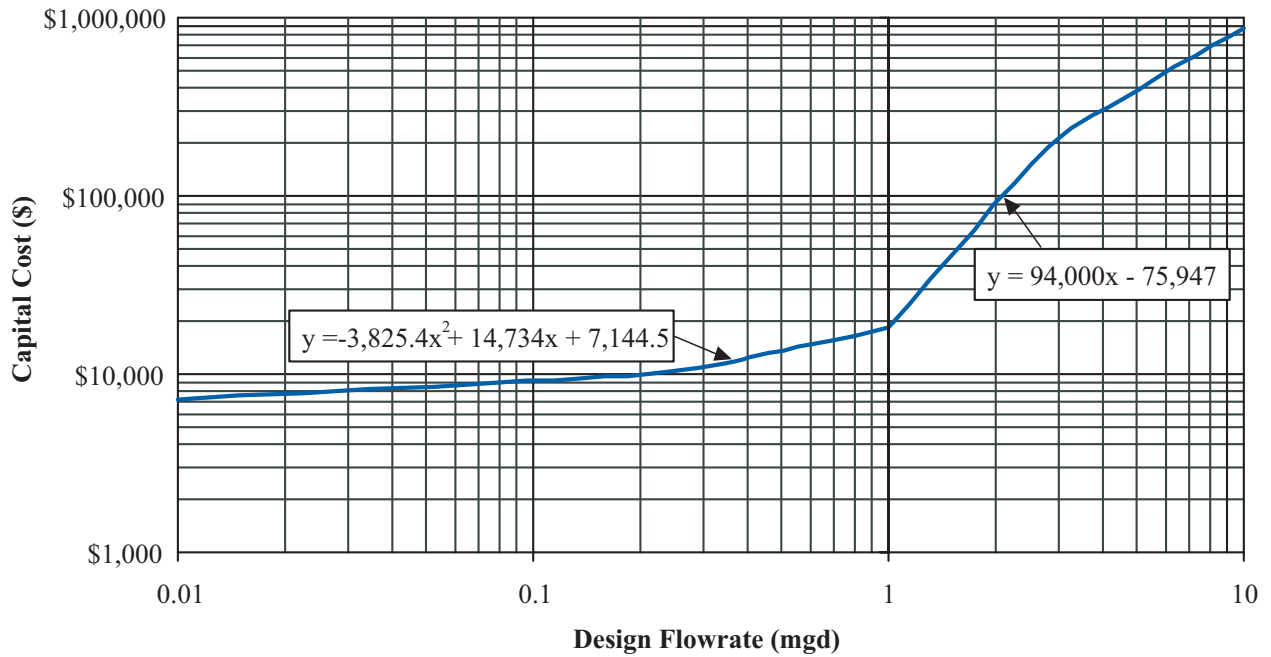

Figure 4-31. Coagulation/Filtration System Enhancement Capital Costs.

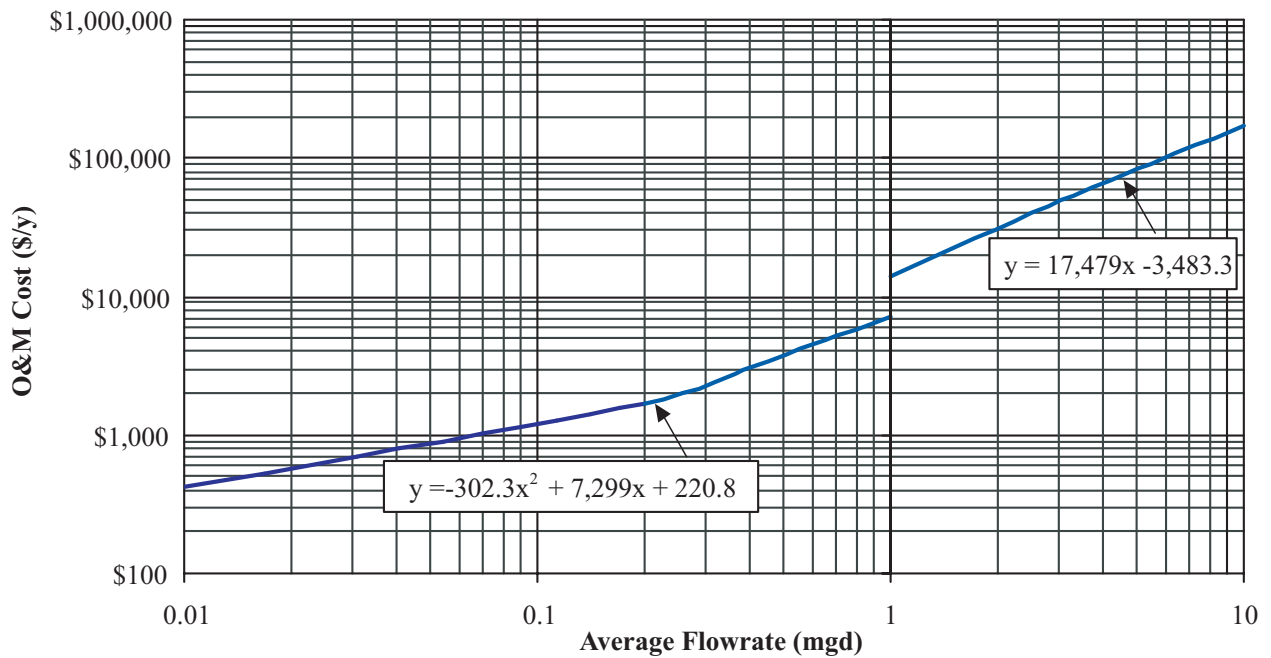

Figure 4-32. Coagulation/Filtration System Enhancement O&M Costs. Lime Softening System Enhancement Costs

## 4.8 Lime Softening System Enhancement Costs

Costs presented in the following charts make the following assumptions:

- An LS system is already installed. Costs are only for system enhancement for arsenic removal.
- Lime dosage of 250 mg/L.
- Carbon dioxide dosage of 35 mg/L for recarbonation.
- Assumptions about the Existing LS System:
  - Systems less than 1 MGD are package plants.
  - Systems Larger Than 1 MGD:
    - Rapid mix for 1 minute.
    - Flocculation for 20 minutes.
    - Sedimentation at 1500 gpd/sft using circular tanks.
    - Dual media gravity filters running at a hydraulic loading rate of 5 gpm/sft.
- Assumptions for the Enhancement of Existing LS System:
  - Additional lime dose of 50 mg/L.
  - Additional feed system for increased LS dose.
  - Additional carbon dioxide dose of 35 mg/L for recarbonation.
  - Additional feed system for increased carbon dioxide dose.

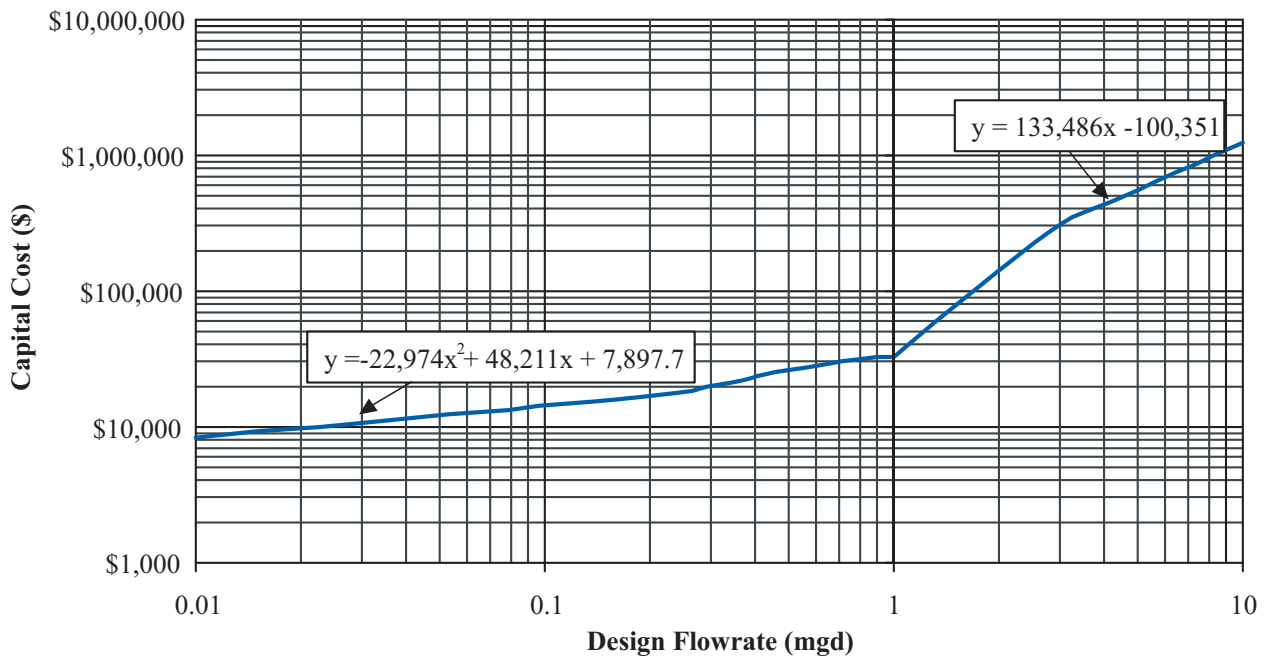

Figure 4-33. Lime Softening Enhancement Capital Costs.

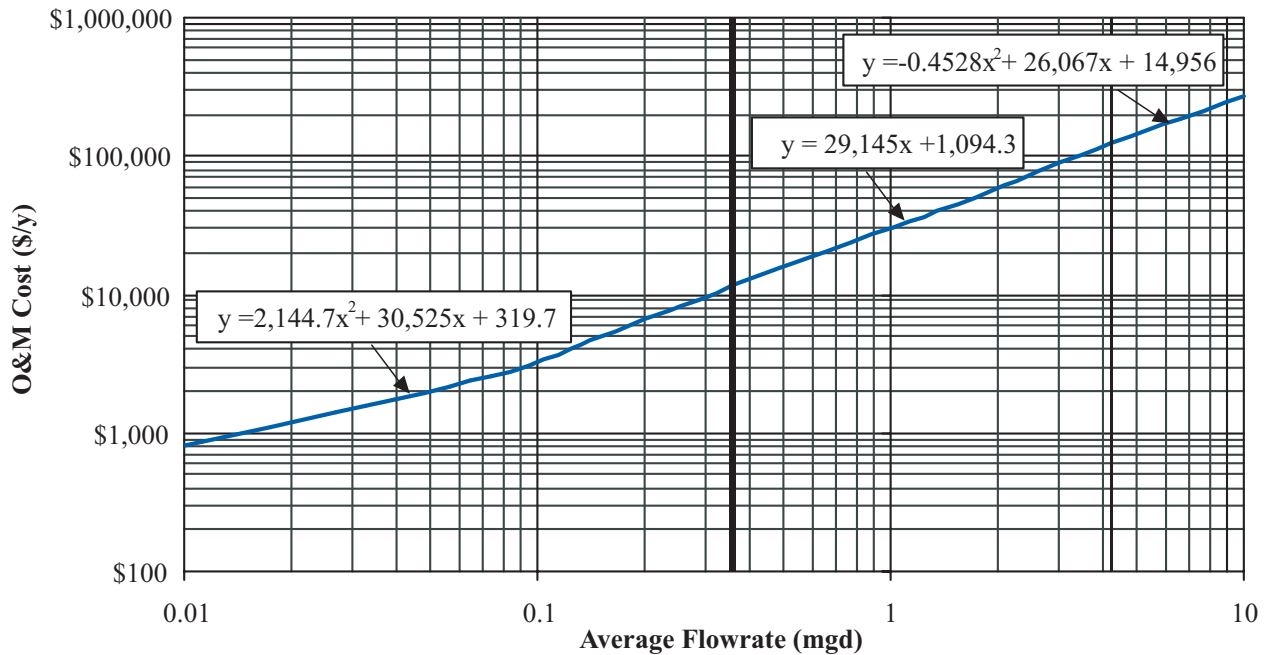

Figure 4-34. Lime Softening Enhancement O&M Costs.

#### 4.9 Point-of-Use Reverse Osmosis System Costs

Costs presented in the following charts make the following assumptions:

- In an average household, there are 3 individuals using 0.53 gallon each per day for a total of 579 gallons per year.<sup>10</sup>
- Life of POU unit is 5 years.
- Duration of cost study is 10 years.
- Cost of water meter and automatic shut-off valve included.
- No shipping and handling included.
- If the water is chlorinated, dechlorination may be required. Costs for dechlorination are not included.
- Volume discount schedule—retail for a single unit, 10 percent discount for 10 or more units, 15 percent discount on more than 100 units.
- Installation time—1 hour unskilled labor (POU)
- Minimally skilled labor—\$14.50 per hour (population less than 3,300 individuals).
- Skilled labor—\$28 per hour (population greater than 3,300 individuals).
- O&M costs include maintenance, replacement of pre-filters and membrane cartridges, laboratory sampling and analysis, and administrative costs.

<sup>10</sup> USEPA, 1998.

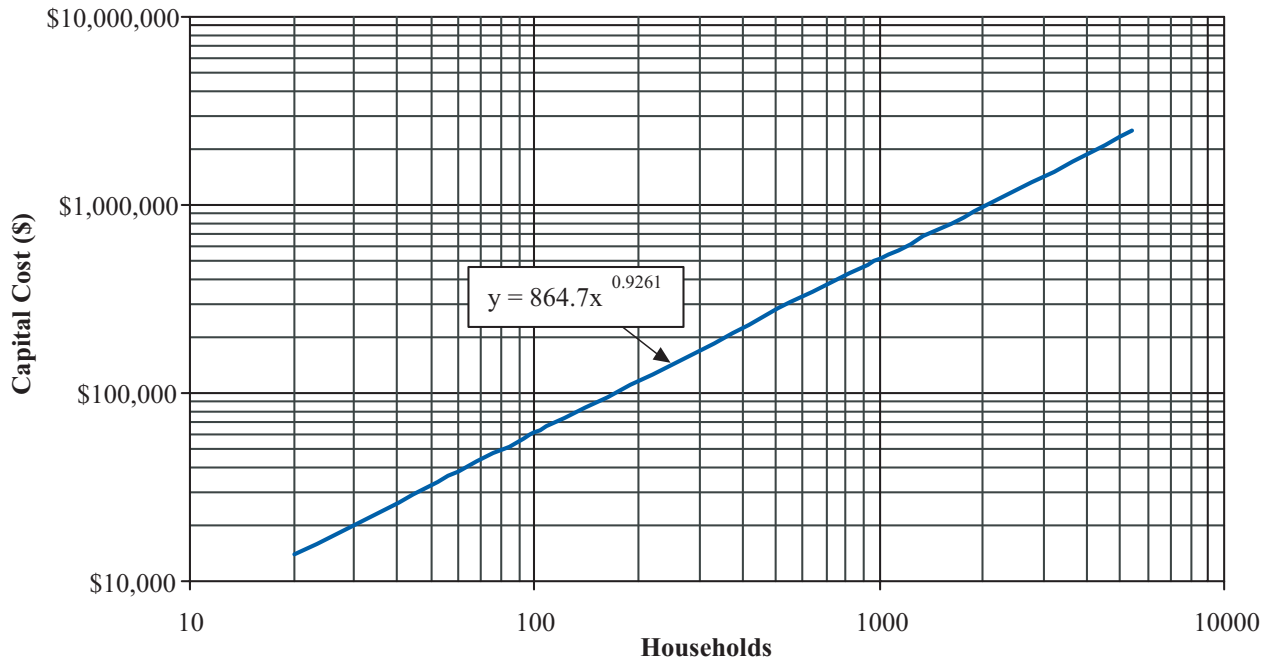

Figure 4-35. POU Reverse Osmosis Capital Costs.

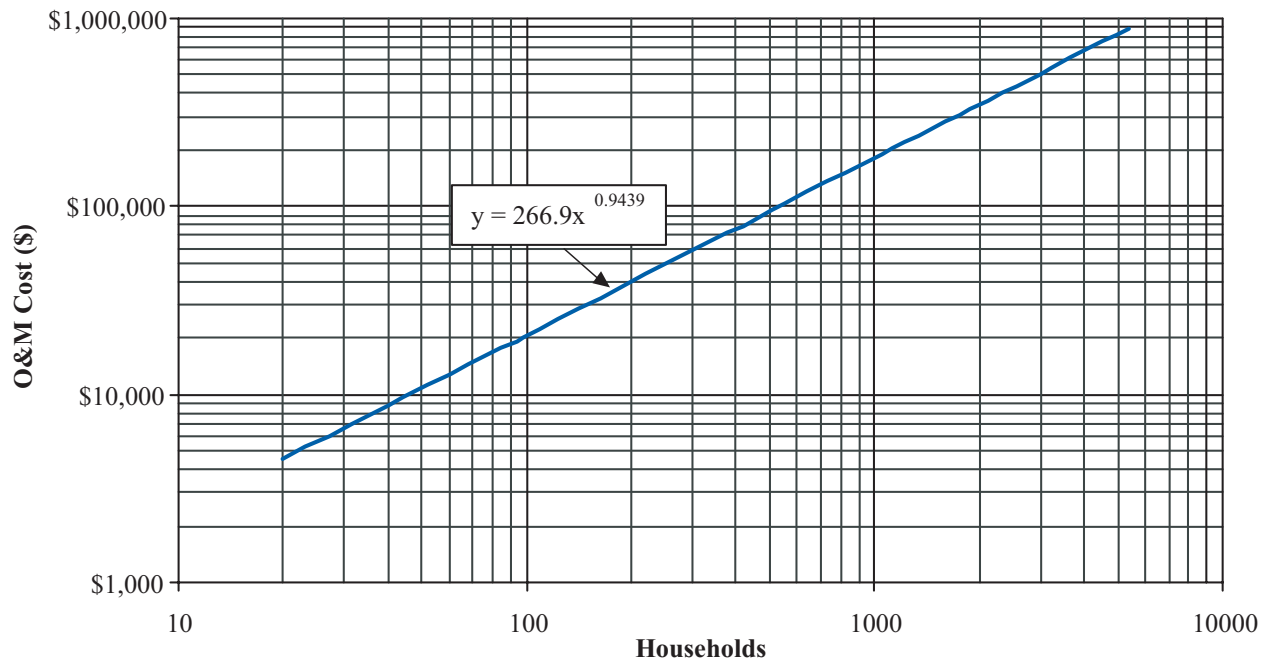

Figure 4-36. POU Reverse Osmosis O&M Costs.

## 4.10 Point-of-Use Activated Alumina System Costs

Costs presented in the following charts make the following assumptions:

- In an average household, there are 3 individuals using 0.53 gallon each per day for a total of 579 gallons per year.<sup>11</sup>
- Life of POU unit is 5 years.
- Duration of cost study is 10 years.
- Cost of water meter and automatic shut-off valve included.
- No shipping and handling included.
- Volume discount schedule—retail for a single unit, 10 percent discount for 10 or more units, 15 percent discount on more than 100 units.
- Installation time—1 hour unskilled labor (POU)
- Minimally skilled labor—\$14.50 per hour (population less than 3,300 individuals).
- Skilled labor—\$28 per hour (population greater than 3,300 individuals).
- O&M costs include maintenance, replacement of pre-filters and membrane cartridges, laboratory sampling and analysis, and administrative costs.

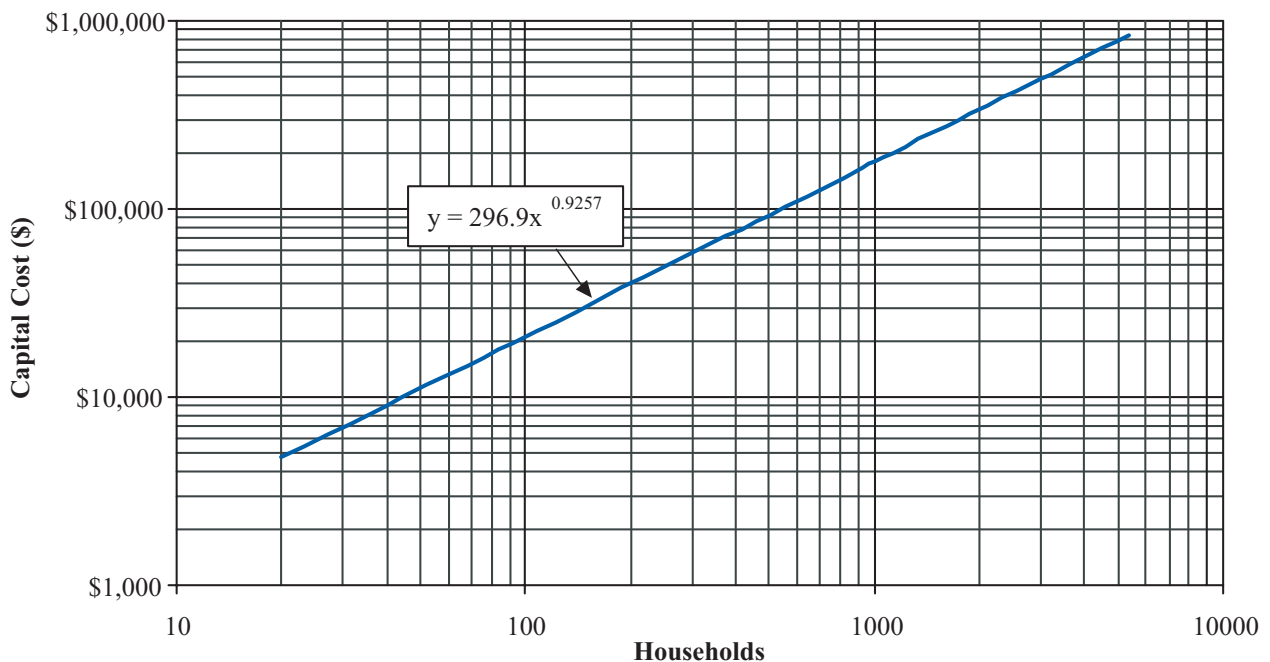

Figure 4-37. POU Activated Alumina Capital Costs.

<sup>11</sup> USEPA, 1998.

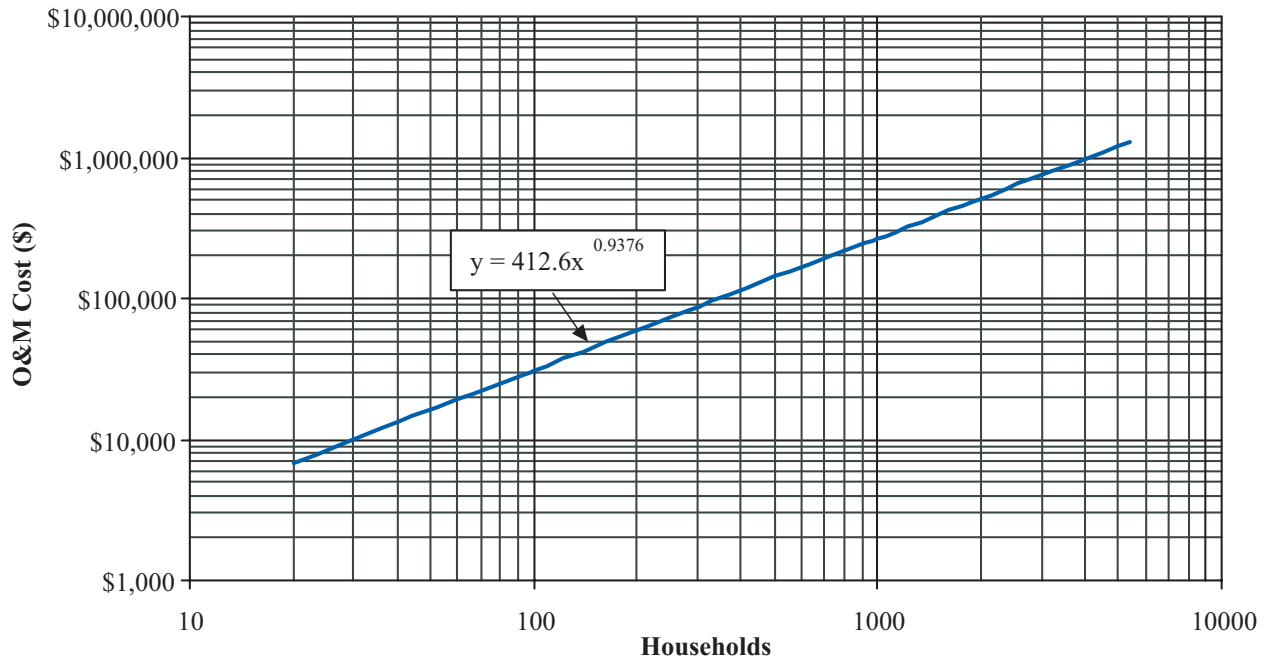

Figure 4-38. POU Activated Alumina O&M Costs.

#### 4.11 Point-of-Use Iron Based Sorbent System Costs

Iron based sorbents (IBS) are relatively new technologies and, as such, the costs for using small IBS units in a POU scheme have not been well defined. Costs for an IBS POU system are anticipated to be similar to those of an AA POU system.

# Section 5

## Pre-Oxidation Design Considerations

---

The conversion of reduced inorganic As(III) to As(V) is critical for achieving optimal performance of *all* unit processes described in this Handbook. Conversion to As(V) can be accomplished by providing an oxidizing agent at the head of any proposed arsenic removal process. Chlorine and permanganate are highly effective for this purpose. They oxidize As(III) to As(V) within one minute in the pH range of 6.3 to 8.3. Ozone rapidly oxidizes As(III) but its effectiveness is significantly diminished by the presence of sulfides or TOC. Solid phase oxidants such as Filox-R™ have also been shown to oxidize As(III). Chlorine dioxide and monochloramine are ineffective in oxidizing As(III). UV light, by itself is also ineffective. However, if the water is spiked with sulfite, UV photo-oxidation shows promise. Because of these considerations, only chlorine, permanganate, ozone, and solid phase oxidants are discussed in this section.

### 5.1 Chlorine Pre-Oxidation Design Considerations

The primary applications of chlorine in water treatment include pre-oxidation, primary disinfection, and secondary disinfection. Several arsenic removal processes, particularly membranes, are chlorine sensitive and/or intolerant. In these instances, the utility should consider an alternate oxidation technology. If this is the case, but the system already has chlorination capabilities in place, the process of modifying the existing system to achieve As(III) oxidation is complicated. One alternative is the application of a pre-chlorination—dechlorination—arsenic removal—re-chlorination treatment setup. However, this alternative may be more costly than integrating a permanganate pre-oxidation system.

Chlorine can be added either as liquid sodium hypochlorite (Equation 5-1) or dissolved gas (Equation 5-2). In either case, biocidal hypochlorous acid is generated.



The first step in selecting the most appropriate method of chlorination is to determine the chlorine flow requirements for the particular application. Chlorine demand can be calculated with Equation 5-3.

$$M_{\text{Cl}_2} = Q \cdot \delta_{\text{Cl}_2} \cdot \left( 0.012 \frac{\text{min}}{\text{d}} \cdot \frac{\text{L}}{\text{gal}} \cdot \frac{\text{lb}}{\text{mg}} \right) \quad \text{Eqn. 5-3}$$

where:

$M_{\text{Cl}_2}$  = Chlorine Mass Flow (lb/day of  $\text{Cl}_2$ ),

Q = Design Flow Rate (gpm), and  
 $\delta_{Cl_2}$  = Chlorine Dose (mg/L as  $Cl_2$ ).

Careful consideration should be given to the chlorine dose estimate. Most waters contain substances other than As(III) that exert chlorine demand. In many cases, these substances compete for chlorine more aggressively than As(III). Section 2.2.1 lists the chlorine demand for the stoichiometric conversion of As(III),  $Fe^{2+}$ ,  $Mn^{2+}$ , and  $HS^-$ . Chlorine will also react with ammonia and TOC. Simple chlorine demand bench testing can be used to ascertain the instantaneous and ultimate chlorine demand of particular water. The applied chlorine dose should be three times the ultimate chlorine demand.

$$\delta_{Cl_2} = 3 \cdot D_{Cl_2} \quad \text{Eqn. 5-4}$$

Where:

$\delta_{Cl_2}$  = Chlorine Dose (mg/L as  $Cl_2$ ), and  
 $D_{Cl_2}$  = Ultimate Chlorine Demand (mg/L as  $Cl_2$ ).

Selection of the type of chlorination system should include consideration of capital and operating costs, O&M requirements, code restrictions, containment requirements, footprint, and safety concerns. This Handbook will address the following options, which are considered most viable for small water systems:

- Commercial liquid hypochlorite feed system
- On-site hypochlorite generation system

The application of chlorine gas for chlorination is not discussed as it is more hazardous, frequently more expensive, and frequently less applicable to small systems.

### 5.1.1 Commercial Liquid Hypochlorite

Liquid sodium hypochlorite can be purchased as a 5¼% or 12½% strength solution. The solution must be delivered to the facility by tanker trucks or in drums on a regular basis. The solution is stored on-site in a tank and metered into the system by a small pump. Figure 5-1 shows a flow diagram for a typical liquid hypochlorite process. Figure 5-2 is a typical flow schematic for a flooded suction hypochlorite metering system.



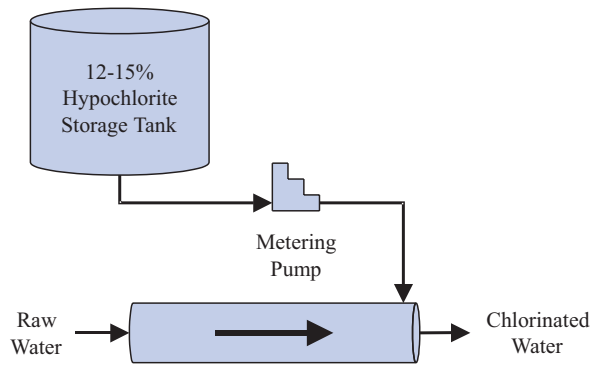

Figure 5-1. Typical Liquid Hypochlorite Process Flow Diagram.

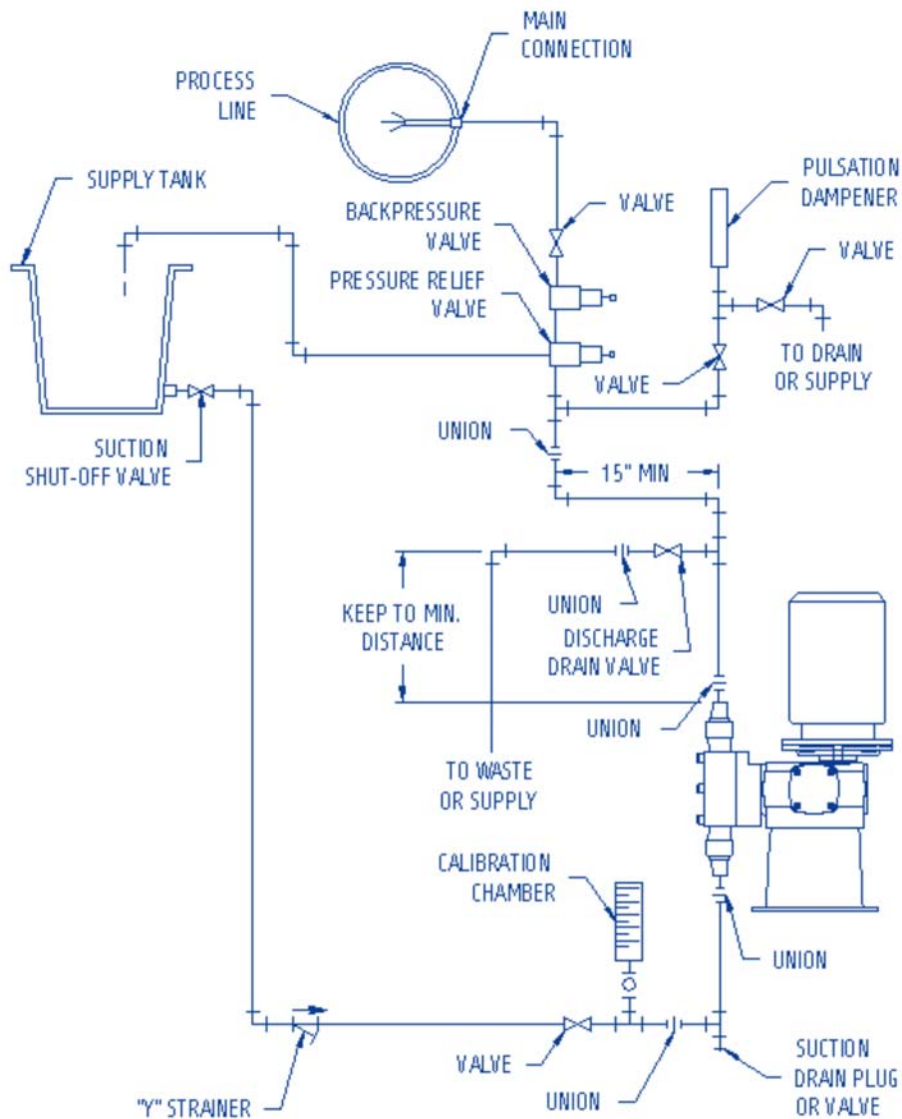

Figure 5-2. Liquid Hypochlorite System Schematic (USFilter, Wallace & Tiernan).

The flow rate of liquid hypochlorite required to meet chlorine mass flow requirements can be approximated by Equation 5-5. This flow rate should be used to size the metering pump, as well as provide an estimate of chemical operating costs.

$$Q_{Cl_2} = \frac{M_{Cl_2}}{C_{Cl_2}} \left( \frac{d}{24 \text{ hr}} \right) \quad \text{Eqn. 5-5}$$

Where:

$Q_{Cl_2}$  = Hypochlorite Metering Pump Rate (gph) and

$M_{Cl_2}$  = Chlorine Mass Flow (lb/day of  $Cl_2$ ).

$C_{Cl_2}$  = Concentration of Chlorine Solution (lbs  $Cl_2$ /gal).

For 12.5 wt% Sodium Hypochlorite, the concentration is 1.26 lbs/gal.

For 5.25 wt% Sodium Hypochlorite, the concentration is 0.47 lbs/gal.

For 0.008 wt% Sodium Hypochlorite, the concentration is 0.068 lbs/gal.

The required capacity of the storage tank is contingent upon the desired frequency of tanker truck deliveries. Tanks are commonly sized to provide 7-21 days of storage. Because commercial strength liquid hypochlorite is a Class 1 Liquid Oxidizer, storage of more than 4,000 pounds represents a non-exempt quantity and requires special precautions. The storage volume required may be calculated as follows.

$$V = (Q_{Cl_2} \cdot t) \cdot \left( 24 \frac{\text{hr}}{\text{day}} \right) \quad \text{Eqn. 5-6}$$

Where:

$V$  = Storage Volume (gal),

$Q_{Cl_2}$  = Hypochlorite Metering Pump Rate (gph), and

$t$  = Storage Time (days).

### 5.1.2 On-Site Hypochlorite Generation

On-site generation of sodium hypochlorite is accomplished by adding electricity to a saturated (32%) brine solution. The strength of hypochlorite produced is 0.8%, which is below the hazardous material threshold of 1%. These systems can be constructed piecewise or purchased as pre-engineered units.

Figure 5-3 shows a typical flow diagram for an on-site hypochlorite generation system. The equipment requirements of an on-site generation system, which can be seen in Figure 5-4, include a salt saturator, hypochlorite storage tanks, electrolyzers, rectifiers, controls, and hypochlorite metering pumps. The following material inputs are required per pound of chlorine generated: 3.5 lbs NaCl salt, 15 gallons of water, and 2.5 kWh of electrical energy.

Figure 5-5 shows an on-site hypochlorite generator that will produce up to 36 lbs of chlorine per day.

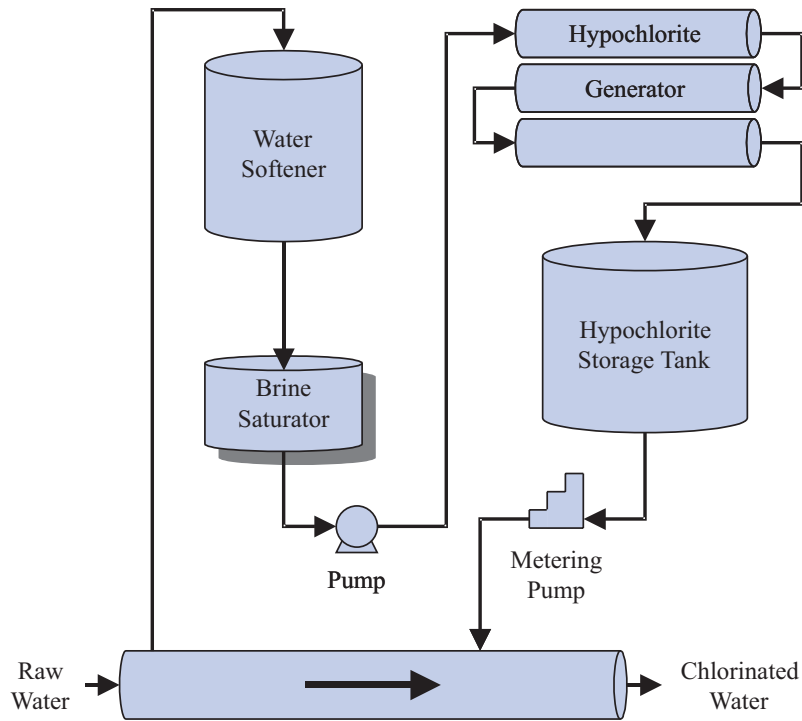

Figure 5-3. Typical On-Site Hypochlorite Generation Process Flow Diagram.

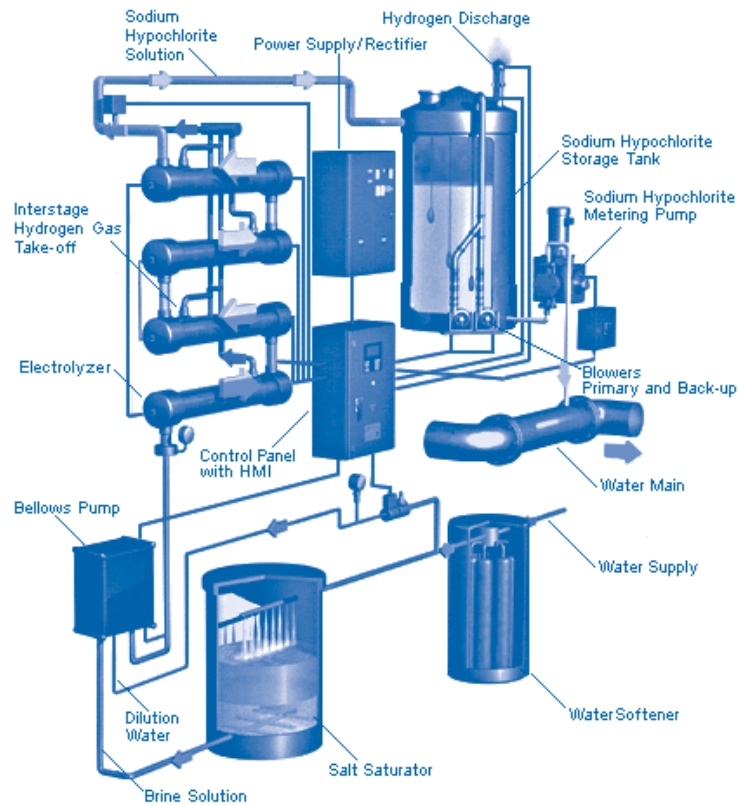

Figure 5-4. On-Site Hypochlorite Generation System Schematic (USFilter, Wallace & Tiernan).



Figure 5-5. On-Site Hypochlorite Generation System (Severn Trent Services).

## 5.2 Permanganate Pre-Oxidation Design Considerations

The primary applications of permanganate ( $\text{MnO}_4^-$ ) in water treatment include preoxidation (particularly for iron and manganese) and taste and odor control. Potassium permanganate exists in solid, granular form, but is typically applied as a saturated liquid (60 g/L at room temperature).

Permanganate is not biocidal against drinking water pathogens, so there should be negligible residual leaving the treatment works. Manganese particulates ( $\text{MnO}_2$ ) are produced as a result of permanganate oxidation reactions. To prevent the accumulation of these deposits in the distribution system, post-filtration treatment must be applied.

Potassium permanganate is a Class 2 Solid Oxidizer. The storage of more than 250 lbs necessitates special hazardous waste precautions. Potassium permanganate can be purchased in a variety of quantities, including 55-lb (25-kg) pails, 110-lb (50-kg) kegs, and 330-lb (150-kg) drums. The solids can be stored indefinitely if kept in a covered container and maintained in a cool, dry environment. Special handling and safety requirements should be employed when working with solid potassium permanganate, including the use of goggles, rubber gloves, and an approved NIOSH-MSHA dust and mist respirator.

Careful consideration should be given to the permanganate dose estimate. Most waters contain substances other than As(III) that exert oxidant demand. Section 2.2.2 lists the permanganate demand for the stoichiometric conversion of As(III),  $\text{Fe}^{2+}$ ,  $\text{Mn}^{2+}$ , and  $\text{HS}^-$ . Permanganate reacts aggressively with organic materials. Permanganate may also be consumed during the regeneration of  $\text{MnO}_2$  media. The ultimate permanganate demand is the sum of all these factors. The applied dose should be three times larger than the ultimate permanganate demand.

$$\delta_{\text{MnO}_4} = 3 \cdot D_{\text{MnO}_4} \quad \text{Eqn. 5-7}$$

Where:

$\delta_{\text{MnO}_4}$  = Permanganate Dose (mg/L as Mn) and

$D_{\text{MnO}_4}$  = Ultimate Permanganate Demand (mg/L as Mn).

The application of potassium permanganate is straightforward. Permanganate solution is prepared by loading solid potassium permanganate into a storage silo. A feeder meters the permanganate into a dry hopper, which allows the solids to be pulled into a water stream where it dissolves. The permanganate solution is then stored in a solution tank until it is metered into the water to be treated. This process is shown in the flow diagram in Figure 5-6. For small systems looking to maintain simplicity, manually loading solids into a solution tank filled with water to create batch quantities of permanganate solution is recommended.

Pre-engineered drum inverters (Figure 5-7) and dry feeders (Figure 5-8) are available in several different styles, including gravimetric weigh-belt and volumetric (hopper) type.

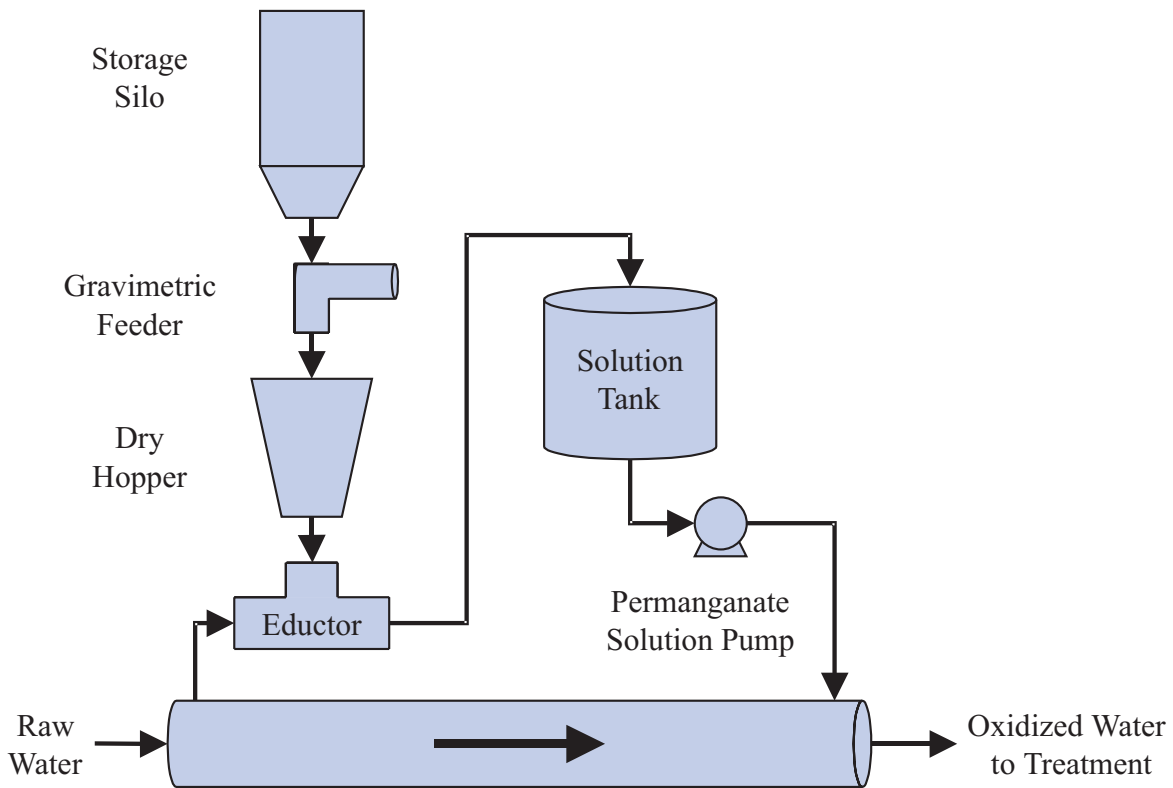

Figure 5-6. Typical Permanganate Process Flow Diagram.



Figure 5-7. Permanganate Dry Feed System (Merrick Industries, Inc.).



Figure 5-8. Permanganate Dry Feed System (Acrison, Inc.).

The stock solution is then metered into the water system with the use of a small pump. The flow rate of solution required to meet the dose requirements are contingent upon the strength of the stock solution, according to Equation 5-8.

$$Q_{\text{MnO}_4} = \frac{Q \cdot \delta_{\text{MnO}_4}}{C_{\text{MnO}_4} - \delta_{\text{MnO}_4}} \cdot \left( 60 \frac{\text{min}}{\text{hr}} \right) \quad \text{Eqn. 5-8}$$

Where:

- $Q_{\text{MnO}_4}$  = Permanganate Metering Pump Rate (gph),
- $Q$  = Design Flowrate (gpm),
- $\delta_{\text{MnO}_4}$  = Permanganate Dose (mg/L), and
- $C_{\text{MnO}_4}$  = Permanganate Stock Solution Concentration (mg/L).

### 5.3 Ozone Pre-Oxidation Design Considerations

Ozone can be used in water treatment for disinfection, oxidation, and taste and odor control. Ozone is a gas and is created either by passing air through an electrical discharge or by irradiating air with UV light. The UV method is much less expensive, quite reliable, and can produce ozone in a 0.1% concentration.

Careful consideration should be given to the ozone dose estimate. Most waters contain substances other than As(III) that exert oxidant demand. Section 2.2.3 lists the ozone demand for the stoichiometric conversion of As(III),  $\text{Fe}^{2+}$ ,  $\text{Mn}^{2+}$ , and  $\text{HS}^-$ . Ozone will also react with TOC. The ultimate ozone demand is the sum of all these factors. The applied dose should be three times larger than the ultimate ozone demand.

$$\delta_{O_3} = 3 \cdot D_{O_3} \quad \text{Eqn. 5-9}$$

Where:

$\delta_{O_3}$  = Ozone Dose (mg/L) and

$D_{O_3}$  = Ultimate Ozone Demand (mg/L).

To create ozone, an air stream is passed through a tube irradiated with UV light. This excites the oxygen ( $O_2$ ) molecules and causes some of them to form ozone ( $O_3$ ). The air stream containing ozone is injected and mixed into the raw water, which then passes into a contactor, which provides time for the ozone to dissolve into the water. The mixture then flows into a de-gas separator that allows the un-dissolved gasses to separate to the top where they leave the separator, pass through a residual ozone gas destructor, and are off-gassed. The contactor and de-gas separator also provide time for ozone to oxidize the As(III) into As(V), which, depending on interfering reductants that may be present, could be as long as 2.2 minutes. Figure 59 below shows a process flow diagram for a typical ozonation process.

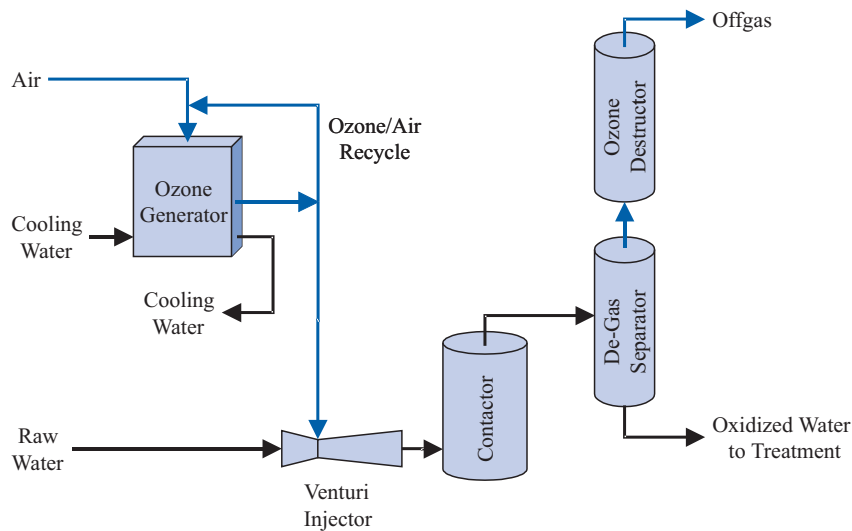

Figure 5-9. Typical Ozonation Process Flow Diagram.

The ozone generator can be sized by taking the flowrate times the ozone dose as shown in the equation:

$$M_{O_3} = \delta_{O_3} \cdot Q \cdot \left( 0.2271 \frac{L}{gal} \cdot \frac{g}{mg} \cdot \frac{min}{hr} \right) \quad \text{Eqn. 5-10}$$

Where:

$M_{O_3}$  = Ozone Mass Flow (g/h  $O_3$ )

$\delta_{O_3}$  = Ozone Dose (mg/L) and

$Q$  = Design Flowrate (gpm).

Figure 5-10 shows an ozone generator that will produce up to 35 g/h (583 mg/min) of ozone.



Figure 5-10. Ozone Generator and Contactor (ProMinent).

## 5.4 Solid Phase Oxidant Pre-Oxidation Design Considerations

Filox-R™ is a solid, granular manganese dioxide media typically used to remove iron and manganese from drinking water. FiloxR™ media has also been shown to effectively catalyze the oxidation of As(III) to As(V) using dissolved oxygen.

For most ground water sources, the dissolved oxygen content will be very low. Oxygen may need to be added depending upon the concentrations of interfering reductants. An alternative to adding oxygen is to increase the empty-bed contact time (EBCT) to overcome the interfering reductants. If oxygen addition is selected, it can be done by injecting air into the water stream using a venturi air injector as shown below in process flow diagram Figure 5-11. Figure 5-12 shows the schematic of an air injection assembly. The water and air are allowed to mix for a short period of time and then the undissolved gasses are removed from the water by a degassing unit. The oxygenated water then flows downward through a column of FiloxR™ media.

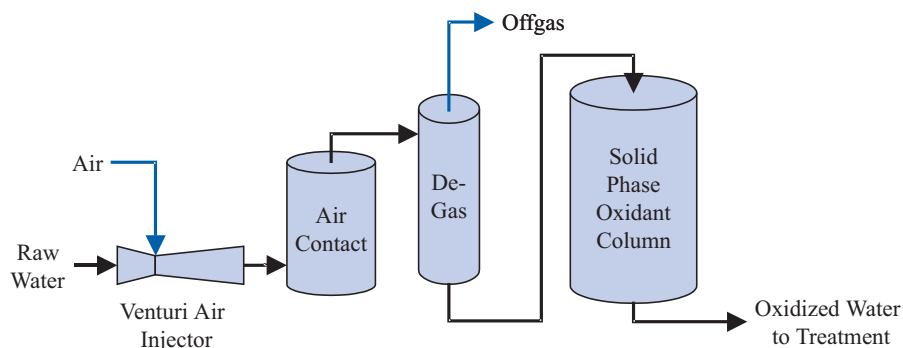

Figure 5-11. Typical Solid Phase Oxidant Arsenic Oxidation Process Flow Diagram.



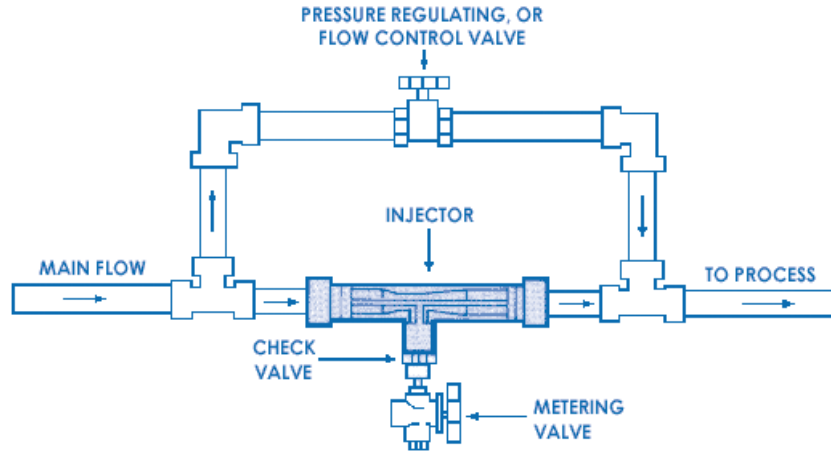

Figure 5-12. Venturi Air Injector Assembly Schematic (Mazzei).

Careful consideration should be given to the dissolved oxygen dose estimate. Most waters contain substances other than As(III) that exert oxidant demand. Section 2.2.4 lists the oxygen demand for the stoichiometric conversion of As(III),  $\text{Fe}^{2+}$ ,  $\text{Mn}^{2+}$ , and  $\text{HS}^-$ . FiloxR™ may also catalyze oxidation with TOC. The ultimate ozone demand is the sum of all these factors. The applied dose should be at least ten times larger than the ultimate oxygen demand as seen in the equation below. Some test runs by Ghurye and Clifford with interfering reductants used as much as 65 times the stoichiometric oxygen demand (Ghurye and Clifford, 2001).

$$\delta_{\text{O}_2} = 10 \cdot D_{\text{O}_2} \quad \text{Eqn. 5-11}$$

Where:

- $\delta_{\text{O}_2}$  = Oxygen Dose (mg/L) and
- $D_{\text{O}_2}$  = Ultimate Oxygen Demand (mg/L).

The EBCT is the other important design criteria for a solid-phase oxidant system. Tests using FiloxR™ were successful with EBCTs of 1.5 minutes. If oxygen was not present in 10 to 65 times the stoichiometric demand, EBCTs of 6 minutes were required. (Ghurye and Clifford, 2001).

Typical hydraulic loading rates for Filox-R™ systems are 10 to 20 gpm/sft. Given this and the EBCT, the height of the Filox-R™ bed can be determined using the equation:

$$Z \geq \text{HLR} \cdot \text{EBCT} \cdot \left( \frac{\text{cft}}{7.48 \text{ gal}} \right) \quad \text{Eqn. 5-12}$$

Where:

- Z = Depth of Media (ft),
- HLR = Hydraulic loading rate (gpm/sft), and
- EBCT = (Minimum) Empty Bed Contact Time (min).

Additional typical design and operating parameters for a Filox-R™ system are given in Table 5-1.

**Table 5-1. Typical Filox-R™ Design and Operating Parameters.**

Parameter	Value	Units
Bulk Density Filox-R™ <sup>1</sup>	114	lbs/cft
Freeboard <sup>1</sup>	30-50%	
Filox-R™ Media <sup>1</sup>	≥ 20	in.
Hydraulic loading rate <sup>2</sup>	10-20	gpm/sft
Empty Bed Contact Time <sup>3</sup>	1.5-6.0	min.
Minimum Backwash Flowrate <sup>1</sup>	12-15	gpm/sft

<sup>1</sup> Recommendation by Matt-Son, Inc., *Filox-R™ Media*, Form No. FXR-01.

<sup>2</sup> Recommendation by Matt-Son, Inc., *Filox-R™ Media*, Form No. FXR-06.

<sup>3</sup> Ghurye and Clifford, 2001.

## 5.5 Comparison of Pre-Oxidation Alternatives

Table 5-2 provides a review of issues pertinent to the five pre-oxidation methods previously discussed.

**Table 5-2. Comparison of Pre-Oxidation Alternatives.**

Criteria	Liquid Sodium Hypochlorite System	On-Site Hypochlorite Generation System	Permanganate Solution Feed System	Ozone Generation	Solid Oxidant System
Safety and Regulatory Issues	<ul style="list-style-type: none"> <li>HazMat regulations for safety and handling apply.</li> <li>Potential for corrosive vapors in the presence of moisture.</li> <li>Emergency response plan required with local fire department.</li> <li>Secondary containment required.</li> </ul>	<ul style="list-style-type: none"> <li>Below 1% threshold for hazardous classification.</li> <li>Exempt from HazMat regulations.</li> <li>No secondary containment requirements.</li> </ul>	<ul style="list-style-type: none"> <li>Solid permanganate poses dust and inhalation hazard.</li> </ul>	<ul style="list-style-type: none"> <li>Poisonous and reactive gas.</li> </ul>	<ul style="list-style-type: none"> <li>None.</li> </ul>
Space Requirements	<ul style="list-style-type: none"> <li>Space requirements are small, assuming the Uniform Fire Code (UFC) exempt criteria are met.</li> </ul>	<ul style="list-style-type: none"> <li>Space requirements are large. There must be room for salt storage, brine tanks, hypochlorite holding tanks, electrolytic equipment, as well as instrumentation &amp; control and power.</li> </ul>	<ul style="list-style-type: none"> <li>Space requirements are small. Additional space may be required for storage of solid permanganate.</li> </ul>	<ul style="list-style-type: none"> <li>Space requirements are small.</li> </ul>	<ul style="list-style-type: none"> <li>Space requirements are small.</li> </ul>
Chemical Characteristics	<ul style="list-style-type: none"> <li>5¼ or 12½% sodium hypochlorite solution. Degrades over time.</li> <li>Decay of solution creates chlorate byproduct.</li> <li>Increases pH of water slightly.</li> </ul>	<ul style="list-style-type: none"> <li>Stable sodium hypochlorite solution (0.8%).</li> <li>Constant application concentration.</li> <li>Chlorate formation low to none.</li> <li>Increases pH of water slightly.</li> </ul>	<ul style="list-style-type: none"> <li>Stable permanganate solution, generally 3-4%.</li> <li>Reacts rapidly with dissolved organics.</li> </ul>	<ul style="list-style-type: none"> <li>Gas.</li> <li>Very strong oxidizer.</li> </ul>	<ul style="list-style-type: none"> <li>Solid.</li> <li>Requires dissolved oxygen in the water.</li> </ul>
Chemical Delivery	<ul style="list-style-type: none"> <li>Liquid hypochlorite delivered by tanker truck, 55-gal drum, or 5-gal pail.</li> </ul>	<ul style="list-style-type: none"> <li>Salt delivered in 50-lb bags or 2000-lb totes.</li> </ul>	<ul style="list-style-type: none"> <li>Solid permanganate available in 25-kg pails, 50-kg kegs, and 150-kg drums.</li> </ul>	<ul style="list-style-type: none"> <li>N/A</li> </ul>	<ul style="list-style-type: none"> <li>N/A</li> </ul>
Labor	<ul style="list-style-type: none"> <li>Periodic delivery.</li> <li>Dilution procedures.</li> </ul>	<ul style="list-style-type: none"> <li>Salt delivery.</li> <li>Weekly loading of salt into brine tank.</li> </ul>	<ul style="list-style-type: none"> <li>Load dry feeder.</li> <li>Dilution procedures.</li> </ul>	<ul style="list-style-type: none"> <li>N/A</li> </ul>	<ul style="list-style-type: none"> <li>N/A</li> </ul>
Operation and Maintenance	<ul style="list-style-type: none"> <li>Low day-to-day O&amp;M. Long-term material maintenance could be a problem because of corrosive effects of liquid hypochlorite.</li> </ul>	<ul style="list-style-type: none"> <li>Moderate O&amp;M, mainly associated with salt handling. Change electrode cells every five years.</li> </ul>	<ul style="list-style-type: none"> <li>Low day-to-day O&amp;M for automated systems.</li> <li>Stains everything purple.</li> </ul>	<ul style="list-style-type: none"> <li>Low day-to-day O&amp;M.</li> </ul>	<ul style="list-style-type: none"> <li>Low day-to-day O&amp;M.</li> </ul>
Off-Normal Operation	<ul style="list-style-type: none"> <li>A temporary bleach solution can be mixed in the storage tank.</li> </ul>	<ul style="list-style-type: none"> <li>A temporary bleach solution can be mixed in the day tank.</li> </ul>	<ul style="list-style-type: none"> <li>N/A</li> </ul>	<ul style="list-style-type: none"> <li>N/A</li> </ul>	<ul style="list-style-type: none"> <li>N/A</li> </ul>
Community Relations	<ul style="list-style-type: none"> <li>HazMat signage required.</li> </ul>	<ul style="list-style-type: none"> <li>No HazMat regulations. Hydrogen byproduct vented to atmosphere.</li> </ul>	<ul style="list-style-type: none"> <li>N/A</li> </ul>	<ul style="list-style-type: none"> <li>N/A</li> </ul>	<ul style="list-style-type: none"> <li>N/A</li> </ul>

This page intentionally left blank.

# Section 6

## Sorption Process Design Considerations

This section describes the design of sorptive processes, including AA, modified AA, IBS, and IX. For reasons previously cited, the discussion about AA, modified-AA, and IBS are restricted to non-regenerable applications. Conversely IX is most economically feasible when used in a regenerable process.

### 6.1 Process Flow

Despite the availability of several different types of sorptive treatment processes, the overall treatment approach for each is similar. Pre-treatment can consist of oxidation, to convert As(III) to As(V), and pre-filtration stages when turbidity is high, as well as optional pH adjustment and pre-filtration backwash. Next, the water is fed through a column packed with sorptive media. Post-treatment consists of an optional pH re-adjustment stage and some media have an option for regenerating the media. Typically, the entire process is carried out under pressure. Figure 6-1 shows a typical sorption treatment process while Figure 6-2 shows the same flow diagram with the optional media regeneration and pH adjustment and re-adjustment. Dashed lines and boxes indicate optional streams and processes.

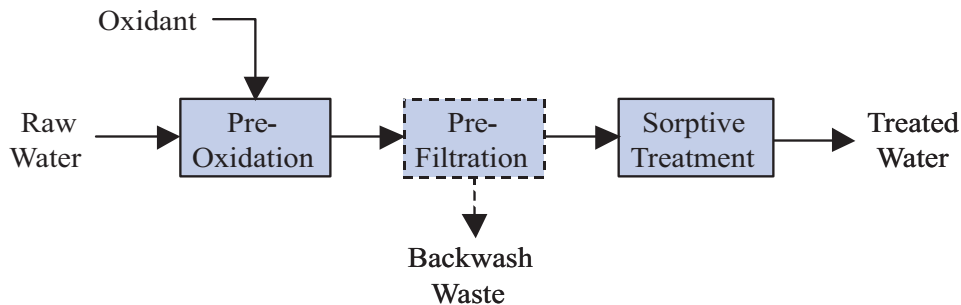

Figure 6-1. Sorption Treatment Process Flow Diagram w/o pH Adjustment and Regeneration.

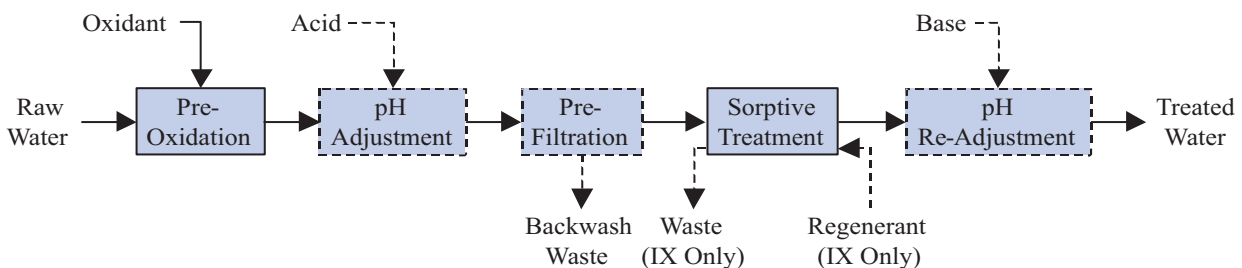

Figure 6-2. Sorption Treatment Process Flow Diagram w/ pH Adjustment and Regeneration.

Pre-filtration is strongly recommended when the source water turbidity is above 0.3 NTU. Suspended solids in the feed water can clog sorption sites and impair process hydraulics. One prefiltration option for smaller systems is backwashable cartridge filters.

The performance of AA treatment is highly pH-sensitive. Treatment conducted under acidic conditions (pH 5.5-6.0) can be expected to produce run lengths 5 to 20 times longer than treatment conducted under natural pH conditions. As a result, in the decisions trees in Section 3, conventional AA is only recommended over IBS when the pH is naturally low or the system is willing to adjust the pH below 6.0. In most cases, pH adjustment will require chemical addition of a strong acid, such as sulfuric ( $H_2SO_4$ ) or hydrochloric (HCl) acid. Dose requirements depend on the background pH and buffering capacity of the water.

## 6.2 Column Rotation

Sorption processes are conducted using two or more columns in series. The first column in the treatment process is referred to as the roughing column, and the last sorption column is referred to as the guard column. Frequently, there is an additional column on standby. The roughing column serves as the primary arsenic removal column. The guard column is intended to capture arsenic breakthrough as soon as it occurs from the roughing column.

The columns are operated in this manner until arsenic breakthrough of the roughing column occurs, which is detected by periodic grab samples. Breakthrough is generally defined as the time when the effluent arsenic concentration is equal to 50% of the feed water arsenic level. However, this number can be adjusted after piloting or operation to optimize the economics of the process. At this point, adsorptive sites on the roughing column have become saturated and the column should be taken off-line for media replacement or regeneration, after which it is placed in standby mode to wait for the next column rotation. The guard column is then promoted to the roughing column position and the standby column becomes the guard column in the series. Figure 6-3 illustrates how the columns' positions are rotated between roughing, guard, and standby operation modes.

The number of columns to be placed in series depends on the estimated lifetime of each column and the desired monitoring and media change-out or regeneration frequency. IX processes operating with sulfate in the feed may have a sulfate roughing column at the head of the operation to remove sulfate before arsenic is removed by the arsenic roughing column.

Typically two parallel process trains are used. This provides operational redundancy and, by staggering their operation, chromatographic peaking may be reduced.

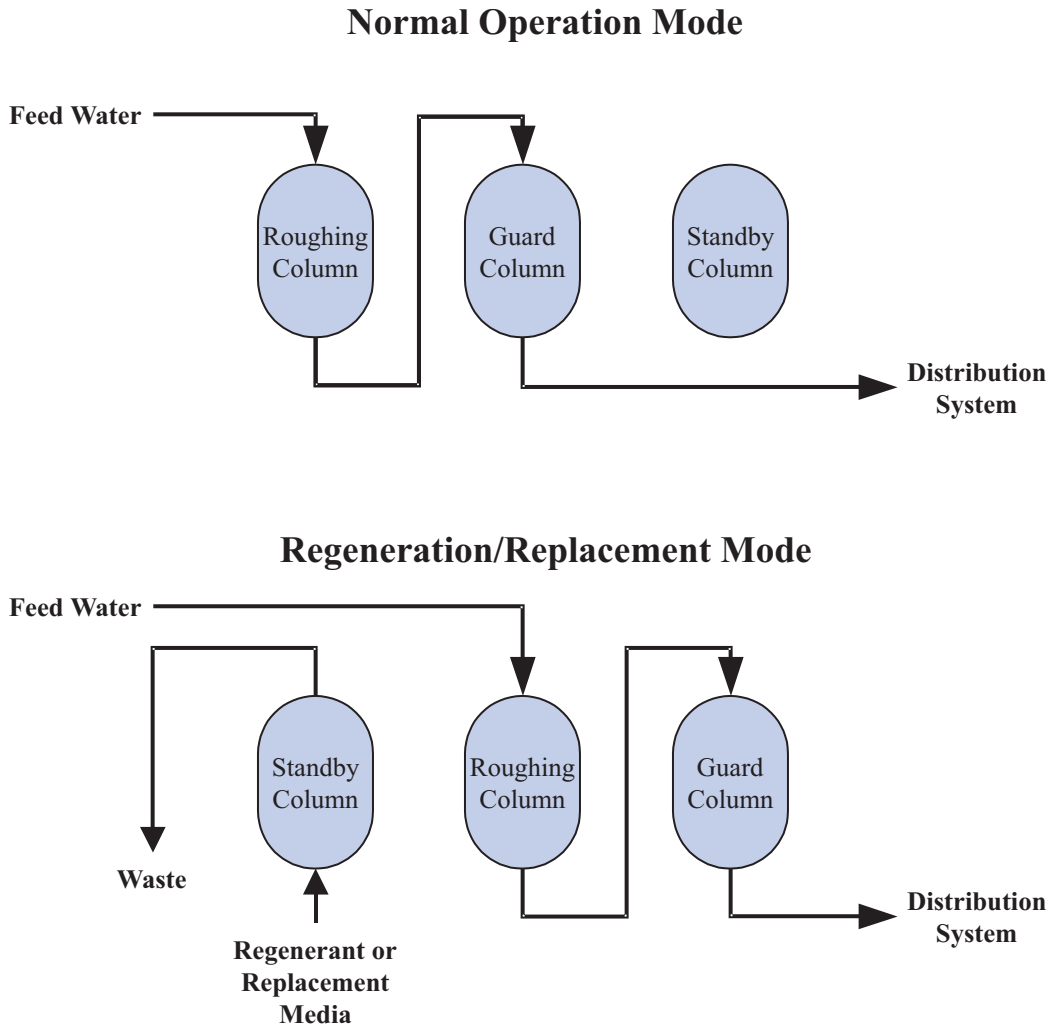

Figure 6-3. Sorption Column Operation Modes.

### 6.3 Sorption Theory

To understand operation of sorption processes, it is important to understand fundamental ion exchange theory. An important consideration in sorption processes is the mass transfer zone (MTZ), which can be viewed as a wave or a zone of activity (i.e., non-equilibrium between liquid and media phases) for a particular contaminant. As depicted in Figure 6-4, the MTZ also represents the front of the exhaustion zone for a particular contaminant. Exhaustion zones and MTZ waves are typically considered for the target contaminant (i.e., arsenic) and any species that have a higher exchange affinity for the media. Arsenic must compete with other anions for exchange sites according to the selectivity sequence for the particular media (see Section 2). Previously sorbed arsenic can be displaced by anions of higher selectivity. Exhaustion and MTZs order themselves according to the selectivity sequence, as illustrated in Figure 6-4. Other sorbed contaminants, such as carbonate ( $\text{CO}_3^{2-}$ ) and nitrate ( $\text{NO}_3^-$ ), would be present further down from the As(V) MTZ.

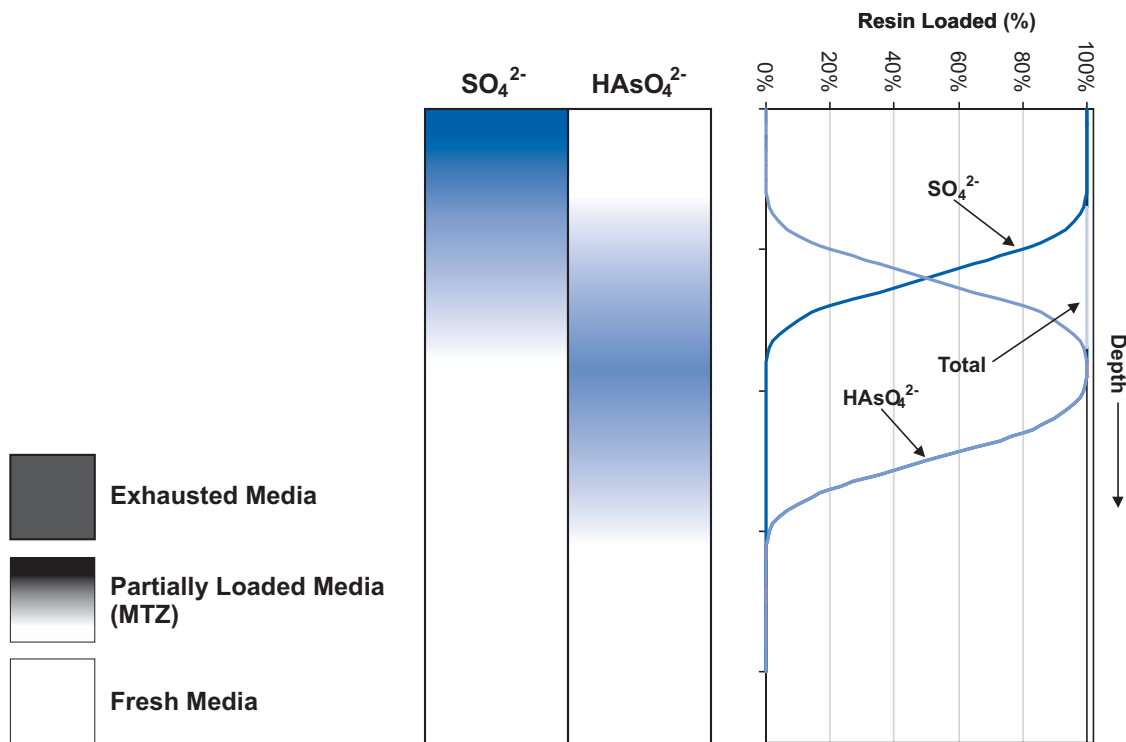

Figure 6-4. Multi-Component Ion Exchange.

### 6.3.1 Non-Regenerated Sorption Processes

For the purpose of this Handbook, processes utilizing AA, modified-AA, or IBS media are referred to as non-regenerated sorption treatment. These technologies are most applicable to small utilities when used as a one-time application with subsequent media disposal and replacement.

Processes utilizing conventional AA function best when the solution pH is less than 6.0. At this pH, the hydroxide ( $\text{OH}^-$ ) concentration is less than 0.2 mg/L. Since this is at least an order-of-magnitude less than the arsenic concentration, hydroxide provides little competition against arsenic for exchange sites. There are several types of modified-AA that have demonstrated enhanced arsenic removal performance under natural pH conditions (6.0-9.0) but these were not designated as BATs by the USEPA when the rule was promulgated.

IBS treatment has been described as chemisorption (Selvin et al., 2000), which is typically considered to be irreversible. Therefore, although phosphate and arsenic compete for sorption sites, neither has the ability to displace the other. In this instance, there is a single exhaustion zone and MTZ comprised of both As(V) and phosphate contaminants.

### 6.3.2 Ion Exchange Processes

As(V) can be removed through the use of SBA in either chloride or hydroxide form, although the former is more commonly used for drinking water applications. The expense



and low capacity of IX resin generally renders it uneconomical for one-time application and disposal. Instead, periodic regeneration should be applied to restore the exchange capacity of the resin.

Figure 6-4 illustrates a resin-phase loading profile down an IX column for treatment of hypothetical natural water containing arsenic and sulfate. As arsenic is exchanged with anions on the SBA, the arsenic band develops and its MTZ moves downward. The same phenomenon is true for sulfate ions. However, because of its higher exchange affinity, sulfate anions displace the arsenic, thereby forcing the arsenic-exhausted region and the arsenic MTZ downward further.

An important consideration in the application of IX treatment is the potential for chromatographic peaking of nitrate ( $\text{NO}_3^-$ ) and nitrite ( $\text{NO}_2^-$ ). These contaminants pose an acute health risk, and as such are regulated under the SDWA with primary MCLs of 10 mg/L (as N) and 1 mg/L (as N), respectively. According to the selectivity sequence provided in Section 2.3.1, nitrate and nitrite will also replace chloride on exchange sites, although with less preference than As(V) or sulfate. As a result, the region of nitrate and nitrite activity will reside further down the column (relative to the activity of sulfate and As(V)), as illustrated in Figure 6-5. These species will chromatographically peak before As(V), and this peaking could produce water that does not meet the aforementioned MCLs. Utilities with source water with measurable quantities of nitrite or nitrate should be aware of this phenomenon and plan column operation to avoid this occurrence.

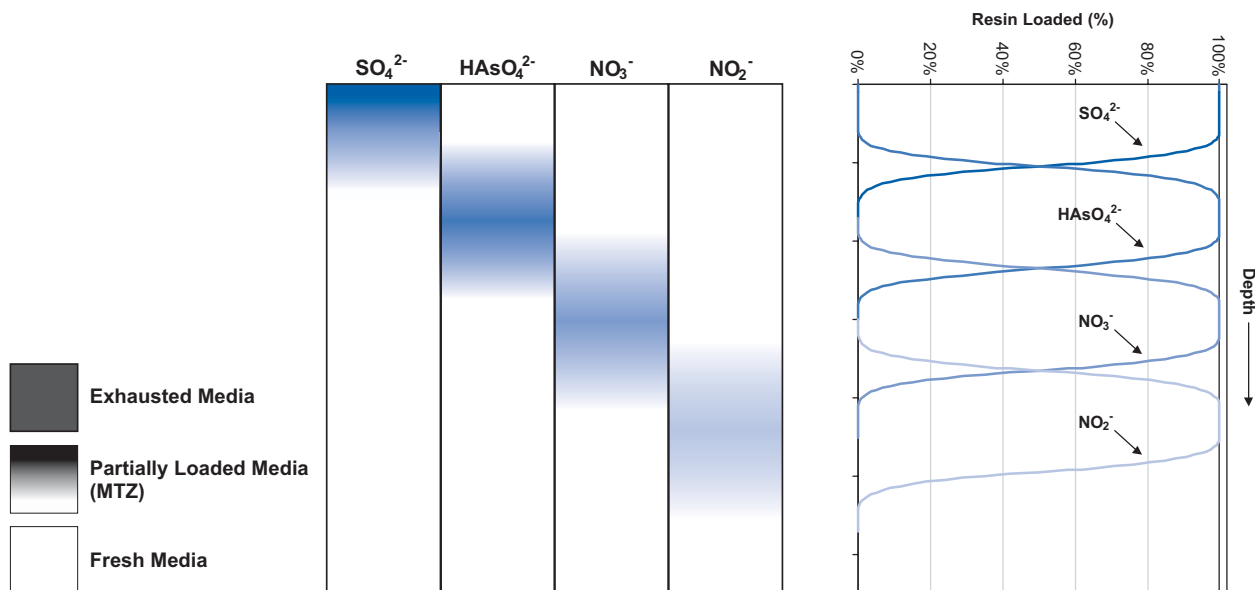

Figure 6-5. Activity of Nitrate and Nitrite During Ion Exchange.

The removal of carbonate ( $\text{CO}_3^{2-}$ ) by IX resin can also lead to a pH drop of 0.5 to 1.0 units, particularly at the beginning of a run. This impact can be minimized by post-treatment addition of soda ash or caustic soda or by sequencing the regenerative cycles of parallel process trains. Pilot testing is recommended to evaluate the impact on pH for the specific water in question.

## 6.4 Process Design & Operational Parameters

Design and operational parameters for sorption treatment processes vary significantly depending on the specific technology chosen, and to a lesser degree on the media type. The most appropriate way to identify the optimal engineering parameters for a particular treatment application is to conduct on-site pilot column studies with the media of interest.

Regenerable IX processes involve three operating modes: (1) Loading; (2) Regeneration; and (3) Rinsing. Loading can be conducted with flow in either the downward or upward direction, although the former is more common in water treatment applications. Once the column is fully loaded it should be taken off-line. The next step is regeneration with concentrated brine for chloride-based SBA, which can be conducted in either the downward or upward direction. The latter case is generally more effective, although care must be taken to prevent fluidization of the media. Prior to returning the column to service, water rinsing should be conducted to displace regenerant solution from the column. Slow rate and fast rate rinsing should be conducted in sequence, with each displacing about 2-3 bed volumes of solution per column.

Table 6-1 details key design and operational parameters for AA, IBS, and IX processes. As described in Section 2, non-regenerable AA and IBS process are recommended for small utilities. Therefore, rinsing and regeneration data is only provided for ion exchange processes.

**Table 6-1. Typical Sorption Treatment Design and Operating Parameters.**

Parameter	IX	AA	IBS	Units
<b>Media Bulk Density</b>	40-44	40-47	72-75	lbs/cft
<b>Minimum Column Layers</b>				
Freeboard	90% <sup>1,2</sup>	50% <sup>3</sup>	50%	-
Media	36-60 <sup>2</sup>	36-60 <sup>3</sup>	32-40	in.
<b>Operating Conditions</b>				
Hydraulic Loading Rate	8-12 <sup>2</sup>	4-9 <sup>3</sup>	5-8	gpm/sft
Empty Bed Contact Time	1.5-5	5 <sup>3</sup>	5-10	min.
Downflow Pressure Drop <sup>4</sup>	0.7-1.3 <sup>2</sup>	0.1 <sup>6</sup>	N/A	psi/ft
Maximum Pressure Differential	14	5	3.5	psi
<b>Backwash Conditions</b>				
Backwashing Flow Rate	3-4 <sup>2</sup>	7 <sup>3</sup>	-	gpm/sft
Backwashing Duration	5-20 <sup>2</sup>	10 <sup>3</sup>	-	min
<b>Regeneration Conditions</b> <sup>1</sup>				
Brine Strength	6-10 <sup>2</sup>	-	-	wt%
Downflow Rate	2-6	-	-	gpm/sft
Regenerant Volume	20 <sup>2</sup>	-	-	gal/cft resin
<b>Rinsing Conditions</b>				
Slow Rinse Rate	0.4-4	-	-	gpm/sft
Fast Rinse Rate	2-20	-	-	gpm/sft
Displacement Requirements	4-6	-	-	bed volumes

<sup>1</sup> This will be very resin specific. Check with the resin manufacturer before design.

<sup>2</sup> Rubel, 2001a Draft.

<sup>3</sup> Rubel, 2001b Draft.

<sup>4</sup> This depends on temperature, type of media, and hydraulic loading rate.

<sup>5</sup> For strong base anion exchange resin at 70°F and 10 gpm/sft.

<sup>6</sup> For AA at 2 gpm/sft.

N/A - Not Available.

## 6.5 Column Design

The vessels should be made from typical, well-known materials of construction such as carbon steel or fiberglass and must be NSF approved. The vessels should have distribution and collector systems that provide a uniform distribution of fluids during all phases of the operation. More detail on these accessories is provided in Section 7. Also, it is advisable to install sight-glasses in order to check resin levels.

Columns placed in series are referred to as a treatment train. The utility should evaluate the number of parallel treatment trains based on the desired redundancy and state design standards. Figure 6-6 shows a commercially available multiple-column IX treatment train.



Figure 6-6. Ion Exchange System (Tonka Equipment Company).

### 6.5.1 Column Diameter

Once the number of parallel treatment trains has been established, column diameter can be calculated based on the recommended hydraulic loading rate of the particular media and the design flowrate. Hydraulic loading rate is the flowrate per unit of cross-sectional area and is proportional to the linear velocity of the fluid through the bed. Recommended maximum hydraulic loading rates are provided in Table 6-1. Column diameter (D) can be calculated using the equation:

$$D = \left( \frac{4 \cdot Q}{\pi \cdot n_p \cdot \text{HLR}} \right)^{0.5} \quad \text{Eqn. 6-1}$$

Where:

- D = Column Diameter (ft),
- Q = Design Flowrate (gpm),
- $n_p$  = Number of Parallel Treatment Trains, and
- HLR = Hydraulic loading rate (gpm/sft).

The benefits of lower hydraulic loading rates include a sharper MTZ and potentially better media utilization. However, a lower hydraulic loading rate also translates into a larger column footprint.

Consider an example where IX will be used to treat a design flowrate of 70 gpm. The utility has decided to provide no parallel treatment trains. Based on a recommended maximum hydraulic loading rate of 10 gpm/sft, the column diameter should be 3 feet.

$$D = \left( \frac{4 \cdot 70 \text{ gpm}}{\pi \cdot 1 \cdot 10 \text{ gpm/sft}} \right)^{0.5} = 3 \text{ ft}$$

### 6.5.2 Column Height

The depth of sorptive media required can be calculated based on the selected hydraulic loading rate and consideration of the minimum empty bed contact time. Values of EBCT are provided in Table 6-1.

$$Z \geq \text{HLR} \cdot \text{EBCT} \cdot \left( \frac{\text{cft}}{7.48 \text{ gal}} \right) \quad \text{Eqn. 6-2}$$

Where:

- Z = Depth of Sorptive Media (ft),
- HLR = Hydraulic loading rate (gpm/sft), and
- EBCT = (Minimum) Empty Bed Contact Time (min).

Returning to the previous example, suppose the specific resin selected had a minimum EBCT of 3 minutes. The total depth of sorptive media required for the primary treatment columns would be 4 feet.

$$Z = \left( 10 \frac{\text{gpm}}{\text{sft}} \right) \cdot (3 \text{ min}) \cdot \left( \frac{\text{cft}}{7.48 \text{ gal}} \right) = 4 \text{ ft}$$

The depth of sorptive media (Z) should then be used in conjunction with the column freeboard to determine column height. For ease of change-out, all columns should be sized similarly.

$$H = Z \cdot (1 + F) \quad \text{Eqn. 6-3}$$

Where:

- H = Column Height (ft),
- Z = Depth of Sorptive Media (ft), and
- F = Freeboard Allowance (% expressed as a decimal).

For the previous example, if the freeboard requirement was 50% of media depth, the column height should be 6 feet.

$$H = (4 \text{ ft}) \cdot (1 + 0.5) = 6 \text{ ft}$$

Therefore, for this particular example, the design should include a single treatment train consisting of three columns (i.e., roughing, guard, and standby). All columns should be 3 feet in diameter by 6 feet tall and contain 4 feet of media. The process flow diagram for this example is provided as Figure 6-7.

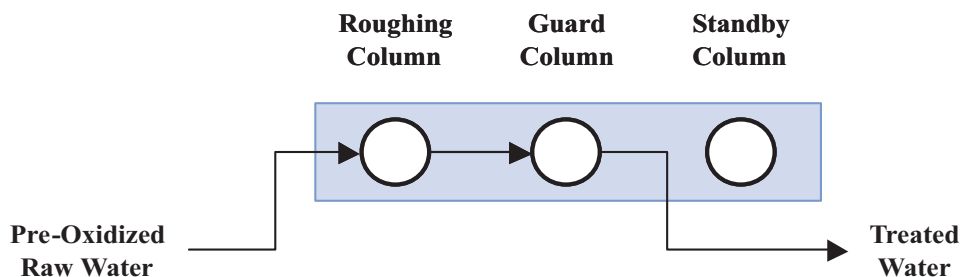

Figure 6-7. Process Flow Diagram for Example Problem.

The following constraints should also be considered:

- Small column aspect ratios (i.e., H:D <1) can lead to flow maldistribution.
- Large column heights can lead to excessive pressure drop.
- The available building footprint.
- The available building height.

## 6.6 Media Replacement Frequency

It is advantageous for a utility to obtain a rough estimate of the optimal operating time until media exhaustion occurs. This is important for establishing an appropriate O&M and monitoring schedule. The optimal filter run time until media exhaustion can be calculated as:

$$\tau = BV_e \cdot EBCT \cdot \left( \frac{\text{hr}}{60 \text{ min}} \right) \quad \text{Eqn. 6-4}$$

Where:

- $\tau$  = Optimal Filter Run Time (hr),
- $BV_e$  = Number of Bed Volumes to Exhaustion, and
- EBCT = Empty Bed Contact Time (min).

The roughing column should be operated until 50% arsenic breakthrough occurs. Therefore, the actual filter run time will be less than the calculated optimal filter run time (t). The deviation will depend on the efficiency of the sorption/exchange process and the width of the MTZ.

Consider an example where the estimated lifetime of a particular combination of media and raw water was 1,357 BV. If the columns are sized to provide an EBCT of 3 minutes, the optimal run time until media exhaustion is 68 hours.

$$\tau = (1,357 \text{ Bed Volumes}) \cdot (3 \text{ min}) \cdot \left( \frac{\text{hr}}{60 \text{ min}} \right) = 68 \text{ hr}$$

## 6.7 Regeneration of Ion Exchange Resin

IX resins are essentially unusable for arsenic removal unless they can be efficiently regenerated. Because of the high selectivity of SBA for sulfate ( $\text{SO}_4^{2-}$ ), the exchange capacity would be exhausted within a few days for many natural waters. The cost of the virgin resin is far too great to dispose of it at that time.

Chloride-based SBA can be regenerated with concentrated brine (1-5 mole/L) in either the upflow or downflow mode. The more concentrated the regenerant solution, the greater the fraction of the bed that is regenerated. It should be noted, however, that regeneration efficiencies are generally less than 100%. Therefore, successive runs can be expected to be slightly shorter in duration.

Utilities should consider the size of the brine holding tank, as they are typically much larger than the IX columns themselves. Based on previous studies (AwwaRF, 2000), roughly 4 BVs of spent brine are produced per regeneration. The regeneration duration can be calculated as:

$$t_R = \frac{Z}{G_R} \cdot \left( 7.48 \frac{\text{gal}}{\text{cft}} \right) \cdot (4 \text{ BV}) \quad \text{Eqn. 6-5}$$

Where:

$t_R$  = Regeneration Duration (min),  
 $Z$  = Depth of Sorptive Media (ft/BV), and  
 $G_R$  = Regeneration Flux (gpm/sft).

Following regeneration, this brine can either be disposed of via indirect discharge (assuming local TBLLs are met) or stored for recycle. In the case of recycle, it may be necessary to add salt to bring the strength of the brine back to the range 15 mole/L.

For a conventional IX process, spent regenerant will contain arsenic and sulfate in a ratio approximately corresponding to their relative concentration in the raw water. If the water contains a moderate amount of competing ions, it is possible that the brine waste will contain less than 5.0 mg/L of arsenic, and thus will not exceed the TC values. However, in most instances, the liquid waste stream will contain more than 5.0 mg/L of arsenic. This will force utilities to consider disposal and waste treatment options. If indirect discharge to a local POTW is the waste disposal method chosen, a spent brine holding tank may be required in order to slowly release the spent brine to the POTW.

Rinsing with water is typically conducted after regeneration to flush out residual brine and prepare the column for normal operation. Generally 4 to 6 BV of rinse water are used per regeneration. This waste may be added with the brine waste being sent to the POTW.

IX resin typically lasts 4-8 years before chemical and mechanical degradation necessitates media replacement.

## 6.8 Waste Handling Systems

This section addresses three types of waste: backwash water from pre-filters, spent regenerant, and spent media.

The two most probable methods for disposal of backwash water from pre-filters are indirect disposal through a POTW or by settling the solids, recycling supernatant, and sending the solid sludge to a landfill.

Regarding brine used in IX regeneration, there are two waste disposal options. Spent brine that contains less than 5.0 mg/L of arsenic can either be disposed of via indirect discharge or treated on-site. The feasibility of indirect discharge of regenerant waste will be dictated by local TBLLs for TDS. The concentration of TDS in the spent regenerant can be approximated as:

$$C_{\text{TDS}} = \left( 58.4 \frac{\text{g NaCl}}{\text{mole}} \right) \cdot \bar{M}_{\text{Brine}} \quad \text{Eqn. 6-6}$$

Where:

$C_{\text{TDS}}$  = Concentration of Total Dissolved Solids (g/L) and  
 $\bar{M}_{\text{Brine}}$  = Brine Molarity (mole/L).

When indirect discharge is not an option, the system must deal with the waste on-site. The most common approach for treating brine waste (containing less than 5.0 mg/L of arsenic) is chemical precipitation with iron-based salts and subsequent solids thickening. Thickening can be conducted using a settling basin, or for more rapid results, mechanical dewatering equipment. The brine decant can then be sent to an evaporation pond.

Spent brine used in the regeneration of arsenic-laden resin may be classified as hazardous. Therefore, manipulating the chemical form of the waste on-site constitutes treatment of a hazardous waste, which has extensive permit and cost implications. As a result, when the brine waste stream contains over 5.0 mg/L of arsenic, indirect discharge to a POTW is considered the only viable option for small utilities. When this option is unavailable, on-site regeneration of arsenic-laden resin should not be performed. Rather, the resin should be disposed of at a municipal solid waste landfill and replaced with fresh resin.

The appropriate disposal method for spent resin is dependant on the results of the TCLP, as described in Section 1.



# Section 7

## Pressurized Media Filtration Process Design Considerations

This section describes the design of a typical pressurized granular-media filtration system including sand filtration and iron and manganese oxidation/filtration systems. Although the following information specifically describes a pressurized greensand filter, it can be applied to any pressurized granular media filtration system.

### 7.1 Process Flow

In a typical media filtration process, seen in Figure 7-1, the raw water is first put through a pre-oxidation step. Dashed lines and boxes indicate optional streams and processes. If the preoxidant is chlorine, potassium permanganate, or ozone, the As(III) and any natural iron will be oxidized to As(V) and Fe III respectively. If, however, aeration (aeration tower) is used for iron oxidation, the air oxidation process will not oxidize As(III) to As(V) and the addition of a chemical preoxidant would be required. If greensand is being used as the filter media, potassium permanganate and chlorine also provides the oxidant for the continuous regeneration of the greensand media.

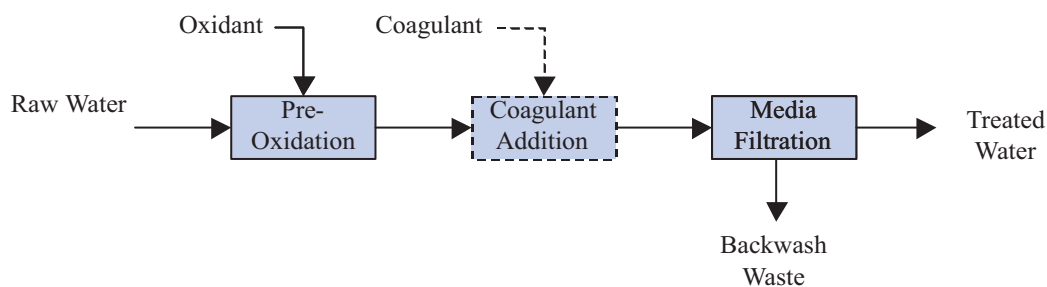

Figure 7-1. Typical Media Filtration Process Flow Diagram.

It should be noted that, although greensand can be regenerated in either batch or continuous methods, only the continuous regeneration method has been shown to also oxidize the As(III) to As(V) so that arsenic can be removed. Therefore, under most circumstances, only the continuous regeneration method is recommended for arsenic removal.

After pre-oxidation, a coagulant addition step may be necessary if the iron concentration or the Fe:As ratio is low. Next, the water is passed through filters containing granular media before being sent to the distribution system. Typically, three or more filters are provided in parallel.

Media filters are operated in three different modes: (1) Filtration; (2) Backwash; and (3) Filter-To-Waste (FTW). In the operating mode, all filters are fed in parallel with flow in the downward direction. The effluent is sent to the distribution system as shown in Figure 7-2.

After some time of operation, solids captured by the filtration media will impede the flow and increase the differential pressure across the filter. To restore hydraulic capacity, the filter will have to be backwashed. The backwash flow is in the upward direction, which fluidizes the granular media and washes the accumulated solids out of the filter. In some instances, air scouring is conducted prior to fluid backwashing. Air scouring bubbles large volumes of air upward through the filter. This assists in breaking apart conglomerates of filtered material, allowing the subsequent fluid backwash to more easily remove the captured solids. An air scour also reduces the volume of backwash waste that is generated.

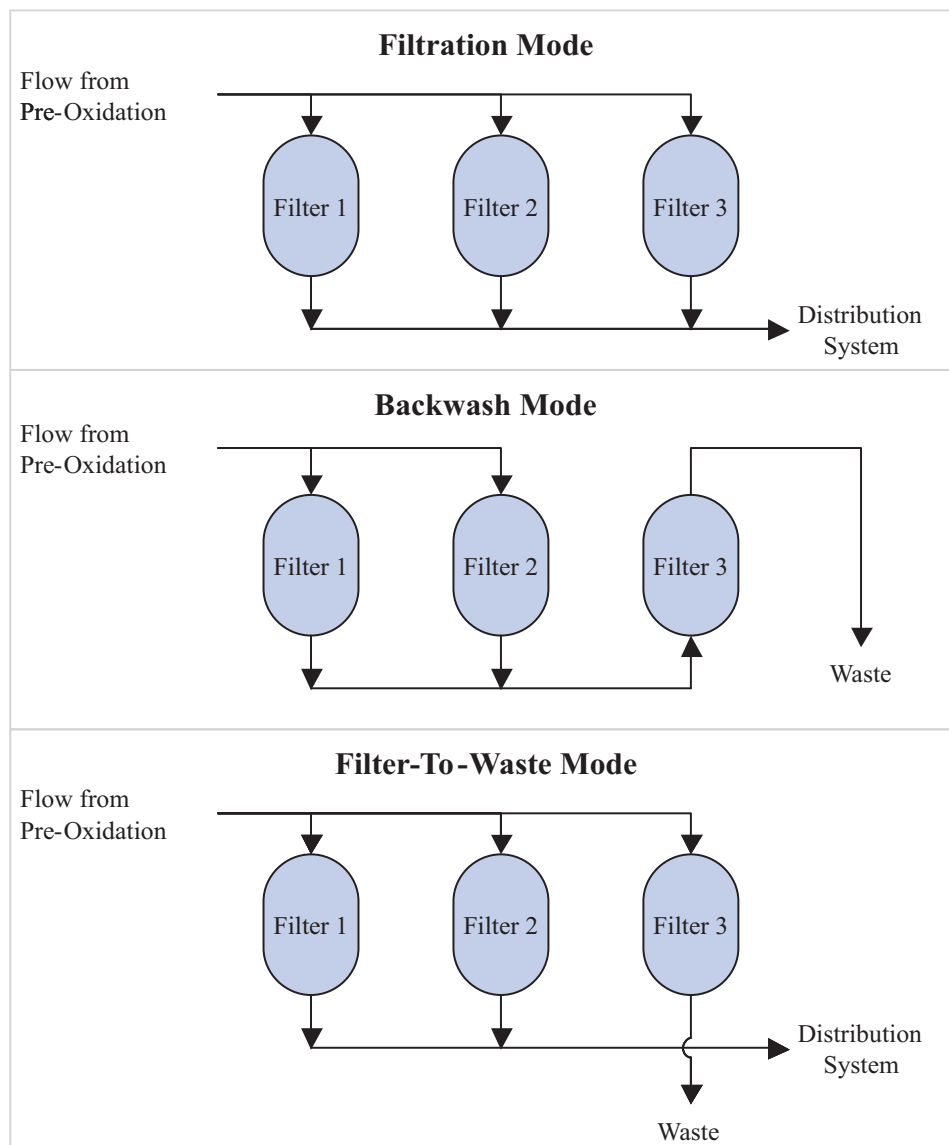

Figure 7-2. Media Filtration Process Flow Modes.

After backwashing, the media is allowed to settle and downward flow is reinstated with the filter effluent going to waste. This re-stratifies the column, setting it up for operation. It also reduces the amount of particulate matter that gets into the distribution system. After the FTW mode, the filter is returned to standard operation.

## 7.2 Process Design & Operational Parameters

Table 7-1 lists design and operational parameters typical of media filtration systems.

<b>Table 7-1. Typical Greensand Column Design and Operating Parameters.</b>		
<b>Parameter</b>	<b>Value</b>	<b>Units</b>
<b>Media Bulk Density</b>		
Anthracite Media <sup>1</sup>	50	lbs/cft
Greensand Media <sup>2</sup>	85	lbs/cft
Garnet Media <sup>3</sup>	140	lbs/cft
Support Gravel <sup>4</sup>	100	lbs/cft
<b>Column Layers</b>		
Freeboard <sup>1,2</sup>	50%	of Anthracite and Greensand
Anthracite Media <sup>5</sup>	12-24	in.
Greensand Media <sup>6</sup>	15-24	in.
Garnet Media <sup>3</sup>	4	in.
Support Gravel <sup>4</sup>	18-30	in.
<b>Operational Parameters</b>		
Hydraulic loading rate <sup>7,8</sup>	3-5	gpm/sft
Max Pressure Differential	8-10	psi
<b>Backwash Parameters</b>		
Minimum Backwash Flowrate <sup>2</sup>	12	gpm/sft
Backwash Duration	15	min.
Backwash Frequency	1-7	days
Bed Expansion <sup>2</sup>	40%	minimum
Air Scouring Rate	0.8-2.0	scfm/sft
<b>Filter-to-Waste Parameters</b>		
FTW Hydraulic loading rate	3-5	gpm/sft
FTW Duration	5	min.

<sup>1</sup> Recommendation by Clack Corporation, Anthracite, Form No. 2354.

<sup>2</sup> Recommendation by Clack Corporation, Manganese Greensand, Form No. 2349.

<sup>3</sup> Recommendation by Clack Corporation, Garnet, Form No. 2355.

<sup>4</sup> Recommendation by Clack Corporation, Filter Sand and Gravel, Form No. 2352.

<sup>5</sup> Clack Corporation, Anthracite, Form No. 2354 recommends 10-18 for multimedia filters but may need to be higher depending on iron concentrations.

<sup>6</sup> Clack Corporation, Manganese Greensand, Form No. 2349 recommends 30" but can be lower if used with continuous regeneration.

<sup>7</sup> Clack Corporation, Manganese Greensand, Form No. 2349 recommends 3-5 gpm/sft with 8-10 gpm/sft intermittent flow possible.

<sup>8</sup> Under some circumstances, continuous flowrates of 10 gpm/sft are possible.

## 7.3 Filter Design

Typically, granular-media pressure filters have multiple layers of media selected to maintain a coarse-to-fine grading from the top to bottom of the filter. The coarse, upper layer provides rough filtration and the bulk of the particulate retention while the fine, lower layer provides superior filtration. This scheme allows for longer runs times while maintaining filtration quality. A typical oxidation/filtration filter is shown in cross-section in Figure 7-3.

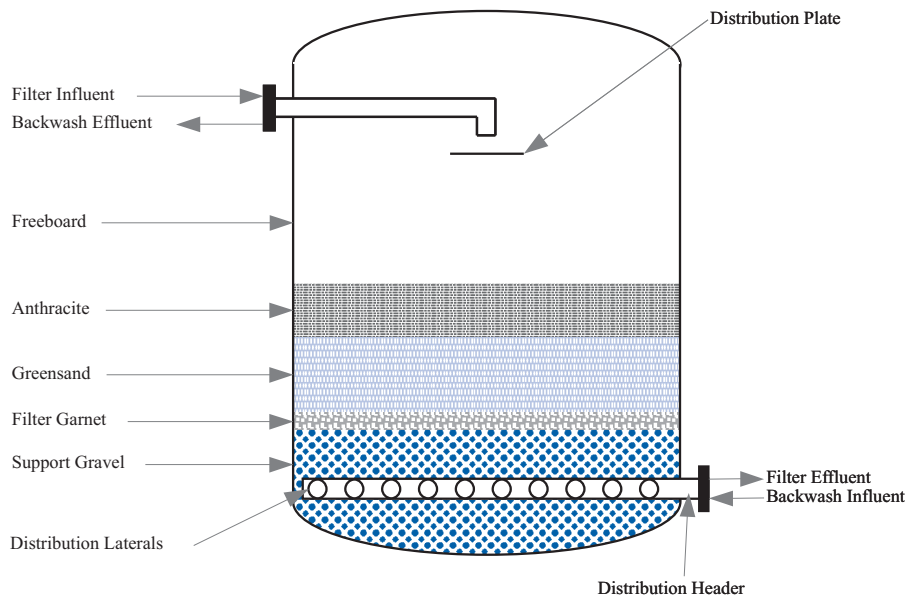

Figure 7-3. Schematic of a Vertical Greensand Pressure Filter.

In the manganese greensand oxidation/filtration process, the primary layer in the filter is made of a media that catalyzes iron and manganese oxidation, promotes its precipitation, and filters out the precipitate. For optimum arsenic removal, continuous chemical preoxidation with either potassium permanganate or chlorine is recommended. Arsenic is removed by the co-precipitation with the iron and, to a lesser degree, the manganese. Greensand, glauconite sand coated with a thin layer of  $MnO_2$ , is the most common of these types of materials.

Because greensand is very fine (16-60 mesh) it is susceptible to being overloaded with solids. To reduce the solids loading on the greensand a layer of filter coal such as anthracite is put on top. This layer also provides an area for the iron floc to coagulate. Because of anthracite's low density, the filter coal will naturally stratify as the top layer after backwash.

In order to keep the greensand from being slurried out the under-drain, a layer of filter garnet is placed below it. This filter garnet has a particle size of 8-12 mesh and a density almost 50% greater than the greensand. This puts the filter garnet below the greensand after stratification.

The bottom layer is support granite, which allows the water to flow easily into the lower distribution system and exit the filter. Because of its larger size, the support granite is not fluidized during backwash. Instead, it assists in distributing the backwash flow evenly throughout the filter.

When the media is backwashed, it will expand 30% to 50%. To accommodate this, the filter is designed with freeboard. Freeboard is the amount of space in the filter between the upper layer of media and the upper distribution manifold. The height of this freeboard is dependent on the height of media but is generally 40-50% of the settled height of the media that undergoes fluidization (i.e., anthracite and greensand in the case of a greensand filter).

Every filter will have an upper and lower distribution manifold. The upper manifold distributes the influent and collects the backwash water. The lower manifold collects filtered water and distributes backwash water. There are numerous designs for these distribution manifolds. Smaller diameter filters may have a distribution plate or a hub-lateral design shown in Figure 7-4. Larger diameter columns may have a header-lateral design, shown in Figure 7-5. The header-lateral design gives a more even distribution of the flow, which is much more important for the lower manifold, as flow distribution directly affects the effectiveness of the backwash.

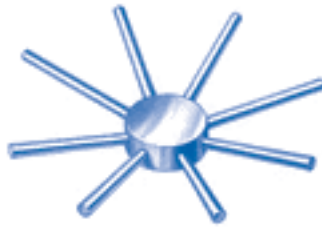

Figure 7-4. Hub-Lateral Distribution System (Johnson Screens).

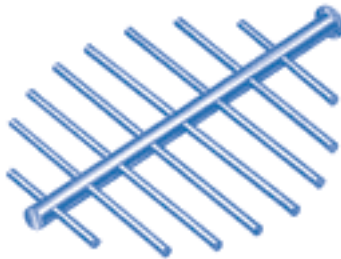

Figure 7-5. Header-Lateral Distribution System (Johnson Screens).

Typical media filtration installations include several filters in parallel. This allows one to be taken offline while the others continue to work. It also allows the other filters to provide the backwash water necessary to backwash a single filter. Figure 7-6 shows one potential valving arrangement that allows the use of multiple filters. Figure 7-7 and Figure 7-8 show pictures of commercially available pressurized media filters.

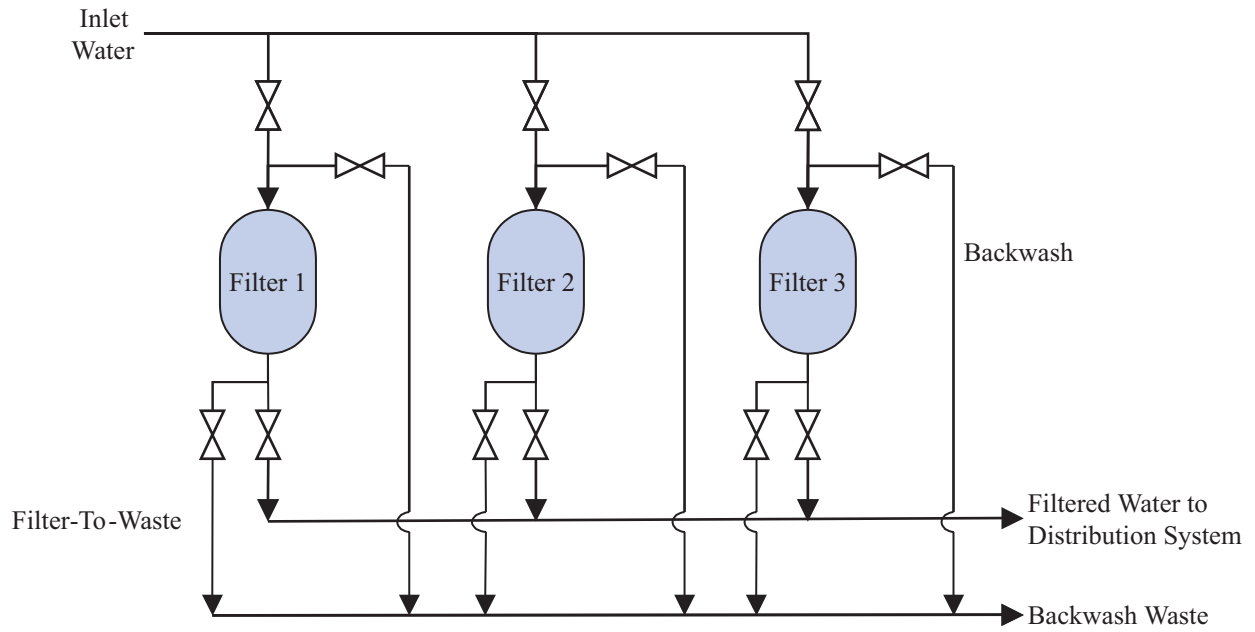

Figure 7-6. Multiple Media Filter Setup.



Figure 7-7. Pressurized Media Filter (USFilter).

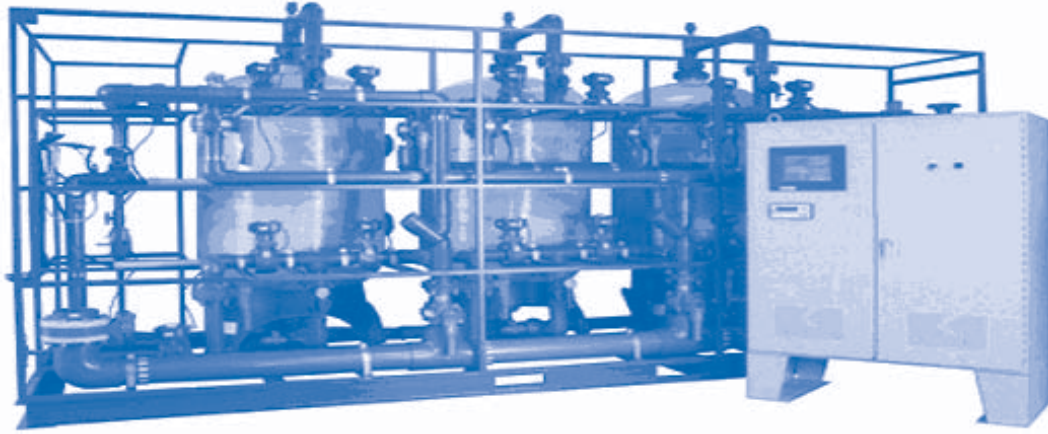

Figure 7-8. Pre-Engineered Arsenic Filtration System (Kineticco).

### 7.3.1 Filter Diameter

The primary design variable for the granular media filters is the hydraulic loading rate. This is the flowrate the filters handle per horizontal cross-sectional area of media. Typical hydraulic loading rates for greensand filters range between 3 and 5 gpm/sft, although, under some circumstances, greensand filters can be successfully operated at hydraulic loading rates as high as 10 gpm/sft. Using this information, the number of filters, and the maximum flowrate for which the filters are designed (i.e., design flowrate), the filter diameter can be calculated using Equation 7-1.

$$D = \left( \frac{4 \cdot Q}{\pi \cdot n_p \cdot \text{HLR}} \right)^{0.5} \quad \text{Eqn. 7-1}$$

Where:

- D = Column Diameter (ft),
- Q = Design Flowrate (gpm),
- $n_p$  = Number of Parallel Treatment Trains, and
- HLR = Hydraulic loading rate (gpm/sft).

For the example of 3 parallel filters designed to treat a maximum of 300 gpm of water at a filter hydraulic loading rate of 5 gpm/sft, the filter diameter should be 5 feet.

$$D = \left( \frac{4 \cdot 300 \text{ gpm}}{\pi \cdot 3 \cdot 5 \text{ gpm/sft}} \right)^{0.5} = 5 \text{ ft}$$

### 7.3.2 Media Weight

The weight of each media layer can be calculated using the following equation:

$$W_j = \frac{\pi \cdot D^2 \cdot h_j \cdot \rho_j}{4} \quad \text{Eqn. 7-2}$$

Where:

- $W_j$  = Weight of Media Layer  $j$  (lbs),
- $D$  = Column Diameter (ft),
- $h_j$  = Height of Media Layer  $j$  (ft), and
- $\rho_j$  = Bulk Density of Media  $j$  (lbs/cft).

For the previously calculated 5ft filters, using 1 ft of anthracite, 2.5 ft of greensand, 0.25 ft of filter garnet, and 2 ft of support granite, the media weights per filter are 982 lbs of anthracite, 4,172 lbs of greensand, 687 lbs of filter garnet, and 3,927 lbs of support granite, respectively. Typical densities for each of the media can be found in Table 7-1.

$$W_{\text{Greensand}} = \frac{\pi \cdot (5 \text{ ft})^2 \cdot (2.5 \text{ ft}) \cdot (85 \text{ lbs/cft})}{4} = 4,172 \text{ lbs of greensand (per filter)}$$

## 7.4 Waste Handling System Design

Both the backwash water and the FTW water from granular media filtration processes pose disposal issues. The backwash flowrate can be calculated using the equation:

$$Q_{\text{BW}} = \frac{\pi}{4} \cdot D^2 \cdot G_{\text{BW}} \quad \text{Eqn. 7-3}$$

Where:

- $Q_{\text{BW}}$  = Backwash flowrate (gpm),
- $G_{\text{BW}}$  = Backwash flux (gpm/sft), and
- $D$  = Column Diameter (ft).

The FTW flowrate is typically the same as the flowrate used in the filtration mode. Therefore, the volume of wastewater produced by the backwash and FTW modes can be calculated using the equation:

$$V_{\text{WW}} = Q_{\text{BW}} \cdot t_{\text{BW}} + \frac{Q}{n_p} \cdot t_{\text{FTW}} \quad \text{Eqn. 7-4}$$

Where:

- $V_{\text{WW}}$  = Volume of Wastewater (gal),
- $Q_{\text{BW}}$  = Backwash Flowrate (gpm),
- $t_{\text{BW}}$  = Backwash Duration (min),
- $Q$  = Design flowrate (gpm),
- $n_p$  = Number of Parallel Treatment Trains, and
- $t_{\text{FTW}}$  = Filter-To-Waste Duration (min).

For example, assume the same 3-filter system as before (5-foot diameter, 300 gpm design flowrate, and 5 gpm/sft hydraulic loading rate) has a backwash flux of 12 gpm/sft, a backwash time of 15 minutes, and a FTW time of 5 minutes. The required backwash flowrate is then 236 gpm/filter and the wastewater volume created is 4,040 gallons per backwash per filter.



$$Q_{BW} = \frac{\pi}{4} \cdot (5 \text{ ft})^2 \cdot \left(12 \frac{\text{gpm}}{\text{sft}}\right) = 236 \text{ gpm (per filter)}$$

$$V_{WW} = \left(236 \frac{\text{gpm}}{\text{Filter}}\right) \cdot \left(15 \frac{\text{min}}{\text{Backwash}}\right) + \left(\frac{300 \text{ gpm}}{3 \text{ Filters}}\right) \cdot \left(5 \frac{\text{min}}{\text{Backwash}}\right) = 4,040 \frac{\text{gallons}}{\text{Filter} \cdot \text{Backwash}}$$

The wastewater can be disposed of in several different ways. The two most probable methods are indirect disposal through a POTW or by settling the solids and recycling the supernatant and sending the solids to a landfill.

In the indirect discharge through a POTW, a holding tank may be desired to eliminate the surging to the POTW system. In the liquid recycle/solids disposal method, a settling tank or basin is required. The holding basin or tank should be sized to hold at least two backwash/FTW cycles. In the above example, this leads to an 8,100 gallon tank.

## 7.5 Coagulant Addition System Design

The efficiency of arsenic co-precipitation to iron floc may vary depending on the concentration of iron and the iron:arsenic ratio. Optimal performance is obtained with an iron:arsenic mass ratio of at least 20:1. If the raw water does not meet these two parameters, iron addition may be required to provide enhanced coagulation. Ferric chloride ( $\text{FeCl}_3$ ) is commonly available for use in potable water systems and can be obtained as a 38wt% liquid. The volumetric flowrate of ferric chloride solution required to meet a predetermined dose rate can be calculated with Equation 7-5.

$$Q_{\text{FeCl}_3} = \frac{Q \cdot \delta_{\text{FeCl}_3}}{C_{\text{FeCl}_3} \cdot \rho_{\text{FeCl}_3}} \cdot \left(0.003785 \frac{\text{kg} \cdot \text{mL}}{\text{mg} \cdot \text{gal}}\right) \quad \text{Eqn. 7-5}$$

Where:

- $Q_{\text{FeCl}_3}$  = Ferric Chloride Metering Pump Rate (mL/min),
- $Q$  = Design flowrate (gpm),
- $\delta_{\text{FeCl}_3}$  = Ferric Chloride Dose (mg/L),
- $C_{\text{FeCl}_3}$  = Ferric Chloride Stock Solution Concentration (wt%), and
- $\rho_{\text{FeCl}_3}$  = Density of Ferric Chloride (kg/L).

For example, if the design flow rate of water to be treated was 300 gpm and the water needed an additional 1.0 mg/L of iron, a 38-wt% solution of ferric chloride with a density of 1.42 kg/L could be added to the water at a rate of 6.1 mL/min to provide the required iron.

$$Q_{\text{FeCl}_3} = \frac{(300 \text{ gpm}) \cdot (1 \text{ mg/L})}{(0.38) \cdot (1.42 \text{ kg/L})} \cdot \left(0.003785 \frac{\text{kg} \cdot \text{mL}}{\text{mg} \cdot \text{gal}}\right) = 2.1 \text{ mL/min}$$

The required storage capacity for the ferric chloride solution can be calculated using Equation 7-6.

$$V = \frac{Q \cdot t \cdot \delta_{\text{FeCl}_3}}{C_{\text{FeCl}_3} \cdot \rho_{\text{FeCl}_3}} \cdot \left( 0.00144 \frac{\text{kg} \cdot \text{min}}{\text{mg} \cdot \text{d}} \right) \quad \text{Eqn. 7-6}$$

Where:

- V = Storage Volume (gal),
- Q = Design flowrate (gpm),
- $\delta_{\text{FeCl}_3}$  = Dose Rate of Ferric Chloride (mg/L),
- t = Storage Time (days),
- $C_{\text{FeCl}_3}$  = Ferric Chloride Stock Solution Concentration (wt%), and
- $\rho_{\text{FeCl}_3}$  = Density of Ferric Chloride (kg/L).

Using the same example and specifying 14 days of ferric chloride storage, the required storage volume would be 32.6 gallons.

$$V = \frac{(300 \text{ gpm}) \cdot (14 \text{ days}) \cdot (1 \text{ mg/L})}{(0.38) \cdot (1.42 \text{ kg/L})} \cdot \left( 0.00144 \frac{\text{kg} \cdot \text{min}}{\text{mg} \cdot \text{d}} \right) = 11.2 \text{ gal}$$

A generalized flow diagram for a ferric chloride chemical addition system is shown in Figure 7-9. The ferric chloride should be stored in a tank made of either fiberglass-reinforced polyester or rubber-lined steel. A flow meter installed along the main water line is used to pace the addition of ferric chloride to the water flowrate. An isolation valve and check valve are used in the connection to the water line. After the ferric chloride addition, the water is mixed with an inline mixer and the dosed water is sent to the filters.

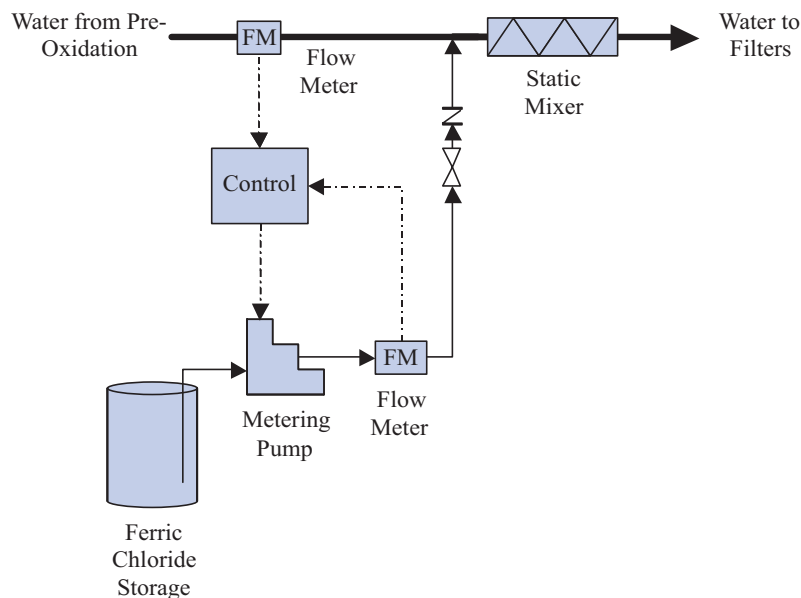

Figure 7-9. Ferric Chloride Addition Flow Diagram.

# Section 8

## Point-Of-Use Treatment

---

POU devices were approved as SSCTs for meeting the revised arsenic MCL. POU devices are attractive for removing contaminants that pose (solely) an ingestion risk, as is the case with arsenic. This is because a very small fraction of the total water supplied to a given household is ultimately consumed. In most cases, the POU unit is plumbed into the kitchen faucet. As such, the kitchen tap would be the only source from which water should be collected for consumption.

The primary advantage of employing POU treatment in a small system is reduced capital and treatment costs, relative to centralized treatment. On the downside, however, it is the utility's responsibility to maintain equipment. Therefore, these programs generally incur higher administrative and monitoring costs to make sure that all units are functioning properly. POU programs are an economically viable alternative to centralized treatment for systems serving up to 500 people.

Another downside is that the media or membranes used in POU treatment devices may be susceptible to microbial colonization. Higher levels of bacteria have been found in the finished water produced by some POU treatment devices, particularly those that incorporate an activated carbon element, than in the corresponding untreated water. Although no illnesses have been reported as a result of the use of these treatment devices, the health effects of these bacteria are still unknown. Therefore, additional monitoring and post-treatment disinfection may be required to ensure customer safety, increasing overall costs.

The primary criteria for selecting an appropriate POU treatment device are arsenic removal performance and cost. Additional considerations include third party certification to NSF/ANSI standards, appropriate mechanical warning devices, and ease of serviceability.

### 8.1 Treatment Alternatives

The technologies that are most amenable to POU treatment include column adsorption with AA, IBS, or RO with pre-filtration. The decision trees in Section 3 lead to the most appropriate POU technology among these choices.

#### 8.1.1 Adsorption Point-of-Use Treatment

While finished water pH values will likely be much higher than the optimal pH for activated alumina (pH 6.0), it can be operated on a disposable basis at higher pH values. Modified AA and IBS provide improved treatment capacity across a broader pH range, and may be preferred depending upon the cartridge replacement frequency selected by the system. Column operation has the advantages of simple operation, low maintenance, low relative cost, small under-the-counter footprint, and high treatment capacity. Additionally, the break-

through kinetics of sorption technologies are slow and more readily detected by routine monitoring.

Figure 8-1 shows how POU adsorption equipment is typically connected to kitchen plumbing.

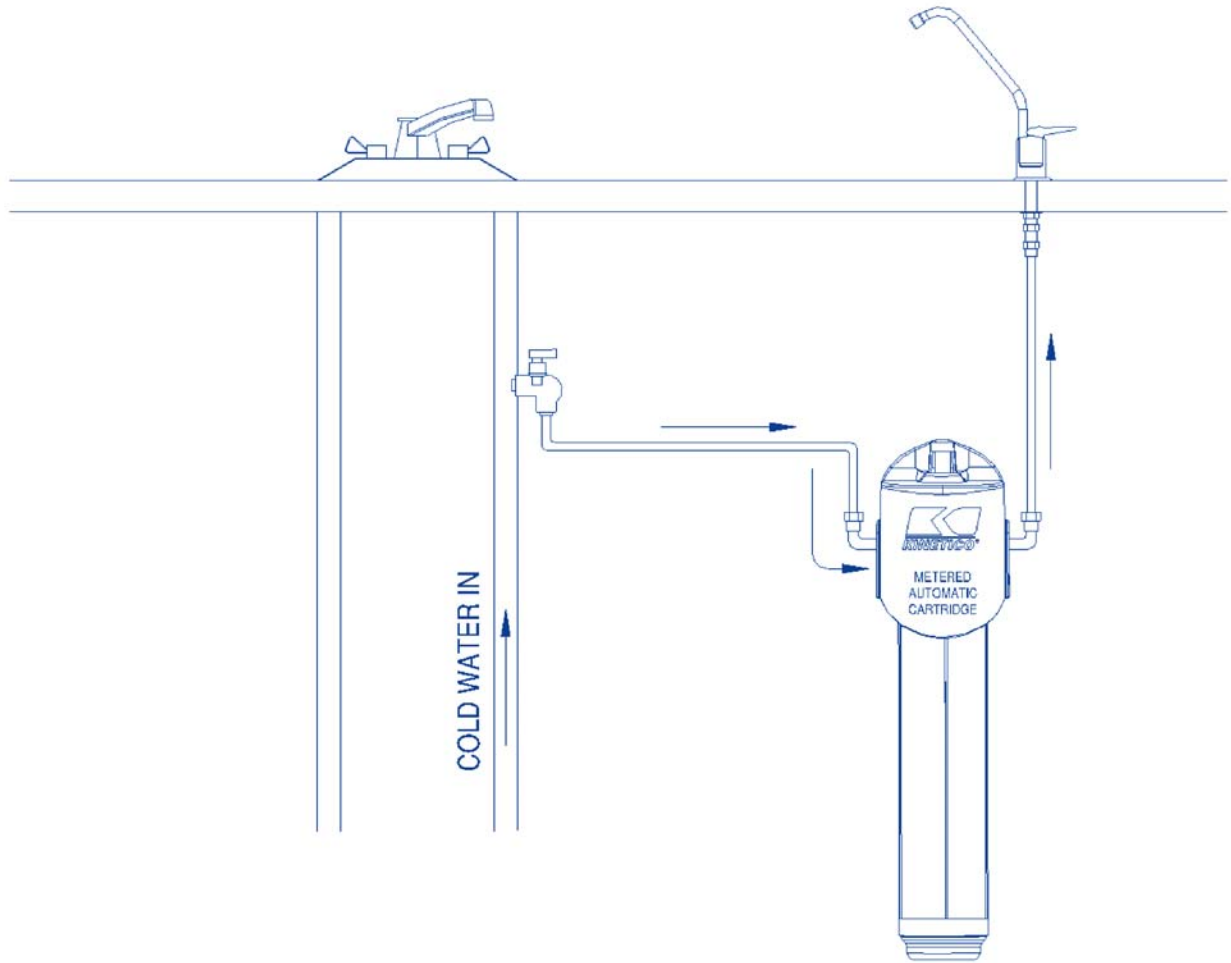

Figure 8-1. Point-Of-Use Adsorption Setup (Kinetico).

Adsorption columns are typically operated to a set volume to prevent arsenic leakage. This is accomplished through the use of a metered cartridge that provides flow totalization and will automatically shut-off water flow once the unit reaches the prescribed volume limit. Figure 8-2 shows a cross-section of one manufacturer's adsorption cartridge.

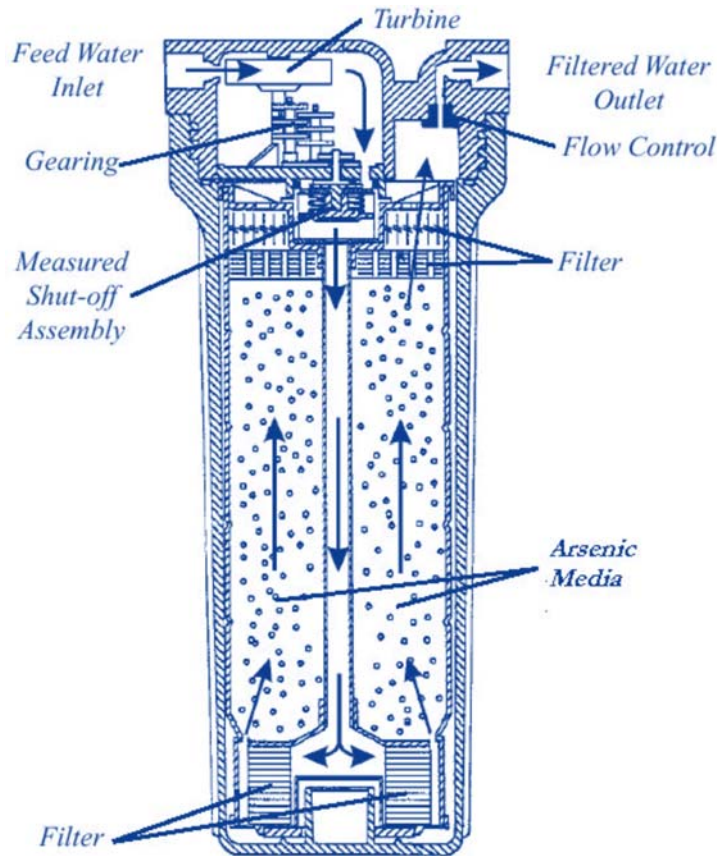

Figure 8-2. Metered Automatic Cartridge (Kinetico).

### 8.1.2 Reverse Osmosis Point-of-Use Treatment

RO POU devices are recommended for treating arsenic-rich water containing high levels of sulfates, phosphates, or total dissolved solids. When operating at typical tap pressures, RO devices commonly achieve greater than 95% As(V) rejection at a water recovery of 10-25%. Most units are designed with pre- and post-filters. Pre-filtration through granular media is applied to reduce solids loading and extend membrane life. For chlorine sensitive membranes, pre-filtration typically utilizes a dechlorinating media such as granular activated carbon. Post-filtration utilizes carbon or arsenic adsorbent media and serves as a final guard step.

Although the cost of RO POU devices is relatively high compared to other possible options, the immediate improvement of the overall water quality could make it very attractive to customers. The potential disadvantages associated with RO systems include poor water recovery, disposal of the reject stream, and high capital cost.

The most common types of membranes used for RO applications are cellulose acetate, thin-film polyamide composites, and sulfonated polysulfone. The membranes are manufactured in various forms, including tubes, sheets, and hollow fibers. The membrane is then constructed into a cartridge called an RO module, either spiral wound or hollow fiber.

Most RO POU devices operate at tap water pressure, and therefore have relatively poor water recoveries. Permeate is sent to a bladder tank large enough to meet on-demand requirements. Typical production rates range from 5-15 gpd.

Over time, the membrane surface will require cleaning in order to maintain performance. This capability is built in to most RO devices. Depending on the specific design, the water source for washing the membrane surface may either be feed water or permeate.

Figure 8-3 shows how RO POU equipment is typically connected to kitchen plumbing.

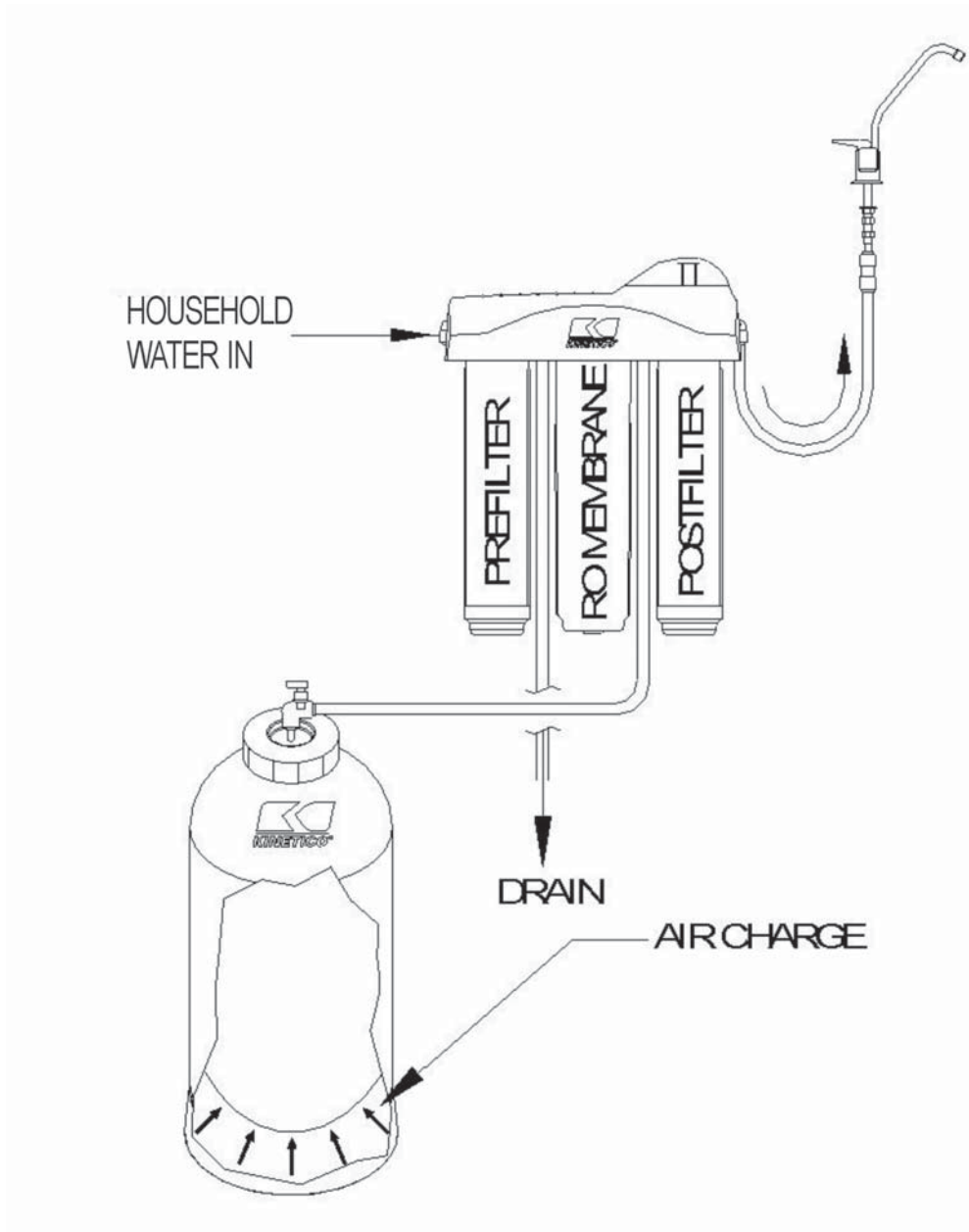

Figure 8-3. Point-Of-Use Reverse Osmosis Setup (Kinetico).

## 8.2 Implementation Considerations

Amendments to the SDWA in 1996 explicitly allow utilities to install POU treatment devices to achieve compliance with the NPDWRs. More information on the implementation of a POU program can be found in the USEPA's *Guidance for Implementing a Point-of-Use or Point-of-Entry Treatment Strategy for Compliance with the Safe Drinking Water Act* (USEPA, 2002b Draft).

The implementation of a centrally managed POU program is very different from application of centralized treatment. In many cases, the customer's acceptance of the treatment unit is affected by familiarity with the technology, the need for treatment, the appearance of the unit, and other subjective factors. Many homeowners currently employ some form of POU treatment such as carbon filtration or water softening. These products are generally used to enhance aesthetic properties of water, and are therefore used voluntarily. Under a centrally managed POU treatment program, all customers would be required to employ treatment devices in their home. As such, utility staff or contractors would need access inside individual homes to install treatment devices, make plumbing modifications, and make periodic O&M checks. The extent of customer acceptance and potential for resistance associated with this utility-customer interface are not well known.

### 8.2.1 Program Oversight

**POU units must be owned, controlled, and maintained by the public water system or by a contractor hired by the public water system to ensure proper operation and maintenance of the device and compliance with MCLs.** The utility must retain oversight of unit installation, maintenance, and sampling. While this provision does not require the utility to perform all maintenance or management functions – utilities are free to contract out these tasks – it does imply that *the utility retains final responsibility* of the quality and quantity of the water provided to the service community and must closely monitor all contractors. Further, the utility *may not* delegate its responsibility for the operation and maintenance of POU devices installed as part of a compliance strategy to homeowners.

The implications of this requirement to the utility are significant. The utility must decide whether it wants to implement the POU program in-house or contract out the necessary services. In one case, the utility would be the main contact with the customer, and utility staff would be responsible for installation, monitoring, record-keeping, and O&M activities. This raises several important issues. First, many small utilities often have difficulty finding the time and budget to hire, train, and retain operators. Second, utilities that elect to keep the work in-house must provide staff training on installation and O&M procedures. Third, the utility should consider the liability implications of entering individuals' homes to conduct work. If the utility decides to contract out the services, the vendor would be the main contact with the customer and the utility would need to monitor the contractor.

### **8.2.2 Cost**

There are a number of cost elements involved in conducting a POU program. These include:

- Capital cost of POU devices. The typical cost ranges of RO devices and adsorption units are \$300-\$1,000 and \$100-\$300 each, respectively.
- Installation labor. Installation of each device is anticipated to take 30 to 60 minutes assuming no significant plumbing modifications are necessary.
- Installation parts
- Replacement parts. Carbon-based pre-filters typically cost between \$15-50. New membranes typically cost about \$150.
- Water quality analyses. Arsenic can be measured by a commercial laboratory for approximately \$10-\$20 per sample.
- O&M labor.

### **8.2.3 Compliance Monitoring**

The current approach is that compliance monitoring would be conducted for each and every installed POU device, though only one-third within the same year. A representative monitoring approach that requires less frequency monitoring is under evaluation. States may have more stringent monitoring requirements. Samples can be taken by the utility or the contractor.

### **8.2.4 Mechanical Warnings**

Each POU treatment device installed as part of a compliance strategy must be equipped with a warning device (e.g., alarm, light, etc.) that will alert users when their unit is no longer adequately treating their water. Alternatively, units may be equipped with an automatic shut-off mechanism to meet this requirement. Several communities have implemented POU treatment strategies using units equipped with water meters and automatic shut-off devices to disable the units after a specified amount of water has been treated to prevent contaminant breakthrough.

### **8.2.5 Operations and Maintenance**

Periodic maintenance is necessary to ensure that the devices are functioning properly and producing tap water in compliance with the arsenic MCL. O&M activities consist of both regular scheduled tasks as well as emergency troubleshooting responses.

The sorbent media or RO membrane should be replaced periodically either on a set frequency or based on monitoring and tracking use. Both replacement schedules should be based on pilot testing results. The Arsenic Rule also stipulates that the POU device be equipped with mechanical warnings to ensure that customers are automatically notified of operational problems. Many devices include a programmable indicator that tracks cumulative water use, and serves as a convenient visual guide for the remaining life of the POU



device. However, it is not recommended that the utility depend solely on the customer for POU servicing. Rather, there should be an established schedule that is made public to the community and adhered to.

### **8.2.6 Customer Education and Residential Access**

Utilities should attempt to educate the public prior to implementing a POU strategy. This education may include public hearings, water bill inserts, posters, or notices in print or on radio or TV. When presented with the facts, most people will happily provide the water utility with access to ensure their ongoing effectiveness.

To address the possibility that an individual or a group of individuals may refuse to provide utility personnel with the necessary access, the utility may need to convince the local government to pass an ordinance guaranteeing water utility personnel access to service treatment units. To meet the legal responsibility to provide water in compliance with all NPDWRs, the utility may also have to pass an ordinance that requires customers to use POU treatment units, and that provides the utility with the authority to shut off a customer's water if the customer refuses to allow installation and maintenance of, tampers with, bypasses, or removes the treatment unit.

To minimize the burden associated with gaining access to individual residences, POU sampling should be coordinated with routine maintenance. Reducing the number of house visits will reduce administrative costs and travel time, resulting in substantial cost savings as well reducing the disruption to the residents.

### **8.2.7 Residual Oxidant in Distribution System**

In order to effectively use many sorbent type POU devices, the arsenic must be in its As(V) form as it is treated at the tap. RO type POU devices may also work more efficiently if arsenic is oxidized. This may require installation of a POU oxidation unit or centralized oxidation. If anoxic conditions occur in the distribution system, there is a potential for arsenic to reduce back to the As(III) state. This would drastically decrease the effectiveness of most of the sorptive type POU devices. Therefore, maintaining an adequate residual oxidant in the distribution system is important.

### **8.2.8 Waste Handling**

The type of waste produced from a POU device will depend on the treatment employed. RO treatment will produce a continuous liquid waste stream (i.e., retentate) that should be suitable for disposal in an on-site or community sewerage system (see Section 2.4). Conversely, with column adsorption treatment, the only waste is exhausted media, which is produced on a periodic basis.

Because the solid residuals generated by POU units are collected from individual households, these wastes *may* be exempt from federal regulation as hazardous wastes, regardless of their toxicity. However, state regulations and each state's implementation of federal regulation can vary. In the case of liquid wastes, local wastewater treatment plants may

issue their own limits for the disposal of arsenic. It is anticipated that this waste will not exceed the TC characteristics and will be disposable in a municipal landfill. Additionally, POU manufacturers or vendors may also provide waste disposal services for the POU devices.

### **8.3 Device Certification**

To meet the requirements of the SDWA, POU devices installed as part of a compliance strategy must be certified according to the American National Standards Institute (ANSI) standards, if a standard exists for that type of device. RO POU devices must be certified as per ANSI/NSF 58 (2002) - *Reverse Osmosis Drinking Water Treatment Systems*. POU devices utilizing a sorption technology such as AA or an IBS must be certified as per ANSI/NSF 53 (2002) - *Drinking Water Treatment Units – Health Effects*.

# Section 9

## References

---

- AwwaRF (2000). *Arsenic Treatability Options and Evaluation of Residuals Management Issues*, Amy, G.L., M. Edwards, P. Brandhuber, L. McNeill, M. Benjamin, F. Vagliasindi, K. Carlson, and J. Chwirka. Awwa Research Foundation, Denver, CO.
- AwwaRF (2002). *Implementation of Arsenic Treatment Systems – Part I. Process Selection*, Chowdhury, Z., S. Kommineni, R. Narasimhan, J. Brereton, G. Amy, and S. Sinha. Awwa Research Foundation, Denver, CO.
- Clifford, Dennis (1999). Presentation at Arsenic Technical Work Group. Washington, D.C.
- Clifford, Dennis (2001). *Arsenic Treatment Technology Demonstration Drinking Water Assistance Program for Small Systems*, Final Report to the Montana Water Resources Center, March 2001.
- Fields, Keith, Abraham Chen, and Lili Wang (2000a). *Arsenic Removal from Drinking Water by Coagulation/Filtration and Lime Softening Plants*, EPA 600R00063, Prepared by Battelle under contract 68C70008 for U.S. EPA ORD, June 2000.
- Fields, Keith, Abraham Chen, and Lili Wang (2000b). *Arsenic Removal from Drinking Water by Iron Removal Plants*, EPA 600R00086, Prepared by Battelle under contract 68C70008 for U.S. EPA ORD, August 2000.
- Ghurye, Ganesh and Dennis Clifford (2001). *Laboratory Study on the Oxidation of As(III) to As(V)*, EPA 600R01021, Prepared under contract 8CR311-NAEX for EPA ORD, March 2001.
- Hanson, Adrian, Jared Bates, Dean Heil, Andrew Bistol (1999). *Arsenic Removal from Water Using Greensand: Laboratory Scale Batch and Column Tests*. New Mexico State University, Las Cruces, NM, June 1999.
- Kempic, Jeffery (2002), Teleconference on October 29, 2002.
- MacPhee, Michael J., Gail E. Charles, and David A Cornwell (2001). *Treatment of Arsenic Residuals from Drinking Water Removal Processes*, EPA 600R 01033, Prepared by Environmental Engineering & Technology, Inc. under contract 8CR613-NTSA for EPA ORD, June 2001.
- National Research Council (NRC) (1999). *Arsenic in Drinking Water*. National Academy Press, Washington, D.C.

- NSF International (2001a). *Environmental Technology Verification Report: Removal of Arsenic in Drinking Water - Hydranautics ESPA2-4040 Reverse Osmosis Membrane Element Module*, NSF 0120EPADW395, March 2001.
- NSF International (2001b). *Environmental Technology Verification Report: Removal of Arsenic in Drinking Water – KOCH Membrane Systems TFC – ULP4 Reverse Osmosis Membrane Module*, NSF 0125EPADW395, August 2001.
- Rubel, Frederick, Jr. *Design Manual – Removal of Arsenic from Drinking Water Supplies by Ion Exchange*, EPA DRAFT.
- Rubel, Frederick, Jr. *Design Manual – Removal of Arsenic from Drinking Water Supplies by Adsorptive Media*, EPA 600-R-03-019, 2003.
- Selvin N., Messham G., Simms J., Pearson I., and Hall J. (2000). *The Development of Granular Ferric Media - Arsenic Removal and Additional Uses in Water Treatment*. Proceedings of the AWWA Water Quality Technology Conference, Salt Lake City.
- Tumalo, Jamie (2002). U.S. Filter. Personal Conversation with Andrew Hill.
- United States Environmental Protection Agency (1998). *Variance Technology Findings for Contaminants Regulated Before 1996*, EPA 815R98003, September 1998.
- United States Environmental Protection Agency (2000). *Technologies and Costs for Removal of Arsenic from Drinking Water*, EPA 815R00028, Prepared by Malcolm Pirnie, Inc. under contract 68C60039 for EPA ORD, December 2000.
- United States Environmental Protection Agency (2001). *Federal Register*, Final Arsenic Rule, 40 CFR Parts 9, 141, and 142.
- United States Environmental Protection Agency (2002a). *Implementation Guidance for the Arsenic Rule - Drinking Water Regulations for Arsenic and Clarifications to Compliance and New Source Contaminants Monitoring*, EPA 816K02018, August 2002.
- United States Environmental Protection Agency (2002b Draft). *Guidance on Implementing a Point-of-Use or Point-of-Entry Treatment Strategy for Compliance with the Safe Drinking Water Act*, EPA xxxx02xxx DRAFT, March 2002.
- Wang, Lili, Abraham Chen, and Keith Fields (2000). *Arsenic Removal from Drinking Water by Ion Exchange and Activated Alumina Plants*, EPA 600R00088, Prepared by Battelle under contract 68C70008 for U.S. EPA ORD, October 2000.

This page intentionally left blank.

**Office of Water (4606M)**  
**EPA 816-R-03-014**  
**July 2003**  
**[www.epa.gov/safewater](http://www.epa.gov/safewater)**