

# sporty's® E6B

ELECTRONIC FLIGHT COMPUTER



# SPORTY'S E6B

## ELECTRONIC FLIGHT COMPUTER



Sporty's E6B Flight Computer is designed to perform 24 aviation functions and 20 standard conversions, and includes timer and clock functions.

We hope that you enjoy your E6B Flight Computer. Its use has been made easy through direct path menu selection and calculation prompting. As you will soon learn, Sporty's E6B is one of the most useful and versatile of all aviation computers.

Copyright © 2016 by Sportsman's Market, Inc.  
Version 13.16A

# CONTENTS

BEFORE USING YOUR E6B .....	3
DISPLAY SCREEN .....	4
PROMPTS AND LABELS.....	5
SPECIAL FUNCTION KEYS .....	7
FUNCTION MENU KEYS .....	8
ARITHMETIC FUNCTIONS .....	9
AVIATION FUNCTIONS .....	9
CONVERSIONS .....	10
CLOCK FUNCTION.....	12
ADDING AND SUBTRACTING TIME .....	13
TIMER FUNCTION.....	14
HEADING AND GROUND SPEED .....	15
PRESSURE AND DENSITY ALTITUDE .....	16
GROUNDSPEED.....	17
PLANNED TRUE AIRSPEED.....	18
ACTUAL TRUE AIRSPEED .....	19
PLANNED MACH NUMBER.....	20
ACTUAL MACH NUMBER .....	21
FUEL REQUIRED.....	22
REQUIRED RATE OF CLIMB .....	23
REQUIRED RATE OF DESCENT .....	24
REQUIRED TRUE AIRSPEED .....	25
REQUIRED CALIBRATED AIRSPEED .....	26
WIND SPEED AND DIRECTION.....	27
CROSSWIND, HEADWIND AND TAILWIND .....	28
CLOUD BASE.....	29
DISTANCE FLOWN .....	30
TOP OF DESCENT.....	31
ENDURANCE.....	32
LEG TIME .....	33
SPECIFIC RANGE .....	34
FUEL PER HOUR.....	35
WEIGHT AND ARM.....	36
WEIGHT AND MOMENT.....	39
PERCENT MAC .....	41
APPENDIX A: SAMPLE PROBLEMS.....	42
WEIGHT AND MEASURE CONVERSIONS. ....	47
BATTERY REPLACEMENT .....	48
TROUBLESHOOTING AND CARE.....	49
WARRANTY INFORMATION.....	50

BEFORE USING YOUR E6B

Sporty's E6B Flight Computer requires three 1.5V AAA batteries (not included) for operation. New batteries should be installed in the battery compartment located in the top rear of the computer. Make sure that battery polarity is aligned correctly.



An opaque plastic film has been placed over the display screen to protect your E6B during shipping. This film is easily removed by peeling up one corner and pulling gently.



This manual is designed to offer an introduction to the operation of the E6B. For each calculation, a sample problem has been given.

In order to save power, the display screen automatically turns off approximately 4 minutes after the last keystroke. However, the internal clock and timer will continue to run. If the timer is counting down, it will not shut off for approximately thirty minutes.

This multi-function computer is authorized and acceptable for use during FAA and Canadian written tests. All memory is erased by removing and reinstalling the batteries. NOTE: This also removes clock settings. References: FAA Advisory Circular 60-11 and FAA Order 8081, Conduct of Airmen Written Tests, April 10, 1989.

**Back light operation:**

To activate back light, press  followed by 

To deactivate, press  followed by 

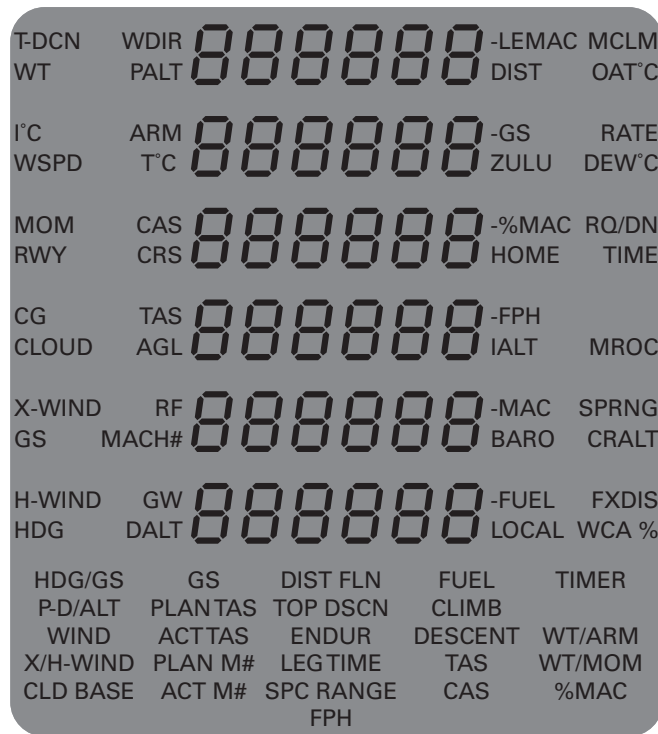

The figure above shows all possible displays, prompts and labels on the E6B. The numeric display is surrounded by labels for specific problems. On the next page are lines of text representing display prompts, labels, and aviation functions. Aviation functions on the E6B are grouped into six menus of similar functions. They will all be visible until you choose one of the menus, where only the functions in the chosen menu will be displayed. The display prompts and labels are only visible when in use.

## PROMPTS AND LABELS

<b>WT:</b>	Weight
<b>I°C:</b>	Indicated Temperature in Celsius
<b>W SPD:</b>	Wind Speed
<b>MOM:</b>	Moment
<b>RWY:</b>	Runway
<b>CG:</b>	Center of Gravity
<b>X-WIND:</b>	Crosswind
<b>GS:</b>	Ground Speed
<b>H-WIND:</b>	Headwind
<b>HDG:</b>	Heading
<b>W DIR:</b>	Wind Direction
<b>P ALT:</b>	Pressure Altitude
<b>ARM:</b>	Arm
<b>T°C:</b>	True Temperature in Celsius
<b>CAS:</b>	Calibrated Air Speed
<b>CRS:</b>	Course
<b>TAS:</b>	True Air Speed
<b>RF:</b>	Reduction Factor
<b>MACH#:</b>	Mach number
<b>GW:</b>	Gross Weight
<b>D ALT:</b>	Density Altitude
<b>LEMACH:</b>	Leading Edge Mean Aerodynamic Chord
<b>DIST:</b>	Distance
<b>ZULU:</b>	Coordinated Universal Time Clock Label
<b>%MAC:</b>	Percent Mean Aerodynamic Chord
<b>HOME:</b>	Home Time Clock Label
<b>FPH:</b>	Fuel Per Hour
<b>TIME:</b>	Time
<b>I ALT:</b>	Indicated Altitude
<b>MAC:</b>	Mean Aerodynamic Chord
<b>BARO:</b>	Altimeter Setting in Inches (Barometer)

## PROMPTS AND LABELS (cont.)

<b>FUEL:</b>	Fuel
<b>LOCAL:</b>	Local Time Clock Label
<b>°C:</b>	Temperature in Celsius Label
<b>FEET:</b>	Feet
<b>NAUT:</b>	Nautical
<b>CALC:</b>	Calculator Function
<b>CONV:</b>	Conversion Function
<b>MCLM:</b>	Minimum Climb
<b>MROC:</b>	Required Rate of Climb
<b>%:</b>	Climb Gradient
<b>CRALT:</b>	Crossing Altitude
<b>FXDIS:</b>	Fix Distance
<b>RQ/DN:</b>	Required Descent Rate
<b>SPRNG:</b>	Specific Range
<b>RATE:</b>	Descent Rate
<b>T-DCN:</b>	Top of Descent
<b>OAT°C:</b>	Outside Air Temperature in Celsius
<b>DEW°C:</b>	Dew Point Temperature in Celsius
<b>CLOUD AGL:</b>	Cloud Base Above Ground Level

## SPECIAL FUNCTION KEYS

 Turns power on/off and resets E6B to main menu.

 Starts and stops timer function.

 Selects menu function and enters data input.

 Totals regular calculator functions.





 Converts keys to alternate functions.

 Controls display and setting of clocks.

 Clears current input line.

 Controls function menu cursor. The function on which the cursor is located will blink. These keys will turn the display's backlight on/off when used with the conversion key.



 Changes negative to a positive and positive to a negative. A negative number will be denoted by a minus sign near the upper right hand corner of the number.  exa  e, to  -17:

Press

and the screen will read 17.-

When in **TIMER** mode, this key changes the direction the timer is counting



## FUNCTION MENU KEYS

The six menu buttons will highlight the related functions.

**HDG/GS  
P-D/ALT**

Heading/Ground Speed and Pressure/  
Density Altitude

**SPEED**

Ground Speed, True Air Speed (Planned &  
Actual), Mach # (Planned and Actual)

**REQUIRED**

Required Fuel, Required Rate of Climb &  
Descent, Required True Air Speed and Required  
Calibrated Air Speed

**WIND**

Wind, Crosswind/Headwind and Cloud Base

**FLIGHT**

Distance Flown, Top of Descent, Endurance, Leg  
Time, Specific Range and Fuel Per Hour

**WT/BAL**

Weight/Arm, Weight/Moment and Percentage of  
Mean Aerodynamic Chord

## AVIATION FUNCTIONS

HDG/GS	GS	DIST FLN	FUEL	TIMER
P-D/ALT	PLANTAS	TOP DSCN	CLIMB	
WIND	ACTTAS	ENDUR	DESCENT	WT/ARM
X/H-WIND	PLAN M#	LEGTIME	TAS	WT/MOM
CLD BASE	ACT M#	SPC RANGE	CAS	%MAC
		FPH		

The aviation function menu is displayed on the bottom of the screen. Your E6B will automatically save computed values from one aviation function to another. To override this option, key in new value when prompted. The E6B will save true airspeed, groundspeed, time, and fuel per hour functions. It will also save cumulative weight and balance totals.



Your E6B performs all of the standard arithmetic functions with the keys shown above, (addition, subtraction, multiplication, and division). These functions as well as any conversions can be performed at any time, even while performing an aviation function. The E6B will display up to six digits of the answer.

The  key should be used to compute any arithmetic function

## CONVERSIONS

Conversions are displayed above the appropriate key, and are listed on the next page. All conversion functions are keyed into the computer in the same manner. For example, to convert decimal hours to hours, minutes and seconds:

Input     4 . 2 6 2 5

Press     

Press     

The answer, 04:15:45, will appear on the display.

There are no conversion keys for kilometers to statute miles or statute miles to kilometers. To convert from kilometers to statute miles, first convert kilometers to nautical miles, then nautical miles to statute miles.

To convert statute miles to kilometers, first convert from statute miles to nautical miles, then nautical miles to kilometers.

NOTE: Conversions may be made at any time and during any other function. For example, if a calculation prompts for temperature in Celsius and only Fahrenheit is available, the Fahrenheit can be entered and converted without exiting the calculation.

## CONVERSIONS (cont.)

- 0 pounds to kilograms
- kilograms to pounds
- = gallons of AvGas to pounds
- + pounds of AvGas to gallons
- 1 feet to meters
- 2 meters to feet
- 3 gallons of jet fuel to pounds
- pounds of jet fuel to gallons
- 4 nautical miles to kilometers
- 5 kilometers to nautical miles
- 6 decimal hours to hours, minutes, seconds
- x hours, minutes, seconds to decimal hours
- 7 nautical miles to statute miles
- 8 statute miles to nautical miles
- 9 U.S. gallons to liters
- ÷ liters to U.S. gallons
- °C degrees Celsius to Fahrenheit
- °F degrees Fahrenheit to Celsius
- : millibars to inches of Mercury
- +/- inches of Mercury to millibars

## THE CLOCK FUNCTION

The E6B has three clocks that run simultaneously. They are labeled as **ZULU**, **HOME** and **LOCAL**.

To display the three clocks, press **CLOCK**

To set 11:25:00 on **ZULU** clock:

Press **CONV** then press **CLOCK**

Key in 11 then press **:**

Key in 25 then press **CLOCK** to start clock

To set hours for **HOME** and **LOCAL** clocks:

Press **CONV** , **CLOCK** then use **▼** to select **HOME**

or **LOCAL** clocks. Set the desired hour then press **CLOCK**

The minutes and seconds of the **HOME** and **LOCAL** clocks will synchronize with those of the **ZULU** clock after each setting.

## ADDING AND SUBTRACTING TIME

Time can be entered into the E6B in either decimal hours or as hours, minutes and seconds. To enter in decimal hours, simply key in a normal decimal number. For example, entering 2.75 hours is the same as entering 02:45:00.

To key in time in hours, minutes and seconds mode, the  key must be used. For example, to enter 3 hours, 14 minutes and 25 seconds:

Key in  then press  and key in 14

Press  and key in 25

The display will read 03:14:25

To key in 5 hours even:

Key in  and press 

The display will read 05:00:00

To key in 15 seconds:

Key in  then press  twice and key in 15

The display will read 00:00:15

Time can be added in either mode; times from different modes can also be added without converting.

For example, to add 3.45 hours and 2:45:00:

Key in 3.45 and press 

Key in 2:45 and press 

The display will read 06:12:00.

## TIMER FUNCTION

The timer can be used in either a count down or count up mode.

To enter **TIMER** mode, press **TIMER**

Once in **TIMER** mode, the **TIMER** key acts as a start/stop button. The timer is set to count up.

To change counting direction, press **+/-**

The timer can be reset to 00:00:00 by pressing:



To input a time other than 00:00:00:

Press **CONV** then **TIMER**. Input a time in hours, minutes, seconds (**HMS**) then press **TIMER**. The timer will begin counting down. To count up, press **+/-**

Upon reaching zero in count down mode, the timer will count time since zero was reached. To denote this, a negative sign will appear to the right of the timer. The count down timer can be used as a reminder of when to switch fuel tanks, to fly a non-precision approach (**LEG TIME** function) or measuring ground speed from one checkpoint to another checkpoint (**GS**).

Any function requiring time to be entered, the timer may be used by

pressing **TIMER** **ENTER** when prompted for time.

Activating the count down timer will keep the screen from turning off until approximately thirty minutes without use.

## HEADING AND GROUND SPEED (HDG/GS)

This function will compute heading and ground speed given wind direction, wind speed, course, and true airspeed. In this example, the wind is from 270° at 20, course is 180°, and true airspeed is 185.

Select **HDG/GS** from the **HDG/GS P-D/ALT** menu

Press **ENTER** and the display will prompt for **WDIR**

Key in 270 and press **ENTER**

The display will prompt for **WSPD**

Key in 20 and press **ENTER**

The display will prompt for **CRS**

Key in 180 and press **ENTER**

The display will prompt for **TAS**

Key in 185 and press **ENTER**

The display will read:

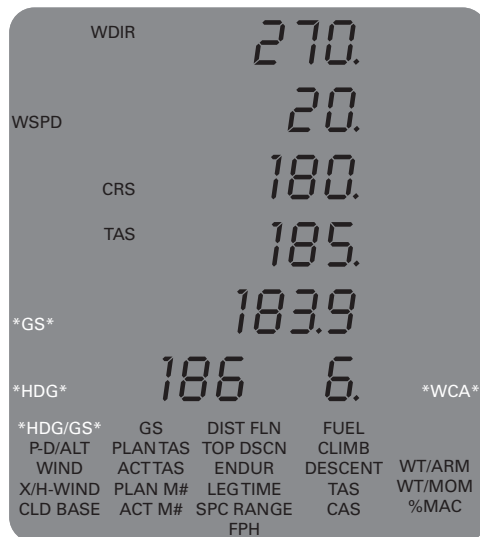

**Note:** Wind direction and direction of flight must be entered consistently relative to true or magnetic north for accurate calculations.



## PRESSURE AND DENSITY ALTITUDE (P-D/ALT)

This function will compute the pressure and density altitude given the indicated altitude, barometric pressure (altimeter setting in inches), and true temperature in Celsius. In this example, indicated altitude is 10,000 feet, the barometer is 29.94 inches, and the temperature is 5°C.

Select **P-D/ALT** from the  menu

Press  and the display will prompt for **IALT**

Key in 10000 and press 

The display will prompt for **BARO**

Key in 29.94 and press 

The display will prompt for **T°C**

Key in 5 and press 

The display will read:

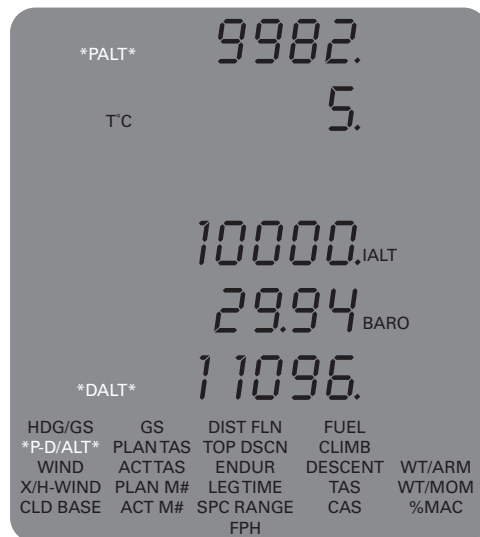

## GROUND SPEED (GS)

This function calculates ground speed given distance and time. In this example, distance is 18, and time is 7 minutes.

Select **GS** from the **SPEED** menu

Press **ENTER** and the display will prompt for **DIST**

Key in 18 and press **ENTER**

The display will prompt for **TIME**

Key in time of 7 minutes and press **ENTER**

The display will read:



**Note:** Times can be imported from the timer for ground speed calculations. This can be done by pressing **TIMER** **ENTER** when the computer prompts for TIME to use the timer's current value.

## PLANNED TRUE AIRSPEED (PLAN TAS)

This function is used to calculate true airspeed for preflight planning. It will compute the true airspeed in knots and Mach number and density altitude, given the pressure altitude, temperature, and calibrated airspeed in knots. In this example, pressure altitude is 10,000 feet, temperature is 2°C, and **CAS** is 200 knots.

Select **PLAN TAS** from the **SPEED** menu

Press **ENTER** and the display will prompt for **PALT**

Key in 10000 and press **ENTER**

The display will prompt for **T°C**

Key in 2 and press **ENTER**

The display will prompt for **CAS**

Key in 200 and press **ENTER**

The display will read:

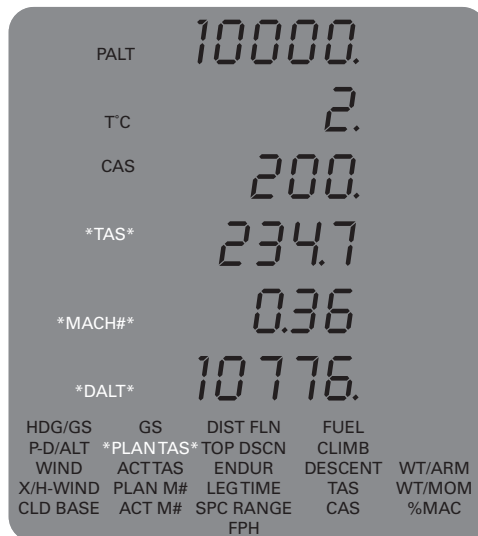

## ACTUAL TRUE AIRSPEED (ACT TAS)

This function calculates true airspeed, Mach number and density altitude given pressure altitude, indicated temperature in Celsius and calibrated airspeed. In this example, pressure altitude is 10,000 feet, temperature is 3°C, and airspeed is 200.

Select **ACT TAS** from the **SPEED** menu

Press **ENTER** and the display will prompt for **PALT**

Key in 10000 and press **ENTER**

The display will prompt for **I°C**

Key in 3 and press **ENTER**

The display will prompt for **CAS**

Key in 200 and press **ENTER**

The display will read:

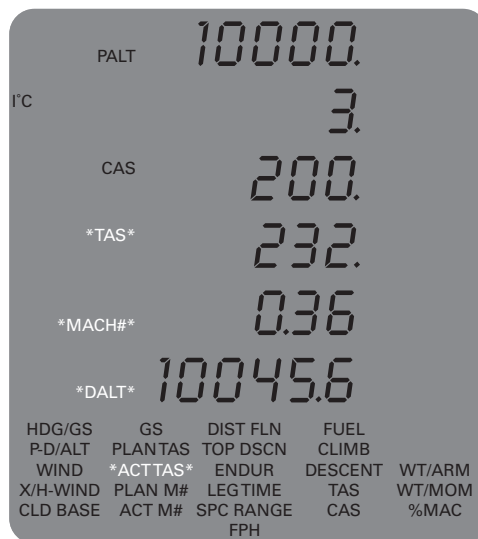

## PLANNED MACH NUMBER (PLAN M#)

This function will compute the true airspeed given the true temperature in Celsius and the Mach number. In this example, temperature is -20°C and the **MACH#** is 0.85.

Select **PLAN M#** from the **SPEED** menu

Press **ENTER** and the display will prompt for **T°C**

Key in 20 and press **+/-**

Press **ENTER**

The display will prompt for **MACH#**

Key in 0.85 and press **ENTER**

The display will read:



## ACTUAL MACH NUMBER (ACT M#)

This function calculates true airspeed given the indicated temperature and Mach number. It differs from the **PLAN M#** function only in that indicated temperature is used instead of true temperature. In this example, the indicated temperature is -17°C and the Mach number is 0.85.

Select **ACT M#** from the **SPEED** menu

Press **ENTER** and the display will prompt for **I°C**

Key in 17 and press **+/-**

Press **ENTER**

The display will prompt for **MACH#**

Key in 0.85 and press **ENTER**

The display will read:



## FUEL REQUIRED (FUEL)

Since it is one of the most important aviation calculations, this function flashes on the main menu when the computer is turned on. It calculates fuel requirements given time and fuel per hour consumption. In this example, flying time is 3 hours 15 minutes and fuel per hour consumption is 14 gallons.

Select **FUEL** from the **REQUIRED** menu

Press **ENTER** and the display will prompt for **TIME**

Key in time of 3 hours, 15 minutes and press **ENTER**

The display will prompt for **FPH** (fuel per hour)

Key in 14 and press **ENTER**

The display will read:



**Note:** The Fuel Required function computes fuel consumption only; it does not take required fuel reserves into account.

## REQUIRED RATE OF CLIMB (CLIMB)

This function computes the required rate of climb (common in departure procedures) in feet per minute and provides the climb gradient given groundspeed and minimum climb in feet per mile. In this example, the groundspeed is 80 and the minimum climb is 330 feet per mile.

Select **CLIMB** from the **REQUIRED** menu

Press **ENTER** and the display will prompt for **MCLM**

Key in 330 and press **ENTER**

The display will prompt for **GS**

Key in 80 and press **ENTER**

The display will read:





## REQUIRED RATE OF DESCENT (DESCENT)

This function determines the required descent or climb rate to arrive at a fix at a specific altitude given groundspeed, indicated altitude, crossing altitude and fix distance. In this example, the aircraft is cruising at 14,000 feet with a groundspeed of 180.

**ATC** assigns a crossing altitude of 8,000 feet for a fix located 25 miles away.

Select **DESCENT** from the **REQUIRED** menu

Press **ENTER** and the display will prompt for **GS**

Key in 180 and press **ENTER**

Display will prompt for **IALT**

Key in 14000 and press **ENTER**

Display will prompt for **CRALT**

Key in 8000 and press **ENTER**

Display will prompt for **FXDIS**

Key in 25 and press **ENTER**

The display will read:



**Note:** This **ATC** crossing restriction will require a descent rate of 720 feet per minute. A positive value for **RO/DN** indicates a descent. A negative value indicates a climb to the crossing altitude.

## REQUIRED TRUE AIRSPEED (TAS)

Required True Airspeed is a planning function used to maintain a certain ground speed and course in order to arrive at a desired point at a specific time. It will compute true airspeed and heading given wind direction and speed, course, and ground speed. In this example, the wind is from 270° at 15, course is 355°, and ground speed is 225.

Select **TAS** from the **REQUIRED** menu

Press **ENTER** and the display will prompt for **WDIR**

Key in 270 and press **ENTER**

Display will prompt for **WSPD**

Key in 15 and press **ENTER**

Display will prompt for **CRS**

Key in 355 and press **ENTER**

Display will prompt for **GS**

Key in 225 and press **ENTER**

The display will read:

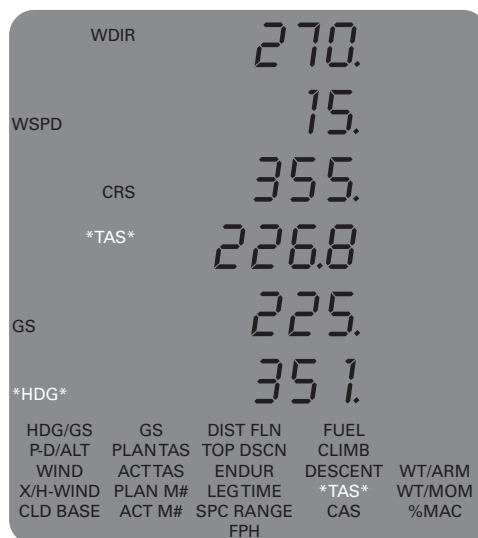

## REQUIRED CALIBRATED AIRSPEED (CAS)

This function calculates the calibrated airspeed, corresponding Mach number, and density altitude given the pressure altitude, true temperature in Celsius, and true airspeed. In this example, pressure altitude is 10,000 feet, temperature is 2°C, and the true airspeed is 200.

Select **CAS** from the **REQUIRED** menu

Press **ENTER** and the display will prompt for **PALT**

Key in 10000 and press **ENTER**

Display will prompt for **T°C**;

Key in 2 and press **ENTER**

Display will prompt for **TAS**

Key in 200 and press **ENTER**

The display will read:

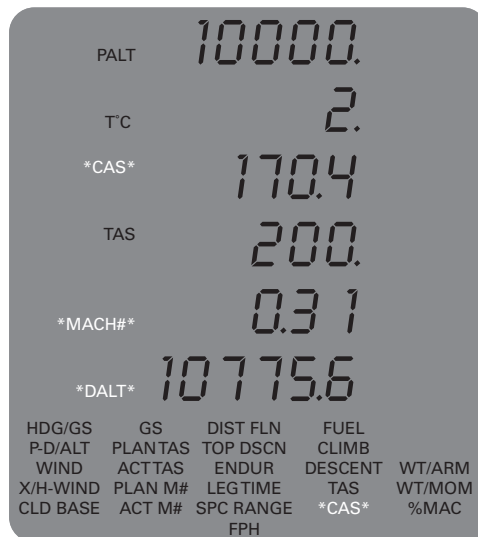

## WIND SPEED AND DIRECTION (WIND)

This function calculates wind speed and direction given course, true airspeed, ground speed, and heading. In this example, the course is 355°, true airspeed is 200, ground speed is 170, and the heading is 350°.

Select **WIND** from the **WIND** menu

Press **ENTER** and the display will prompt for **CRS**

Key in 355 and press **ENTER**

The display will prompt for **TAS**

Key in 200 and press **ENTER**

The display will prompt for **GS**

Key in 170 and press **ENTER**

The display will prompt for **HDG**

Key in 350 and press **ENTER**

The display will read:

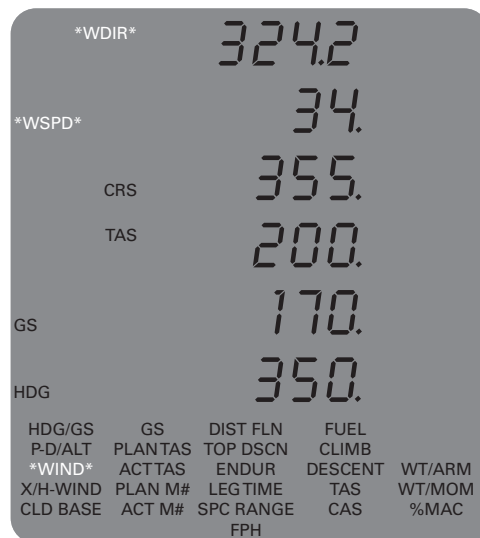

## CROSSWIND, HEADWIND AND TAILWIND (X/H-WIND)

This function computes the crosswind component and headwind or tailwind component given wind direction, wind speed and runway number. In this example, the wind is from 270° at 20, and the runway number is 30. Note that the runway number, not heading, is asked for, and therefore 30 should be entered, not 300.

Select **X/H-WIND** from the **WIND** menu

Press **ENTER** and the display will prompt for **WDIR**

Key in 270 and press **ENTER**

The display will prompt for **WSPD**

Key in 20 and press **ENTER**

The display will prompt for **RWY**

Key in 30 and press **ENTER**

The display will read:

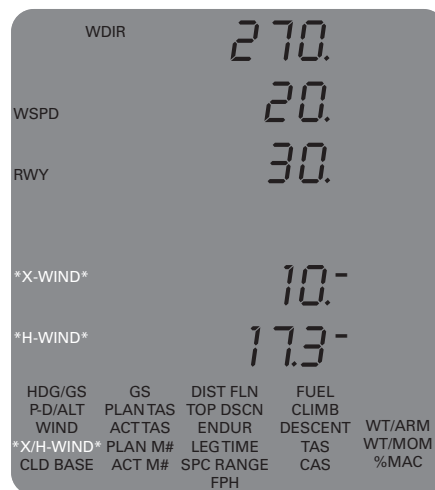

**Note:** Wind direction and direction of flight must be entered consistently relative to true or magnetic north for accurate calculations. Right crosswinds are shown as positive numbers, while left crosswinds are shown as negative numbers. A positive value for **H-WIND** denotes a tailwind, while a negative value denotes a headwind.

## CLOUD BASE (CLD BASE)

This function is used to determine the approximate base of clouds above ground level (**AGL**) given temperature and dew point in Celsius. In this example, outside air temperature is 20°C and the dew point is 12°C.

Select **CLD BASE** from the **WIND** menu

Press **ENTER** and the display will prompt for **OAT°C**

Key in 20 and press **ENTER**

The display will prompt for **DEW°C**

Key in 12 and press **ENTER**

The display will read:



## DISTANCE FLOWN (DIST FLN)

This function calculates for distance given time and ground speed. In this example, the ground speed is 185 and time is 15 minutes.

Select **DIST FLN** from the **FLIGHT** menu

Press **ENTER** and the display will prompt for **GS**

Key in 185 and press **ENTER**

The display will prompt for **TIME**

Key in time of 15 minutes and press **ENTER**

The display will read:

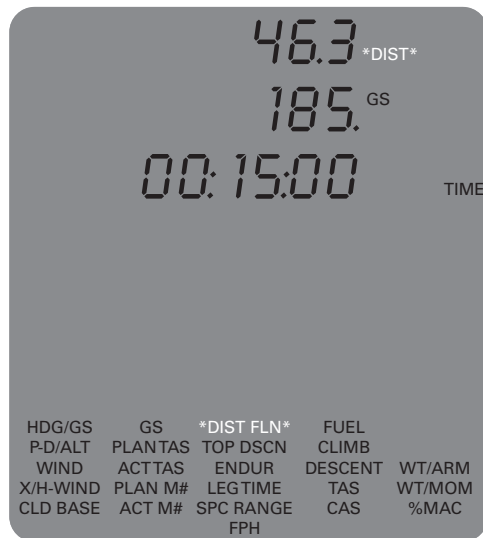

**Note:** The time can also be keyed in as 0.25 hours; see “Adding and Subtracting Time”.

## TOP OF DESCENT (TOP DSCN)

This function determines when to begin a descent to arrive at the destination at a desired altitude given aircraft groundspeed, indicated altitude, desired altitude and rate of descent. In this example, our indicated altitude is 11,500 feet. We desire to be at a pattern altitude of 1,500 feet descending at 600 feet per minute with a groundspeed of 140.

Select **TOP DSCN** from the **FLIGHT** menu

Press **ENTER** and the display will prompt for **GS**

Key in 140 and press **ENTER**

Display will prompt for **IALT**;

Key in 11,500 and press **ENTER**

Display will prompt for **DALT**

Key in 1500 and press **ENTER**

Display will prompt for **RATE**

Key in 600 and press **ENTER**

The display will read:

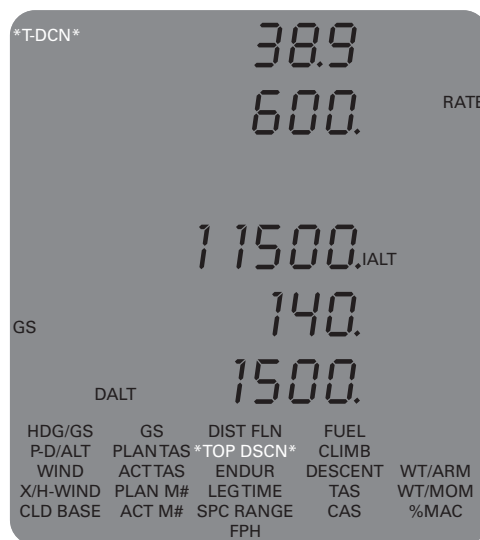

The descent should begin 39 miles from our destination.



## ENDURANCE (ENDUR)

This function calculates endurance given the total fuel on board and the fuel per hour consumption. In this example, fuel on board is 74, and fuel per hour is 14.

Select **ENDUR** from the **FLIGHT** menu

Press **ENTER** and the display will prompt for **FUEL**

Key in 74 and press **ENTER**

The display will prompt for **FPH**

Key in 14 and press **ENTER**

The display will read:



## LEG TIME (LEG TIME)

This function computes the time required to fly a particular distance given distance and ground speed. In this example, distance is 25 and ground speed is 185.

Select **LEG TIME** from the **FLIGHT** menu

Press **ENTER** and the display will prompt for **DIST**

Key in 25 and press **ENTER**

The display will prompt for **GS**

Key in 185 and press **ENTER**

The display will read:



After **LEG TIME** is calculated, the count down timer can be activated starting at the calculated time by pressing

**CONV**

**TIMER**

## SPECIFIC RANGE (SPCRANGE)

Specific range is a planning function used to determine the most desirable altitude for long range flight. Range is calculated in miles given the total fuel, groundspeed and fuel burn. In this example, we will compute aircraft range at 12,000 feet with 140 gallons of fuel. Our fuel burn will be 24 gallons per hour with a groundspeed of 150.

Select **SPC RANGE** from the **FLIGHT** menu

Press **ENTER** and the display will prompt for **FUEL**

Key in 140 and press **ENTER**

The display will prompt for **GS**

Key in 150 and press **ENTER**

The display will prompt for **FPH**

Key in 24 and press **ENTER**

The display will read:

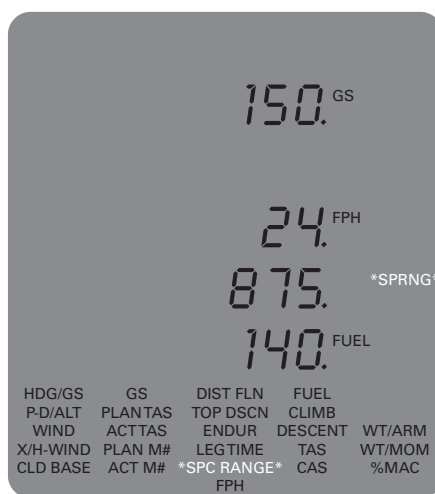

This cruise altitude will yield a range of 875 miles

Following the same sequence for a flight at 8,000 feet with 140 gallons of fuel, a groundspeed of 165 and fuel burn of 27 gallons per hour, a specific range of 855.6 is calculated. An additional 20 miles of range is available at 12,000 feet.

## FUEL PER HOUR (FPH)

This function computes fuel per hour given time and total fuel consumed. In this example, time is 3 hours 15 minutes, and fuel consumed is 45.5 gallons.

Select **FPH** from the **FLIGHT** menu

Press **ENTER** and the display will prompt for **FUEL**

Key in 45.5 and press **ENTER**

The display will prompt for **TIME**

Key in time of 3 hours, 15 minutes and press **ENTER**

The display will read:



## WEIGHT AND ARM (WT/ARM)

This function is an easy method to compute the proper loading of the aircraft. The E6B will retain and display cumulative totals for center of gravity, (**CG**), gross weight (**GW**), and moment (**MOM**). This will allow you to continue keying in weight and arm values for the plane, passengers and baggage to obtain running totals. In the **WT/ARM** mode, the E6B continuously prompts for new **WT** and **ARM** values.

Arm is the distance in inches from the datum line to the center of gravity of an item. The datum line is an imaginary line established by the manufacturer from which all arm measurements are taken. The moment is the product of arm times weight, divided by the reduction factor. The reduction factor (**RF**) is adjustable, but most **WT/ARM** calculations will use a reduction factor of 1

In this example, aircraft empty weight is 2467, arm is 76.7", and the reduction factor is 1.

Select **WT/ARM** from the **WT/BAL** menu

Press **ENTER** and the display will prompt for **WT**

Key in 2467 and press **ENTER**

The computer will prompt for **ARM**

Key in 76.7 and press **ENTER**

The computer will prompt for **RF** and the computer will input a default value of 1.

Press **ENTER**

The display will read:

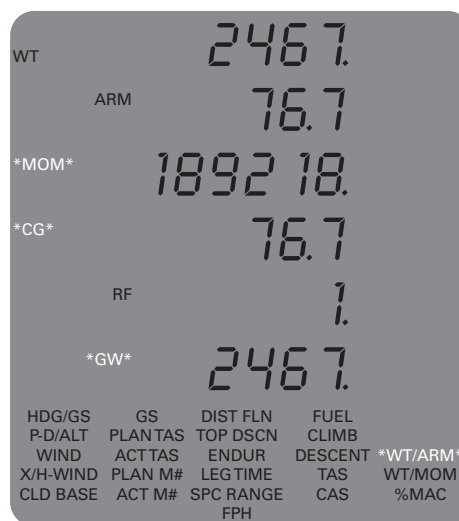

After keying in the airplane's empty weight and arm, the next step is to calculate the weight and balance for the aircraft at takeoff. For this example, we'll assume the following load:

<b>Item</b>	<b>Weight</b>	<b>Arm</b>
Fuel	72.5 gal (6 lbs./gal.)	75
Front passengers	340	75
Rear passengers	340	115
Baggage	18	164

With above display showing, press **ENTER**

Key in 72.5 **x** 6 **=** ; **WT** will display 435

Press **ENTER** ; Key in **ARM** of 75; Press **ENTER**

New totals will appear for **MOM**, **CG** and **GW**. The passengers can be added onto the total in the same manner the fuel was added above. **RF** will remain the same throughout the problem; therefore, you will only be prompted once for the **RF**. The final calculations can be used to confirm that the weight and **CG** are within the airplane's operating limitations.

When finished, the cumulative totals will be displayed. The screen will display:

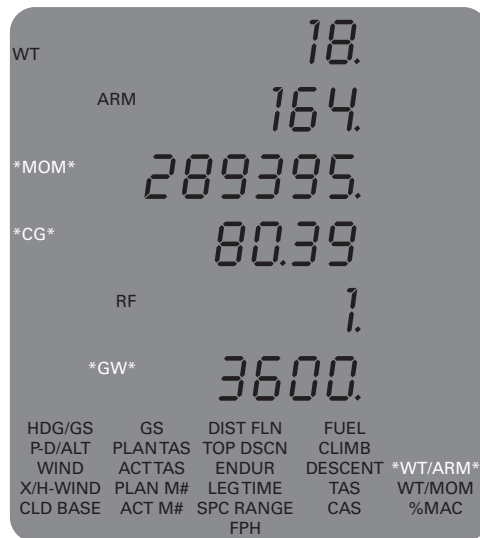

## WEIGHT AND ARM (cont.)

Weight can also be moved or subtracted. Suppose one of the rear seat passengers can't make the trip:

Press **ENTER**

Key in **WT** of 170 and press **+/-** ; Press **ENTER**

Key in **ARM** of 115; Press **ENTER**

The screen will display:

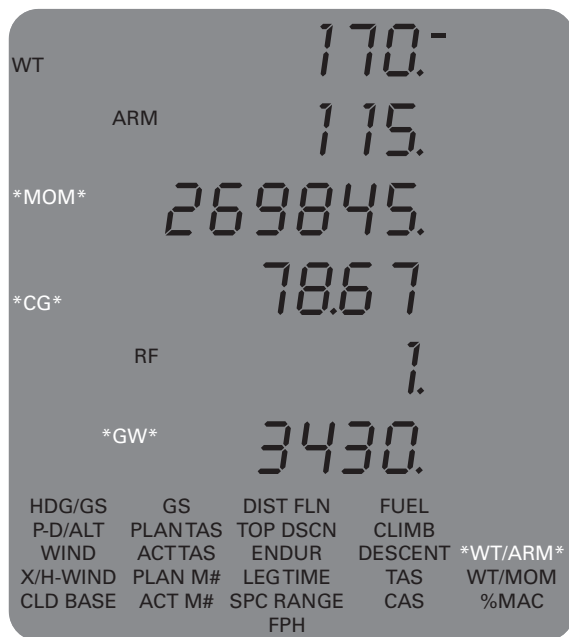

## WEIGHT AND MOMENT (WT/MOM)

This function is similar to the **WEIGHT AND ARM** function. However, flight manuals for some aircraft describe weight and balance problems in terms of moments. Sporty's E6B will retain and display cumulative totals for center of gravity, gross weight and moment given weight and moment for each item and reduction factor. Reduction Factor is 100. As an example, use the following table for entry:

<b>ITEM</b>	<b>WEIGHT</b>	<b>MOM/100</b>
Empty weight	3472	1220
Seat #1	170	63
Seat #2	160	59
Seat #3	100	68
Seat #4	120	82
Baggage, nose compartment	100	-31
Baggage, rear compartment	60	74
Fuel, main tanks	600	210
Fuel, auxiliary tanks	378	178

Select **WT/MOM** from the **WT/BAL** menu

Press **ENTER** and the display will prompt for **WT**

Key in 3472 and press **ENTER**

The display will prompt for **MOM**

Key in 1220 and press **ENTER**

The display will prompt for **RF**

Key in 100 and press **ENTER**



## WEIGHT AND MOMENT (cont.)

The display will read:

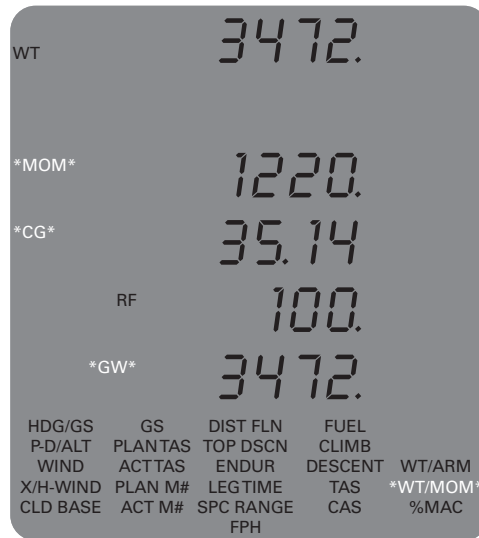

Press **ENTER** to input remaining weights and moments.

Since the **RF** has already been keyed in, the computer will not prompt for **RF** after the first entry. The E6B will keep running totals for moment, center of gravity and gross weight.

When finished, the display will read:

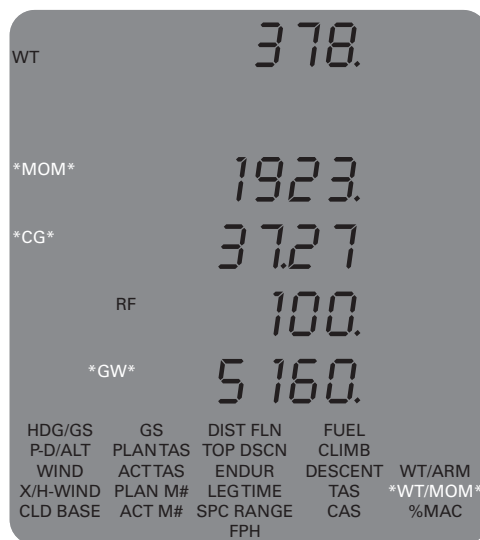

Totals for moment, center of gravity, and gross weight should then be checked against the aircraft's approved operating limits.

## PERCENT MAC (%MAC)

This function computes the percent of mean aerodynamic chord, or the percentage distance of the center of gravity from the leading edge to the trailing edge of the wing. Leading edge mean aerodynamic chord, the center of gravity, and the mean aerodynamic chord. In this example, leading edge mean aerodynamic chord (**LEMAC**) is 22.29, the **CG** is 37.27, and the mean aerodynamic chord (**MAC**) is 61.4.

Select **%MAC** from the **WT/BAL** menu

Press **ENTER** and the display will prompt for **LEMAC**

Key in 22.29 and press **ENTER**

The display will prompt for **CG**

Key in 37.27 and press **ENTER**

The display will prompt for **MAC**

Key in 61.4 and press **ENTER**

The display will read:



The total for **%MAC** should be checked against the aircraft's approved operating limits.

**APPENDIX A**  
**SAMPLE PROBLEMS**

**TIME**

$$4:45:00 + 2:15:30 = 07:00:30$$

$$6.7 - 5:20:00 = 01:22:00$$

**CONVERSIONS**

25 pounds to kilograms	11.34
12 kilograms to pounds	26.46
25 gallons of AvGas to pounds of fuel	150
87.1 pounds of fuel to gallons of AvGas	14.52
30 feet to meters	9.14
100 meters to feet	328.08
250 gallons of jet fuel to pounds of fuel	1675
3025 pounds of fuel to gallons of jet fuel	451.49
32° Fahrenheit to Celsius	0°
100° Celsius to Fahrenheit	212°
100 nautical miles to kilometers	185.2
50 kilometers to nautical miles	27
9.5125 decimal hrs to hms	9:30:45
12:30:30 hms to decimal hrs	12.5083
87 nautical miles to statute miles	100.12
115 statute miles to nautical miles	99.93
1 U.S. gallon to liters	3.79
10 liters to U.S. gallons	2.64
1 inches of mercury to millibars	33.86
1024 millibars to inches of mercury	30.24

**INPUT**

**OUTPUT**

**HDG/GS**

W DIR	270		
W SPD	20	GS	192.2
CRS	355	HDG	349
TAS	195	WCA	-6

**P-D/ALT**

IALT	10000	PALT	9926
BARO	30.00	DALT	11028
T°C	5		

**INPUT****OUTPUT****GS**

DIST 32  
 TIME 00:15:00

GS 128

**PLAN TAS**

PALT 12000  
 T°C 2  
 CAS 195

TAS 237.7  
 MACH# 0.37  
 DALT 13226

**ACT TAS**

PALT 12000  
 I°C 2  
 CAS 195

TAS 234.5  
 MACH# 0.37  
 DALT 12375

**PLAN M#**

T°C -45  
 MACH# 0.82

TAS 482.8

**ACT M#**

I°C -52  
 MACH# 0.82

TAS 445.6

**FUEL REQ**

TIME 02:45:00  
 FPH 14

FUEL 38.5

**REQCLIMB**

MCLM 400  
 GS 80

MROC 533.3  
 % 6.6

**REQ/DSCN**

GS 220  
 IALT 20000  
 CRALT 11000  
 FXDIS 25

RQ/DN 1320

**APPENDIX A (cont.)****INPUT****OUTPUT****REQ TAS**

W DIR 270  
W SPD 20  
CRS 355  
GS 192

TAS 194.8  
HDG 349

**REQ CAS**

PALT 8000  
T°C 12  
TAS 185

CAS 160.7  
MACH# 0.28  
DALT 9461.9

**WIND**

CRS 355  
TAS 195  
GS 175  
HDG 349

W DIR 307.9  
W SPD 27.8

**X/H-WIND**

W DIR 200  
W SPD 17  
RWY 22

X-WIND -5.8  
H-WIND -16

**CLD BASE**

OAT°C 15  
DEW°C 10

CLOUD AGL 2045.5

**DIST FLN**

GS 220  
TIME 02:10:00

DIST 476.7

**TOP/DSCN**

GS 230  
IALT 22000  
DALT 1000  
RATE 1500

T-DCN 53.7

**INPUT****OUTPUT****ENDUR**

FUEL	70	TIME	05:00:00
FPH	14		

**LEG TIME**

DIST	25	TIME	00:07:42
GS	195		

**SPCRANGE**

FUEL	2500		
GS	280	SPRNG	1000
FPH	700		

**FPH**

FUEL	33	FPH	12
TIME	02:45:00		

**%MAC** (using CG from WT/MOM problem)

LEMAC	285.6		
CG	308.08	%MAC	27.8
MAC	81		

**WT/ARM**

	<u>WT</u>	<u>ARM</u>	<u>MOM</u>	<u>GW</u>
empty	2467	76.7	189218	2467
RF 1				
fuel	444	75.0	222518	2911
front seat	340	75.0	248018	3251
2nd row	0	115		
3rd row	0	148		
baggage	100	164	264418	3351
CG = 78.91				

## APPENDIX A (cont.)

### WT/MOM

Payload computations

<u>ITEM</u>	<u>WEIGHT</u> (pounds)	<u>MOMENT</u> /1000
Basic operating weight	8916	2809.0
<b>Cabin</b>		
Seat 3	170	37.7
Seat 4	160	35.5
Seat 5	190	50.5
Seat 6	110	29.3
<b>Baggage</b>		
Nose	60	4.4
Tail cone	110	50.8
Zero fuel weight	9716	3017.2
+ Fuel	5424	1644.1
= Ramp weight	15,140	4661.3
— Taxi fuel	-200	-61.8
= Takeoff gross weight	14,940	4599.5
— En Route fuel	-2000	-612.9
= Landing weight	12940	3986.6
CG =	308.08	

## WEIGHT AND MEASURE

### CONVERSIONS

1 inch	=	2.54 centimeters
1 centimeter	=	0.3937 inches
1 statute mile	=	1.61 kilometers
1 kilometer	=	0.62 statute miles
1 statute mile	=	0.869 nautical miles
1 nautical mile	=	1.151 statute miles
1 U.S. gallon	=	0.833 Imperial gallons
1 Imperial gallon	=	1.201 U.S. gallons
1 liter	=	0.22 Imperial gallons
1 Imperial gallon	=	4.55 liters
1 ounce	=	28.35 grams
1 gram	=	0.035 ounces
1 inch of Mercury	=	33.86 millibars
1 millibar	=	0.0295" of Mercury



## BATTERY REPLACEMENT

Your E6B computer requires three 1.5 volt AAA batteries. The life of the batteries depends on the frequency of use and the type of battery used.

To replace the batteries:

**1.** The battery cover is located on the top rear of the calculator. Use your thumb to unlock the battery cover clip and lift the cover off.

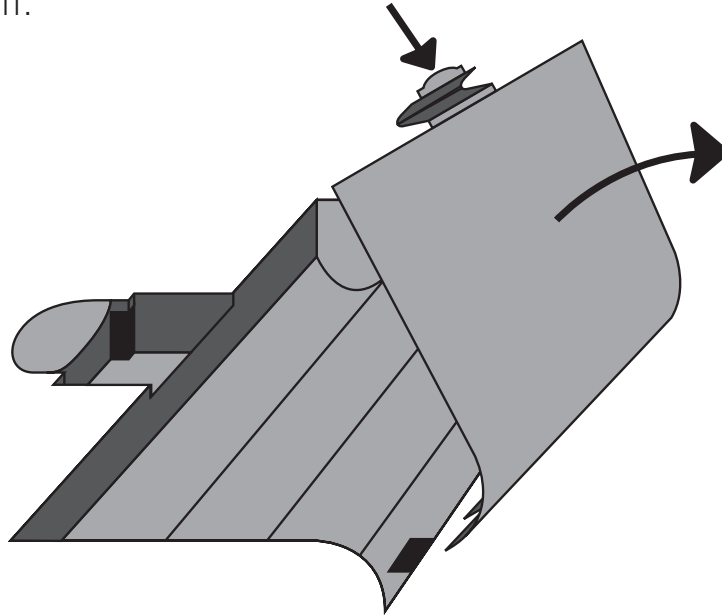

**2.** Install the negative (-) end of the battery against the spring and the positive (+) end against the contact. Install three batteries. Put the battery cover back into place and push down until the clip locks.

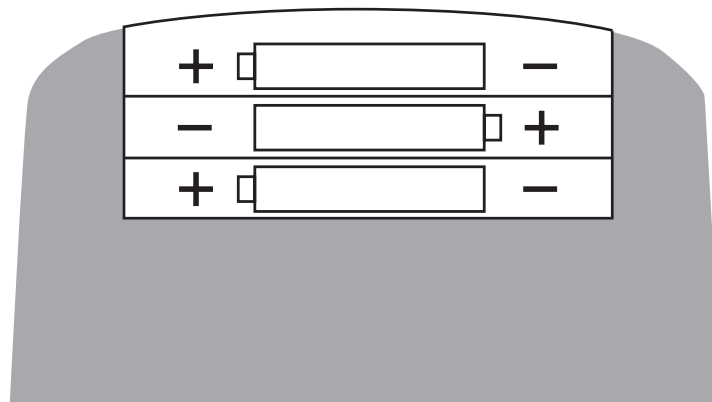

## TROUBLESHOOTING AND CARE

- 1.** Batteries should last from six to nine months depending on use. If your E6B fails to respond or the display becomes dim, replace the batteries. Installation of new batteries should be checked to ensure proper placement.
- 2.** Improper input of data will cause incorrect answers. Read the operating instructions to ensure that you are entering problems correctly. Also be sure that units agree, i.e., all units in statute miles, nautical miles, or kilometers.
- 3.** Your E6B is designed to withstand a wide range of temperatures. However, exposure to direct sunlight or excessive temperatures for prolonged periods may cause the display to go blank. If this occurs, move the calculator to a cooler place and the display will return.
- 4.** Solvents should not be used to clean your E6B. To clean the display, use a clean eyeglass lens tissue.
- 5.** To conserve battery life, deactivate timer when computer is not in use.
- 6.** If the computer does not respond to these steps, return it to us with a detailed description of the difficulty you are having. Pack the E6B carefully to prevent damage during shipping. Include your name, address, and phone number, and return it to:

Sporty's Pilot Shop  
Clermont County / Sporty's Airport  
2001 Sporty's Drive  
Batavia, Ohio 45103

## **SPORTY'S E6B CALCULATOR FIVE YEAR LIMITED WARRANTY**

Our limited warranty is simple. If your E6B fails due to defective workmanship or parts during normal use in its first five years, we will replace or repair it at our option.

This warranty does not apply to units subjected to misuse, battery leakage, neglect or accidents. This warranty does not apply to units damaged by excess moisture or to units repaired or altered outside the factory.

To have your unit serviced under this warranty, return it postage paid with proof of purchase to:

Sporty's Pilot Shop  
Clermont County / Sporty's Airport  
2001 Sporty's Drive  
Batavia, Ohio 45103

**Note:** Sporty's E6B is an instruction and information aid, and is not an avionics instrument.

# Notes

# Notes

# **sporty's<sup>®</sup> pilot shop**

**Clermont County/Sporty's Airport**

**2001 Sportys Drive**

**Batavia, Ohio 45103-9747**

**1-800-SPORTYS (776.7897)**

**[sportys.com](http://sportys.com)**

---