



EverStrong[®]

PROFILES



EVERSTRONG PROFILES ARE
VMA CERTIFIED AND ASTM COMPLIANT



The VMA (Vinyl
Manufacturers Association)
is the Voice of the
Vinyl Fence and Railing Industry.



INTERNATIONAL
Standards Worldwide

ASTM International is a globally
recognized leader in the
development and delivery of
voluntary consensus standards.



A Full, Comprehensive Vinyl Program For Fence People By Fence People

The EverStrong® Profiles Advantage



EverStrong®
P R O F I L E S



EVERSTRONG PROFILES ARE VMA CERTIFIED

The VMA (Vinyl Manufacturers Association) is the Voice of the Vinyl Fence and Railing Industry

The VMA was formed to advance the following objectives:

- To develop product performance standards to govern all manufacturers and establish a comprehensive certification program to ensure ongoing compliance with the established standards.
- Monitor the activities of consumer and environmental advocacy groups and help to improve the public perception of vinyl fence and railing products.
- Develop trade and consumer educational programs to demonstrate the engineered performance of vinyl fence, deck, and railing products.

What Does This Mean For You?

- With the VMA Certified Seal prominently displayed on your EverStrong® Vinyl Fence and Railing products, you can have the confidence that you are receiving the highest quality vinyl products on the market.
- VMA Certified EverStrong® Profiles products meet or exceed industry standards. EverStrong's company, products, processes, and facilities have been audited by approved third party test labs and inspection agencies.
- The VMA Certified seal offers the peace of mind that purchases made today will withstand the test of time due to the high quality manufacturing and verification processes.

All EverStrong® Profiles Meet ASTM F964-13. Control Tests Including:

D256	To determine Izod impact properties
D618	Practice for Conditioning Plastics for Testing
D635	Test Method for Rate of Burning and/or Extent and Time of Burning of Plastics in a Horizontal Position
D638	To determine tensile properties
D648	To determine heat distortion temperature
D696	Test Method for Coefficient of Linear Thermal Expansion of Plastics Between 030°C and 30°C with a Vitreous Silica Dilatometer
D790	To determine flexural properties
D792	To determine specific gravity
D883	Terminology Relating to Plastics
D1435	Practice for Outdoor Weathering of Plastics
D1600	Terminology for Abbreviated Terms Relating to Plastics
D1784	Specification for Rigid Poly (Vinyl Chloride) (PVC) Compounds and Chlorinated Poly (Vinyl Chloride) (CPVC) Compounds
D1898	Practice for Sampling of Plastics
D2240	To determine Shore hardness values
D2244	Practice for Calculation of Color Tolerances and Color Differences from Instrumentally Measured Color Coordinates
D2565	Practice for Xenon-Arc Exposure of Plastics Intended for Outdoor Applications
D4216	Material Class Number 1-32333-3. To establish Cell Classification of PVC material. Illusions compounds have higher cell classification because one or more properties are superior to those used in standard acceptable compounds
D4226	Test Methods for Impact Resistance of Rigid Poly-(Vinyl Chloride) (PVC) Building Products
D4726	Specification for Rigid Poly(Vinyl Chloride) (PVC) Exterior-Profile Extrusions Used for Assembled Windows and Doors
E-84-04	Used to determine the flame spread value of PVC material; EverStrong® burn rate is significantly lower than allowed value

Competitor:
450 Hrs.
(4-5 Years)

EverStrong®
1000 Hrs.
(10-11 Years)

WOW!
THAT WOULD COST A FORTUNE IN RE-INSTALLS!



EverStrong® Profiles are backed by almost 50 years experience in the fence business as a manufacturer and distributor. We have been in the vinyl fence fabrication business since 1996, and with this knowledge we expanded into extrusion.

All EverStrong® Profiles are inventoried in stock lengths in White, Beige, Gray, and Clay all the time. They are available to ship as soon as your order is placed. That is correct; the only lead time on stock lengths of profiles is giving your address to our carrier.

EverStrong® set up an extrusion plant with the most technologically advanced extruding systems in the industry, some of the most seasoned people in extrusion worldwide, and a complete quality control lab which is unparalleled in our industry.

All EverStrong® Profiles are manufactured to rigid specifications using only the best compounds available in the market.

All EverStrong® Profiles and Accessories are tested and compliant to ASTM as well as our own, more strict specifications.



**A Full, Comprehensive Vinyl Program
For Fence People By Fence People**



EverStrong® Available Profiles



7/8" x 6" TONGUE & GROOVE BOARD

Item #	Description
V78616TGW	7/8" x 6" T&G x 16'
V78664TGW	7/8" x 6" T&G x 64"
V78662TGW	7/8" x 6" T&G x 62"
V78651TGW	7/8" x 6" T&G x 51-1/2"
V78650TGW	7/8" x 6" T&G x 50"
V78647TGW	7/8" x 6" T&G x 47-3/4"



7/8" x 6" BOARD

Item #	Description
V78612W-075	7/8" x 6" x 12'



7/8" x 3" PICKET

Item #	Description
V78316-080	7/8" x 3" x 16'



7/8" x 1-1/2" PICKET

Item #	Description
V78612-075	7/8" x 1-1/2" x 16'



1-1/2" x 1-1/2" PICKET

Item #	Description
V151516-080	1-1/2" x 1-1/2" x 16'



1" x 1" PICKET

Item #	Description
V1116-080	1" x 1" x 16'



VINYL U-CHANNEL

Item #	Description
V7816U	7/8" x 16' U-Channel





EverStrong® Available Profiles



1-1/2" x 5-1/2" SLOTTED RAIL

Item #	Description
V15558WS-080	1-1/2" x 5-1/2" x 8'
V155593WS-080	1-1/2" x 5-1/2" x 93-3/4"
V155570WS-080	1-1/2" x 5-1/2" x 70"



1-1/2" x 5-1/2" RAIL

Item #	Description
V15558W-080	1-1/2" x 5-1/2" x 8'
V155593W-080	1-1/2" x 5-1/2" x 93-3/4"
V155570W-080	1-1/2" x 5-1/2" x 70"



2" x 3-1/2" RAIL

Item #	Description
V2358-120	2" x 3-1/2" x 8'
V2356-120	2" x 3-1/2" x 6'



2" x 3-1/2" T-RAIL

Item #	Description
V2358TR	2" x 3-1/2" x 8' T-Rail Vinyl
V2356TR	2" x 3-1/2" x 6' T-Rail Vinyl

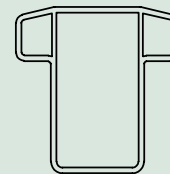

NEW ITEM!

2" x 6" SLOTTED RAIL

Item #	Description
V2616WS-085	2" x 6" x 16' Slotted Rail
V268WS-085	2" x 6" x 8' Slotted Rail



2" x 6" RAIL

Item #	Description
V2616W-085	2" x 6" x 16'
V268W-085	2" x 6" x 8'



2" x 7" DECO RAIL

Item #	Description
V278WS-095	2" x 7" x 8'
V2793WS-095	2" x 7" x 93-3/4"



2" x 8" RAIL

Item #	Description
V288W-105	2" x 8" x 8'



3" x 3" RAIL

Item #	Description
V338-110	3" x 3" x 8'

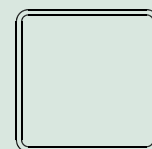



EverStrong® Available Profiles



3-1/2" x 3-1/2" RAIL

Item #	Description
V353516-170	3-1/2" x 3-1/2" x 16' (With Diamonds)

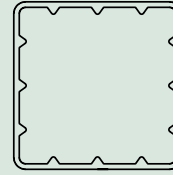

4" x 4" POST

Item #	Description
V4416-115	4" x 4" x 16'
V448-115	4" x 4" x 8'
V447-115	4" x 4" x 7'
V446-115	4" x 4" x 6'
V4416-175	4" x 4" x 16' Heavy Duty

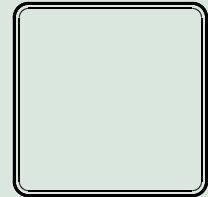
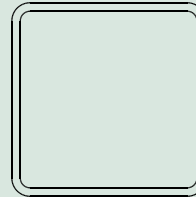

5" x 5" POST

Item #	Description
V5516-140	5" x 5" x 16'
V5512-140	5" x 5" x 12'
V559-140	5" x 5" x 9'
V55102-140	5" x 5" x 102"
V558-140	5" x 5" x 8'
V557-140	5" x 5" x 7'

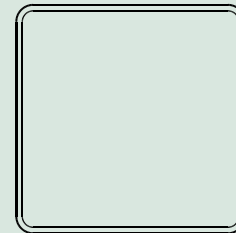

5" x 5" HEAVY DUTY POST

Item #	Description
V5516-300	5" x 5" x 16'
V559-300	5" x 5" x 9'

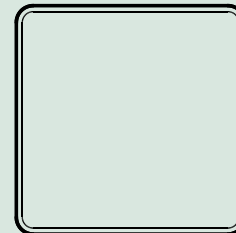

8" x 8" MAJESTIC POST

Item #	Description
V8812B	8" x 8" x 12'
V889B	8" x 8" x 9'

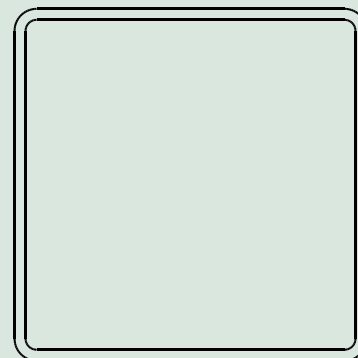



EverStrong® Available Profiles



METAL RAIL INSERTS

Item #	Description
U-CHANNEL	Galv. Steel Reinforcement Channel 93.75" for 1-1/2" x 5-1/2"
U-CHANNEL26	Galv. Steel Reinforcement Channel 93.75" for 2" x 6"

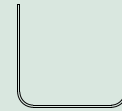

ALUMINUM REINFORCEMENT INSERT

Item #	Description
AHC6	Aluminum Reinforcement Insert 6'
AHC8	Aluminum Reinforcement Insert 8'
AHC10	Aluminum Reinforcement Insert 10'

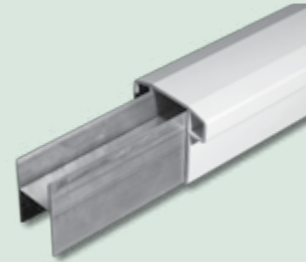

HALF ARCH WELDED (FOR 42" WIDE - 72" WIDE GATES)

Item #	Description
--------	-------------



VBHAW	2" x 3-1/2" for 42"W - 72"W Gates
-------	-----------------------------------



HALF ARCH WELDSHOWN WITH 8" x 8" MAJESTIC POSTS

ALUMINUM POST INSERTS

Item #	Description
--------	-------------

API9	4.5" x 4.5" x 9' Aluminum Post Insert
------	---------------------------------------

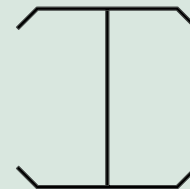

NEW ITEM!

VINYL GATE INSERT

Item #	Description
--------	-------------

VGI44	Vinyl Gate Insert (Fits 1-1/2" or 2" Rails)
-------	---

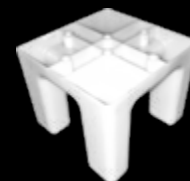

NEW ITEM!



PRIVACY



NEW DRIFTWOOD WOODGRAIN!

Privacy Panels feature a "V"-Jointed tongue and groove board and come with a wide variety of decorative tops. Privacy fence panels include a metal reinforcement channel in the bottom rail to help create a stronger and longer lasting fence. We pride ourselves on offering a Privacy Panel for every taste. They are also offered in color and woodgrain. Lattice comes in color and woodgrain.

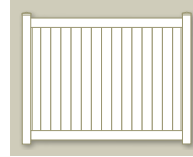

PRIVACY

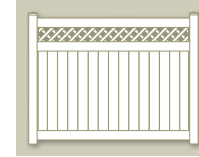

**PRIVACY WITH
DIAGONAL LATTICE**

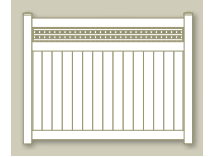

**PRIVACY WITH
SQUARE LATTICE**

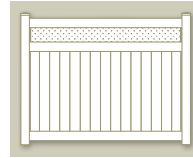

**PRIVACY WITH
SMALL DIAGONAL
LATTICE**

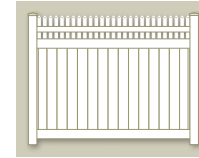

**PRIVACY WITH
STRAIGHT
PICKET TOP**

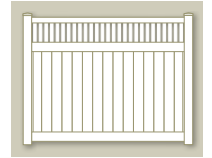

**PRIVACY WITH
FRAMED
PICKET TOP**

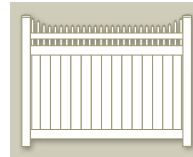

**PRIVACY WITH
STEPPED
PICKET TOP**

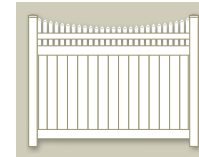

**PRIVACY WITH
SCALLOPED
PICKET TOP**



**PRIVACY WITH
ARCHED
PICKET TOP**



PRIVACY

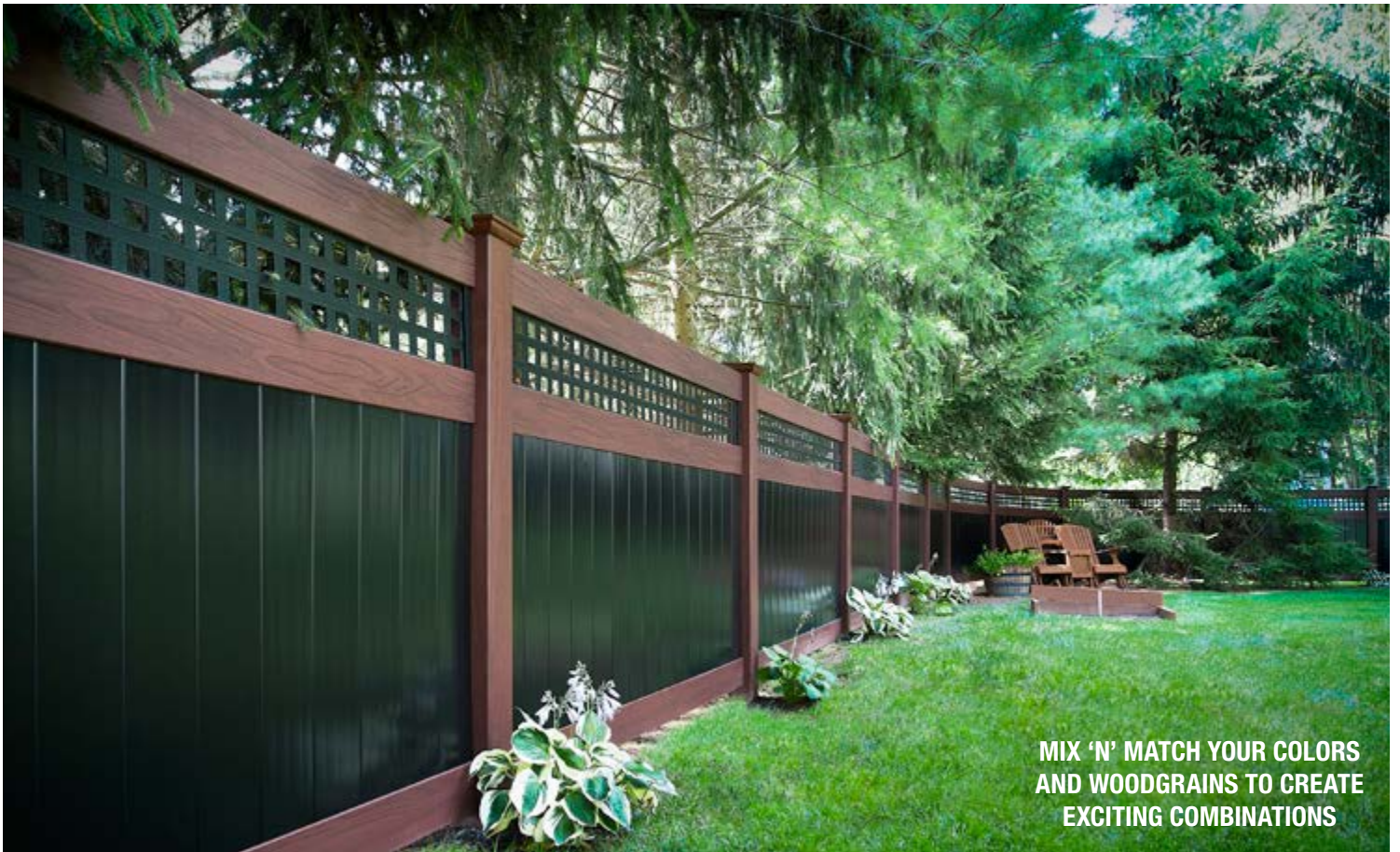

MIX 'N' MATCH YOUR COLORS
AND WOODGRAINS TO CREATE
EXCITING COMBINATIONS

SEMI-PRIVACY

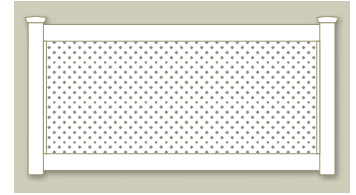

SMALL DIAGONAL LATTICE

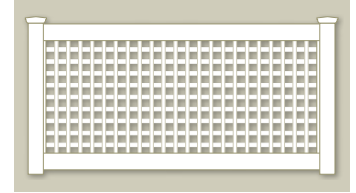

OLD ENGLISH LATTICE

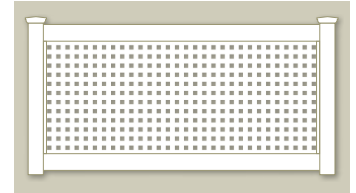

SQUARE LATTICE

The Semi-Privacy line has one of the largest selections we offer. Customers are invited to pick one of our pre-made styles or to custom design their own. Semi-Privacy panels are specially designed to offer privacy without a “closed in” feeling. Our extensive selection offers open lattice styles as well as the more secure “front to back” large picket styles. All are available in color and woodgrain.

Semi-Privacy fence panels include a metal reinforcement channel in the bottom rail to help create a stronger and longer lasting fence. Also popular in the Semi-Privacy series is “Old English Lattice.” It’s designed to look like a vinyl version of the common fence style used for growing vines, gardens, and hedgerows.

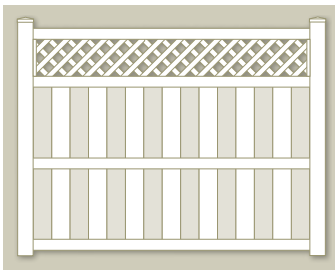

BOARD ON BOARD WITH DIAGONAL LATTICE

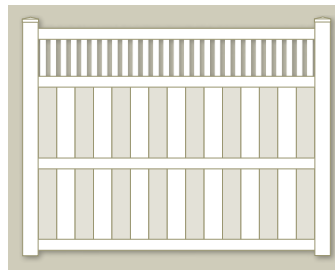

BOARD ON BOARD WITH FRAMED PICKET TOP

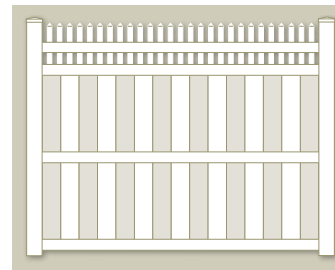

BOARD ON BOARD WITH STRAIGHT PICKET TOP

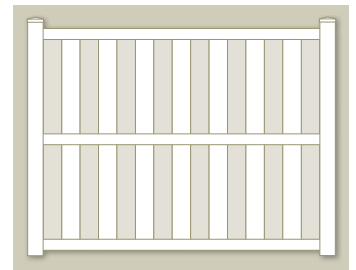

BOARD ON BOARD

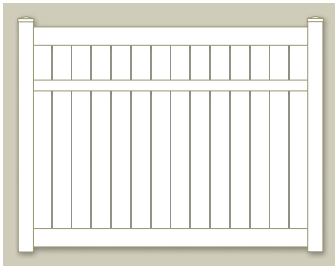

SEMI-PRIVACY WITH 6” BOARDS

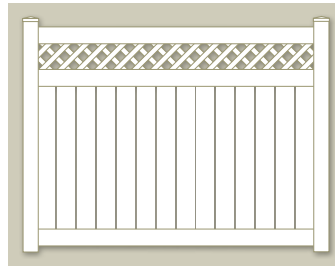

SEMI-PRIVACY WITH 6” BOARDS AND DIAGONAL LATTICE

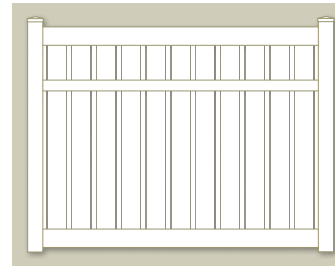

SEMI-PRIVACY WITH ALTERNATING 6” AND 1-1/2” BOARDS

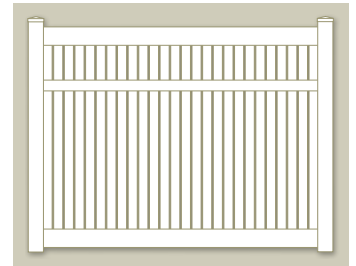

SEMI-PRIVACY WITH 3” BOARDS



CLASSIC VICTORIAN PICKET

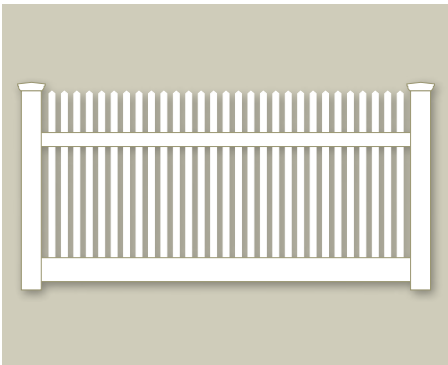

1-1/2" X 1-1/2" STRAIGHT TOP PICKET

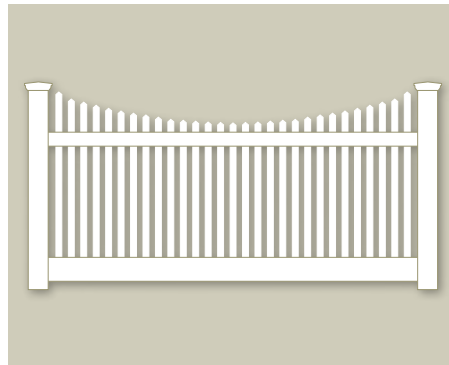

1-1/2" X 1-1/2" SCALLOPED PICKET

One of the most popular fence styles in the USA is the Classic Victorian Picket. Using 1-1/2" x 1-1/2" pickets, it is a maintenance-free look alike of the old red cedar fence. All of the panels are carefully designed with the classic look in mind and all are available in color and woodgrain.



1-1/2" X 1-1/2" STAGGERED TOP PICKET

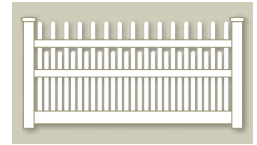

1-1/2" X 1-1/2" STAGGERED TWO-RAIL

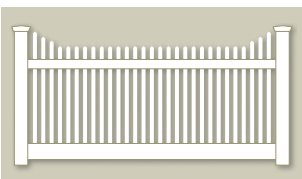

1-1/2" X 1-1/2" STEPPED TOP PICKET

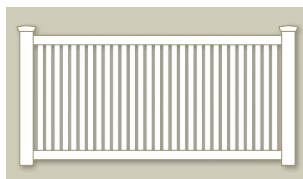

1-1/2" X 1-1/2" FRAMED TOP PICKET

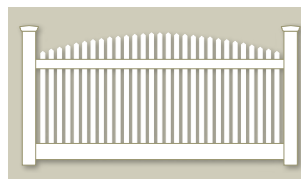

1-1/2" X 1-1/2" ARCHED TOP PICKET

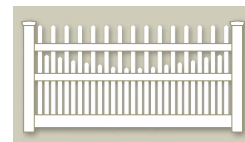

1-1/2" X 1-1/2" SCALLOPED TWO-RAIL



1-1/2" X 1-1/2" FRAMED TWO-RAIL



CONTEMPORARY PICKET

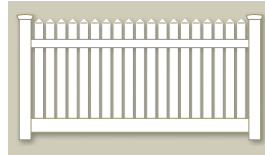

7/8" X 3" PICKETS WITH POINTED PICKET CAPS (REDUCED SPACING)

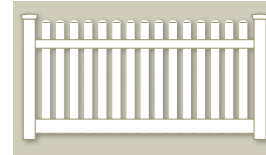

7/8" X 3" PICKETS WITH DOG-EAR PICKET CAPS

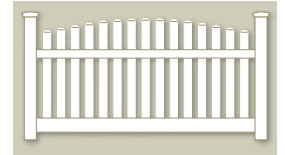

7/8" X 3" ARCHED PICKETS W/ DOG-EAR PICKET CAPS

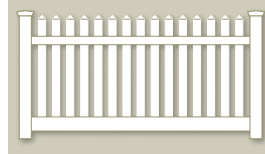

7/8" X 3" PICKETS W/ POINTED PICKET CAPS

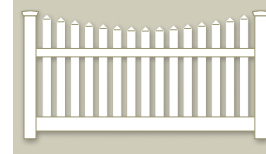

7/8" X 3" SCALLOPED PICKETS W/ POINTED PICKET CAPS



7/8" X 3" STEPPED PICKETS W/ POINTED PICKET CAPS

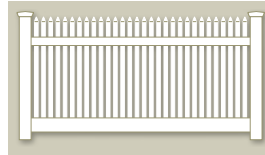

7/8" X 1-1/2" PICKETS W/ POINTED PICKET CAPS

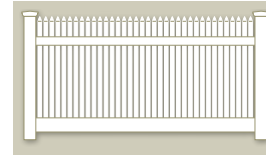

7/8" X 1-1/2" PICKETS W/ POINTED PICKET CAPS (REDUCED SPACING)

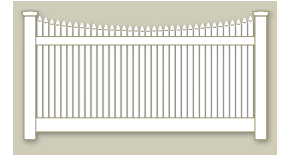

7/8" X 1-1/2" SCALLOPED W/ POINTED PICKET CAPS (REDUCED SPACING)

Contemporary Picket offers what is known as the "good neighbor" approach to fencing. It is a fence that features both sides of the panels being exactly the same. The pickets are assembled THROUGH the rails instead of simply being attached to them.



ORNAMENTAL PICKET

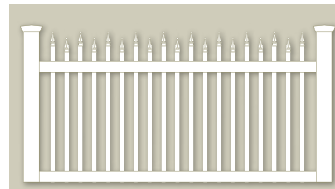

1" X 1" ORNAMENTAL PICKET FENCE WITH STAGGERED PICKET TOPS

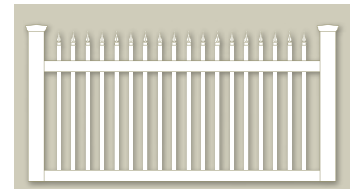

1" X 1" ORNAMENTAL PICKET FENCE WITH STRAIGHT PICKET TOP

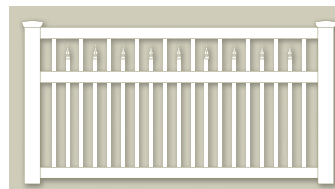

1" X 1" ORNAMENTAL PICKET FENCE WITH STAGGERED FRAMED PICKET TOP

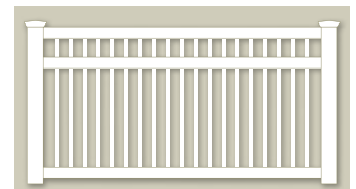

1" X 1" FRAMED TOP ORNAMENTAL PICKET FENCE

Ornamental 1" x 1" Picket offers a vinyl alternative to the wrought iron fence. It enables the homeowner to maintain the look of wrought iron without the maintenance.

PICKET TOP STYLES



ARROWHEAD



BOY SCOUT



GOthic



POST & RAIL



Our Post & Rail fence is available with three different styled rails for the Two-Rail, Three-Rail, Four-Rail or Crossbuck fence. Whatever setting you may have, we have the look you want and the strength you need. We also offer all Post & Rail styles in color and woodgrain.



2-RAIL



3-RAIL



4-RAIL

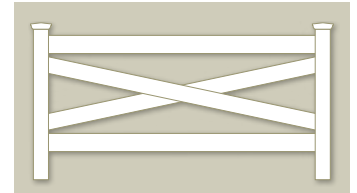

CROSSBUCK



2-RAIL DIAMOND

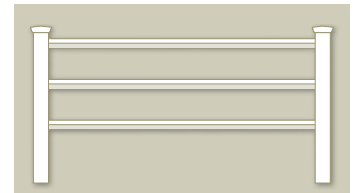

3-RAIL DIAMOND



RAILING



EverStrong® offers a complete lines of vinyl railings. All railing panels contain a metal channel in the top-rail. Some styles are also offered in Grand Illusions colors and woodgrains. An optional metal channel for the bottom rail is available for extra protection.

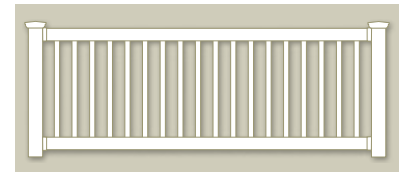

TRADITIONAL - 2" X 3.5" TOP-RAIL

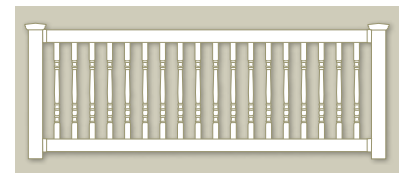

COLONIAL - 2" X 3.5" TOP-RAIL

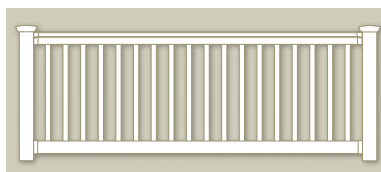

TRADITIONAL - T-RAIL TOP-RAIL

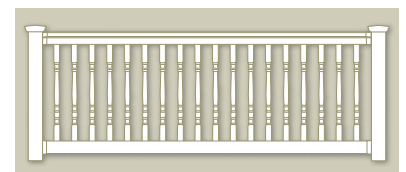

COLONIAL - T-RAIL TOP-RAIL



CURVES & TRANSITIONS



Are you looking for the perfect finishing touch for your fence installation? EverStrong® Curved and Transitions Rails have many different options to help bring out the beauty of your landscaping and home or installation. They can be mixed and matched to show creative style and enhance any section. You can even get them in Grand Illusions Color Spectrum™ and Grand Illusions Vinyl WoodBond™.

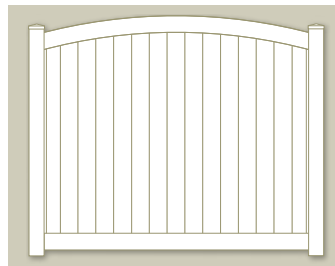

ARCHED PRIVACY

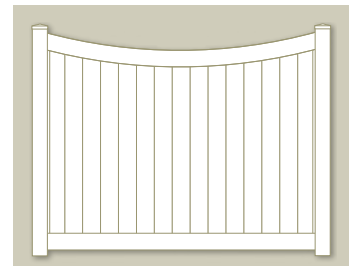

SCALLOPED PRIVACY





CURVES & TRANSITIONS

EverStrong offers many options to enhance the look and feel of your fence installation.

Looking for a perfect fence idea to go with your creative personality?

Consider one of these terrific curved, transition, and rounded corner styles for your next project.

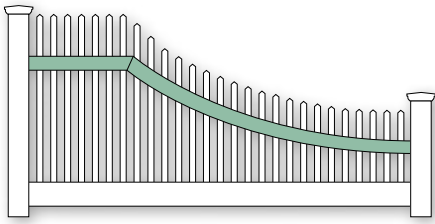

WATERFALL "A" SLOPE RAIL

Available in ALL fence styles

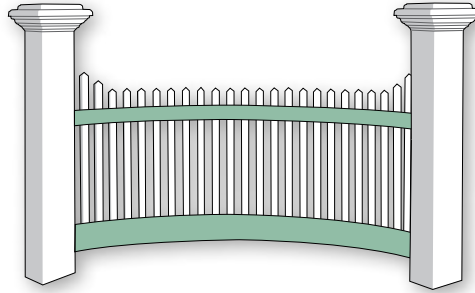

RADIUS "E" RAIL

Only available in picket fence styles

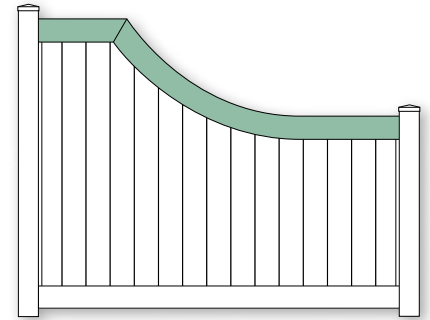

WATERFALL "H" RAIL

Available in all full privacy and Semi-privacy fence styles

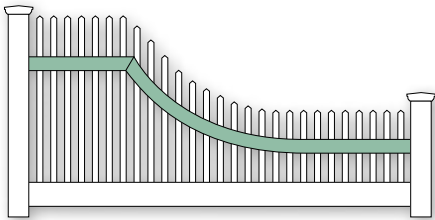

WATERFALL "B" SWEEP RAIL

Available in ALL fence styles

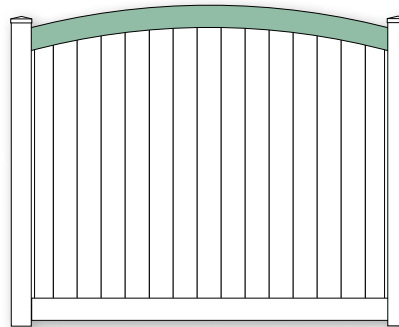

CROWNED "F" RAIL

Available in all full privacy and Semi-privacy fence styles

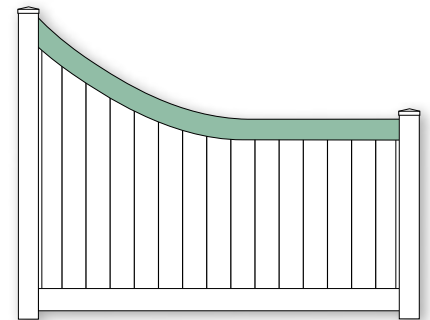

SWEEP "I" RAIL

Available in all full privacy and Semi-privacy fence styles

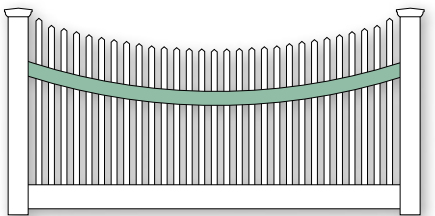

SCALLOPED "C" RAIL

Available in ALL fence styles

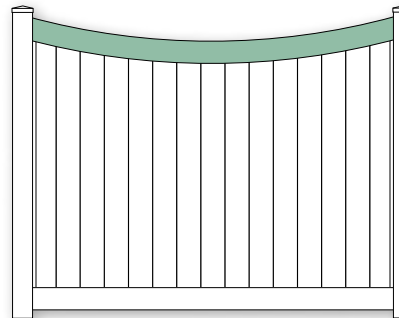

SCALLOPED "G" RAIL

Available in all full privacy and Semi-privacy fence styles

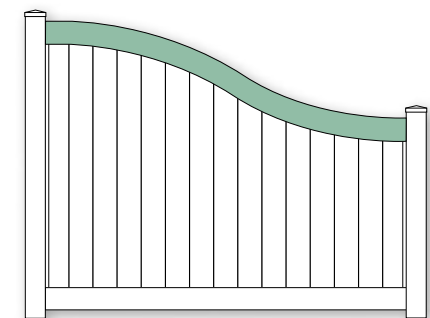

S-CURVED STYLED "J" RAIL

Available in all full privacy and Semi-privacy fence styles

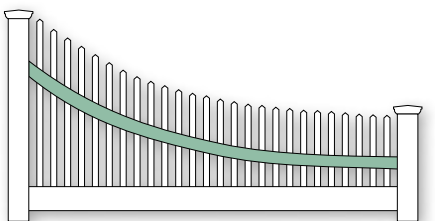

SWEEP "D" RAIL

Available in ALL fence styles



ARBORS & PERGOLAS



ARBORS & PERGOLAS



EverStrong Arbors & Pergolas are an important option to help add flair to your fence installation by taking it from a good looking fence install to a great looking fence install in one simple step. Use with a gate or as a fun ornament for your landscaping.

ASK ABOUT
 8' x 8'
 8' x 12'
 10' x 10'
 10' x 12'
 12' x 12'
 PERGOLA KITS

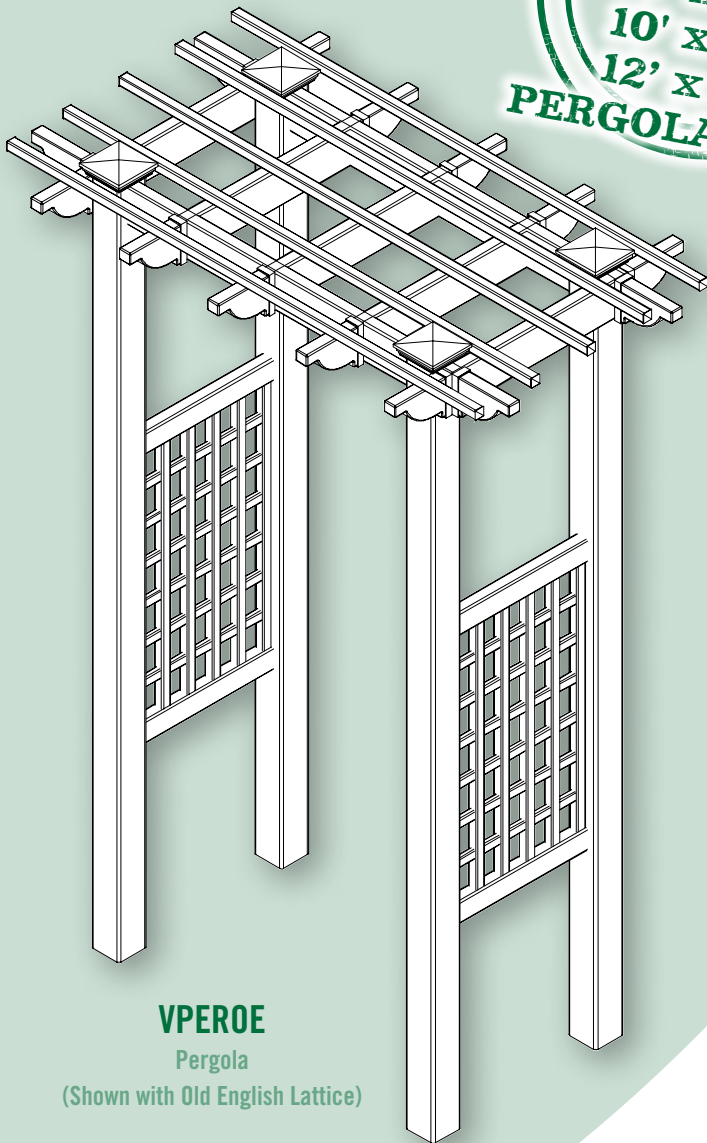

VPEROE
 Pergola
 (Shown with Old English Lattice)

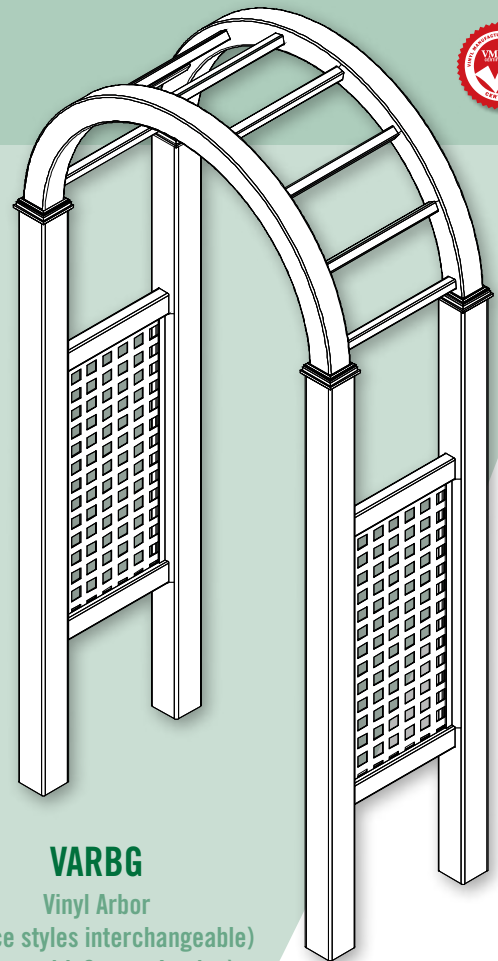

VARBG
 Vinyl Arbor
 (Lattice styles interchangeable)
 (Shown with Square Lattice)

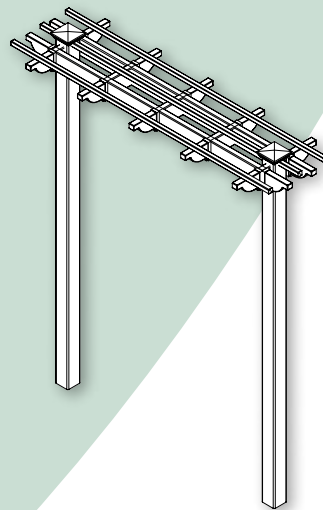

VPER2P
 2 Post Pergola

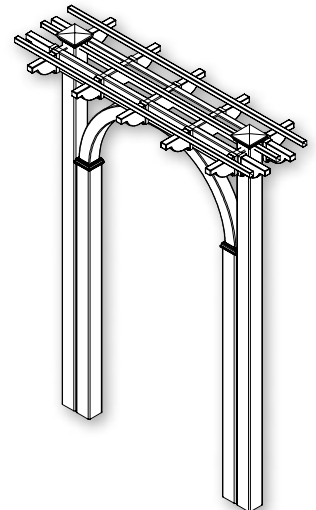

VPER4P
 4 Post Pergola with Arch

NOTE: Only up to 75" wide for arbors

COLOR OPTIONS

Classic Series

Looking for something simple and timeless?
Check out your 4 Illusions
"Classic" color options:
White, Beige, Gray, and Clay.



CLASSIC WHITE

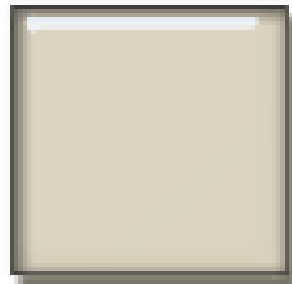

CLASSIC BEIGE



CLASSIC GRAY



CLASSIC CLAY (NEW!)

ALL COLORS SHOWN ARE APPROXIMATE.
SEE PHYSICAL SAMPLE FOR ACTUAL COLOR.



EverStrong[®]
P R O F I L E S



NEW COLOR
**Classic
Clay**



All Classic Series Colors Are Available in All Profiles

COLOR OPTIONS

Color Vinyl Fence!

EverStrong® Fence Styles are available in these colors and more!
Grand Illusions Color Spectrum™ is the next evolution of a product. Choose from 32 different low gloss colors of vinyl fence. You can even Mix 'n' Match™ your colors to create incredible home accent matching fence installations.

(ALL GRAND ILLUSIONS COLORS AND WOODGRAINS AVAILABLE IN ASSEMBLED PANELS ONLY)

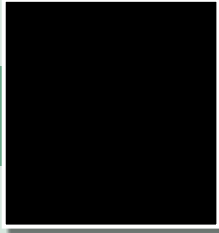

Black



Brown



Hunter Green



Slate Gray

Grand Illusions Color Spectrum FOCUS COLORS

The above four colors with matching posts, caps, and matching 4' and 5' wide gates are in stock and available for immediate shipment in V300-6 privacy panels (6'H x 8'W).

ALL COLORS SHOWN ARE APPROXIMATE. SEE PHYSICAL SAMPLE FOR ACTUAL COLOR.



- Low Gloss Matte Finish
- Mix 'n' Match™ Your Colors
- Sky2Blue™ Color Protection



GRAND ILLUSIONS

VINYL WOODBOND

WOODGRAIN VINYL FENCE



**YES!
THIS IS
VINYL!**

**NEW COLOR
Driftwood**



Mahogany

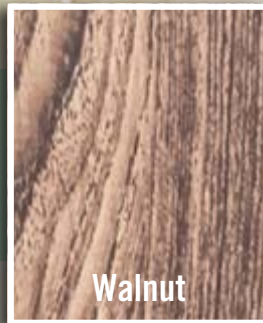

Walnut

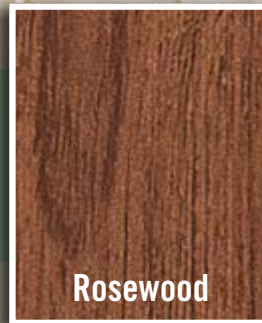

Rosewood



**Eastern
White Cedar**

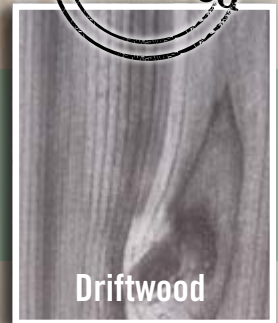

Driftwood

ALL COLOR SWATCHES SHOWN ARE APPROXIMATE. SEE PHYSICAL SAMPLE FOR ACTUAL COLOR.

(ALL GRAND ILLUSIONS COLORS AND WOODGRAINS AVAILABLE IN ASSEMBLED PANELS ONLY)

6' Height shown in Grand Illusions Vinyl WoodBond Eastern White Cedar with French Gothic (V55FG) post caps



Endless Color Possibilities...

All of these beautiful low gloss Grand Illusions Color Spectrum colors are created to match common home accent colors. You can Mix 'n' Match™ them with any other Illusions colors as well. (These colors are not available through the QuickShip™ program. Ask your local dealer for delivery times.)

(ALL GRAND ILLUSIONS COLORS AND WOODGRAINS AVAILABLE IN ASSEMBLED PANELS ONLY)

ALL STYLES AVAILABLE IN ALL COLORS.

Colors shown are approximate. See physical sample for actual color.

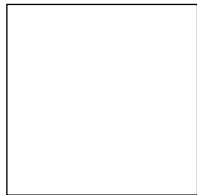

Patio White

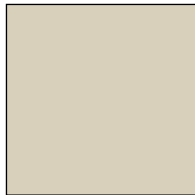

Tan

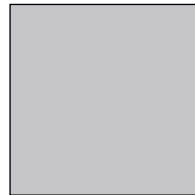

Seacoast Gray



Eastern Green

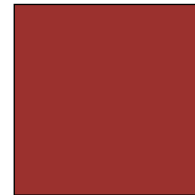

Barn Red

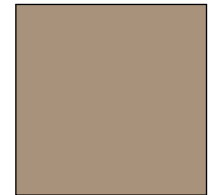

Adobe

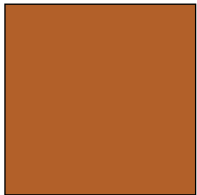

Autumn Orange



Federal Blue

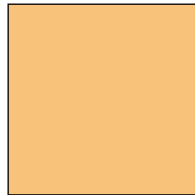

Colonial Yellow

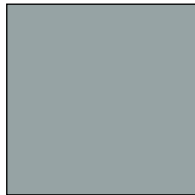

Millennium Gray

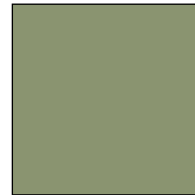

Evergreen

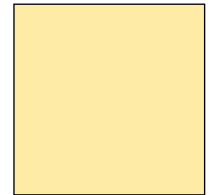

Sahara

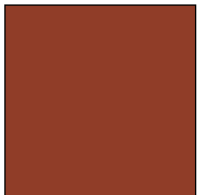

Brick Red

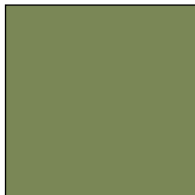

Olive



Burgundy

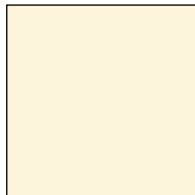

Antique White

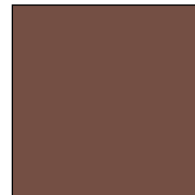

Brownstone

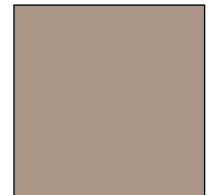

Prairie Dust

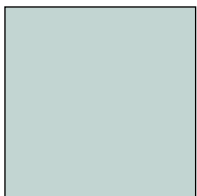

Sky Blue

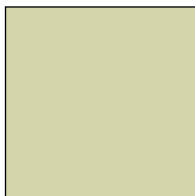

Sage



Midnight Blue



Atlantic Blue



Bordeaux



Forest Green

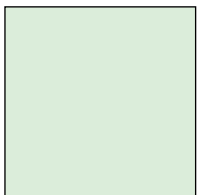

Seafoam Green



Vintage Wine

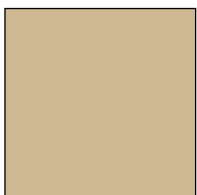

Desert Sand



Dark Royal Blue

Need a custom color?

Give us a swatch and we'll match it!

The *Grand Illusions Color Spectrum "Designer Series"* allows you to match any color. This creates limitless color possibilities for any fence application.





Rosewood



Classic White



Patio White



Classic White



Eastern White Cedar



Classic White



Black

SEE WEBSITE OR FULL SIZED 104 PAGE BROCHURE FOR TONS MORE STYLES AND PHOTOS!

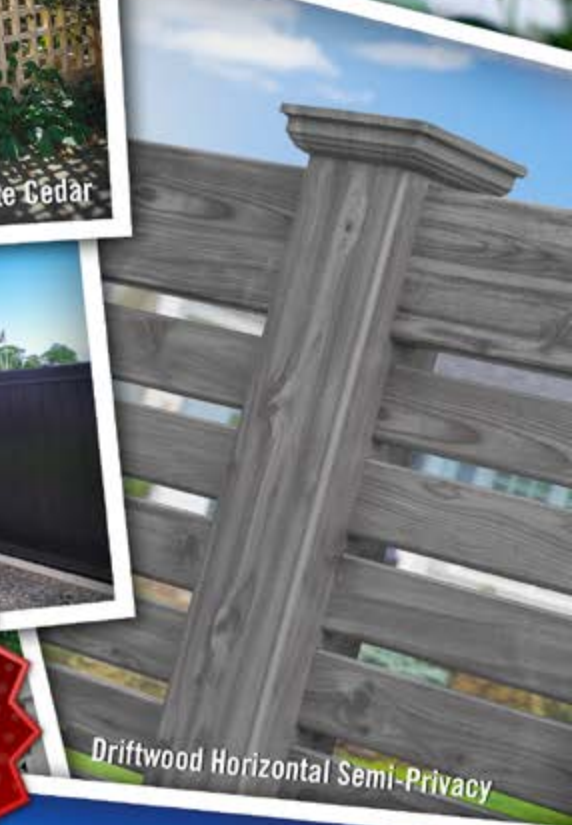

Driftwood Horizontal Semi-Privacy



Patio White & Sahara



Classic Gray



Hunter Green

(ALL GRAND ILLUSIONS COLORS AND WOODGRAINS AVAILABLE IN ASSEMBLED PANELS ONLY)





EVERSTRONG PROFILES ARE VMA CERTIFIED!

The VMA (Vinyl Manufacturers Association) is the Voice of the Vinyl Fence and Railing Industry and this is their certification logo.

EVERSTRONG VINYL PROFILES LIMITED WARRANTY

EverStrong Vinyl Profiles ("EverStrong") warrants to the purchasing homeowner (the "Purchaser") that the components of his or her vinyl fence where EverStrong Profiles were used, as applicable, will be free from manufacturing defects including peeling, flaking, blistering and corroding when subject to normal and proper use, subject to the following terms and conditions. Should any manufacturing defect occur during the lifetime of the Purchaser (and provided that the Purchaser is still the homeowner at the time such defect is reported), EverStrong, at the sole option of EverStrong, will repair or replace the defective material or the defective parts.

Limitations

In the event of any repair or replacement of fence product under this limited warranty, EverStrong shall not be liable for labor charges or other expenses incurred in connection with removal or installation of either the original or replacement product. EverStrong reserves the right to refund the amount paid by the Purchaser for the fence product instead of repairing or replacing the defective fence product. In the event of repair or replacement under the terms of this limited warranty, the original limited warranty shall apply to the repaired or replaced fence product and will extend for the balance of the original limited warranty period only. The coverage offered by this limited warranty automatically ends upon the earlier of the sale of the property or death of the last of the Purchasers.

In the event a fence product is purchased by or installed upon property owned by a corporation, governmental agency, partnership, trust, religious organization, school, condominium, homeowner association, cooperative housing arrangement, apartment building or any other type of building or any other premises not consisting of a single family home used by an individual homeowner as his or her primary residence, the limited warranty period will be twenty (20) years from the installation date where EverStrong product was used.

EverStrong does not warrant installation or defects caused by installation. This limited warranty is void if any of the following occurs: (a) improper application techniques; (b) misuse, neglect or improper storage; (c) altering or changing the product by use of applied heat, welding, solvents, epoxies or any other alterations beyond the manufacturer's control; (d) impact of objects, fire, flood, hurricane, tornado, wind storms, casualty, or "Acts of God"; (e) painting the surface of the product; (f) adverse effects of air pollution, mold and Normal Weathering of surfaces. The manufacturer of this product does not recommend or approve this product for all possible end use applications. The appropriate local code authority should be consulted as to its safety and applicability for intended usage.

EverStrong reserves the right to discontinue or modify any of its products, without notice to Purchaser. EverStrong shall not be liable in the event the replacement product varies in color or gloss level in comparison to the original product as a result of Normal Weathering or if a fence product has been discontinued or changed. If EverStrong replaces or repairs any product under this limited warranty, it may substitute products determined by EverStrong to be of comparable quality or price range.

To submit a warranty claim, the "purchaser" must notify the original company of purchase who will supply to EverStrong the documentation necessary.

THE STATEMENTS CONTAINED IN THIS LIMITED WARRANTY SET FORTH THE ONLY WARRANTIES EXTENDED BY EVERSTRONG, AND ARE IN LIEU OF ALL OTHER WARRANTIES, INCLUDING BUT NOT LIMITED TO IMPLIED WARRANTIES OF MERCHANTABILITY AND WARRANTIES OF FITNESS, AND THE PROVISIONS OF THIS WARRANTY SHALL CONSTITUTE THE ENTIRE LIABILITY OF EVERSTRONG AND THE PURCHASER'S EXCLUSIVE REMEDY FOR BREACH OF EVERSTRONG' WARRANTY. TO THE EXTENT PERMITTED BY APPLICABLE LAW, EVERSTRONG SHALL NOT BE LIABLE TO THE PURCHASER FOR INCIDENTAL OR CONSEQUENTIAL DAMAGES FOR BREACH OF ANY EXPRESS OR IMPLIED WARRANTY ON THE PRODUCT.

Post Cap Styles



EXTERNAL FLAT



BALL



COACHMAN



TEARDROP



GOthic



NEW ENGLAND



SOLAR



PALACE SOLAR

Mix 'n' Match Your Colors



Color Railing Too!



**AMERICAN
MADE**



EverStrong[®]
PROFILES

P: 800.339.3362

F: 631.698.2475

www.everstrongprofiles.com